

ICT TRANSFORMERS

Industrial Control Transformers provide a low and safe control voltage for the operation of many electromagnetic devices



TA SERIES INDUSTRIAL CONTROL TRANSFORMER

Industrial control transformers are used to reduce supply voltages to 230 V or lower for the operation of electromagnetic devices such as contactors, solenoids, relays, and timers. They are especially designed to accommodate the momentary current inrush caused when electromagnetic components are energized without sacrificing secondary voltage stability beyond practical limits.

Acme Industrial Control Transformers are dry-type, step-down transformers with the secondary control circuit isolated from the primary line circuit to assure maximum safety.

Voltage regulation of Acme Industrial Control Transformers exceeds standards recommended by the National Electrical Manufacturers Association. Secondary circuit voltage drop between no-load and momentary overload remains exceptionally low. This excellent secondary circuit voltage regulation assures reliable operation of electromagnetic components and may permit the use of a smaller and less expensive industrial control transformer.

Features

- Constructed with high quality silicon steel lamination to minimize core losses and increase efficiency.
- Designs incorporate precision wound coils for improved regulation.
- Primary fuse blocks and secondary fuse kits available and easily adaptable.
- Series-parallel connecting links save wiring and labor costs.
- Sturdy phenolic terminal panel protects the coil from foreign objects and mechanical damage.
- Copper windings on all groups.
- 130°C Insulation class. 80°C temperature rise.
- Wire retention on both primary and secondary terminals.
- Mounting plate adapts to various mounting dimensions.
- Voltage regulation exceeds NEMA requirements.
- UL Listed, CSA Certified.
- Attractive finish, nameplate, and design features enhance the end product.

Acme Industrial Control Transformers Meet or Exceed UL, CSA, NEMA & ANSI – Acme

Industrial Control Transformers 50 through 5000 VA are UL Listed, File E79947 and CSA certified, File 7357.

Laminations—High-permeability silicon steel continuously annealed to minimize core losses.

Magnet Wire—Copper magnet wire is coated with high temperature-resisting insulating film.

Coils—Precision wound by machine; total turns per coil automatically counted.

Mounting—Heavy steel mounting plates add strength to core construction and provide firm mounting, slotted to facilitate installation.

Terminal Boards—Sturdy phenolic terminal boards.

Sizing Primary Fuses:

Primary Amps < 2, fuse size is 300% of rated primary current.

Primary Amps 2 < 9, fuse size is 167% of rated primary current.

Primary Amps \geq 9, fuse size is 125% of rated primary current.

Sizing Secondary Fuses:

Secondary Amps < 9, fuse size is 167% of rated secondary current.

Secondary Amps \geq 9, fuse size is 125% of rated secondary current.



Primary Fuse Kit with Snap-on Secondary Fuse Block



Jumper Link Connections



Secondary Fuse Clips



Integrally Mounted Fuse Blocks

TB SERIES INDUSTRIAL CONTROL TRANSFORMER

Acme's TB Series Industrial Control Transformers are especially designed to accommodate the momentary current inrush caused when electromagnetic components are energized... without sacrificing secondary voltage stability beyond practical limits.

Acme's TB Series transformers are dry-type, step-down transformers with the secondary control circuit isolated from the primary line circuit to assure maximum safety.

Voltage regulation of Acme's TB Series transformers exceeds standards recommended by the National Electrical Manufacturers Association. Secondary circuit voltage drop between no-load and momentary overload remains exceptionally low. This excellent secondary circuit voltage regulation assures reliable operation of electromagnetic components and may permit the use of a smaller and less expensive industrial control transformer.

Features

- 600 volt class and below.
- 50–1000 VA, 50/60 Hz.
- 80°C temperature rise, 130°C insulation class.
- Constructed with high quality silicon steel lamination to minimize core losses and increase efficiency.
- Designs incorporate precision split bobbin wound coils for improved regulation.
- Primary fuse blocks and secondary fuse kits available and easily adaptable.
- Series-parallel connecting links save wiring and labor costs.
- Terminal blocks allow full access for ring terminals for easy installation even with solid strand conductors.
- Integrally molded terminal blocks with isolation barriers to prevent arc over.
- Footprint matches TA Series for easy interchangeability.
- Copper windings on all groups.
- Heavy gauge steel mounting plate adapts to various mounting dimensions.
- Voltage regulation exceeds NEMA requirements.
- UL Listed and CSA Certified.
- Meets or exceeds UL, CSA, NEMA, ANSI and OSHA Standards.
- Ten-year limited warranty.

Applications

- Motor Starters
- Contactors
- Solenoids
- Timer Circuits
- Relays
- Control Panels
- Robotics





120 X 240 PRIMARY VOLTS — 12/24 SECONDARY VOLTS — 1Ø, 50/60 Hz

VA Rating	Catalog Number ②	Output Amps	Approximate Dimensions (Inches)(Cm.)						Approximate Ship Weight (Lbs.)(Kg.)	Primary Fuse Block Part Number	Secondary Fuse Size 24 Volts	Wiring Diagram
			A	B	C	D	E	F				
50	TB181141②	2.08	4.23	3.00	2.70	2.50	2.13	.22 x .50	4	PL112700	3 1/2 amps	A
			(10.7)	(7.6)	(6.8)	(6.4)	(5.4)	(0.6 x 1.3)	(1.8)			
75	TB181142 ②	3.13	4.74	3.00	2.70	2.50	2.61	.22 x .50	4	PL112700	5 amps	A
			(12.0)	(7.6)	(6.8)	(6.4)	(6.6)	(0.6 x 1.3)	(1.8)			
100	TB181143 ②	4.17	4.90	3.00	2.70	2.50	2.81	.22 x .50	4	PL112700	6 1/2 amps	A
			(12.4)	(7.6)	(6.8)	(6.4)	(7.1)	(0.6 x 1.3)	(1.8)			
150	TB181144 ②	6.25	4.78	3.75	3.40	3.13	2.63	.22 x .50	6	PL112701	10 amps	A
			(12.1)	(9.5)	(8.6)	(8.0)	(6.7)	(0.6 x 1.3)	(2.7)			
250	TB181146 ②	10.42	5.08	4.50	3.84	3.75	3.05	.22 x .50	9	PL112702	15 amps	A
			(12.9)	(11.4)	(9.8)	(9.5)	(7.7)	(0.6 x 1.3)	(4.1)			
350	TB181148 ②	14.58	6.12	4.50	3.84	3.75	4.06	.22 x .50	13	PL112702	20 amps	A
			(15.5)	(11.4)	(9.8)	(9.5)	(10.3)	(0.6 x 1.3)	(5.9)			
500	TB181149 ②	20.83	5.90	5.25	4.47	4.38	4.19	.31 x .50	16	PL112704	30 amps	A
			(15.0)	(13.3)	(11.4)	(11.1)	(10.6)	(0.8 x 1.3)	(7.3)			
750	TB181150	31.25	7.53	5.25	4.47	4.38	5.25	.31 x .50	24	PL112704	—	A
			(19.1)	(13.3)	(11.4)	(11.1)	(13.3)	(0.8 x 1.3)	(10.9)			
1000	TB181151	41.67	7.43	6.75	5.72	5.75	3.81	.31 x .50	26	PL112705	—	A
			(18.9)	(17.1)	(14.5)	(14.6)	(9.7)	(0.8 x 1.3)	(11.8)			

② See chart for integrally mounted fuse block catalog number suffix.

208/240/277/380/480 PRIMARY VOLTS — 24 SECONDARY VOLTS — 1Ø, 50/60 Hz

VA Rating	Catalog Number	Output Amps	Approximate Dimensions (Inches)(Cm.)						Approximate Ship Weight (Lbs.)(Kg.)	Primary Fuse Block Part Number	Secondary Fuse Kit ① Part Number	Secondary Fuse Size 24 Volts	Wiring Diagram
			A	B	C	D	E	F					
50	TB81321	2.08	4.08	3.75	3.40	3.13	2.19	.22 x .50	4	PL112701	*	3 ² /10 amp	D
			(10.4)	(9.5)	(8.6)	(8.0)	(5.6)	(0.6 x 1.3)	(1.8)				
75	TB81322	3.13	4.31	3.75	3.40	3.13	2.31	.22 x .50	5	PL112701	*	5 amps	D
			(10.9)	(9.5)	(8.6)	(8.0)	(5.9)	(0.6 x 1.3)	(2.3)				
100	TB81323	4.17	4.52	3.75	3.40	3.13	2.63	.22 x .50	5	PL112701	*	6 ¹ /4 amps	D
			(11.5)	(9.5)	(8.6)	(8.0)	(6.7)	(0.6 x 1.3)	(2.3)				
150	TB81324	6.25	4.75	4.50	3.84	3.75	3.05	.22 x .50	9	PL112702	*	10 amps	D
			(12.1)	(11.4)	(9.8)	(9.5)	(7.7)	(0.6 x 1.3)	(4.1)				
250	TB81325	10.42	5.24	4.65	4.15	4.06	3.25	.22 x .50	11	PL112702	*	15 amps	D
			(13.3)	(11.8)	(10.5)	(10.3)	(8.3)	(0.6 x 1.3)	(5.0)				
350	TB81326	14.58	6.02	5.25	4.47	4.38	4.00	.31 x .50	18	PL112704	*	20 amps	D
			(15.3)	(13.3)	(11.4)	(11.1)	(10.2)	(0.8 x 1.3)	(8.2)				
500	TB81327	20.83	6.51	5.25	4.47	4.38	4.19	.31 x .50	19	PL112704	*	30 amps	D
			(16.5)	(13.3)	(11.4)	(11.1)	(10.6)	(0.8 x 1.3)	(8.6)				
750	TB81328	31.25	7.08	6.75	5.78	5.75	3.81	.31 x .50	26	PL112705	*	—	D
			(18.0)	(17.1)	(14.7)	(14.6)	(9.7)	(0.8 x 1.3)	(11.8)				
1000	TB81329	41.67	8.10	6.75	5.72	5.75	4.63	.31 x .50	33	PL112705	*	—	D
			(20.6)	(17.1)	(14.5)	(14.6)	(11.8)	(0.8 x 1.3)	(15.0)				

① Secondary Fuse Kit PL112603 may be substituted for PL112600 thru PL112602 when Primary Fuse Kit is used.

* See fusing chart for secondary fuse kits.

208/277/380 PRIMARY VOLTS — 115/95 SECONDARY VOLTS — 1Ø, 50/60 Hz

VA Rating	Catalog Number	Output Amps @115V	Approximate Dimensions (Inches)(Cm.)						Approximate Ship Weight (Lbs.)(Kg.)	Primary Fuse Block Part Number	Secondary Fuse Kit ① Part Number	Secondary Fuse Size 115 Volts	Wiring Diagram
			A	B	C	D	E	F					
50	TB81301	0.43	4.35 (11.0)	3.00 (7.6)	2.70 (6.8)	2.50 (6.4)	2.61 (6.6)	.22 x .50 (0.6 x 1.3)	4 (1.8)	PL112700	*	6/10 amp	E
75	TB81302	0.65	4.74 (12.0)	3.00 (7.6)	2.70 (6.8)	2.50 (6.4)	2.81 (7.1)	.22 x .50 (0.6 x 1.3)	4 (1.8)	PL112700	*	1 amp	E
100	TB81303	0.87	4.45 (11.3)	3.75 (9.5)	3.40 (8.6)	3.13 (8.0)	2.44 (6.2)	.22 x .50 (0.6 x 1.3)	5 (2.3)	PL112701	*	1 ¹ / ₄ amps	E
150	TB81304	1.30	5.00 (12.7)	3.75 (9.5)	3.84 (9.8)	3.13 (8.0)	3.06 (7.8)	.22 x .50 (0.6 x 1.3)	5 (2.3)	PL112701	*	2 amps	E
250	TB81305	2.17	5.68 (14.4)	4.50 (11.4)	3.84 (9.8)	3.75 (9.5)	4.06 (10.3)	.22 x .50 (0.6 x 1.3)	13 (5.9)	PL112702	*	3 ¹ / ₂ amps	E
350	TB81306	3.04	6.30 (16.0)	4.65 (11.8)	4.15 (10.5)	4.06 (10.3)	4.75 (12.1)	.22 x .50 (0.6 x 1.3)	18 (8.2)	PL112702	*	5 amps	E
500	TB81307	4.35	6.22 (15.8)	5.25 (13.3)	4.47 (11.4)	4.38 (11.1)	4.56 (11.6)	.22 x .50 (0.6 x 1.3)	20 (9.1)	PL112704	*	7 amps	E
750	TB81308	6.52	6.82 (17.3)	6.75 (17.1)	5.78 (14.7)	5.75 (14.6)	3.69 (9.4)	.31 x .50 (0.8 x 1.3)	24 (10.9)	PL112705	*	10 amps	E
1000	TB81309	8.70	7.96 (20.2)	6.75 (17.1)	5.72 (14.5)	5.75 (14.6)	4.44 (11.3)	.31 x .50 (0.8 x 1.3)	31 (14.1)	PL112705	*	12 amps	E

① Secondary Fuse Kit PL112603 may be substituted for PL112600 thru PL112602 when Primary Fuse Kit is used.

* See fusing chart for secondary fuse kits.

208/230/460 PRIMARY VOLTS — 115 SECONDARY VOLTS — 1Ø, 50/60 Hz

VA Rating	Catalog Number	Output Amps	Approximate Dimensions (Inches)(Cm.)						Approximate Ship Weight (Lbs.)(Kg.)	Primary Fuse Block Part Number	Secondary Fuse Kit ① Part Number	Secondary Fuse Size 115 Volts	Wiring Diagram
			A	B	C	D	E	F					
50	TB69300	0.43	4.44 (11.3)	3.00 (7.6)	2.70 (6.8)	2.50 (6.4)	2.61 (6.6)	.22 x .50 (0.6 x 1.3)	4 (1.8)	PL112700	*	6/10 amp	H
100	TB69301	0.87	5.21 (13.2)	3.00 (7.6)	2.70 (6.8)	2.50 (6.4)	3.26 (8.3)	.22 x .50 (0.6 x 1.3)	4 (1.8)	PL112700	*	1 ⁴ / ₁₀ amps	H
150	TB69302	1.30	5.10 (13.0)	3.75 (9.5)	3.40 (8.6)	3.13 (8.0)	3.06 (7.8)	.22 x .50 (0.6 x 1.3)	7 (3.2)	PL112701	*	2 amps	H
250	TB69303	2.17	5.38 (13.7)	4.50 (11.4)	3.84 (9.8)	3.75 (9.5)	3.50 (8.9)	.22 x .50 (0.6 x 1.3)	11 (5.0)	PL112702	*	3 ¹ / ₂ amps	H
350	TB69304	3.04	5.90 (15.0)	4.65 (11.8)	4.15 (10.5)	4.06 (10.3)	3.81 (9.7)	.22 x .50 (0.6 x 1.3)	15 (6.8)	PL112702	*	5 amps	H
500	TB69305	4.35	6.22 (15.8)	5.25 (13.3)	4.47 (11.4)	4.38 (11.1)	4.56 (11.6)	.31 x .50 (0.8 x 1.3)	20 (9.1)	PL112704	*	7 amps	H
750	TB69306	6.52	6.82 (17.3)	6.75 (17.1)	5.78 (14.7)	5.75 (14.6)	3.81 (9.7)	.31 x .50 (0.8 x 1.3)	26 (11.8)	PL112705	*	10 amps	H
1000	TB69307	8.70	7.96 (20.2)	6.75 (17.1)	5.78 (14.7)	5.75 (14.6)	4.63 (11.8)	.31 x .50 (0.8 x 1.3)	33 (15.0)	PL112705	*	12 amps	H

* See fusing chart for secondary fuse kits.

① Secondary Fuse Kit PL112603 may be substituted for PL112600 thru PL112602 when Primary Fuse Kit is used.



208/277 PRIMARY — 12 SECONDARY VOLTS — 50/60 Hz

VA Rating	Catalog Number	Output Amps @12V	Approximate Dimensions (Inches)(Cm.)						Approximate Ship Weight (Lbs.)(Kg.)	Wiring Diagram
			A	B	C	D	E	F		
50	TB080050	4.16	4.23	3.00	2.70	2.50	2.13	.22 x .50	4	L
			(10.74)	(7.62)	(6.85)	(6.35)	(5.41)	(0.6 x 1.3)	(1.8)	
75	TB080075	6.25	4.74	3.00	2.70	2.50	2.61	.22 x .50	4	L
			(12.03)	(7.62)	(6.85)	(6.35)	(6.62)	(0.6 x 1.3)	(1.8)	
100	TB080100	8.33	4.90	3.00	2.70	2.50	2.81	.22 x .50	4	L
			(12.44)	(7.62)	(6.85)	(6.35)	(7.13)	(0.6 x 1.3)	(1.8)	
150	TB080150	12.50	4.78	3.75	3.40	3.13	2.63	.22 x .50	6	L
			(12.14)	(9.52)	(8.63)	(7.95)	(6.68)	(0.6 x 1.3)	(2.7)	
250	TB080250	20.83	5.08	4.50	3.84	3.75	3.05	.22 x .50	9	L
			(12.90)	(11.43)	(9.75)	(9.52)	(0)	(0.6 x 1.3)	(4.1)	
350	TB080350	29.16	6.12	4.50	3.84	3.75	4.06	.22 x .50	13	L
			(15.54)	(11.43)	(9.75)	(9.52)	(10.31)	(0.6 x 1.3)	(5.9)	
500	TB080500	41.66	5.90	5.25	4.47	4.38	4.19	.31 x .50	16	L
			(14.98)	(13.33)	(11.35)	(11.12)	(10.64)	(0.8 x 1.3)	(7.25)	
750	TB080750	62.50	7.53	5.25	4.47	4.38	5.25	.31 x .50	24	L
			(19.12)	(13.33)	(11.35)	(11.12)	(13.33)	(0.8 x 1.3)	(10.88)	
1000	TB081000	83.33	7.43	6.75	5.72	5.75	3.81	.31 x .50	26	L
			(18.87)	(17.14)	(14.52)	(4.60)	(9.67)	(0.8 x 1.3)	(11.79)	

240 X 480, 230 X 460, 220 X 440 PRIMARY VOLTS — 120/115/110 SECONDARY VOLTS — 1Ø, 50/60 Hz

VA Rating	Catalog Number ②	Output Amps @120V	Approximate Dimensions (Inches)(Cm.)						Approximate Ship Weight (Lbs.)(Kg.)	Primary Fuse Block Part Number	Secondary Fuse Kit ① Part Number	Secondary Fuse Size 120 Volts	Wiring Diagram
			A	B	C	D	E	F					
50	TB81210 ②	0.42	4.23	3.00	2.70	2.50	2.13	.22 x .50	4	PL112700	*	6/10 amp	B
			(10.7)	(7.6)	(6.8)	(6.4)	(5.4)	(0.6 x 1.3)	(1.8)				
75	TB81201 ②	0.63	4.74	3.00	2.70	2.50	2.61	.22 x .50	4	PL112700	*	1 amp	B
			(12.0)	(7.6)	(6.8)	(6.4)	(6.6)	(0.6 x 1.3)	(1.8)				
100	TB81211 ②	0.83	4.90	3.00	2.70	2.50	2.81	.22 x .50	4	PL112700	*	1 1/4 amps	B
			(12.4)	(7.6)	(6.8)	(6.4)	(7.1)	(0.6 x 1.3)	(1.8)				
150	TB81212 ②	1.25	5.00	3.75	3.40	3.13	2.81	.22 x .50	6	PL112701	*	2 amps	B
			(12.7)	(9.5)	(8.6)	(8.0)	(7.1)	(0.6 x 1.3)	(2.7)				
250	TB81213 ②	2.08	4.18	4.50	3.84	3.75	3.13	.22 x .50	9	PL112702	*	3 ² /10 amps	B
			(10.6)	(11.4)	(9.8)	(9.5)	(8.0)	(0.6 x 1.3)	(4.1)				
300	TB81200 ②	2.50	5.57	4.50	3.84	3.75	3.13	.22 x .50	10	PL112702	*	4 amps	B
			(14.1)	(11.4)	(9.8)	(9.5)	(8.0)	(0.6 x 1.3)	(4.5)				
350	TB81214 ②	2.92	6.32	4.50	3.84	3.75	3.83	.22 x .50	12	PL112702	*	4 1/2 amps	B
			(16.1)	(11.4)	(9.8)	(9.5)	(9.7)	(0.6 x 1.3)	(5.4)				
500	TB81215 ②	4.17	6.30	5.25	4.47	4.06	3.81	.22 x .50	15	PL112704	*	6 1/4 amps	B
			(16.0)	(13.3)	(11.4)	(10.3)	(9.7)	(0.6 x 1.3)	(6.8)				
750	TB81216 ②	6.25	6.65	5.25	4.47	4.38	5.13	.31 x .50	23	PL112704	*	10 amps	B
			(16.9)	(13.3)	(11.4)	(11.1)	(13.0)	(0.8 x 1.3)	(10.4)				
1000	TB81217 ②	8.33	7.58	6.75	5.78	5.75	3.69	.31 x .50	25	PL112705	*	12 amps	B
			(19.3)	(17.1)	(14.7)	(14.6)	(9.4)	(0.8 x 1.3)	(11.3)				

① Secondary Fuse Kit PL112603 may be substituted for PL112600 thru PL112602 when Primary Fuse Kit is used.

② See chart for integrally mounted fuse block catalog number suffix.

240 X 480, 230 X 460, 220 X 440 PRIMARY VOLTS — 120/115/110 SECONDARY VOLTS — 1Ø, 50/60 Hz (Cont.)

VA Rating	Catalog Number ^②	Output Amps @120V	Approximate Dimensions (Inches)(Cm.)						Approximate Ship Weight (Lbs.)(Kg.)	PRIMARY FUSE BLOCK PART NUMBER	Secondary Fuse Kit ^① Part Number	Secondary Fuse Size 120 Volts	Wiring Diagram
			A	B	C	D	E	F					
1500	TA281218	12.50	8.80	6.75	5.72	5.75	5.75	.31 x .50	43	PL112705	PL112601	15 amps	B
			(22.4)	(17.1)	(14.5)	(14.6)	(14.6)	(0.8 x 1.3)					
2000	TA281219	16.67	9.25	6.75	5.72	5.75	6.38	.31 x .50	49	PL112705	PL112601	20 amps	B
			(23.5)	(17.1)	(14.5)	(14.6)	(16.2)	(0.8 x 1.3)					
3000	TA281220	25.00	8.81	7.50	8.34	6.50	7.52	.41 x .81	70	PL112706	—	—	B
			(22.4)	(19.1)	(21.2)	(16.5)	(19.1)	(1.0 x 2.1)					
5000	TA281221	41.67	7.52	11.92	9.49	6.75	6.25	.41 x .81	125	PL112707	—	—	B
			(12.7)	(9.5)	(8.6)	(8.0)	(7.1)	(0.6 x 1.3)					

① Secondary Fuse Kit PL112603 may be substituted for PL112600 thru PL112602 when Primary Fuse Kit is used.

② See chart for integrally mounted fuse block catalog number suffix.

240/480/600, 230/460/575, 220/440/550 PRIMARY VOLTS — 120/100, 115/95, 110/90 SECONDARY VOLTS — 1Ø, 50/60 Hz

VA Rating	Catalog Number ^②	Output Amps @120V	Approximate Dimensions (Inches)(Cm.)						Approximate Ship Weight (Lbs.)(Kg.)	Primary Fuse Block Part Number	Secondary Fuse Kit ^① Part Number	Secondary Fuse Size 120 Volts	Wiring Diagram
			A	B	C	D	E	F					
50	TB81000	0.42	4.56	3.00	2.70	2.50	2.61	.22 x .50	4	PL112700	*	6/10 amp	C
			(11.6)	(7.6)	(6.8)	(6.4)	(6.6)	(0.6 x 1.3)					
75	TB81009	0.63	4.90	3.00	2.70	2.50	2.81	.22 x .50	4	PL112700	*	1 amp	C
			(12.4)	(7.6)	(6.8)	(6.4)	(7.1)	(0.6 x 1.3)					
100	TB81001	0.83	5.36	3.00	2.70	2.50	3.26	.22 x .50	5	PL112700	*	1 ¹ / ₄ amps	C
			(13.6)	(7.6)	(6.8)	(6.4)	(8.3)	(0.6 x 1.3)					
150	TB81002	1.25	5.00	3.75	3.40	3.13	3.06	.22 x .50	7	PL112701	*	2 amps	C
			(12.7)	(9.5)	(8.6)	(8.0)	(7.8)	(0.6 x 1.3)					
250	TB81003	2.08	5.57	4.50	3.84	3.75	3.50	.22 x .50	11	PL112702	*	3 ² / ₁₀ amps	C
			(14.1)	(11.4)	(9.8)	(9.5)	(8.9)	(0.6 x 1.3)					
300	TB81020	2.50	6.48	4.65	4.15	4.06	4.06	.22 x .50	15	PL112702	*	4 amps	C
			(16.5)	(11.8)	(10.5)	(10.3)	(10.3)	(0.6 x 1.3)					
350	TB81004	2.92	6.48	4.65	4.15	4.06	4.06	.22 x .50	15	PL112702	*	4 ¹ / ₂ amps	C
			(16.5)	(11.8)	(10.5)	(10.3)	(10.3)	(0.6 x 1.3)					
500	TB81005	4.17	6.43	5.25	4.47	4.38	4.56	.31 x .50	21	PL112704	*	6 ¹ / ₄ amps	C
			(16.3)	(13.3)	(11.4)	(11.1)	(11.6)	(0.8 x 1.3)					
750	TB81006	6.25	7.19	6.75	5.78	5.75	3.81	.31 x .50	25	PL112705	*	10 amps	C
			(18.3)	(17.1)	(14.7)	(14.6)	(9.7)	(0.8 x 1.3)					
1000	TB81007	8.33	7.96	6.75	5.78	5.75	4.63	.31 x .50	32	PL112705	*	12 amps	C
			(20.2)	(17.1)	(14.7)	(14.6)	(11.8)	(0.8 x 1.3)					
1500	TA281008	12.50	9.46	6.75	5.72	5.75	6.38	.31 x .50	47	PL112705	PL112601	15 amps	C
			(24.0)	(17.1)	(14.5)	(14.6)	(16.2)	(0.8 x 1.3)					
2000	TA253929	16.67	7.90	7.50	7.66	6.50	6.57	.41 x .81	55	PL112706	PL112601	20 amps	C
			(20.1)	(19.1)	(19.5)	(16.5)	(16.7)	(1.0 x 2.1)					
3000	TA253930	25.00	7.02	11.92	8.83	6.75	5.75	.41 x .81	75	PL112707	—	—	C
			(17.8)	(30.3)	(22.4)	(17.1)	(14.6)	(1.0 x 2.1)					
5000	TA253931	41.67	7.52	11.92	9.49	6.75	6.25	.41 x .81	110	PL112707	—	—	C
			(19.1)	(30.3)	(24.1)	(17.1)	(15.9)	(1.0 x 2.1)					

① Secondary Fuse Kit PL112603 may be substituted for PL112600 thru PL112602 when Primary Fuse Kit is used.

* See fusing chart for secondary fuse kits.

② See chart for integrally mounted fuse block catalog number suffix



**240/416/480/600; 230/400/460/575; 220/380/440/550; 208/500 PRIMARY VOLTS
99/120/130; 95/115/125; 91/110/120; 85/100/110 SECONDARY VOLTS — 1Ø, 50/60 Hz**

VA Rating @ 130V	Catalog Number	Output Amps	Approximate Dimensions (Inches)(Cm.)						Approximate Ship Weight (Lbs.)(Kg.)	Primary Fuse Block Part Number	Secondary Fuse Kit Part Number	Secondary Fuse Size 130 Volts	Wiring Diagram
			A	B	C	D	E	F					
50	TB32403	0.38	4.08 (10.4)	3.75 (9.5)	3.40 (8.6)	3.13 (8.0)	2.31 (5.9)	.22 x .50 (0.6 x 1.3)	5 (2.3)	PL112701	NA	6 ⁶ /10 amp	G
150	TB32404	1.15	4.75 (12.1)	4.50 (11.4)	3.84 (9.8)	3.75 (9.5)	3.05 (7.7)	.22 x .50 (0.6 x 1.3)	10 (4.5)	PL112702	NA	16 ⁶ /10 amps	G
250	TB32405	1.92	5.58 (14.2)	4.65 (11.8)	4.15 (10.5)	4.06 (10.3)	4.06 (10.3)	.22 x .50 (0.6 x 1.3)	16 (7.3)	PL112702	NA	32 ² /10 amps	G
350	TB32669	2.69	6.23 (15.8)	4.65 (11.8)	4.15 (10.5)	4.06 (10.3)	5.50 (14.0)	.22 x .50 (0.6 x 1.3)	22 (10.0)	PL112702	NA	4 amps	G
500	TB32406	3.85	6.40 (16.3)	6.75 (17.1)	5.78 (14.7)	5.75 (14.6)	3.69 (9.4)	.22 x .50 (0.6 x 1.3)	23 (10.4)	PL112705	NA	6 ¹ / ₄ amps	G
750	TB54523	5.77	7.08 (18.0)	6.75 (17.1)	5.78 (14.7)	5.75 (14.6)	4.13 (10.5)	.31 x .50 (0.8 x 1.3)	29 (13.2)	PL112705	NA	9 amps	G
1000	TB54524	7.69	8.56 (21.7)	6.75 (17.1)	5.78 (14.7)	5.75 (14.6)	4.88 (12.4)	.31 x .50 (0.8 x 1.3)	35 (15.9)	PL112705	NA	12 amps	G
1500	TA254525	11.54	6.75 (17.1)	7.50 (19.1)	7.66 (19.5)	6.50 (16.5)	5.42 (13.8)	.41 x .81 (1.0 x 2.1)	55 (24.9)	PL112706	PL-112601	20 amps	G
2000	TA281202	15.39	7.45 (18.9)	7.50 (19.1)	7.66 (19.5)	6.50 (16.5)	6.12 (15.5)	.41 x .81 (1.0 x 2.1)	55 (24.9)	PL112706	PL-112601	25 amps	G
3000	TA281203	23.08	7.02 (17.8)	11.92 (30.3)	8.83 (22.4)	6.75 (17.1)	5.75 (14.6)	.41 x .81 (1.0 x 2.1)	70 (31.8)	PL112707	—	—	G
5000	TA281205	38.46	7.52 (19.1)	11.92 (30.3)	9.49 (24.1)	6.75 (17.1)	6.25 (15.9)	.41 x .81 (1.0 x 2.1)	110 (49.9)	PL112707	—	—	G

240 X 480 PRIMARY VOLTS — 120/240 SECONDARY VOLTS — 1Ø, 60 Hz

VA Rating	Catalog Number	Output Amps @120V	Approximate Dimensions (Inches)(Cm.)						Approximate Ship Weight (Lbs.)(Kg.)	Primary Fuse Block Part Number	Wiring Diagram
			A	B	C	D	E	F			
50	TB83210	0.42	4.13	3.00	2.70	2.50	2.30	.22 x .50	4	PL112700	J
			(10.5)	(7.6)	(6.8)	(6.4)	(5.8)	(0.6 x 1.3)			
100	TB83212	0.83	4.90	3.00	2.70	2.50	3.35	.22 x .50	4	PL112700	J
			(12.4)	(7.6)	(6.8)	(6.4)	(8.5)	(0.6 x 1.3)			
150	TB83213	1.25	4.92	3.75	3.40	3.13	2.81	.22 x .50	6	PL112701	J
			(12.5)	(9.5)	(8.6)	(8.0)	(7.1)	(0.6 x 1.3)			
250	TB83215	2.08	5.38	4.50	3.84	3.75	3.05	.22 x .50	9	PL112702	J
			(13.7)	(11.4)	(9.8)	(9.5)	(7.7)	(0.6 x 1.3)			
500	TB83218	4.17	6.06	5.25	4.47	4.06	4.06	.22 x .50	13	PL112704	J
			(15.4)	(13.3)	(11.4)	(10.3)	(10.3)	(0.6 x 1.3)			
750	TB83219	6.25	6.43	5.25	4.47	4.38	5.30	.31 x .50	21	PL112704	J
			(16.3)	(13.3)	(11.4)	(11.1)	(13.0)	(0.8 x 1.3)			
1000	TB83220	8.33	7.34	6.75	5.78	5.75	3.69	.31 x .50	24	PL112705	J
			(18.6)	(17.1)	(14.7)	(14.6)	(9.4)	(0.8 x 1.3)			
1500	TA83221	12.50	8.80	6.75	5.72	5.75	5.02	.31 x .50	43	PL112705	J
			(22.4)	(17.1)	(14.5)	(14.6)	(12.8)	(0.8 x 1.3)			
2000	TA83222	16.67	9.15	6.75	5.72	5.75	5.42	.31 x .50	48	PL112705	J
			(23.2)	(17.1)	(14.5)	(14.6)	(13.8)	(0.8 x 1.3)			
3000	TA83223	25.00	7.00	7.50	7.66	6.50	5.55	.41 x .81	51	PL112706	J
			(17.8)	(19.1)	(19.5)	(16.5)	(14.1)	(1.0 x 2.1)			
5000	TA83224	41.67	7.06	11.92	8.75	6.75	5.75	.41 x .81	90	PL112707	J
			(17.9)	(30.3)	(22.2)	(17.1)	(14.6)	(1.0 x 2.1)			

380/440/550/600 PRIMARY VOLTS — 115/230 SECONDARY VOLTS — 1Ø, 50/60 Hz

VA Rating	Catalog Number	Output Amps @115V	Approximate Dimensions (Inches)(Cm.)						Approximate Ship Weight (Lbs.)(Kg.)	Primary Fuse Block Part Number	Secondary Fuse Size 115 Volts	Wiring Diagram
			A	B	C	D	E	F				
50	TA254535	0.43	4.12	3.75	3.21	3.13	2.19	.22 x .50	4	PL112701	6/10 amp	F
			(10.5)	(9.5)	(8.2)	(8.0)	(5.6)	(0.6 x 1.3)				
100	TA254536	0.87	4.56	3.75	3.21	3.13	2.31	.22 x .50	5	PL112701	1 ¹ / ₄ amps	F
			(11.6)	(9.5)	(8.2)	(8.0)	(5.9)	(0.6 x 1.3)				
150	TA254537	1.30	5.00	3.75	3.21	3.13	3.06	.22 x .50	10	PL112701	2 amps	F
			(12.7)	(9.5)	(8.2)	(8.0)	(7.8)	(0.6 x 1.3)				
250	TA254538	2.17	5.49	4.50	3.84	3.75	3.50	.22 x .50	11	PL112702	3 ¹ / ₂ amps	F
			(13.9)	(11.4)	(9.8)	(9.5)	(8.9)	(0.6 x 1.3)				
350	TA281197	3.04	6.03	4.88	4.15	4.06	4.38	.22 x .50	17	PL112703	5 amps	F
			(15.3)	(12.4)	(10.5)	(10.3)	(11.1)	(0.6 x 1.3)				
500	TA254539	4.35	6.76	4.88	4.15	4.06	5.75	.22 x .50	23	PL112703	7 amps	F
			(17.1)	(12.4)	(10.5)	(10.3)	(14.6)	(0.6 x 1.3)				
750	TA281240	6.52	7.19	6.75	5.72	5.75	3.69	.31 x .50	25	PL112705	10 amps	F
			(18.3)	(17.1)	(14.5)	(14.6)	(9.4)	(0.8 x 1.3)				
1000	TA281241	8.70	7.77	6.75	5.72	5.75	4.44	.31 x .50	30	PL112705	12 amps	F
			(19.7)	(17.1)	(14.5)	(14.6)	(11.3)	(0.8 x 1.3)				



600 PRIMARY VOLTS — 12/24 SECONDARY VOLTS — 1Ø, 60 Hz

VA Rating	Catalog Number	Output Amps @12V	Approximate Dimensions (Inches)(Cm.)						Approximate Ship Weight (Lbs.)(Kg.)	Primary Fuse Block Part Number	Wiring Diagram
			A	B	C	D	E	F			
50	TA83300	4.17	4.13	3.00	2.59	2.50	2.30	.22 x .50	4	PL112700	I
			(10.5)	(7.6)	(6.6)	(6.4)	(5.8)	(0.6 x 1.3)	(1.8)		
100	TA83301	8.33	4.90	3.00	2.59	2.50	3.35	.22 x .50	4	PL112700	I
			(12.4)	(7.6)	(6.6)	(6.4)	(8.5)	(0.6 x 1.3)	(1.8)		
150	TA83302	12.50	4.92	3.75	3.21	3.13	2.81	.22 x .50	6	PL112701	I
			(12.5)	(9.5)	(8.2)	(8.0)	(7.1)	(0.6 x 1.3)	(2.7)		
250	TA83303	20.83	5.38	4.50	3.84	3.75	3.05	.22 x .50	9	PL112702	I
			(13.7)	(11.4)	(9.8)	(9.5)	(7.7)	(0.6 x 1.3)	(4.1)		
500	TA83304	41.67	6.06	4.88	4.15	4.06	4.06	.22 x .50	13	PL112703	I
			(15.4)	(12.4)	(10.5)	(10.3)	(10.3)	(0.6 x 1.3)	(5.9)		
750	TA83305	62.50	6.43	5.25	4.47	4.38	4.00	.31 x .50	21	PL112704	I
			(16.3)	(13.3)	(11.4)	(11.1)	(10.2)	(0.8 x 1.3)	(9.5)		
1000	TA83306	83.33	7.30	6.75	5.72	5.75	3.69	.31 x .50	24	PL112705	I
			(18.5)	(17.1)	(14.5)	(14.6)	(9.4)	(0.8 x 1.3)	(10.9)		

600 PRIMARY VOLTS — 120/240 SECONDARY VOLTS — 1Ø, 60 Hz

VA Rating	Catalog Number	Output Amps @120V	Approximate Dimensions (Inches)(Cm.)						Approximate Ship Weight (Lbs.)(Kg.)	Primary Fuse Block Part Number	Wiring Diagram
			A	B	C	D	E	F			
50	TA83310	0.42	4.13	3.00	2.59	2.50	2.30	.22 x .50	4	PL112700	K
			(10.5)	(7.6)	(6.6)	(6.4)	(5.8)	(0.6 x 1.3)	(1.8)		
100	TA83311	0.83	4.90	3.00	2.59	2.50	3.35	.22 x .50	4	PL112700	K
			(12.4)	(7.6)	(6.6)	(6.4)	(8.5)	(0.6 x 1.3)	(1.8)		
150	TA83312	1.25	4.92	3.75	3.21	3.13	2.81	.22 x .50	6	PL112701	K
			(12.5)	(9.5)	(8.2)	(8.0)	(7.1)	(0.6 x 1.3)	(2.7)		
250	TA83313	2.08	5.38	4.50	3.84	3.75	3.05	.22 x .50	9	PL112702	K
			(13.7)	(11.4)	(9.8)	(9.5)	(7.7)	(0.6 x 1.3)	(4.1)		
500	TA83314	4.17	6.06	4.88	4.15	4.06	4.06	.22 x .50	13	PL112703	K
			(15.4)	(12.4)	(10.5)	(10.3)	(10.3)	(0.6 x 1.3)	(5.9)		
750	TA83315	6.25	6.43	5.25	4.47	4.38	4.00	.31 x .50	21	PL112704	K
			(16.3)	(13.3)	(11.4)	(11.1)	(10.2)	(0.8 x 1.3)	(9.5)		
1000	TA83316	8.33	7.34	6.75	5.72	5.75	3.69	.31 x .50	24	PL112705	K
			(18.6)	(17.1)	(14.5)	(14.6)	(9.4)	(0.8 x 1.3)	(10.9)		

INTEGRALLY MOUNTED FUSE BLOCKS

120X240-12/24: 50-500VA (F2 Option Only)

240X480-120/115/110: 50-2000VA

Add Suffix to Catalog Number	Configuration
F2	Factory installed integrally mounted 2-pole primary block
F3	Factory installed integrally mounted 3-pole primary and secondary block (100 VA & larger)
F4	Factory installed 2-pole primary block and secondary fuse clips (50 & 75 VA)

Consult factory for other sizes available.

TA & TB SERIES PROTECTIVE DEVICES— Primary Fuse Kits

FUSES ARE NOT INCLUDED. CONSULT CATALOG FOR PROPER FUSE SELECTION

Catalog Number	Approximate Ship Weight (Lbs.)(Kg.)
PL112700	1 (0.5)
PL112701	1 (0.5)
PL112702	1 (0.5)
PL112703	1 (0.5)
PL112704	1 (0.5)
PL112705	1 (0.5)
PL112706	1 (0.5)
PL112707	1 (0.5)

TA SERIES PROTECTIVE DEVICES — Secondary Fuse Kits

FOR USE WITH INDUSTRIAL CONTROL TRANSFORMERS THROUGH 1500 VA

Catalog Number	Approximate Ship Weight (Lbs.)(Kg.)
PL112600	0.5 (0.2)
PL112601	0.5 (0.2)
PL112602	1 (0.5)
PL112603	1 (0.5)

TB SERIES PROTECTIVE DEVICES — Secondary Fuse Kits

Catalog Number	VA	Description	Approximate Ship Weight (Lbs.)(Kg.)
PL79924		Fuse Kit: Secondary Fuse 1/4" x 1-1/4" w/ARM	1.0 (0.5)
PL79928	50–350	Link: Small Jumper Links (Qty. 2)	1.0 (0.5)
PL79929	500 & 750	Link: Large Jumper Links (Qty. 2)	1.0 (0.5)
PL79930	50–350	Fuse Kit: Secondary Fuse Midget w/ARM	1.0 (0.5)
PL79931	500 & 1000	Fuse Kit: Secondary Fuse Midget w/ARM	1.0 (0.5)

CONNECTION DETAILS FOR WIRING DIAGRAM G

H1-H2	H1-H3	Approximate Dimensions (Inches)(Cm.)			X1-X2	X1-X3	Output Volts X1-X4
		H1-H4	H1-H5				
208	—	—	500	85	100	110	
220	380	440	550	91	110	120	
230	400	460	575	95	115	125	
240	416	480	600	99	120	130	

HARSH ENVIRONMENT WIRING DIAGRAMS

B

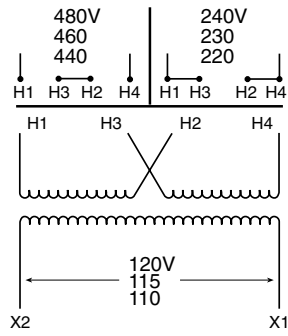

C

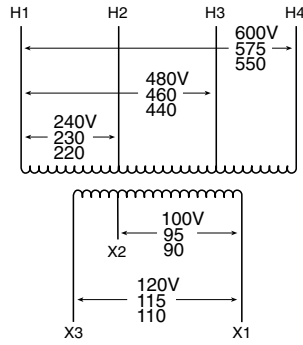

TA/TB SERIES OPEN CORE AND COIL WIRING DIAGRAMS

A

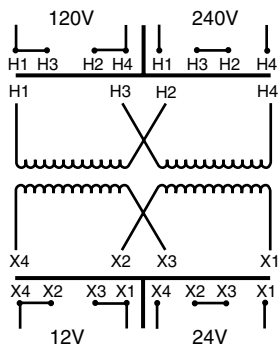

B

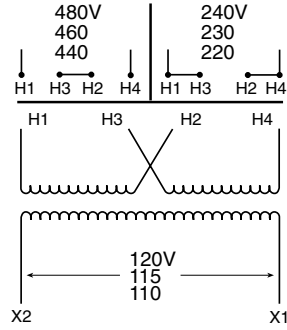

C

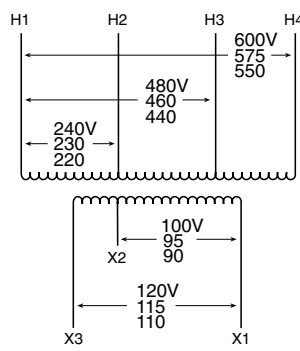

D

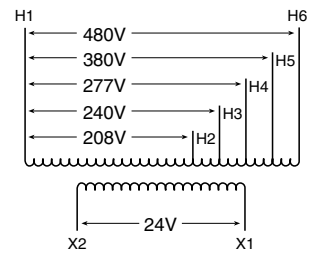

E

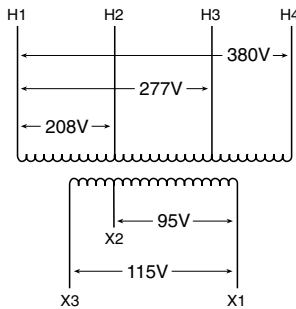

G

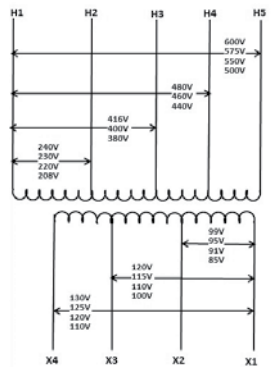

H

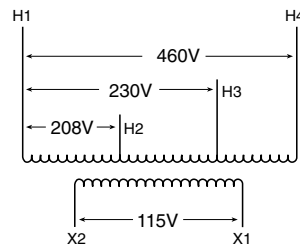

J

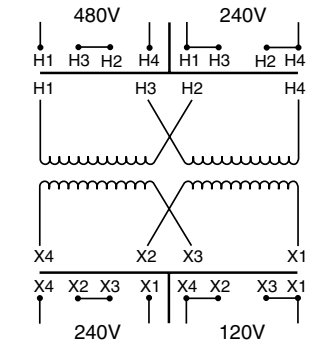

L

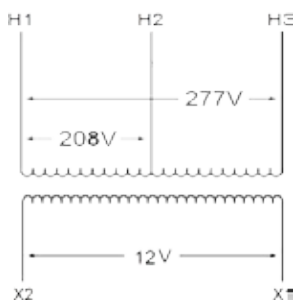

TA/TB SERIES OPEN CORE AND COIL DIMENSIONAL DRAWINGS

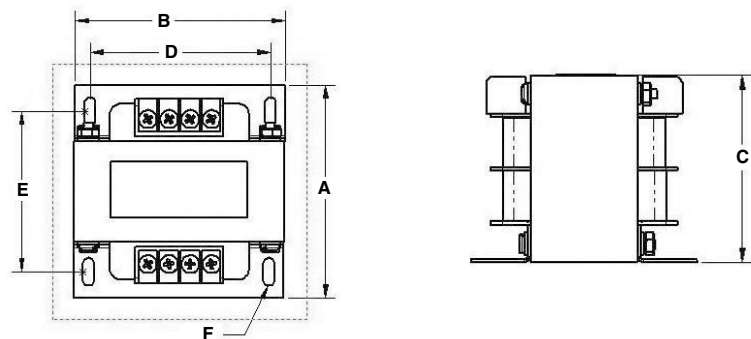

INDUSTRIAL CONTROL TRANSFORMERS FOR HARSH ENVIRONMENTS

Designed for control panels where internal installation of Control Transformers is prohibited

Some specifications require installation of large control transformers, usually 1000 to 5000 VA outside the control cabinet. This means the transformer must be in a sheet metal enclosure instead of the usual open core and coil construction method.

Acme meets this need by providing all of the power, protection, regulation and performance of our standard industrial control transformers in one UL-3R enclosure. These transformers are wound with copper magnet wire, deliver full nameplate capacity, and provide the high regulation required in control applications.

Voltage combinations available are: 240 x 480V primary, 120V secondary and 240/480/600V primary, 120/100V secondary. Ratings available are 1000, 2000, 3000 and 5000 VA. All units are UL listed, CSA certified, and covered by Acme's exclusive 10-year limited warranty.

Features

- Fully encapsulated and enclosed
- 55°C temperature rise, 155°C insulation
- Copper windings
- 1000, 2000, 3000, 5000 and 10000 VA sizes
- Voltage regulation exceeds NEMA requirements
- UL and UL-3R listed
- CSA certified
- 10-year limited warranty



240 X 480 PRIMARY VOLTS — 120 SECONDARY VOLTS — 1Ø, 50/60 Hz

VA Rating	Catalog Number	Output Amps	Height (Inches)(Cm.)	Width (Inches)(Cm.)	Depth (Inches)(Cm.)	Weight (Lbs.)(Kg.)	Wiring Diagram ① ②
1000	T181217	8.33	13.10 (33.3)	10.31 (26.2)	7.13 (18.1)	55 (24.9)	B
2000	T181219	16.67	14.77 (37.5)	10.31 (26.2)	7.13 (18.1)	80 (36.3)	B
3000	T181220	25.00	14.77 (37.5)	10.31 (26.2)	7.13 (18.1)	100 (45.4)	B
5000	T181221	41.67	13.85 (35.2)	13.25 (33.7)	10.19 (25.9)	140 (63.5)	B
10000	T181223	83.3	16.47 (41.8)	13.88 (35.3)	12.94 (32.9)	308 (139.7)	B

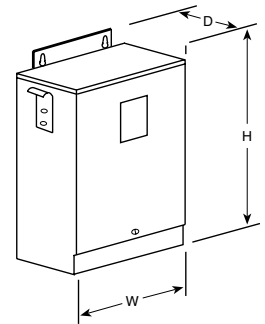

**Encapsulated
1000 VA–10000 VA**

240/480/600 PRIMARY VOLTS — 120/100 SECONDARY VOLTS — 1Ø, 50/60 Hz

VA Rating	Catalog Number	Output Amps	Height (Inches)(Cm.)	Width (Inches)(Cm.)	Depth (Inches)(Cm.)	Weight (Lbs.)(Kg.)	Wiring Diagram ① ②
2000	T153929	16.67	14.77 (37.5)	10.31 (26.2)	7.13 (18.1)	80 (36.3)	C
3000	T153930	25.00	13.85 (35.2)	13.25 (33.7)	10.19 (25.9)	130 (59.0)	C
5000	T153931	41.67	13.85 (35.2)	13.25 (33.7)	10.19 (25.9)	140 (63.5)	C

AE/CE SERIES INDUSTRIAL CONTROL TRANSFORMERS

The Acme Electric AE and CE Series Industrial Control Transformers are designed specifically for machine tool control circuit applications. These transformers have the ability to handle potentially damaging high in-rush currents that occur when electromagnetic components are energized, without sacrificing the required stable output voltage. Designed to meet or exceed the demands of international standards, combined with the full breadth of product offering, the AE and CE Series Transformers from Acme Electric are the ideal solution for your industrial control applications.

Cooler. Cleaner. More Compact.

The AE and CE Series design improves the dissipation of the heat away from the core and coil assembly providing cooler operation. In addition, the AE and CE Series industrial control transformers seal the transformer's windings and internal terminations within an epoxy encapsulant encased in a durable thermoplastic end cap, protecting them from potentially damaging moisture, dirt and other ambient contaminants. Furthermore, Acme's compact design helps minimize the mounting footprint, providing more flexibility in applications where space is at a premium.

Features

- Epoxy encapsulated design protects core & coil assembly from potentially damaging contaminants
- Integrally molded terminal blocks with isolation barriers to prevent arc over, terminal blocks allow full access for ring terminals for easy installation and solid termination
- Heavy gauge steel mounting feet
- Available factory or field installed fuse blocks provide integral fusing on the primary or primary and secondary
- Dual labeling for easy product identification when equipped with a fuse block
- 50-750 VA, 50/60 Hz
- UL and cUL Listed, CE Marked (CE Series only)
- Ten-year limited warranty
- 55°C Temperature Rise
- 105°C Insulation Class

CE Series for Global Applications

Acme's CE Series Encapsulated Industrial Control Transformers carry the CE mark, indicating it complies with the requirements established by the International Electrotechnical Commission (IEC) for use of control circuit transformers in the countries of the European Union. Regulations that apply to control transformers include Low Voltage Directive 2006/95/EC and Electromagnetic Compatibility (EMC) Directive 2004/108/EC.



**120 X 240 PRIMARY VOLTS — 24 SECONDARY VOLTS — 1Ø, 50/60 Hz****AE SERIES**

VA Rating	Catalog Number	Approximate Dimensions (Inches)(Cm.)					Mounting Slot F	Approximate Ship Weight (Lbs.)(Kg.)
		A	B	C	D	E		
50	AE010050	2.69 (6.8)	3.00 (7.6)	2.81 (7.1)	2.03 (5.1)	2.53 (6.4)	.20 x .40 (0.5 x 1.0)	2.50 (1.1)
75	AE010075	3.22 (8.1)	3.00 (7.6)	2.81 (7.1)	2.53 (6.4)	2.53 (6.4)	.20 x .40 (0.5 x 1.0)	3.50 (1.6)
100	AE010100	3.28 (8.3)	3.41 (8.6)	3.09 (7.8)	2.41 (6.1)	2.81 (7.1)	.20 x .40 (0.5 x 1.0)	4.05 (1.8)
150	AE010150	3.88 (9.8)	3.78 (9.6)	3.41 (8.6)	2.97 (7.5)	3.13 (7.9)	.20 x .40 (0.5 x 1.0)	6.50 (2.9)
250	AE010250	4.13 (10.4)	4.50 (11.4)	3.84 (9.7)	2.94 (7.4)	3.75 (9.5)	.20 x .40 (0.5 x 1.0)	9.25 (4.2)
350	AE010350	5.00 (12.7)	4.50 (11.4)	3.84 (9.7)	3.78 (9.6)	3.75 (9.5)	.20 x .40 (0.5 x 1.0)	12.75 (5.8)
500	AE010500	5.53 (14.0)	5.25 (13.3)	4.66 (11.8)	4.16 (10.5)	4.38 (11.1)	.31 x .69 (0.8 x 1.7)	19.00 (8.6)
750	AE010750	6.81 (17.3)	5.25 (13.3)	4.66 (11.8)	5.75 (14.6)	4.38 (11.1)	.31 x .69 (0.8 x 1.7)	26.00 (11.8)

200/220/440, 208/230/460, 240/480 PRIMARY VOLTS — 23/110, 24/115, 25/120 SECONDARY VOLTS — 1Ø, 50/60 Hz**AE SERIES**

VA Rating	Catalog Number	Approximate Dimensions (Inches)(Cm.)					Mounting Slot F	Approximate Ship Weight (Lbs.)(Kg.)
		A	B	C	D	E		
50	AE020050	3.28 (8.3)	3.00 (7.6)	2.78 (7.0)	2.25 (5.7)	2.53 (6.4)	.20 x .40 (0.5 x 1.0)	3.0 (1.4)
75	AE020075	3.28 (8.3)	3.00 (7.6)	3.09 (7.8)	2.53 (6.4)	2.81 (7.1)	.20 x .40 (0.5 x 1.0)	4.0 (1.8)
100	AE020100	3.28 (8.3)	3.41 (8.6)	3.41 (8.6)	2.53 (6.4)	3.13 (7.9)	.20 x .40 (0.5 x 1.0)	4.0 (1.8)
150	AE020150	4.03 (10.2)	3.75 (9.5)	3.41 (8.6)	3.28 (8.3)	3.13 (7.9)	.20 x .40 (0.5 x 1.0)	7.0 (3.2)
250	AE020250	4.38 (11.1)	4.50 (11.4)	4.03 (10.2)	3.75 (9.5)	3.75 (9.5)	.20 x .40 (0.5 x 1.0)	9.0 (4.1)
300	AE020300	5.13 (13.0)	4.50 (11.4)	4.97 (12.6)	3.88 (9.8)	4.38 (11.1)	.31 x .69 (0.8 X 1.7)	11.0 (5.0)
350	AE020350	5.25 (13.3)	4.50 (11.4)	4.97 (12.6)	4.16 (10.5)	4.38 (11.1)	.31 x .69 (0.8 X 1.7)	13.0 (5.9)
500	AE020500	6.31 (16.0)	5.25 (13.3)	4.97 (12.6)	5.25 (13.3)	4.38 (11.1)	.31 x .69 (0.8 X 1.7)	19.0 (8.6)
750	AE020750	6.81 (17.3)	5.25 (13.3)	4.97 (12.6)	5.75 (14.6)	4.38 (11.1)	.31 x .69 (0.8 X 1.7)	27.0 (12.2)

208/230/460 PRIMARY VOLTS — 115 SECONDARY VOLTS — 1Ø, 50/60 Hz**AE SERIES**

VA Rating	Catalog Number	Approximate Dimensions (Inches)(Cm.)					Mounting Slot F	Approximate Ship Weight (Lbs.)(Kg.)
		A	B	C	D	E		
50	AE070050	2.84 (7.2)	3.00 (7.6)	2.81 (7.1)	2.16 (5.4)	2.53 (6.4)	.20 x .40 (0.5 x 1.0)	2.6 (1.2)
100	AE070100	3.41 (8.6)	3.41 (8.6)	3.09 (7.8)	2.69 (6.8)	2.81 (7.1)	.20 x .40 (0.5 x 1.0)	4.2 (1.9)
150	AE070150	3.88 (9.8)	3.75 (9.5)	3.41 (8.6)	3.09 (7.8)	3.09 (7.8)	.20 x .40 (0.5 x 1.0)	6.7 (3.1)
250	AE070250	4.16 (10.5)	4.50 (11.4)	4.03 (10.2)	3.28 (8.3)	3.75 (9.5)	.20 x .40 (0.5 x 1.0)	9.5 (4.3)
350	AE070350	5.19 (13.1)	4.50 (11.4)	4.03 (10.2)	4.38 (11.1)	3.75 (9.5)	.20 x .40 (0.5 x 1.0)	13.4 (6.1)
500	AE070500	5.88 (14.9)	5.25 (13.3)	4.66 (11.8)	4.78 (12.1)	4.38 (11.1)	.31 x .69 (0.8 X 1.7)	19.0 (8.6)
750	AE070750	6.81 (17.3)	5.25 (13.3)	4.66 (11.8)	5.75 (14.6)	4.38 (11.1)	.31 x .69 (0.8 X 1.7)	27.0 (12.2)



230/460/575 PRIMARY VOLTS — 95/115 SECONDARY VOLTS — 1Ø, 50/60 Hz

AE SERIES

VA Rating	Catalog Number	Approximate Dimensions (Inches)(Cm.)					Mounting Slot F	Approximate Ship Weight (Lbs.)(Kg.)
		A	B	C	D	E		
50	AE120050	2.88 (7.3)	3.00 (7.6)	2.81 (7.1)	2.19 (5.5)	2.53 (6.4)	.20 x .40 (0.5 x 1.0)	2.6 (1.2)
100	AE120100	3.59 (9.1)	3.41 (8.6)	3.09 (7.8)	2.88 (7.3)	2.81 (7.1)	.20 x .40 (0.5 x 1.0)	4.2 (1.9)
150	AE120150	3.94 (10.0)	3.78 (9.6)	3.41 (8.6)	3.28 (8.3)	3.09 (7.8)	.20 x .40 (0.5 x 1.0)	6.8 (3.1)
250	AE120250	4.16 (10.5)	4.50 (11.4)	4.03 (10.2)	3.22 (8.1)	3.75 (9.5)	.20 x .40 (0.5 x 1.0)	9.5 (4.3)
350	AE120350	5.00 (12.7)	4.50 (11.4)	4.03 (10.2)	3.69 (9.3)	4.31 (10.9)	.20 x .40 (0.5 x 1.0)	13.2 (6.0)
500	AE120500	5.84 (14.8)	5.25 (13.3)	4.66 (11.8)	4.66 (11.8)	4.38 (11.1)	.31 x .69 (0.8 X 1.7)	19.2 (8.7)
750	AE120750	6.81 (17.3)	5.25 (13.3)	4.66 (11.8)	5.81 (14.7)	4.38 (11.1)	.31 x .69 (0.8 X 1.7)	27.0 (12.2)

240 X 480 PRIMARY VOLTS — 24 SECONDARY VOLTS — 1Ø, 50/60 Hz

AE SERIES

VA Rating	Catalog Number	Approximate Dimensions (Inches)(Cm.)					Mounting Slot F	Approximate Ship Weight (Lbs.)(Kg.)
		A	B	C	D	E		
50	AE030050	2.69 (6.8)	3.00 (7.6)	2.81 (7.1)	2.03 (5.1)	2.53 (6.4)	.20 x .40 (0.5 x 1.0)	2.5 (1.1)
75	AE030075	3.22 (8.1)	3.00 (7.6)	2.81 (7.1)	2.53 (6.4)	2.53 (6.4)	.20 x .40 (0.5 x 1.0)	3.5 (1.6)
100	AE030100	3.28 (8.3)	3.41 (8.6)	3.09 (7.8)	2.41 (6.1)	2.81 (7.1)	.20 x .40 (0.5 x 1.0)	4.0 (1.8)
150	AE030150	3.88 (9.8)	3.84 (9.7)	3.41 (8.6)	2.97 (7.5)	3.13 (7.9)	.20 x .40 (0.5 x 1.0)	6.5 (2.9)
250	AE030250	4.13 (10.4)	4.50 (11.4)	3.84 (9.7)	2.94 (7.4)	3.75 (9.5)	.20 x .40 (0.5 x 1.0)	9.2 (4.2)
350	AE030350	5.00 (12.7)	4.50 (11.4)	3.84 (9.7)	3.78 (9.6)	3.75 (9.5)	.20 x .40 (0.5 x 1.0)	12.7 (5.8)
500	AE030500	5.53 (14.0)	5.25 (13.3)	4.66 (11.8)	4.16 (10.5)	4.34 (11.0)	.31 x .69 (0.8 X 1.7)	19.0 (8.6)
750	AE030750	6.81 (17.3)	5.25 (13.3)	4.66 (11.8)	5.75 (14.6)	4.38 (11.1)	.31 x .69 (0.8 X 1.7)	26.0 (11.8)

240 X 480, 230 X 460, 220 X 440 PRIMARY VOLTS —120/115/110 SECONDARY VOLTS — 1Ø, 50/60 Hz

AE SERIES

VA Rating	Catalog Number	Approximate Dimensions (Inches)(Cm.)					Mounting Slot F	Approximate Ship Weight (Lbs.)(Kg.)
		A	B	C	D	E		
50	AE060050	2.69 (6.8)	3.00 (7.6)	2.81 (7.1)	2.03 (5.1)	2.53 (6.4)	.20 x .40 (0.5 x 1.0)	2.5 (1.1)
75	AE060075	3.22 (8.1)	3.00 (7.6)	2.81 (7.1)	2.53 (6.4)	2.53 (6.4)	.20 x .40 (0.5 x 1.0)	3.5 (1.6)
100	AE060100	3.28 (8.3)	3.41 (8.6)	3.09 (7.8)	2.41 (6.1)	2.81 (7.1)	.20 x .40 (0.5 x 1.0)	4.0 (1.8)
150	AE060150	3.88 (9.8)	3.84 (9.7)	3.41 (8.6)	2.97 (7.5)	3.13 (7.5)	.20 x .40 (0.5 x 1.0)	6.5 (2.9)
250	AE060250	4.13 (10.4)	4.50 (11.4)	3.84 (9.7)	2.94 (7.4)	3.75 (9.5)	.20 x .40 (0.5 x 1.0)	9.2 (4.2)
350	AE060350	5.00 (12.7)	4.50 (11.4)	3.84 (9.7)	3.78 (9.6)	3.75 (9.5)	.20 x .40 (0.5 x 1.0)	12.7 (5.8)
500	AE060500	5.53 (14.0)	5.25 (13.3)	4.66 (11.8)	4.16 (10.5)	4.34 (11.0)	.31 x .69 (0.8 X 1.7)	19.0 (8.6)
750	AE060750	6.81 (17.3)	5.25 (13.3)	4.66 (11.8)	5.75 (14.6)	4.31 (10.9)	.31 x .69 (0.8 X 1.7)	26.0 (11.8)



120 X 240 PRIMARY VOLTS — 24 SECONDARY VOLTS — 1Ø, 50/60 Hz

CE SERIES

VA Rating	Catalog Number	Approximate Dimensions (Inches)(Cm.)					Mounting Slot F	Approximate Ship Weight (Lbs.)(Kg.)
		A	B	C	D	E		
50	CE010050	2.69 (6.8)	3.00 (7.6)	2.81 (7.1)	2.25 (5.7)	2.56 (6.5)	.20 x .40 (0.5 x 1.0)	2.5 (1.2)
75	CE010075	3.22 (8.1)	3.41 (8.6)	2.81 (7.1)	2.25 (5.7)	2.88 (7.3)	.20 x .40 (0.5 x 1.0)	3.5 (1.6)
100	CE010100	3.28 (8.3)	3.75 (9.5)	3.09 (7.8)	2.53 (6.4)	3.13 (7.9)	.20 x .40 (0.5 x 1.0)	4.2 (1.9)
150	CE010150	3.88 (9.8)	4.50 (11.4)	3.41 (8.6)	2.53 (6.4)	3.84 (9.7)	.20 x .40 (0.5 x 1.0)	6.6 (3.0)
250	CE010250	4.13 (10.4)	4.50 (11.4)	4.03 (10.2)	3.22 (8.1)	3.84 (9.7)	.20 x .40 (0.5 x 1.0)	9.4 (4.3)
350	CE010350	5.00 (12.7)	5.25 (13.3)	4.03 (10.2)	3.75 (9.5)	4.50 (11.4)	.31 x .69 (0.8 X 1.7)	13.0 (5.9)
500	CE010500	5.50 (13.9)	5.25 (13.3)	4.66 (11.8)	4.28 (10.8)	4.50 (11.4)	.31 x .69 (0.8 X 1.7)	19.1 (8.7)
750	CE010750	7.03 (17.8)	5.25 (13.3)	4.66 (11.8)	5.75 (14.6)	4.50 (11.4)	.31 x .69 (0.8 X 1.7)	26.6 (12.1)

200/220/440, 208/230/460, 240/480 PRIMARY VOLTS — 23/110, 24/115, 25/120 SECONDARY VOLTS — 1Ø, 50/60 Hz

CE SERIES

VA Rating	Catalog Number	Approximate Dimensions (Inches)(Cm.)					Mounting Slot F	Approximate Ship Weight (Lbs.)(Kg.)
		A	B	C	D	E		
50	CE020050	3.28 (8.3)	3.28 (8.3)	2.81 (7.1)	2.25 (5.7)	2.81 (7.1)	.20 x .40 (0.5 x 1.0)	2.7 (1.2)
100	CE020100	4.03 (10.2)	3.75 (9.5)	3.13 (7.9)	3.22 (8.1)	3.16 (8.0)	.20 x .40 (0.5 x 1.0)	4.3 (1.9)
150	CE020150	4.03 (10.2)	4.50 (11.4)	3.41 (8.6)	2.81 (7.1)	3.75 (9.5)	.20 x .40 (0.5 x 1.0)	6.8 (3.0)
250	CE020250	4.78 (12.1)	4.50 (11.4)	4.03 (10.2)	4.06 (10.3)	3.75 (9.5)	.20 x .40 (0.5 x 1.0)	9.7 (4.4)
350	CE020350	5.53 (14.0)	5.25 (13.3)	4.03 (10.2)	4.28 (10.8)	4.38 (11.1)	.31 x .69 (0.8 X 1.7)	13.5 (6.1)
500	CE020500	7.25 (18.4)	5.25 (13.3)	4.69 (11.9)	6.00 (15.2)	4.38 (11.1)	.31 x .69 (0.8 X 1.7)	19.6 (8.9)
750	CE020750	6.81 (17.3)	5.28 (13.4)	4.69 (11.9)	5.75 (14.6)	4.44 (11.2)	.31 x .69 (0.8 X 1.7)	27.0 (12.2)

**208, 220/380/440, 230/400/460, 240/416/480 PRIMARY VOLTS —
85/100/110, 91/110/120, 95/115/125, 99/120/130 SECONDARY VOLTS — 1Ø, 50/60 Hz**

CE SERIES

VA Rating	Catalog Number	Approximate Dimensions (Inches)(Cm.)					Mounting Slot F	Approximate Ship Weight (Lbs.)(Kg.)
		A	B	C	D	E		
50	CE050050	4.03 (10.2)	3.41 (8.6)	3.09 (7.8)	2.47 (6.2)	2.81 (7.1)	.20 x .40 (0.5 x 1.0)	2.7 (1.2)
150	CE050150	3.88 (9.8)	4.34 (11.0)	3.41 (8.6)	2.88 (7.3)	3.75 (9.5)	.20 x .40 (0.5 x 1.0)	6.7 (3.0)
250	CE050250	5.13 (13.0)	4.50 (11.4)	4.03 (10.2)	4.38 (11.1)	3.75 (9.5)	.20 x .40 (0.5 x 1.0)	9.5 (4.3)
350	CE050350	5.91 (15.0)	5.25 (13.3)	4.03 (10.2)	4.78 (12.1)	4.38 (11.1)	.31 x .69 (0.8 X 1.7)	13.3 (6.0)
500	CE050500	5.91 (15.0)	5.25 (13.3)	4.66 (11.8)	4.63 (11.7)	4.38 (11.1)	.31 x .69 (0.8 X 1.7)	19.0 (8.6)
750	CE050750	7.09 (18.0)	5.25 (13.3)	4.66 (11.1)	5.81 (14.7)	4.38 (11.1)	.31 x .69 (0.8 X 1.7)	27.0 (12.2)



240 X 480 PRIMARY VOLTS—24 SECONDARY VOLTS — 1Ø, 50/60 Hz

CE SERIES

VA Rating	Catalog Number	Approximate Dimensions (Inches)(Cm.)					Mounting Slot F	Approximate Ship Weight (Lbs.)(Kg.)
		A	B	C	D	E		
50	CE030050	3.00 (7.6)	3.00 (7.6)	2.81 (7.1)	2.25 (5.7)	2.53 (6.4)	.20 x .40 (0.5 x 1.0)	2.5 (1.1)
75	CE030075	3.28 (8.3)	3.28 (8.3)	2.81 (7.1)	2.25 (5.7)	2.81 (7.1)	.20 x .40 (0.5 x 1.0)	3.5 (1.6)
100	CE030100	3.28 (8.3)	3.75 (9.5)	3.09 (7.8)	2.53 (6.4)	3.13 (7.9)	.20 x .40 (0.5 x 1.0)	4.0 (1.8)
150	CE030150	3.88 (9.8)	4.50 (11.4)	3.47 (8.8)	2.53 (6.4)	3.75 (9.5)	.20 x .40 (0.5 x 1.0)	6.5 (2.9)
250	CE030250	4.13 (10.4)	4.50 (11.4)	4.03 (10.2)	3.22 (8.1)	3.75 (9.5)	.20 x .40 (0.5 x 1.0)	9.2 (4.2)
350	CE030350	5.00 (12.7)	5.25 (13.3)	4.03 (10.2)	3.75 (9.5)	4.38 (11.1)	.31 x .69 (0.8 X 1.7)	12.7 (5.8)
500	CE030500	5.53 (14.0)	5.25 (13.3)	4.66 (11.8)	4.28 (10.8)	4.38 (11.1)	.31 x .69 (0.8 X 1.7)	19.0 (8.6)
750	CE030750	7.03 (17.8)	5.25 (13.3)	4.66 (11.8)	5.41 (13.7)	4.38 (11.1)	.31 x .69 (0.8 X 1.7)	26.0 (11.8)

240 X 480, 230 X 460, 220 X 440 PRIMARY VOLTS—120/115/110 SECONDARY VOLTS — 1Ø, 50/60 Hz

CE SERIES

VA Rating	Catalog Number	Approximate Dimensions (Inches)(Cm.)					Mounting Slot F	Approximate Ship Weight (Lbs.)(Kg.)
		A	B	C	D	E		
50	CE060050	3.41 (8.6)	3.00 (7.6)	2.81 (7.1)	2.53 (6.4)	2.53 (6.4)	.20 x .40 (0.5 x 1.0)	2.6 (1.2)
75	CE060075	3.41 (8.6)	3.28 (8.3)	2.81 (7.1)	2.53 (6.4)	2.81 (7.1)	.20 x .40 (0.5 x 1.0)	3.6 (1.6)
100	CE060100	3.41 (8.6)	3.75 (9.5)	3.09 (7.8)	2.53 (6.4)	3.13 (7.9)	.20 x .40 (0.5 x 1.0)	4.3 (1.9)
150	CE060150	3.88 (9.8)	4.50 (11.4)	3.47 (8.8)	2.53 (6.4)	3.75 (9.5)	.20 x .40 (0.5 x 1.0)	6.7 (3.0)
250	CE060250	4.13 (10.4)	4.50 (11.4)	4.03 (10.2)	3.22 (8.1)	3.75 (9.5)	.20 x .40 (0.5 x 1.0)	9.4 (4.3)
300	CE060300	4.53 (11.5)	4.50 (11.4)	4.03 (10.2)	3.75 (9.5)	3.75 (9.5)	.20 x .40 (0.5 x 1.0)	10.9 (4.9)
350	CE060350	5.00 (12.7)	5.25 (13.3)	4.03 (10.2)	3.75 (9.5)	4.38 (11.1)	.31 x .69 (0.8 X 1.7)	13.0 (5.9)
500	CE060500	6.00 (15.2)	5.25 (13.3)	4.66 (11.8)	4.78 (12.1)	4.38 (11.1)	.31 x .69 (0.8 X 1.7)	18.8 (8.5)
750	CE060750	6.81 (17.3)	5.25 (13.3)	4.66 (11.8)	5.75 (14.6)	4.38 (11.1)	.31 x .69 (0.8 X 1.7)	26.0 (11.8)

380/400/415 PRIMARY VOLTS— 110/220 SECONDARY VOLTS — 1Ø, 50/60 Hz

CE SERIES

VA Rating	Catalog Number	Approximate Dimensions (Inches)(Cm.)					Mounting Slot F	Approximate Ship Weight (Lbs.)(Kg.)
		A	B	C	D	E		
50	CE040050	3.53 (8.9)	3.00 (7.6)	2.81 (7.1)	2.53 (6.4)	2.53 (6.4)	.20 x .40 (0.5 x 1.0)	2.6 (1.2)
100	CE040100	3.53 (8.9)	3.75 (9.5)	3.22 (8.1)	2.53 (6.4)	3.13 (8.0)	.20 x .40 (0.5 x 1.0)	4.3 (1.9)
150	CE040150	3.53 (8.9)	4.34 (11.0)	3.41 (8.6)	2.53 (6.4)	3.75 (9.5)	.20 x .40 (0.5 x 1.0)	6.7 (3.0)
250	CE040250	4.03 (10.2)	4.50 (11.4)	4.22 (10.7)	3.22 (8.1)	3.75 (9.5)	.20 x .40 (0.5 x 1.0)	9.4 (4.3)
350	CE040350	4.91 (12.4)	4.50 (11.4)	4.22 (10.7)	4.06 (10.3)	3.75 (9.5)	.20 x .40 (0.5 x 1.0)	13.0 (5.9)
500	CE040500	6.00 (15.2)	5.25 (13.3)	4.69 (11.9)	4.78 (12.1)	4.38 (11.1)	.31 x .69 (0.8 X 1.7)	18.8 (8.5)
750	CE040750	6.81 (17.3)	5.25 (13.3)	4.69 (11.9)	5.75 (14.6)	4.38 (11.1)	.31 x .69 (0.8 X 1.7)	26.0 (11.8)

CONNECTION DETAILS FOR AE05 & CE05

H1-H2	H1-H3	H1-H4	X1-X2	X1-X3	X1-X4
208			85	100	110
220	380	440	91	110	120
230	400	460	95	115	125
240	416	480	99	120	130

FUSE KITS AND ACCESSORIES

Catalog Number	VA	Description	Approximate Ship Weight (Lbs.)(Kg.)
PL79920	50-750	Fuse Kit: Primary Fuse Block EIC Series (2 Class CC Blocks)	1.0 (0.5)
PL79921	150-750	Fuse Kit: Primary & Secondary Fuse Block EIC Series (2 Class CC and 1 Midget Blocks)	1.0 (0.5)
PL79922	50-750	Fuse Kit: Primary Fuse Block EIC Series CE Listed w/ Covers (2 Class CC Blocks)	1.0 (0.5)
PL79923	150-750	Fuse Kit: Primary & Secondary Fuse Block EIC Series CE Listed w/ Covers (2 Class CC and 1 Midget Blocks)	1.0 (0.5)
PL79924		Fuse Kit: Secondary Fuse 1/4" x 1-1/4" w/ARM	1.0 (0.5)
PL79925	50-350	Cover: Small Terminal Covers (Qty. 2)	1.0 (0.5)
PL79926	500 & 750	Cover: Large Terminal Covers (Qty. 2)	1.0 (0.5)
PL79927		Cover: Fuse Block Covers (Qty. 1)	1.0 (0.5)
PL79928	50-350	Link: Small Jumper Links (Qty. 2)	1.0 (0.5)
PL79929	500 & 750	Link: Large Jumper Links (Qty. 2)	1.0 (0.5)
PL79930	50-350	Fuse Kit: Secondary Fuse Midget w/ARM	1.0 (0.5)
PL79931	500 & 750	Fuse Kit: Secondary Fuse Midget w/ARM	1.0 (0.5)

AE AND CE WIRING DIAGRAMS

WIRING FOR AE01 & CE01

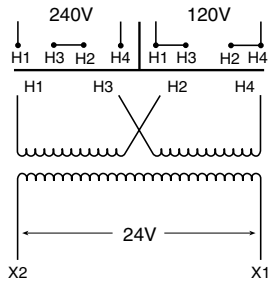

WIRING FOR AE02 & CE02

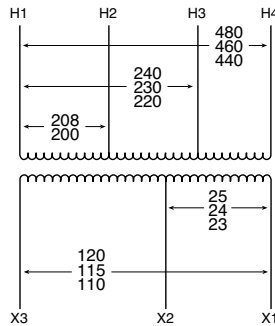

WIRING FOR AE03 & CE03

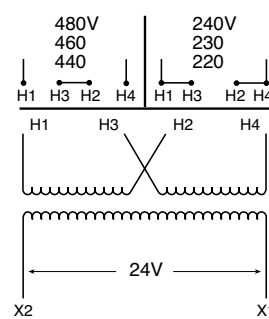

WIRING FOR CE04

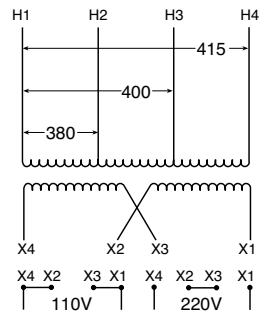

WIRING FOR AE05 & CE05

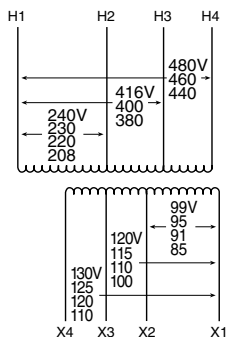

WIRING FOR AE06 & CE06

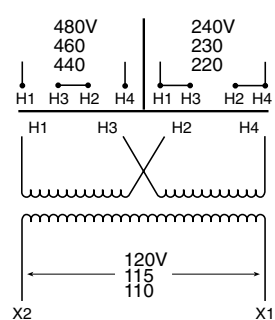

WIRING FOR AE07

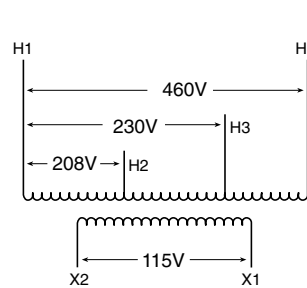

WIRING FOR AE 12

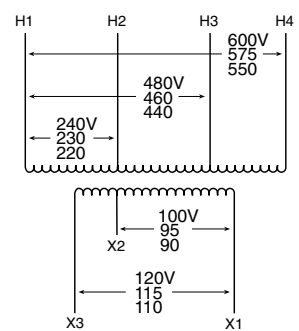

AE AND CE SERIES DIMENSIONAL DRAWINGS

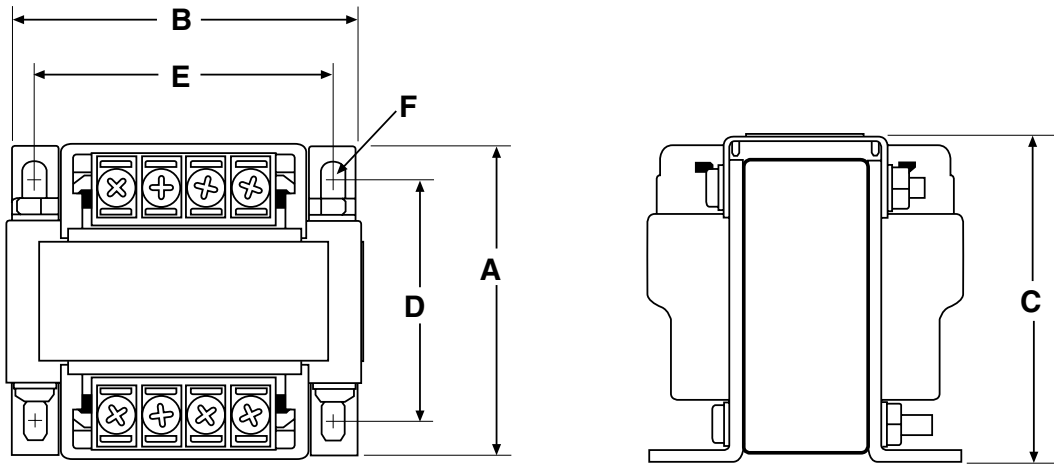

FINGER/GUARD INDUSTRIAL CONTROL TRANSFORMER

The Acme FINGER/GUARD® line of Touch-Protected Industrial Control Transformers offers the most advanced and versatile design concepts available to the marketplace today

They are designed to meet Acme's rigid standards for mechanical durability as well as surpass Agency and Industry electrical standards. The FINGER/GUARD® line is designed for all control applications and features integrally installed, durable molded plastic terminations designed to protect against contact with live components. No slip-on plastic covers to be broken, lost or misplaced.

All FINGER/GUARD® products use copper windings, high-permeability silicon steel cores and 130 degree C (Class B) insulation. All FINGER/GUARD® products meet or exceed ANSI, IEC and NEMA standards. They are third party witness tested and are UL Listed (File E79947), CSA Certified (File 7357) and CE Marked (to EN60742)... ON ALL SIZES. The product is suitable for both 50 and 60 Hertz applications and is available in sizes ranging from 50 VA to 3000 VA.

Features

- Constructed with high quality silicon steel lamination to minimize core losses and increase efficiency.
- Designs incorporate precision wound coils for improved regulation.
- Copper windings on all groups.
- 50 VA through 3000 VA sizes, 50/60 Hz.
- 130°C (Class B) Insulation 80°C temperature rise.
- Voltage regulation exceeds NEMA requirements.
- UL Listed, CSA Certified and CE Marked.
- Attractive finish, nameplate, and design features enhance the end product.
- Ten-year limited warranty.
- Smaller, lighter weight design.

CE MARKING Series for Global Applications

The CE Marking, standing for Conformité Européene, is a European Mark of conformity indicating that a product or system to which it is applied, complies with European law (Directives) regulating a necessary level of protection in Europe with respect to safety, health, environmental and consumer protection; however, it is not intended as a guarantee of quality for the consumer. The CE Marking must be applied to products being placed on the European market. The CE Marking does allow a product to be moved freely within the internal market of the European Union.

The Directives that apply to Control or Power Distribution Transformers are:

- Low Voltage Directive, 2006/95/EC
- Electromagnetic Compatibility (EMC) Directive, 2004/108/EC

The stringent testing required to obtain a third party certification mark in many cases is significantly more rigid than domestic requirements. This ensures that not only the Acme FINGER/GUARD® product, but all of our CE Marked products are designed to meet a higher level of safety standards than non-CE Marked products.

All Acme transformers are manufactured in a facility certified by Underwriters Laboratories to ISO-9001.

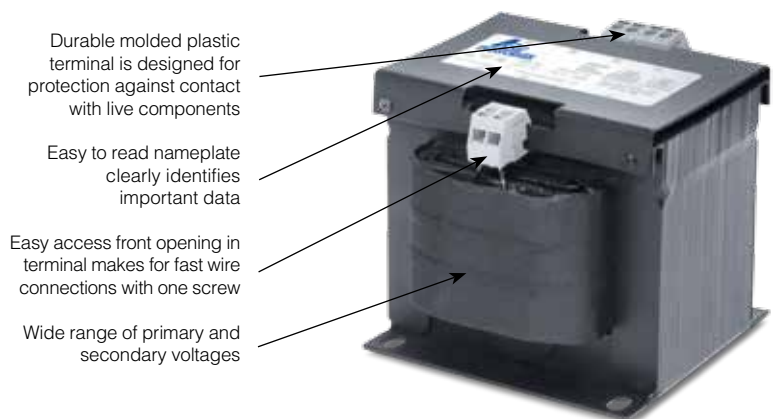



120 X 240 PRIMARY VOLTS — 24 SECONDARY VOLTS — 1Ø, 50/60 Hz

VA Rating	Catalog Number	European Rating*	Approximate Dimensions (Inches)(Cm.)					Mounting Slot F	Approximate Ship Weight (Lbs.)(Kg.)	Wiring Diagram
			A	B	C	D	E			
1000	FS11000	870	4.76 (12.1)	6.75 (17.1)	6.03 (15.3)	5.75 (14.6)	2.86 (7.3)	.31 x .50 (0.8 x 1.3)	26 (11.8)	A

240 X 480, 230 X 460, 220 X 440 PRIMARY VOLTS — 120/115/110 SECONDARY VOLTS — 1Ø, 50/60 Hz

VA Rating	Catalog Number	European Rating*	Approximate Dimensions (Inches)(Cm.)					Mounting Slot F	Approximate Ship Weight (Lbs.)(Kg.)	Wiring Diagram
			A	B	C	D	E			
1000	FS21000	870	4.76 (12.1)	6.75 (17.1)	6.03 (15.3)	5.75 (14.6)	2.86 (7.3)	.31 x .50 (0.8 x 1.3)	26 (11.8)	B
1500	FS21500	1290	6.01 (15.3)	6.75 (17.1)	6.03 (15.3)	5.75 (14.6)	4.13 (10.5)	.31 x .50 (0.8 x 1.3)	38 (17.2)	B
2000	FS22000	1680	6.51 (16.5)	6.75 (17.1)	6.03 (15.3)	5.75 (14.6)	4.63 (11.8)	.31 x .50 (0.8 x 1.3)	44 (20.0)	B
3000	FS23000	2465	7.44 (18.9)	7.50 (19.1)	6.68 (17.0)	6.50 (16.5)	6.47 (16.4)	.41 x .81 (1.0 x 2.1)	60 (27.2)	B

240/416/480/600; 230/400/460/575; 220/380/440/550; 208/500 PRIMARY VOLTS 99/120/130; 95/115/125; 91/110/120; 85/100/110 SECONDARY VOLTS — 1Ø, 50/60 Hz

VA Rating	Catalog Number	European Rating*	Approximate Dimensions (Inches)(Cm.)					Mounting Slot F	Approximate Ship Weight (Lbs.)(Kg.)	Wiring Diagram
			A	B	C	D	E			
50	FS350	50	2.59 (6.6)	3.75 (9.5)	3.64 (9.2)	3.13 (8.0)	1.70 (4.3)	.22 x .50 (0.6 x 1.3)	5 (2.3)	C
150	FS3150	150	3.31 (8.4)	4.50 (11.4)	4.15 (10.5)	3.75 (9.5)	2.18 (5.5)	.22 x .50 (0.6 x 1.3)	8 (3.6)	C
250	FS3250	250	3.61 (9.2)	4.88 (12.4)	4.46 (11.3)	4.06 (10.3)	2.33 (5.9)	.22 x .50 (0.6 x 1.3)	11 (5.0)	C
350	FS3350	345	4.69 (11.9)	4.88 (12.4)	4.46 (11.3)	4.06 (10.3)	3.48 (8.8)	.22 x .50 (0.6 x 1.3)	17 (7.7)	C
500	FS3500	490	4.39 (11.2)	6.75 (17.1)	6.03 (15.3)	5.75 (14.6)	2.48 (6.3)	.31 x .50 (0.8 x 1.3)	22 (10.0)	C
750	FS3750	720	5.18 (13.2)	6.75 (17.1)	6.03 (15.3)	5.75 (14.6)	3.31 (8.4)	.31 x .50 (0.8 x 1.3)	30 (13.6)	C
1000	FS31000	870	6.18 (15.7)	6.75 (17.1)	6.03 (15.3)	5.75 (14.6)	4.30 (10.9)	.31 x .50 (0.8 x 1.3)	39 (17.7)	C
1500	FS31500	1290	6.26 (15.9)	7.50 (19.1)	6.68 (17.0)	6.50 (16.5)	5.26 (13.4)	.41 x .81 (1.0 x 2.1)	51 (23.1)	C
2000	FS32000	1680	7.76 (19.7)	7.50 (19.1)	7.70 (19.6)	6.50 (16.5)	6.75 (17.1)	.41 x .81 (1.0 x 2.1)	66 (29.9)	C
3000	FS33000	2465	8.88 (22.6)	11.92 (30.3)	8.83 (22.4)	6.75 (17.1)	5.75 (14.6)	.41 x .81 (1.0 x 2.1)	70 (31.8)	C

FUSE KITS — FOR FINGER/GUARD® INDUSTRIAL CONTROL TRANSFORMERS

Catalog Number	Description
PL79905	PRIMARY FUSE KIT FOR CLASS CC FUSES
PL79906	PRIMARY & SECONDARY FUSE KIT FOR CLASS CC PRIMARY FUSES & MIDGET SECONDARY FUSE
PL79907	PRIMARY FUSE KIT FOR MIDGET FUSES
PL79908	PRIMARY & SECONDARY FUSE KIT FOR MIDGET FUSES

* EN60742 requires transformers to pass the temperature rise limits of a 130° C (Class B) insulation system at 6% above the rated supply voltage.

CONNECTION DETAILS WIRING DIAGRAM C

Connect to Line for Respective Voltage					Output Volts	
H1-H2	H1-H3	H1-H4	H1-H5	X1-X2	X1-X3	X1-X4
208	—	—	500	85	100	110
220	380	440	550	91	110	120
230	400	460	575	95	115	125
240	416	480	600	99	120	130

FINGER/GUARD® WIRING DIAGRAMS

A

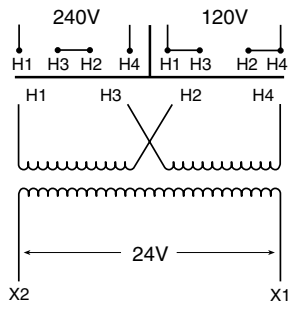

B

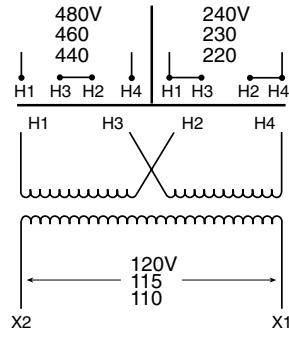

C

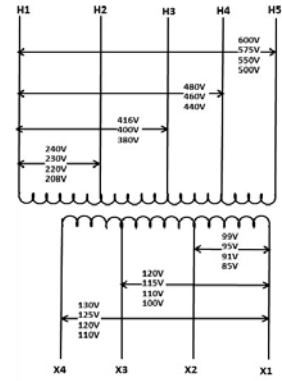

FINGER/GUARD® DIMENSIONAL DRAWINGS

50 VA THRU 2 kVA

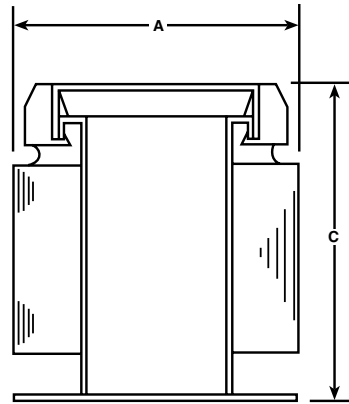
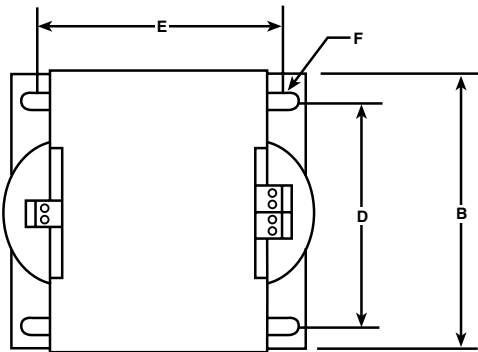

3 kVA

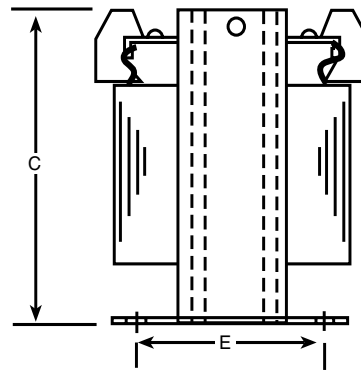
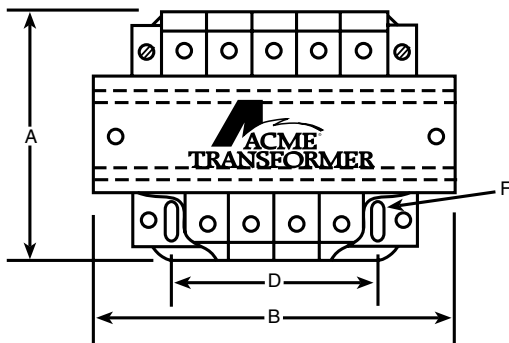



N85 W12545 Westbrook Crossing
Menomonee Falls, WI 53051
800.334.5214

hubbell-acmeelectric.com



Hubbell Canada Inc.
905-839-1138

Hubbell de Mexico, S.A. de C.V.
52-55-9151-9999

ACM_BRO_027_0216