

STEEL TRACK, 30 lb.

COMPONENTS



For loads up to 30 lbs. (13.5 kg)

RAIL LENGTH		MODEL NUMBER
ft.	(m)	
3.0	(0.9)	WS30-T03
4.0	(1.2)	WS30-T04
5.0	(1.5)	WS30-T05
6.0	(1.8)	WS30-T06
7.0	(2.1)	WS30-T07
8.0	(2.4)	WS30-T08
9.0	(2.7)	WS30-T09

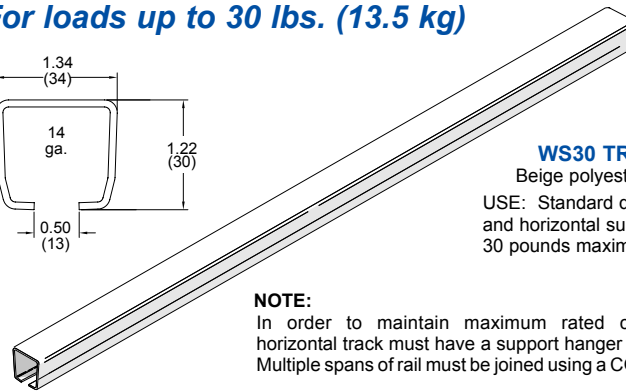
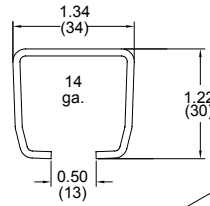

WS30 TRACK

Beige polyester finish.
USE: Standard duty tool rail and horizontal supports up to 30 pounds maximum load.

NOTE:

In order to maintain maximum rated capacity all WS30 horizontal track must have a support hanger every 6.0 ft. (1.8m). Multiple spans of rail must be joined using a COUPLER/HANGER.

Consult factory for lengths not shown above.

Separate **TOOL RAIL COMPONENTS** allow you to quickly and inexpensively build your own work stations, retrofit existing stations or customize a kit. Finished as shown, all parts are the same high quality included with kits and guaranteed to be interchangeable. Components shown are designed for use with **WS30** rail. Starred (*) items may also be used with WS50 or extruded aluminum rails. **Mounting hardware, where required, is included.**

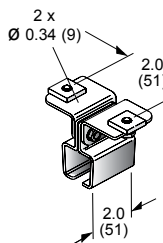

WS30-HG HANGER

Black polyester finish.
USE: Hang/support single spans of WS30 rail from **WS50, WA50 Extruded Aluminum** rail or other suitable support.

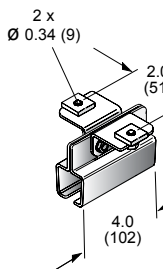

WS30-CH COUPLER/HANGER

Black polyester finish.
USE: Connects and hangs multiple spans of WS30 rail from **WS50, WA50 Extruded Aluminum** rail or other suitable supports

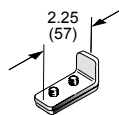

WS30-ES END STOP

Zinc plated steel.
USE: Keeps trolley movement within preselected limits.

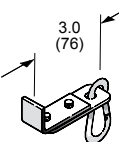

WS30-ESH END STOP HOOK

Zinc plated steel.
USE: Supports tool balancer. Also acts as end stop.

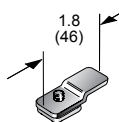

WS-HC* HOLDOWN CLIP

Black polyester finish.
USE: Affixes conveyors and other machines to top of rail.

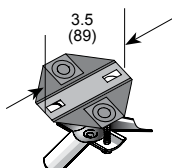

WS-EC01* 0.31 - 0.59 O.D. (08 - 15mm)

WS-EC02* 0.60 - 0.94 O.D. (15 - 24mm)

END CLAMP ASSY
USE: Supports hose/cable and prevents trolley overtravel.

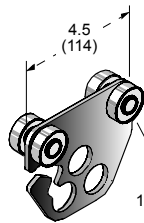

WS30-BTL BALANCER TROLLEY

Black polyester finish.
USE: Moving support for tool balancers, etc. Runs in WS30 tool rail.



WS30-BTS SINGLE ROLLER BALANCER TROLLEY

Black polyester finish.
USE: Tool balancer trolley. Runs in WS30 tool rail.

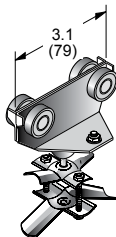

WS30-HT01* 0.31 - 0.59 O.D. hose (08 - 15mm)

WS30-HT02* 0.60 - 0.94 O.D. hose (15 - 24mm)

HOSE/CABLE TROLLEY
Black polyester finish.
USE: Moving cable/hose clip.

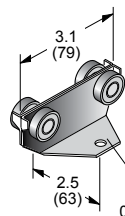

WS30-03TP PLAIN TROLLEY

Black polyester finish.
USE: Utility trolley

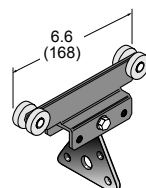

WS30-SPT SWING PLATE TROLLEY

Black polyester finish.
USE: Designed for use with Hose-Hider but also works extremely well alone. Swinging tool hook aids lateral movement.

WS30-TB BENCH MOUNT

Black polyester finish.
USE: Mounting WS30 rail vertically to bench top.

WS30-TBS Backing Plate Optional (Use beneath mounting surface.)

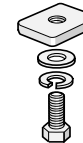
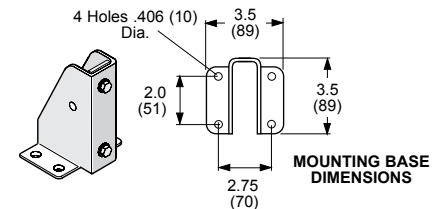

WS30-TN* TRACK NUT

Zinc plated steel.
USE: Attaches fixed components to rail.

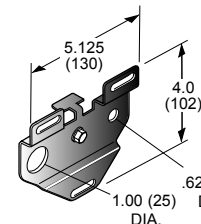

WS-UH* UNIVERSAL BRACKET

Black polyester finish.
USE: Supports hose or cable, peg board, etc.

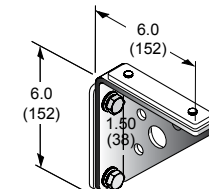

WS-AB* ANGLE BRACKET

Black polyester finish.
USE: Mounts horizontal tool rail to vertical column.

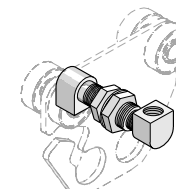

WS00-CH* 90° CONNECTOR

Brass. For 3/8"(9mm) hose.
USE: Attach hose to balancer trolley or various brackets.

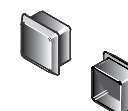

WS30-EP END CAP

Black molded vinyl.
USE: Caps off ends of rail for a finished look.