

MODULAR CARRIER TRAK

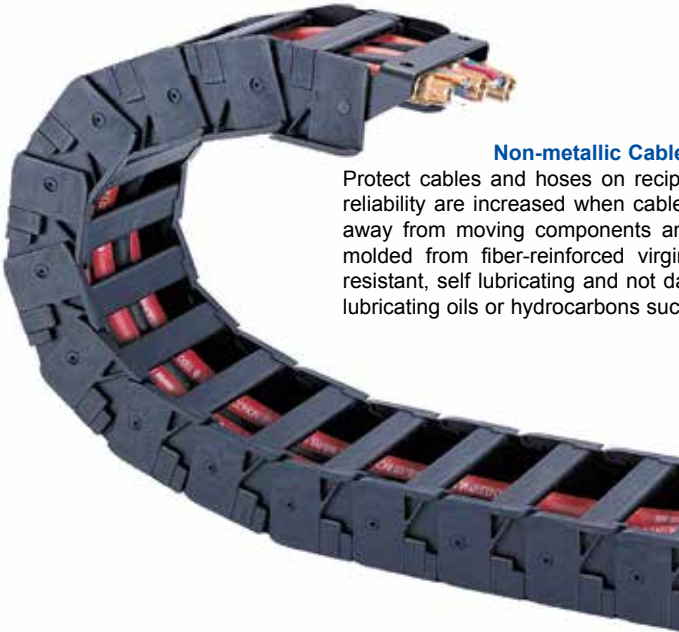

Non-metallic Cable/Hose Carriers

Protect cables and hoses on reciprocating machinery. Safety and reliability are increased when cables and hoses are kept together, away from moving components and operators. Durable links are molded from fiber-reinforced virgin nylon which is highly wear-resistant, self lubricating and not damaged by salt, hard water and lubricating oils or hydrocarbons such as fuels.



Modular Trak is available in a wide variety of configurations and sizes to handle cable or hose up to 1.676" dia. Larger sizes are available with standard closed tops, flip-tops to facilitate cable/hose installation, or completely enclosed models designed to protect cables and hoses from dirt, chips, etc. Kits of all styles facilitate application and purchasing. Standard and flip-top configurations are also available in bulk which is especially attractive to OEM and other high volume users. Refer to following pages for details.

Easy Assembly of Kits or Bulk Trak

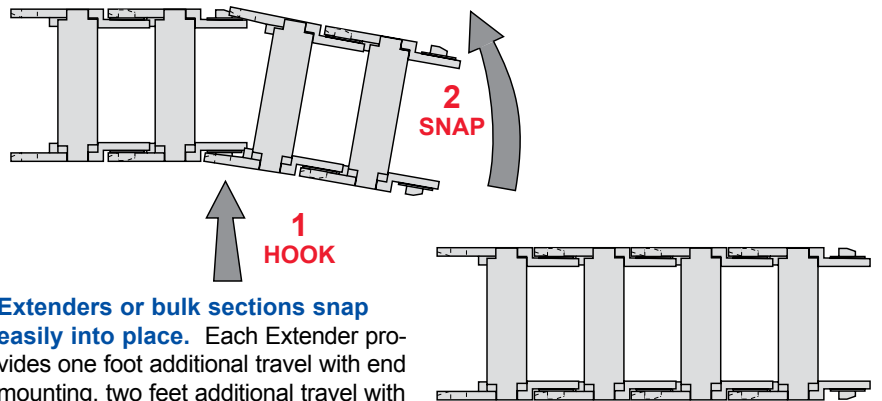
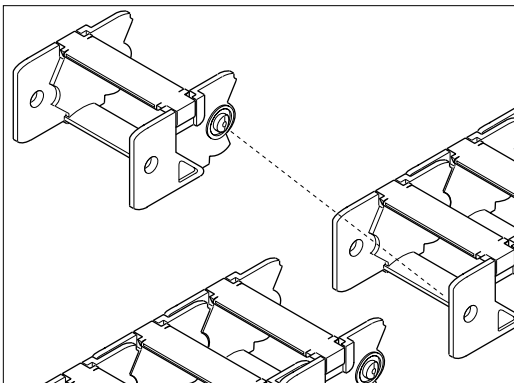

Extenders or bulk sections snap easily into place. Each Extender provides one foot additional travel with end mounting, two feet additional travel with center mounting. Individual links may be removed to arrive at exact length.

Flip-Top

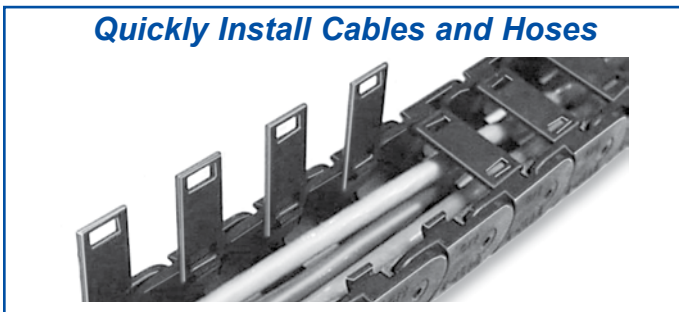

Snap-In Separators

(Optional for P16 and P25)

Group Cables and Hoses

OPTIONAL Snap-in Separators (see dimension "N") may be ordered for Types P16 and P25. Simple field installation.

Pkg of 12 P16 separators:
Model No. **P16SP**

Pkg of 12 P25 separators:
Model No. **P25SP**

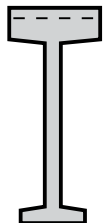

MODULAR TRAK - KITS & BULK SELECTION

BASIC KITS (C) include enough trak to form the curve and provide for three ft. of machine travel (standard mounting) or six ft. of machine travel (center mounting). Mounting hardware included.

EXTENDERS (D) include one foot of trak only - no hardware. Extenders are inserted into the BASIC KIT to provide additional travel and required overall length. Links snap together. Individual links can be easily removed with a screwdriver to provide custom length.

BULK TRAK is ideal for high volume users. Shipped in 10' lengths packed in 12" x 12" x 12" cartons or 3" lengths packed in 12.5" x 12.5" x 40" cartons. Bulk trak does NOT include brackets. Order brackets (sets of 6 only) separately.

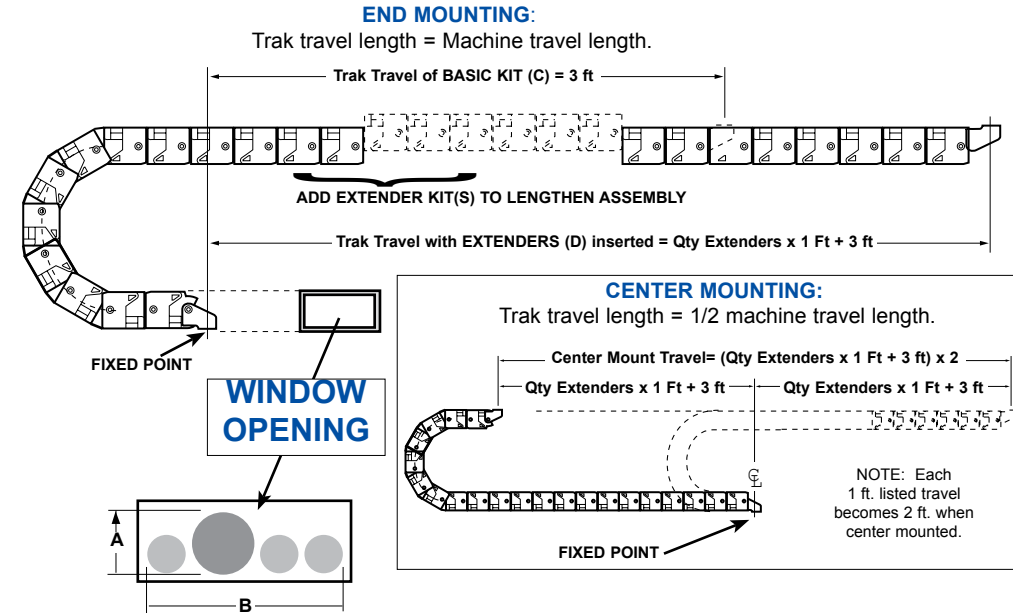

1. WINDOW. See columns A & B below. Select trak that accommodates height and width of hose/cable bundle.

2. TRAVEL. Measure machine travel. Determine if fixed point of trak is to be at end (standard mount) or in center of machine travel. See drawings, left.

3. ORDER TRAK.

A. BASIC KIT (C) provides 3' travel (standard mount), up to 6' for center mount.

B. EXTENDER KITS (D) Provide 1' travel. Order as many as needed for travel.

Formula: *Trak travel (ft) minus 3 (rounded to next highest number) equals extender kits required.*

NOTE:

Individual links may be removed to obtain exact length. See DIMENSIONS page for length (pitch) of each size link.

A Max. Height Largest O.D. Hose/Cable in. (mm)	B Max. Width Hose/Cable Bundle in. (mm)	C Basic Kit 3 Ft. Travel (With brackets) Model No.	D Extender 1 Ft. Travel (No brackets) Model No.	Bulk Trak 3 Ft. Lengths Brackets NOT included Model No.	Bulk Trak Total Length in Carton ft.	Brackets Male & Female 6 sets Model No.
0.286 (7)	0.531 (13)	P10-1-1.4-3.0	EP10-1-1.4-1.0	BP10-1-1.4	318	BB10-1
0.286 (7)	0.900 (23)	P10-2-1.4-3.0	EP10-2-1.4-1.0	BP10-2-1.4	264	BB10-2
0.382 (9)	0.900 (23)	P10-2-1.9-3.0	EP10-2-1.9-1.0	BP10-2-1.9	264	BB10-2
0.410 (10)	1.350 (34)	P13-1-2.0-3.0	EP13-1-2.0-1.0	BP13-1-2.0	120	BB13-1
0.740 (19)	1.350 (34)	P13-1-3.7-3.0	EP13-1-3.7-1.0	BP13-1-3.7	120	BB13-1
0.410 (10)	2.052 (52)	P13-2-2.0-3.0	EP13-2-2.0-1.0	BP13-2-2.0	96	BB13-2
0.740 (19)	2.052 (52)	P13-2-3.7-3.0	EP13-2-3.7-1.0	BP13-2-3.7	96	BB13-2
0.410 (10)	2.772 (70)	P13-3-2.0-3.0	EP13-3-2.0-1.0	BP13-3-2.0	72	BB13-3
0.740 (19)	2.772 (70)	P13-3-3.7-3.0	EP13-3-3.7-1.0	BP13-3-3.7	72	BB13-3
0.382 (9)	1.350 (34)	P16-1-1.9-3.0	EP16-1-1.9-1.0	BP16-1-1.9	90	BB16-1
0.688 (17)	1.350 (34)	P16-1-3.4-3.0	EP16-1-3.4-1.0	BP16-1-3.4	90	BB16-1
0.382 (9)	2.052 (52)	P16-2-1.9-3.0	EP16-2-1.9-1.0	BP16-2-1.9	84	BB16-2
0.688 (17)	2.052 (52)	P16-2-3.4-3.0	EP16-2-3.4-1.0	BP16-2-3.4	84	BB16-2
0.382 (9)	2.772 (70)	P16-3-1.9-3.0	EP16-3-1.9-1.0	BP16-3-1.9	63	BB16-3
0.688 (17)	2.772 (70)	P16-3-3.4-3.0	EP16-3-3.4-1.0	BP16-3-3.4	63	BB16-3
0.382 (9)	3.654 (93)	P16-4-1.9-3.0	EP16-4-1.9-1.0	BP16-4-1.9	42	BB16-4
0.688 (17)	3.654 (93)	P16-4-3.4-3.0	EP16-4-3.4-1.0	BP16-4-3.4	42	BB16-4
0.680 (17)	2.340 (59)	P25-1-3.4-3.0	EP25-1-3.4-1.0	BP25-1-3.4	36	BB25-1
0.680 (17)	3.825 (97)	P25-2-3.4-3.0	EP25-2-3.4-1.0	BP25-2-3.4	24	BB25-2
0.956 (24)	3.825 (97)	P25-2-4.7-3.0	EP25-2-4.7-1.0	BP25-2-4.7	24	BB25-2
1.546 (39)	3.825 (97)	P25-2-7.7-3.0	EP25-2-7.7-1.0	BP25-2-7.7	24	BB25-2
1.575 (40)	3.825 (97)	P25-2-11.6-3.0	EP25-2-11.6-1.0	BP25-2-11.6	24	BB25-2
0.956 (24)	5.940 (151)	P25-3-4.7-3.0	EP25-3-4.7-1.0	BP25-3-4.7	18	BB25-3
1.546 (39)	5.940 (151)	P25-3-7.7-3.0	EP25-3-7.7-1.0	BP25-3-7.7	18	BB25-3
0.468 (12)	1.350 (34)	T0815-2.3-3.0	ET0815-2.3-1.0	-	-	-
0.650 (16)	1.800 (82)	T1020-3.2-3.0	ET1020-3.2-1.0	-	-	-
0.900 (23)	1.800 (82)	T1020-5.8-3.0	ET1020-5.8-1.0	-	-	-
0.824 (21)	2.700 (69)	T1530-4.1-3.0	ET1530-4.1-1.0	-	-	-
1.350 (34)	2.700 (69)	T1530-7.7-3.0	ET1530-7.7-1.0	-	-	-
1.176 (30)	4.050 (103)	T2045-5.8-3.0	ET2045-5.8-1.0	-	-	-
1.676 (43)	4.050 (103)	T2045-8.3-3.0	ET2045-8.3-1.0	-	-	-



Standard



Flip-Top



Enclosed

MODULAR TRAK DIMENSIONS

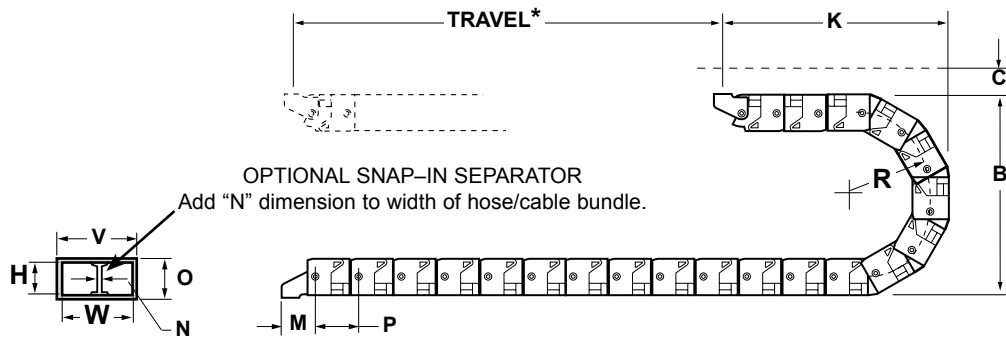

NOTES

***MOUNTING:**

End Mounted *trak* travel equals *machine* travel.

Center Mounted *trak* travel equals 1/2 *machine* travel.

****WEIGHT** per foot of trak only. Add weight per foot of hose/cable bundle.

SERIES	W	H	R	WGT** (lbs/ft.)	B	CLEARANCE C	OVERALL O	K	M	SEPARATOR N	PITCH P	OVERALL V
P10-1-1.4-...	0.59	0.75	1.43	0.20	3.86	2.00	1.00	5.68	1.33	-	1.250	1.03
P10-2-1.4-...	1.00	0.75	1.43	0.25	3.86	2.00	1.00	5.68	1.33	-	1.250	1.44
P10-2-1.9-...	1.00	0.75	1.91	0.25	4.82	2.00	1.00	5.41	1.33	-	1.250	1.44
P13-1-2.0-...	1.50	0.98	2.05	0.44	5.44	3.00	1.34	5.50	1.19	-	1.812	2.12
P13-1-3.7-...	1.50	0.98	3.70	0.44	8.74	3.00	1.34	7.56	1.19	-	1.812	2.12
P13-2-2.0-...	2.28	0.98	2.05	0.48	5.44	3.00	1.34	5.50	1.19	-	1.812	2.91
P13-2-3.7-...	2.28	0.98	3.70	0.48	8.74	3.00	1.34	7.56	1.19	-	1.812	2.91
P13-3-2.0-...	3.08	0.98	2.05	0.54	5.44	3.00	1.34	5.50	1.19	-	1.812	3.70
P13-3-3.7-...	3.08	0.98	3.70	0.54	8.74	3.00	1.34	7.56	1.19	-	1.812	3.70
P16-1-1.9-...	1.50	1.00	1.91	0.55	5.44	3.00	1.62	5.72	1.19	0.14 ⌀	1.812	2.12
P16-1-3.4-...	1.50	1.00	3.44	0.55	8.50	3.00	1.62	7.85	1.19	0.14 ⌀	1.812	2.12
P16-2-1.9-...	2.28	1.00	1.91	0.64	5.44	3.00	1.62	5.72	1.19	0.14 ⌀	1.812	2.91
P16-2-3.4-...	2.28	1.00	3.44	0.64	8.50	3.00	1.62	7.85	1.19	0.14 ⌀	1.812	2.91
P16-3-1.9-...	3.08	1.00	1.91	0.74	5.44	3.00	1.62	5.72	1.19	0.14 ⌀	1.812	3.70
P16-3-3.4-...	3.08	1.00	3.44	0.74	8.50	3.00	1.62	7.85	1.19	0.14 ⌀	1.812	3.70
P16-4-1.9-...	4.06	1.00	1.91	0.84	5.44	3.00	1.62	5.72	1.19	0.14 ⌀	1.812	4.69
P16-4-3.4-...	4.06	1.00	3.44	0.84	8.50	3.00	1.62	7.85	1.19	0.14 ⌀	1.812	4.69
P25-1-3.4-...	2.60	1.75	3.40	1.00	9.30	3.00	2.50	8.31	1.19	0.15 ⌀	2.500	3.70
P25-2-3.4-...	4.25	1.75	3.40	1.20	9.30	3.00	2.50	8.31	1.19	0.15 ⌀	2.500	5.36
P25-2-4.7-...	4.25	1.75	4.78	1.20	12.06	3.00	2.50	10.52	1.19	0.15 ⌀	2.500	5.36
P25-2-7.7-...	4.25	1.75	7.73	1.20	17.96	3.00	2.50	11.84	1.19	0.15 ⌀	2.500	5.36
P25-2-11.6-...	4.25	1.75	11.67	1.20	25.84	3.00	2.50	15.59	1.19	0.15 ⌀	2.500	5.36
P25-3-4.7-...	6.60	1.75	4.78	1.50	12.06	3.00	2.50	10.52	1.19	0.15 ⌀	2.500	7.70
P25-3-7.7-...	6.60	1.75	7.73	1.50	17.96	3.00	2.50	11.84	1.19	0.15 ⌀	2.500	7.70
T0815-2.3-...	1.50	0.81	2.34	0.62	6.34	2.75	1.31	5.32	2.56	-	1.125	2.20
T1020-3.2-...	2.00	1.00	3.25	0.83	8.34	2.75	1.50	7.89	2.81	-	1.375	2.76
T1020-5.8-...	2.00	1.00	5.88	0.83	13.61	2.75	1.50	9.39	2.81	-	1.375	2.76
T1530-4.1-...	3.00	1.50	4.12	1.48	10.92	2.75	2.25	10.77	4.00	-	2.000	3.93
T1530-7.7-...	3.00	1.50	7.75	1.48	18.18	2.75	2.25	14.70	4.00	-	2.000	3.93
T2045-5.8-...	4.50	2.00	5.88	2.20	14.94	2.75	2.75	13.02	4.75	-	2.562	5.55
T2045-8.3-...	4.50	2.00	8.38	2.20	19.94	2.75	2.75	17.59	4.75	-	2.562	5.55

⌀ Brackets for BP16 and BP25 (bulk) shipped six male and six female per box. Brackets included with 3 ft. basic (non-bulk) kits.