

Anchors



Catalog 4

Table of Contents

NOTE: For Anchor Installing Tools, see Catalog Section 4A

The Science of Selecting Anchors 4-3

Anchor Application Information (Soil Classification Data Chart) 4-4

Power-Installed Screw Anchors (Holding-Capacity/Installing-Torque Charts) 4-5

Tough One® Anchor Helix Assemblies - Small Hub (Torque Ratings: 10,000 ft.-lb.) 4-6

Tough One® Anchor Helix Assemblies - Large Hub (Torque Ratings: 10,000 ft.-lb. & 15,000 ft.-lb.) 4-7

Mid-Strength PISA® Anchor Helix Assemblies 1-3/8"-Core (Torque Ratings: 6,000 ft.-lb.) 4-8

PISA® 6 and PISA® 7 Anchor Helix Assemblies 1-1/2"-Core (Torque Ratings: 6,000 ft.-lb. & 7,000 ft.-lb.) 4-9

PISA® Anchor Rods, Eyenuts and Couplings 4-10

RR (Round-Rod) Screw Anchors 4-12

SS (Square-Shaft) Screw Anchors 4-14

High-Strength SS Screw Anchors for Heavy Tension Loading 4-16

No-Wrench Screw Anchors 4-19

"Bust" Expanding Anchors 4-21

Cross-Plate Anchors and Anchor Rod Extensions 4-22

Anchor Rods 4-23

Expanding Rock Anchors 4-26

Socket Type Rock Anchors 4-27

Grouted Rock Anchors 4-28

Expanding Pole Key Anchors 4-30

Pole Bearing Plates 4-31

Helical Pole Support 4-32

Corrosion-Protected Anchors 4-33

Bumper Posts 4-35

Swamp Anchors 4-36

NOTE:
Galvanized products are galvanized to
ASTM A153 latest revision

The Science of Selecting Anchors

Soil Mechanics and Holding Capacity

During the early stages of the screw anchor, the load resistance of an installed anchor could not be predicted with reasonable accuracy. Specific information on soil conditions was lacking, making anchor selection more or less a guess. With little consideration for soil variations and the effects of seasonal weather changes or drainage, soils were classified as "sand, clay, hardpan or swamp." There wasn't any definitive explanation for such soil conditions.

Chance soil classification data opened new horizons in predicting anchor holding capacity. Initially, it was necessary to obtain soil samples from the projected anchor depth in order to classify the soil and to make anchor recommendations. However, this method was inconvenient, costly and time-consuming.



Torque and Performance

Later this method was improved with the development of Chance torque indicators and sets of holding capacity values for given anchor types. This did not obviate the soil classification data but strengthened and simplified it so the utility employee could install a PISA anchor or other Chance anchor to a given torque value and predict with relative accuracy the holding capacity of the installed anchor. Actually, the correlation between installing torque and anchor performance required thousands of tests throughout the United States and in every conceivable soil condition. It is much labor, engineering research and investment that have made possible the development of this reliable and predictable anchoring philosophy.

Torque Ratings

Chance screw anchors are designed and manufactured for maximum torsional strength. During installation, some of the torque applied by the digger and measured by installation torque indicators is dissipated by friction along the wrench and not applied to the anchor itself, so it is possible to apply more torque than the anchor alone can withstand. Chance anchors are rated by maximum working torque or, for the more recent designs, by the 5 per cent exclusion limit which is a more explicitly defined criterion based on statistical analysis of on-line quality control testing. Both ratings take into consideration the variation to be expected in anchor torsional strength due to normal variations in materials and manufacturing processes. Customers should consider this variation along with the wide variation that can be seen in the frictional loss along the wrench in deciding how much torque can be applied safely during installation. The fact that Chance ratings are set near the minimum credible torsional strength also should be considered in comparing Chance ratings to those of manufacturers who rate their anchors based on average strength.



Soil Probe, A Logical Development

Chance engineers developed the "soil test probe", a mechanical tool which makes it possible to infer subsoil conditions from the surface of the earth. The soil test probe is screwed into the soil. As it displaces the soil, probe installation torque is measured in inch-pounds on a torque gauge, which is an integral part of the installing tool. Probe torque readings are then compared with the information on the Chance Soil Classification Data Chart and translated into the appropriate soil classification.

PISA®: Power-Installed Screw Anchors

More than 50 years ago, Chance introduced this system of utilizing the power of digging equipment to install screw anchors. The system consists of a screw anchor, anchor rod and a special installing wrench. Each anchor has a galvanized steel threaded anchor rod with an upset hex; single or twin helices and a galvanized guy wire nut which is screwed to the anchor rod end. PISA anchors can be installed in a matter of minutes.

Anchor Application Information

Soil Classification Data

Class	Common Soil-Type Description	Geological Soil Classification	Probe Values in/lbs (nm)	Typical Blow Count N per ASTM D1586
0	Sound hard rock, unweathered	Granite, Basalt, Massive Limestone	N.A	N.A
1	Very dense and/or cemented sands; coarse gravel and cobbles	Caliche, (Nitrate-bearing gravel/ rock)	750-1600 (85-181)	60-100+
2	Dense fine sands; very hard silts and clays (may be preloaded)	Basal till; boulder clay, caliche; weathered laminated rock	600-750 (68-85)	45-60
3	Dense sands and gravel; hard silts and clays	Glacial till; weathered shales, schist, gniess and siltstone	500-600 (56-68)	35-50
4	Medium dense sand and gravel; very stiff to hard silts and clays	Glacial till; hardpan; marls	400-500 (45-56)	24-40
5	Medium dense coarse sands and sandy gravels; stiff to very stiff silts and clays	Saprolites, residual soils	300-400 (34-45)	14-25
6	Loose to medium dense fine to coarse sands to stiff clays and silts	Dense hydraulic fill; compacted fill; residual soils	200-300 (23-34)	7-14
**7	Loose fine sands; Alluvium; loess; medium- stiff and varied clays; fill	Flood plain soils; lake clays; adobe; gumbo, fill	100-200 (11-23)	4-8
**8	Peat, organic silts; inundated silts, fly ash very loose sands, very soft to soft clays	Miscellaneous fill, swamp marsh	less than 100 (0-11)	0-5

Class 1 soils are difficult to probe consistently and the ASTM blow count may be of questionable value.

*** It is advisable to install anchors deep enough, by the use of extensions, to penetrate a Class 5 or 6, underlying the Class 7 or 8 Soils.*

NOTE: Where applicable, anchors manufactured by Hubbell Power Systems, Inc. are made from steel produced in accordance with ASTM A575 and/or ASTM A576. Where galvanized, items are galvanized in accordance with ASTM A153. Refer to Catalog Section 4 or call your Hubbell representative for conformance of particular items to the above specifications.

Power-Installed Screw Anchors (PISA®)

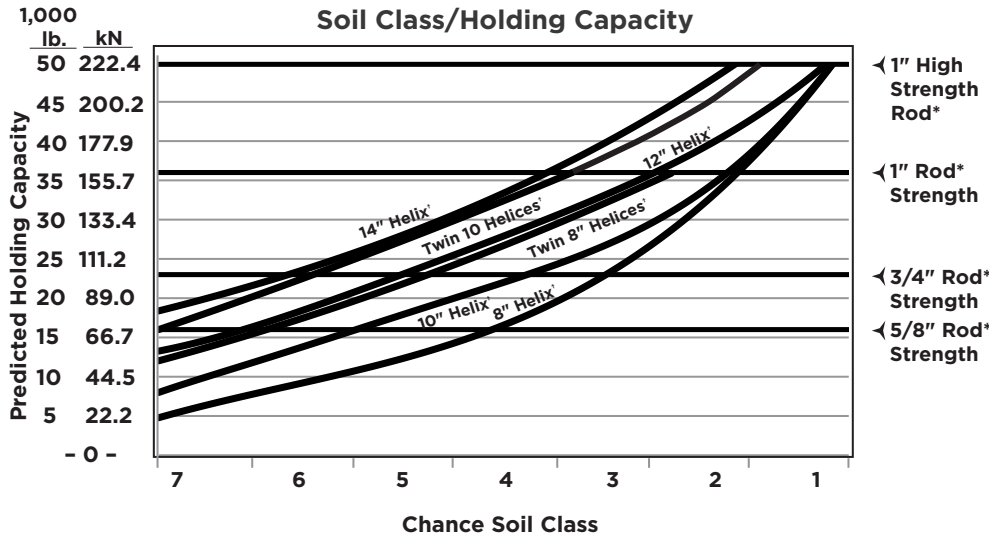

Under no circumstance should the rod and guy strand join at an angle of departure exceeding ± 5° on PISA anchors.

Helix Dia.
8" = 203.2 mm
10" = 254.0 mm
12" = 304.8 mm
14" = 355.6 mm
*Rod Dia.
5/8" (0.625") = 15.9 mm
3/4" (0.756") = 19.1 mm
1" = 25.4 mm
1" High Strength = 25.4 mm
*Rod Strengths
5/8" - 16,000 lb. / 71.2 kN
3/4" - 23,000 lb. / 102.3 kN
1" - 36,000 lb. / 160.1 kN
1" HS - 50,000 lb. / 222.4 kN

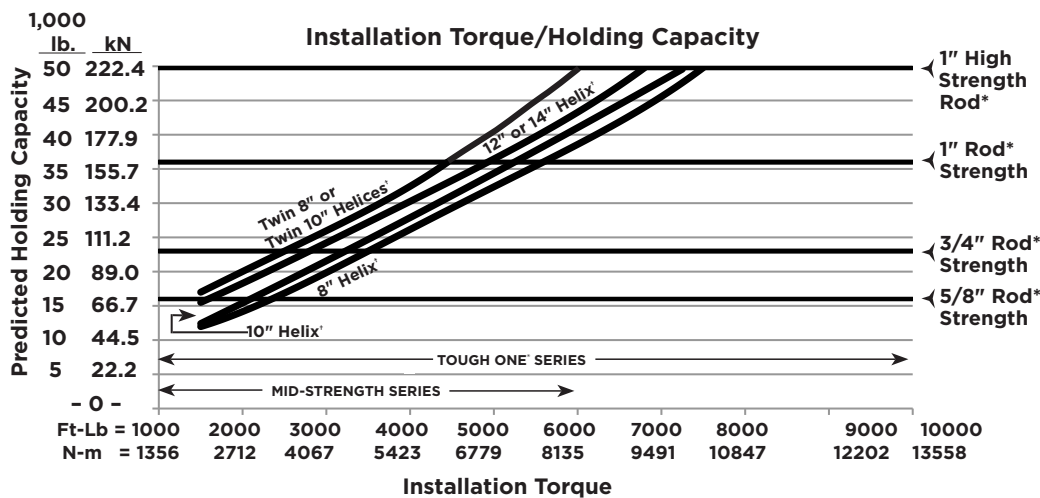

Predicted ultimate holding capacities are based on results of extensive Chance tests and interpretation and are offered as an application guide only. They do not represent a guarantee of holding capacity in a particular soil class. A user must factor in his individual, appropriate safety factor. Torque values shown are steady values in homogenous soils, not peak values that might occur in non-homogenous soil. Torque values shown were obtained by averaging readings from the last 2 feet of anchor penetration. The anchor shaft must be aligned with the guy load to prevent premature failure of the rod. Under no circumstance should the rod and guy strand join at an angle of departure exceeding ±5° on PISA anchors.

CAUTION: ALL COMPONENTS OF THE CHANCE ANCHORING SYSTEM ARE PERFORMANCE MATED. USE OF OTHER ANCHORING PRODUCTS OR EQUIPMENT WILL NOT NECESSARILY PRODUCE THE SAME RESULTS.

Tough One® Anchor Helix Assemblies

TORQUE RATINGS: 10,000 FT.-LB. Small Hub (2-1/4" Square Inside)

The C10252-- series of Tough One anchors have a smaller inside hub diameter than our C10250-- series. The smaller hub is designed to be installed with the Chance anchor wrench C1021583.

Tough One anchors give users high-strength anchor capability in all soils. You get a better anchor at an economical price.

The anchor's sloped lead point improves penetration and helps soil flow from below the hub to above the anchor.

Tough One anchors use standard PISA® rods.

Tough One anchors are painted with a black paint.



Use high-strength 10,000 ft.-lb. Tough One® anchor in soft and medium-hard soils

10,000 ft.-lb. Tough One anchor - 2-1/4" Square Inside Hub

Install with the Chance STANDARD (10,000 ft.-lb.) wrench

	8" Dia.	Approx. Wt. Each Lbs.(Kg)	10" dia.	Approx. Wt. Each Lbs.(Kg)
For 3/4" & 1" dia. Rods	C1025200	10.5 (4.7)	C1025201	13.0 (5.9)
	12" Dia.	Approx. Wt. Each Lbs.(Kg)	14" dia.	Approx. Wt. Each Lbs.(Kg)
	C1025202	20.0 (9.1)	C1025203**	26.0 (11.8)
	8" Dia.	Approx. Wt. Each Lbs.(Kg)	10" dia.	Approx. Wt. Each Lbs.(Kg)
For 5/8" dia. Rod	C1025208	10.5 (4.7)	C1025209	13.0 (5.9)
	12" Dia.	Approx. Wt. Each Lbs.(Kg)	14" dia.	Approx. Wt. Each Lbs.(Kg)
	C1025210*	20.0 (9.1)		

* RUS Listed.

** RUS Pending.

Tough One® Anchor Helix Assemblies

TORQUE RATINGS: 15,000 FT.-LB., AND 10,000 FT.- LB. Large Hub (2-1/2" Square Inside)

Tough One anchors give users high-strength anchor capability in all soils. You get a better anchor at an economical price. With Tough One anchors, there's little concern about anchor breakage when encountering hard soils.

The anchor's sloped lead point improves penetration and helps soil flow from below the hub to above the anchor.

Tough One anchors use standard PISA® rods.

It's easy to upgrade your entire program with Tough One® anchors.

If soil conditions require installations above 10,000 ft.-lbs., you will need our Tough One wrench system consisting of drive-end assembly, Kelly bar adapter and locking dog assembly. The high-strength system will also install PISA® 6 and 7 anchors. See catalog high-strength anchor installing wrench information.

Tough One anchors are painted with a black paint.

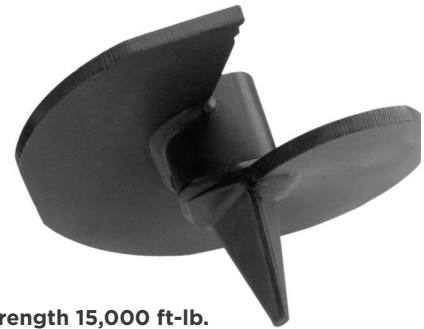

Use high-strength 15,000 ft.-lb. TOUGH ONE in very hard soils short of solid rock.



Use 10,000 ft.-lb. TOUGH ONE anchor in soft and medium-hard soils.

10,000 ft.-lb. Tough One® anchor - 2 1/2" Square Inside Hub

Install with the Chance HYBRID* or Tough One® wrench

	8" Dia.	Approx. Wt. Each Lbs.(Kg)	10" dia.	Approx. Wt. Each Lbs.(Kg)
For 3/4" & 1" dia. Rods	C1025004	11.2 (5.1)	C1025005	14.3 (6.5)
	12" Dia.	Approx. Wt. Each Lbs.(Kg)	14" dia.	Approx. Wt. Each Lbs.(Kg)
	C1025006	21.0 (9.5)	C1025007	26.5 (12.0)
	8" Dia.	Approx. Wt. Each Lbs.(Kg)	10" dia.	Approx. Wt. Each Lbs.(Kg)
For 5/8" dia. Rod	C1025008	11.2 (5.1)	C1025009	14.3 (6.5)
	12" Dia.	Approx. Wt. Each Lbs.(Kg)	14" dia.	Approx. Wt. Each Lbs.(Kg)
	C1025010	21.0 (9.5)		

15,000 ft.-lb. Tough One anchor - 2 1/2" Square Inside Hub

Install with only the Chance Tough One wrench system

	8" Dia.	Approx. Wt. Each Lbs.(Kg)	10" dia.	Approx. Wt. Each Lbs.(Kg)
For 3/4" & 1" dia. Rods	C1025000	11.7 (5.3)	C1025001	16.4 (7.4)
	12" Dia.	Approx. Wt. Each Lbs.(Kg)	14" dia.	Approx. Wt. Each Lbs.(Kg)
	C1025002	20.0 (9.1)	C1025003	27.8 (12.6)

PISA® Anchor Helix Assemblies

Chance Mid-Strength 6,000 foot-pound anchors have curvilinear leading edges to help penetrate rocky soils and to reduce damage during installation. These anchors are available in single and twin-helix designs. The same installing wrench installs Mid-Strength anchors as well as TOUGH ONE® C10252- - series anchors. Anchors are painted with a black paint.



PISA® anchor installation takes about 5 minutes with two workers.

Mid-Strength Anchor Series

1 3/8" CORE . 6000 ft.-lbs. Typical Working Torque . Squared Helix . 3.0" Helix Pitch

Single Helix	Catalog Number							
	8" Dia.	Approx. Wt. Each Lbs. (Kg)	10" dia.	Approx. Wt. Each Lbs. (Kg)	12" dia.	Approx. Wt. Each Lbs. (Kg)	14" dia.	Approx. Wt. Each Lbs. (Kg)
For 5/8" Dia. Rods	E1021629	10.0 (4.5)	E1021630	13.5 (6.1)	E1021631*	16.8 (7.6)	NA	—
For 3/4" & 1" Dia. Rods	E1021632	10.0 (4.5)	E1021633	13.5 (6.1)	E1021634	16.8 (7.6)	E1021801*	23.0 (10.4)

* RUS Pending.

Twin Helix	Catalog Number					
	4" Dia.	Approx. Wt. Each Lbs.(Kg)	8" dia.	Approx. Wt. Each Lbs.(Kg)	10" dia.	Approx. Wt. Each Lbs.(Kg)
For 3/4" & 1" Dia. Rods	E1021635	15.3 (7.0)	E1021636	22.8 (10.4)	E1021637	32.0 (14.5)

PISA® Anchor Helix Assemblies

Chance PISA-6 6000 foot-pound anchors and PISA-7 7000 foot-pound anchors have curvilinear leading edges to help penetrate rocky soils and to reduce damage during installation. These anchors are available in single and twin-helix designs.

PISA-6 and PISA-7 anchors have a 1-1/2" square solid core for added strength. Anchors are painted with a black paint.



PISA 6 anchor

1 1/2" CORE — 6000 ft.-lbs. Typical Working Torque — Squared Helix — 3.0" Helix Pitch

Single Helix	Catalog Number							
	8" Dia.	Approx. Wt. Each Lbs. (Kg)	10" dia.	Approx. Wt. Each Lbs. (Kg)	12" dia.	Approx. Wt. Each Lbs. (Kg)	14" dia.	Approx. Wt. Each Lbs. (Kg)
For 5/8" Dia. Rods	E1020816	10.5 (4.8)	E1020817	14.0 (6.4)	—	—	—	—
For 3/4" & 1" Dia. Rods	E1020819	10.5 (4.8)	E1020820	14.0 (6.4)	E1020821	17.0 (7.7)	T1022142	27.0 (12.2)

Twin Helix	Catalog Number			
	Two 8" dia.	Approx. Wt. Each Lbs.(Kg)	Two 10" dia.	Approx. Wt. Each Lbs.(Kg)
For 3/4" & 1" Dia. Rods	E1020822	25.1 (11.4)	E1020823	35.0 (15.9)

PISA 7 anchor

1 1/2" CORE — 7000 ft.-lbs. Typical Working Torque — Squared Helix — 3.0" Helix Pitch

Single Helix	Catalog Number							
	8" Dia.	Approx. Wt. Each Lbs. (Kg)	10" dia.	Approx. Wt. Each Lbs. (Kg)	12" dia.	Approx. Wt. Each Lbs. (Kg)	14" dia.	Approx. Wt. Each Lbs. (Kg)
For 3/4" & 1" Dia. Rods	E1021223	10.3 (4.6)	E1020250	13.3 (6.0)	T1022143	16.8 (7.6)	T1022319	23.3 (10.5)

Twin Helix	Catalog Number					
	Two 8" Dia.	Approx. Wt. Each Lbs.(Kg)	Two 10" dia.	Approx. Wt. Each Lbs.(Kg)	Two 4" dia.	Approx. Wt. Each Lbs.(Kg)
For 3/4" & 1" Dia. Rods	E1021219	25.1 (11.4)	E1021220	35.0 (15.9)	V1021428	19.0 (8.6)

PISA® Anchor Rods, Eyenuts & Couplings

All components shown on this page are hot-dip galvanized per ASTM A153.

Eyenut	Catalog Number					
	Thimbleye®	Approx. Wt. Each Lbs.(Kg)	Twineye®	Approx. Wt. Each Lbs.(Kg)	Tripleye®	Approx. Wt. Each Lbs.(Kg)
For 5/8" Dia. Rods	12587*	0.8 (0.4)	12589	2.0 (0.9)	12593	2.4 (1.1)
For 3/4" & 1" Dia. Rods	6512*	2.0 (0.9)	6562	1.9 (0.9)	12585	2.1 (1.0)
For 1" Dia. H.S.+	N/A	N/A	6562H	1.8 (0.8)	12585H	2.1 (1.0)

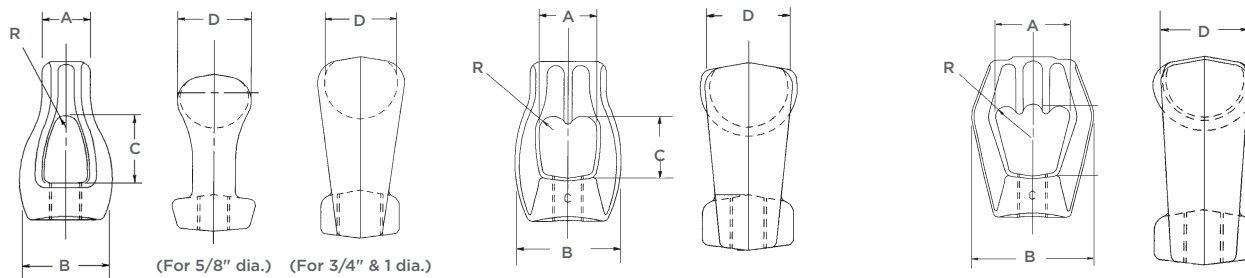
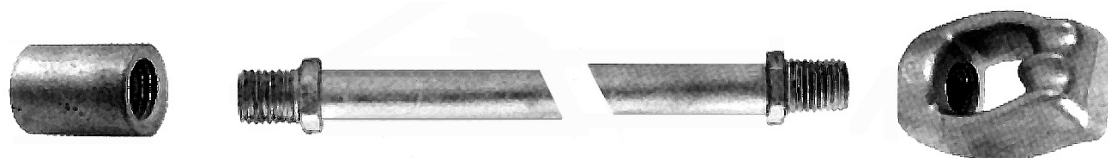

Thimbleye® Nuts	A	B	C	D	R
For 5/8" Dia. Rods	7/8"	1 7/8"	1 3/8"	1 11/64"	1/4"
For 3/4" & 1" Dia. Rods	1 1/8"	2 25/64"	1 19/32"	1 5/8"	13/32"

Twineye® Nuts	A	B	C	D	R
For 5/8", 3/4" & 1 Dia. Rods	1 13/32"	2 25/64"	1 27/64"	1 1/2"	5/16"

Tripleye® Nuts	A	B	C	D	R
For 5/8", 3/4" & 1 Dia. Rods	7/8"	1 7/8"	1 3/8"	1 11/64"	1/4"
1 Dia. Rods	1 3/4"	2 13/16"	1 5/8"	1 1/2"	1/4"

ROD	3 1/2-ft. ROD		7-ft. ROD		Ultimate Strength†
	Catalog Number	Approx. Wt. Each Lbs.(Kg)	Catalog Number	Approx. Wt. Each Lbs.(Kg)	
5/8" Dia.	12336P	3.2 (1.5)	12332P*	6.5 (2.9)	16,000 lbs.
3/4" Dia.	12634P	17.0 (7.7)	12632P*	9.7 (4.4)	23,000 lbs.
1" Dia.	12338P	9.0 (4.1)	12334P	17.0 (7.7)	36,000 lbs.
1" Dia. H.S.	C1021987	9.1 (4.1)	C1021986	16.9 (7.7)	50,000 lbs.

H.S. 50,000-lb. Eyenuts are galvanized and painted orange.

* RUS Listed

† Ultimate strength ratings apply to properly installed anchors only. Failure to install within 5° of alignment with the guy load will significantly lower strength.

PISA® Anchor Rods, Eyenuts & Couplings

COUPLING	Catalog Number	Approx. Wt. Each Lbs.(Kg)	Ultimate Strength
For 5/8" Dia. Rods	12245P	0.3 (0.2)	16,000 lbs
For 3/4" & 1" Dia. Rods	12247P	0.5 (0.3)	50,000 lbs

NOTE: Couplings are required only when it is necessary to add additional rods of 3½ ft. or 7 ft. to form an extension.

Extension Rod & Coupling Combinations	3 1/2-ft. ROD		7-ft. ROD	
	Catalog Number	Approx. Wt. Each Lbs. (Kg)	Catalog Number	Approx. Wt. Each Lbs. (Kg)
5/8" Dia.	12249A	4.6 (2.1)	—	—
3/4" Dia.	12250A	5.6 (2.5)	C1022328	10.1 (4.6)
1" Dia.	12251A	9.5 (4.3)	12255A	20.5 (9.3)

PISA Rod & Eye Nut Combinations

Catalog Number	Rod, Eye Nut	Approx. Wt. Each Lbs.(Kg)
E1020031	5/8" x 3-1/2' Rod & Thimbleye Nut	4.5 (2.0)
E1020047	5/8" x 3-1/2' Rod & Tripleye Nut	5.7 (2.6)
E1020035	5/8" x 7' Rod & Thimbleye Nut	7.3 (3.3)
E1020043	5/8" x 7' Rod & Twineye Nut	8.6 (3.9)
E1020051	5/8" x 7' Rod & Tripleye Nut	8.6 (3.9)
E1020032	3/4" x 3-1/2' Rod & Thimbleye Nut	7.0 (3.2)
E1020040	3/4" x 3-1/2' Rod & Twineye Nut	7.3 (3.3)
E1020036	3/4" x 7' Rod & Thimbleye Nut	12.3 (5.6)
E1020044	3/4" x 7' Rod & Twineye Nut	11.4 (5.2)
E1020052	3/4" x 7' Rod & Tripleye Nut	12.3 (5.6)
E1020041	1" x 3-1/2' Rod & Twineye Nut	11.0 (5.0)
E1020049	1" x 3-1/2' Rod & Tripleye Nut	11.3 (5.1)
E1020037	1" x 7' Rod & Thimbleye Nut	20.0 (9.1)
E1020045	1" x 7' Rod & Twineye Nut	20.5 (9.3)
E1020053	1" x 7' Rod & Tripleye Nut	18.9 (8.6)

Corrosion-Protected PISA Rod & Coupling

Rods are painted and galvanized, with heat-shrink and a plastic tube covering. Couplings are galvanized and covered with heat-shrink tubing.

ROD Cat No.	Fits Rod Size	Approx. Wt. Each Lbs.(Kg)
C1021996	1" x 7"	19.7 (8.9)
C1022061	1" x 3 1/2'	10.0 (4.5)
COUPLING Cat No.		
C1025240	1"	0.5 (0.2)



RR (Round-Rod) Screw Anchors

The Round-Rod "RR" multi-helix anchors are used in areas where weak soil conditions exist and moderate holding capacities are required. All helix lead sections are 7 ft. long. Extension shafts may be required for installation to proper depth.

RR screw anchors consist of three galvanized components: Lead section, extension shaft (which includes an integral coupling), and the guy adapter. Each extension and guy adapter includes a high-strength bolt and nut.

Type RR (Round-Rod) anchors torque rating is 2,300 ft-lb. Ultimate tension rating for RR mechanical strength is 70,000 lb. Failure to install within 5° of alignment with the guy load will significantly lower strength.

Lead Sections

Catalog Number	Length	Helix Combinations	Approx. Wt. Each Lbs.(Kg)	Holding Capacity - (lb.) vs. Soil Class		
				Class 7	Class 6	Class 5
012690AE	7 ft.	8" - 10"	47.5 (21.5)	19,000	23,000	27,000
012690AEJ	7 ft.	8" - 10" - 12"	60.9 (27.6)	26,000	32,000	39,000
V1090007	7 ft.	10" - 10" - 10"	48.0 (21.8)	25,000	31,000	N/A
V1090006	7 ft.	10"	52.0 (23.6)	17,000	21,000	24,000

Extensions

Catalog Number	Nominal length	Approx. Wt. Each Lbs.(Kg)
12696	3 1/2 ft.	20.0 (9.1)
12697	5 ft.	29.0 (13.2)
12698	7 ft.	34.5 (15.6)
12699	10 ft.	46.8 (21.2)

Contact your Hubbell representative for information or additional size or helix options.

Extension



Lead Section

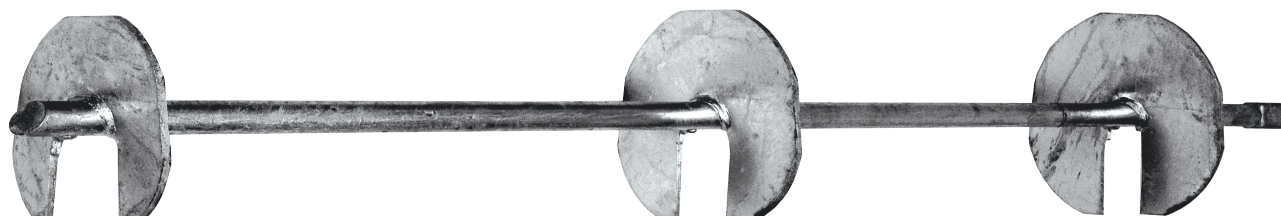

RR (Round-Rod) Screw Anchors

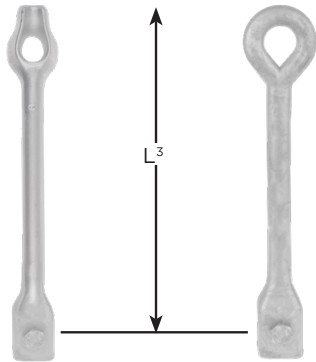

**Thimbleye® & Ovaley®
Guy Adapters
WITHOUT Pulling Eye**

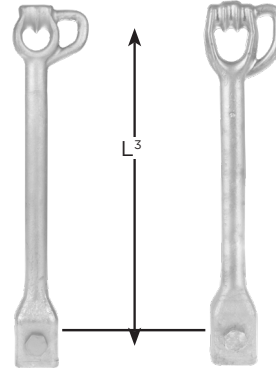

**Twineye® & Tripleye®
Guy Adapters
WITH Pulling Eye**

NOTE: Guy wire should not be attached to Pulling Eye.

Guy Adapters: 18" overall length, 17" L3 length

Catalog Number	WITHOUT Pulling Eye	WITH Pulling Eye	Strand Eye Rating*	Pulling Eye Rating	Approx. Wt. Each Lbs.(Kg)
C1020023	Thimbleye®	N/A	70,000 lb	N/A	10.8 (4.9)
C1020024	N/A	Twineye®		12,000 lb	9.8 (4.4)
C1020025	N/A	Tripleye®		N/A	10.6 (4.8)
C1100041	Ovaley	N/A		N/A	

Guy adapters are shipped in corrugated cartons.

Typical "RR" Drive String

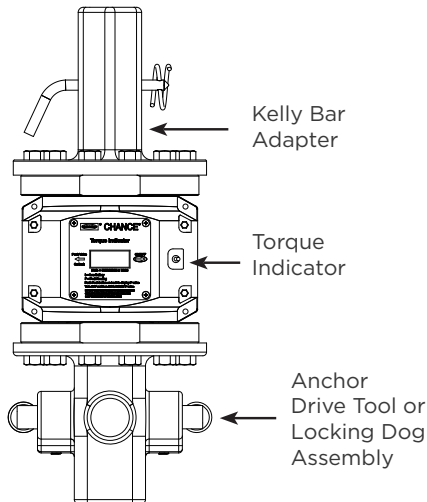

**Load Capacity¹ Based On Installation Torque²
Load Capacity Of RR Anchors In Soil (Pounds Tension)**

Helix Combinations	Installation Torque (ft-lb)		
	1,500	2,000	2,300
10"	16,000	22,000	28,000
8" - 10"	17,000	23,000	29,000
10" - 10" - 10"	19,000	25,000	31,000
8" - 10" - 12"	19,000	25,000	31,000

1. Load capacities listed above are ultimate values based on average test data and are offered as an application guide. Typical deflection at ultimate load ranges between 2 and 4 inches. The listed values should be reduced by an appropriate factor of safety. More specific data on soils and anchor performance in any site condition can be obtained by contacting Hubbell Power Systems.

2. The torque values shown are steady values in homogeneous soils, not peak values that can occur in non-homogeneous soils such as glacial till or other rocky soils. The torque values shown are obtained by averaging the readings from the last 2 feet of anchor penetration.

SS5 (Square-Shaft) Screw Anchors

Square-Shaft “SS” multi-helix screw anchors are designed for heavy-guy loading. They have 1-1/2” square steel shafts. Extension shafts must be coupled to the helix section for installation to the proper depth. For installation tool options, see catalog Section 4A.

SS screw anchors consist of three galvanized components: the lead section, the extension shaft, which includes an integral coupling, and the guy adapter. Extensions and guy adapters include a high-strength bolt and nut.

Lead Sections

Catalog Number	Length	Helix Combinations	Approx. Wt. Each Lbs.(Kg)	Holding Capacity - (lb.) vs. Soil Class					
				Class 7	Class 6	Class 5	Class 4	Class 3	Class 2
012642AE*	3 ft.	8" - 10"	38.0 (17.2)	19,000	23,000	27,000	32,000	36,000	41,000
012642EJ	3-1/2 ft.	10" - 12"	50.5 (22.9)	21,000	26,000	31,000	36,000	41,000	46,000
012642AEJ*	5-1/2 ft.	8" - 10" - 12"	67.2 (30.5)	26,000	32,000	39,000	46,000	51,000	58,000
012642EJN*	7 ft.	10" - 12" - 14"	96.0 (43.5)	29,000	37,000	45,000	53,000	61,000	69,000
012642AEJN	10-1/2 ft.	8" - 10" - 12" - 14"	117.0 (53.1)	31,000	40,000	49,000	58,000	67,000	N/A
012642EJNS*	10-1/2 ft.	10" - 12" - 14" - 14"	131.0 (59.4)	40,000	51,000	62,000	70,000	N/A	N/A

*RUS Listed. [†]Lead sections are banded to wood blocks to facilitate forklift handling.

Note: Other lengths available upon request. Holding capacity based on Helix Combination, not Lead Length.

Mechanical Properties	SS5 1.50" Square Shaft
Max. Installation Torque	5,500 ft.-lb.
Min. Ultimate Tension Strength	70,000 lb.

Extra Bolt & Nut
for Extensions & Guy Adapters Standard Package: 10 each

Catalog Number	Description
P0010041P	Extra SS5 Bolt
055449P	Extra SS5 Nut

Extensions

Catalog Number	Nominal length	Helix Diameter	Approx. Wt. Each Lbs.(Kg)
12655	3 1/2 ft.	N/A	28.0 (12.7)
12656	5 ft.	N/A	39.0 (17.7)
12657	7 ft.	N/A	56.5 (25.6)
12658	10 ft.	N/A	77.6 (35.2)
12656N	5 ft.	14"	56.0 (25.4)
12655J	3 1/2 ft.	12"	41.0 (18.6)

Extension

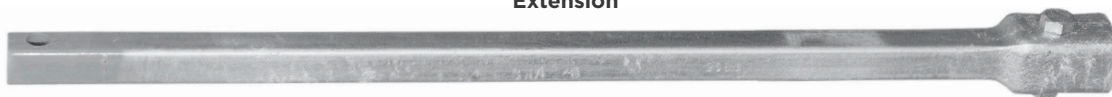

Lead Section

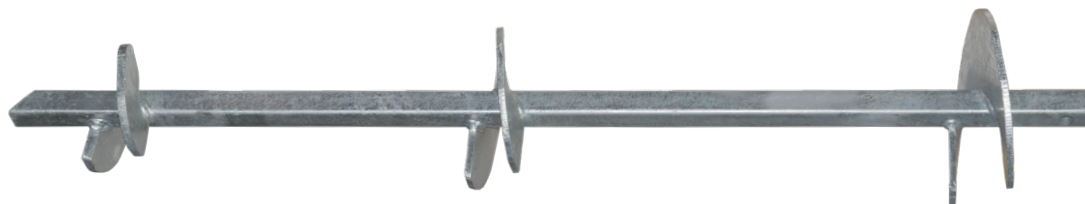

SS5 (Square-Shaft) Screw Anchors

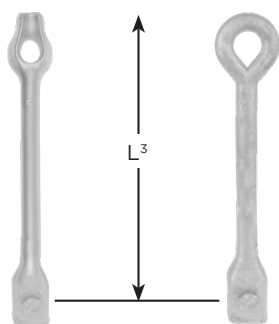

Thimbleye® & Ovaley Guy Adapters WITHOUT Pulling Eye

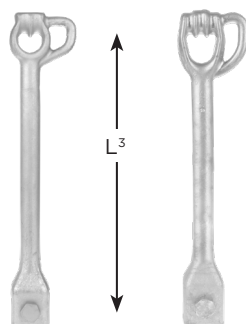

Twineye® & Tripleye® Guy Adapters WITH Pulling Eye

NOTE: Guy wire should not be attached to Pulling Eye.

Guy Adapters: 18" overall length, 17" L3 length

Catalog Number	WITHOUT Pulling Eye	WITH Pulling Eye	Strand Eye Rating*	Pulling Eye Rating	Approx. Wt. Each Lbs.(Kg)
C1020023	Thimbleye®	N/A	70,000 lb	N/A	10.8 (4.9)
C1020024	N/A	Twineye®		12,000 lb	9.8 (4.4)
C1020025	N/A	Tripleye®		N/A	10.9 (5.0)
C1100041	Ovaley	N/A		N/A	10.6 (4.8)

†† Guy adapters are shipped in corrugated cartons.

Lead Section & Guy Adapter Combinations

Catalog Number	Guy Adapter	Helix Combinations
126541AE	Thimbleye® without Pulling Eye	8" - 10"
126541EJ	Thimbleye® without Pulling Eye	10" - 12"
126541AEJ	Thimbleye® without Pulling Eye	8" - 10" - 12"
126541EJN	Thimbleye® without Pulling Eye	10" - 12" - 14"
126541EJNS	Thimbleye® without Pulling Eye	10" - 12" - 14" - 14"
126542AE	Twineye® with Pulling Eye	8" - 10"
126542EJ	Twineye® with Pulling Eye	10" - 12"
126542AEJ	Twineye® with Pulling Eye	8" - 10" - 12"

Catalog Number	Guy Adapter	Helix Combinations
126542EJN	Twineye® with Pulling Eye	10" - 12" - 14"
126542EJNS	Twineye® with Pulling Eye	10" - 12" - 14" - 14"
126543AE	Tripleye® with Pulling Eye	8" - 10"
126543EJ	Tripleye® with Pulling Eye	10" - 12"
126543AEJ	Tripleye® with Pulling Eye	8" - 10" - 12"
126543EJN	Tripleye® with Pulling Eye	10" - 12" - 14"
126543EJNS	Tripleye® with Pulling Eye	10" - 12" - 14" - 14"

Packaging note: Lead sections are banded to wood blocks to facilitate forklift handling. Guy adapters are shipped in separate corrugated cartons.

Load Capacity¹ in Soil Based on Installation Torque² (Pounds Tension)

Catalog Number	Length	Helix Combinations	Installation Torque (ft-lb)								
			1,500	2,000	2,500	3,000	3,500	4,000	4,500	5,000	5,500
012642AE*	3 ft.	8" - 10"	17,000	23,000	29,000	34,000	40,000	46,000	52,000	58,000	63,000
012642EJ	3-1/2 ft.	10" - 12"	18,000	24,000	30,000	36,000	42,000	48,000	54,000	60,000	66,000
012642AEJ*	5-1/2 ft.	8" - 10" - 12"	19,000	25,000	31,000	38,000	44,000	50,000	56,000	62,000	68,000
012642EJN*	7 ft.	10" - 12" - 14"	20,000	26,000	32,000	39,000	46,000	52,000	58,000	65,000	70,000
012642AEJN	10-1/2 ft.	8" - 10" - 12" - 14"	20,000	27,000	34,000	40,000	47,000	54,000	61,000	68,000	70,000
012642EJNS*	10-1/2 ft.	10" - 12" - 14" - 14"	21,000	28,000	35,000	42,000	49,000	56,000	63,000	70,000	70,000

Note: Other lengths available upon request. Holding capacity based on Helix Combination, not Lead Length.

1. Holding capacities are based on average test data and are offered as an application guide only. Ultimate strength ratings apply to properly installed anchors only. Failure to install within 5° of alignment with the guy load will significantly lower strength. Load capacities listed above are ultimate values based on average test data and are offered as an application guide. Typical deflection at ultimate load ranges between 2 and 4 inches. The listed values should be reduced by an appropriate factor of safety. Minimum vertical depth is five times the diameter of the largest helix. More specific data on soils and anchor performance in any site condition can be obtained by contacting Hubbell Power Systems.

2. The torque values shown are steady values in homogeneous soils, not peak values that can occur in non-homogeneous soils such as glacial till or other rocky soils. The torque values shown are obtained by averaging the readings from the last 2 feet of anchor penetration.

High-Strength SS Anchors for Heavy Tension Loading

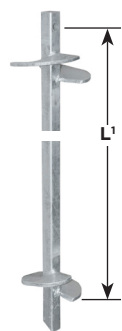

Lead Section

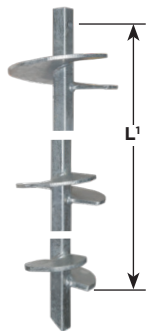

Lead Section

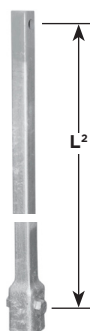

Plain Extension

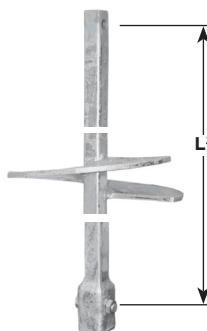

Single Helix Extension

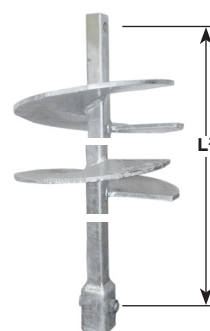

Two Helix Extension

Guy Adapters

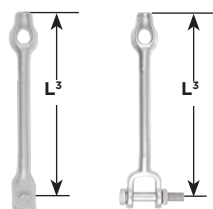

Socket THIMBLEYE
NO Pulling Eye

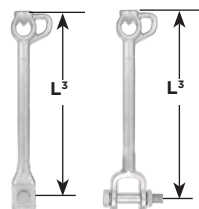

Clevis TWINEYE
with Pulling Eye

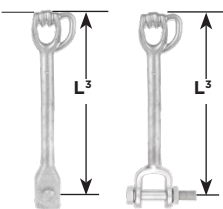

Socket TRIPLEYE
with Pulling Eye

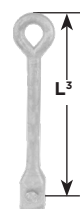

Ovaleye Adapter
NO Pulling Eye

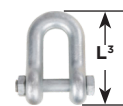

Chain Shackle

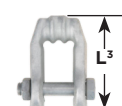

TRIPLEYE
Chain Shackle

Ratings

Mechanical Properties	SS 150 1.50" Square Shaft	SS 175 1.75" Square Shaft	SS 200 2.00" Square Shaft	SS 225 2.25" Square Shaft
Max. Installation Torque	7,000 ft.-lb.	10,500 ft.-lb.	16,000 ft.-lb.	21,000 ft.-lb.
Min. Ultimate Tension Strength	70,000 lb.	100,000 lb.	150,000 lb.	200,000 lb.

Lead Sections - Hot-Dip Galvanized

Helix Configuration	SS 150 Catalog No.	L1	SS 175 Catalog No.	L1	SS 200 Catalog No.	L1	SS 225 Catalog No.	L1
8" & 10"	C1100385	30"	C1100227	30"	C1101166	60"	—	—
10" & 12"	C1100871	42"	C1100884	58"	C1101256	72"	—	—
6", 8" & 10"	—	—	—	—	C1100569	60"	C1100543	54"
8", 10" & 12"	C1100386	57"	C1100235	60"	C1100570	60"	C1100544	75"
10", 12" & 14"	C1100838	84"	C1100923	84"	C1100924	84"	—	—
14", 14" & 14"	C1100504	120"	C1100505	124"	C1100572	122"	C1100545	114"
8", 10", 12" & 14"	T1100521	120"	C1100247	124"	C1100573	122"	C1100591	115"

High-Strength SS Anchors for Heavy Tension Loading

Extensions - Hot-dip galvanized

Helix Configuration	SS 150 Catalog No.	L1	SS 175 Catalog No.	L1	SS 200 Catalog No.	L1	SS 225 Catalog No.	L1
None	C1100388	37"	C1100136	37"	C1100563	37"	C1100645	33"
None	C1100470	59"	C1100137	59"	C1100564	58"	C1100646	60"
None	C1100389	80"	C1100138	80"	C1100565	80"	C1100647	80"
None	C1100440	122"	C1100140	124"	C1100566	123"	—	120"
Single 14" helix	C1100471	48"	C1100472	48"	C1100577	45"	C1100650	39"
Twin 14" helices	C1100454	80"	C1100450	80"	C1100581	80"	C1100652	78"
Triple 14" helices	C1100475	123"	C1101138	124"	C1101611	123"	—	120"

Extra Bolt & Nut - Hot-Dip Galvanized

for Extensions and Guy Adapters (socket & clevis types)

Description	SS5/SS150 Catalog No.	SS175 Catalog No.	SS200 Catalog No.	SS225 Catalog No.
Extra Bolt - Extension	P0010041P	P0011443P	P0011445P	P0011771P
Extra Bolt - Adapter	P0010041P	P0011444P	P0010690P	—
Extra Nut - BOTH	055449P	055591P	P0010030P	056292P

Guy Adapters - Hot-Dip Galvanizes Socket & Clevis Adapters: 18" Overall Length

Description	SS5/SS150			SS175			SS200			SS225		
	Cat No.	Rating (lbs)	L3	Cat No.	Rating (lbs)	L3	Cat No.	Rating (lbs)	L3	Cat No.	Rating (lbs)	L3
Thimbleye No Pulling Eye	C1020023	70,000	17"	*T1100311	100,000	17"	*†T1100312	100,000	17"	—	100,000	—
Twineye with Pulling Eye	C1020024	70,000	17"	*T1100964	100,000	17"	*†T1101229	100,000	17"	—	100,000	—
Tripleye with Pulling Eye	C1020025	70,000	17"	*T1100465	100,000	17"	*†T1100629	100,000	17"	—	100,000	—
Ovaleye No Pulling Eye	C1100041	70,000	17"	—	100,000	—	—	100,000	—	—	100,000	—
Chain Shackle	†C1100574	70,000	5 1/8"	T1100134	100,000	6 5/8"	C1100557	150,000	8 1/4"	C1100558	200,000	9"

†Tripleye® shackle *Clevis fitting. Others have Socket fitting.

ROCK-IT™ Square Shaft Anchor Lead Section

Thin Rocky Layers

The ROCK-IT™ lead section by Hubbell Power Systems is an innovative solution to help penetrate thin rocky layers without pre-drilling. The single carbide tip design was developed after site testing of several rock anchor configurations to provide an economical, yet proven solution to reach load-bearing depths.

Catalog Number	Anchor Family	Description
C1101290	SS5 or SS150	Square Shaft Anchor, SS150, 6/8 X 3 ft. ROCK-IT
C1101553	SS5 or SS150	Square Shaft Anchor, SS150, 6/8/10 X 5 ft. ROCK-IT
C1101670	SS5 or SS150	Square Shaft Anchor, SS150, 8 X 5 ft. ROCK-IT
C1101291	SS5 or SS150	Square Shaft Anchor, SS150, 8/10 X 3 ft. ROCK-IT
C1101292	SS5 or SS150	Square Shaft Anchor, SS150, 8/10 X 5 ft. ROCK-IT
C1101791	SS5 or SS150	Square Shaft Anchor, SS150, 8/10/12 X 5 ft. ROCK-IT
C1101405	SS175	Square Shaft Anchor, SS175, 10/12/14 X 7 ft. ROCK-IT
C1101295	SS175	Square Shaft Anchor, SS175, 6/8 X 3 ft. ROCK-IT
C1101404	SS175	Square Shaft Anchor, SS175, 6/8/10 X 5 ft. ROCK-IT
C1101671	SS175	Square Shaft Anchor, SS175, 8 X 5 ft. ROCK-IT
C1101806	SS175	Square Shaft Anchor, SS175, 8 X 7 ft. ROCK-IT
C1101296	SS175	Square Shaft Anchor, SS175, 8/10 X 3 ft. ROCK-IT
C1101294	SS175	Square Shaft Anchor, SS175, 8/10 X 5 ft. ROCK-IT
C1101293	SS175	Square Shaft Anchor, SS175, 8/10/12 X 5 ft. ROCK-IT
C1101612	SS200	Square Shaft Anchor, SS200, 10/12/14 X 7 ft. ROCK-IT
C1101568	SS200	Square Shaft Anchor, SS200, 6/8/10 X 5 ft. ROCK-IT
C1101459	SS200	Square Shaft Anchor, SS200, 6/8/10 X 7 ft. ROCK-IT
C1101724	SS200	Square Shaft Anchor, SS200, 6/8/10/12 X 10 ft. ROCK-IT
C1101559	SS200	Square Shaft Anchor, SS200, 8/10/12 X 5 ft. ROCK-IT
C1101297	SS200	Square Shaft Anchor, SS200, 8/10/12 X 7 ft. ROCK-IT
C1101569	SS225	Square Shaft Anchor, SS225, 6/8/10 X 5 ft. ROCK-IT
C1101725	SS225	Square Shaft Anchor, SS225, 6/8/10/12 X 10 ft. ROCK-IT
C1101560	SS225	Square Shaft Anchor, SS225, 8/10/12 X 5 ft. ROCK-IT
C1101298	SS225	Square Shaft Anchor, SS225, 8/10/12 X 7 ft. ROCK-IT

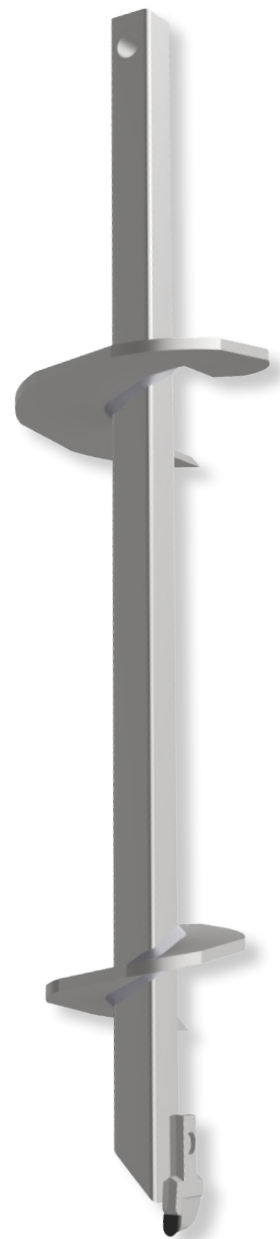

No-Wrench Screw Anchor

For Hand or Machine Installation

Chance No-Wrench Screw Anchors may be installed by hand or machine. The THIMBLEYE® eye or TRIPLEYE® eye on the rod has a large opening to admit a turning bar for screwing the anchor down. The eye will also fit into an adapter available from most hole-boring machine manufacturers so the anchor may be power-installed. The No-Wrench Screw Anchor consists of a drop-forged steel THIMBLEYE® eye or TRIPLEYE® eye rod welded to a steel helix. The entire anchor is hot-dip galvanized for long resistance to rust.

No-Wrench Screw Anchors can be installed to a greater depth to reach a firmer soil by using an extension rod. Maximum installing torque is 2300 ft.-lbs. for 1-1/4" diameter rod.

Catalog numbers 4345, 6346 and PS816 may be ordered with a forged THIMBLEYE® rod rather than the standard TRIPLEYE® rod. To order a THIMBLEYE® rod simply add "1" to the suffix of the catalog number. Example: Catalog No. 63461.

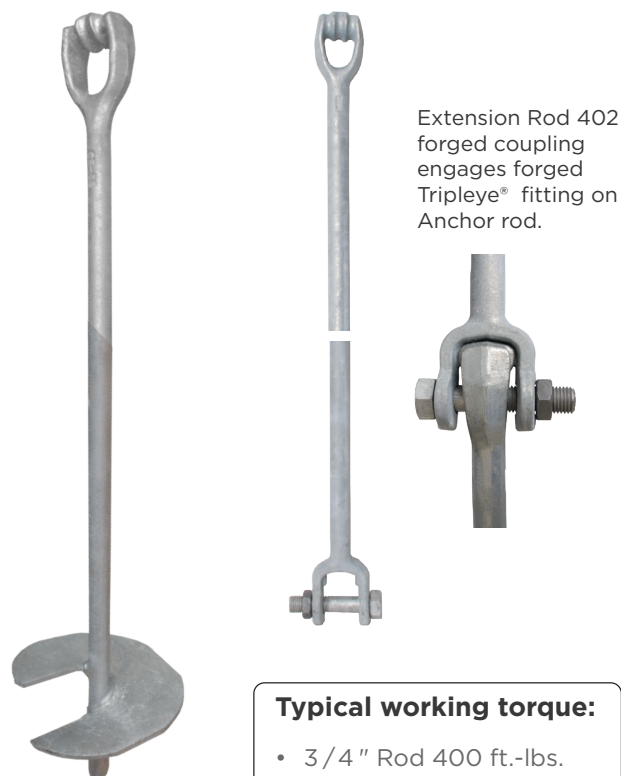

Extension Rod 402 forged coupling engages forged Tripleye® fitting on Anchor rod.

Typical working torque:

- 3/4" Rod 400 ft.-lbs.
- 1" Rod 1000 ft.-lbs.
- 1 1/4" Rod 2300 ft.-lbs.

No-Wrench Screw Anchor Holding Capacity - (lbs.) vs Soil Class

Catalog No.	Description	Anchor Size Dia.	Rod Dia. & Length	Approx. Wt. Each Lbs.(Kg)	Class 5	Class 6	Class 7
4345	Tripleye®	4"	3/4" x 54"	8.0 (3.6)	4500	3000	1500
6346*	Tripleye®	6"	3/4" x 66"	11.5 (5.2)	6500	5000	2500
PS816	Tripleye®	8"	1" x 66"	21.5 (9.7)	11000	9000	6000
10146	Tripleye®	10"	1 1/4" x 66"	31.0 (14.1)	13000	10000	7000
10148	Tripleye®	10"	1 1/4" x 96"	43.0 (19.5)	13000	10000	7000
12537	Tripleye®	14"	1 1/4" x 96"	55.8 (25.3)	16000	15000	12000
15148	Tripleye®	15"	1 1/4" x 96"	71.0 (32.2)	19000	17000	14000
43451	Thimbleye®	4"	3/4" x 54"	7.0 (3.2)	4500	3000	1500
63461	Thimbleye®	6"	3/4" x 66"	10.8 (4.9)	6500	5000	2500
8161	Thimbleye®	8"	1" x 66"	19.0 (8.6)	11000	9000	6000

* RUS Listed.

Extension Rod

402	Tripleye®	N/A	1 1/4" x 72"	28.0 (12.7)	N/A	N/A	N/A
-----	-----------	-----	--------------	-------------	-----	-----	-----

Note: If hand installed, holding capacity may be reduced by as much as 10% to 20%. Capacity ratings apply to properly installed anchors only. Failure to install within 5° of alignment with the guy load will significantly lower strength.

No-Wrench Power Installation Tool

This tool bolts directly to the installer fs output flange or appropriate Kelly bar adapter. Adjustable pivot plates accept rods from 3/4 to 1-1/4" diameter. Through-pin with retainer clip passes through the eyenut. Has (four) holes on a 5-1/4" bolt circle for attachment. Includes (four) 1/2" x 1-1/2" bolts, nuts and lockwasher.

Note: Can be attached to any Chance Torque Indicator

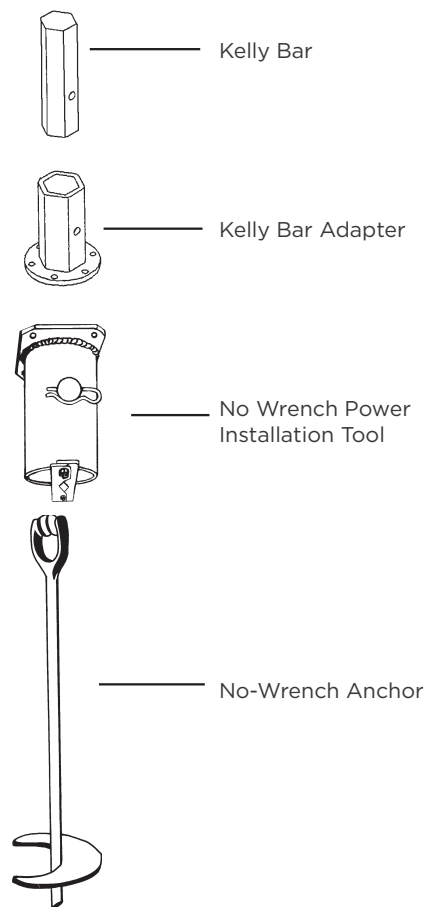
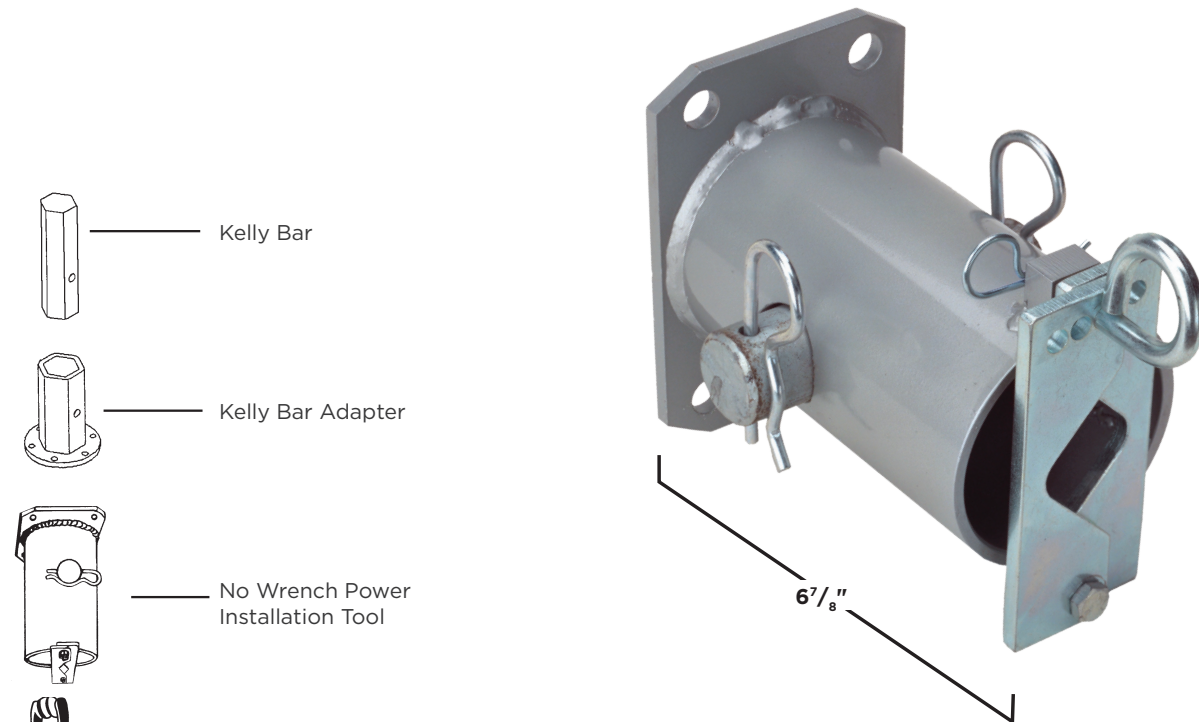

Catalog Number	Approx. Wt. Each Lbs.(Kg)
E3030255	9 (4.1)

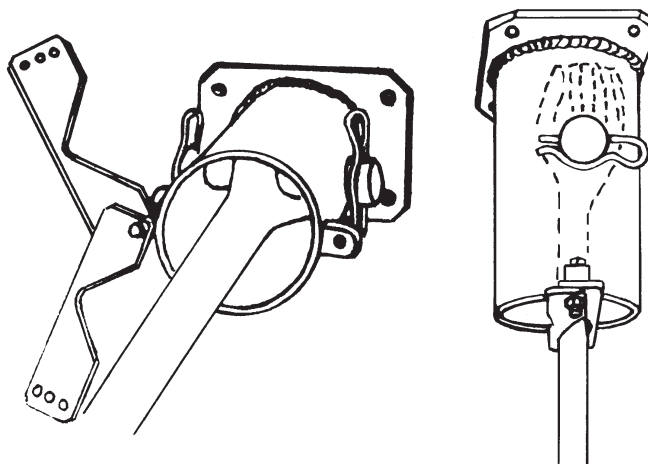

“Bust” Expanding Anchor

More Holding Capacity For Less

Four different sizes are available with holding capacity as high as 40,000 pounds.

Chance “Bust” Expanding Anchors expand to take full advantage of the available area. All eight blades wedge into undisturbed earth; there is no wasted space between blades.

This anchor should be installed in relatively dry and solid soils. The effectiveness of the anchor is dependent upon the thoroughness of backfill tamping.



Application and Ordering Information

Catalog Number	Anchor Hole Size	Area Sq. In.	Rod Size (Order Separately)	Approx. Wt. Each Lbs.(Kg)	8-Way Anchor Holding Capacity - (lbs.) vs Soil Class				
					Class 3	Class 4	Class 5	Class 6	Class 7
6870*	6"	70	5/8"	5.2 (2.3)	16000	14000	11000	8500	5000
88135*	8"	135	5/8" or 3/4"	8.7 (3.9)	26500 [†]	22000 [†]	18000 [†]	15000	10000
1082	10"	200	1"	19.8 (9.0)	31000	26500	21000	16500	12000
108234	10"	200	3/4"	19.4 (8.8)	31000 [†]	26500 [†]	21000	16500	12000
1283	12"	300	1 1/4"	28.0 (12.7)	40000	34000	26500	21500	16000
12831	12"	300	1"	29.1 (13.2)	40000 [†]	34000	26500	21500	16000

†Ultimate strength of rod may limit holding capacity. (See catalog for rod ratings and selection.)

Add suffix "G" for galvanized. Example: 88135G.

**RUS Listed.*

Note: Capacity ratings apply to properly installed anchors only.

Failure to install within 5° of alignment with the guy load will significantly lower strength.

Note: Recommend minimum depth of 5' vertical

Expanding & Tamping Bar

The improved Chance fiberglass handle Expanding and Tamping Bar simplifies the job of expanding anchors. The curved Tamper and Expander Head distributes the weight of the bar evenly around the anchor rod to reduce handle vibration. The hook of the Expanding and Tamping Bar wraps around the anchor rod to keep the Expanding Head from slipping off the anchor top plate. This tool is also effectively used for tamping in soil above the installed anchor. The base casting is attached directly to the Epoxiglas® handle.



Catalog Number	Description	Length	Approx. Wt. Each Lbs.(Kg)
C3020003	Expanding & Tamping Bar	10'	30.0 (13.6)
C3020004	Expanding & Tamping Bar	12'	27.0 (12.2)

Cross-Plate Anchor

The Cross-Plate anchor is made for installation in holes drilled by power diggers. Because the size of the hole does not affect holding capacity, the hole can be dug by the same auger that is used to dig the pole holes on transmission projects.

Cross-Plate anchors are installed in a diagonal bored hole which is undercut so the anchor is at right angles to the guy. A rod trench is either cut with a trenching tool or drilled with a small power auger. Both anchor and rod trench should be refilled and tamped.



*Order Anchor Rod Separately

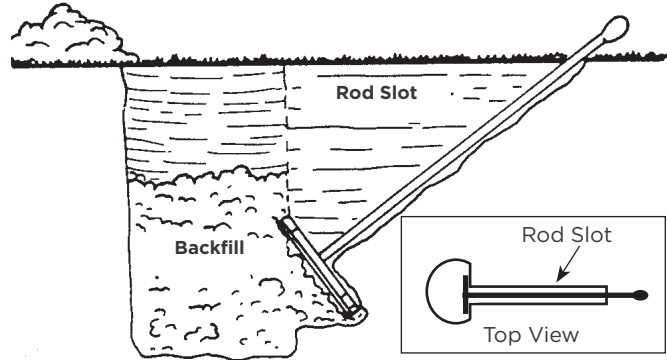

Application and Ordering Information

Catalog Number	Hole Size	Approx. Wt. Each Lbs.(Kg)	Area Sq. In.	Rod Size (order separately)	Holding Capacity‡ - (lbs.) (No Safety Factors Included) vs Soil Class				
					Class 3	Class 4	Class 5	Class 6	Class 7
X16	16"	10.0 (4.5)	150	5/8", 3/4"	26500‡	22500‡	18500‡	14500	9500
X20	20"	15.9 (7.2)	250	5/8", 3/4"	26500‡	22500‡	18500‡	14500	9500
X201	20"	15.5 (7.0)	250	1"	34000‡	29000‡	24000‡	19000‡	14000
X2434*	24"	34.8 (15.8)	400	5/8", 3/4"	34000	29000	24000	19000	14000
X24	24"	34.8 (15.8)	400	1"	45000‡	37000‡	30000‡	23500‡	18000‡
X241	24"	35.0 (15.9)	400	1 1/4"	45000‡	37000‡	30000	23500	18000

Holding capacities are ultimate values. An appropriate factor of safety should be used to determine the allowable or service load. Hubbell Power Systems, Inc. recommends a factor of safety of at least 2 for permanent structures

For Class 3, 4, 5, and 6 soils, the depth required to achieve the holding capacities listed in the table is 5 vertical feet to the center of the plate. For Class 7 soils, the depth required is 7 vertical feet to the center of the plate.

‡ Ultimate strength of rod may limit holding capacity.

* RUS Listed.

Note: Capacity ratings apply to properly installed anchors only.

Failure to install within 5° of alignment with the guy load will significantly lower strength.

Rods, Anchor, Galvanized

Available for one, two, or three guys for use with expanding and cross-plate anchors. Thimbleye®, Twineye® and Tripleye® rods distribute pulling stresses uniformly over individual strands of guy wire and keep the guy wire from spreading, kinking, or bending. The drop-forged eye of each anchor rod is stronger than the rod itself. Rod length and diameter are stamped below each rod eye.

Each rod is threaded 3-1/2" minimum length. Nuts included.

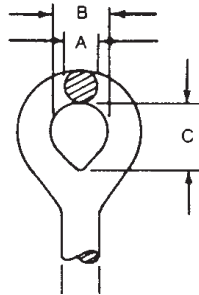

Ovaleyeye Adapter

D	A	B	C
5/8"	9/16"	1-1/2"	2"
1"	7/8"	1-1/2"	2"

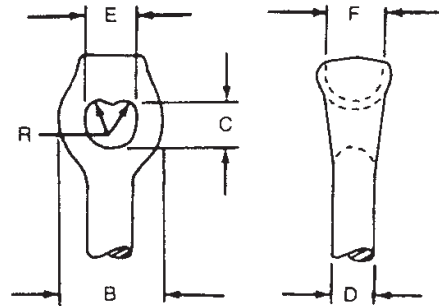

Twineye® Adapter

D	*R	B	C	E	F
5/8"	7/32"	1-3/4"	7/8"	15/16"	1-1/4"
3/4"	1/4"	2"	1"	1-1/16"	1-3/8"
1"	5/16"	2-5/8"	1-3/16"	1-5/16"	1-1/2"
1-1/4"	3/8"	2-15/16"	1-1/4"	1-9/16"	1-5/8"

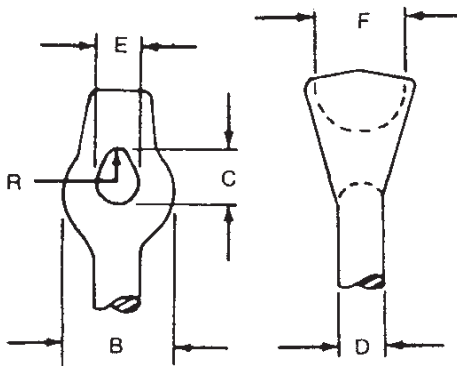

Thimbleye® Adapter

D	*R	B	C	E	F
1/2"	3/16"	1-3/4"	9/16"	1/2"	1-1/4"
5/8"	1/4"	1-1/2"	11/16"	9/16"	1-3/8"
3/4"	9/32"	1-5/8"	13/16"	11/16"	1-1/2"
1"	13/16"	2-1/16"	1-1/8"	15/16"	1-5/8"

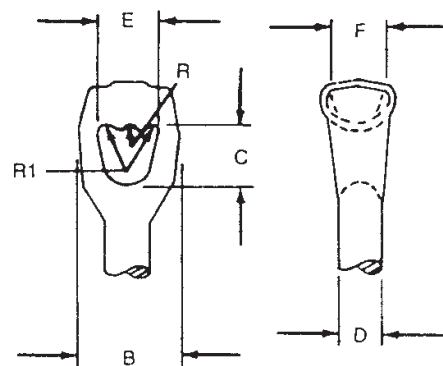

Tripleye® Adapter

D	*R	*R1	B	C	E	F
3/4"	1/4"	7/32"	2-1/2"	1-11/16"	1-1/2"	1-1/4"
1"	1/4"	1/4"	2-9/16"	1-11/16"	1-5/8"	1-1/2"
1-1/4"	9/32"	1/4"	2-7/8"	1-11/16"	1-11/16"	1-5/8"

Rods, Anchor, Galvanized

Tensile Strength**/Extra Nut

Rod Size, in.	Strength, lb.	Nut Part No.
1/2	10,000	55058P
5/8	16,000	55006P
3/4	23,000	55312P
1	36,000	55320P
1-1/4	58,000	56001P

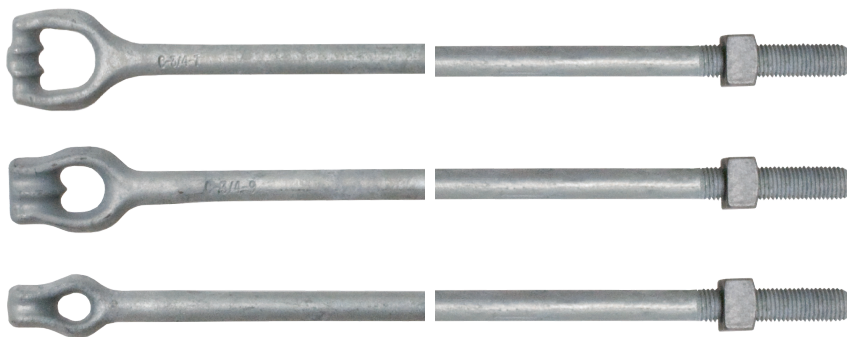

Anchor Rods

Catalog No.				Size	±Protected Rods - Catalog No.		
Thimbleye® Adapter	Twineye® Adapter	Tripleye® Adapter	Ovaleye Adapter		Thimbleye® Adapter	Twineye® Adapter	Tripleye® Adapter
5305	—	—	—	1/2" x 5'	—	—	—
5306	—	—	—	1/2" x 6'	—	—	—
5307	—	—	—	1/2" x 7'	—	—	—
5315	—	—	—	5/8" x 5'	—	—	—
†*5316	5346	—	—	5/8" x 6'	—	—	—
†*5317	†*5347	—	PS6417	5/8" x 7'	—	—	—
†*5318	†*5348	—	—	5/8" x 8'	—	—	—
*5326	*5356	—	—	3/4" x 6'	C2000088	C2000092	—
*5327	*5357	*7557	—	3/4" x 7'	C2000089	C2000093	—
†*5328	†*5358	7558	—	3/4" x 8'	C2000090	C2000094	C2000098
—	†*5359	7559	—	3/4" x 9'	—	C2000095	C2000097
—	†*5360	—	—	3/4" x 10'	C2000091	C2000096	—
*5338	*5368	7568	—	1" x 8'	C2000102	—	C2000105
—	†*5369	—	—	1" x 9'	—	C2000100	—
†*5340	†*5370	7570	6440	1" x 10'	C2000103	C2000101	C2000104
—	—	C2000028	—	1-1/4" x 8'	—	—	—
—	15129	7574	—	1-1/4" x 10'	—	—	—

* IEEE Standard

† RUS Listed.

± Galvanized rod and square nuts meet IEEE specification plus have polyethylene tube. No paint is added, so tube can slide down after anchor is expanded.

** Ultimate strength ratings apply to properly installed anchors only. Failure to install within 5° of alignment with the guy load will significantly lower strength.

Rods, Anchor, Galvanized — Extensions

These anchor rod extensions primarily are for making above-grade connections between installed anchors and guy wires. Each extension's forged eye is designed to distribute pulling stresses uniformly over individual strands of guy wire and keep the guy wire from spreading, kinking, or bending.

The drop-forged eye of each extension rod is stronger than the rod itself. Rod length and diameter are stamped below each rod eye.

Each extension rod is hot dip galvanized and includes a high-strength bolt and nut.



Welded Clevis style

Catalog No.	Description	Rod Dia. & Length	Clevis Bolt Diameter	Std. Pkg	Strength lb.
PSC1022176	Tripleye®	3/4" x 24"	3/4"	5/50	23,000
PSC1022177	Tripleye®	3/4" x 36"	3/4"	1/50	23,000
PSC1022178	Tripleye®	3/4" x 72"	3/4"	1/50	23,000
PSC1022314	Twineye®	3/4" x 24"	3/4"	5/50	23,000
PSC1022315	Twineye®	3/4" x 36"	3/4"	1/50	23,000
PSC1022316	Twineye®	3/4" x 72"	3/4"	1/50	23,000
PSC1022183	Twineye®	1" x 24"	7/8"	5/50	36,000
PSC1022305	Tripleye®	1" x 24"	7/8"	1/50	36,000
PSC1022184	Twineye®	1" x 36"	7/8"	1/50	36,000
PSC1022306	Tripleye®	1" x 36"	7/8"	1/50	36,000
PSC1022185	Twineye®	1" x 72"	7/8"	1/50	36,000
PSC1022307	Tripleye®	1" x 72"	7/8"	1/50	36,000

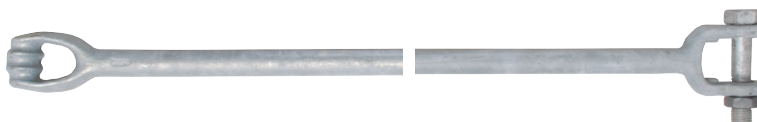

Forged Clevis style

Catalog No.	Description	Rod Dia. & Length	Clevis Bolt Diameter	Std. Pkg	Strength lb.
4022	Tripleye®	1-1/4" x 24"	1"	1/50	40,000
PS4023	Tripleye®	1-1/4" x 36"	1"	1/50	40,000
402	Tripleye®	1-1/4" x 72"	1"	1/50	40,000

Expanding Rock Anchors

Saves Time, Labor, Money

The Chance Expanding Rock Anchor is a big time, labor, and money saver; because, in most cases, there is no need to mix concrete, melt lead, or carry extra, bulky equipment to the job. Generally, the cost of installing the Expanding Rock Anchor is about 35% less than the old-fashioned grouting method.

Expands and Wedges

This anchor expands and wedges against solid walls of rock. And, once it is expanded, the harder the pull on the rod—the tighter it wedges. Wedges are made of malleable or ductile iron with a rust-resistant coating. Rod should be in line with the guy.



Catalog No.	Rod Dia.	Rod Length	Anchor Size	Anchor Fully Expanded	Hole Size	Approx. Wt. Each Lbs.(Kg)	Strength lb.
R315*	3/4"	15"	1-3/4"	2-3/8"	2"	5.0 (2.3)	
R330*	3/4"	30"	1-3/4"	2-3/8"	2"	6.8 (3.1)	5
R353*	3/4"	53"	1-3/4"	2-3/8"	2"	9.6 (4.4)	
R360	3/4"	60"	1-3/4"	2-3/8"	2"	10.5 (4.8)	5
R372	3/4"	72"	1-3/4"	2-3/8"	2"	11.8 (5.4)	
R384	3/4"	84"	1-3/4"	2-3/8"	2"	13.5 (6.1)	4
R396	3/4"	96"	1-3/4"	2-3/8"	2"	14.7 (6.7)	

Ultimate strength ratings apply to properly installed anchors only.

Failure to install within 5° of alignment with the guy load will significantly lower strength. Recommended minimum installation depth is 12" in solid rock.

Rods and Wedges are hot dip galvanized.

Catalog No.	Rod Dia.	Rod Length	Anchor Size	Anchor Fully Expanded	Hole Size	Approx. Wt. Each Lbs.(Kg)	Strength lb.
R130L	1"	30"	2-1/4"	3-1/8"	2-1/2"	11.7 (5.3)	3
R153L	1"	53"	2-1/4"	3-1/8"	2-1/2"	17.1 (7.8)	3
R172L	1"	72"	2-1/4"	3-1/8"	2-1/2"	21.0 (9.5)	2
R196L	1"	96"	2-1/4"	3-1/8"	2-1/2"	26.7 (12.1)	2

* RUS Listed.

3/4" Rod Minimum Ultimate Strength of 23,000 pounds.

1" Rod Minimum Ultimate Strength of 36,000 pounds.

Extendable Rock Anchor

The Chance Extendable Rock Anchor uses standard PISA® couplings and rods to install the rock anchor at depths greater than standard expandable rock anchors (96"). For rods, couplings and eyenuts, see page 4-10. Hot dip galvanized.

Catalog No.	Rod Dia.	Rod Length	Approx. Wt. Each Lbs.(Kg)
R84LE	1"	84"	23.5 (10.6)



Expanding Rock Anchors

Installation

Installation is quick and simple. Bore the hole with hand or power drill, making sure that the diameter of the hole is 1/4-inch larger than the diameter of the unexpanded anchor. Drop the anchor in the hole. Put a bar through the large eye of the anchor rod. Turn the rod until the anchor is firmly expanded against the sides of the hole.

Grouting should be done if protection of the rock against weathering is a concern. This wedging force holds the anchor securely in place—to stay.

1, 2 or 3 Guy Strands

The large drop-forged TRIPLEYE® rod of high-test steel holds up to three guy strands. The contour of the eye grooves keeps the guy strands from spreading, kinking, bending. . . and allows slack to be pulled up without binding, damaging, or weakening the guy.



1. Drill hole

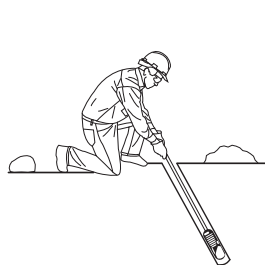

2. Push anchor into hole

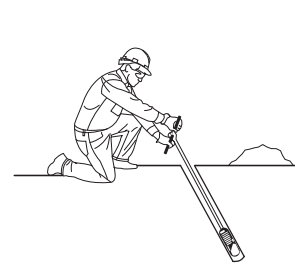

3. Turn rod to expand.

Socket Style Rock Anchor

New Style Rock Anchor for Guying Applications

Features and Benefits

- Socket makes 360 degrees of contact with rock
- Socket will tighten as load increases
- Spin socket by hand to adjust to hole size before installation
- After anchor is installed, finish tightening by applying torque through rod
- Max tension rating
 - 3/4" rod = 23,000 lbs
 - 1" rod = 36,000 lbs
- Steel rod and ductile iron socket
- Galvanized per ASTM A-153



SKU	Rod Dia.	Rod Length	Hole Size Required
R315H	3/4"	15"	2"
R330H	3/4"	30"	2"
R353H	3/4"	53"	2"
R360H	3/4"	60"	2"
R372H	3/4"	72"	2"
R384H	3/4"	84"	2"
R396H	3/4"	96"	2"
R130LH	1"	30"	2.5"
R153LH	1"	53"	2.5"
R172LH	1"	72"	2.5"
R196LH	1"	96"	2.5"

Grouted Rock Anchors

The Chance Grouted Rock Anchor is designed to be used in situations where the soil is too rocky to use screw anchors, but the rock is fractured preventing the use of wedge style rock anchors. The forged knob on the end of the anchor along with any extension couplings provides the interference fit with the grout. The holding capacity of the anchor is dependent on the bond stress between the rock and the grout. The Grouted Rock anchor is designed to be used inline with the guy. Failure to install within 5° of alignment with the guy load will significantly lower strength.

To install a Grouted Rock Anchor requires first drilling a 6"-diameter hole. Then insert the anchor, assembled with any Round Rod Extensions and Guy Adapter needed. Portland-cement grout pumped in to completely fill the hole around the anchor takes approximately five days to cure.

For Application Information, see next page.

Ordering Information

Galvanized per ASTM A-153

Grouted Rock Anchor — 1.25"-diameter rod

Catalog No.	Length A	Approx. Ship Wt. Each	Approx. Wt. Each Lbs.(Kg)
W1040004	36"	17.6 lb.	17.6 (8.0)
W1040055	84"	38.0 lb.	34.0 (15.4)

RR (Round Rod) Extension — 1.25"-diameter rod

Catalog No.	Length A	Approx. Ship Wt. Each	Approx. Wt. Each Lbs.(Kg)
12696	42"	17.6 lb.	20.0 (9.1)
12697	60"	38.0 lb.	29.0 (13.2)
12698	84"	24.0 lb.	34.5 (15.6)
12699	120"	46.8 lb.	46.8 (21.2)

Note: SS5 and SS150 extensions can be used in place of the RR extensions listed above.

Typical Assembly of Components as Installed, at right

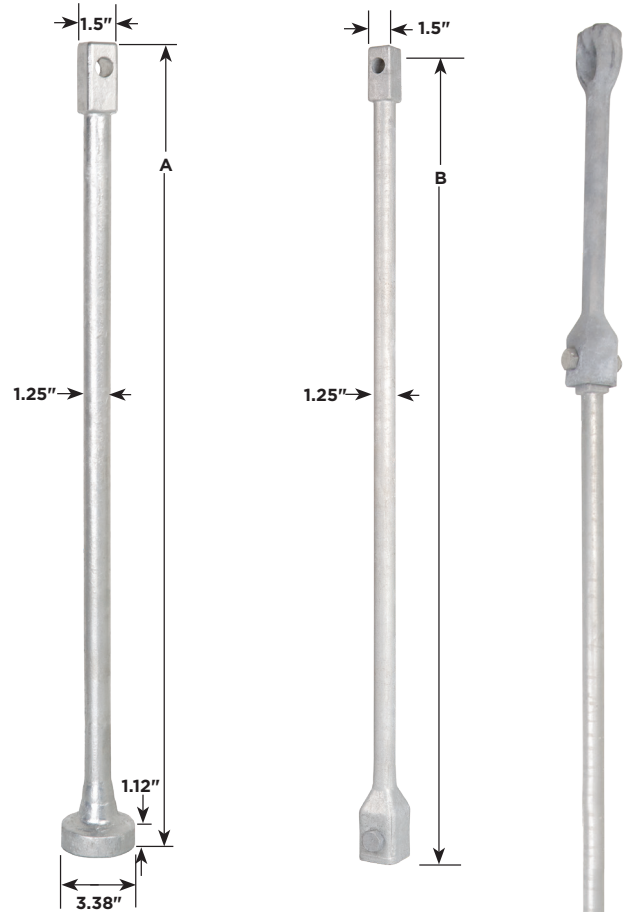

Grouted Rock Anchor

RR Extension

Guy Adapters

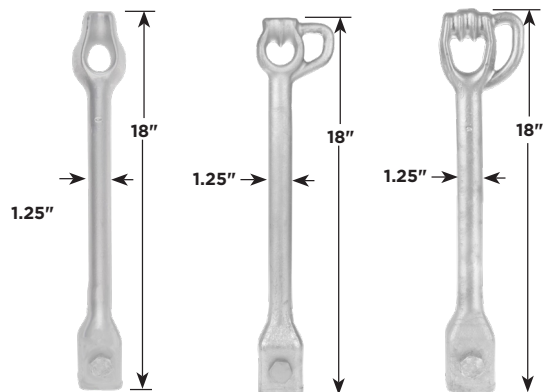

Thimbleye®
Cat No.
C1020023

Twineye®
Cat No.
C1020024

Tripleye®
Cat No.
C1020025

Application Table for Cat. No. W1040004 and W1040055

Rock	Ultimate Bond Stress between Rock & Grout psi ^{(1), (2), (3)}	Allowable Load Capacity for 6" dia x 1' long grout column lb/ft of length ⁽⁴⁾
Granite Basalt Dolomitic Limestone	200	15000
Soft Limestone Slates & Hard Shales Sandstone	100	7500
Soft Shales	30	1800
Soil ⁽⁵⁾ Class 5	8	600

1. Ultimate bond stress values from the PTI (Post Tensioning Institute) and the grout to ground bond values from the FHWA (Federal Highway Administration) were used to arrive at the indicated ultimate bond stress between rock and grout used in the above chart.
2. Identification of the rock and application of the chart values is the responsibility of those designing the rock anchor.
3. The values in the chart are intended to provide conservative results.
4. Higher bond stress values may be obtainable, but the associated investigation to determine appropriate values and the use of those values is left to those designing the rock anchor.
5. The given ultimate stresses were applied over the surface of a 6" diameter x 1' long grout column, then divided by 3 to obtain the recommended allowed load per foot of length in the indicated rock or soil.
6. Actual capacities will depend on the strength of the rock, the grout strength and the quality of the installation.
7. A rough surface in the drilled hole is preferred as well as a clean hole free of loose material, soil, dust, etc.
8. A 6" diameter hole is recommended for the use of the W1040004 and W1040055 rock anchors.
9. The minimum bond length of the rock anchor to be engaging the rock is 5 feet.
10. It is recommended that field testing be accomplished to confirm capacities.
11. Anchor grout is to be made using Type I, II, III, or V Portland Cement conforming to ASTM C-150 specifications. Pre-packaged blended mixes per ASTM C-595 are also acceptable.
12. The compressive strength of the grout shall be a minimum 3000 psi at the time of stressing.
13. The grout should be flowable to reach the bottom of the drilled hole or pumpable if it is to be placed via a grout pump.
14. The ultimate mechanical strength of the W1040004 and W1040055 rock anchors and associated extensions and terminations is 70,000 lbs when Chance/Hubbell anchor components are used.
15. Water used in the grout mix should be potable (suitable for public consumption), clean and free of substances known to be harmful to portland cement or steel.
16. It is recommended that grout be placed in the hole prior to inserting the rock anchor.
17. When using pre-packaged grout mixes follow directions and use the water cement ratio recommended by manufacturer.
18. For recommendations concerning bonded lengths and unbonded lengths, reference the PTI specifications.
19. The rock anchor is to be installed in line with the guywire. Any misalignment is to be no more than ± 5 degrees.

NOTES:

The given ultimate stresses were applied over the surface of a 6" diameter x 1' long grout column, then divided by 3 to obtain the recommended allowed load per foot of length in the indicated rock or soil.

Actual capacities will depend on the strength of the rock, grout strength and quality of the installation.

A rough surface in the drilled hole is preferred as well as a clean hole free of loose material, soil, dust, etc.

A 6" diameter hole is recommended for the use of the W1040004 and W1040055 rock anchors.

The minimum bond length of the rock anchor to be engaging the rock is 5 feet.

It is recommended that field testing be accomplished to confirm capacities. Anchor grout is to be made using Type I, II, III, or V Portland Cement conforming to ASTM C-150 specifications or pre-packaged blended mixes per ASTM C-595.

The compressive strength of the grout shall be a minimum of 3000 psi at the time of stressing.

Grout should be flowable to reach the bottom of the drilled hole or pumpable if it is to be placed via a grout pump.

The ultimate mechanical strength of the W1040004 and W1040055 rock anchors and associated extensions and terminations is 70,000 lb when CHANCE/Hubbell anchor components are used.

Water used in the grout mix should be potable (suitable for public consumption), clean and free of substances known to be harmful to Portland Cement or Steel.

It is recommended that grout be placed in the hole prior to inserting the rock anchor.

When using pre-packaged grout mixes, follow the directions and use the water cement ratio recommended by the manufacturer.

The rock anchor is to be installed in line with the guy wire. Any misalignment is to be no more than ± 5 degrees.

Expanding Pole Key Anchor

Quicker Installing, More Efficient Than Wood Key

The Chance Pole Key can be used to reinforce poles in soft soils where the load is unbalanced and the pole must resist the load. However, it is recommended that Pole Keys only be used where a proper guy wire and guy anchor cannot be used, since a guy and anchor will generally provide more resistance to lateral movement. The Pole Keys will not withstand the same load, or perform as well a proper guy and anchor.

The Chance Pole Key can be installed next to the distribution pole butt to help hold it in place against light overturning loads such as service drops, prevailing winds or small line angles.

The additional lateral load and resulting overturning moment which can be resisted by Pole Keys depends on the height of the load, the locations of the Pole Keys, the allowable lateral deflection of the pole at ground line and the quality of the installation.

The percent capacity increase shown in the table is based on analyses that used 2" lateral deflection at the ground line as the upper capacity limit.



Closed

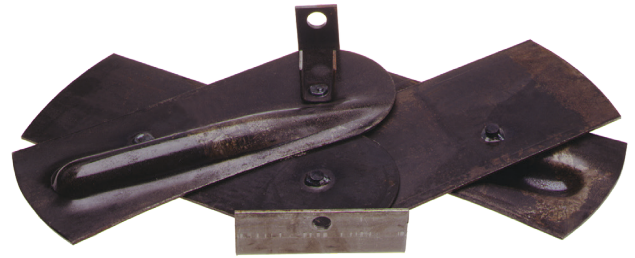

Open

Application and Ordering Information

Catalog No.	Width Expanded	Blade Width	Area Expanded	Approx. Wt. Each Lbs.(Kg)
*P4817	27 1/4"	7"	276 sq. in.	25.2 (11.4)

* RUS Listed

Pole Height and Class	% Capacity Increase by adding two Pole Keys
35' CI 5	30
40' CI 4	24
60' CI 3	13

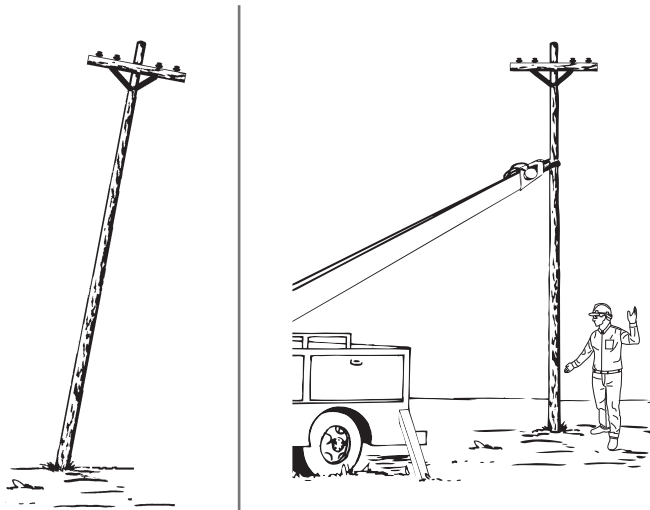

Chance Pole Key anchor is quickly installed next to a pole butt to help hold it in place against light overturning loads due to service drops, prevailing winds or small changes in line direction (See illustrations).

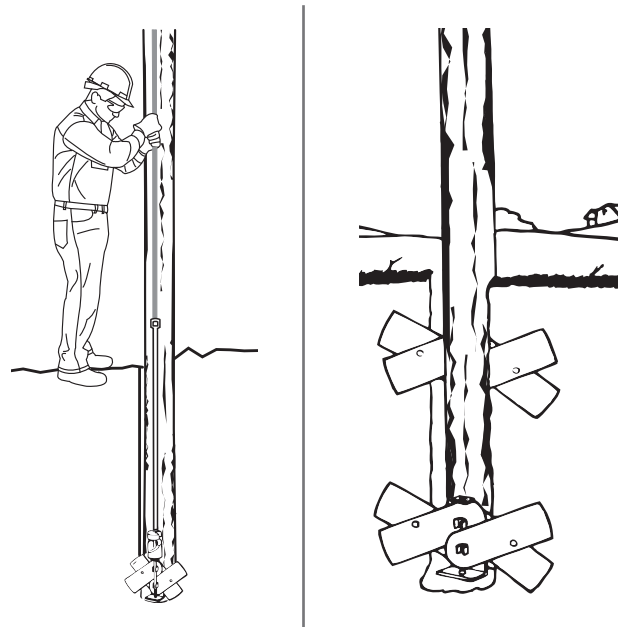

Pole Bearing Plates

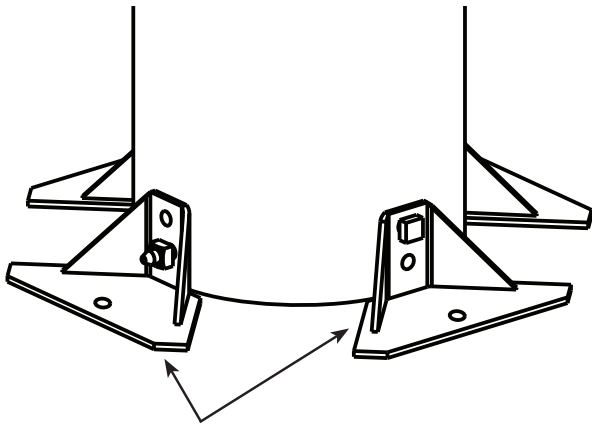

One or two pairs of pole bearing plates can be used. Note how each pair mounts with one bolt through upper or lower locating hole.



Bolts and lag screws are not included. Order separately from Catalog Section 5.

Pole Bearing Plate

Catalog No. C1100926.
Sold as a single unit, not in pairs.

One pair of these plates adds 180 square inches of bearing area to that of a pole bottom. Two pairs add 360 square inches.

Large Pole Bearing Plate

One pair of these plates adds 245 square inches of bearing area to that of a pole bottom. Two pairs add 490 square inches.

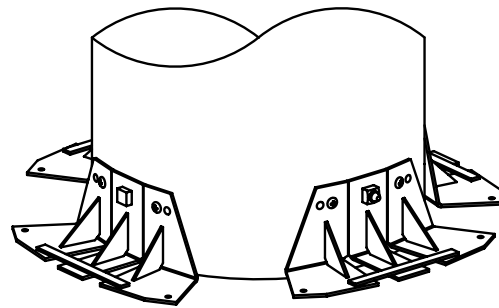
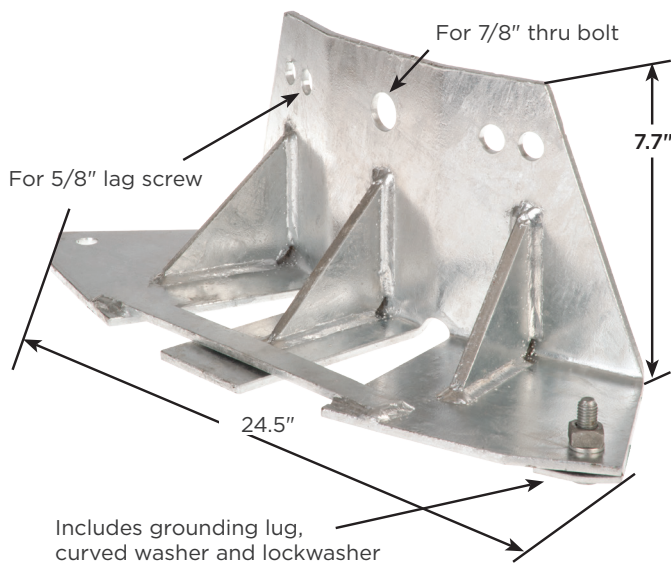

One or two pairs of pole bearing plates can be used. Plate only Catalog No. C1100954*

Kits also are available.

To order multiple units and/or include 7/8" bolts and/or 5/8" lag screws, select suffixes and add to the basic Catalog No. as shown below.

C1100954 2 16 H

H = Two 5/8" x 4 1/2" lag screws per plate

One 7/8" bolt per plate
(specify length in inches:
16, 18, 20, 22, 24, 26, 28 or 30)

Plates quantity (specify only 2 or 4)

* Rus Accepted

Helical Pole Support

Chance Helical Pole Supports are used with SS5 or SS150 Square Shaft anchors to help prevent a direct buried pole from sinking in soft soils.

Support installs in the bottom of the pole hole. Hot-dip galvanized per ASTM A153.

- Saves time and money.
- Installs in minutes with Standard PISA® or TOUGH ONE® anchor drive tools.
- Auger standard size pole hole - unlike oversize hole for pole bearing plates.
- Less spoils to remove.
- Greener method than expanding foam!

Bearing capacity can be estimated using soil class or calculated by measuring torque. The bearing capacity is shown below for SS5 and SS150 anchors (40,000 lb. maximum). For example a 100-foot Douglas fir pole weighs approximately 10,000 lb., which can be supported in a class 7 soil by an SS5 Lead Section with 8" and 10" helix plates.

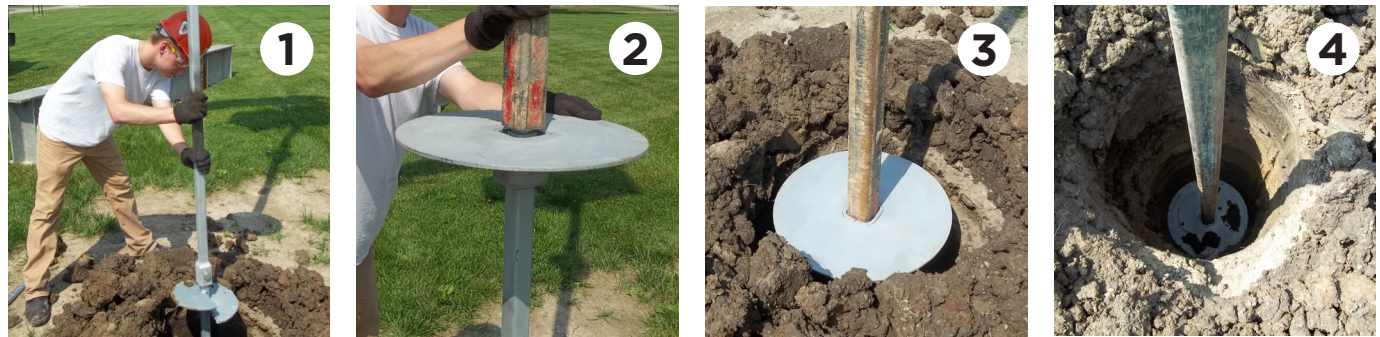
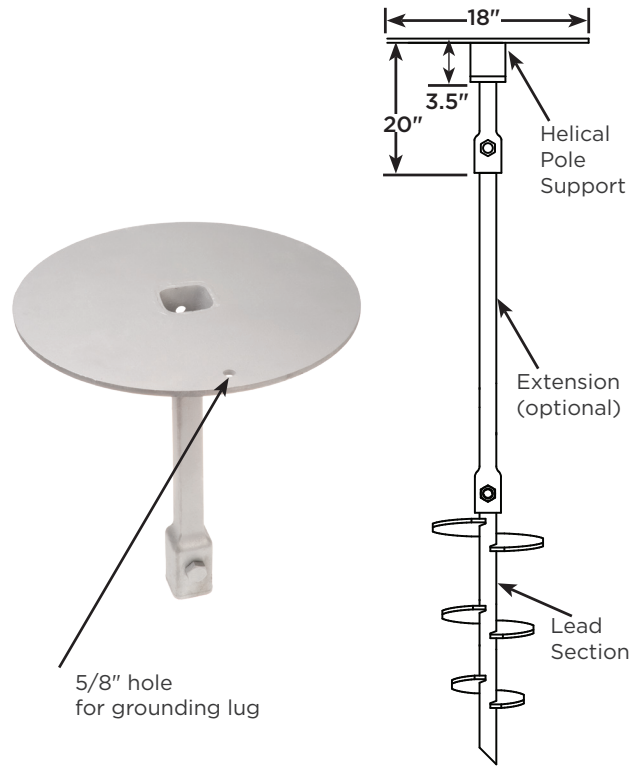

SS5/SS150 Lead Section		Bearing Capacity (lb.) vs Soil Class					
Length	Helix Combinations	Class 7	Class 6	Class 5	Class 4	Class 3	Class 2
3 ft.	8" - 10"	19000	23000	27,000	32,000	36,000	*40,000
3 1/2 ft.	10" - 12"	21000	26000	31,000	36,000	*40,000	*40,000
5 1/2 ft.	8" - 10" - 12"	26000	32000	39,000	*40,000	*40,000	*40,000
7 ft.	10" - 12" - 14"	29000	37000	*40,000	*40,000	*40,000	*40,000
10 1/2 ft.	8" - 10" - 12" - 14"	31000	40000	*40,000	*40,000	*40,000	N/A
10 1/2 ft.	10" - 12" - 14" - 14"	40000	*40,000	*40,000	*40,000	N/A	N/A

Notes: Holding capacities are based on average test data and are offered as an application guide only.

* 40,000 lb. maximum load

Corrosion-Protected Anchor

Chance design offers many advantages

The Chance corrosion protected disc anchor is designed for low resistivity, alkaline and acidic soils with electrolyte combinations. Available with anchor eye is forged directly to the rod or a threaded screw on eye. The anchor's flanged cap nut is cast. It's large and heavy for greater protection. The heat-shrink sleeve over the galvanized anchor rod helps prevent moisture from going down the rod. The insulating washer is plastic-reinforced thermoset material for better load-bearing properties.

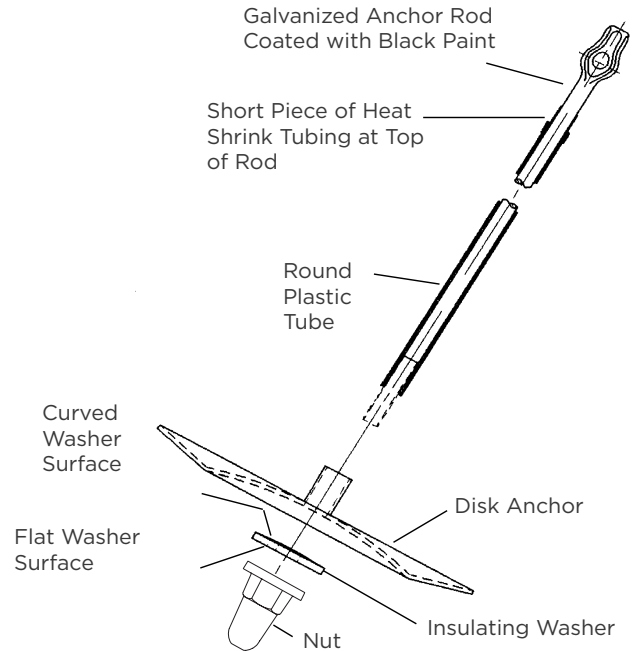

Corrosion-Protected Anchor

Catalog Number	Description	Hole Size	Fits Protected Rod Size	Holding Capacity† - (lbs.) (No Safety Factors Included) vs Soil Class				
				Class 3 500-600 in-lb	Class 4 400-500 in-lb	Class 5 300-400 in-lb	Class 6 200-300 in-lb	Class 7 100-200 in-lb
C1022008	16" Anchor .187" Thick	16"	3/4"	31000‡	26500‡	21000	16500	12000
C1022009	16" Anchor .187" Thick	16"	1"	31000‡	26500	21000	16500	12000
C1022011	20" Anchor .187" Thick	20"	1"	40000‡	34000	26000	21500	16000
C1022012	20" Anchor .250" Thick	20"	1"	40000‡	34000	26000	21500	16000
C1022054	24" Anchor .187" Thick	24"	1"	50000‡	41000‡	33500	26000	20000
C1022050	24" Anchor .250" Thick	24"	1"	50000‡	41000‡	33500	26000	20000
C1022381	30" Anchor .375" Thick	30"	1 1/4"	78100‡	64000‡	52300	40600	31200

†Ultimate strength of rod may limit holding capacity.

Note: Capacity ratings apply to properly installed anchors only.

Failure to install within 5° of alignment with the guy load will significantly lower strength.

Corrosion-Protected Anchor



Plastic Washer

Catalog No.	Fits Rod Size	Approx. Wt. Each Lbs.(Kg)
C2100033	3/4"	0.2 (0.1)
C2100034	1"	0.2 (0.1)
C2100050	1.25"	0.7 (0.3)

Cap Nut

Catalog No.	Fits Rod Size	Approx. Wt. Each Lbs.(Kg)
C2050407	3/4"	2.4 (1.1)
C2050408	1"	2.4 (1.1)
C2050590	1-1/2"	3.0 (1.4)

Protected Rod for Corrosion-Protected Anchor

These rods include fiber-reinforced washer and heavy-forged cap nut. Nut is attached to rod. Fiber Washer is assembled to anchor rod at factory. Galvanized Rod meets NEMA specification PH2 plus has paint coating, polyethylene tube and heat shrink collar.

Rod Size	Rod Tensile Strength, lb.	Thimbleye® Adapter		Twineye® Adapter		Tripleye® Adapter	
		Catalog No.	Approx. Wt. Each Lbs.(Kg)	Catalog No.	Approx. Wt. Each Lbs.(Kg)	Catalog No.	Approx. Wt. Each Lbs.(Kg)
3/4" x 6'	23,000	C2000047AW	12.2 (5.5)	C2000053AW	12.0 (5.4)	—	—
3/4" x 7'	23,000	C2000048AW	14.6 (6.6)	C2000054AW	20.2 (9.2)	—	—
3/4" x 8'	23,000	C2000049AW	24 (10.9)	C2000055AW	21.6 (9.8)	C2000061AW	22.0 (10.0)
3/4" x 9'	23,000	—	—	C2000056AW	23.2 (10.5)	C2000062AW	24.0 (10.9)
3/4" x 10'	23,000	—	—	C2000057AW	27.3 (12.4)	—	—
1" x 7'	36,000	—	—	C2000114AW	23 (10.4)	—	—
1" x 8'	36,000	C2000051AW	33.0 (15.0)	C2000108AW	31.5 (14.3)	C2000063AW	26.7 (12.1)
1" x 9'	36,000	—	—	C2000058AW	—	—	—
1" x 10'	36,000	C2000052AW	38.0 (17.2)	C2000059AW	29.8 (13.5)	C2000064AW	32.2 (14.6)
1-1/4"x10'	58,000	—	—	C2000141	50.2 (22.8)	—	—
1-1/4"x15'	58,000	—	—	—	—	C2000140	75.0 (34.0)

For additional sizes of rods, contact Hubbell Power Systems, Inc.

For Instant Equipment Protection

Protect transformers, switchgear and guys. Any equipment needing bumper protection is an ideal candidate. Cheaper than concrete. Installation in minutes regardless of weather conditions. Available power diggers can install through black-top surfaces. Hot-dip galvanized corrosion-resistant finish.

Power-Installed Design

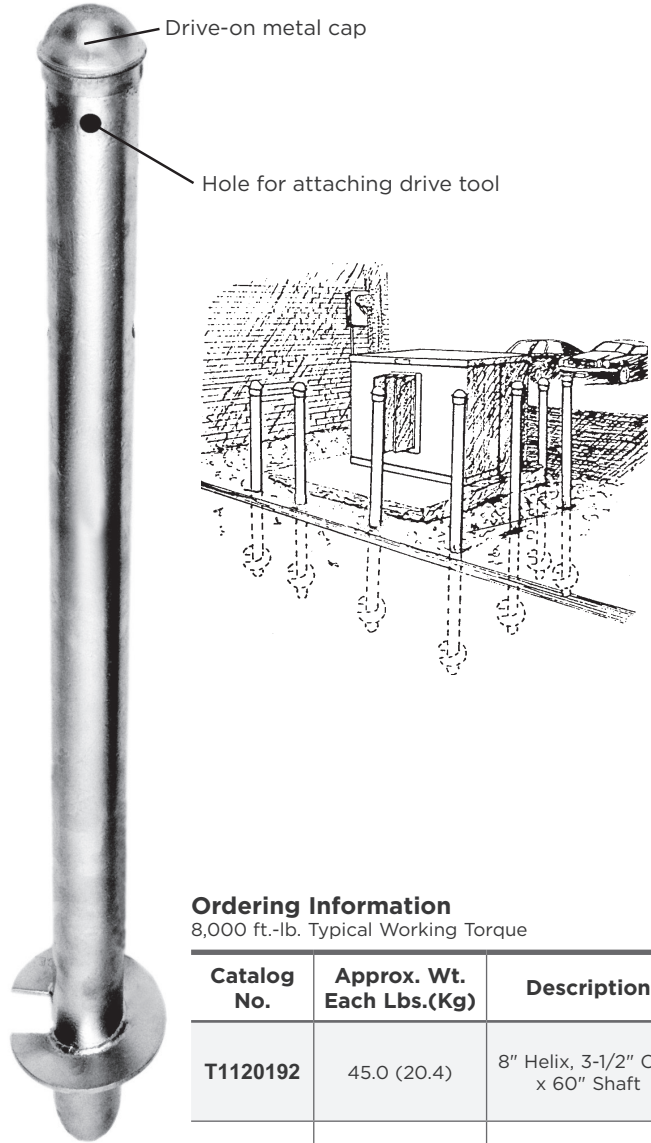

Ordering Information
 8,000 ft.-lb. Typical Working Torque

Catalog No.	Approx. Wt. Each Lbs.(Kg)	Description
T1120192	45.0 (20.4)	8" Helix, 3-1/2" O.D. x 60" Shaft
T1120224	52.7 (23.9)	8" Helix, 3-1/2" O.D. x 75" Shaft
C1120275	61 (27.7)	8" Helix, 3-1/2" O.D. x 84" Shaft

Installing Tools

Additional tools may not be required for Bumper Post if Kelly bar can be inserted into the 3.06" inside dia. of the post and pinned by a bent-arm pin.

Tools are available which bolt directly to Chance Kelly bar adapters or which can be used with Chance locking dog assembly.

Order C3030737 for Kelly bar attachment or C3030739 for use with locking dog assembly. Bumper Post is inserted into drive tool and held by the provided bent-arm pin.



C3030739



C3030737

Swamp Screw Anchors

Chance Swamp Screw anchors are designed to be installed in swamps, bogs, and marshes. This anchor includes the 1.5" square bar helix section bolted to the Thimbleye® Guy Adapter. Install the Swamp Screw Anchor by removing the Guy Adapter and attaching Chance Square Shaft Drive Tool Catalog No 639001 or Catalog No C3030020 found in catalog section 4A. Torque rating of the helix section is 5,500 ft-lbs. Anchor extensions Catalog No 12656 (5' long) or Catalog No 12657 (7' long) may be added to the helix section for installation to the proper depth. Additional extensions may be found in the SS5 product family located in catalog section 4. All components are galvanized to ASTM A153.

Application and Ordering Information

Catalog Number	Description	Helix Diameter	Length	Core Diameter	Holding Capacity vs Soil Class 1		
					Class 5	Class 6	Class 7
C1101169*	Thimbleye	10"	8'	Square 1.5"	13000	10000	7000
C1101170*	Thimbleye	12"	8'	Square 1.5"	16000	15000	12000
C1101171*	Thimbleye	15"	8'	Square 1.5"	19000	17000	14000

* RUS Accepted

1 Holding capacities are based on average test data and are offered as an application guide only. Ultimate strength ratings apply to properly installed anchors only. Failure to install within 5° of alignment with the guy load will significantly lower strength. Load capacities listed above are ultimate values based on average test data and are offered as an application guide. Typical deflection at ultimate load ranges between 2 and 4 inches. The listed values should be reduced by an appropriate factor of safety. Minimum vertical depth is five times the diameter of the largest helix. More specific data on soils and anchor performance in any site condition can be obtained by contacting Hubbell Power Systems.



CHANCE[®]

210 N. Allen Centralia, MO 65240
<https://www.hubbell.com/hubbellpowersystems/en> | hpscsc@hubbell.com | 573-682-5521



A proud member of the Hubbell family.

©2024 Hubbell Power Systems. All rights reserved.
Hubbell and the Hubbell logo are registered trademarks or trademarks of Hubbell Incorporated. All other trademarks are the property of their respective owners.

CENT-CP-CAT-EN-01729 | 05/2024