



HUBBELL

INDUSTRIAL
COMMERCIAL
RESIDENTIAL



Wiring Device-Kellems

Hubbell Continues the Tradition by



- Hubbell inSIGHT Phase Indicating Disconnect Switches
- Non-Metallic Labelless Circuit-Lock® Switched Disconnect Enclosures
- Disconnects with Jog Switch

- Advantage™ Series Switch-Rated IEC Pin and Sleeve Floor Boxes
- Watertight Pin and Sleeve Devices
- Corrosion Resistant Devices
- Low Profile Devices

- Twist-Lock® Edge Series with strong spring continues to apply pressure as strands relax
- No exposed metal on receptacles, allowing more devices to be installed closer together
- No torque screwdrivers required for wiring



For more than a century, Hubbell Wiring Device-Kellems has offered distributors, end-user customers and specifiers the electrical and electronic wiring devices, wire management systems and specialized wiring products and solutions needed for industrial, institutional, commercial and residential markets.

Focusing on Safety and Efficiency

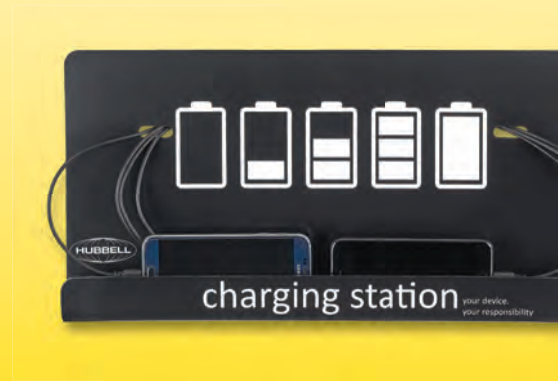

- SystemOne 4 inch Adjustable Recessed Floor Boxes
- Hubbell SystemOne Floor Boxes and Fire-Rated Poke-Throughs

- Countertop Pop-Up Receptacles
- Table Top Boxes
- Pre-Wired USB Pop-Up Boxes
- Pre-Wired Furniture/Work Boxes

- Powered Seating Boxes
- Cabled Charging Stations
- Power Charging Pedestals
- USB Charger Receptacles
- USB-C Power Delivery Charger Receptacles
- PlugTrak® Raceway with USB

Ensuring the safety of people and equipment while still effectively delivering power and technology is priority number one, which is why Hubbell products provide essential protection against injury and the dangers of electricity. Hubbell products are innovatively designed to maximize energy efficiency, reduce costs and ultimately lead to a lower total cost of ownership.



Table of Contents – Sections Overview

A Straight Blade Devices



- HBL® Extra Heavy Duty Max Devices
- SNAPConnect® Extra Heavy Duty Devices
- Commercial Specification Grade Devices
- USB Charger Receptacles and Outlets
- Hubbell-PRO Extra Heavy Duty Devices
- Insulgrip® Plugs and Connectors

B Twist-Lock® and Hubbellock® Devices



- Insul-Lock™ Devices
- Midget Twist-Lock® Devices
- Twist-Lock® Devices
- Switched Safety Enclosures
- 50A Twist-Lock® Devices
- Hubbellock® Devices

C Watertight Devices



- Watertight Safety-Shroud® Twist-Lock® Devices
- Straight Blade Devices
- Twist-Lock® Devices
- FD Boxes and Angled Adapters
- GFCI Protected FD Box
- Heavy Duty Portable Outlet Boxes and Plates

D Switches



- HBL® Extra Heavy Duty Industrial Grade Series
- SNAPConnect® Heavy Duty Series
- Hubbell-PRO Heavy Duty Industrial Series
- Specification Grade Commercial Series
- Low Voltage Commercial Series

E Energy Efficiency Solutions



- Wall Switch Sensors
- Ceiling, Wall and End Mount Sensors
- OPTIMYZER® High Bay and Low Bay Sensors
- MAXX™ Harsh Environment Sensors
- Automatic Receptacle Control Solutions
- Wireless Sensors and Controls

F Switched Disconnects and Enclosures



- inSIGHT™ Phase Indicating Disconnect Switches
- Non-Metallic and Stainless Steel Enclosures
- MotorQuick® Disconnect Switches
- Circuit-Lock® Fused Disconnects
- Hazardous Locations Devices
- AC Manual Toggle Controllers/Disconnects

G Pin and Sleeve Devices/Mechanical Interlocks



- Advantage™ Series Switch-Rated Devices
- IEC Pin and Sleeve Watertight Devices
- Circuit-Lock® Mechanical Interlocks
- Low Profile Pin and Sleeve Devices
- UL1686 C1 Insulgrip® Pin and Sleeve Devices
- Hazardous Locations Devices

H Single Pole Devices and Temporary Power



- Series 15 - 150A Single Pole Devices
- Series 16 & 18 - 300 & 400A Single Pole Devices
- Spider® II Temporary Power Boxes
- Temporary Lighting
- Stage Pin Devices
- Convention Center Pin and Sleeve Devices

I Industrial Connectivity and Control Products



- LINKOSITY® Power Components
- MotorQuick® Disconnect Switches
- CableTrak® Hose and Cable Carrier System
- DIN Rail Utility Boxes
- PANEL-SAFE® Power and Data Access Ports
- HI-Impact Industrial Ethernet Products

J Cable, Cord and Hose Reels



- inREACH™ Industrial Cord Reels
- inREACH™ Industrial Cord Reels Connector Ends
- inREACH™ Industrial Weatherproof Cord Reels
- Heavy Duty Industrial Weatherproof Reels
- Commercial Cord Reels
- Air/Water Hose and Static Discharge Reels

K Ground Fault Products



- Extra Heavy Duty Industrial Series
- Heavy Duty Commercial LED Series
- SNAPConnect® GFCI Series
- Arc Fault AFCI Receptacles
- GFCI Portable Products
- Hard Wired 30 Amp GFCI Series

L Hospital Products



- HBL® Extra Heavy Duty Max Devices
- USB Charger Receptacles
- Plugs and Connectors
- Extra Heavy Duty Industrial GFCI Receptacles
- Surge Protection Devices
- Hubbellock® Devices

M SpikeShield® Power Quality Products



- Service/Branch Panel Protection
- Surge Protection Plug Strips
- Surge Protection Receptacles
- SNAPConnect® TR & Power Ind. LED Receptacles
- Isolated Ground Devices

N Wallplates and Covers



- Snap-On Wallplates
- Non-Metallic and Metal Wallplates
- Pre-Marked Wallplates
- Security Wallplates
- Weatherproof Covers
- Heavy Duty Weatherproof Covers

O Floor Boxes and Surface Enclosures



- SystemOne Recessed Floor Boxes
- SystemOne Flush Floor Boxes
- Flush Floor Boxes and Covers
- Convention Center Utility Boxes
- CONNEXION 2.0 Zone Distribution System

P Fire-Rated Poke-Through (FRPT) Devices



- Hubbell SystemOne Recessed Systems
- Hubbell SystemOne Flush Systems
- 2X2 Flush FRPT Units
- Flush Duplex and Furniture Feed FRPT Units
- Painted or Brushed Aluminum Pedestal FRPT

Q Charging Solutions



- Powered Seating Boxes
- Cabled Charging Stations
- Power Charging Pedestals
- USB Charging Receptacles
- 2X2 USB Work Surface Pop-Up Boxes
- PlugTrak® Raceway with USB Charger Outlets

R Aluminum Service Poles



- Features and Benefits
- Aluminum Series Offering
- Custom Pole Configurations
- Division 16 Specifications

S Metal and Non-Metallic Raceway



- Metal Raceway and PlugTrak®
- Aluminum Raceway and PlugTrak®
- Non-Metallic Raceway and PlugTrak®
- Pre-Wired Raceway
- FloorTrak™ PRO System

T Trench, Wall and Underfloor Duct Products



- Trench Duct Series
- Wall Duct Series
- Underfloor Duct Series
- Underfloor Duct Raceway Activation Kits

U Wire Basket Tray



- Round Cross-Wire Basket Tray
- Flat Style Cross-Wire Basket Tray
- Under Floor Round Cross-Wire Basket Tray
- Preformed Fittings Accessories
- Supports and Brackets

V Hose and Cable Protection Systems



- TrukTrak® Systems
- TredTrak® Systems
- AccessTrak® Systems
- ProTrak™ Systems
- FloorTrak® Systems

W Wire Management Products



- Pulling Grips
- Support Grips
- Fiber Optic Cable Grips
- Strain Relief for Flexible Cords
- Cord Connectors
- Non-Metallic Liquidtight Conduit & Tubing

X Power and AV Enclosures



- Furniture/Work Surface & Table Top Boxes
- Prefab
- Wall boxes
- New Ceiling boxes to come

Y Network Wiring and netSELECT® Products



- Modular Jacks and Connectors
- Hubbell iSTATION Products
- In-Wall AV Delivery
- HDMI Products
- Network Enclosures and Modules
- Molded-In Voice/Data/Video

Z tradeSELECT® Products



- Decorator Products
- iDevices Products
- USB Charger Receptacles
- Switches and Receptacles
- Countertop Receptacles
- Power Delivery

AA Marine Products



- ELCI Interface Solutions
- 30A and 50A Cable Sets
- 100A and 200A Cable Sets
- Internationally Rated Devices
- Adapters
- Telephone and Cable TV Devices

BB Other Wiring Products



- Circuit Testers
- Adapters and Fluorescent Starters
- Lockout Devices
- Lampholders and Accessories
- Taps, Adapters, Plugs and Connectors

General Technical Data



- Industry Standards
- Certification Agencies and Markings
- Codes and Standards Organizations
- NEMA and IEC Classifications
- Circuit Wiring Diagrams

Hubbell Configuration Charts (page IV-V)

Rating	18 Amps	25 Amps	35 Amps
Conduit Entry	Conduit Entry	Conduit Entry	Conduit Entry
1/2" NPT	1/2" NPT	1/2" NPT	1/2" NPT
18VAC	18VAC	18VAC	18VAC
277V AC	277V AC	277V AC	277V AC

- NEMA Straight Blade Devices
- NEMA Twist-Lock® Devices

Catalog Number Index

Category	Page	Category	Page
00000000.PACK	W-75, W-47	00010000	W-23
00010000.PACK	W-75, W-47	00020000	W-23
00020000.PACK	W-75, W-47	00030000	W-23
00030000.PACK	W-75, W-47	00040000	W-23
00040000.PACK	W-75, W-47	00050000	W-23
00050000.PACK	W-75, W-47	00060000	W-23
0110-100	W-15	02010000	W-23
0110-103	W-15	02020000	W-23
0110-106	W-15	02030000	W-23
0110-109	W-15	02040000	W-23
0110-112	W-15	02050000	W-23
0110-115	W-15	02060000	W-23
0110-118	W-15	02070000	W-23
0110-121	W-15	02080000	W-23
0110-124	W-15	02090000	W-23
0110-127	W-15	02100000	W-23
0110-130	W-15	02110000	W-23
0110-133	W-15	02120000	W-23
0110-136	W-15	02130000	W-23
0110-139	W-15	02140000	W-23
0110-142	W-15	02150000	W-23
0110-145	W-15	02160000	W-23
0110-148	W-15	02170000	W-23
0110-151	W-15	02180000	W-23
0110-154	W-15	02190000	W-23
0110-157	W-15	02200000	W-23

- Numeric Part Numbers
- Section Page(s) Indicated

Hubbell Wiring Device-Kellems

General Information

Industrial and Commercial Wiring Devices and Systems

Kellems Wire Management Products

Residential Products

Marine Products



National Electrical Manufacturers Association

NEMA promotes the competitiveness of its member companies by providing a forum for the development of technical standards that are in the best interests of the industry and the users of its products.



National Association of Electrical Distributors

Since 1908, NAED has served as the trade association for the electrical distribution industry.

To be an NAED associate member, your company must be a manufacturer or value-added reseller.



Restriction of Hazardous Substances

The RoHS Directive stands for "the restriction of the use of certain hazardous substances in electrical and electronic equipment".



U.S. Green Building Council Member

Hubbell is a US Green Building Council (USGBC) member dedicated to advancing buildings that are environmentally responsible in the way they are designed, built and operated.



International Organization for Standardization

ISO (International Organization for Standardization) is the world's largest developer and publisher of International Standards.

Precautions have been taken to assure accuracy of the information in this catalog. Typographical or pictorial errors which are brought to our attention will be corrected in subsequent issues.

Product dimensions in this catalog are nominal and are provided for the convenience of our customers. Hubbell reserves the right to make product changes from time to time, without prior notification, which may change the dimensions shown. We, therefore, recommend they be checked before using for customer projects or product development and specification.

The designs and dimensions of the products listed in this catalog, were correct at the date of publication and are subject to change without notice.

All configuration diagrams shown in the various sections of the catalog are female devices (receptacles, connector bodies, etc.) unless otherwise indicated.

No material will be accepted for return unless permission is granted in writing by this Company. All orders received for special items and engraved plates are accepted as firm orders and are non-cancelable by the customer.

Claims for freight charges or allowances of any kind will not be considered after 30 days from receipt of goods and our responsibility ceases when we have delivered such shipments to the carriers and hold their receipts.

The following trademarks of Hubbell Incorporated, are your assurance of the highest quality wiring devices and wiring management products in the industry.

- | | | | | |
|-----------------|--------------------|-----------------------|-------------------|---------------------|
| • 4-PLEX® | • HBL® | • Micro-Quick® | • PremiseTrak® | • Super Twist-Lock® |
| • AccessTrak® | • Handi-Screw® | • Mini-Quick® | • PresSwitch® | • SWITCHOUT® |
| • Advantage™ | • Hubbell® | • MotorQuick® | • ProTrak™ | • SwivelLok® |
| • ADD-A-SHROUD® | • Hubbell Juniors® | • Nano-Quick® | • RACO® | • tradeSELECT® |
| • AUTOGUARD® | • Hubbellok® | • netSELECT® | • Rough-in Ready® | • TredTrak® |
| • BaseTrak® | • Hubbellnet® | • NEXTSPEED® | • Safety-Shroud® | • TrukTrak® |
| • CableTrak® | • inSIGHT™ | • NOT Plug Resistant™ | • ScrubShield® | • Twist-Lock® |
| • CircuitGuard® | • Insul-Lock™ | • OPTIMYZER® | • Seal-Tite® | • Valise® |
| • Circuit-Lock® | • Insulgrip® | • OPTISOK® | • Signal-Quick® | • Variload® |
| • CircuitPro® | • JLOAD® | • PANEL-SAFE® | • SNAPConnect® | • VARI-SIZE® |
| • DUA-PULL® | • Kellems® | • PLUG-CHECK® | • SPEEDGAIN® | • WallTrak® |
| • Elastogrip® | • LANTrak® | • PLUGOUT® | • Spider® | • XCLAMP™ |
| • FloorTrak® | • LINKOSITY® | • PlugTrak® | • SpikeShield® | |
| • GOTCHA® | • Load:Logic® | • PolyTrak® | • Style Line® | |
| • Gripulator® | • MAXX™ | • PolyTuff® | • Super BaseTrak® | |

UPC Vendor Code No. 783585 - Hubbell Wiring Device-Kellems

CAGE No. 74545

© 2020 Hubbell Incorporated

SECTION A

Table of Contents



Product	Page	Product	Page
Products at a Glance	A-2	USB Charger and Power Delivery Receptacles	
HBL® Extra Heavy Duty Max Devices		Features and Benefits	A-7
Hospital Grade Receptacles	A-8	Hospital and Commercial Grade Receptacles	A-32
Specification Grade Receptacles	A-9	4 Port and 2 Ports Outlets	A-32
SNAPConnect® Extra Heavy Duty Devices		4-PLEX® Receptacles and Accessories	A-33
Hospital Grade Receptacles	A-17	15 & 20A Plugs and Connectors	
GFCI, USB and Surge Receptacles	A-18	Hospital Grade 125V & 250V Devices	A-37
Specification Grade Receptacles	A-19	Standard 125V Devices	A-38
EdgeConnect™	A-19	Standard 250V Devices	A-42
Permanently Marked Receptacles	A-23	16A, 250V AC International	A-44
Switched Receptacles for Automatic Receptacle Control		Hazardous Location Receptacles, Plugs and Boxes	A-45
Wired and Wireless	A-25	Heavy Duty Insulgrip® Devices	
Codes and Standards	A-26	30A Receptacles and Plugs	A-46
Hubbell-PRO Extra Heavy Duty Devices		50A Receptacles and Plugs	A-48
Hospital Grade Receptacles	A-27	60A Receptacles and Plugs	A-50
Specification Grade Receptacles	A-29	Miscellaneous and Combination Receptacles	A-51
Commercial Specification Grade Devices		Accessories	A-52
Permanently Marked Receptacles	A-24	Technical Information	A-56
Duplex Receptacles	A-30		
Style Line® Decorator Receptacles	A-31		

Straight Blade Devices

Products at a Glance



HBL® Extra Heavy Duty Max Hospital Grade

- Deep nylon body design increases impact and chemical resistance
- One-piece nickel-plated brass ground strap
- ID marking surface for quick circuit identification
- Square head, 10-thread bronze center rivet
- External back wire clamp



HBL® Extra Heavy Duty Max

- One-piece brass ground strap
- Exclusive bypass contact design for greater contact force and reduced heat buildup
- Barbed assembly arms reduce possibility of face/base separation
- Deep face design



SNAPConnect® Extra Heavy Duty

- Hospital and Specification Grade
- SNAPConnect® modular wiring device system saves installation time
- Eliminates screw terminations
- Steel mounting strap, self-grounding
- Compact size requires minimal space
- Single receptacles available



EdgeConnect™ Spring Termination Receptacles

- Hospital and Specification Grade
- Spring termination saves installation time
- Eliminates screw terminations
- More secure connection
- Steel/Brass mounting strap, self-grounding



Hubbell-PRO Extra Heavy Duty

- Specification Grade and Hospital Grade
- Tamper-Resistant... **NOT** Plug Resistant™
- Power indicating LED feature optional
- Circuit ID marking area on Hospital Grade
- Steel mounting strap, self-grounding



USB Charger Receptacles

- Type-C, Type A&C and Type A port configurations, high power 5 Amp, 5 Volt DC USB output
- Available in Standard and Hospital Grade
- Weather Resistant Type A&C USB charger
- SNAPConnect® devices, reduce labor costs and installation time
- 4 Port and Switch Combo outlets



Commercial Specification Grade

- Installation ease
 - Single tab breakoff ears
 - Self-grounding staple
 - Easy access split circuit tab
- Tamper-Resistant... **NOT** Plug Resistant™
- Wrap-around galvanized steel straps



4-PLEX Receptacles

- Hospital Grade and Surge styles
- Mounts directly to 4-inch square box
- "A" and "B" circuit ID molded into face
- Removable knockouts for mounting to octagon concrete ring or box
- Heavy duty, triple wipe, brass power and ground contacts

Straight Blade Devices

Features and Benefits

HBL® Extra Heavy Duty Max Hospital Grade Devices

UL requirements for Hospital Grade devices is more stringent than those for standard devices. Hubbell receptacles are designed to meet and exceed the standards.

- Exclusive nickel-plated bypass contact design increases contact pressure, lowering the operating temperature
- Four point grounding system provides redundant grounding for low resistance ground continuity in high abuse areas
- Impact resistant deep face design prevents breakage

Because of these features and others, the benefit is performance, reliability and value for any health care facility.



Housing Design

- Reinforced thermoplastic base provides superior thermal, electrical and mechanical properties
- Providing contact stability, this high performance material will reduce heat buildup giving you long lasting performance
- Deep body design increases impact and chemical resistance



Terminals

- External wiring clamps allow for visual inspection of the terminals
- Unique strand containment feature on the terminal "bundles" the wire, ensuring 100% clamping of wire strands and reducing heat from the termination



One-Piece Mounting Strap

- Back wired ground terminal allows faster, easier installation
- One-piece nickel-plated brass integral ground strap for greater corrosion resistance
- Patented ground contact provides redundant grounding

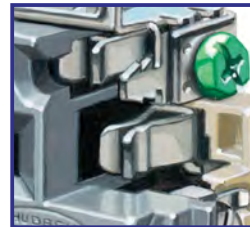

Contacts

- Exclusive bypass contacts are made of nickel-plated brass alloy, increasing blade retention, insuring reliable uninterrupted flow of power
- Barbed assembly arms reduce possibility of face/base separation



Identification

- I.D. marking surface provides quick, sure circuit identification
- All Hospital Grade devices are marked with the green dot symbol, required by UL

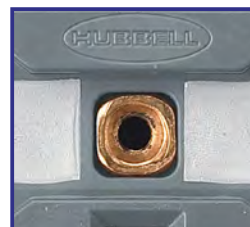

Center Rivet

- Square head, 10-thread bronze center rivet won't rotate, reduces stripping and resists corrosion

Straight Blade Devices

Features and Benefits

HBL® Extra Heavy Duty Max Industrial Series

Hubbell's commitment to quality continually reinforces a philosophy of unrivaled performance. No Hubbell device exemplifies this philosophy more than the HBL5262. While all Hubbell receptacles are designed and manufactured to withstand even the harshest environments, none match the total performance of the HBL5262.

Whether in a factory, office building or school, the Hubbell HBL5262 is the receptacle of choice when people are depending on the safety and reliability of a receptacle.

- One-piece brass ground strap
- Patented bypass contacts
- Back wired ground terminal reduces installation time and increases convenience

The safest, most reliable design for a low resistance flow of fault currents. Oversized "bell" shaped ground contacts, along with nickel plated steel retaining shields, help minimize damage to the grounding system during abrupt pullout.



Housing Design

- RTP base offers greater heat resistance, plus contact stability
- Providing contact stability, this high tech material will reduce heat buildup, giving you long lasting performance
- Deep nylon body design delivers increased impact resistance

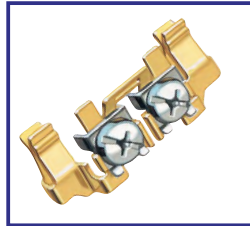

Terminals

- External bundling terminals contain wire strands and are designed for quick inspection
- Unique strand containment feature on the terminal "bundles" the wire, ensuring 100% clamping of wire strands and reducing heat from the termination

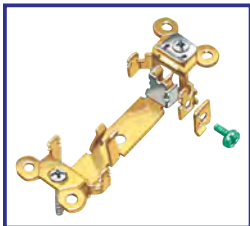

One-Piece Mounting Strap

- Back wired ground terminal allows faster, easier installation
- One-piece brass ground strap for low resistance of fault currents
- Patented ground contact provides redundant grounding



Contacts

- Patented "bypass" contacts are made of high grade brass alloy, increasing blade retention, insuring reliable uninterrupted flow of power
- Barbed brass locking arms keep the face locked in place to diminish potential for face/base separation



Identification

- I.D. marking surface provides quick, sure circuit identification



Center Rivet

- Square head, 10-thread brass center rivet won't rotate, reduces stripping and resists corrosion

Straight Blade Devices

Features and Benefits

EdgeConnect™ Spring Termination Receptacles

Hubbell's innovative, patented EdgeConnect™ devices with screwless terminations are the fastest termination devices on the market. Strong steel springs continuously apply pressure to wires, ensuring a strong connection in the most abusive environments.

Designed with easy termination access in the back of the device with laser etched terminal markings for clear identification of correct wiring.

Funneled wire entry to direct conductor strands as well as molded in leverage points for easy unwiring.

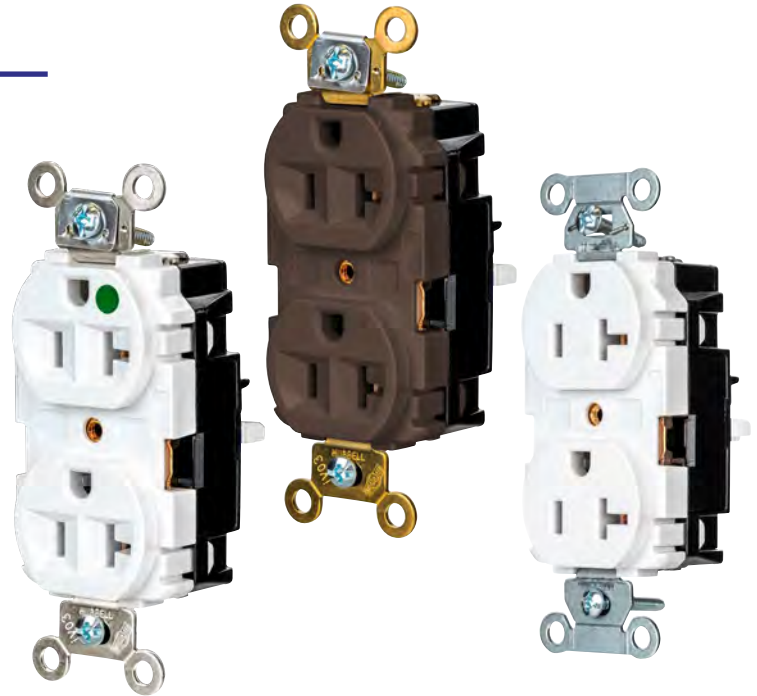

The terminations are tight from day one and stay tight, gripping hard to keep the power flowing even through high vibration environments that can steadily work wires loose and cause unscheduled downtime.

Similar performance is also demonstrated in the face of related industrial threats such as temperature cycling and strand relaxation. No matter what the environment, with EdgeConnect™ devices you won't have to go back and retighten—just install once and you're all set.

Wires secured with Hubbell's EdgeConnect™ screwless termination devices not only stay tight, they actually dig in and get tighter in the face of the relentless vibration from industrial equipment which constantly threatens the integrity of traditional connections.

IT'S ABOUT **PERFORMANCE**



Speed

80% faster terminations



Durability

Built to withstand the industry's harshest environments



Performance

Terminations are 25-60% stronger when subjected to vibration



Patented

The only screwless termination in an industrial NEMA wiring device

Straight Blade Devices

Features and Benefits

SNAPConnect® Extra Heavy Duty Receptacles

- Modular wiring system eliminates screw terminals
- Speeds installation and trim-out
- Clear polycarbonate terminal housing to inspect contacts
- Available in standard, tamper-resistant and power indicating LED versions
- Abuse resistant nylon for extra heavy use applications
- Stainless steel autoground

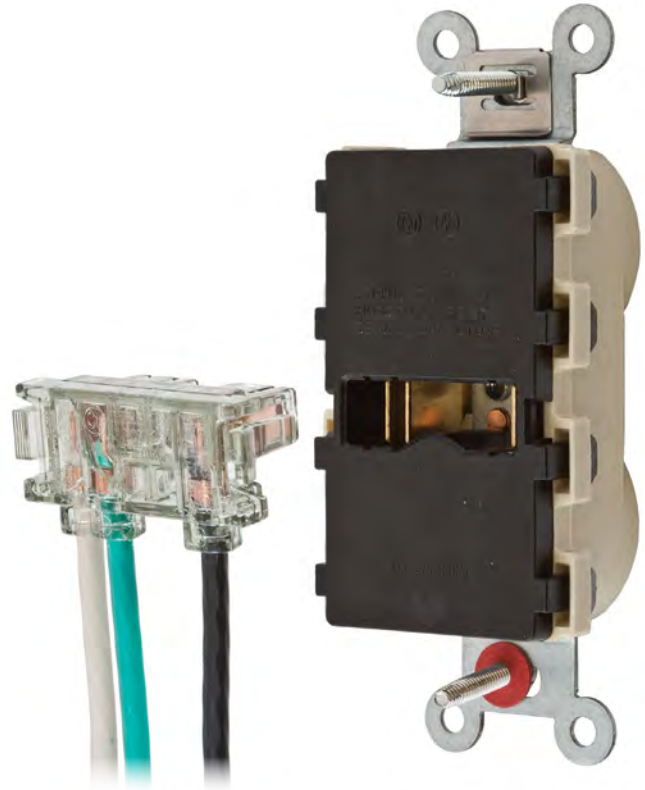

Labor Savings



Housing Design

- Reinforced thermoplastic base provides superior thermal, electrical and mechanical properties
- Compact size, requires minimal box space
- Clean finished look



Save One Minute!

- Rough-in the SNAPConnect® terminal instead of pigtails



Installation Ease

- Self-grounding clip
- Modular receptacle which requires pigtailed connector below



Save Over Three Minutes!

- Remove protective packaging and SNAPConnect® device to the circuit



Identification

- Clear terminal housing for easy inspection of power contacts
- No exposed metal
- Audible SNAP, indicates solid connection
- Secure, easy grip latch

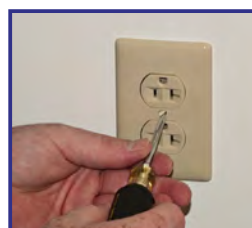

Complete Trim-Out in Less Than One Minute!

- Secure mounting screws, attach wallplate, job complete

Straight Blade Devices

Features and Benefits

Commercial Specification Grade Receptacles

The Hubbell Tamper-Resistant Mechanism eliminates the frustration and difficulty experienced using TR receptacles with plugs that have sharp, or bent blades. Hubbell TR receptacles work so well there is virtually no perceptible difference in the feel between the TR receptacles and our conventional non-TR receptacles. Trust Hubbell to deliver Tamper-Resistant protection that feels like it's not even there.

- Patented TR design eliminates plug-in difficulty and TR complaints
- Perfect for residential TR applications involving tenants with limited dexterity or hand strength
- For use in locations requiring Tamper-Resistant receptacles
- Best-in-class TR mechanism

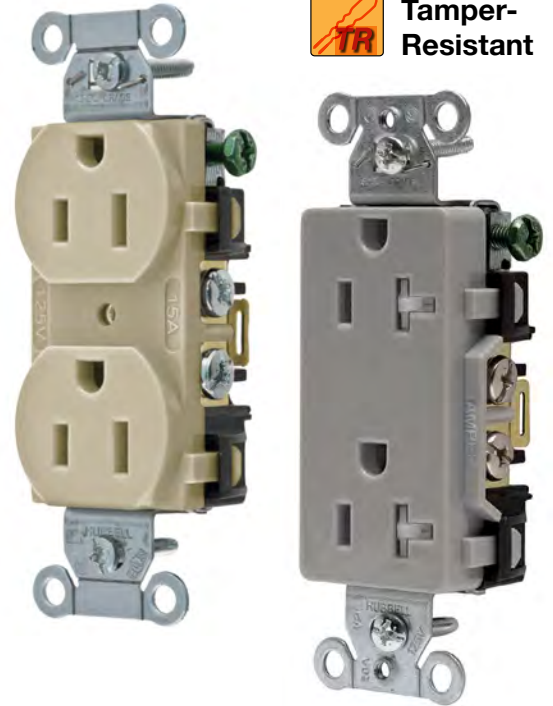

Tamper-Resistant... **NOT** Plug Resistant™



Housing Design

- Durable polycarbonate face and base construction
- Modern architectural appearance, Style Line® decorator face



Tamper-Resistant... NOT Plug Resistant®

- Patented Cam Action TR Mechanism
- Difficulties due to problematic plugs are minimized



One-Piece Mounting Strap

- Sturdy construction, wrap-around galvanized steel straps
- Installation ease
- Single tab breakoff ears
- Self-grounding staple



Contacts

- Easy access split circuit tab
- Fork terminal capable
- Oversized terminal screws



Permanently Marked Receptacles for Automatic Outlet Control Systems

- These receptacles are embossed with the universally recognized power symbol and the word "CONTROLLED" remains clearly visible after installation
- Available in SNAPConnect® and conventionally wired versions



Nightlight Receptacle

- Two nightlight LEDs for 0.5 Lumens total
- Tamper-Resistant shutters complies with NEC article 406.12
- Back and side wired

Straight Blade Devices

Features and Benefits

USB Charger Receptacles and Outlets

Hubbell's new fast charging USB-C Power Delivery receptacles provide more power. Users can quickly charge laptops and other large devices. The USB-C port marked PD (Power Delivery) provides up to 55 Watt of output. The additional Type-C or Type-A port delivers up to 1.5 Amp, 5 Volt (7.5 Watt) of power.

More Ways to Charge Faster with Hubbell's line of USB Chargers, available in Type-C, Combination Type A&C or the legacy Type A, all with a USB high power output of 5 Amp 5 Volt DC. Hubbell's USB Charger Duplex Receptacle provides both USB and electrical power in a standard single gang opening. Designed to provide maximum charging for portable electronics, the USB ports are capable of charging two tablets simultaneously.

The 4 Port Charger Outlet feature a USB port door, which when open enables power. When closed, all power is switched OFF. This eliminates all current flow for a "zero" no-load draw. Buildings looking to provide 100% green efficiency in power delivery will maximize LEED and energy efficient design.

Common Features

- Green LED indicator to show USB power available
- USB stainless steel ports rated for minimum 10,000 insertions and removals
- Complies with battery charging specification BC1.2 and 3.1 Power Delivery specification
- Designed for commercial, industrial and home use
- Compatible with USB 1.1/2.0/3.0 devices, including Apple® products



USB Charger Receptacles



4 Port Outlets



Types of USB Chargers

- Two Type-C ports, one Type A and one Type-C port, or two Type A port configurations
- High power 5 Amp, 5 Volt DC USB output
- Tamper-Resistant decorator duplex receptacle



Weather Resistant Type A&C USB Charger

- One Type A and one Type-C port configurations
- Meets Section 406.9 of NEC®
- 5 Amp, 5 Volt USB output
- Power indicating green LED light



USB-C Power Delivery Charger Receptacles

- Commercial and Hospital Grade
- Type C/C or Type A/C port configurations
- USB-C port (up to 20 Volt, 55 Watt output)
- 2nd USB-A or USB-C convenience port (up to 1.5 Amp, 5 Volt, 7.5 Watt output)
- Heavy duty spec grade



SNAPConnect® Receptacle

- SNAPConnect® devices reduce labor time during installation and when being serviced in the future
- Installation ease
- Self-grounding staple



Identification

- Patented Hubbell TR technology uses cam action shutters; the friction-free design of the mechanism's doors requires much less force to open
- Green LED indicator to show USB power available



4 Port and Switch Combo Outlets

- 4 Port outlet, Type A&C class 2.0 5 Amp, up to 9 Volt DC
- 4 Port has switch activated port door; when closed, all power is switched OFF
- Switch Combo has two USB ports 2.1 Amp, 5 Volt DC, Type A, class 2.0
- Isolated 15 Amp, 120V AC single pole/3-way switch

Apple® is a registered trademark of Apple Inc.

NEC® is a registered trademark of the National Fire Protection Association (NFPA).

Straight Blade Devices



15 and 20 Ampere, 125 Volts

IP20
SUITABILITY



15A 125V
NEMA 5-15R
UL CSA
0.5 HP



20A 125V
NEMA 5-20R
UL CSA
1 HP

HBL® Extra Heavy Duty Max Hospital Grade Receptacles

Duplex	Color	Catalog Number	
Flush, thermoplastic polyester face, back and side wired.	Black	HBL8200BK	—
	Blue	—	HBL8300BL
	Brown	HBL8200	HBL8300
	Gray	HBL8200GY	HBL8300GY
	Ivory	HBL8200I	HBL8300I
	Light Almond	HBL8200LA	HBL8300LA
	Red	HBL8200RED	HBL8300RED
	White	HBL8200W	HBL8300W
Flush, LED illuminated face, back and side wired.	Gray	HBL8200ILGY	HBL8300ILGY
	Ivory	HBL8200ILI	HBL8300ILI
	Red	HBL8200ILR	HBL8300ILR
	White	HBL8200ILW	HBL8300ILW
Tamper-Resistant receptacle with wire leads. Complies with requirements of NEC® article 517-18(c).	Brown	HBL8200SGA	HBL8300SGA
	Gray	HBL8200SGGYA	HBL8300SGGYA
	Ivory	HBL8200SGIA	HBL8300SGIA
	Light Almond	—	HBL8300SGLA
	Red	HBL8200SGRA	HBL8300SGRA
White	HBL8200SGWA	HBL8300SGWA	
Isolated ground ^A .	Orange	IG8200	IG8300
	Red	IG8200R	IG8300R

MRI Receptacle, Duplex

MRI receptacle, flush, thermoplastic polyester face, back and side wired. 100% non-ferrous.	Ivory	HBL8200IMRI	HBL8300IMRI
	Light Almond	HBL8200LAMRI	HBL8300LAMRI
	Red	HBL8200RMRI	HBL8300RMRI
	White	HBL8200WMRI	HBL8300WMRI

Slender/Compact, Duplex

Flush, thermoplastic polyester face, back, and side wired, Fed. Spec. verified.	Brown	HBL8200H	HBL8300H
	Gray	HBL8200HG	HBL8300HG
	Green	—	HBL8300HGN
	Ivory	HBL8200HI	HBL8300HI
	Light Almond	HBL8200HLA	HBL8300HLA
	Red	HBL8200HRED	HBL8300HRED
	White	HBL8200HW	HBL8300HW

Style Line® Decorator*

Flush, nylon face, back and side wired.	Brown	HBL2172	HBL2182
	Gray	HBL2172GY	HBL2182GY
	Ivory	HBL2172I	HBL2182I
	Red	HBL2172R	HBL2182R
	White	HBL2172WA	HBL2182WA
Isolated ground ^A .	Ivory	—	IG2182I
	Orange	—	IG2182
	White	—	IG2182WA

Single

Flush, nylon face, back and side wired, Fed. Spec. verified.	Brown	HBL8210	HBL8310
	Gray	HBL8210GY	HBL8310GY
	Ivory	HBL8210I	HBL8310I
	Red	HBL8210R	HBL8310R
	White	HBL8210W	HBL8310W
Panel mount on 1.94 in. (49.2) centers.	Brown	HBL8284	—
	Ivory	HBL8284I	HBL8384I
Isolated ground ^A .	Orange	IG8210	IG8310

Note: ^ASee section N for additional information on isolated ground devices.

*Not Fed. Spec. Listed.

See pages A-47 and A-48 for accessories.

See page Tech-10 for Tamper-Resistant description.

See section M for additional information on Hospital Grade products.

See section O for wallplates.

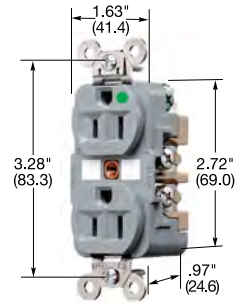

HBL8200GY

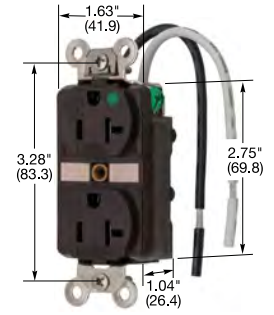

HBL8300SGA

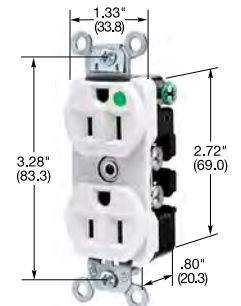

HBL8200ILW

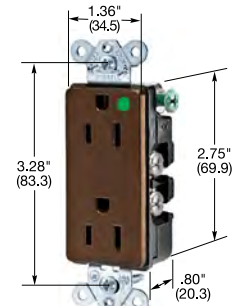

HBL2172

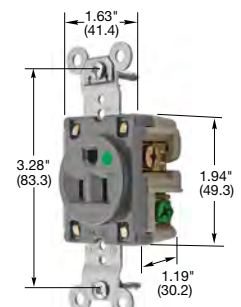

HBL8210GY

Dimensions in Inches (mm)

NEC® is a registered trademark of the National Fire Protection Association (NFPA).

Straight Blade Devices



15 and 20 Ampere, 125 and 250 Volts

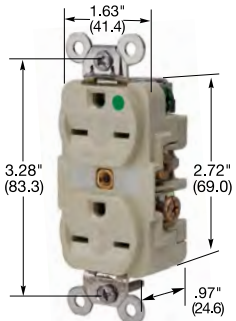

HBL8600I

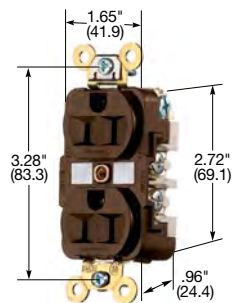

HBL5262

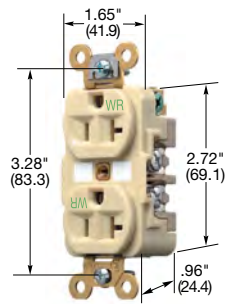

HBL5362IWR

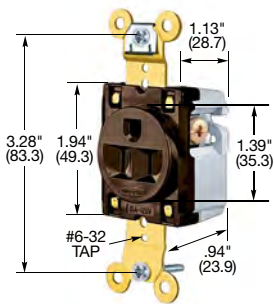

HBL5261

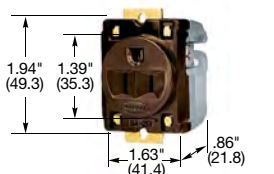

HBL5284

Dimensions in Inches (mm)

HBL® Extra Heavy Duty Max Hospital Grade Receptacles



15A 250V
NEMA 6-15R
UL CSA
1.5 HP



20A 250V
NEMA 6-20R
UL CSA
2 HP

Duplex	Color	Catalog Number	
Flush, thermoplastic polyester face, back and side wired.	Brown	HBL8600	HBL8400
	Ivory	HBL8600I	HBL8400I

Note: See page A-48 for accessories.
See section N for wallplates.



15A 125V
NEMA 5-15R
UL CSA
0.5 HP



20A 125V
NEMA 5-20R
UL CSA
1 HP

HBL® Extra Heavy Duty Max Specification Grade Receptacles

Duplex	Color	Catalog Number	
Flush, nylon face, back and side wired.	Black	HBL5262BK	HBL5362BK
	Blue	—	HBL5362BL
	Brown	HBL5262	HBL5362
	Gray	HBL5262GY	HBL5362GY
	Ivory	HBL5262I	HBL5362I
	Red	HBL5262R	HBL5362R
	White	HBL5262W	HBL5362W

Isolated ground ^A .	Gray	IG5262GY	IG5362GY
	Ivory	IG5262I	IG5362I
	Orange	IG5262	IG5362
	Red	IG5262R	IG5362R
	White	—	IG5362W

Non-isolated ground, bulk pack of 100.	Orange	—	HBL5362M4	
	Weather Resistant, flush, nylon face, back and side wired.	Black	HBL5262BKWR	HBL5362BKWR
		Brown	HBL5262WR	HBL5362WR
		Gray	HBL5262GYWR	HBL5362GYWR
		Ivory	HBL5262IWR	HBL5362IWR
		Red	HBL5262RWR	HBL5362RWR
		White	HBL5262WWR	HBL5362WWR

Corrosion resistant.	Ivory	HBL52CM62I	—
	Yellow	HBL52CM62	HBL53CM62
Weather Resistant, Isolated ground ^A .	Gray	IG5262GYWR	IG5362GYWR
	Ivory	IG5262IWR	IG5362IWR
	Orange	IG5262WR	IG5362WR
	Red	IG5262RWR	IG5362RWR
	White	—	IG5362WWR

On 4 in. (101.6) round cover.	Brown	HBL5282	—
-------------------------------	-------	----------------	---

Single

Flush, nylon face, back and side wired.	Black	HBL5261BK	HBL5361BK
	Brown	HBL5261	HBL5361
	Gray	—	HBL5361GRY
	Ivory	HBL5261I	HBL5361I
	White	—	HBL5361W

Isolated ground ^A .	Orange	IG5261	IG5361
--------------------------------	--------	---------------	---------------

Weather Resistant, Isolated ground ^A .	Orange	IG5261WR	IG5361WR
---	--------	-----------------	-----------------

Ring terminal connection.	Brown	HBL5261RT	HBL5361RT
	White	HBL5261WRT	—
	Yellow	HBL5261YRT	—

Weather Resistant, flush, nylon face, back and side wired.	Brown	HBL5261WR	HBL5361WR
	Gray	—	HBL5361GRYWR
	Ivory	HBL5261IWR	HBL5361IWR

Corrosion resistant.	Yellow	HBL52CM61	HBL53CM61
----------------------	--------	------------------	------------------

Panel mount on 1.94 in. (49.3) centers.	Brown	HBL5284	HBL5357
---	-------	----------------	----------------

Note: ^ASee section N for additional information on isolated ground devices.

See pages A-47 and A-48 for accessories.

See page Tech-10 for Weather Resistant descriptions.

See section O for wallplates.

Straight Blade Devices



15 and 20 Ampere, 125 Volts



15A 125V
NEMA 5-15R
UL CSA
0.5 HP



20A 125V
NEMA 5-20R
UL CSA
1 HP

HBL® Extra Heavy Duty Max Tamper-Resistant Receptacles

Duplex	Color	Catalog Number	
Flush, nylon face, Tamper-Resistant, back and side wired.	Black	HBL5262BKTR	HBL5362BKTR
	Blue	HBL5262BLTR	HBL5362BLTR
	Brown	HBL5262TR	HBL5362TR
	Gray	HBL5262GYTR	HBL5362GYTR
	Ivory	HBL5262ITR	HBL5362ITR
	Light Almond	HBL5262LATR	HBL5362LATR
	Red	HBL5262RTR	HBL5362RTR
	White	HBL5262WTR	HBL5362WTR

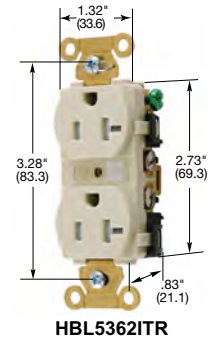

HBL® Extra Heavy Duty Max Compact Receptacles

Duplex	Color	Catalog Number	
Flush, nylon face, back and side wired.	Black	HBL5252BK	HBL5352BK
	Blue	—	HBL5352BL
	Brown	HBL5252	HBL5352
	Gray	HBL5252GY	HBL5352GY
	Ivory	HBL5252I	HBL5352I
	Red	HBL5252R	HBL5352R
	White	HBL5252W	HBL5352W
	On a 4 in. (101.6) round cover.	Brown	HBL5253
Flush, nylon face, side wired only.	Brown	HBL5242	HBL5342
	Gray	HBL5242GY	HBL5342GY
	Ivory	HBL5242I	HBL5342I
	White	HBL5242W	HBL5342W
Ring terminal connection.	Brown	HBL5242RT	HBL5342RT

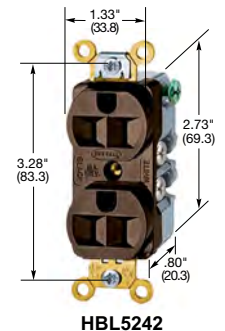
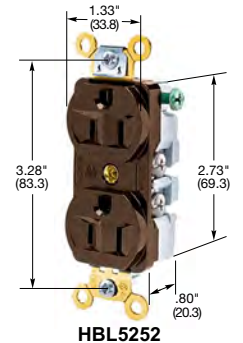

Single

Flush, side wired only.	Brown	HBL5251	—
	Ivory	HBL5251I	—
Panel mount 1.75 in. (44.5) centers.	Brown	HBL5258	HBL5358
	Ivory	HBL5258I	—

Style Line® Decorator*

Flush, nylon face, back and side wired.	Black	HBL2152BK	HBL2162BK
	Brown	HBL2152	HBL2162
	Gray	HBL2152GY	HBL2162GY
	Ivory	HBL2152I	HBL2162I
	White	HBL2152WA	HBL2162WA
Isolated ground ^A .	Gray	—	IG2162GY
	Orange	IG2152	IG2162

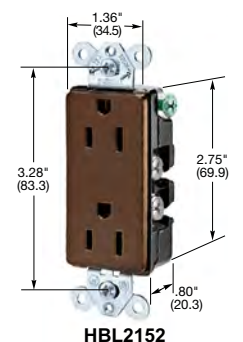
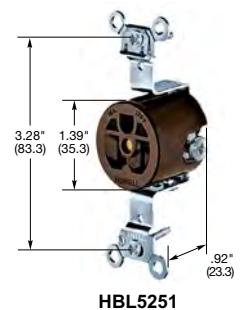

Dimensions in Inches (mm)

Note: ^ASee section N for additional information on isolated ground devices.

*Style Line Duplex devices are not Fed. Spec. Listed.

See page A-47 for accessories.

See section O for wallplates.

15 and 20 Ampere, 250 Volts

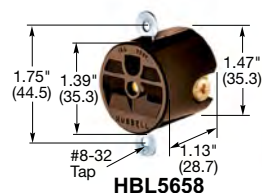
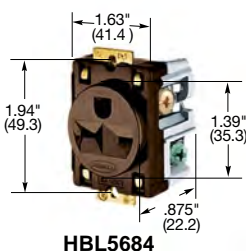
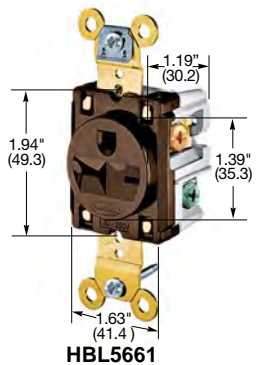
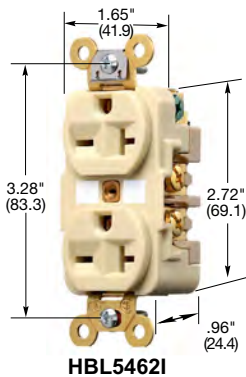
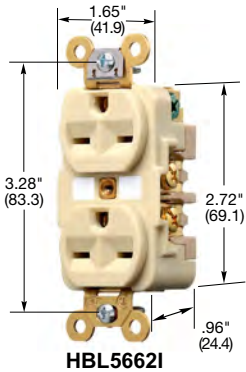

Dimensions in Inches (mm)

HBL® Extra Heavy Duty Max Specification Grade Receptacles



Duplex	Color	Catalog Number	
Flush, nylon face, back and side wired, multiple drive screws.	Black	—	HBL5462BK
	Brown	HBL5662	HBL5462
	Gray	—	HBL5462GY
	Ivory	HBL5662I	HBL5462I
	Red	—	HBL5462R
Isolated ground ^A .	Orange	IG5662	IG5462

Single	Color	Catalog Number	
Flush, nylon face, back and side wired.	Brown	HBL5661	HBL5461
	Gray	—	HBL5461GY
	Ivory	HBL5661I	HBL5461I
	Red	—	HBL5461R
	White	—	HBL5461W
Isolated ground ^A .	Orange	IG5661	IG5461
Panel mount 1.94 in. (49.3) centers.	Brown	HBL5684	—
Ring terminal connection.	Brown	HBL5661RT	—

Duplex and Single Panel Mount	Color	Catalog Number	
Flush, nylon duplex face, side wired only.	Brown	HBL5652	—
	Ivory	HBL5652I	—
Panel mount 1.75 in. (44.5) centers.	Brown	HBL5658	—

Note: ^ASee section N for additional information on isolated ground devices.
HP ratings are AC only.
See page A-47 for accessories.
See section O for wallplates.

Straight Blade Devices



15 and 20 Ampere, 125 Volts

SNAPConnect® Extra Heavy Duty Hospital Grade Receptacles

IP20
SUITABILITY

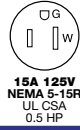

Duplex	Color	Catalog Number	Catalog Number	
Hospital grade, finder groove, nylon face, modular receptacle which requires pigtailed connector on page A-15.	Black	SNAP8200BKA	SNAP8300BKA	
	Brown	SNAP8200A	SNAP8300A	
	Gray	SNAP8200GYA	SNAP8300GYA	
	Ivory	SNAP8200IA	SNAP8300IA	
	Light Almond	SNAP8200LAA	SNAP8300LAA	
	Red	SNAP8200RA	SNAP8300RA	
Hospital grade, smooth nylon face, modular receptacle which requires pigtailed connector on page A-15. Assembled in USA.	Black	SNAP8200BKNA	SNAP8300BKNA	
	Brown	SNAP8200NA	SNAP8300NA	
	Gray	SNAP8200GYNA	SNAP8300GYNA	
	Ivory	SNAP8200INA	SNAP8300INA	
	Light Almond	SNAP8200LANA	SNAP8300LANA	
	Red	SNAP8200RNA	SNAP8300RNA	
Hospital grade, Tamper-Resistant, smooth nylon face, modular receptacle which requires pigtailed connector on page A-15. Assembled in USA.	Black	SNAP8200BKTRA	SNAP8300BKTRA	
	Brown	SNAP8200TRA	SNAP8300TRA	
	Gray	SNAP8200GYTRA	SNAP8300GYTRA	
	Ivory	SNAP8200ITRA	SNAP8300ITRA	
	Light Almond	SNAP8200LATRA	SNAP8300LATRA	
	Red	SNAP8200RTRA	SNAP8300RTRA	
Hospital grade, Tamper-Resistant, Split Circuit, smooth nylon face, modular receptacle which requires pigtailed connector on page A-15. Assembled in USA.	Black	SNAP8200BKSCTRA	SNAP8300BKSCTRA	
	Brown	SNAP8200SCTRA	SNAP8300SCTRA	
	Gray	SNAP8200GYSCTRA	SNAP8300GYSCTRA	
	Ivory	SNAP8200ISCTRA	SNAP8300ISCTRA	
	Light Almond	SNAP8200LASCTRA	SNAP8300LASCTRA	
	Red	SNAP8200RSCTRA	SNAP8300RSCTRA	
Isolated ground ^A , Hospital grade, Tamper-Resistant.	Orange	SNAP8200IGTRA	SNAP8300IGTRA	
	Red	SNAP8200RIGTRA	SNAP8300RIGTRA	
	Hospital grade, with Power Indicating LED, smooth nylon face, modular receptacle which requires pigtailed connector on page A-15. Assembled in USA.	Black	SNAP8200BKL	SNAP8300BKL
		Brown	SNAP8200L	SNAP8300L
		Gray	SNAP8200GYL	SNAP8300GYL
		Ivory	SNAP8200IL	SNAP8300IL
Light Almond		SNAP8200LAL	SNAP8300LAL	
Red		SNAP8200RL	SNAP8300RL	
Isolated ground ^A , Hospital grade, with Power Indicating LED.	Orange	SNAP8200IGL	SNAP8300IGL	
	Red	SNAP8200RIGL	SNAP8300RIGL	
	Hospital grade, Tamper-Resistant, with Power Indicating LED, smooth nylon face, modular receptacle which requires pigtailed connector on page A-15. Assembled in USA.	Black	SNAP8200BKLTR	SNAP8300BKLTR
		Brown	SNAP8200LTR	SNAP8300LTR
		Gray	SNAP8200GYLTR	SNAP8300GYLTR
		Ivory	SNAP8200ILTR	SNAP8300ILTR
Light Almond		SNAP8200LALTR	SNAP8300LALTR	
Red		SNAP8200RLTR	SNAP8300RLTR	
Hospital grade, Tamper-Resistant, with Power Indicating Face, smooth face, modular receptacle which requires pigtailed connector on page A-15.	Gray	SNAP8200GYLTR	SNAP8300GYLTR	
	Ivory	SNAP8200ILTR	SNAP8300ILTR	
	Red	SNAP8200RLTR	SNAP8300RLTR	
	White	SNAP8200WLTR	SNAP8300WLTR	
	Isolated ground ^A , Hospital grade, TR with Power Indicating LED.	Orange	SNAP8200IGLTR	SNAP8300IGLTR
		Red	SNAP8200RIGLTR	SNAP8300RIGLTR

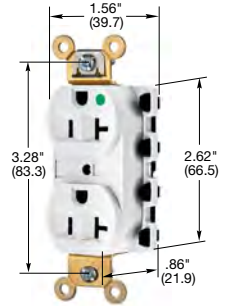

SNAP8300WA

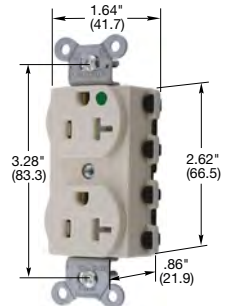

SNAP8300LATRA

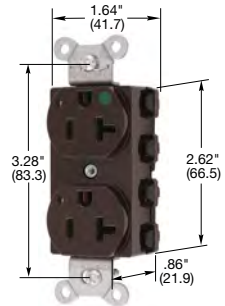

SNAP8300L



SNAP8300RLTR

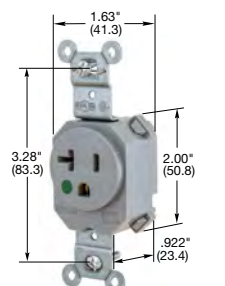

SNAP8310GY

Dimensions in Inches (mm)

SNAPConnect® Extra Heavy Duty Hospital Grade Single Receptacles

Color	Hospital Grade		Hospital Grade Tamper-Resistant	
	15A 125V	20A 125V	15A 125V	20A 125V
Black	SNAP8210BK	SNAP8310BK	SNAP8210BKTR	SNAP8310BKTR
Blue	SNAP8210BL	SNAP8310BL	SNAP8210BLTR	SNAP8310BLTR
Brown	SNAP8210	SNAP8310	SNAP8210TR	SNAP8310TR
Gray	SNAP8210GY	SNAP8310GY	SNAP8210GYTR	SNAP8310GYTR
Ivory	SNAP8210I	SNAP8310I	SNAP8210ITR	SNAP8310ITR
Light Almond	SNAP8210LA	SNAP8310LA	SNAP8210LATR	SNAP8310LATR
Red	SNAP8210R	SNAP8310R	SNAP8210RTR	SNAP8310RTR
White	SNAP8210W	SNAP8310W	SNAP8210WTR	SNAP8310WTR

15 and 20 Ampere, 125 Volts

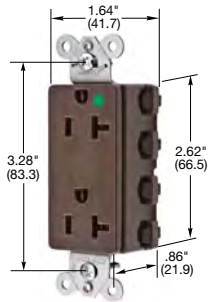

SNAP2182A

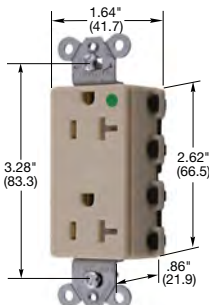

SNAP2182ITRA

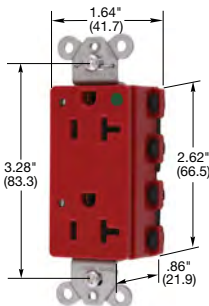

SNAP2182RL

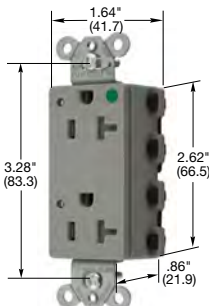

SNAP2182GYLTRA

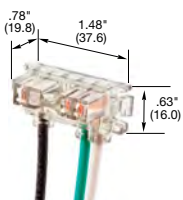

SNAP1RA

Dimensions in Inches (mm)

IP20
SUITABILITY



15A 125V
NEMA 5-15R
UL CSA
0.5 HP



20A 125V
NEMA 5-20R
UL CSA
1 HP

SNAPConnect® Extra Heavy Duty Hospital Grade Receptacles

Style Line® Decorator

Hospital grade, Style Line® decorator, flush, nylon face, modular receptacle which requires pigtailed connector on page A-15.

Hospital grade, Style Line® decorator, flush, nylon face, modular receptacle which requires pigtailed connector on page A-15. Assembled in USA.



Hospital grade, Tamper-Resistant, Style Line® decorator, flush, nylon face, modular receptacle which requires pigtailed connector on page A-15. Assembled in USA.



Hospital grade, Tamper-Resistant, Split Circuit, Style Line® decorator, flush, nylon face, modular receptacle which requires pigtailed connector on page A-15. Assembled in USA.



Isolated ground^A, Hospital grade, Tamper-Resistant.

Hospital grade, with Power Indicating LED, Style Line® decorator, flush, nylon face, modular receptacle which requires pigtailed connector on page A-15. Assembled in USA.



Isolated ground^A, Hospital grade, with Power Indicating LED.



Hospital grade, Tamper-Resistant, with Power Indicating LED, Style Line® decorator, flush, nylon face, modular receptacle which requires pigtailed connector on page A-15. Assembled in USA.

Isolated ground^A, Hospital grade, TR with Power Indicating LED.

Note: ^ASee section N additional information on isolated ground devices and section O for wallplates.

See page A-5 for additional information on SNAPConnect features.

See page Tech-10 for Tamper-Resistant and LED Power Indicators descriptions.

See pages A-47 and A-48 for accessories.

SNAPConnect® Right Angle Pigtailed Connector

Description	Wire Type	General Use	Assembled in USA
Clear right angle terminal with 6 inch leads #12 AWG THHN/THWN-2; Polycarbonate housing material.	Solid	SNAP1RA	SNAP1RNA
	Stranded	SNAP2RA	SNAP2RNA
Clear right angle terminal with 6 inch leads #12 AWG THHN/THWN-2; Polycarbonate housing material with WAGO terminals.	Solid	SNAP1RAM2	SNAP1RNAM2
	Stranded	SNAP2RAM2	SNAP2RNAM2

Note: For Assembled in USA products, must order connector with NA suffix.

Straight Blade Devices



15 and 20 Ampere, 125 Volts



15A 125V
NEMA 5-15R
UL CSA
0.5 HP



20A 125V
NEMA 5-20R
UL CSA
1 HP

SNAPConnect®

Extra Heavy Duty Receptacles

Duplex	Color	Catalog Number	Catalog Number
Specification grade, finder groove, nylon face, modular receptacle which requires pigtailed connector on page A-13.	Black	SNAP5262BK A	SNAP5362BK A
	Brown	SNAP5262A	SNAP5362A
	Gray	SNAP5262GY A	SNAP5362GY A
	Ivory	SNAP5262IA	SNAP5362IA
	Light Almond	SNAP5262LA A	SNAP5362LA A
	Red	SNAP5262RA	SNAP5362RA
	White	SNAP5262WA	SNAP5362WA
Specification grade, smooth, nylon face, modular receptacle which requires pigtailed connector on page A-13. Assembled in USA.	Black	SNAP5262BKNA	SNAP5362BKNA
	Brown	SNAP5262NA	SNAP5362NA
	Gray	SNAP5262GYNA	SNAP5362GYNA
	Ivory	SNAP5262INA	SNAP5362INA
	Light Almond	SNAP5262LANA	SNAP5362LANA
	Red	SNAP5262RNA	SNAP5362RNA
	White	SNAP5262WNA	SNAP5362WNA
Specification grade, Tamper-Resistant, smooth nylon face, modular receptacle which requires pigtailed connector on page A-13. Assembled in USA.	Black	SNAP5262BKTRA	SNAP5362BKTRA
	Blue	SNAP5262BLTRA	SNAP5362BLTRA
	Brown	SNAP5262TR A	SNAP5362TR A
	Gray	SNAP5262GYTRA	SNAP5362GYTRA
	Ivory	SNAP5262ITRA	SNAP5362ITRA
	Light Almond	SNAP5262LATRA	SNAP5362LATRA
	Red	SNAP5262RTRA	SNAP5362RTRA
White	SNAP5262WTRA	SNAP5362WTRA	
Specification grade, Tamper-Resistant, Split Circuit, smooth nylon face, modular receptacle which requires pigtailed connector on page A-13. Assembled in USA.	Black	SNAP5262BKSCTRA	SNAP5362BKSCTRA
	Blue	SNAP5262BLSCTRA	SNAP5362BLSCTRA
	Brown	SNAP5262SCTRA	SNAP5362SCTRA
	Gray	SNAP5262GYSCTRA	SNAP5362GYSCTRA
	Ivory	SNAP5262ISCTRA	SNAP5362ISCTRA
	Light Almond	SNAP5262LASCTRA	SNAP5362LASCTRA
	Red	SNAP5262RSCTRA	SNAP5362RSCTRA
White	SNAP5262WSCTRA	SNAP5362WSCTRA	
Isolated ground ⁴ , Specification grade, Tamper-Resistant.	Orange	SNAP5262IGTRA	SNAP5362IGTRA
Spec. grade, with Power Indicating LED, smooth nylon face, modular receptacle which requires pigtailed connector on page A-13. Assembled in USA.	Black	SNAP5262BKL	SNAP5362BKL
	Blue	SNAP5262BLL	SNAP5362BLL
	Brown	SNAP5262L	SNAP5362L
	Gray	SNAP5262GYL	SNAP5362GYL
	Ivory	SNAP5262IL	SNAP5362IL
	Light Almond	SNAP5262LAL	SNAP5362LAL
	Red	SNAP5262RL	SNAP5362RL
White	SNAP5262WL	SNAP5362WL	
Isolated ground ⁴ , Specification grade, with Power Indicating LED.	Orange	SNAP5262IGL	SNAP5362IGL
Specification grade, Tamper-Resistant, with Power Indicating LED, smooth nylon face, modular receptacle which requires pigtailed connector on page A-13. Assembled in USA.	Black	SNAP5262BKLTR A	SNAP5362BKLTR A
	Blue	SNAP5262BLLTR A	SNAP5362BLLTR A
	Brown	SNAP5262LTR A	SNAP5362LTR A
	Gray	SNAP5262GYLTR A	SNAP5362GYLTR A
	Ivory	SNAP5262ILTR A	SNAP5362ILTR A
	Light Almond	SNAP5262LALTR A	SNAP5362LALTR A
	Red	SNAP5262RLTR A	SNAP5362RLTR A
White	SNAP5262WLTR A	SNAP5362WLTR A	
Isolated ground ⁴ , Specification grade, TR with Power Indicating LED.	Orange	SNAP5262IGLTR A	SNAP5362IGLTR A

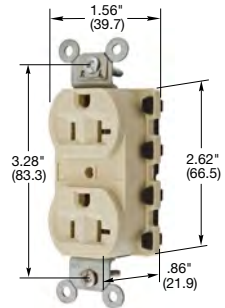

SNAP5362IA

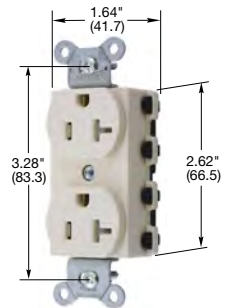

SNAP5362LA-

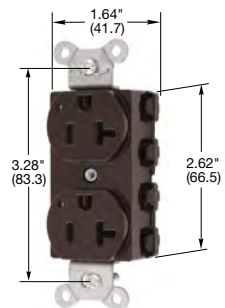

SNAP5362L

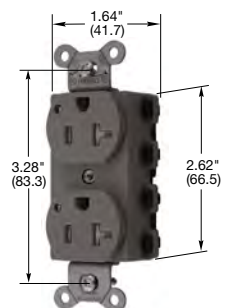

SNAP5362GYLTR A

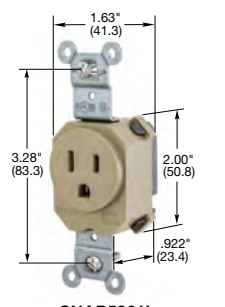

SNAP5261I

Dimensions in Inches (mm)

SNAPConnect® Extra Heavy Duty Standard Single Receptacles

Color	Standard Duplex		Standard Duplex Tamper-Resistant	
	15A 125V	20A 125V	15A 125V	20A 125V
Black	SNAP5261BK	SNAP5361BK	SNAP5261BKTR	SNAP5361BKTR
Blue	SNAP5261BL	SNAP5361BL	SNAP5261BLTR	SNAP5361BLTR
Brown	SNAP5261	SNAP5361	SNAP5261TR	SNAP5361TR
Gray	SNAP5261GY	SNAP5361GY	SNAP5261GYTR	SNAP5361GYTR
Ivory	SNAP5261I	SNAP5361I	SNAP5261ITR	SNAP5361ITR
Light Almond	SNAP5261LA	SNAP5361LA	SNAP5261LATR	SNAP5361LATR
Red	SNAP5261R	SNAP5361R	SNAP5261RTR	SNAP5361RTR
White	SNAP5261W	SNAP5361W	SNAP5261WTR	SNAP5361WTR

Straight Blade Devices



15 and 20 Ampere, 125 and 250 Volts

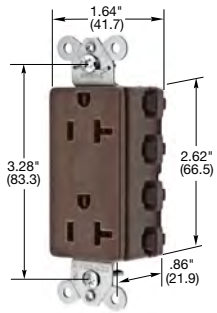

SNAP2162A

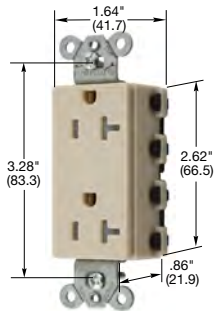

SNAP2162ITRA

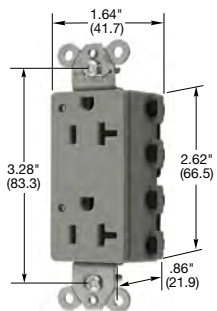

SNAP2162GYL

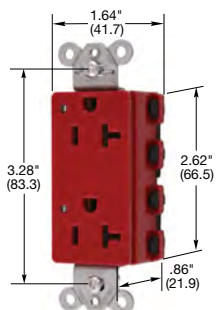

SNAP2162RLTRA

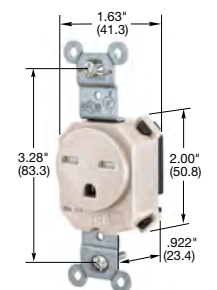

SNAP5661LATR

Dimensions in Inches (mm)

SNAPConnect® Extra Heavy Duty Receptacles



Style Line® Decorator

Specification grade, Style Line® decorator, flush, nylon face, modular receptacle which requires pigtailed connector below.

Specification grade, Style Line® decorator, flush, nylon face, modular receptacle which requires pigtailed connector below. Assembled in USA.



Specification grade, Tamper-Resistant, Style Line® decorator, flush, nylon face, modular receptacle which requires pigtailed connector below. Assembled in USA.



Specification grade, Tamper-Resistant, Split Circuit, Style Line® decorator, flush, nylon face, modular receptacle which requires pigtailed connector below. Assembled in USA.



Isolated ground^A, Spec. grade, TR. Spec. grade, with Power Indicating LED, Style Line® decorator, flush, nylon face, modular receptacle which requires pigtailed connector below. Assembled in USA.



Isolated ground^A, Spec. grade, with LED. Specification grade, Tamper-Resistant, with Power Indicating LED, Style Line® decorator, flush, nylon face, modular receptacle which requires pigtailed connector below. Assembled in USA.

Isolated ground^A, Spec. grade, TR with LED.

Note: ^ASee section N additional information on isolated ground devices.
See page Tech-10 for Tamper-Resistant and LED Power Indicators descriptions.
See pages A-47 and A-48 for accessories.
See section O for wallplates.

SNAPConnect® 250V Extra Heavy Duty Standard Single Receptacles

Description	Color	15A 250V	20A 250V
Spec. grade, single modular receptacle Tamper-Resistant, smooth nylon face. Requires pigtailed connector on page A-13.	Black	SNAP5661BKTR	SNAP5461BKTR
	Brown	SNAP5661BTR	SNAP5461BTR
	Gray	SNAP5661GYTR	SNAP5461GYTR
	Ivory	SNAP5661ITR	SNAP5461ITR
	Light Almond	SNAP5661LATR	SNAP5461LATR
	White	SNAP5661WTR	SNAP5461WTR

Straight Blade Devices

15 and 20 Ampere, 125 Volts



15A 125V
NEMA 5-15R
UL CSA
0.5 HP



20A 125V
NEMA 5-20R
UL CSA
1 HP



Meets UL
Standard 943
Class A GFCI



Fed. Spec.

SNAPConnect® GFCI LED Hospital Grade ●

Description	Color	Catalog Number	
Hospital Grade SNAPConnect GFCI LED, self-grounding staple, requires connector below, sold separately.	Black	-	SNAPGF83BLK
	Brown	-	SNAPGF83
	Gray	-	SNAPGF83GRY
	Ivory	SNAPGF82I	SNAPGF83I
	Light Almond	SNAPGF82LA	SNAPGF83LA
	Red	SNAPGF82R	SNAPGF83R
	White	SNAPGF82W	SNAPGF83W



SNAPGF83R

SNAPConnect® GFCI LED Hospital Grade ● Tamper and Weather Resistant

Description	Color	Catalog Number	
Hospital Grade SNAPConnect GFCI TR/WR, self-grounding staple, requires connector below, sold separately.	Black	-	SNAPGFTW83BLK
	Brown	-	SNAPGFTW83
	Gray	SNAPGFTW82GRY	SNAPGFTW83GRY
	Ivory	SNAPGFTW82I	SNAPGFTW83I
	Light Almond	SNAPGFTW82LA	SNAPGFTW83LA
	Red	SNAPGFTW82R	SNAPGFTW83R
	White	SNAPGFTW82W	SNAPGFTW83W



SNAPGFTW83I

Note: GFCI type receptacles should not be used in critical care patient areas or for electrical life support equipment applications because of the possibility of power interruption. All GFCI receptacles are furnished with a matching color thermoplastic wallplate, 20 amp feed-through capability.



15A 125V
NEMA 5-15R
UL CSA
0.5 HP



20A 125V
NEMA 5-20R
UL CSA
1 HP



SNAPConnect® USB Charger Hospital Grade ● Duplex Receptacles

Description	Color	Catalog Number	
Hospital Grade SNAPConnect USB Charger, Tamper-Resistant Style Line® decorator duplex receptacle, 15 or 20 Amp, 125 Volt AC with one type A & one type-C USB port, 3 Amp up to 9 Volt USB output.	Black	SNAP8200UACBK	SNAP8300UACBK
	Brown	SNAP8200UAC	SNAP8300UAC
	Gray	SNAP8200UACGY	SNAP8300UACGY
	Ivory	SNAP8200UACI	SNAP8300UACI
	Light Almond	SNAP8200UACLA	SNAP8300UACLA
	Red	SNAP8200UACR	SNAP8300UACR
	White	SNAP8200UACW	SNAP8300UACW

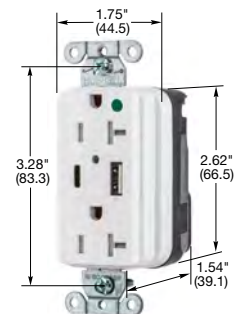

SNAP8300UACW



15A 125V
NEMA 5-15R
UL CSA
0.5 HP



20A 125V
NEMA 5-20R
UL CSA
1 HP



SNAPConnect® Surge Protection Hospital Grade ● Tamper-Resistant Receptacle with Power Indicating LED

Description	Color	Catalog Number	
Hospital Grade SNAPConnect Surge suppression, Tamper-Resistant, smooth face, duplex receptacle.	Blue	SNAP8262S	SNAP8362S
	Gray	SNAP8262GYS	SNAP8362GYS
	Ivory	SNAP8262IS	SNAP8362IS
	Light Almond	SNAP8262LAS	SNAP8362LAS
	Red	SNAP8262RS	SNAP8362RS
	White	SNAP8262WS	SNAP8362WS

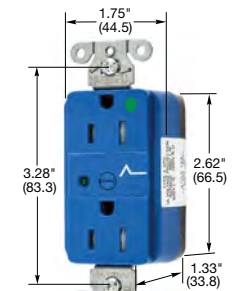

SNAP8262S

SNAPConnect® Right Angle Pigtailed Connector

Description	Wire Type	General Use	Assembled in USA
Clear right angle terminal with 6 inch leads #12 AWG THHN/THWN-2; Polycarbonate housing material.	Solid	SNAP1RA	SNAP1RNA
	Stranded	SNAP2RA	SNAP2RNA
Clear right angle terminal with 6 inch leads #12 AWG THHN/THWN-2; Polycarbonate housing material with WAGO terminals.	Solid	SNAP1RAM2	SNAP1RNAM2
	Stranded	SNAP2RAM2	SNAP2RNAM2

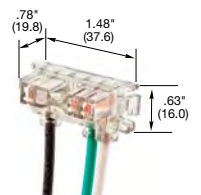

SNAP1RA

Note: See page Tech-10 for Tamper-Resistant, Weather Resistant and LED Power Indicators descriptions.

Dimensions in Inches (mm)

Straight Blade Devices

15 and 20 Ampere, 125 Volts

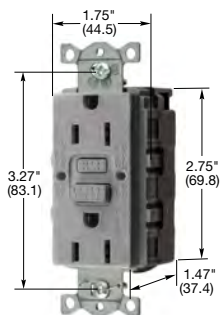

GFRST15SNAPGY

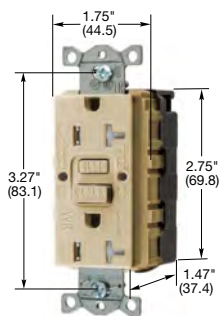

GFTWRST20SNAPI

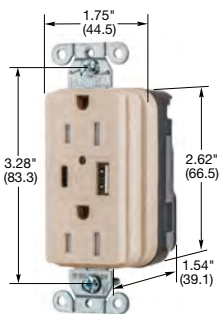

SNAP15UACLA

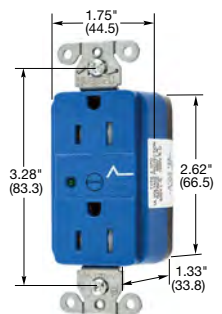

SNAP5262S

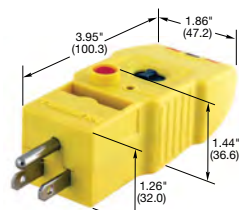

SNAPCTG

Dimensions in Inches (mm)

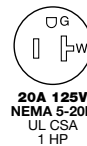
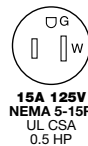

SNAPConnect® GFCI LED

Description	Color	Catalog Number	
SNAPConnect GFCI LED, self-grounding staple, requires connector below, sold separately. Add "NA" suffix for devices Assembled in USA.	Black	GFRST15SNAPBK	GFRST20SNAPBK
	Brown	GFRST15SNAP	GFRST20SNAP
	Gray	GFRST15SNAPGY	GFRST20SNAPGY
	Ivory	GFRST15SNAPI	GFRST20SNAPI
	Light Almond	GFRST15SNAPLA	GFRST20SNAPLA
	Red	GFRST15SNAPR	GFRST20SNAPR
	White	GFRST15SNAPW	GFRST20SNAPW

SNAPConnect® GFCI LED, Tamper and Weather Resistant



Description	Color	Catalog Number	
SNAPConnect GFCI TR/WR, self-grounding staple, requires connector below, sold separately. Add "NA" suffix for devices Assembled in USA.	Black	GFTWRST15SNAPBK	GFTWRST20SNAPBK
	Brown	GFTWRST15SNAP	GFTWRST20SNAP
	Gray	GFTWRST15SNAPGY	GFTWRST20SNAPGY
	Ivory	GFTWRST15SNAPI	GFTWRST20SNAPI
	Light Almond	GFTWRST15SNAPLA	GFTWRST20SNAPLA
	Red	GFTWRST15SNAPR	GFTWRST20SNAPR
	White	GFTWRST15SNAPW	GFTWRST20SNAPW

Note: GFCI type receptacles should not be used in critical care patient areas or for electrical life support equipment applications because of the possibility of power interruption. All GFCI receptacles are furnished with a matching color thermoplastic wallplate, 20 amp feed-through capability.

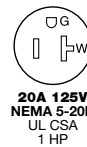
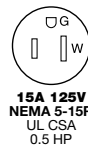

SNAPConnect® USB Charger, Duplex Receptacles



Description	Color	Catalog Number	
SNAPConnect USB Charger, Tamper-Resistant Style Line® decorator duplex receptacle, 15 or 20 Amp, 125 Volt AC with one type A & one type-C USB port, 3 Amp up to 9 Volt USB output.	Black	SNAP15UACBK	SNAP20UACBK
	Brown	SNAP15UAC	SNAP20UAC
	Gray	SNAP15UACGY	SNAP20UACGY
	Ivory	SNAP15UACI	SNAP20UACI
	Light Almond	SNAP15UACLA	SNAP20UACLA
	White	SNAP15UACW	SNAP20UACW

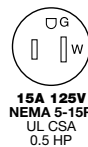

SNAPConnect® Surge Protection, Tamper-Resistant Receptacle with Power Indicating LED



Description	Color	Catalog Number	
SNAPConnect Surge suppression, Tamper-Resistant, smooth face, duplex receptacle.	Blue	SNAP5262S	SNAP5362S
	Gray	SNAP5262GYS	SNAP5362GYS
	Ivory	SNAP5262IS	SNAP5362IS
	Light Almond	SNAP5262LAS	SNAP5362LAS
	White	SNAP5262WS	SNAP5362WS

SNAPConnect® Tester

Description	Catalog Number
Circuit Tester for SNAPConnect receptacle terminals, GFCI and standard receptacles.	SNAPCTG

Note: See page Tech-10 for Tamper-Resistant, Weather Resistant and LED Power Indicators descriptions.

Straight Blade Devices

15 and 20 Ampere, 125 Volts

IP20
SUITABILITY



15A 125V
NEMA 5-15R
UL CSA
0.5 HP



20A 125V
NEMA 5-20R
UL CSA
1 HP

EdgeConnect™ HBL® Extra Heavy Duty Max Hospital Grade Receptacles

Duplex	Color	Catalog Number	
Hospital Grade, Finder Groove Face, Spring Termination	Black	HBL8200STBK	HBL8300STBK
	Blue	HBL8200STBL	HBL8300STBL
	Brown	HBL8200ST	HBL8300ST
	Gray	HBL8200STGY	HBL8300STGY
	Green	HBL8200STGN	HBL8300STGN
	Ivory	HBL8200STI	HBL8300STI
	Light Almond	HBL8200STLA	HBL8300STLA
	Orange	HBL8200STO	HBL8300STO
	Red	HBL8200STR	HBL8300STR
	White	HBL8200STW	HBL8300STW



HBL8200STBK



HBL2182STGY



HBL2172STOTR



HBL2182STRTR



HBL5362STBK

EdgeConnect™ Style Line® Decorator*

Hospital Grade, Decorator, Spring Termination	Black	HBL2172STBK	HBL2182STBK
	Blue	HBL2172STBL	HBL2182STBL
	Brown	HBL2172ST	HBL2182ST
	Gray	HBL2172STGY	HBL2182STGY
	Green	HBL2172STGN	HBL2182STGN
	Ivory	HBL2172STI	HBL2182STI
	Light Almond	HBL2172STLA	HBL2182STLA
	Orange	HBL2172STO	HBL2182STO
	Red	HBL2172STR	HBL2182STR
	White	HBL2172STW	HBL2182STW
	Hospital Grade, Tamper-Resistant, Decorator, Spring Termination	Black	HBL2172STBKTR
Blue		HBL2172STBLTR	HBL2182STBLTR
Brown		HBL2172STTR	HBL2182STTR
Gray		HBL2172STGYTR	HBL2182STGYTR
Green		HBL2172STGNTR	HBL2182STGNTR
Ivory		HBL2172STITR	HBL2182STITR
Light Almond		HBL2172STLATR	HBL2182STLATR
Orange		HBL2172STOTR	HBL2182STOTR
Red		HBL2172STRTR	HBL2182STRTR
White		HBL2172STWTR	HBL2182STWTR

EdgeConnect™ HBL® Extra Heavy Duty Max Specification Grade Receptacles

Duplex	Color	Catalog Number	
Finder Groove Face, Spring Termination	Black	HBL5262STBK	HBL5362STBK
	Blue	HBL5262STBL	HBL5362STBL
	Brown	HBL5262ST	HBL5362ST
	Gray	HBL5262STGY	HBL5362STGY
	Green	HBL5262STGN	HBL5362STGN
	Ivory	HBL5262STI	HBL5362STI
	Light Almond	HBL5262STLA	HBL5362STLA
	Orange	HBL5262STO	HBL5362STO
	Red	HBL5262STR	HBL5362STR
	White	HBL5262STW	HBL5362STW
	Tamper-Resistant, Smooth Face, Spring Termination	Black	HBL5262STBKTR
Blue		HBL5262STBLTR	HBL5362STBLTR
Brown		HBL5262STTR	HBL5362STTR
Gray		HBL5262STGYTR	HBL5362STGYTR
Green		HBL5262STGNTR	HBL5362STGNTR
Ivory		HBL5262STITR	HBL5362STITR
Light Almond		HBL5262STLATR	HBL5362STLATR
Orange		HBL5262STOTR	HBL5362STOTR
Red		HBL5262STRTR	HBL5362STRTR
White		HBL5262STWTR	HBL5362STWTR

Dimensions in Inches (mm)

Straight Blade Devices

15 and 20 Ampere, 125 and 250 Volts



15A 125V
NEMA 5-15R
UL CSA
0.5 HP



20A 125V
NEMA 5-20R
UL CSA
1 HP



HBL2152STBK



HBL2162STLA



HBL2152STGYTR



8200STGY



8300STTR

EdgeConnect™ HBL® Extra Heavy Duty Max Specification Grade Receptacles

Style Line® Decorator*

Decorator, Spring Termination	Black	HBL2152STBK	HBL2162STBK
	Blue	HBL2152STBL	HBL2162STBL
	Brown	HBL2152ST	HBL2162ST
	Gray	HBL2152STGY	HBL2162STGY
	Green	HBL2152STGN	HBL2162STGN
	Ivory	HBL2152STI	HBL2162STI
	Light Almond	HBL2152STLA	HBL2162STLA
	Orange	HBL2152STO	HBL2162STO
	Red	HBL2152STR	HBL2162STR
	White	HBL2152STW	HBL2162STW
Tamper-Resistant, Decorator, Spring Termination	Black	HBL2152STBKTR	HBL2162STBKTR
	Blue	HBL2152STBLTR	HBL2162STBLTR
	Brown	HBL2152STTR	HBL2162STTR
	Gray	HBL2152STGYTR	HBL2162STGYTR
	Green	HBL2152STGNTR	HBL2162STGNTR
	Ivory	HBL2152STITR	HBL2162STITR
	Light Almond	HBL2152STLATR	HBL2162STLATR
	Orange	HBL2152STOTR	HBL2162STOTR
	Red	HBL2152STRTR	HBL2162STRTR
	White	HBL2152STWTR	HBL2162STWTR



EdgeConnect™ Hubbell-PRO Extra Heavy Duty Hospital Grade Receptacles

Duplex	Color	Catalog Number	
Hospital Grade, Smooth Face, Spring Termination	Black	8200STBK	8300STBK
	Blue	8200STBL	8300STBL
	Brown	8200ST	8300ST
	Gray	8200STGY	8300STGY
	Green	8200STGN	8300STGN
	Ivory	8200STI	8300STI
	Light Almond	8200STLA	8300STLA
	Orange	8200STO	8300STO
	Red	8200STR	8300STR
	White	8200STW	8300STW
Hospital Grade, Tamper-Resistant, Smooth Face, Spring Termination	Black	8200STBKTR	8300STBKTR
	Blue	8200STBLTR	8300STBLTR
	Brown	8200STTR	8300STTR
	Gray	8200STGYTR	8300STGYTR
	Green	8200STGNTR	8300STGNTR
	Ivory	8200STITR	8300STITR
	Light Almond	8200STLATR	8300STLATR
	Orange	8200STOTR	8300STOTR
	Red	8200STRTR	8300STRTR
	White	8200STWTR	8300STWTR



EdgeConnect™ Hubbell-PRO Extra Heavy Duty Specification Grade Receptacles

Smooth face, duplex, spring termination	Black	5252STBK	5352STBK
	Blue	5252STBL	5352STBL
	Brown	5252ST	5352ST
	Gray	5252STGY	5352STGY
	Green	5252STGN	5352STGN
	Ivory	5252STI	5352STI
	Light Almond	5252STLA	5352STLA
	Orange	5252STO	5352STO
	Red	5252STR	5352STR
	White	5252STW	5352STW

Straight Blade Devices

15 and 20 Ampere, 125 Volts

IP20
SUITABILITY



15A 125V
NEMA 5-15R
UL CSA
0.5 HP



20A 125V
NEMA 5-20R
UL CSA
1 HP

EdgeConnect™ Hubbell-PRO Extra Heavy Duty Specification Grade Receptacles

Finder Groove face, duplex, spring termination

Black	5262STBK	5362STBK
Blue	5262STBL	5362STBL
Brown	5262ST	5362ST
Gray	5262STGY	5362STGY
Green	5262STGN	5362STGN
Ivory	5262STI	5362STI
Light Almond	5262STLA	5362STLA
Orange	5262STO	5362STO
Red	5262STR	5362STR
White	5262STW	5362STW



5362STI

Tamper-Resistant, smooth face, duplex, spring termination



Black	5262STBKTR	5362STBKTR
Blue	5262STBLTR	5362STBLTR
Brown	5262STTR	5362STTR
Gray	5262STGYTR	5362STGYTR
Green	5262STGNTR	5362STGNTR
Ivory	5262STITR	5362STITR
Light Almond	5262STLATR	5362STLATR
Orange	5262STOTR	5362STOTR
Red	5262STRTR	5362STRTR
White	5262STWTR	5362STWTR



5362STWTR

EdgeConnect™ Commercial Specification Grade Receptacles

Duplex

Smooth face, duplex, spring termination

Color	Catalog Number	
Black	BR15STBK	BR20STBK
Blue	BR15STBL	BR20STBL
Brown	BR15ST	BR20ST
Gray	BR15STGY	BR20STGY
Green	BR15STGN	BR20STGN
Ivory	BR15STI	BR20STI
Light Almond	BR15STLA	BR20STLA
Orange	BR15STO	BR20STO
Red	BR15STR	BR20STR
White	BR15STW	BR20STW



BR20STGY

Tamper-Resistant, smooth face, duplex, spring termination



Black	BR15STBKTR	BR20STBKTR
Blue	BR15STBLTR	BR20STBLTR
Brown	BR15STTR	BR20STTR
Gray	BR15STGYTR	BR20STGYTR
Green	BR15STGNTR	BR20STGNTR
Ivory	BR15STITR	BR20STITR
Light Almond	BR15STLATR	BR20STLATR
Orange	BR15STOTR	BR20STOTR
Red	BR15STRTR	BR20STRTR
White	BR15STWTR	BR20STWTR



BR20STWTR

EdgeConnect™ Style Line® Decorator*

Style Line® decorator duplex, spring termination

Black	DR15STBK	DR20STBK
Blue	DR15STBL	DR20STBL
Brown	DR15ST	DR20ST
Gray	DR15STGY	DR20STGY
Green	DR15STGN	DR20STGN
Ivory	DR15STI	DR20STI
Light Almond	DR15STLA	DR20STLA
Orange	DR15STO	DR20STO
Red	DR15STR	DR20STR
White	DR15STW	DR20STW



DR20STW

Tamper-Resistant, Style Line® decorator duplex, spring termination



Black	DR15STBKTR	DR20STBKTR
Blue	DR15STBLTR	DR20STBLTR
Brown	DR15STTR	DR20STTR
Gray	DR15STGYTR	DR20STGYTR
Green	DR15STGNTR	DR20STGNTR
Ivory	DR15STITR	DR20STITR
Light Almond	DR15STLATR	DR20STLATR
Orange	DR15STOTR	DR20STOTR
Red	DR15STRTR	DR20STRTR
White	DR15STWTR	DR20STWTR

Straight Blade Devices

15 and 20 Ampere, 125 Volts

IP20
SUITABILITY

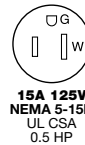

HBL5262STWWR

EdgeConnect™ HBL® Extra Heavy Duty Specification Grade Receptacles

Weather Resistant,
Finder Groove Face,
Spring Termination



Black
Blue
Brown
Gray
Green
Ivory
Light Almond
Orange
Red
White

HBL5262STBKWR
HBL5262STBLWR
HBL5262STWWR
HBL5262STGYWR
HBL5262STGNWR
HBL5262STIWR
HBL5262STLAWR
HBL5262STOWR
HBL5262STRWR
HBL5262STWWR

HBL5362STBKWR
HBL5362STBLWR
HBL5362STWWR
HBL5362STGYWR
HBL5362STGNWR
HBL5362STIWR
HBL5362STLAWR
HBL5362STOWR
HBL5362STRWR
HBL5362STWWR

EdgeConnect™ Hubbell-PRO Extra Heavy Duty Specification Grade Receptacles

Weather Resistant,
Finder Groove face, duplex,
spring termination



Black
Blue
Brown
Gray
Green
Ivory
Light Almond
Orange
Red
White

5262STBKWR
5262STBLWR
5262STWWR
5262STGYWR
5262STGNWR
5262STIWR
5262STLAWR
5262STOWR
5262STRWR
5262STWWR

5362STBKWR
5362STBLWR
5362STWWR
5362STGYWR
5362STGNWR
5362STIWR
5362STLAWR
5362STOWR
5362STRWR
5362STWWR



DR20STWWR

EdgeConnect™ Commercial Specification Grade Receptacles

Weather Resistant,
Smooth face, duplex,
spring termination



Black
Blue
Brown
Gray
Green
Ivory
Light Almond
Orange
Red
White

BR15STBKWR
BR15STBLWR
BR15STWWR
BR15STGYWR
BR15STGNWR
BR15STIWR
BR15STLAWR
BR15STOWR
BR15STRWR
BR15STWWR

BR20STBKWR
BR20STBLWR
BR20STWWR
BR20STGYWR
BR20STGNWR
BR20STIWR
BR20STLAWR
BR20STOWR
BR20STRWR
BR20STWWR



DR15STIWRTR

Weather Resistant,
Tamper-Resistant,
smooth face, duplex,
spring termination



Black
Blue
Brown
Gray
Green
Ivory
Light Almond
Orange
Red
White

BR15STBKWRTR
BR15STBLWRTR
BR15STWWRTR
BR15STGYWRTR
BR15STGNWRTR
BR15STIWRTR
BR15STLAWRTR
BR15STOWRTR
BR15STRWRTR
BR15STWWRTR

BR20STBKWRTR
BR20STBLWRTR
BR20STWWRTR
BR20STGYWRTR
BR20STGNWRTR
BR20STIWRTR
BR20STLAWRTR
BR20STOWRTR
BR20STRWRTR
BR20STWWRTR

Weather Resistant,
Style Line® decorator duplex,
spring termination



Black
Blue
Brown
Gray
Green
Ivory
Light Almond
Orange
Red
White

DR15STBKWR
DR15STBLWR
DR15STWWR
DR15STGYWR
DR15STGNWR
DR15STIWR
DR15STLAWR
DR15STOWR
DR15STRWR
DR15STWWR

DR20STBKWR
DR20STBLWR
DR20STWWR
DR20STGYWR
DR20STGNWR
DR20STIWR
DR20STLAWR
DR20STOWR
DR20STRWR
DR20STWWR



BR15STGYWR

Weather Resistant,
Tamper-Resistant,
Style Line® decorator duplex,
spring termination



Black
Blue
Brown
Gray
Green
Ivory
Light Almond
Orange
Red
White

DR15STBKWRTR
DR15STBLWRTR
DR15STWWRTR
DR15STGYWRTR
DR15STGNWRTR
DR15STIWRTR
DR15STLAWRTR
DR15STOWRTR
DR15STRWRTR
DR15STWWRTR

DR20STBKWRTR
DR20STBLWRTR
DR20STWWRTR
DR20STGYWRTR
DR20STGNWRTR
DR20STIWRTR
DR20STLAWRTR
DR20STOWRTR
DR20STRWRTR
DR20STWWRTR

Dimensions in Inches (mm)

Straight Blade Devices



15 and 20 Ampere, 125 Volts



- Permanent power symbol remains clearly visible after installation
- Control both outlets per device for 100% controlled applications or just one outlet for 50% controlled applications
- Ideal for commercial buildings, retail, schools, hotel rooms
- Part of the Hubbell Load:Logic® Plug Control system

SNAPConnect® Permanently Marked Receptacles

Duplex	Color	One Controlled Face Split Circuit Hot Tab		Two Controlled Faces		
		15 Amp	20 Amp	15 Amp	20 Amp	
SNAPConnect® standard duplex, permanently marked for use with automatic plugload controls.	Black	SNAP5262C1BK	SNAP5362C1BK	SNAP5262C2BK	SNAP5362C2BK	
	Blue	SNAP5262C1BL	SNAP5362C1BL	SNAP5262C2BL	SNAP5362C2BL	
	Brown	SNAP5262C1	SNAP5362C1	SNAP5262C2	SNAP5362C2	
	Gray	SNAP5262C1GY	SNAP5362C1GY	SNAP5262C2GY	SNAP5362C2GY	
	Green	SNAP5262C1GN	SNAP5362C1GN	SNAP5262C2GN	SNAP5362C2GN	
	Ivory	SNAP5262C1I	SNAP5362C1I	SNAP5262C2I	SNAP5362C2I	
	Lt. Almond	SNAP5262C1LA	SNAP5362C1LA	SNAP5262C2LA	SNAP5362C2LA	
	Red	SNAP5262C1R	SNAP5362C1R	SNAP5262C2R	SNAP5362C2R	
	White	SNAP5262C1W	SNAP5362C1W	SNAP5262C2W	SNAP5362C2W	
	SNAPConnect® Tamper-Resistant, standard duplex, permanently marked for use with automatic plugload controls.	Black	SNAP5262C1BKTRA	SNAP5362C1BKTRA	SNAP5262C2BKTRA	SNAP5362C2BKTRA
Brown		SNAP5262C1TRA	SNAP5362C1TRA	SNAP5262C2TRA	SNAP5362C2TRA	
Gray		SNAP5262C1GYTRA	SNAP5362C1GYTRA	SNAP5262C2GYTRA	SNAP5362C2GYTRA	
Green		SNAP5262C1GNTRA	SNAP5362C1GNTRA	SNAP5262C2GNTRA	SNAP5362C2GNTRA	
Ivory		SNAP5262C1ITRA	SNAP5362C1ITRA	SNAP5262C2ITRA	SNAP5362C2ITRA	
Lt. Almond		SNAP5262C1LATRA	SNAP5362C1LATRA	SNAP5262C2LATRA	SNAP5362C2LATRA	
White		SNAP5262C1WTRA	SNAP5362C1WTRA	SNAP5262C2WTRA	SNAP5362C2WTRA	
SNAPConnect® Style Line® Decorator		Black	SNAP2152C1BK	SNAP2162C1BK	SNAP2152C2BK	SNAP2162C2BK
		Blue	SNAP2152C1BL	SNAP2162C1BL	SNAP2152C2BL	SNAP2162C2BL
		Brown	SNAP2152C1	SNAP2162C1	SNAP2152C2	SNAP2162C2
	Gray	SNAP2152C1GY	SNAP2162C1GY	SNAP2152C2GY	SNAP2162C2GY	
	Green	SNAP2152C1GN	SNAP2162C1GN	SNAP2152C2GN	SNAP2162C2GN	
	Ivory	SNAP2152C1I	SNAP2162C1I	SNAP2152C2I	SNAP2162C2I	
	Lt. Almond	SNAP2152C1LA	SNAP2162C1LA	SNAP2152C2LA	SNAP2162C2LA	
	Red	SNAP2152C1R	SNAP2162C1R	SNAP2152C2R	SNAP2162C2R	
	White	SNAP2152C1W	SNAP2162C1W	SNAP2152C2W	SNAP2162C2W	
	SNAPConnect® Tamper-Resistant, decorator duplex, permanently marked for use with automatic plugload controls.	Black	SNAP2152C1BKTRA	SNAP2162C1BKTRA	SNAP2152C2BKTRA	SNAP2162C2BKTRA
Brown		SNAP2152C1TRA	SNAP2162C1TRA	SNAP2152C2TRA	SNAP2162C2TRA	
Gray		SNAP2152C1GYTRA	SNAP2162C1GYTRA	SNAP2152C2GYTRA	SNAP2162C2GYTRA	
Green		SNAP2152C1GNTRA	SNAP2162C1GNTRA	SNAP2152C2GNTRA	SNAP2162C2GNTRA	
Ivory		SNAP2152C1ITRA	SNAP2162C1ITRA	SNAP2152C2ITRA	SNAP2162C2ITRA	
Lt. Almond		SNAP2152C1LATRA	SNAP2162C1LATRA	SNAP2152C2LATRA	SNAP2162C2LATRA	
White		SNAP2152C1WTRA	SNAP2162C1WTRA	SNAP2152C2WTRA	SNAP2162C2WTRA	

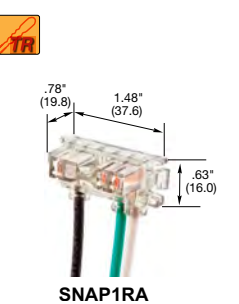
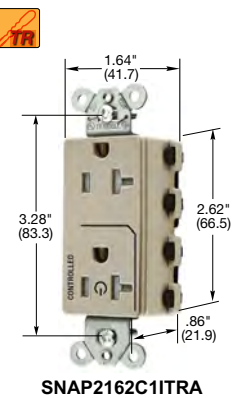
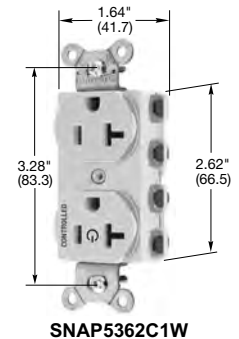

SNAPConnect® Right Angle Pigtailed Connector

Description	Solid Wire	Stranded Wire
Clear right angle terminal with 6 inch leads, 600V, #12 AWG THHN/THWN-2; Polycarbonate housing material.	SNAP1RA	SNAP2RA

Permanent Controlled Receptacle Label

Description	Catalog Number
For use in retrofit applications where indication of a controlled receptacle is required. This label is UL approved for marking and labeling. 60 labels of each per pack.	CL60

Dimensions in Inches (mm)

15 and 20 Ampere, 125 Volts

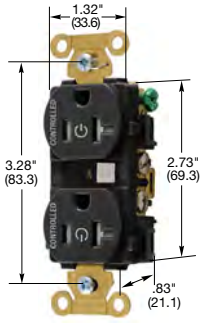

HBL5362C2BLKTR

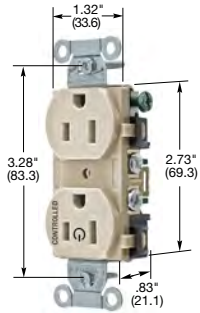

BR15C1LA

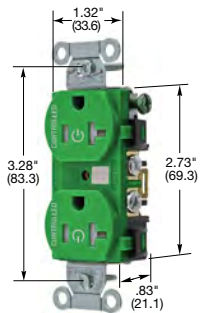

BR20C2GNTR

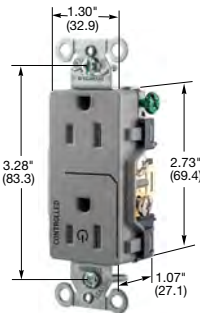

DR15C1GRY

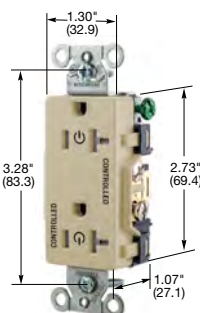

DR20C2I TR

Industrial Grade, Permanently Marked Tamper-Resistant Receptacles



Duplex	Color	One Controlled Face Split Circuit Hot Tab		Two Controlled Faces	
		15 Amp	20 Amp	15 Amp	20 Amp
Smooth nylon face, duplex, permanently marked for use with automatic outlet control systems, back and side wired.	Black	HBL5262C1BLKTR	HBL5362C1BLKTR	HBL5262C2BLKTR	HBL5362C2BLKTR
	Blue	HBL5262C1BLTR	HBL5362C1BLTR	HBL5262C2BLTR	HBL5362C2BLTR
	Brown	HBL5262C1TR	HBL5362C1TR	HBL5262C2TR	HBL5362C2TR
	Gray	HBL5262C1GRYTR	HBL5362C1GRYTR	HBL5262C2GRYTR	HBL5362C2GRYTR
	Ivory	HBL5262C1ITR	HBL5362C1ITR	HBL5262C2ITR	HBL5362C2ITR
	Lt. Almond	HBL5262C1LATR	HBL5362C1LATR	HBL5262C2LATR	HBL5362C2LATR
	Red	HBL5262C1RTR	HBL5362C1RTR	HBL5262C2RTR	HBL5362C2RTR
	White	HBL5262C1WHITR	HBL5362C1WHITR	HBL5262C2WHITR	HBL5362C2WHITR

Permanently Marked Receptacles

Duplex	Color	One Controlled Face Split Circuit Hot Tab		Two Controlled Faces		
		15 Amp	20 Amp	15 Amp	20 Amp	
Smooth polycarbonate face, duplex, permanently marked for use with automatic outlet control systems, back and side wired.	Black	BR15C1BLK	BR20C1BLK	BR15C2BLK	BR20C2BLK	
	Blue	BR15C1BL	BR20C1BL	BR15C2BL	BR20C2BL	
	Brown	BR15C1	BR20C1	BR15C2	BR20C2	
	Gray	BR15C1GRY	BR20C1GRY	BR15C2GRY	BR20C2GRY	
	Green	BR15C1GN	BR20C1GN	BR15C2GN	BR20C2GN	
	Ivory	BR15C1I	BR20C1I	BR15C2I	BR20C2I	
	Lt. Almond	BR15C1LA	BR20C1LA	BR15C2LA	BR20C2LA	
	Red	BR15C1R	BR20C1R	BR15C2R	BR20C2R	
	White	BR15C1WHI	BR20C1WHI	BR15C2WHI	BR20C2WHI	
	Smooth polycarbonate face, Tamper-Resistant, duplex, permanently marked for use with automatic outlet control systems, back and side wired.	Black	BR15C1BLKTR	BR20C1BLKTR	BR15C2BLKTR	BR20C2BLKTR
		Blue	BR15C1BLTR	BR20C1BLTR	BR15C2BLTR	BR20C2BLTR
Brown		BR15C1TR	BR20C1TR	BR15C2TR	BR20C2TR	
Gray		BR15C1GRYTR	BR20C1GRYTR	BR15C2GRYTR	BR20C2GRYTR	
Green		BR15C1GNTR	BR20C1GNTR	BR15C2GNTR	BR20C2GNTR	
Ivory		BR15C1ITR	BR20C1ITR	BR15C2ITR	BR20C2ITR	
Lt. Almond		BR15C1LATR	BR20C1LATR	BR15C2LATR	BR20C2LATR	
Red		BR15C1RTR	BR20C1RTR	BR15C2RTR	BR20C2RTR	
White	BR15C1WHITR	BR20C1WHITR	BR15C2WHITR	BR20C2WHITR		



Style Line® Decorator

Smooth polycarbonate face, decorator duplex, permanently marked for use with automatic outlet control systems, back and side wired.	Black	DR15C1BLK	DR20C1BLK	DR15C2BLK	DR20C2BLK	
	Blue	DR15C1BL	DR20C1BL	DR15C2BL	DR20C2BL	
	Brown	DR15C1	DR20C1	DR15C2	DR20C2	
	Gray	DR15C1GRY	DR20C1GRY	DR15C2GRY	DR20C2GRY	
	Green	DR15C1GN	DR20C1GN	DR15C2GN	DR20C2GN	
	Ivory	DR15C1I	DR20C1I	DR15C2I	DR20C2I	
	Lt. Almond	DR15C1LA	DR20C1LA	DR15C2LA	DR20C2LA	
	Red	DR15C1R	DR20C1R	DR15C2R	DR20C2R	
	White	DR15C1WHI	DR20C1WHI	DR15C2WHI	DR20C2WHI	
	Smooth polycarbonate face, Tamper-Resistant, decorator duplex, permanently marked for use with automatic outlet control systems, back and side wired.	Black	DR15C1BLKTR	DR20C1BLKTR	DR15C2BLKTR	DR20C2BLKTR
		Blue	DR15C1BLTR	DR20C1BLTR	DR15C2BLTR	DR20C2BLTR
Brown		DR15C1TR	DR20C1TR	DR15C2TR	DR20C2TR	
Gray		DR15C1GRYTR	DR20C1GRYTR	DR15C2GRYTR	DR20C2GRYTR	
Green		DR15C1GNTR	DR20C1GNTR	DR15C2GNTR	DR20C2GNTR	
Ivory		DR15C1ITR	DR20C1ITR	DR15C2ITR	DR20C2ITR	
Lt. Almond		DR15C1LATR	DR20C1LATR	DR15C2LATR	DR20C2LATR	
Red		DR15C1RTR	DR20C1RTR	DR15C2RTR	DR20C2RTR	
White	DR15C1WHITR	DR20C1WHITR	DR15C2WHITR	DR20C2WHITR		



Permanent Controlled Receptacle Label

Description	Catalog Number
For use in retrofit applications where indication of a controlled receptacle is required. This label is UL approved for marking and labeling. 60 labels of each per pack.	CL60

Dimensions in Inches (mm)

Straight Blade Devices

Features and Benefits

Switched Receptacles for Automatic Receptacle Control

The Load Control Switched Duplex Receptacle is the latest addition to Hubbell Wiring Device-Kellems' comprehensive offering for automatic receptacle control requirements. Featuring Hubbell's exclusive and patented tamper-resistant mechanism as standard, the unit is capable of controlling other receptacles downstream in the branch circuit.

Hubbell offers this innovative device in wired and wireless options, which are both fully compatible with existing systems. This allows for easy additions and changes to meet current energy codes and standards in current facilities.

Common Features

- Half Controlled or Fully Controlled 15A or 20A Options
- Hubbell's Exclusive Tamper-Resistant Mechanism
- Downstream Branch Circuit Control
- Brass Strap
- Permanent NEC 406.3 (E) Markings
- UL498B SA Listed Receptacles with Integral Switching Comply with Supplement SA
- Fed Spec W596G
- Hospital Grade Series Available



Wired Switched Receptacles

- The wired series is designed to be automatically controlled by a low voltage signal from either occupancy sensors, or any other type of control device capable of performing this task, such as a time-of-day control device



Wireless Switched Receptacles

- The Clear Connect™ enabled wireless series is a wireless receiver that is controlled by the corresponding occupancy sensor

Wired Switched Receptacles for Automatic Receptacle Control

Description	Color	15A		20A	
		Split Circuit	Fully Controlled	Split Circuit	Fully Controlled
Auto ON/Auto OFF control. Capable of controlling additional receptacles downstream.	Black	HBL5262LC1BK	HBL5262LC2BK	HBL5362LC1BK	HBL5362LC2BK
	Brown	HBL5262LC1	HBL5262LC2	HBL5362LC1	HBL5362LC2
	Gray	HBL5262LC1GY	HBL5262LC2GY	HBL5362LC1GY	HBL5362LC2GY
	Green	HBL5262LC1GN	HBL5262LC2GN	HBL5362LC1GN	HBL5362LC2GN
	Ivory	HBL5262LC1I	HBL5262LC2I	HBL5362LC1I	HBL5362LC2I
	Lt. Almond	HBL5262LC1LA	HBL5262LC2LA	HBL5362LC1LA	HBL5362LC2LA
White	HBL5262LC1W	HBL5262LC2W	HBL5362LC1W	HBL5362LC2W	

Note: See Section E, page E-31 for technical information. Special order for hospital grade devices.



HBL5362LC2LA

Wireless Switched Receptacles for Automatic Receptacle Control

Description	Color	15A		20A	
		Split Circuit	Fully Controlled	Split Circuit	Fully Controlled
Wireless receiver Auto ON/Auto OFF. Capable of controlling additional receptacles downstream.	Black	HBL5262RFC1BK	HBL5262RFC2BK	HBL5362RFC1BK	HBL5362RFC2BK
	Brown	HBL5262RFC1	HBL5262RFC2	HBL5362RFC1	HBL5362RFC2
	Gray	HBL5262RFC1GY	HBL5262RFC2GY	HBL5362RFC1GY	HBL5362RFC2GY
	Green	HBL5262RFC1GN	HBL5262RFC2GN	HBL5362RFC1GN	HBL5362RFC2GN
	Ivory	HBL5262RFC1I	HBL5262RFC2I	HBL5362RFC1I	HBL5362RFC2I
	Lt. Almond	HBL5262RFC1LA	HBL5262RFC2LA	HBL5362RFC1LA	HBL5362RFC2LA
White	HBL5262RFC1W	HBL5262RFC2W	HBL5362RFC1W	HBL5362RFC2W	

Note: See Section E, page E-31 for technical information. Special order for hospital grade devices.



HBL5362RFC1GY

Straight Blade Devices



New Codes and Standards mandates that 50% of all receptacles in private offices, open offices and computer classrooms must be automatically controlled by occupancy or time based schedules. This also includes outlets in modular furniture. Hubbell provides solutions for compliance that are cost effective and installer friendly. Find out more design resources at www.hubbell-wiring.com/energy.aspx

Wired

Utilizing low voltage wiring provides installers with a familiar method of wiring and installation. Specify Hubbell's new load control receptacle to meet this requirement. Utilize alternating outlet or split receptacle wiring as required to control at least 50% of the outlets in the space.

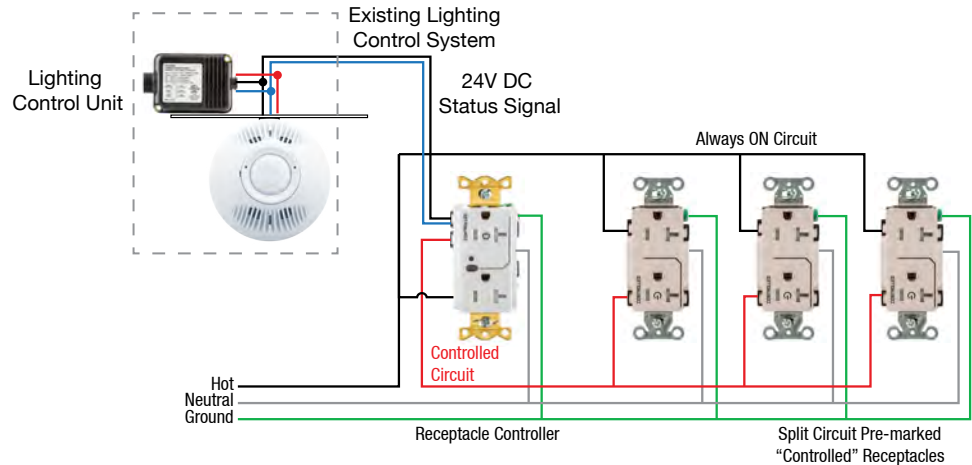

Wireless

Wireless communication takes complexity out of retrofit and difficult installations by eliminating low voltage wires running between lighting and receptacle control units. This gives installers flexibility to quickly deploy, add additional devices, and configure and re-configure the system as needed. Hubbell's WL series controls utilize Clear Connect® communication and are compatible with other Clear Connect® devices, such as Hubbell's wireless occupancy sensors.

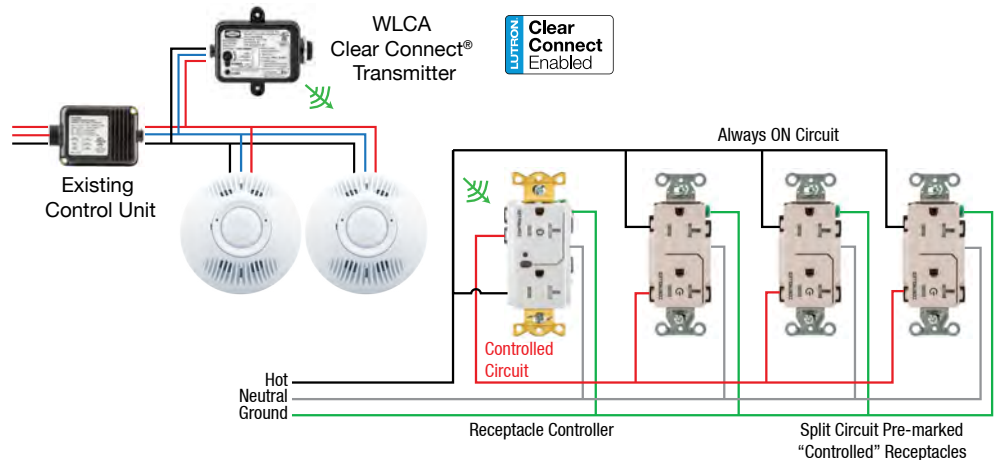

Codes and Standards

ASHRAE Standard 90.1 2019

Standard 90.1 requires that at least 50 percent of all 125V, 15A and 20A receptacles in private offices, open offices and classrooms be controlled by an automatic control device. Controlled receptacles need to be marked to differentiate them from non-controlled receptacles.



California Title 24 Building Energy Efficiency Standards 2019

Section 130.5(d) of California Energy Commission Title 24, Part 6 - 2019 code requires receptacles to have automatic shutoff controls in certain spaces in all buildings.



2020 National Electrical Code®

NEC® Section 406.3(E) requires that all nonlocking, 125 V, 15A and 20A receptacles controlled by an automatic control device or by an automatic energy management system must be marked with the  symbol and the word "CONTROLLED".



Clear Connect® is a registered trademark of Lutron Electronics Co., Inc.

Straight Blade Devices



15 and 20 Ampere, 125 Volts



15A 125V
NEMA 5-15R
UL CSA
0.5 HP



20A 125V
NEMA 5-20R
UL CSA
1 HP

Hubbell-PRO Extra Heavy Duty Hospital Grade Receptacles

Duplex	Color	Catalog Number	One Controlled Face	Two Controlled Faces
Hospital grade and hospital grade controlled, smooth nylon face, back and side wired. Assembled in USA.	Black	8200BK	8300BK	-
	Brown	8200	8300	-
	Gray	8200GY	8300GY	-
	Ivory	8200IV	8300IV	8300C1IV
	Light Almond	8200LA	8300LA	8300C1LA
	Red	8200RED	8300RED	8300C1RED
	White	8200WHI	8300WHI	8300C1WHI
Hospital grade, Tamper-Resistant, smooth nylon face, back and side wired. Assembled in USA.	Black	8200BKTRA	8300BKTRA	
	Brown	8200TRA	8300TRA	
	Gray	8200GYTRA	8300GYTRA	
	Ivory	8200IVTRA	8300IVTRA	
	Light Almond	8200LATRA	8300LATRA	
	Red	8200REDTRA	8300REDTRA	
	White	8200WTRA	8300WTRA	
Hospital grade, with Power Indicating LED, smooth nylon face, back and side wired. Assembled in USA.	Black	8200BKL	8300BKL	
	Brown	8200L	8300L	
	Gray	8200GYL	8300GYL	
	Ivory	8200IVL	8300IVL	
	Light Almond	8200LAL	8300LALM	
	Red	8200REDL	8300REDL	
	White	8200WL	8300WL	
Hospital grade, Tamper-Resistant, with Power Indicating LED, smooth nylon face, back and side wired. Assembled in USA.	Black	8200BKLTRA	8300BKLTRA	
	Brown	8200LTRA	8300LTRA	
	Gray	8200GYLTRA	8300GYLTRA	
	Ivory	8200IVLTRA	8300IVLTRA	
	Light Almond	8200LALTRA	8300LALTRA	
	Red	8200REDLTRA	8300REDLTRA	
	White	8200WLTRA	8300WLTRA	

Style Line® Decorator

Hospital grade, Style Line® decorator, flush, nylon face, back and side wired. Assembled in USA.	Black	2172BK	2182BK
	Brown	2172	2182
	Gray	2172GY	2182GY
	Ivory	2172IV	2182IV
	Light Almond	2172LA	2182LA
	Red	2172RED	2182RED
	White	2172W	2182W
Hospital grade, Tamper-Resistant, Style Line® decorator, flush, nylon face, back and side wired. Assembled in USA.	Black	2172BKTRA	2182BKTRA
	Brown	2172TRA	2182TRA
	Gray	2172GYTRA	2182GYTRA
	Ivory	2172IVTRA	2182IVTRA
	Light Almond	2172LATRA	2182LATRA
	Red	2172REDTRA	2182REDTRA
	White	2172WTRA	2182WTRA
Hospital grade, with Power Indicating LED, Style Line® decorator, flush, nylon face, back and side wired. Assembled in USA.	Black	2172BKL	2182BKL
	Brown	2172L	2182L
	Gray	2172GYL	2182GYL
	Ivory	2172IVL	2182IVL
	Light Almond	2172LAL	2182LAL
	Red	2172REDL	2182REDL
	White	2172WL	2182WL
Hospital grade, Tamper-Resistant, with Power Indicating LED, Style Line® decorator, flush, nylon face, back and side wired. Assembled in USA.	Black	2172BKLTRA	2182BKLTRA
	Brown	2172LTRA	2182LTRA
	Gray	2172GYLTRA	2182GYLTRA
	Ivory	2172IVLTRA	2182IVLTRA
	Light Almond	2172LALTRA	2182LALTRA
	Red	2172REDLTRA	2182REDLTRA
	White	2172WLTRA	2182WLTRA

Note: See pages A-47 and A-48 for accessories.
See page Tech-10 for Tamper-Resistant and LED Power Indicators descriptions.
See section O for wallplates.

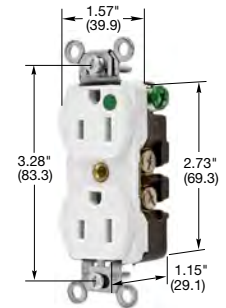

8200WHI

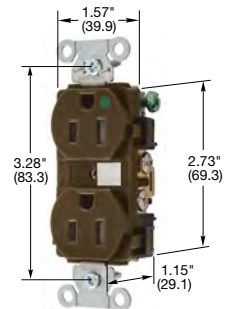

8200TRA

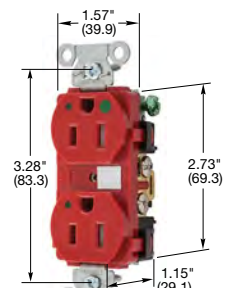

8200REDLTRA

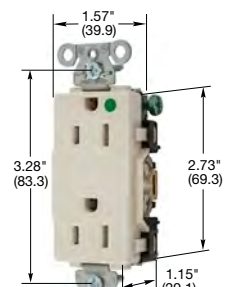

2172LATRA

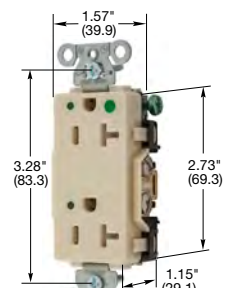

2182IVLTRA



Dimensions in Inches (mm)

Straight Blade Devices



15 and 20 Ampere, 125 and 250 Volts

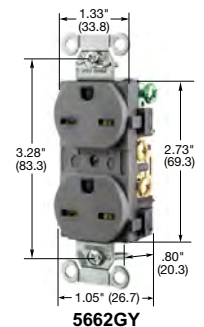
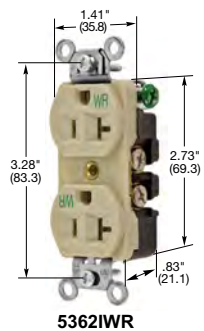
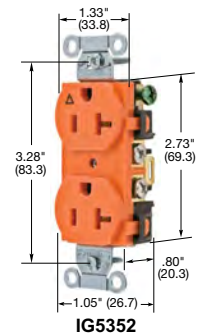
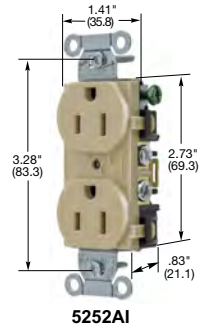
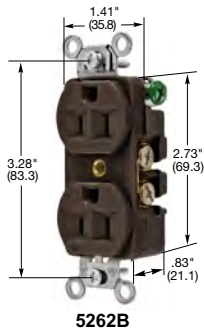

Dimensions in Inches (mm)

Hubbell-PRO Extra Heavy Duty Specification Grade Receptacles

Duplex	Color	Catalog Number	Catalog Number
Smooth polycarbonate face, duplex, back and side wired. Assembled in USA.	Black	5252BK	5352BK
	Brown	5252B	5352B
	Gray	5252G	5352G
	Ivory	5252I	5352I
	Light Almond	5252LA	5352LA
	Red	5252R	5352R
	White	5252W	5352W
Finder groove polycarbonate face, duplex, back and side wired. Assembled in USA.	Black	5262BLK	5362BLK
	Blue	5262BL	5362BL
	Brown	5262B	5362B
	Gray	5262G	5362G
	Ivory	5262I	5362I
	Light Almond	5262LA	5362LA
	Red	5262R	5362R
White	5262W	5362W	

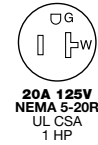
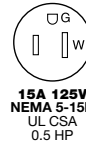

Hubbell-PRO Heavy Duty Specification Grade Receptacles

Duplex	Color	Standard Duplex		Isolated Ground ^A	
		15A 125V NEMA 5-15R	20A 125V NEMA 5-20R	15A 125V NEMA 5-15R	20A 125V NEMA 5-20R
Smooth polycarbonate face, duplex, back and side wired.	Black	5252ABLK	5352ABLK	—	—
	Brown	5252AB	5352AB	—	—
	Gray	5252AG	5352AG	IG5252GY	IG5352GY
	Ivory	5252AI	5352AI	IG5252I	IG5352I
	Light Almond	5252ALA	5352ALA	IG5252LA	IG5352LA
	Orange	—	—	IG5252	IG5352
	Red	5252AR	5352AR	—	—
	White	5252AW	5352AW	IG5252W	IG5352W
	Black	5252BLKTR	5352BLKTR	—	—
	Brown	5252BTR	5352BTR	—	—
	Gray	5252GTR	5352GTR	—	—
	Ivory	5252ITR	5352ITR	IG5252ITR	IG5352ITR
	Light Almond	5252LATR	5352LATR	—	—
Orange	—	—	IG5252TR	IG5352TR	
Red	5252RTR	5352RTR	—	—	
White	5252WTR	5352WTR	IG5252WTR	IG5352WTR	
Finder groove polycarbonate face, duplex, back and side wired.	Black	5262ABLK	5362ABLK	CR5252IGBK	CR5352IGBK
	Blue	5262ABL	5362ABL	—	CR5352IGBL
	Brown	5262AB	5362AB	—	—
	Gray	5262AG	5362AG	CR5252IGGY	CR5352IGGY
	Ivory	5262AI	5362AI	CR5252IGI	CR5352IGI
	Light Almond	5262ALA	5362ALA	—	—
	Orange	—	—	CR5252IG	CR5352IG
	Red	5262AR	5362AR	—	—
	White	5262AW	5362AW	CR5252IGW	CR5352IGW
	Weather resistant, Finder groove nylon face, duplex, back and side wired.	Black	5262BKWR	5362BKWR	—
Brown		5262WR	5362WR	—	—
Gray		5262GYWR	5362GYWR	—	—
Ivory		5262IWR	5362IWR	—	—
White		5262WWR	5362WWR	—	—

Note: ^ASee section N for additional information on isolated ground devices. See page A-47 for accessories and section O for wallplates. See page Tech-10 for Tamper and Weather Resistant descriptions. Horsepower ratings listed above are AC only.

Hubbell-PRO 250V Heavy Duty Specification Grade Receptacles

Description	Color	Catalog Number	Catalog Number
Smooth nylon face, duplex, back and side wired.	Black	5662BK	5462BK
	Blue	5662BL	5462BL
	Brown	5662B	5462B
	Gray	5662GY	5462GY
	Green	5662GN	5462GN
	Ivory	5662IV	5462IV
	Light Almond	5662LA	5462LA
	Red	5662R	5462R
	White	5662WHI	5462WHI

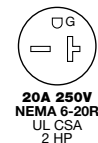
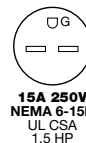

Straight Blade Devices



15 and 20 Ampere, 125 Volts



15A 125V
NEMA 5-15R
UL CSA
0.5 HP



20A 125V
NEMA 5-20R
UL CSA
1 HP

Commercial Specification Grade Receptacles

Duplex	Color	Catalog Number	
Smooth polycarbonate face, duplex, side wired only.	Black	CR15BLK	CR20BLK
	Brown	CR15	CR20
	Gray	CR15GRY	CR20GRY
	Ivory	CR15I	CR20I
	Light Almond	CR15LA	CR20LA
	White	CR15WHI	CR20WHI
Tamper-Resistant, smooth polycarbonate face, duplex, side wired only.	Black	CR15BLKTR	CR20BLKTR
	Brown	CR15TR	CR20TR
	Gray	CR15GRYTR	CR20GRYTR
	Ivory	CR15ITR	CR20ITR
	Light Almond	CR15LATR	CR20LATR
	White	CR15WHITR	CR20WHITR
Finder groove, polycarbonate face, duplex, side wired only.	Black	—	CRF20BLK
	Brown	CRF15	CRF20
	Gray	CRF15GRY	CRF20GRY
	Ivory	CRF15I	CRF20I
	Light Almond	CRF15LA	CRF20LA
	White	CRF15WHI	CRF20WHI
Pre-wired receptacles, smooth polycarbonate face, duplex, side wired only, self-grounding, 8" solid wire leads.	Black	CR15BLKP1	CR20BLKP1
	Brown	CR15P1	CR20P1
	Gray	CR15GRYP1	CR20GRYP1
	Ivory	CR15IP1	CR20IP1
	Light Almond	CR15LAP1	CR20LAP1
	White	CR15WHIP1	CR20WHIP1
Pre-wired receptacles, smooth polycarbonate face, duplex, side wired only, self-grounding, 8" stranded wire leads.	Black	CR15BLKP2	CR20BLKP2
	Brown	CR15P2	CR20P2
	Gray	CR15GRYP2	CR20GRYP2
	Ivory	CR15IP2	CR20IP2
	Light Almond	CR15LAP2	CR20LAP2
	White	CR15WHIP2	CR20WHIP2
Pre-wired receptacles, Tamper-Resistant, smooth polycarbonate face, duplex, side wired only, self-grounding, 8" solid wire leads.	Black	CR15BLKTRP1	CR20BLKTRP1
	Brown	CR15TRP1	CR20TRP1
	Gray	CR15GRYTRP1	CR20GRYTRP1
	Ivory	CR15ITRP1	CR20ITRP1
	Light Almond	CR15LATRP1	CR20LATRP1
	White	CR15WHITRP1	CR20WHITRP1
Pre-wired receptacles, Tamper-Resistant, smooth polycarbonate face, duplex, side wired only, self-grounding, 8" stranded wire leads.	Black	CR15BLKTRP2	CR20BLKTRP2
	Brown	CR15TRP2	CR20TRP2
	Gray	CR15GRYTRP2	CR20GRYTRP2
	Ivory	CR15ITRP2	CR20ITRP2
	Light Almond	CR15LATRP2	CR20LATRP2
	White	CR15WHITRP2	CR20WHITRP2

Note: See page A-47 for accessories.
See page Tech-10 for Tamper-Resistant descriptions.
See section O for wallplates.

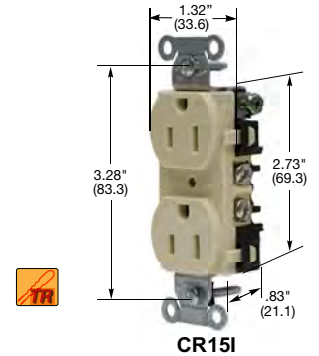

CR15

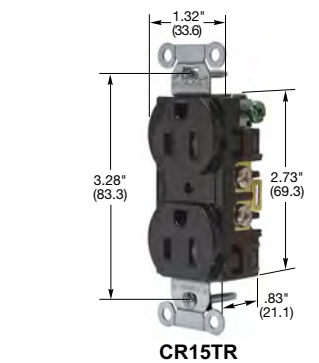

CR15TR

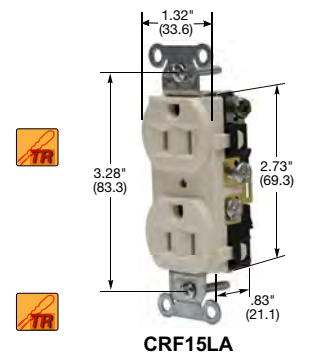

CRF15LA

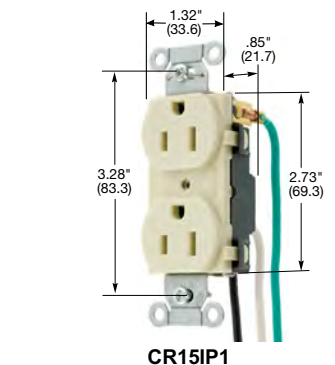

CR15IP1

Dimensions in Inches (mm)

15 and 20 Ampere, 125 Volts

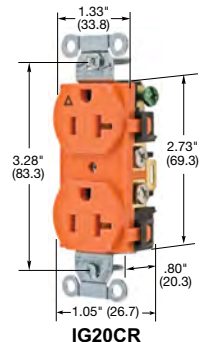
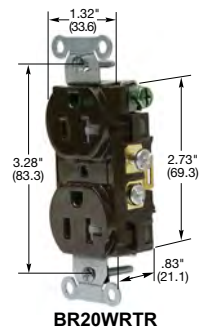
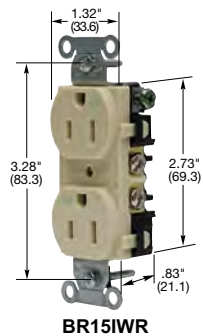
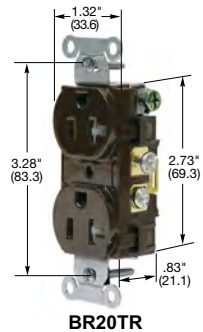
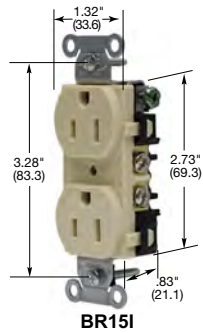

15A 125V
NEMA 5-15R
UL CSA
0.5 HP



20A 125V
NEMA 5-20R
UL CSA
1 HP

Commercial Specification Grade Receptacles

Duplex	Color	Catalog Number	
Smooth polycarbonate face, duplex, back and side wired.	Black	BR15BLK	BR20BLK
	Blue	BR15BL	BR20BL
	Brown	BR15	BR20
	Gray	BR15GRY	BR20GRY
	Green	BR15GN	BR20GN
	Ivory	BR15I	BR20I
	Light Almond	BR15LA	BR20LA
	Red	BR15R	BR20R
	White	BR15WHI	BR20WHI
	Tamper-Resistant, smooth polycarbonate face, duplex, back and side wired.	Black	BR15BLKTR
Blue		BR15BLTR	BR20BLTR
Brown		BR15TR	BR20TR
Gray		BR15GRYTR	BR20GRYTR
Green		BR15GNTR	BR20GNTR
Ivory		BR15ITR	BR20ITR
Light Almond		BR15LATR	BR20LATR
Red		BR15RTR	BR20RTR
White		BR15WHITR	BR20WHITR
Weather Resistant, smooth polycarbonate face, duplex, back and side wired.		Black	BR15BLKW
	Brown	BR15W	BR20W
	Gray	BR15GRYW	BR20GRYW
	Ivory	BR15IW	BR20IW
	Light Almond	BR15LAW	BR20LAW
	White	BR15WHIW	BR20WHIW
Weather and Tamper-Resistant, smooth polycarbonate face, duplex, back and side wired.	Black	BR15BLKWTR	BR20BLKWTR
	Brown	BR15WTR	BR20WTR
	Gray	BR15GRYWTR	BR20GRYWTR
	Ivory	BR15IWTR	BR20IWTR
	Light Almond	BR15LAWTR	BR20LAWTR
	White	BR15WHIWTR	BR20WHIWTR
Isolated ground ^A , smooth nylon face, duplex, side wired only.	Gray	IG15CRGRY	IG20CRGRY
	Ivory	IG15CRI	IG20CRI
	Light Almond	IG15CRLA	IG20CRLA
	Orange	IG15CR	IG20CR
	White	IG15CRWHI	IG20CRWHI
Isolated ground ^A , Style Line [®] decorator*, smooth nylon face, duplex, back and side wired.	Gray	IG15DRGRY	IG20DRGRY
	Ivory	IG15DRI	IG20DRI
	Light Almond	IG15DRLA	IG20DRLA
	Orange	IG15DR	IG20DR
	White	-	IG20DRWHI

Note: ^ASee section N for additional information on isolated ground devices.
See page A-47 for accessories.
See page Tech-10 for Tamper and Weather Resistant descriptions.
See section O for wallplates.

Dimensions in Inches (mm)

Straight Blade Devices



15 and 20 Ampere, 125 Volts



15A 125V
NEMA 5-15R
UL CSA
0.5 HP



20A 125V
NEMA 5-20R
UL CSA
1 HP

Commercial Specification Grade Receptacles

Style Line® Decorator	Color	Catalog Number	
Smooth polycarbonate face, Style Line® decorator duplex, back and side wired.	Black	DR15BLK	DR20BLK
	Brown	DR15	DR20
	Gray	DR15GRY	DR20GRY
	Green	DR15GN	DR20GN
	Ivory	DR15I	DR20I
	Light Almond	DR15LA	DR20LA
	Red	DR15R	DR20R
	White	DR15WHI	DR20WHI
Tamper-Resistant, Style Line® decorator duplex, smooth polycarbonate face, back and side wired.	Black	DR15BLKTR	DR20BLKTR
	Brown	DR15TR	DR20TR
	Gray	DR15GRYTR	DR20GRYTR
	Green	DR15GNTR	DR20GNTR
	Ivory	DR15ITR	DR20ITR
	Light Almond	DR15LATR	DR20LATR
	White	DR15WHITR	DR20WHITR
Weather and Tamper-Resistant, Style Line® decorator duplex, smooth polycarbonate face, back and side wired.	Black	DR15BLKWTR	DR20BLKWTR
	Brown	DR15WRTR	DR20WRTR
	Gray	DR15GRYWRTR	DR20GRYWRTR
	Ivory	DR15IWRTR	DR20IWRTR
	Light Almond	DR15LAWTR	DR20LAWTR
	White	DR15WHIWRTR	DR20WHIWRTR
Pre-wired receptacles, Style Line® decorator duplex, smooth polycarbonate face, back and side wired, self-grounding, 8" solid wire leads.	Black	DR15BLKP1	DR20BLKP1
	Brown	DR15P1	DR20P1
	Gray	DR15GRYP1	DR20GRYP1
	Ivory	DR15IP1	DR20IP1
	Light Almond	DR15LAP1	DR20LAP1
	White	DR15WHIP1	DR20WHIP1
Pre-wired receptacles, Style Line® decorator duplex, smooth polycarbonate face, back and side wired, self-grounding, 8" stranded wire leads.	Black	DR15BLKP2	DR20BLKP2
	Brown	DR15P2	DR20P2
	Gray	DR15GRYP2	DR20GRYP2
	Ivory	DR15IP2	DR20IP2
	Light Almond	DR15LAP2	DR20LAP2
	White	DR15WHIP2	DR20WHIP2
Pre-wired receptacles, Tamper-Resistant, Style Line® decorator duplex, smooth polycarbonate face, back and side wired, self-grounding, 8" solid wire leads.	Black	DR15BLKTRP1	DR20BLKTRP1
	Brown	DR15TRP1	DR20TRP1
	Gray	DR15GRYTRP1	DR20GRYTRP1
	Ivory	DR15ITRP1	DR20ITRP1
	Light Almond	DR15LATRP1	DR20LATRP1
	White	DR15WHITRP1	DR20WHITRP1
Pre-wired receptacles, Tamper-Resistant, Style Line® decorator duplex, smooth polycarbonate face, back and side wired, self-grounding, 8" stranded wire leads.	Black	DR15BLKTRP2	DR20BLKTRP2
	Brown	DR15TRP2	DR20TRP2
	Gray	DR15GRYTRP2	DR20GRYTRP2
	Ivory	DR15ITRP2	DR20ITRP2
	Light Almond	DR15LATRP2	DR20LATRP2
	White	DR15WHITRP2	DR20WHITRP2
Nightlight receptacle, two nightlight sources for a total of 0.5 Lumens, Tamper-Resistant shutters complies with NEC article 406.12, back and side wired	Ivory	DR15NLIV	-
	Light Almond	DR15NLLA	-
	White	DR15NLWH	-

Note: See page A-47 for accessories.
See page Tech-10 for Tamper and Weather Resistant descriptions.
See section O for wallplates.

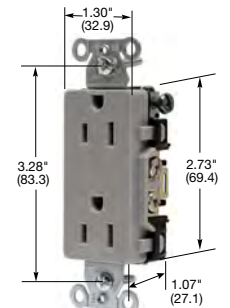

DR15GRY

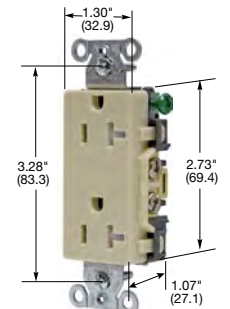

DR20ITR

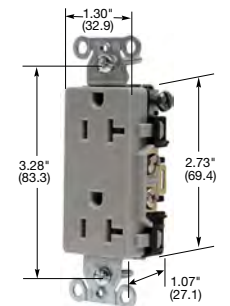

DR20GRYWRTR

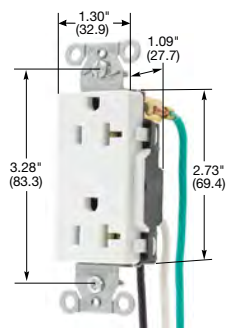

DR20WHITRP2

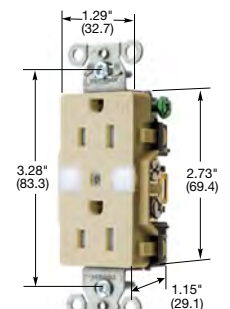

DR15NLIV

Dimensions in Inches (mm)

USB Charger Receptacles and Outlets



Weather Resistant Receptacle Features

- Meets Section 406.9 of NEC®
- 5 Amp, 5 Volt USB output
- Type A&C USB ports
- Power indicating green LED light



Weather Resistant USB Charger Duplex Receptacles

Description	Color	15A 125V	20A 125V
Type A&C USB Charger Receptacle, One Type A and one Type-C port configurations, high power 5 Amp, 5 Volt USB output, Tamper-Resistant USB ports rated 10,000 cycles; Commercial Grade	Black	USB15AC5BKWR	USB20AC5BKWR
	Brown	USB15AC5WR	USB20AC5WR
	Gray	USB15AC5GYWR	USB20AC5GYWR
	Ivory	USB15AC5IWR	USB20AC5IWR
	Light Almond	USB15AC5LAWR	USB20AC5LAWR
	White	USB15AC5WWR	USB20AC5WWR

Note: Outdoor circuits should be GFCI protected per national and local electric codes.

Commercial and Hospital Grade ● USB-C Power Delivery Charger Tamper-Resistant Duplex Receptacles



USB8300CPDW

Two Type-C port configurations, one USB-C Power Delivery port with up to 55 Watt output and one USB Type-C convenience port with up to 1.5 Amp, 5 Volt USB output, Tamper Resistant duplex receptacle, USB ports rated 10,000 cycles

Description	Color	Commercial		Hospital Grade	
		15A 125V	20A 125V	15A 125V	20A 125V
One Type-A and one Type-C port configurations, one USB-C Power Delivery port with up to 55 Watt output and one USB-A convenience port with up to 1.5 Amp, 5 Volt USB output, Tamper Resistant duplex receptacles, USB ports rated 10,000 cycles.	Black	USB15CPDBK	USB20CPDBK	USB8200CPDBK	USB8300CPDBK
	Brown	USB15CPD	USB20CPD	USB8200CPD	USB8300CPD
	Gray	USB15CPDGY	USB20CPDGY	USB8200CPDGY	USB8300CPDGY
	Ivory	USB15CPDI	USB20CPDI	USB8200CPDI	USB8300CPDI
	Lt. Almond	USB15CPDLA	USB20CPDLA	USB8200CPDLA	USB8300CPDLA
	Red	-	-	USB8200CPDR	USB8300CPDR
White	USB15CPDW	USB20CPDW	USB8200CPDW	USB8300CPDW	

Note: See page Tech-10 for Tamper-Resistant description.

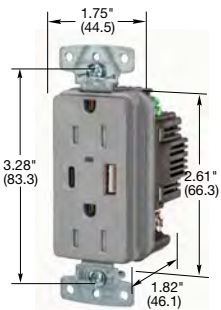

USB15ACPDGY

4 Port USB Charger Outlets



Description	Color	Catalog Number
USB Charger Outlets, 4 USB ports, two Type A & two Type-C ports, 5 Amp up to 9 Volt DC, Style Line® decorator.	Black	USB4ACBK
	Brown	USB4AC
	Gray	USB4ACGY
	Ivory	USB4ACI
	Light Almond	USB4ACLA
	White	USB4ACW

Switch Combo Outlets



Description	Color	Catalog Number
Switch Combo Outlet, two USB type 2.0 ports, 2.1 Amp, 5 Volt DC, Style Line® decorator.	Black	USB102BK
	Brown	USB102
	Gray	USB102GY
	Ivory	USB102I
	Light Almond	USB102LA
	White	USB102W

NEC® is a registered trademark of the National Fire Protection Association (NFPA).

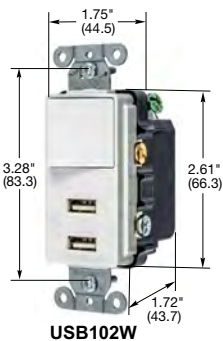

USB102W

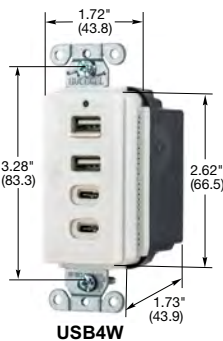

USB4W

Dimensions in Inches (mm)

Straight Blade Devices



15 and 20 Ampere, 125 Volts

4-PLEX®

Hospital Grade ● Receptacles

Description	Color	Catalog Number	
4 outlet high impact resistant Polycarbonate construction. Mount to 4 in. square box.	Brown	HBL415H	HBL420H
	Gray	-	HBL420HG
	Ivory	HBL415HI	HBL420HI
	Red	HBL415HR	HBL420HR
	White	HBL415HW	HBL420HW
4-PLEX surge protection receptacles with lights, 80 joules, 6.5kA peak current.	Blue	—	HBL420HS
	Ivory	—	HBL420HIS
	Red	—	HBL420HRS



15A 125V
NEMA 5-15R
UL CSA
0.5 HP



20A 125V
NEMA 5-20R
UL CSA
1 HP

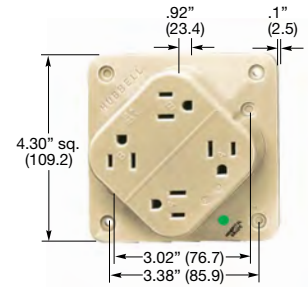

HBL415HI

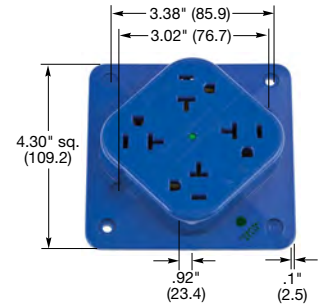

HBL420HS



15A 125V
NEMA 5-15R
UL CSA
0.5 HP



20A 125V
NEMA 5-20R
UL CSA
1 HP

4-PLEX® Receptacles

Over Size Robertson/Slotted Head Terminal Screws

Description	Color	Catalog Number	
Specification grade.	Black	HBL415BK	HBL420BK
	Brown	HBL415	HBL420
	Gray	HBL415GY	HBL420GY
	Ivory	HBL415I	HBL420I
	White	HBL415W	HBL420W
Isolated ground ^A .	Orange	IG415	IG420
Surge suppression.	Blue	HBL415S	HBL420S
	Ivory	HBL415IS	HBL420IS

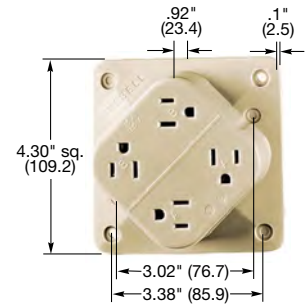

HBL415I

Note: ^ASee section N for additional information on isolated ground devices.

Horsepower ratings are AC only.

4-PLEX Receptacles are of a non-metallic design. Product is supplied with isolated ground symbol stickers.

Apply if needed. Mounts to 4-inch square box.

4-PLEX® Accessories

Description	Color	Catalog Number
4-PLEX adapter plates for 1- and 2-gang, device boxes.	Blue	HBL4APBL
	Brown	HBL4AP
	Gray	HBL4APGY
	Ivory	HBL4API
	Orange	HBL4APO
	Red	HBL4APR
	White	HBL4APW
4-PLEX Portable Box, 4 in. (101.6) square box with cord grip. Accepts up to .66 in. (16.8) diameter cord.	Black	HBL4PBBK
	Brown	HBL4PB
	Ivory	HBL4PBI

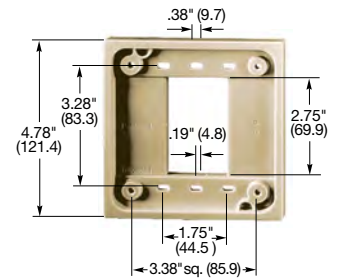

HBL4API

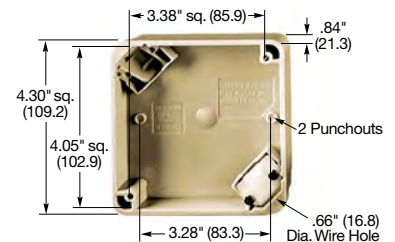

HBL4PBI

Note: 4-PLEX Box is not UL listed or CSA Certified. UL listing does not apply when 4-PLEX Receptacle is used with 4-PLEX Box in extension cord application. Supplied with one cord clamp.

Dimensions in Inches (mm)

NEC® is a registered trademark of the National Fire Protection Association (NFPA).

HUBBELL® Wiring Device-Kellems

Straight Blade Devices

Products at a Glance



Hospital Grade Plugs and Connectors

- Hospital Grade with green dot symbol
- Powerful offsetting cord grips clamp on individual conductors
- Transparent angled wiring entrance holes permit "straight in" conductor insertion
- Valise® devices have unique patented clamp type terminals, provide a superior electrical connection



Heavy Duty Insulgrip® Plugs and Connectors

- Beveled housing prevents snagging
- Integral VARI-SIZE® insert adjusts to a wide range of cord sizes: .23 to .72 inch (5.8 to 18.3).
- Individually molded face for each blade configuration keeps debris out of plug interior
- Ribbed nylon housing is impact and chemical resistant



Watertight and Dust Tight Devices

- Multiple "U-Drive" fast lead body assembly screws
- Color coded Kellems GOTCHA® rings provide increased cord retention
- Powerful nylon cord grip prevents strain on terminals
- Dust and moisture seal keeps out liquids, metal filings and other foreign materials
- Closure plug seals connector body when disconnected from plug

Straight Blade Devices

Features and Benefits

Insulgrip® 15 and 20 Ampere Plugs and Connector Bodies

Insulgrip products are synonymous with Hubbell's ongoing commitment to discovering ways to make products safer and last longer.

By encasing wiring devices in tough nylon housings, Insulgrip devices ensure high impact, heat, and chemical resistance while insulating current-carrying components from the user for maximum safety.

- The Insulgrip's cord gripping design clamps conductors, not just the cable jacket, making it the industry's most powerful cord grip with superior strain relief.
- Each Insulgrip device is manufactured with roomy, separate wiring chambers to insulate conductors and an individually molded face to keep out dust and debris that can cause contamination over time.

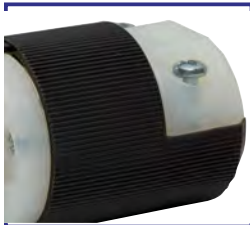
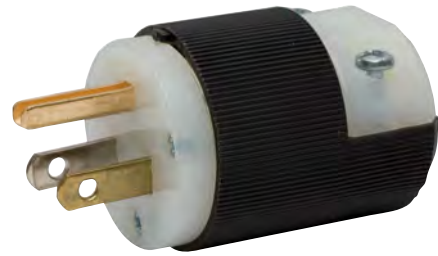

Housing Design

- Ribbed nylon housing provides a secure grip that's impact and chemical resistant
- Beveled housing prevents snagging when dragged across uneven surfaces
- Individually molded face for each blade configuration keeps debris out of plug interior



Internal Design

- Powerful cord grips clamp on individual conductors and outer cord jacket to prevent strain on terminations
- Individual wiring terminals are completely enclosed in their own separate chambers



Cord Range

- Integral VARI-SIZE® insert adjusts to a wide range of cord sizes: .230"-.720" (5.8-18.3)
- VARI-SIZE® pointer set to "smaller than gauge" position. Cord diameter range is .230"-.360" (5.8-9.0). Accepts slotted and Phillips head drivers



Assembly

- Multiple drive screw heads provide screwdriver versatility. Pocketed recess for cord grip screws deters slippage of the screwdriver



Identification

- Catalog number is visible on the device while in use for easy identification



Visual Verification

- Transparent angled wiring entrance holes permit "straight in" conductor insertion and quick visual verification for terminations

Straight Blade Devices

Features and Benefits

Valise® Plugs and Connector Bodies

Hubbell Valise plugs go together in seconds but stay together securely for reliable long-term operation. Eight loadbearing, locking lugs in the impact- and crush-resistant nylon body assure a positive grip. Devices feature patented “wire bundling” terminals that are easy to wire and provide positive, reliable terminations

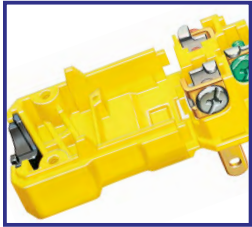

Housing Design

- Removable cord inserts to accommodate a wide range of cord sizes, .220"-.660" (5.6-16.8)
- Powerful cord grips prevent conductor slippage and strain on wiring terminals
- Eight specially designed load bearing locking lugs insure a positive fit as the blade holder and sides are closed

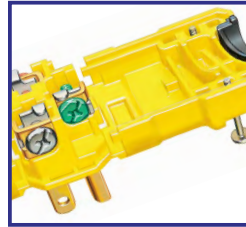

Internal Design

- Unique patented clamp-type terminals provide a superior electrical connection by “bundling” the conductor strands when clamps are tightened
- Nylon webs are provided to make wiring quick and easy during assembly
- Two captive multiple drive assembly screws

Elastogrip® High Visibility Yellow Plugs and Connectors

Hubbell straight blade devices, female connector body, Elastogrip watertight, industrial/commercial grade, 2-pole 3-wire grounding, 15A 125V, NEMA 5-15R, yellow, single pack. Tough nylon body provides superior resistance in harsh abusive environments. IP55 suitability when closure plug inserted or when installed and used properly with mating watertight plug.



Watertight Plug Housing Design

- Thermoplastic elastomer housing resists weathering caused by ultraviolet rays and ozone better than rubber; also oil and chemical resistant
- Nylon compression nut keeps water and dust from getting into the body around the cord

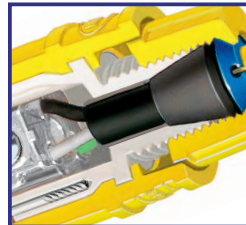

Watertight Plug Internal Design

- Three separate transparent wiring chambers allow for visual inspection
- Multiple drive “U-Drive” fast lead body assembly screws
- Neoprene bushing keeps water and dust out
- Color coded Kellems GOTCHA® rings provide increased cord retention



Watertight Connector Housing Design

- Closure plug seals connector body when disconnected from plug
- Integral weatherproofing shroud seals connection between plug and connector

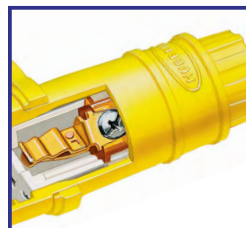

Watertight Connector Internal Design

- Pretensioned “bypass” design female contacts for abuse resistance and reliability
- Nylon compression nut keeps water and dust from getting into the body around the cord



Dust Tight Plug Housing Design

- Thermoplastic elastomer housing
- Powerful nylon cord grip prevents strain on terminals



Dust Tight Plug Internal Design

- Multiple drive “U-Drive” fast lead body assembly screws
- Dust and moisture seal keeps out liquids, metal filings and other foreign materials

IP20
SUITABILITY



15A 125V
NEMA 5-15P
UL CSA



20A 125V
NEMA 5-20P
UL CSA

Hospital Grade Plugs

Insulgrip®

Description	Cord Diameter	Catalog Number	
Black and white nylon.	.230"-.720" (5.8-18.3)	HBL8215C	HBL8315C
Black and white, spring termination	.230"-.720" (5.8-18.3)	HBL8215CST	HBL8315CST
Transparent housing.	.230"-.720" (5.8-18.3)	HBL8215CT	HBL8315CT
Transparent housing, spring termination	.230"-.720" (5.8-18.3)	HBL8215CTST	HBL8315CTST
8 position angle plug, transparent housing.	.250"-.655" (6.4-16.6)	HBL8215CAT*	HBL8315CAT*

Valise®

Description	Cord Diameter	Catalog Number	
White nylon.	.300"-.660" (7.6-16.8)	HBL8115V	HBL8364V
Insulation displacement, white nylon.	.300"-.360" (7.6-9.1)	HBL8013V*	-

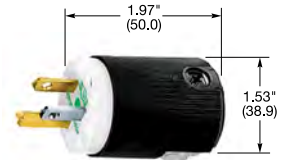

HBL8215C



HBL8215CTST

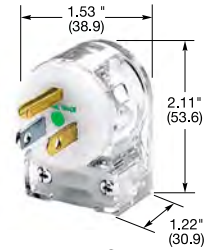

HBL8215CAT



HBL8115V



HBL8219C

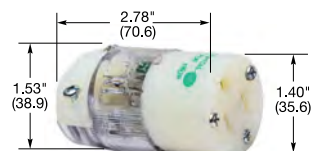

HBL8219CT

IP20
SUITABILITY



15A 125V
NEMA 6-15R
UL CSA
0.5 HP



20A 125V
NEMA 6-20R
UL CSA
1 HP

Hospital Grade Connector Bodies

Insulgrip®

Description	Cord Diameter	Catalog Number	
Black and white nylon.	.230"-.720" (5.8-18.3)	HBL8219C	HBL8319C
Black and white, spring termination	.230"-.720" (5.8-18.3)	HBL8219CST	HBL8319CST
Transparent housing.	.230"-.720" (5.8-18.3)	HBL8219CT	HBL8319CT
Transparent housing, spring termination	.230"-.720" (5.8-18.3)	HBL8219CTST	HBL8319CTST

Valise®

Description	Cord Diameter	Catalog Number	
White nylon.	.300"-.660" (7.6-16.8)	HBL8119V	-

Note: *Not Fed. Spec. Listed.
See page A-48 for accessories.

Hospital Grade Plugs

Valise®

Description	Cord Diameter	Catalog Number	
Valise plug, white nylon.	.300"-.660" (7.6-16.8)	HBL8666V	HBL8464V

Note: HP ratings listed above are based on 208 to 240V AC only.

IP20
SUITABILITY



15A 250V
NEMA 6-15P
UL CSA
1.5 HP



20A 250V
NEMA 6-20P
UL CSA
2 HP

Hospital Grade Connector Bodies

Valise®

Description	Cord Diameter	Catalog Number	
White nylon.	.300"-.660" (7.6-16.8)	-	HBL8469V



HBL8119V



HBL8666V

Dimensions in Inches (mm)



HBL5266C



HBL5266CST

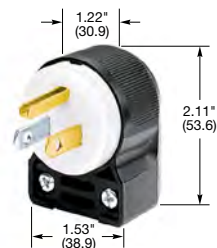

HBL5266CA



HBL1447

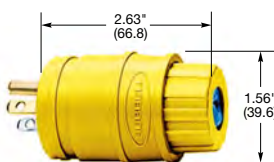

HBL14W47



HBL5965VY



HBL5966VBLK

Dimensions in Inches (mm)

IP20
SUITABILITY



15A 125V
NEMA 5-15P
UL CSA



20A 125V
NEMA 5-20P
UL CSA

Plugs

Insulgrip®

Description	Cord Diameter	Catalog Number	
Black and white nylon.	.230"-.720" (5.8-18.3)	HBL5266C	HBL5366C
Black and white, spring termination	.230"-.720" (5.8-18.3)	HBL5266CST	HBL5366CST
Blue and white nylon.	.230"-.720" (5.8-18.3)	HBL5266CBL	-
Black nylon extra large cord clamp.	.360"-.720" (9.1-18.3)	HBL5266EBK	HBL5366EBK
Black, spring termination	.230"-.720" (5.8-18.3)	HBL5266CBKST	HBL5366CBKST
Corrosion resistant yellow nylon.	.230"-.720" (5.8-18.3)	HBL52CM66C	HBL53CM66C
Corrosion resistant yellow nylon, spring termination		HBL52CM66CST	HBL53CM66CST
8-position angle plug, black and white nylon.	.325"-.655" (8.3-16.6)	HBL5266CA	HBL5366CA
8-position angle plug, transparent enclosure.	.325"-.655" (8.3-16.6)	HBL5266CAT	-
Anchor lock, black and white nylon.	.230"-.720" (5.8-18.3)	HBL5280C*	-
Anchor lock, corrosion resistant yellow nylon.	.230"-.720" (5.8-18.3)	HBL52CM80C*	-
Finger grip, black neoprene, combination screws. CSA only.	.31"-.43" (7.9-10.9)	HBL5921	-
Fusible, black vinyl housing, slotted screws. CSA only.	.296"-.625" (7.5-15.9)	HBL5299	-

Elastogrip®

Description	Cord Diameter	Catalog Number	
Yellow elastomer, dust tight. IP20 SUITABILITY.	.300"-.655" (7.6-16.6)	HBL1447	HBL1433
Yellow elastomer, watertight. IP20 and IP55 SUITABILITY.	.300"-.655" (7.6-16.6)	HBL14W47**	HBL14W33**
Yellow elastomer, watertight. IP65, 66, 67 SUITABILITY.	.375"-.625" (9.5-15.9)	HBL14W47A	HBL14W33A

Valise®

IP20
SUITABILITY

Description	Cord Diameter	Catalog Number	
Yellow nylon.	.220"-.660" (5.6-16.8)	HBL5965VY	HBL5364VY
Black nylon.	.220"-.660" (5.6-16.8)	HBL5965VBLK	HBL5364VBLK
Gray nylon.	.220"-.660" (5.6-16.8)	HBL5965VGY	-
Orange nylon, sold in bulk pack of 50.	.220"-.660" (5.6-16.8)	HBL515PVO	-
Insulation displacement terminals, black nylon.	.230"-.360" (5.8-9.1)	HBL5966VBLK	-
Insulation displacement terminals, yellow nylon.	.230"-.360" (5.8-9.1)	HBL5966VY	-

Note: *UL Component Listed only. Not for general use applications.

**Watertight plugs IP55 suitability when installed and used properly with mating Elastogrip watertight connector bodies.

Horsepower ratings listed are AC only.

See page A-48 for accessories.



15A 125V
NEMA 5-15R
UL CSA
0.5 HP



20A 125V
NEMA 5-20R
UL CSA
1 HP

IP20
SUITABILITY

Connector Bodies

Insulgrip®

Description	Cord Diameter	Catalog Number	
Black and white nylon.	.230"-.720" (5.8-18.3)	HBL5269C	HBL5369C
Black and white, spring termination	.230"-.720" (5.8-18.3)	HBL5269CST	HBL5369CST
Blue and white nylon.	.230"-.720" (5.8-18.3)	HBL5269CBL	—
Black nylon extra large cord clamp.	.360"-.720" (9.1-18.3)	HBL5269EBK	HBL5369EBK
All black, spring termination	.230"-.720" (5.8-18.3)	HBL5269CBKST	HBL5369CBKST
Corrosion resistant yellow nylon.	.230"-.720" (5.8-18.3)	HBL52CM69C	HBL53CM69C

Note: See page A-48 for accessories.

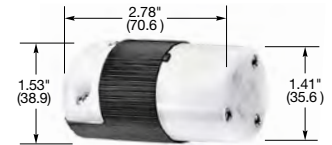

HBL5269C

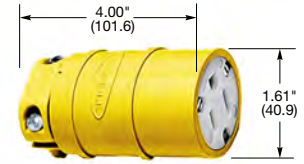

HBL1547

Elastogrip®

Description	Cord Diameter	Catalog Number	
Yellow elastomer, dust tight. IP20 SUITABILITY.	.300"-.655" (7.6-16.6)	HBL1547	HBL1533
Yellow elastomer, watertight. IP20 and IP55 SUITABILITY.	.300"-.655" (7.6-16.6)	HBL15W47*	HBL15W33*
Yellow elastomer, watertight. IP65, 66, 67 SUITABILITY.	.375"-.625" (9.5-15.9)	HBL15W47A	HBL15W33A

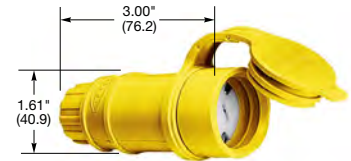

HBL15W47

Valise®

IP20
SUITABILITY

Description	Cord Diameter	Catalog Number	
Yellow nylon.	.220"-.660" (5.6-16.8)	HBL5969VY	HBL5369VY
Black nylon.	.220"-.660" (5.6-16.8)	HBL5969VBLK	HBL5369VBK
Gray nylon.	.220"-.660" (5.6-16.8)	HBL5969VGY	—
Orange nylon, sold in bulk pack of 50.	.220"-.660" (5.6-16.8)	HBL515CVO	—
Insulation displacement terminals, black nylon.	.230"-.360" (5.8-9.1)	HBL5963VBK	—
Insulation displacement terminals, yellow nylon.	.230"-.360" (5.8-9.1)	HBL5963VY	—

Note: *Watertight connectors IP55 suitability when closure plug inserted or when installed and used properly with mating Elastogrip watertight plug. Connector bodies are not HP rated. See page A-48 for accessories.

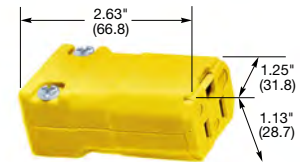

HBL5969VY

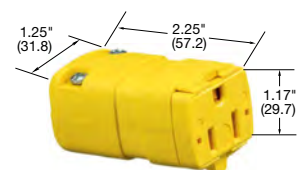

HBL5963VY

For quick visual identification of circuits or configurations.

Colored Cord Clamps*

Description	Color	Catalog Number
For use with 15A and 20A, 2 pole/3 wire, insulgrip plugs and connectors with cord diameter range of .230"-.720" (5.8-18.3) only.	Blue	HBLCORDCLAMPBL
	Green	HBLCORDCLAMPGN
	Orange	HBLCORDCLAMPOR
	Purple	HBLCORDCLAMPPP
	Red	HBLCORDCLAMPRR
	Yellow	HBLCORDCLAMPY

Note: *Clamp only. Contains no screws. Order in increments of 10. Not UL Listed or CSA Certified.



Dimensions in Inches (mm)

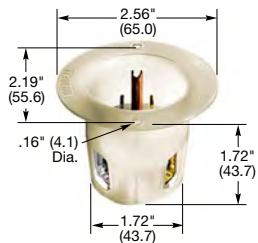

HBL5278C

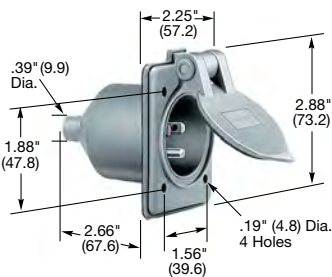

HBL61CM64

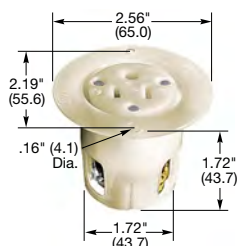

HBL5279C

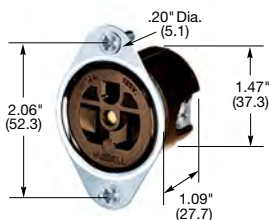

HBL5256

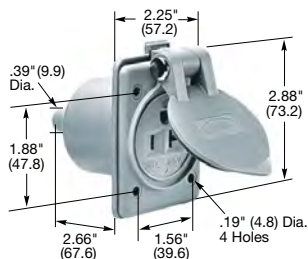

HBL61CM65



15A 125V
NEMA 5-15P
UL CSA



20A 125V
NEMA 5-20P
UL CSA

Flanged Inlets

Description	Catalog Number	
Nylon casing, back wired.	HBL5278C	HBL5378C
Weatherproof, gray, with lift cover and multiple drive screws.	HBL61CM64	—
Weatherproof, black, with lift cover and boot, multiple drive screws.	HBL61CM64BK	—
Stainless steel flange, phenolic body, miniature style, for molded on connectors only, multiple drive screws.	HBL5240*	—

*Note: *Specially designed to accept "molded-on" connector bodies. Catalog number HBL5240 will not accept re-wireable size connector bodies listed in this catalog or molded connectors having a "rejection obstruction" as required by Underwriters Laboratories Inc. standard #817 cord sets and power supply cords" effective 7/1/81. See pages A-47 and A-48 for accessories.*



15A 125V
NEMA 5-15R
UL CSA
0.5 HP



20A 125V
NEMA 5-20R
UL CSA
1 HP

Flanged Receptacles

Description	Catalog Number	
Nylon casing, back wired.	HBL5279C	HBL5379C
Stainless steel flange, phenolic body, covered terminals, multiple drive screws.	HBL5279	—
Stainless steel flange, brown phenolic (mounting screws packed separately).	HBL5256	—
Weatherproof, gray nylon, with lift cover and boot, multiple drive screws.	—	HBL61CM65

Note: See pages A-47 and A-48 for accessories.

Dimensions in Inches (mm)



**15A 250V
NEMA 6-15P
UL CSA
1.5 HP**



**20A 250V
NEMA 6-20P
UL CSA
2 HP**

Plugs

Description	Cord Diameter	Catalog Number	
Insulgrip® Plug, black and white nylon.	.230"-.720" (5.8-18.3)	HBL5666C	HBL5466C
Insulgrip plug, black and white, spring termination	.230"-.720" (5.8-18.3)	HBL5666CST	HBL5466CST
Insulgrip® Plug, corrosion resistant, yellow nylon.	.230"-.720" (5.8-18.3)	HBL56CM66C	HBL54CM66C
Insulgrip plug, corrosion resistant, spring termination, yellow	.230"-.720" (5.8-18.3)	HBL56CM66CST	HBL54CM66CST
8-Position Insulgrip® Angle Plug, black and white nylon.	.325"-.655" (8.3-16.6)	HBL5666CA	HBL5466CA
Valise® Plug, yellow nylon.	.220"-.660" (5.6-16.8)	HBL5666VY	HBL5464VY

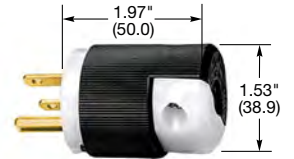

HBL5666C



HBL5666CST

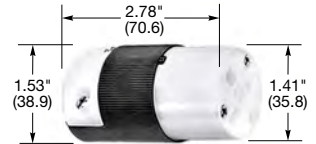

HBL5669C

Connector Bodies

Description	Cord Diameter	Catalog Number	
Insulgrip® Connector Body, black and white nylon, multiple drive screws.	.230"-.720" (5.8-18.3)	HBL5669C	HBL5469C
Insulgrip Connector Body, Black and White, Spring Termination	.230"-.720" (5.8-18.3)	HBL5669CST	HBL5469CST
Valise® Connector Body, yellow nylon.	.220"-.660" (5.6-16.8)	HBL5669VY	HBL5469VY

Note: See page A-48 for accessories.



**15A 250V
NEMA 6-15R
UL CSA**



**20A 250V
NEMA 6-20R
UL Listed**



HBL5669C

Insulgrip® Flanged Inlets

Description	Catalog Number	
Nylon casing, back wired.	HBL5678C	HBL5478C

Note: Flanged inlets are not HP rated.
See page A-48 for accessories.



**15A 250V
NEMA 6-15P
UL CSA**



**20A 250V
NEMA 6-20P
UL CSA**

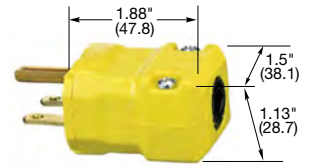

HBL5666VY

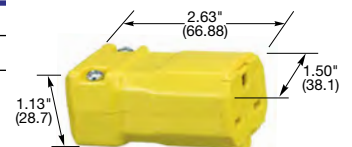

HBL5669VY

Flanged Receptacles

Description	Catalog Number	
Nylon casing, multiple drive screws.	HBL5679C	HBL5479C
Stainless steel flange, brown phenolic housing (mounting screws packaged separately).	HBL5656	-

Note: Connector bodies are not HP rated.
See pages A-47 and A-48 for accessories.



**15A 250V
NEMA 6-15R
UL CSA**



**20A 250V
NEMA 6-20R
UL Listed**

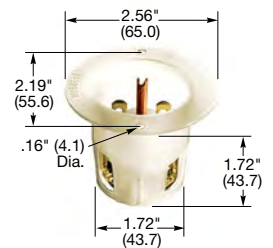

HBL5678C

For quick visual identification of circuits or configurations.

Colored Cord Clamps*

Description	Color	Catalog Number
For use with 15A and 20A, 2 pole/3 wire, insulgrip plugs and connectors with cord diameter range of .230"-.720" (5.8-18.3) only.	Blue	HBLCORDCLAMPBL
	Green	HBLCORDCLAMPGN
	Orange	HBLCORDCLAMPOR
	Purple	HBLCORDCLAMPPP
	Red	HBLCORDCLAMPR
	Yellow	HBLCORDCLAMPY

Note: *Clamp only. Contains no screws. Order in increments of 10. Not UL Listed or CSA Certified.



Dimensions in Inches (mm)

Straight Blade Devices

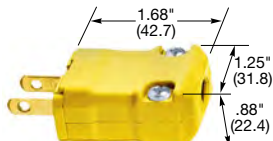

HBL5865VY

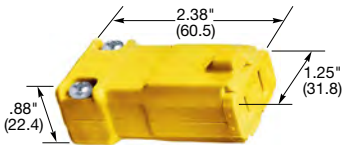

HBL5869VY

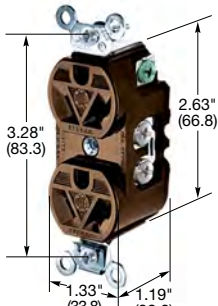

HBL5302

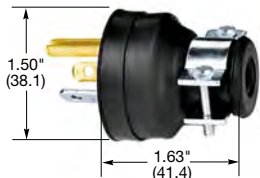

HBL5929



HBL9758VY

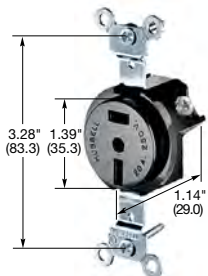

HBL5552B



15A, 125V, 2 Pole, 2 Wire Non-Grounding, Valise® Plugs

IP20
SUITABILITY



15A 125V
NEMA 1-15R
UL CSA
0.5 HP



15A 125V
NEMA 1-15P
UL CSA
0.5 HP

Description	Cord Diameter	Catalog Number
Yellow nylon, non-polarized.	.218"-.385" (5.5-9.8)	— HBL5865VY
Yellow nylon, polarized.	.218"-.385" (5.5-9.8)	— HBL5866VY
Black nylon, polarized.	Type 17/2 "SVT" cord	— HBL5867VBLK

Valise® Connector Bodies

Description	Cord Diameter	Catalog Number
Yellow nylon.	.218"-.385" (5.5-9.8)	HBL5869VY —



15A, 277V AC, 2 Pole, 3 Wire Grounding, Plugs



15A 277V AC
NEMA 7-15R
UL CSA
2 HP



15A 277V AC
NEMA 7-15P
2 HP

Description	Cord Diameter	Catalog Number
Finger grip, black elastomer.	.31"-.43" (7.9-10.9)	— HBL5929*

Receptacles and Connector Bodies

Description	Cord Diameter	Catalog Number
Receptacle, flush duplex, brown, back and side wired.	—	HBL5302 —
Connector Body, phenolic and steel body.	.296"-.625" (7.5-15.9)	HBL5324 —

Note: *Not UL Listed.
Horsepower ratings are AC only.
See pages A-47 and A-48 for accessories.



20A, 250V, 2 Pole, 2 Wire Non-Grounding, Valise® Plugs

IP20
SUITABILITY



20A 250V
NEMA 2-20R
UL Listed
2 HP



20A 250V
NEMA 2-20P
UL Listed
2 HP

Description	Cord Diameter	Catalog Number
Yellow nylon.	.220"-.660" (5.6-16.8)	— HBL9758VY

Receptacle, Single

Description	Catalog Number
Black phenolic.	HBL5552B —

Note: Horsepower ratings are AC only and apply to plugs and receptacles only.
See pages A-47 and A-48 for accessories.

Dimensions in Inches (mm)

Straight Blade Devices



20A, 125/250V, 3 Pole, 3 Wire Non-Grounding, Receptacles and Plugs

IP20
SUITABILITY



20A 125V/250V
NEMA 10-20R
UL Listed
2(1) HP



20A 125V/250V
NEMA 10-20P
UL Listed
2(1) HP

Description	Cord Diameter	Catalog Number
Receptacle, black phenolic.	–	HBL6810
Plug, Insulgrip®, nylon.	.385"-.780" (9.8-19.8)	HBL9977C

Note: Horsepower ratings listed above are AC only.
Horsepower ratings not in parentheses are phase to phase (208 to 240V AC).
Those in parentheses are phase to neutral (120V AC).
See pages A-47 and A-48 for accessories.

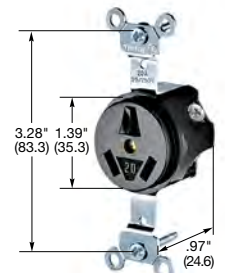

HBL6810



20A, 125/250V, 3 Pole, 4 Wire Grounding, Receptacles and Plugs

IP20
SUITABILITY



20A 125V/250V
NEMA 14-20R
UL CSA
2(1) HP



20A 125V/250V
NEMA 14-20P
UL CSA
2(1) HP

Description	Cord Diameter	Catalog Number
Receptacle, black nylon body, back and side wired.	–	HBL8410
Plug, nylon, angle 4-position.	.390"-.775" (9.9-19.7)	HBL8411C

See pages A-47 and A-48 for accessories.



HBL9977C

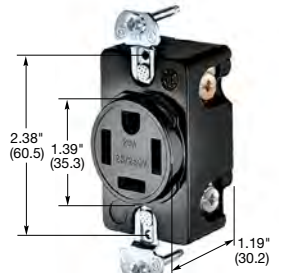

HBL8410



20A, 3Ø 250V AC, 3 Pole, 4 Wire Grounding, Receptacles and Plugs

IP20
SUITABILITY



20A 3Ø 250V AC
NEMA 15-20R
UL CSA
3 HP



20A 3Ø 250V AC
NEMA 15-20P
UL CSA
3 HP

Description	Cord Diameter	Catalog Number
Receptacle, black nylon body, back and side wired.	–	HBL8420
Plug, nylon, angle 4-position.	.390"-.775" (9.9-19.7)	HBL8421C

Note: Horsepower ratings listed above are AC only.
Horsepower ratings not in parentheses are phase to phase (208 to 240V AC).
Horsepower ratings in parentheses are phase to neutral (120V AC).
See pages A-47 and A-48 for accessories.



HBL8411C



20A, 3ØY 120/208V AC, 4 Pole, 4 Wire Non-Grounding, Receptacles and Plugs

IP20
SUITABILITY



20A 3ØY 120/208V AC
NEMA 18-20R
UL Listed
2 HP



20A 3ØY 120/208V AC
NEMA 18-20P
UL Listed
2 HP

Description	Cord Diameter	Catalog Number
Receptacle, black nylon body.	–	HBL7250
Plug, nylon, angle, 4-position.	.390"-.775" (9.9-19.7)	HBL7251C

Note: Horsepower ratings are phase to phase (208 to 240V AC).
Weatherproof boots for plugs not available.
See pages A-47 and A-48 for accessories.

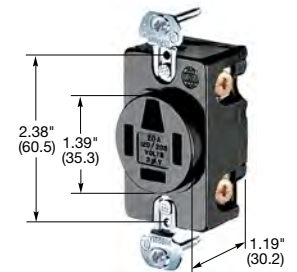

HBL7250

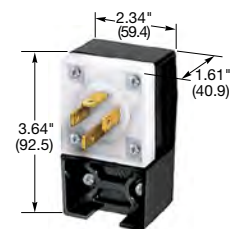

HBL7251C

Dimensions in Inches (mm)

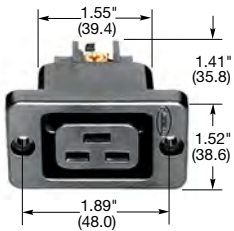

H320R



Receptacle IEC 320 Compatible

Description
20/16A 250V AC IEC straight blade.
For Ring Terminal connection.

Note: *Not UL Listed.

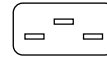

Description	Catalog Number
20/16A 250V AC IEC straight blade.	H320R
For Ring Terminal connection.	H320RRT*



H320C



Connector

IP20
SUITABILITY

Description
20/16A 250V AC IEC straight blade.

Description	Catalog Number
20/16A 250V AC IEC straight blade.	H320C

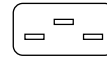

H320P



Plug IEC 320 Compatible

IP20
SUITABILITY

Description
20/16A 250V AC IEC straight blade.

Description	Catalog Number
20/16A 250V AC IEC straight blade.	H320P

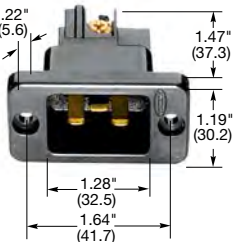

H320B



Inlets

Description
20/16A 250V AC IEC straight blade.
20/16A 250V AC IEC straight blade with retention clamp.

Description	Catalog Number
20/16A 250V AC IEC straight blade.	H320B
20/16A 250V AC IEC straight blade with retention clamp.	H320BL

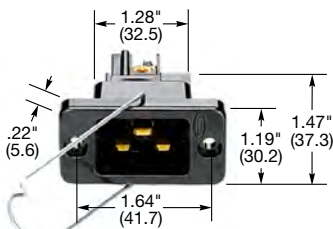

H320BL

Dimensions in Inches (mm)

Straight Blade Devices



Acceptor®

Hazardous Location Receptacles

Description	Catalog Number	
Explosion and dust ignition proof.	-	UGRO20231
Class I, Div. 1 & 2, Groups C, D	-	UGRA20231*
Class II, Div. 1 & 2, Groups F, G		
Class III		
NEMA® 3, 7 B C D, 9 F G		

Note: *UGRA version includes an adapter plate for mounting to Crouse-Hinds® EDS series and Appleton® EFD series back boxes.
UL Listed for Class 1, Div. 2, Groups B, C, D.



15A 125V
NEMA 5-15R
UL CSA
0.5 HP



20A 125V
NEMA 5-20R
UL CSA
1 HP



UGRO20231



Acceptor®

Hazardous Location Plugs

Description	Catalog Number	
Explosion and dust ignition proof.	UGP15231	UGP20231
Class I, Div. 1 & 2, Groups B, C, D		
Class II, Div. 1 & 2, Groups E, F, G		
Class III		
NEMA® 3, 7 B C D, 9 F G		



15A 125V
NEMA 5-15P
UL CSA



20A 125V
NEMA 5-20P
UL CSA

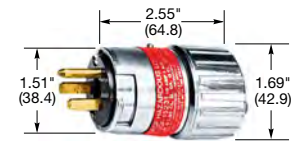

UGP15231

SWB Series Boxes

Hub Size	1-Gang Dead End	1-Gang Feed Thru
½ in. NPT	SWB1	SWB4
¾ in. NPT	SWB2	SWB5
Class I, Div. 1 & 2, Groups C, D		
Class II, Div. 1 & 2, Groups E, F, G		
Class III		
NEMA® 7 C D, 9 E F G		

Note: SWB series boxes will only accommodate Acceptor Series receptacles, not standard weatherproof covers.

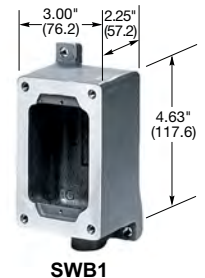

SWB1

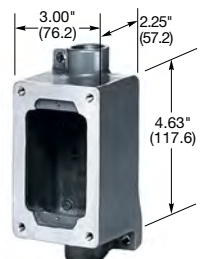

SWB5

NEMA® is a registered trademark of the National Electrical Manufacturers Association.

Dimensions in Inches (mm)

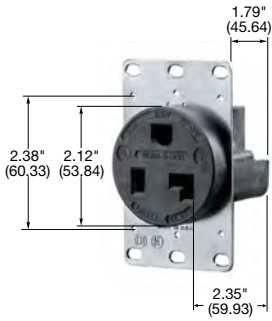

HBL9308

30A, 125V, 2 Pole, 3 Wire Grounding, Receptacles and Plugs

IP20
SUITABILITY



30A 125V
NEMA 5-30R
UL CSA
2 HP



30A 125V
NEMA 5-30P
UL CSA
2 HP

Description	Cord Diameter	Catalog Number
Receptacle, black RTP.	-	HBL9308
Receptacle, orange, isolated ground ^A .	-	IG9308
Plug, nylon, angle, 4-position.	.625"-1.187" (15.9-30.1)	HBL9309*

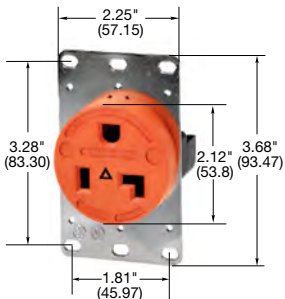

IG9308

30A, 125V, 2 Pole, 3 Wire Grounding, Receptacles and Plugs



30A 125V
NEMA TT-30R
UL Listed
2 HP



30A 125V
NEMA TT-30P
UL Listed
2 HP

Description	Cord Diameter	Catalog Number
Receptacle, black RTP. Travel Trailer use only.	-	HBLTT30R
Plug, nylon, angle. Travel Trailer use only.	.625"-1.187" (15.9-30.1)	HBLTT30P

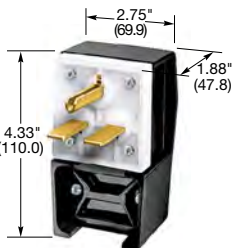

HBL9331

30A, 250V, 2 Pole, 3 Wire Grounding, Receptacles and Plugs

IP20
SUITABILITY

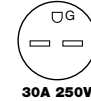

30A 250V
NEMA 6-30R
UL CSA
2 HP

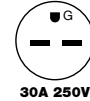

30A 250V
NEMA 6-30P
UL CSA
2 HP

Description	Cord Diameter	Catalog Number
Receptacle, black RTP.	-	HBL9330
Receptacle, orange, isolated ground ^A .	-	IG9330
Plug, nylon, angle, 4-position	.625"-1.187" (15.9-30.1)	HBL9331*

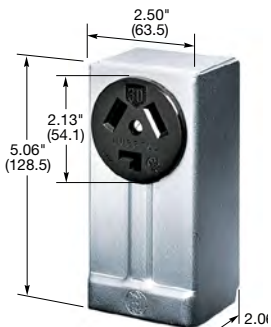

HBL9395

30A, 277V AC, 2 Pole, 3 Wire Grounding, Receptacles and Plugs

IP20
SUITABILITY



30A 277V AC
NEMA 7-30R
UL CSA
3 HP



30A 277V AC
NEMA 7-30P
UL CSA
3 HP

Description	Cord Diameter	Catalog Number
Receptacle, black RTP.	-	HBL9315
Plug, nylon, angle, 4-position.	.625"-1.187" (15.9-30.1)	HBL9319*

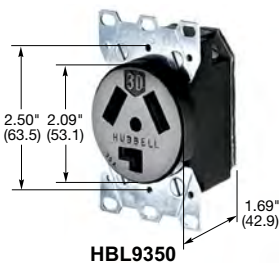

HBL9350

30A, 125/250V, 3 Pole, 3 Wire Non-Grounding, Receptacles and Plugs

IP20
SUITABILITY

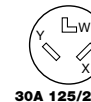

30A 125/250V
NEMA 10-30R
UL Listed
2(2) HP



30A 125/250V
NEMA 10-30P
UL Listed
2(2) HP

Description	Cord Diameter	Catalog Number
Receptacle, black phenolic.	-	HBL9350
Receptacle, surface mount aluminum housing.	-	HBL9395
Plug, Insulgrip®, nylon.	.625"-1.00" (15.9-25.4)	HBL9337C
Plug, nylon, angle, 4-position.	.625"-1.187" (15.9-30.1)	HBL9333

Note: RTP is an abbreviation for reinforced thermoplastic polyester.
^ASee section N for additional information on isolated ground devices.
^{*}Not Fed. Spec. Listed.
 See page A-49 for accessories.

Dimensions in Inches (mm)

30A, 125/250V, 3 Pole, 4 Wire Grounding, Receptacles and Plugs

IP20
SUITABILITY



**30A 125/250V
NEMA 14-30R
2(2) HP**



**30A 125/250V
NEMA 14-30P
2(2) HP**

Description	Cord Diameter	Catalog Number
Receptacle, black RTP.	-	HBL9430A
Plug, nylon.	.625"-1.310" (15.9-33.3)	- HBL9431C
Plug, nylon, angle, 4-position.	.625"-1.310" (15.9-33.3)	- HBL9432C



30A, 3Ø 250V AC, 3 Pole, 4 Wire Grounding, Receptacles and Plugs

IP20
SUITABILITY



**30A 3Ø 250V AC
NEMA 15-30R
3 HP**



**30A 3Ø 250V AC
NEMA 15-30P
3 HP**

Description	Cord Diameter	Catalog Number
Receptacle, black RTP.	-	HBL8430A
Plug, nylon.	.625"-1.310" (15.9-33.3)	- HBL8431C
Plug, nylon, angle, 4-position.	.625"-1.310" (15.9-33.3)	- HBL8432C



30A, 3ØY 120/208V AC, 4 Pole, 4 Wire Non-Grounding, Receptacles and Plugs

IP20
SUITABILITY



**30A 3ØY
120/208V AC
NEMA 18-30R
UL Listed
3 HP**



**30A 3ØY
120/208V AC
NEMA 18-30P
UL Listed
3 HP**

Description	Cord Diameter	Catalog Number
Receptacle, black RTP.	-	HBL8330A
Plug, nylon.	.625"-1.310" (15.9-33.3)	- HBL8331C

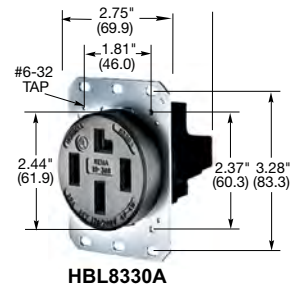

Note: RTP is an abbreviation for reinforced thermoplastic polyester.
See pages A-49 and A-50 for accessories.

Dimensions in Inches (mm)

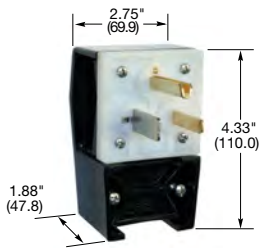

HBL9361

50A, 125V, 2 Pole, 3 Wire Grounding, Receptacles and Plugs

IP20
SUITABILITY



**50A 125V
NEMA 5-50R
UL CSA
2 HP**



**50A 125V
NEMA 5-50P
UL CSA
2 HP**

Description	Cord Diameter	Catalog Number
Receptacle, black RTP.	-	HBL9360
Plug, nylon, angle, 4-position.	.625"-1.187" (15.9-30.2)	HBL9361

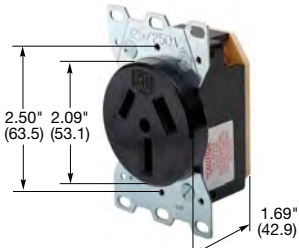

HBL7962

50A, 250V, 2 Pole, 3 Wire Grounding, Receptacles and Plugs

IP20
SUITABILITY



**50A 250V
NEMA 6-50R
UL CSA
3 HP**



**50A 250V
NEMA 6-50P
UL CSA
3 HP**

Description	Cord Diameter	Catalog Number
Receptacle, black RTP.	-	HBL9367
Plug, nylon, angle, 4-position.	.625"-1.187" (15.9-30.2)	HBL9368

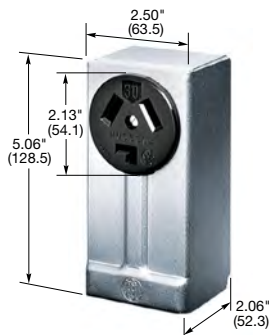

Representative of surface
mount receptacle

50A, 277V AC, 2 Pole, 3 Wire Grounding, Receptacles and Plugs

IP20
SUITABILITY



**50A 277V AC
NEMA 7-50R
UL CSA
5 HP**



**50A 277V AC
NEMA 7-50P
UL CSA
5 HP**

Description	Cord Diameter	Catalog Number
Receptacle, black RTP.	-	HBL9365
Plug, nylon, angle, 4-position.	.625"-1.187" (15.9-30.2)	HBL9379



HBL7515C

**50A, 125/250V,
3 Pole, 3 Wire Non-Grounding,
Receptacles, Connector Body and Plugs**

IP20
SUITABILITY



**50A 125/250V
NEMA 10-50R
UL Listed
3(2) HP**



**50A 125/250V
NEMA 10-50P
UL Listed
3(2) HP**

Description	Cord Diameter	Catalog Number
Receptacle, black phenolic.	-	HBL7962
Receptacle, surface mount aluminum housing.	-	HBL7940
Connector body, Insulgrip, nylon.	.625"-1.218" (15.9-30.9)	HBL7515C
Plug, Insulgrip, nylon.	.625"-1.218" (15.9-30.9)	HBL7513C
Plug, nylon, angle, 4-position.	.625"-1.187" (15.9-30.2)	HBL7977

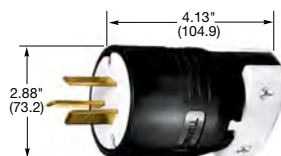

HBL7513C

Note: RTP is an abbreviation for reinforced thermoplastic polyester.
See pages A-49 and A-50 for accessories.

Dimensions in Inches (mm)

50A, 125/250V, 3 Pole, 4 Wire Grounding, Receptacles and Plugs

IP20
SUITABILITY



50A 125/250V
NEMA 14-50R
UL CSA
3(2) HP



50A 125/250V
NEMA 14-50P
UL CSA
3(2) HP

Description	Cord Diameter	Catalog Number
Receptacle, black RTP.	-	HBL9450A
Plug, nylon.	.625"-1.310" (15.9-33.3)	HBL9451C
Plug, nylon, angle, 4-position.	.625"-1.310" (15.9-33.3)	HBL9452C

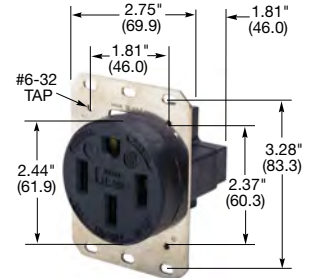

HBL9450A

50A, 3Ø 250V AC, 3 Pole, 4 Wire Grounding, Receptacles and Plugs

IP20
SUITABILITY



50A 3Ø 250V AC
NEMA 15-50R
UL CSA
7.5 HP



50A 3Ø 250V AC
NEMA 15-50P
UL CSA
7.5 HP

Description	Cord Diameter	Catalog Number
Receptacle, black RTP.	-	HBL8450A
Plug, nylon.	.625"-1.310" (15.9-33.3)	HBL8451C
Plug, nylon, angle, 4-position.	.625"-1.310" (15.9-33.3)	HBL8452C



HBL9451C



50A, 3ØY 120/208V AC, 4 Pole, 4 Wire Non-Grounding, Receptacles and Plugs

IP20
SUITABILITY



50A 3ØY
120/208V AC
NEMA 18-50R
UL Listed
7.5 HP



50A 3ØY
120/208V AC
NEMA 18-50P
UL Listed
7.5 HP

Description	Cord Diameter	Catalog Number
Receptacle, black RTP.	-	HBL8350A
Plug, nylon, angle, 4-position.	.625"-1.310" (15.9-33.3)	HBL8352C

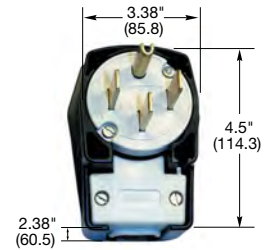

HBL9452C

Note: RTP is an abbreviation for reinforced thermoplastic polyester.
See page A-50 for accessories.

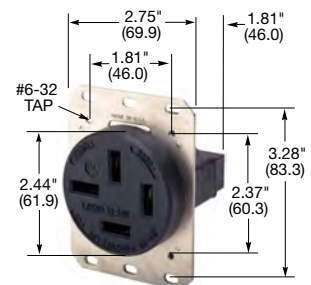

HBL8350A

Dimensions in Inches (mm)

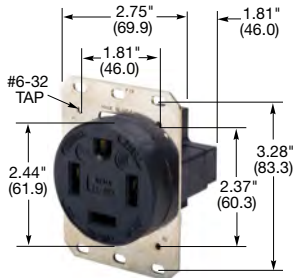

HBL9460A

60A, 125/250V, 3 Pole, 4 Wire Grounding, Receptacles and Plugs

IP20
SUITABILITY



**60A 125/250V
NEMA 14-60R
UL CSA
3(2) HP**



**60A 125/250V
NEMA 14-60P
UL CSA
3(2) HP**

Description	Cord Diameter	Catalog Number
Receptacle, black RTP.	-	HBL9460A
Plug, nylon.	.625"-1.310" (15.9-33.3)	- HBL9461C
Plug, nylon, angle, 4-position.	.625"-1.310" (15.9-33.3)	- HBL9462C



HBL9461C

60A, 3Ø 250V AC, 3 Pole, 4 Wire Grounding, Receptacles and Plugs

IP20
SUITABILITY



**60A 3Ø 250V AC
NEMA 15-60R
UL CSA
10 HP**



**60A 3Ø 250V AC
NEMA 15-60P
UL CSA
10 HP**

Description	Cord Diameter	Catalog Number
Receptacle, black RTP.	-	HBL8460A
Plug, nylon.	.625"-1.310" (15.9-33.3)	- HBL8461C
Plug, nylon, angle, 4-position.	.625"-1.310" (15.9-33.3)	- HBL8462C

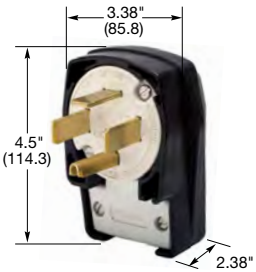

HBL9462C

60A, 3ØY 120/208V AC, 4 Pole, 4 Wire Non-Grounding, Receptacles and Plugs

IP20
SUITABILITY



**60A 3ØY
120/208V AC
NEMA 18-60R
UL Listed
7.5 HP**

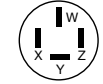

**60A 3ØY
120/208V AC
NEMA 18-60P
UL Listed
7.5 HP**

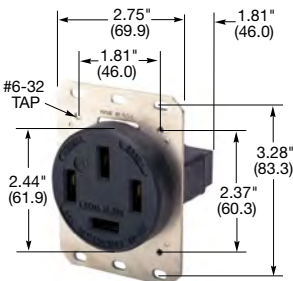

HBL7301A

Description	Cord Diameter	Catalog Number
Receptacle, black RTP.	-	HBL7301A
Plug, nylon.	.625"-1.310" (15.9-33.3)	- HBL7303C
Plug, nylon, angle, 4-position.	.625"-1.310" (15.9-33.3)	- HBL7302C

*Note: RTP is an abbreviation for reinforced thermoplastic polyester.
See page A-50 for accessories.*

Dimensions in Inches (mm)

Straight Blade Devices

Miscellaneous and Combination Receptacles

2 Pole, 3 Wire Grounding

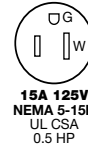

Miscellaneous Receptacles

Description	Catalog Number
Receptacle, display type, brown phenolic with .060 in. brass plate and blank flush plug.	HBL5236
Replacement receptacle for HBL5236.	HBL5236M2
Replacement threaded plug for HBL5236.	HBL5236PLUG*
Receptacle, wooden floors, brown phenolic with .060 in. brass plate, blank flush plug and box.	HBL6236
Receptacle, clock hanger, white with stainless steel plate.	HBL5235











HBL5236



HBL5235

Special Combination Duplex Receptacles

Description	Catalog Number
15A, 125V Brown RTP, 1 feed, 1 return, back/side wired	HBL4792
 Brown RTP, 2 feeds, 1 return, side wired	HBL4794
15A, 125V  Brown RTP, 2 feeds, 2 returns, side wired	HBL4795
15A, 250V  Brown nylon face, 2 circuit, back and side wired	HBL5292
15A, 125V  Ivory nylon face, 2 circuit, back and side wired	HBL52921
20A, 250V  Brown nylon face, 2 circuit, back and side wired	HBL5492
20A, 125V  Ivory nylon face, 2 circuit, back and side wired	HBL54921
15A, 125V  Brown RTP, 2 feeds, 1 return, common ground	HBL7371
10A, 250V 15A, 125V  Brown nylon, side and back wired	HBL5392
20A, 125V  <i>Note: This device will only accept 20A grounding plugs.</i>	

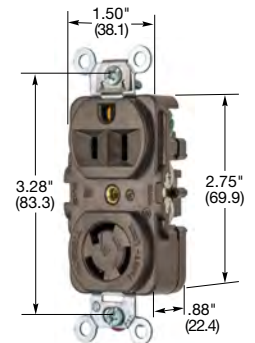

HBL4792

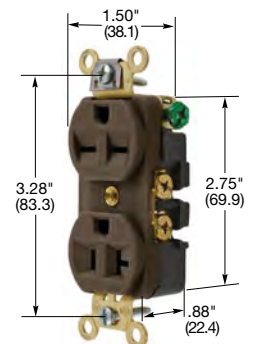

HBL5292

Note: RTP is an abbreviation for reinforced thermoplastic polyester.

*Not UL Listed or CSA certified.

See page A-47 for accessories.

Dimensions in Inches (mm)

Straight Blade Devices

Accessories

For 15 and 20 Ampere, 125 and 250 Volts and 277 Volts AC Devices



P8



Wallplates, 1-Gang

Description	Color	Duplex Receptacle	Style Line® Receptacle	Single Receptacle Plate 1.40 in. (35.6) Dia.
Thermoplastic, smooth.	Black	P8BK	P26BK	P7BK
	Brown	P8	P26	P7
	Gray	P8GY	P26GY	P7GY
	Ivory	P8I	P26I	P7I
	Light Almond	P8LA	P26LA	P7LA
	Orange	P8OR	–	–
	Red	P8R	P26R	P7R
	White	P8W	P26W	P7W
	Stainless steel 302/304, .035 in. (0.9) horizontal brushed finish.		SS8	SS26
Brass .04 in. (1.0), horizontal brushed finish.		SB8	SB26	SB7
Aluminum .05 in. (1.3), horizontal brushed finish.		SA8	–	SA7



P26I



SS7



HBL52CM22

Weatherproof Covers

Description	Duplex Receptacle	Single Receptacle Plate 1.40 in. (35.6) Dia.
RTP, gray, for FS/FD box mounting.	HBL5221	HBL7423WO
RTP, yellow, for FS/FD box mounting.	HBL52CM21	HBL74CM23WO
RTP, gray, for device mounting.	HBL5222	–
RTP, yellow, for device mounting.	HBL52CM22	–
Cast aluminum for FS/FD box mounting.	HBL5206WO	HBL7420
Cast aluminum for device mounting.	HBL5205WO	–

Note: All weatherproof plates are UL Listed for Wet Locations.
 Those with suffix WO are listed for use with cover open, all others with cover closed.
 RTP is an abbreviation for reinforced thermoplastic polyester.
 See section O for additional information on cover plates.



HBL5206WO



HBL7423WO

Dimensions in Inches (mm)

Straight Blade Devices

Accessories

For 15 and 20 Ampere, 125 and 250 Volts and 277 Volts AC Devices



IP44
SUITABILITY

Weatherproof Covers For Nylon Flanged Inlets and Flanged Receptacles

Description	Catalog Number
RTP, gray, for FS/FD box mounting.	WP1

Note: RTP is an abbreviation for reinforced thermoplastic polyester.
See page O-21 for additional information on weatherproof covers.



WP1

Weatherproof Boots

IP55*
SUITABILITY

Description	Catalog Number
Seal-Tite® triple seal, black elastomer cover for Insulgrip® plugs (HBL5266C style), when used in a cord set, and connector bodies (HBL5269C style), when used with flanged inlets.	HBL6017
Same as above except yellow.	HBL60CM17
Seal-Tite® triple seal black elastomer cover for Insulgrip® connector bodies when used in a cord set.	HBL6018
Same as above except yellow.	HBL60CM18
Closure plug, black.	HBL6019
Closure plug, yellow.	HBL60CM19

Note: *IP55 when installed and used properly with mating components.
Boots are not UL Listed or CSA Certified.



HBL6017



HBL6018



HBL60CM19
Shown with **HBL6018**

PLUGOUT® Device

Description	Catalog Number
Electrical plug lockout devices for 15 and 20A straight blade plugs.	HLDMP**
PLUGOUT® Lockout device for 20 and 30A Hubbell plugs and others.	HLD**

Note: **Not UL Listed or CSA Certified.
See section BB for additional information on lockout devices.

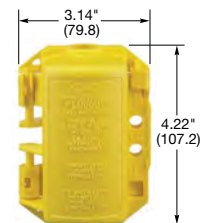

HLDMP

Inserts

Description	Catalog Number
Replacement cord grip inserts for Valise® device, (bag of 40).	HBLVCGBK**

Note: **Not UL Listed or CSA Certified.



HLD

Dimensions in Inches (mm)

Straight Blade Devices

Accessories

For 3 Wire 30 and 50 Ampere, 125 and 250 Volts and 277 Volts AC

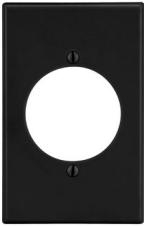

P724BK



SS723



SS703



HBL9420



HLD2



Wallplates

Description	Color	Single Receptacle Plate 2.16 in. (54.9) Dia.
Thermoplastic, smooth, 1-gang.	Black	P724BK
Thermoplastic, smooth, 2-gang.	Black	P703BK
Aluminum, .05 in. (1.3), 1-gang, smooth horizontal brushed finish.		SA723
Stainless steel 302/304, .035 in. (0.9), 1-gang, smooth horizontal brushed finish.		SS723
Stainless steel 302/304, .035 in. (0.9), 2-gang, smooth horizontal brushed finish.		SS703



IP44
SUITABILITY

Weatherproof Lift Covers

Description	Catalog Number
Cast aluminum for FS/FD box mounting for 30A.	HBL9420
Cast aluminum for FS/FD box mounting for 50A.	HBL9425

PLUGOUT® Device

Description	Catalog Number
Electrical plug lockout device for 30, 50 and 60A devices.	HLD2

Note: See section BB for additional information on lockout devices.

Dimensions in Inches (mm)

Straight Blade Devices

Accessories

For 4 Wire 30, 50 and 60 Ampere, 125/250 Volts, 3Ø 250 and 3ØY 120/208 Volts AC



Wallplates, 2-Gang

Description	Catalog Number
Single Receptacle Plate 2.48 in. (63.0) Dia.	SB701
Brass .04 in. (1.0), brushed, smooth.	SB701
Stainless steel 302/304, .035 in. (0.9), smooth horizontal brushed finish.	SS701



SS701



IP44
SUITABILITY

Weatherproof Lift Covers

Description	Catalog Number
RTP, gray, lift cover plate. Will fit FS/FD boxes having plate mounting hole 3.25 in. x 3.75 in. (82.5 x 95.2), centers. Only for use with receptacles on pages A-40 to A-43 with "A" suffix.	HBL7777A
Same as above except yellow.	HBL77CM77A

Note: RTP is an abbreviation for reinforced thermoplastic polyester.



HBL7777A

PLUGOUT® Device

Description	Catalog Number
Electrical plug lockout device for 30, 50 and 60A devices.	HLD2

Note: See section BB for additional information on lockout devices.



HLD2

Dimensions in Inches (mm)

Straight Blade Devices

Technical Information

HBL® Extra Heavy Duty Max, Straight Blade Hospital Grade Duplex Receptacles



HBL8200GY

Specifications

Receptacles	Part	Description
Typical Specification – Catalog No. HBL8200	Receptacle	15A
Manufacturer's Identification – Hubbell HBL8200	Top	PBT*
Description – Hospital Grade, Straight Blade Duplex Receptacle	Base	RTP**
Type – 2 Pole, 3 Wire, Grounding	By-Pass Power Contacts	.037 in. (.9) Brass – Nickel Finish
Rating – 15A, 125V	Clamping Plate	.031 in. (.8) Brass – Nickel Finish
Certification: UL Listed to UL 498 File E2186, Fed. Spec. WC596,	Mounting Strap	.050 in. (1.3) Brass – Nickel Finish
Hospital Grade, NEMA® WD-6 Compliant	Line Terminal Screws	#10-32 Silicone Bronze, Multiple Drive
Certified to CSA, C22.2, No. 42 File 285	Hex Head Grounding Screw	#10-32 (Green) Silicon Bronze, Multiple Drive
	Center Assembly Rivet	Silicon Bronze
	Automatic Self-Grounding Clip	Stainless Steel
	Flat Head Mounting Screws	Stainless Steel

Performance

Electrical	
Dielectric Voltage	Withstands 2,000V minimum.
Max. Working Voltage	125V or 250V as rated.
Current Interrupting	Certified for current interrupting at full rated current.
Temperature Rise	Max 30°C temperature rise at full rated current after 50 cycles of overload at 150% of rated current at a power factor of 75%.
Mechanical	
Terminal Identification	Terminals identified in accordance with UL 498 and CSA (Brass, White, Green).
Terminal Accommodation	#14-10 AWG stranded or solid copper conductor only.
Product Identification	Ratings are a permanent part of the device.
Environmental – Material	
Flammability	UL 94V-0 and UL 94-5 VA.
Operating Temperature	Maximum continuous 75°C; minimum -40°C (w/o impact).

Note: *Polybutylene Terephthalate.

**Reinforced Thermoplastic Polyester.

Straight Blade Devices

Technical Information

HBL® Extra Heavy Duty Max, Straight Blade Specification Grade Duplex Receptacles



HBL5262

Specifications

Receptacles	Part	Description
Typical Specification – Catalog No. HBL5262	Receptacle	15A
Manufacturer's Identification – Hubbell HBL5262	Top	Nylon
Description – Heavy Duty Straight Blade Duplex Receptacle	Base	RTP*
Type – 2 Pole, 3 Wire, Grounding	By-Pass Power Contacts	.037 in. (.9) Brass
Rating – 15A, 125V	Wire Clamps	.031 in. (.8) Brass
Certification: UL Listed to UL498 File E2186, Guide RTRT	Mounting Strap	.050 in. (1.3) Brass
Fed. Spec. WC596, Meets NEMA® WD-6 Compliant	Line Terminal Screws	#10-32 Brass, Multiple Drive
Certified to CSA, C22.2, No. 42 File 285	Ground Screw	#10-32 Brass, Multiple Drive (Green)
	Center Assembly Rivet	Brass
	Automatic Self-Grounding Clip	Stainless Steel
	Flat Head Mounting Screws	Steel-Zinc Plated
	Ground Tension Clips	Steel-Nickel Finish

Performance

Electrical

Dielectric Voltage	Withstands 2,000V minimum.
Max. Working Voltage	125V or 250V as rated.
Current Interrupting	Certified for current interrupting at full rated current.
Temperature Rise	Max 30°C temperature rise at full rated current after 50 cycles of overload at 150% of rated current at a power factor of 75%.

Mechanical

Terminal Identification	Terminals identified in accordance with UL 498 and CSA (Brass, White, Green).
Terminal Accommodation	#14-10 AWG stranded or solid copper conductor only.
Product Identification	Ratings are a permanent part of the device.

Environmental – Material

Flammability	Top: UL 94V-2. Base: UL 94V-0 and UL 94-5 VA.
Operating Temperature	Maximum continuous 75°C; minimum -40°C (w/o impact).

Note: *Reinforced Thermoplastic Polyester.

NEMA® is a registered trademark of the National Electrical Manufacturers Association.

Straight Blade Devices

Technical Information

HBL® Compact Extra Heavy Duty Max, Straight Blade Specification Grade Receptacles



HBL5252

Specifications

Receptacles	Part	Description
Typical Specification – Catalog No. HBL5252	Receptacle	15A
Manufacturer's Identification – Hubbell HBL5252	Top	Nylon
Description – Straight Blade Duplex Receptacle	Base	RTP*
Type – 2 Pole, 3 Wire, Grounding	Triple Wipe Power Contacts	.032 in. (.8) Brass
Rating – 15A, 125V	Wire Clamps	.062 in. (1.8) Steel
Certification – UL Listed to UL 498 File E2186, Fed. Spec. WC596, Certified to CSA 22.2, No. 42 File 285	Mounting Strap	.050 in. (1.3) Brass
	Line Terminal Screws	#8-32 Brass, Multiple Drive
	Ground Screw	#8-32 Brass, Multiple Drive (Green)
	Center Assembly Rivet	Brass
	Automatic Self-Grounding Clip	Stainless Steel
	Flat Head Mounting Screws	Steel-Zinc Plated

Performance

Electrical	
Dielectric Voltage	Withstands 2,000V minimum.
Max. Working Voltage	125V or 250V as rated.
Current Interrupting	Certified for current interrupting at full rated current.
Temperature Rise	Max 30°C temperature rise at full rated current after 50 cycles of overload at 150% of rated current at a power factor of 75%.
Mechanical	
Terminal Identification	Terminals identified in accordance with UL 498 (Brass, White, Green).
Terminal Accommodation	#14-10 AWG stranded or solid copper conductor only.
Product Identification	Ratings are a permanent part of the device.
Environmental – Material	
Flammability	UL 94V-2.
Operating Temperature	Maximum continuous 75°C; minimum -40°C (w/o impact).

Note: *Reinforced Thermoplastic Polyester.

Please consult the factory for product dimensions and specifications of other products listed in this catalog.

Straight Blade Devices

Technical Information

HBL® Compact Heavy Duty Style Line®, Specification Grade and Hospital Grade Straight Blade Duplex Receptacles



HBL2152



HBL2172

Specifications

Receptacle	Part	Description
Typical Specification – Catalog No. HBL2152	Receptacle	15A
Manufacturer’s Identification – Hubbell HBL2152 Receptacle	Top	Nylon
Description – Straight Blade Duplex Receptacle	Base	Nylon
Type – 2 Pole, 3 Wire Grounding	Triple Wipe Power Contacts	.031 in. (.8) Brass
Rating – 15A, 125V	Wire Clamp	.062 in. (1.8) Steel-Nickel Finish
Certification – UL File No. E2186	Mounting Strap	.050 in. (1.3) Galvanized Steel
Certified to CSA File No. 285	Ground Contact	.031 in. (.8) Brass
	Line Terminal Screws	#8-32 Brass, Multiple Drive
	Ground Screw	#8-32 Brass, Multiple Drive
	Automatic Self-Grounding Staple	Stainless Steel
	Mounting Screws	Zinc Plated Steel
Receptacle	Part	Description
Typical Specification – Catalog No. HBL2172	Receptacle	15A
Manufacturer’s Identification – Hubbell HBL2182 Receptacle	Top	Nylon
Description – Straight Blade Duplex Receptacle	Base	RTP*
Type – 2 Pole, 3 Wire Grounding	Triple Wipe Power Contacts	.031 in. (.8) Brass
Rating – 15A, 125V	Wire Clamp	.062 in. (1.8) Steel-Nickel Finish
Certification – UL Listed to UL498 File E2186,	Mounting Strap	.050 in. (1.3) Galvanized Steel
Fed. Spec. WC596, Certified to CSA File No. 285	Ground Contact	.031 in. (.8) Brass
	Line Terminal Screws	#8-32 Brass, Multiple Drive
	Ground Screw	#8-32 Brass, Multiple Drive
	Automatic Self-Grounding Staple	Stainless Steel
	Mounting Screws	Zinc Plated Steel

Performance

Electrical

Dielectric Voltage	Withstands 2,000V minimum.
Max. Working Voltage	125V.
Current Interrupting	Certified for current interrupting at full rated current.
Temperature Rise	Max 30°C temperature rise at full rated current after 50 cycles of overload at 150% of rated current at a power factor of 75%.

Mechanical

Terminal Identification	Terminals identified in accordance with UL 498 and CSA (Brass, White, Green).
Terminal Accommodation	#14-10 AWG stranded or solid copper conductor only.
Product Identification	Ratings are a permanent part of the device.

Environmental – Material

Flammability	UL 94V-2.
Operating Temperature	Maximum continuous 75°C; minimum -40°C (w/o impact).

Note: *Reinforced Thermoplastic Polyester.

Please consult the factory for product dimensions and specifications of other products listed in this catalog.

Straight Blade Devices

Technical Information

SNAPConnect® Straight Blade Duplex Receptacles Specification Grade and Hospital Grade



Specifications

Receptacle	Part	Description
Typical Specification – Catalog No. SNAP8200	Receptacle	15A
Manufacturer's Identification – Hubbell SNAP8200	Top	Nylon
Description – Straight Blade Duplex Receptacle	Base	Nylon
Type – 2 Pole, 3 Wire, Grounding	Triple Wipe Power Contacts	Brass
Rating – 15A, 125V	Mounting Strap	Galvanized Steel; Brass (HG)
Certification – UL Listed to UL 498	Automatic Self-Grounding Clip	Stainless Steel
Fed. Spec. WC596, Certified to CSA 22.2, No. 42	Flat Head Mounting Screws	Steel-Zinc Plated/Self Tapping

Connector	Contact	Connector Body	Wire
SNAP1RA	Brass	Clear Polycarbonate	6" Solid copper #12 AWG THHN/THWN-2 600V, T90 Nylon FT-1, PVC 90°C (min).
SNAP2RA	Brass	Clear Polycarbonate	6" Stranded copper #12 AWG THHN/THWN-2 600V, T90 Nylon FT-1, PVC 90°C (min).

Performance

Electrical	
Dielectric Voltage	Withstands 2,000V minimum.
Max. Working Voltage	125V as rated.
Current Interrupting	Receptacle certified for current interrupting at full rated current with equivalently rated NEMA® plug.
Temperature Rise	Max 30°C temperature rise at full rated current after 50 cycles of overload at 150% of rated DC current.

Mechanical	
Terminal Wire Leads Identification	Terminal wire leads identified in accordance with UL 498 (Black, White, Green).
Product Identification	Ratings are a permanent part of the device.

Environmental – Material	
Flammability	UL 94V-2.
Operating Temperature	Maximum continuous 75°C; minimum -40°C (without impact).

Dimensions

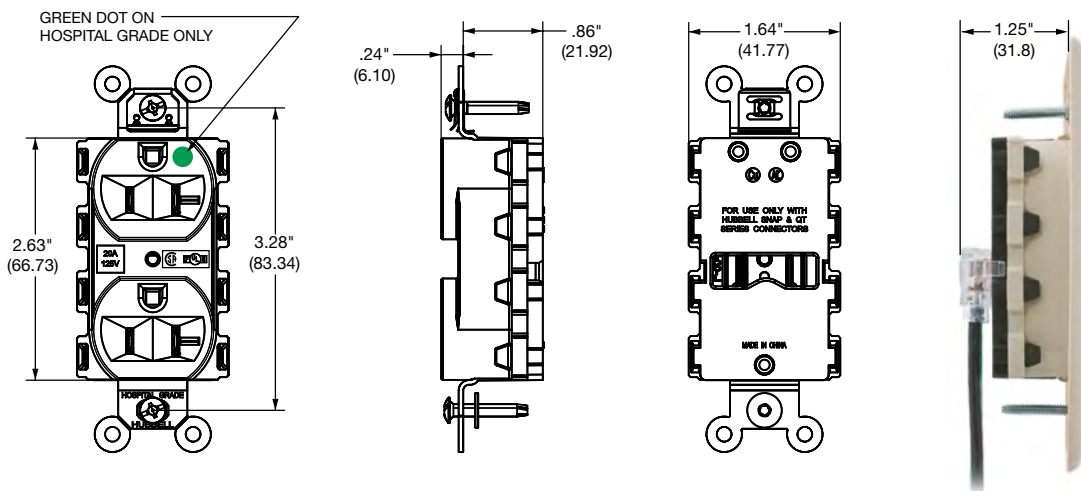

NEMA® is a registered trademark of the National Electrical Manufacturers Association.

Straight Blade Devices

Technical Information

Hubbell-PRO Heavy Duty, Straight Blade Hospital Grade Duplex Receptacles



Specifications

Receptacle	Part	Description
Typical Specification - Catalog No. 8200	Receptacle	15A
Manufacturer's Identification - Hubbell-PRO 8200	Top	Nylon
Description - Straight Blade Hospital Grade Duplex Receptacle	Base	Nylon
Type - 2 Pole, 3 Wire, Grounding	Triple Wipe Power Contacts	.0295 in. Brass
Rating - 15A, 125V	Clamping Plate	Plated Steel
Certification - UL Listed to UL 498, Fed. Spec. WC596	Mounting Strap	.040 in. Galvanized Steel
Hospital Grade, NEMA® WD-6 Compliant	Terminal Screws	Plated Steel
Certified to CSA	Hex Head Grounding Screw	Plated Steel
	Automatic Self-Grounding Staple	Stainless Steel
	Mounting Screws	Zinc Plated Steel

Performance

Electrical	
Dielectric Voltage	Withstands 2,000V minimum.
Max. Working Voltage	125V.
Current Interrupting	Certified for current interrupting at full rated current.
Temperature Rise	Max 30°C temperature rise at full rated current after 50 cycles of overload at 150% of rated current at a power factor of 75%.
Mechanical	
Terminal Identification	Terminals identified in accordance with UL 498 and CSA (Brass, White, Green)
Terminal Accommodation	#14-10 AWG stranded or solid copper conductor only.
Product Identification	Ratings are a permanent part of the device.
Environmental - Material	
Flammability	UL 94V-2.
Operating Temperature	Maximum continuous 75°C; minimum -40°C (w/o impact).

NEMA® is a registered trademark of the National Electrical Manufacturers Association.

Straight Blade Devices

Technical Information

USB-C Power Delivery Charger Tamper-Resistant, Straight Blade Hospital Grade and Specification Grade Duplex Receptacles



Specifications

USB-C Power Delivery Charger Receptacle	Part	Description
Typical Specification - Catalog No. USB8300ACPD	Charger Receptacle	Electrical 20 Amp 125V AC USB 5.0 Amp 5V DC
Manufacturer's Identification - Hubbell USB8300ACPD		
Available Type USB-C Power Delivery Charger	Ports	Type A&C or C
	LED	Power Indication (White)/USB Charging (Blue)
Receptacle	Top	Nylon
Description - Hospital Grade, Straight Blade Duplex Receptacle	Base	Nylon
Type - 2 Pole, 3 Wire, Grounding	Triple Wipe Power Contacts	.030 in. Cooper Alloy
Rating - 15 or 20 Amp, 125V AC, USB 5 Amp, 5V DC	Clamping Plate	Plated Steel
	Mounting Strap	.040 in. Galvanized Steel
Certification - cULus Listed to UL498 and UL1310	Terminal Screws	Plated Steel
Hospital Grade, NEMA® WD-6 Compliant (USB8200 and 8300 series only)	Hex Head Grounding Screw	Plated Steel
Complies with battery charging specification USB BC1.2 and 3.0 Power	Automatic Self-Grounding Staple	Stainless Steel
Complies with Part 15 of the FCC rules	Mounting Screws	Zinc Plated Steel
Compatible with USB 1.1/2.0/3.0 devices, including Apple products	Auto-Ground Staple	Stainless Steel

Performance

Electrical	
Dielectric Voltage	Withstands 2,000V minimum.
Max. Working Voltage	125V.
Current Interrupting	Certified for current interrupting at full rated current.
Temperature Rise	Max 30°C temperature rise at full rated current after 50 cycles of overload at 150% of rated current at a power factor of 75%.
Mechanical	
USB Port	Stainless Steel Rated for 10,000 plug insertions and removal
Terminal Identification	Terminals identified in accordance with UL 498 and CSA (Brass, White, Green)
Terminal Accommodation	#14-10 AWG stranded or solid copper conductor only.
Product Identification	Ratings are a permanent part of the device.
Circuit Feed-Through	20 Amp 125 Volt
Environmental - Material	
Flammability	UL 94V-2.
Operating Temperature	Maximum continuous 75°C; minimum -40°C (w/o impact).

NEMA® is a registered trademark of the National Electrical Manufacturers Association.

Straight Blade Devices

Technical Information

Hubbell-PRO Extra Heavy Duty, Straight Blade Specification Grade Duplex Receptacles



Specifications

Receptacle, Smooth Nylon Face	Part	Description
Typical Specification – Catalog No. 5252AB	Receptacle	15A
Manufacturer's Identification – Hubbell 5252AB Receptacle	Top	Polycarbonate
Description – Straight Blade Duplex Receptacle	Base	RTP*
Type – 2 Pole, 3 Wire, Grounding	Triple Wipe Power Contacts	.031 in. (.8) Brass
Rating – 15A, 125V	Wire Clamp	.062 in. (1.8) Steel-Nickel Finish
Certification – UL Listed to UL498 File E2186	Mounting Strap	.040 in. (1) Galvanized Steel
Fed. Spec. WC596, Certified to CSA 22.2, No. 42	Ground Contact	.031 in. (.8) Brass
NEMA® WD-6 Compliant	Line Terminal Screws	#8-32 Brass, Multiple Drive
	Ground Screw	#8-32 Brass, Multiple Drive
	Center Assembly Staple	.040 in. (1) Galvanized Steel
	Automatic Self-Grounding Staple	Stainless Steel
	Mounting Screws	Zinc Plated Steel
Receptacle, Finder Groove Face	Part	Description
Typical Specification – Catalog No. 5262B	Receptacle	15A
Manufacturer's Identification – Hubbell 5262B Receptacle	Top	Polycarbonate
Description – Straight Blade Duplex Receptacle	Base	RTP*
Type – 2 Pole, 3 Wire, Grounding	Triple Wipe Power Contacts	.031 in. (.8) Brass
Rating – 15A, 125V	Wire Clamp	.062 in. (1.8) Steel-Nickel Finish
Certification – UL Listed to UL498 File E2186	Mounting Strap	.040 in. (1) Galvanized Steel
Fed. Spec. WC596, Certified to CSA C22.2, No. 42	Ground Contact	.031 in. (.8) Brass
NEMA® WD-6 Compliant	Line Terminal Screws	#8-32 Brass, Multiple Drive
	Ground Screw	#8-32 Brass, Multiple Drive
	Center Assembly Staple	.040 in. (1) Galvanized Steel
	Automatic Self-Grounding Clip	Stainless Steel
	Mounting Screws	Zinc Plated Steel

Performance

Electrical	
Dielectric Voltage	Withstands 2,000V minimum.
Max. Working Voltage	125V.
Current Interrupting	Certified for current interrupting at full rated current.
Temperature Rise	Max 30°C temperature rise at full rated current after 50 cycles of overload at 150% of rated current at a power factor of 75%.
Mechanical	
Terminal Identification	Terminals identified in accordance with UL 498 and CSA (Brass, White, Green)
Terminal Accommodation	#14-10 AWG stranded or solid copper conductor only.
Product Identification	Ratings are a permanent part of the device.
Environmental – Material	
Flammability	UL 94V-2.
Operating Temperature	Maximum continuous 75°C; minimum -40°C (w/o impact).

Note: *Reinforced Thermoplastic Polyester.

Please consult the factory for product dimensions and specifications of other products listed in this catalog.

NEMA® is a registered trademark of the National Electrical Manufacturers Association.

Straight Blade Devices

Technical Information

Commercial Specification Grade Receptacles



CRF151



BR15LA



DR20I



CR20TR



DR20GRYWR

Specifications

Part	Standard	Weather Resistant
Top	Polycarbonate	Polycarbonate (UV Rated)
Base	Nylon	Nylon
Double Wipe Power Contacts	.030 in. (.8) Brass	.030 in. (.8) Brass
Wire Clamp	.062 in. (1.6) Steel-Nickel Plated	.062 in. (1.6) Steel-Nickel Plated
Finish		
Mounting Strap	.040 in. (1) Galvanized Steel	.040 in. (1) Galvanized Steel
Ground Contact	.031 in. (.8) Brass	.031 in. (.8) Brass
Line Terminal Screws	#8-32 Plated Steel, Multiple Drive	#8-32 Stainless Steel, Multiple Drive
Ground Screw	#8-32 Plated Steel, Multiple Drive	#8-32 Stainless Steel, Multiple Drive
Automatic Self-Grounding Staple	Stainless Steel	Stainless Steel
Mounting Screws	Zinc Plated Steel	Stainless Steel
Certification		
UL Listed	UL498	UL498
Fed. Spec	WC596	WC596*
Certified to CSA	C22.2, No. 42	C22.2, No. 42

Performance

Electrical		
Dielectric Voltage	Withstands 2,000V minimum.	Withstands 2,000V minimum.
Max. Working Voltage	125V.	125V.
Current Interrupting	Certified for current interrupting at full rated current.	Certified for current interrupting at full rated current.
Temperature Rise	Max 30°C temperature rise at full rated current after 100 cycles of overload at 150% of rated current.	Max 30°C temperature rise at full rated current after 100 cycles of overload at 150% of rated current.
Mechanical		
Terminal Identification	Terminals identified in accordance with UL 498 and CSA (Brass, White, Green).	Terminals identified in accordance with UL 498 and CSA (Brass, White, Green).
Terminal Accommodation	#14-10 AWG stranded or solid copper conductor only.	#14-10 AWG stranded or solid copper conductor only.
Product Identification	Ratings are a permanent part of the device.	Ratings are a permanent part of the device.
Environmental – Material		
Flammability	UL 94V-2.	UL 94V-2.
Operating Temperature	Maximum continuous 75°C; minimum -40°C (w/o impact).	Maximum continuous 75°C; minimum -40°C (w/o impact).

Note: *Decorator and Commercial Tamper-Resistant devices are not Fed. Spec. Listed.

Straight Blade Devices

Technical Information



HBL415I

4-PLEX® Receptacles

Specifications

Receptacle	Part	Description
Typical Specification – Catalog No. HBL415	Receptacle	15 or 20A
Manufacturer's Identification – Hubbell 4-PLEX HBL415	Top	Polycarbonate
Description – Straight Blade, Multiple Outlet Receptacle	Base	Polycarbonate
Type – 2 Pole, 3 Wire, Grounding	Power Contacts	.032 in. (.8) Brass
Rating 15A, 125V	Ground Contacts	.031 in. (.8) Brass
Certification – Listed to UL Standard 498 File E2186	Ground Plate	.032 in. (.8) Plated Steel
Certified to CSA 22.2, No. 42 File 285	(Hospital Grade)	.050 in. (1.3) Plated Steel
	Line and Neutral Terminal Plate	.031 in. (.8) Brass
	Line Terminal Screw	#8-32 Brass
	Ground Screw	#8-32 Brass (Green)

Performance

Electrical	
Dielectric Voltage	Withstands 2,000V minimum.
Max. Working Voltage	125V.
Current Interrupting	Capable of withstanding a fault level of 1000A, per UL498.
Temperature Rise	Max 30°C temperature rise at full rated current after 50 cycles of overload current at 150% of rated current at a power factor of 75%.
Mechanical	
Terminal Identification	Terminals identified in accordance with UL498 and CSA (Brass, White, Green).
Terminal Accommodation	#14-12 AWG stranded or solid copper conductor only.
Product Identification	Ratings are a permanent part of the device.
Environmental	
Flammability	UL 94V-2.
Operating Temperature	Maximum continuous 75°C; minimum -40°C (w/o impact).

Straight Blade Devices

Technical Information

Insulgrip® Plugs and Connector Bodies



HBL5266C



HBL5269C

Specifications

Plugs	Part	Description
Typical Specification – Catalog No. HBL5266C		Plug
Manufacturer's Identification – Hubbell HBL5266C		Housing
Description – Straight Body Plug		Blade Holder
Type – 2 Pole, 3 Wire, Grounding		Retainer
Rating – 15A, 125V		Cord Clamp
Verified to Fed. Spec. WC596		Contact Blades
Certification – UL Listed to UL498 File E1706, CSA Certified to C22.2 No. 42 File 280		Ground Contact Blade
IP Suitability – IP20		Line Terminal Screws
		Ground Screw
		Wire Clamps
		15A
		Nylon – Black
		Nylon – Natural
		Polycarbonate – Clear
		Nylon – Natural
		.060 in. (1.5) Brass
		.040 in. (1.0) Copper Alloy
		#8-32 Brass, Multiple Drive
		#8-32 Brass, Multiple Drive (Green)
		.062 in. (1.6) Steel – Nickel Finish
Connector Bodies	Part	Description
Typical Specification – Catalog No. HBL5269C		Connector Body
Manufacturer's Identification – Hubbell HBL5269C		Housing
Description – Straight Body Connector		Contact Holder
Type – 2 Pole, 3 Wire, Grounding		Retainer
Rating – 15A, 125V		Cord Clamp
Verified to Fed. Spec. WC596		Power Contacts
Certification – UL Listed to UL498 File E1706, CSA Certified to C22.2 No. 42 File 280		Line Terminal Screws
IP Suitability – IP20		Ground Screw
		Wire Clamps
		15A
		Nylon – Black
		Nylon – Natural
		Polycarbonate – Clear
		Nylon – Natural
		.040 in. (1.0) Copper Alloy
		#8-32 Brass, Multiple Drive
		#8-32 Brass, Multiple Drive (Green)
		.062 in. (1.6) Steel – Nickel Finish

Performance

Electrical	
Dielectric Voltage	Withstands 2,000V minimum.
Max. Working Voltage	125V or 250V as rated.
Current Interrupting	Certified for current interrupting at full rated current.
Temperature Rise	Max 30°C temperature rise at full rated current after 50 cycles of overload at 150% of rated current at a power factor of 75%.
Mechanical	
Terminal Identification	Terminals identified in accordance with UL498 and CSA (Brass, White, Green).
Terminal Accommodation	#18-10 AWG copper conductors only.
Product Identification	Ratings are a permanent part of the device.
Torque Range	12 in./lb. terminal screws, 7 in./lb. assembly screws.
Cord Diameter Range	.230–.720 in. (5.8–18.3) integral cord grip.
Environmental – Material	
Flammability	UL 94HB or better.
Operating Temperature	Maximum continuous 75°C; minimum – 40°C (w/o impact).

Straight Blade Devices

Technical Information

Valise® Plugs and Connectors



HBL5965VY



HBL5969VY

Specifications

Plugs	Part	Description
Typical Specification – Catalog No. HBL5965VY	Plug	15A
Manufacturer's Identification – Hubbell HBL5965VY	Housing	Nylon
Description – Straight Body Plug	Contact Blades	Brass
Type – 2 Pole, 3 Wire, Grounding	Ground Blade	Brass
Rating – 15A, 125V	Line Terminal Screws	Steel-Copper, Multiple Drive
Verified to Fed. Spec. WC596	Ground Screw	Steel (Green), Multiple Drive
Certification – UL Listed to UL 498 File E1706, CSA Certified to C22.2 No. 42 File 280C	Cable Inserts	Poly Phenylene Oxide
IP Suitability – IP20	Wire Clamps	Steel
	Body Holding Screws	Steel, Multiple Drive
Connector Bodies	Part	Connector
Typical Specification – Catalog No. HBL5969VY	Connector Body	15A
Manufacturer's Identification – Hubbell HBL5969VY	Housing	Nylon
Description – Straight Body Connector	Contact and Ground Springs	Brass
Type – 2 Pole, 3 Wire, Grounding	Line Terminal Screws	Steel-Copper, Multiple Drive
Rating – 15A, 125V	Ground Screw	Steel (Green), Multiple Drive
Verified to Fed. Spec. WC596	Cable Inserts	Poly Phenylene Oxide
Certification – UL Listed to UL 498 File E1706, CSA Certified to C22.2 No. 42 File 280C	Wire Clamps	Steel
IP Suitability – IP20	Body Holding Screws	Steel, Multiple Drive

Performance

Electrical	
Dielectric Voltage	Withstands 2,000V minimum.
Max. Working Voltage	125V or 250V as rated.
Current interrupting	Certified for current interrupting at full rated current.
Temperature Rise	Max 30°C temperature rise at full rated current after 50 cycles of overload at 150% of rated current at a power factor of 75%.
Mechanical	
Terminal Identification	Terminals identified in accordance with UL 498 and CSA (Brass, White, Green).
Terminal Accommodation	Copper conductors only. 2 Wire 15A Only #18-14 AWG, 2 Wire 20A & 3 Wire #18-12 AWG, Hospital Grade #16-12 AWG, I.D. Valise #18-16 AWG.
Product Identification	Molded Rating on Device Face.
Torque	12 in./lb. terminal screws, 7 in./lb. assembly screws.
Cord Diameter Range	2-Wire 15A Only .218–.385 in. (5.5–9.8), 2-Wire 20A & 3 Wire .220–.660 in. (5.6–16.8), Hospital Grade .300–.660 in. (7.6–16.8), I.D. Valise .230–.360 in. (5.8–9.1).
Environmental – Material	
Flammability	UL 94V-2.
Operating Temperature	Maximum continuous 75°C; minimum -40°C (w/o impact).
Standards	
NEMA® WD1	
NEMA® Configurations	
Listed to UL Standard UL498	
Certified to CSA Standard C22.2 No. 42	
Verified to Federal Spec WC596	

NEMA® is a registered trademark of the National Electrical Manufacturers Association.

Straight Blade Devices

Technical Information



IEC 320 Devices

Specifications

Receptacle

Catalog Number	H320R
Description	IEC Configuration compatible straight blade panel mount receptacle.
Type	2 Pole + earth.
Rating	16A 250V AC for European service; 20A 250V AC for North American service.
Certification	UL Listed 20A 250V AC – File No. E2186; CSA Certified 20A 250V AC – File No. 17337.
Terminal Accommodation	North American – #16-12 AWG stranded or solid copper conductor only. International – 1.55mm ² –2.5mm ² .

Connector

Catalog Number	H320C
Description	IEC Detachable straight blade connector.
Type	2 Pole + earth.
Rating	16A 250V AC for European service; 20A 250V AC for North American service.
Configuration	IEC 60320-1 Style appliance coupler, C19.
Certification	UL Listed 20A 250V AC – File No. E1706; CSA Certified 20A 250V AC – File No. 17337; UL Classified to IEC 320, 16A 250V AC – File No. E111246;
Cord Accommodation	North American – 16/3SJ-12/3SJ (.325–.475 in. dia.); International – (HAR cord) 3x1.5mm ² –3x2.5mm ² (8mm–12mm dia.).
IP Suitability	IP20.

Plug

Catalog Number	H320P
Description	IEC Configuration compatible straight blade Valise® plug.
Type	2 Pole + earth.
Rating	16A 250V AC for European service; 20A 250V AC for North American service.
Certification	UL Listed 20A 250V AC – File No. E1706; CSA Certified 20A 250V AC – File No. 17337.
Cord Accommodation	North American – 16/3 SJ-12/3SJ (.325–.475 in. dia.); International – (HAR cord) 3x1.5mm ² 3x2.5mm ² (8–12mm dia.).
IP Suitability	IP20.

Inlet

Catalog Number	H320B and H320BL
Description	IEC Straight blade panel mount power inlet.
Type	2 Pole + earth.
Rating	16A 250V AC for European service; 20A 250V AC for North American service.
Configuration	IEC 60320-1 Style appliance coupler, C20.
Certification	UL Listed 20A 250V AC – File No. E1706; CSA Certified 20A 250V AC – File No. 17337; UL Classified to IEC 320, 16A 250V AC – File No. E111246; VDE Certified at 16A 250V AC – File No. 12469 1550 1002.
Terminal Accommodation	North American – #16-12 AWG stranded or solid copper conductor only. International – 1.5mm ² –2.5mm ² .

Straight Blade Devices

Technical Information

Heavy Duty Insulgrip® Plugs and Receptacles



HBL9431C



HBL9430A

Specifications

Plug	Part	Description
Typical Specification - Catalog No. HBL9431C	Plug	30A
Manufacturer's identification - Hubbell HBL9431C	Housing	Supertough Nylon
Description - Straight Body Plug	Blade Holder & Retainer	Reinforced Thermoplastic Polyester
Type - 3 Pole, 4 Wire, Grounding	Blades	Brass
Rating - 30A, 125/250V	Terminal Screws	3/8 in. Allen Head, Plated Steel
Certification - UL Listed File E1706, CSA Certified*	Box Terminals	Copper Alloy
IP Suitability - IP20	Cord Clamps	Reinforced Thermoplastic Polyester
	Mounting and Clamp Screws	Stainless Steel
	Cord Grip Range	.625–1.310 in. (15.9–33.3)
Receptacle	Part	Description
Typical Specification - Catalog No. HBL9430A	Receptacle	30A
Manufacturer's Identification - Hubbell HBL9430A	Housing Construction	Reinforced Thermoplastic Polyester
Description - Single Receptacle	Mounting Plate	.062 in. (1.5) Pre-Plated Steel
Type - 3 Pole, 4 Wire, Grounding	Contacts	Brass
Rating - 30A, 125/250V	Ground Shunt	Brass
Certification - UL Listed File E2186, CSA Certified	Terminal Screws	3/8 in. Allen Head, Plated Steel
	Box Terminals	Copper

Performance

Electrical	
Dielectric Voltage	Withstands 2,000V minimum.
Max. Working Voltage	125V or 250V as rated.
Current Interruption	Certified for current interrupting at full rated current.
Temperature Rise	Max 30°C temperature rise at full rated current after 50 cycles of overload at 150% of rated current at a power factor of 75%.
Mechanical	
Terminal Identification	Terminals identified in accordance with UL 498 (Brass, White, Green).
Terminal Accommodation	#12 AWG through #4 AWG copper wire only.
Production Identification	Ratings are a permanent part of the device.
Environmental	
Flammability	Receptacle: UL 94 VO. Plug: UL 94 HB (Housing), UL 94 VO (Blade Holder and Retainer).
Operating Temperature	Maximum continuous 60°C, minimum -40°C (w/o impact).

Note: *Listed to UL Standard 498 (Attachment Plugs and Receptacles), Certified to CSA Standard 42M (General Use Receptacles, Attachments, Plugs and Singular Wiring Devices) where applicable.

SECTION B

Table of Contents



Twist-Lock® Devices



50A Twist-Lock® Devices



Hubbellock® Devices



Product	Page
Products at a Glance	B-2
Insul-Lock™ Plus & Insul-Lock™ Devices	B-4
Midget Twist-Lock® Devices	B-6
Midget Twist-Lock® Accessories	B-8
Twist-Lock® Devices	
15 Amp	B-11
20 Amp	B-19
30 Amp	B-28
Compatibility and Environmental Protection Chart	B-18
Switched Safety Enclosures	B-39
Mechanical Interlock Switched Safety Enclosures	B-41
Add-A-Shroud®	B-42

Product	Page
Non-NEMA Twist-Lock® Devices	
10 Amp	B-43
20 Amp	B-44
30 Amp	B-47
Variload® Twist-Lock® Devices	B-49
Accessories	
15 Amp	B-50
20 and 30 Amp	B-52
Safety-Shroud® Boxes	B-54
50A Twist-Lock® Devices	B-56
50A Accessories	B-60
Hubbellock® Devices	B-61
Hubbellock® Accessories	B-68
Technical Information	B-69

Twist-Lock® Devices

Products at a Glance



Insul-Lock™ Plus Connectors

- 20A 250V AC rated
- Rated for disconnect under load
- IP65 rated
- Interchangeable with other similar brands

Insul-Lock™ Connectors

- 25A 250V AC and DC rated
- Do not connect or disconnect under load
- Color coded blue for power in & gray for power out



50 Amp Insulgrip® Devices

- Heavy duty design built for heavy duty applications
- Thermoplastic cord grips are designed with offset gripping jaws to hold connectors as well as the jacket
- Stainless steel shroud restricts mismatching with the wrong device
- Padlock capable shroud allows compliance to OSHA lockout/tagout regulation 29 CFR 1910.147



Midget Twist-Lock® Devices

- Smaller body size for use in tighter fit applications where larger products can't
- Abuse resistant nylon housing

Midget Valise® Devices

- Powerful, cord-gripping jaws designed to eliminate conductor slip and strain on terminals
- Patented locking lugs interlock the two sections together providing a secure assembly



Insulgrip® Twist-Lock® Devices

- Tough ribbed nylon housing for secure gripping
- Insulated nylon construction to keep non-current carrying parts from becoming energized
- Integral dust shield protects wiring chamber from dust and contaminants
- Voltage color coding on receptacle face facilitates proper mating of devices



Hubbelock® Devices

- Enhanced safety because access to live female contacts is restricted by the spring-loaded safety shutter
- No "lazy" connections because a spring-loaded safety shutter automatically ejects the plug if it hasn't been properly locked into the female device. This eliminates teasing of the contacts, a major cause of contact burn-up



Safety-Shroud® Twist-Lock® Devices

- Tough nylon shroud protect blades from damage and abuse
- Prevents exposure to potential arc
- Lockout/tagout hole allows compliance with OSHA regulation 29 CFR 1910.147
- Accepts conventional NEMA locking plugs



Watertight Safety-Shroud® Devices

- Gland seal prevents water ingress at cord entrance
- Strong PBT body for heavy duty applications
- Closure cap creates environmental seal when device is not in use
- Visible color coded rating label on devices ensure proper mating

Twist-Lock® Devices

Features and Benefits

Miniature 20 & 25 Amp Power Connections for Entertainment Applications

Ideal for use with LED lighting and other applications including multiple screen video walls. The rear of the connector is black to blend in when used in visible areas.

Available in both inline and panel mount styles, Hubbell's Insul-Lock™ Connectors have a quick release, vibration resistant latch. Hubbell's connections intermate with other similar brands.

Insul-Lock™ Plus Connectors

- 20A 250V AC rated
- Rated for disconnect under load
- IP65 rated
- Panel mount devices accept commonly available .25" spade style connectors
- Industry standard mating, interchangeable with installed base

Insul-Lock™ Connectors

- 25A 250V AC and DC rated
- Do not connect or disconnect under load
- Color coded blue for power in and gray for power out
- Industry standard mating Interchangeable with installed base
- Impact-resistant thermoplastic construction; suitable for use in UL1640 applications



Housing Design

- 20A 250V AC rated
- Impact-resistant thermoplastic construction
- Industry standard mating, interchangeable with installed base
- UL 50E enclosure Type 4 rated when used with mating connector or with panel mount and watertight cover



Connector Housing

- 25A 250V AC and DC rated
- Insulgrip style body design for a secure grip
- Color coded blue for power in and gray for power out
- Do not connect or disconnect under load



Connector Body

- Connectors accept up to 12/3 AWG SO cable which meets NEC 520.68 requirements for extra-hard usage cords or cables
- Multiple strain relief collets to accommodate cable range



Locking Latch

- Turn and latch feature prevents nuisance disconnects
- Quick release locking latch to ensure positive connection
- Connectors accept up to 12/3 AWG SO cable meets NEC 520.68 requirements for extra-hard usage cords or cables

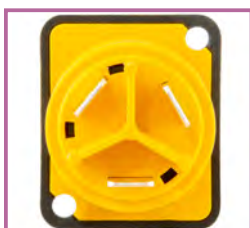

Contacts

- Panel mount devices accept commonly available .25" spade style connectors



Panel Mount

- Divided panel mounts available for use with non-insulated terminations
- Panel mount devices accept commonly available .25" spade style connectors; simplifies installation for domestic OEM's

Twist-Lock® Devices

Miniature 20 & 25 Amp Power Connections for Entertainment Applications



Insul-Lock™ Plus Inline Connectors

Description	Male Connector Power In	Female Connector Power Out
20 Amp locking cable connector, screw terminals	HBLMC	HBLFC

Insul-Lock™ Plus Panel Mounts

Description	Inlet	Outlet
20 Amp ¼" tab terminations without divider	HBLMP	HBLFP
20 Amp ¼" tab terminations, with divider	HBLMPD	HBLFPD

Insul-Lock™ Plus Accessories

Description	Inlet	Outlet
Spring loaded watertight cover	HBLMPC	HBLFPC
Watertight dust protection cap with chain	HBLMPDC	HBLFPDC

Insul-Lock™ Plus Certifications

UL Recognized component for USA and Canada
 Connectors are rated UL50E Enclosure type 4X when used with mating connector or with panel mount and watertight cover.
 Panel Mounts are rated UL50E Enclosure type 4X with the cover closed or with the mating connectors.
 IP65 Rated
 Rated for connection and disconnection under load.



Insul-Lock™ Inline Connectors



Description	Male Connector Power In (Blue)	Female Connector Power Out (Gray)
25 Amp locking cable connector, screw terminals	HBLCPIBL	HBLCPOGY

Insul-Lock™ Panel Mounts

Style	Power In (Blue)	Power Out (Gray)
25 Amp ¼" tab terminations without divider	HBLPMIBL	HBLPMOGY
25 Amp ¼" tab terminations with divider	HBLPMIDBL	HBLPMODGY

Insul-Lock™ Accessories

Description	Catalog Number
Panel mount retainer plate (also compatible with HBLMP & HBLMPD)	HBLPMRP
Panel mount M3x.5 screw, 8mm long	HBLPMSC

Insul-Lock™ Certifications

UL Recognized component for USA and Canada
 VDE Certified
 Do not connect or disconnect under load.



Dimensions in Inches (mm)

Twist-Lock® Devices

Features and Benefits

Midget 15 Amp Plugs and Connector Bodies

Hubbell's Valise® insulation displacement terminal for Midget Twist-Lock® Plugs and Connector Bodies are the right choice for economy, wiring speed and long life.

- Nylon webs join two sections together which makes assembly of the Valise® style device quick and easy
- Patented locking lugs interlock the two sections together when the device is assembled providing a secure assembly
- Powerful, cord-gripping jaws designed to eliminate conductor slip and strain on terminals
- "TURN & PULL" marking is highly visible, reducing possible damage to equipment by attempting disconnection prior to unlocking



Note: The cut-away views below are construction elements pertaining specifically to the Valise® style series.



Housing Design

- Totally insulated body adds extra measure of safety
- Abuse resistant nylon housing



Contacts

- The insulation displacement terminal reduces the time required for wire preparation and provides uniformity in the quality of termination
- Powerful, cord-gripping jaws designed to eliminate conductor slip and strain on terminals

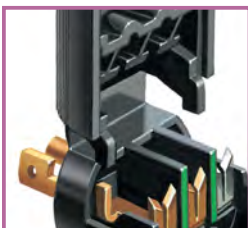

One-Piece Design

- Nylon webs join two sections together which makes assembly of the device quick and easy
- Patented locking lugs interlock the two sections together when the device is assembled providing a secure assembly, even in the most abusive environments



Assembly

- Assembly screws have multiple drive heads for screwdriver versatility. Only two assembly screws are needed to close this device, make the wire terminations and retain the cord



Identification

- Rating marked on surface provides quick, sure circuit identification



Markings

- "TURN & PULL" marking is highly visible, reducing possible damage to equipment by attempting disconnection prior to unlocking

Midget Plugs and Flanged Inlets



HBL7465V



HBL7594V

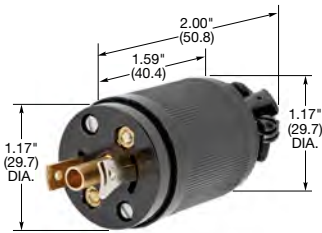

HBL7594



HBL7570

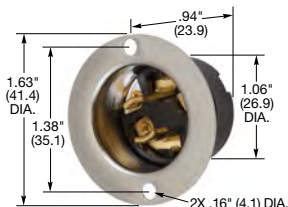

HBL7466, HBL7467

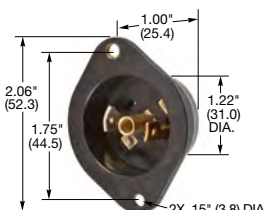

HBL7595N

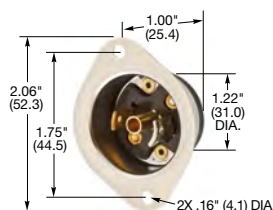

HBL7595

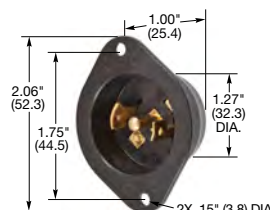

HBL7486N

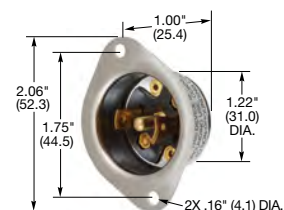

HBL7486

IP20
SUITABILITY

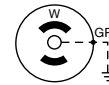

15A 125V NEMA ML-1P	15A 125V NEMA ML-2P	15A 125/250V AC NEMA ML-3P
--------------------------------	--------------------------------	---------------------------------------

Plugs

Description	Cord Dia.	Catalog Number		
Valise® plug, black nylon, multiple drive screw terminals.	.220"-.385" (5.6-9.8)	HBL7465V*	—	—
Valise® plug, black nylon, insulation displacement terminals.	.300"-.430" (7.6-10.9)	—	HBL7594V	—
Black nylon cover, phenolic body, multiple drive screw terminals.	.281"-.421" (7.1-10.7)	—	HBL7594	—
Angle plug, black nylon cover, phenolic body, multiple drive screw terminals.	.335"-.421" (8.5-10.7)	—	HBL7570	—
Valise® plug, black nylon, with insulation displacement terminals.	.300"-.430" (7.6-10.9)	—	—	HBL7485V*
Black nylon body, phenolic base, multiple drive screw terminals, cord grip.	.281"-.421" (7.1-10.7)	—	—	HBL7485*
Same as above, except angle cord grip.	.335"-.421" (8.5-10.7)	—	—	HBL7432*

Flanged Inlets

Description	Catalog Number		
Stainless steel flange, polarized, exposed terminals.	HBL7467*	—	—
Stainless steel flange, not polarized, exposed terminals.	HBL7466*	—	—
Exposed terminals, black nylon flange.	—	HBL7595N	—
Exposed terminals, stainless steel flange.	—	HBL7595	—
Covered terminals, stainless steel flange, accepts cord .500" (12.7) dia.	—	HBL7551	—
Exposed terminals, black nylon flange.	—	—	HBL7486N*
Exposed terminals, stainless steel flange.	—	—	HBL7486*

Note: See page B-8 for accessories.

*UL Listed only.

Male ML-2P devices have hollow center ground sleeves.

Male ML-3P devices have solid center neutral pins.

Dimensions in Inches (mm)

Midget Connector Bodies and Flanged Receptacles

IP20
SUITABILITY

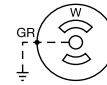

Connector Bodies

Description	Cord Dia.	Catalog Number		
		15A 125V NEMA ML-1R	15A 125V NEMA ML-2R	15A 125/250V AC NEMA ML-3R
Valise® connector body, black nylon, polarized, multiple drive screws.	.220"-.385" (5.6-9.8)	HBL7464V*	-	-
Valise® connector body, black nylon, insulation displacement terminals.	.300"-.430" (7.6-10.9)	-	HBL7593V	-
Black nylon cover, phenolic body, screw terminals.	.281"-.421" (7.1-10.7)	-	HBL7593	-
Angle connector body, black nylon cover, phenolic body, screw terminals.	.335"-.421" (8.5-10.7)	-	HBL7571	-
Valise® type, black nylon, with insulation displacement terminals.	.300"-.430" (7.6-10.9)	-	-	HBL7484V*
Black nylon body, phenolic base, cord grip.	.281"-.421" (7.1-10.7)	-	-	HBL7484*
Same as above, except for angle cord grip.	.335"-.421" (8.5-10.7)	-	-	HBL7433*

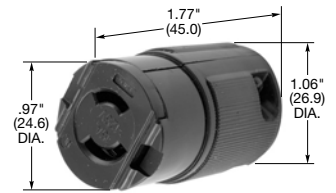

HBL7464V



HBL7593V



HBL7593

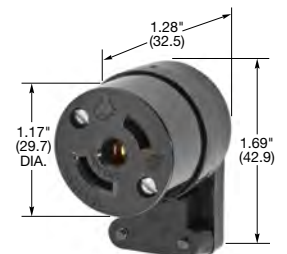

HBL7571



HBL7484V

Flanged Receptacles

Description	Catalog Number		
Stainless steel flange, exposed terminals.	HBL7468*	-	-
Exposed terminals, black nylon flange.	-	HBL7596N	-
Exposed terminals, stainless steel flange.	-	HBL7596	-
Covered terminals, stainless steel flange, accepts cord .500" (12.7) in dia.	-	HBL7598	-
Exposed terminals, black nylon flange.	-	-	HBL7487N*
Exposed terminals, stainless steel flange.	-	-	HBL7487*
Covered terminals, stainless steel flange, accepts cord .500" (12.7) in diameter.	-	-	HBL7489*

Note: See page B-8 for accessories.

*UL Listed only.

Female ML-2R devices have solid center ground pins.

Female ML-3R devices have hollow center neutral sleeves.

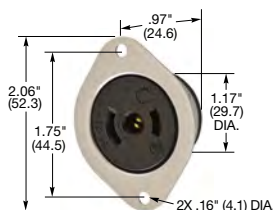

HBL7596

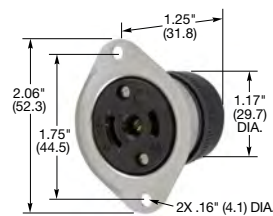

HBL7598

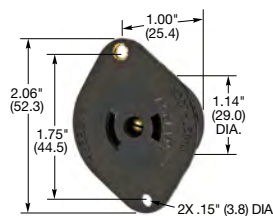

HBL7596N

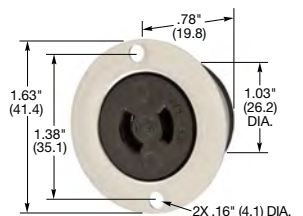

HBL7468

Dimensions in Inches (mm)

Midget Accessories



HBL7490V



HBL7459V



HBL4890



HBL7495V



HBL7440V



HBL4889

Weatherproof Accessories for ML-1

Description	Catalog Number
Seal-tite® cover, black elastomer, for use with a HBL7465V plug when used with a HBL7464V connector body or a HBL7464V connector when used with a flanged inlet.	HBL7490V*
Seal-tite® cover, black elastomer, for use with a HBL7464V connector body and combination of HBL7465V plug and HBL7490V cover.	HBL7459V*
Closure cover for use with HBL7466 or HBL7467. Bead chain is nickel-plated.	HBL4890

Weatherproof Accessories for ML-2

Description	Catalog Number
Seal-Tite® cover, black elastomer, for use with a HBL7594V plug when used with a HBL7593V connector body or a HBL7593V connector body when used with a flanged inlet.	HBL7495V*
Seal-Tite® cover, black elastomer, for use with a HBL7593V connector body and a combination of HBL7594V plug and HBL7495V cover.	HBL7440V*
Closure cover for use with HBL7595 or HBL7595N.	HBL4889

Weatherproof Accessories for ML-3

Description	Catalog Number
Seal-Tite® cover, black elastomer, for use with a HBL7485V or HBL7485 plug when used with a HBL7484V or HBL7484 connector body when used with a flanged inlet.	HBL7495V*
Seal-Tite® cover, black elastomer, for use with a HBL7484V or HBL7484 connector body and a combination of HBL7485V or HBL7485 plug and HBL7495V cover.	HBL7440V*
Closure cover for use with HBL7486 or HBL7486N.	HBL4889

*Note: *IP55 suitability when installed and used properly with plug and connector body combinations.*

Dimensions in Inches (mm)

Twist-Lock® Devices

Features and Benefits

Insulgrip® 15 Amp Plugs and Connector Bodies

Insulgrip products are synonymous with Hubbell's ongoing commitment to discovering ways to make products safer and last longer.

By encasing wiring devices in tough nylon housings, Insulgrip devices ensure high impact, heat, and chemical resistance while insulating current-carrying components from the user for maximum safety.

- The Insulgrip's cord gripping design clamps conductors, not just the cable jacket, making it the industry's most powerful cord grip with superior strain relief
- Each Insulgrip device is manufactured with roomy, separate wiring chambers to insulate conductors and an individually molded face to keep out dust and debris that can cause contamination over time



Housing Design

- Ribbed nylon housing provides a secure grip that's impact and chemical resistant
- Beveled housing prevents snagging when dragged across uneven surfaces
- Individually molded face for each blade configuration keeps debris out of plug interior

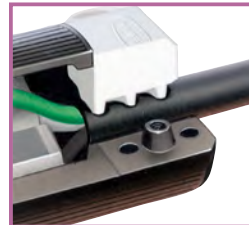

Internal Design

- Powerful cord grips clamp on individual conductors and outer cord jacket to prevent strain on terminations
- Individual wiring terminals are completely enclosed in their own separate chambers



Cord Range

- Integral VARI-SIZE® insert adjusts to a wide range of cord sizes: .230-.720 inch (5.8-18.3)
- VARI-SIZE® pointer set to "smaller than gauge" position. Cord diameter range is .230-.360 inch (5.8-9.0). Accepts slotted and Phillips head drivers



Assembly

- "Multiple drive" screw heads provide screwdriver versatility. Pocketed recess for cord grip screws deters slippage of the screwdriver



Identification

- Catalog number is visible on the device while in use for easy identification



Visual Verification

- Transparent angled wiring entrance holes guide conductor insertion and allow for quick visual verification of terminations

Twist-Lock® Devices

Features and Benefits

15 Amp Duplex Twist-Lock® Receptacles

Hubbell Wiring Device-Kellems line of duplex Twist-Lock® receptacles are designed to deliver premium service and longer life. This rugged product design establishes a new standard for 15 amp locking receptacles. A reinforced thermoplastic top and base encapsulates the brass alloy contacts that are locked together for unequalled assembly strength. Wiring and installation is simplified with back and side wire terminations, integral wire restraints, and combination head screws. The integral split circuit capability offers flexibility. Available in 2 pole, 3 wire configurations including isolated ground and corrosion resistant versions.

- Superior spring characteristics for increased contact force, secure connections and longer life
- High-conductivity, corrosion resistant material for reliable, low resistance to fault currents
- Easy and reliable installation for stranded and solid wire
- Features split circuit capability in the field
- The assembly locks together to make the most abuse resistant receptacle ever



Housing Design

- Reinforced thermoplastic construction
- High impact and heat resistance provides maximum safety and longer life



Terminals

- Single point break-off tabs
- High performance internal wiring clamps and open terminal design provide for the use of forked terminals



One-Piece Design

- Mounting strap tabs lock the body and base together
- Brass mounting strap with stainless steel grounding clip



Contacts

- Single piece, all brass contacts
- All terminals are back and side wired including the ground



Identification

- Rating marked on surface provides quick, sure circuit identification



Center Rivet

- Square head, 10-thread bronze center rivet won't rotate, reduces stripping and resists corrosion

15 Amp, 125 Volts
2 Pole, 2 Wire, Non-Grounding

IP20
 SUITABILITY



15A 125V
NEMA L1-15P
0.5 HP

Plugs

Description	Cord Dia.	Catalog Number
Black and white nylon, polarized. Multiple drive screws.	.230"-.720" (5.8-18.3)	HBL7545C

Note: See page B-51 for accessories.

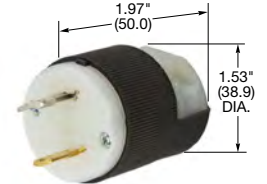

HBL7545C

Flanged Inlets

Description	Catalog Number
Nylon casing, polarized, backwired, Multiple drive screws.	HBL7524C

Note: See page B-50 for accessories.



15A 125V
NEMA L1-15R
0.5 HP

Connector Bodies

Description	Cord Dia.	Catalog Number
Black and white nylon. Multiple drive screws.	.230"-.720" (5.8-18.3)	HBL7506C

Note: See page B-51 for accessories.

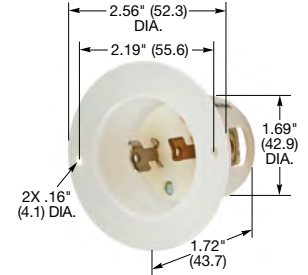

HBL7524C

Receptacles

Description	Catalog Number
Duplex, flush, black phenolic.	HBL7540
Single, flush, black phenolic.	HBL7535
Single, panel mount, 1 ⁵ / ₁₆ " (49.2) centers, black phenolic.	HBL7498

Note: See pages B-50 and B-51 for accessories.

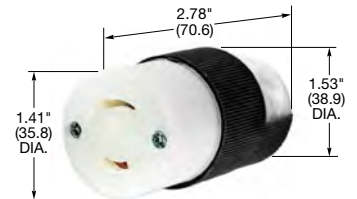

HBL7506C

Flanged Receptacles

Description	Catalog Number
Insulgrip nylon casing, backwired. Multiple drive screws.	HBL7526C
Metal flange, stainless steel casing, black phenolic, exposed terminals.	HBL7526

Note: See pages B-50 and B-51 for accessories.
 Only receptacles and plugs are HP rated.
 HP ratings are AC only.

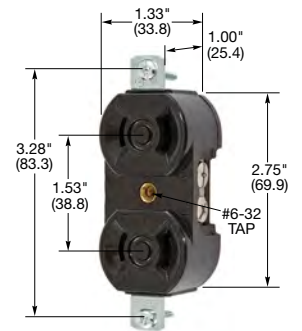

HBL7540

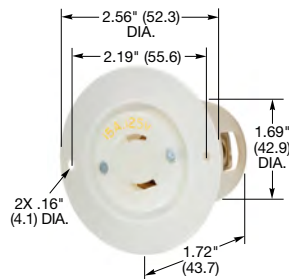

HBL7526C

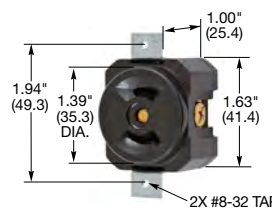

HBL7498

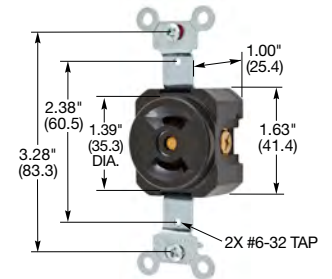

HBL7535

Dimensions in Inches (mm)

**15 Amp, 125, 250 Volts and 277 Volts AC
2 Pole, 3 Wire, Grounding**

IP20
SUITABILITY

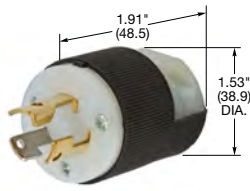

HBL4720C

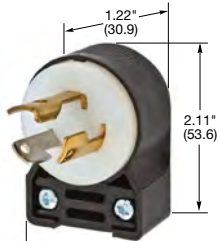

HBL4720CA

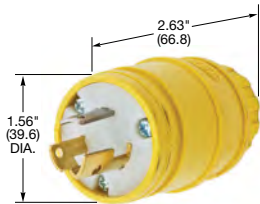

HBL24W47

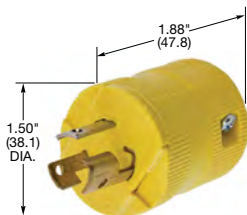

HBL4723VY

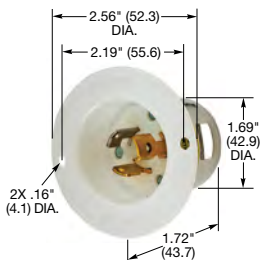

HBL4716C

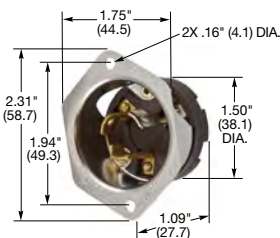

HBL4716

Dimensions in Inches (mm)

Plugs

Description	Cord Dia.	Catalog Number		
		15A 125V NEMA L5-15P 0.5 HP	15A 250V NEMA L6-15P 1.5 HP	15A 277V AC NEMA L7-15P 2 HP
Insulgrip plug, black and white nylon. Multiple drive screws. Fed Spec WC596	.230"-.720" (5.8-18.3)	HBL4720C	HBL4570C	HBL4770C
Insulgrip plug, black and white, spring termination Fed Spec WC596	.230"-.720" (5.8-18.3)	HBL4720CST	HBL4570CST	HBL4770CST
All black nylon.	.230"-.720" (5.8-18.3)	HBL4720CBK	-	-
Insulgrip angle plug, 8 position angle, black and white nylon. Multiple drive screws.	.325"-.655" (8.3-16.6)	HBL4720CA	HBL4570CA	HBL4770CA
Insulgrip plug, corrosion resistant, yellow and white nylon. Multiple drive screws. Fed Spec WC596	.230"-.720" (5.8-18.3)	HBL47CM20C	HBL45CM70C	HBL47CM70C
Elastogrip® plug, yellow elastomer, dust tight.	300"-.655" (7.6-16.6)	HBL2447	-	-
Elastogrip plug, yellow elastomer, water/dust tight.	300"-.655" (7.6-16.6)	HBL24W47	-	-
Valise® plug, yellow nylon.	.220"-.660" (5.6-16.8)	HBL4723VY	HBL4573VY	HBL4773VY
Valise® plug, black nylon.	.220"-.660" (5.6-16.8)	HBL4723VBK	HBL4573VBK	HBL4773VBK

Note: See page B-51 for accessories.

Flanged Inlets

Description	Catalog Number		
Insulgrip flanged inlet, nylon casing, back wired.	HBL4716C	HBL4586C	HBL4786C
Stainless steel casing, brown phenolic.	HBL4716*	HBL4586*	HBL4786*
Corrosion resistant, stainless steel casing, yellow melamine.	HBL47CM16*	-	-

Note: See page B-50 for accessories.

HP ratings are AC only.

Only plugs are HP rated.

See page B-69 for technical information on Insulgrip devices.

*These flanged inlets will not accept Valise® connector bodies.

**15 Amp, 125, 250 Volts and 277 Volts AC
2 Pole, 3 Wire, Grounding**

IP20
SUITABILITY



**15A 125V
NEMA L5-15R
0.5 HP**

**15A 250V
NEMA L6-15R
1.5 HP**

**15A 277V AC
NEMA L7-15R
2 HP**

Connector Bodies

Description	Cord Dia.	Catalog Number		
Insulgrip connector body, black and white nylon. Multiple drive screws.	.230"-.720" (5.8-18.3)	HBL4729C	HBL4579C	HBL4779C
Insulgrip connector body, black and white body. Spring Termination	.230"-.720" (5.8-18.3)	HBL4729CST	HBL4579CST	HBL4779CST
All black nylon.	.230"-.720" (5.8-18.3)	HBL4729CBK	-	-
Insulgrip connector body, 8 position angle, black and white nylon. Multiple drive screws.	.325"-.655" (8.3-16.6)	HBL4729CA	-	-
Insulgrip connector body, corrosion resistant, yellow and white nylon. Multiple drive screws.	.230"-.720" (5.8-18.3)	HBL47CM29C	HBL45CM79C	HBL47CM79C
Elastogrip connector body, yellow elastomer, dust tight.	.300"-.655" (7.6-16.6)	HBL2547	-	-
Elastogrip® connector body, yellow elastomer, water/dust tight.	.300"-.655" (7.6-16.6)	HBL25W47**	-	-
Valise® connector body, yellow nylon.	.220"-.660" (5.6-16.8)	HBL4729VY	HBL4579VY	HBL4779VY
Valise® connector body, black nylon.	.220"-.660" (5.6-16.8)	HBL4729VBK	HBL4579VBK	HBL4779VBK

Note: See page B-49 for accessories.

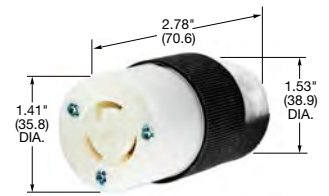

HBL4729C



HBL4729CBK

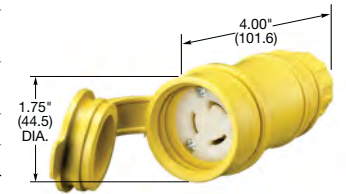

HBL25W47

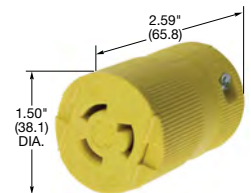

HBL4729VY

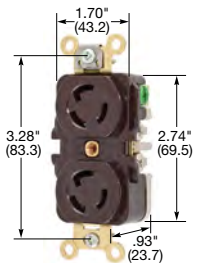

HBL4700ST

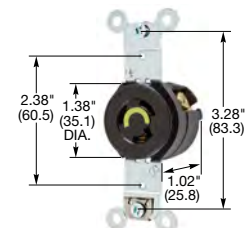

HBL4710ST

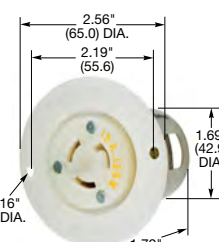

HBL4715C

Dimensions in Inches (mm)

Receptacles

Description	Catalog Number		
Duplex, flush, brown RTP face, back and side wired.	HBL4700*	HBL4550*	HBL4750*
Duplex, flush, ivory RTP face, back and side wired.	HBL4700I*	-	-
Duplex, flush, brown, spring termination	HBL4700ST	HBL4550ST	HBL4750ST
Duplex, ring terminal connection.	HBL4700RT*	HBL4550RT*	-
Duplex, isolated ground, flush, orange RTP face, back and side wired.	IG4700A*	IG4550A*	-
Duplex, isolated ground, flush, orange face, spring termination	IG4700AST	-	-
Duplex, corrosion resistant, yellow RTP face, back and side wired.	HBL47CM00*	-	-
Single, flush, black nylon face, back and side wired.	HBL4710	HBL4560	HBL4760
Single flush, black face, spring termination	HBL4710ST	HBL4560ST	HBL4760ST
Same as HBL4760 without mounting screws, ears. Terminal screws backed out, back and side wired. This item is bulk packed 100 pcs case.	-	-	HBL4760C
Single, ring terminal connection.	HBL4710RT	HBL4560RT	-
Single, isolated ground, flush, orange nylon face, back and side wired.	IG4710	IG4560	-
Single, Isolated ground, flush, orange, spring termination	IG4710ST	-	-
Single, black nylon face mounted on a 4" (101.6) round box cover, back and side wired.	HBL4711	-	HBL4761
Single, panel mount, black nylon face, side wired only, 1.75" or 1.937" (44.5 or 49.2) mounting centers.	HBL4713	HBL4563	HBL4763
Single, panel mount, black face, spring termination, 1.75" or 1.937" (44.5 or 49.2) mounting centers	HBL4713ST	HBL4563ST	-

Note: See pages B-50 and B-51 for accessories.

Flanged Receptacles

Description	Catalog Number		
Insulgrip flanged receptacle, nylon casing, back wired.	HBL4715C	HBL4585C	HBL4785C
Stainless steel casing, brown phenolic.	HBL4715	HBL4585	HBL4785
Corrosion resistant, stainless steel casing, yellow melamine.	HBL47CM15	-	-

Note: See pages B-50 and B-51 for accessories.

HP ratings are AC only.

RTP is an abbreviation for reinforced thermoplastic polyester.

See section N for additional information on isolated ground devices.

*Supplied with break-off tabs for split circuit wiring.

**Watertight connector body IP55 suitability when closure plug is inserted or when installed and used properly with watertight plug.

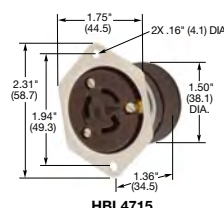

HBL4715C

Twist-Lock® Devices

Features and Benefits

Insulgrip® 20 and 30 Amp Plugs and Connector Bodies

Our 20 and 30 amp Insulgrip® plugs and connectors maintain Hubbell's classic integrity, solid construction and safety features that make these devices the "industry standard".

Insulgrip's cord gripping design clamps the conductors, not just the cable jacket, making it the industry's most powerful cord grip. The cord grips also provide a clean, one-piece look and makes it stronger.

Insulgrip's design guards against contamination. The nylon body and housing of the plugs and connectors are resistant to industrial chemicals, solvents and hydrocarbons. The face of each plug is molded specific to the blade configuration, eliminating holes that attract debris. And finally, our dust shield provides additional protection from contamination.

Additional features that make Insulgrip the industry standard are our improved contacts that provide better terminations, an exclusive double rivet design for the female contacts and an easy to read identification system.

The Hubbell Twist-Lock® line of plugs and connectors remain the broadest in the industry. Hubbell has you covered – proven performance, innovation and selection.



Housing Design

- Tough ribbed nylon housing for secure gripping
- Insulated nylon construction to keep non-current carrying parts from becoming energized

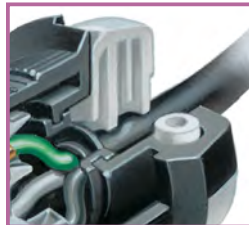

Internal Design

- Integral dust shield protects wiring chamber from dust or contaminants. Single-piece shield/housing eliminates need for separate step at installation
- Wiring chambers separate and positively insulate conductors and promote easy inspection



Cord Range

- Two-part cord grip tightens with two screws for maximum retention force
- Broad gripping area to accommodate wide range of cable diameters

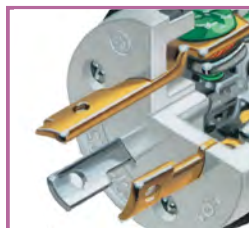

Assembly

- Self-threading screws specially designed for secure assembly



Identification

- Product identification is visible while device is in use. Markings include catalog number and ratings printed in the IEC color scheme on the current-carrying portion of the device



Contacts

- Improved terminations include #10 multiple drive screws and thicker .080 inch clamping nuts
- Funneled holes to permit "straight-in" conductor insertion
- Contoured binding plates ensures strong wire retention

Twist-Lock® Devices

Features and Benefits

Insulgrip® Standard Locking Receptacles

Twist-Lock® receptacles combine functional design features, unparalleled quality to deliver ultimate performance.

The high-impact nylon face of each Hubbell Twist-Lock receptacle has a colored ring. Keyed to an internationally recognized color coding scheme, this ring enables mating devices to be matched quickly. It's just one more example of user-oriented thinking at Hubbell.

The terminals in each Hubbell Twist-Lock receptacle are mechanically and electrically the finest available. These terminals incorporate unique design features to contain and hold conductors, including an external back wiring "wraparound" clamp, a wire restraint recess and more.

The materials used in every receptacle are of the highest quality. The all brass mounting system provides a safer, lower resistance ground path than those made of steel. The thick wall base is constructed of an engineered thermoplastic to offer the benefits of a thermoset, yet with much greater impact resistance.

Hubbell Twist-Lock Receptacles: Voltage color coding on the outside. Proven designs and quality materials on the inside. Any way you look at them, they are the standard of the industry.



Housing Design

- High-impact, abuse-resistant nylon face
- Glass-Reinforced thermoplastic base (PBT) has the desirable characteristics of a thermoset material, including heat, flame resistance and dimensional stability. The impact resistance it provides, however, is much greater than that of a thermoset

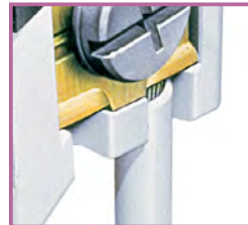

Wiring Design

- Wire restraint recess for both back and side wiring, greatly reduces the possibility of loosening the terminal connection



Mounting Strap

- All-brass mounting and grounding system provides a lower resistance ground path and greater resistance to corrosion than steel mounting systems



Terminals

- #10 brass terminal screw provides greater strength and resistance to corrosion and stripping
- Anti-rotational clamp has a stop to limit the amount of cocking when only one side is used. Accommodates both back and side wiring



Identification

- Face color coding by voltage facilitates locating and mating of proper devices
- Boss diameter is 1.562 inch on 20A and 30A devices for simplifying installation and accessory selection



Contacts

- One-piece contact with long spring arm (low stress) and oxide cutting nibs: prevents stress and overheating associated with riveted contact and short spring arms

Twist-Lock® Devices

Features and Benefits

Watertight Safety-Shroud® Twist-Lock® System

- Virtually eliminates bent and broken plug blades, leading to longer equipment life
- Extends life of mating receptacles by eliminating damage caused by insertion of bent blades
- Extra protection for personnel by significantly reducing chance of inadvertent contact with blades when connecting or disconnecting energized receptacles and connector bodies
- Reduces exposure to arcing when connecting or disconnecting plugs under load
- Compliance with California Code of Regulations, Title 8, Article 51, subsection 2510.7(b), which requires shrouding for devices exceeding 300 volts
- Lockout/tagout hole allows compliance with OSHA regulation 29 CFR 1910.147



Note: Works with Mechanical Interlocks, see page B-43 for additional information.



Housing Design

- One-piece, engineered thermoplastic housing is impact-resistant for heavy duty industrial environments
- Blades are recessed for protection against bending and breaking
- Closure cap is included for environmental seal when device is not in use

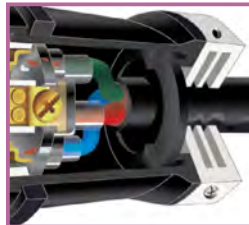

Assembly

- Cord grip screw recess minimizes screwdriver slippage
- All screws are #10 multiple drive head



Cord Range

- Assorted TPE seal glands can accommodate a wide range of cord sizes from #16-3 Type SJ to #8-5 Type S, SO
- Sealing gland and thermoplastic guard assure sealing when fully connected



Panel or Box Mount Receptacles and Inlets

- High impact, thermoplastic housing for heavy duty industrial environments
- Mounting screw recesses minimize screwdriver slippage
- Accepts all mating NEMA locking plugs and most connector bodies, allowing interchangeability with existing devices



Identification

- Catalog number and color-coded voltage rating are easily visible even when in use
- Alignment arrows and lock and unlock symbols provide a visual indication that devices are properly connected



Spring-Loaded Cover

- One-step, push-to-close, spring-loaded cover with latch allows for fast opening and closing of lift cover
Result: environmental sealing is assured

Twist-Lock® Devices

Features and Benefits

Safety-Shroud® Twist-Lock® System

- Mates with most NEMA locking connector bodies
- Virtually eliminates bent and broken plug blades
- Provides protection for personnel by reducing chance of inadvertent contact with blades when connecting or disconnecting energized devices
- Reduces exposure to arcing when connecting or disconnecting under load
- Extends life of mating receptacles by eliminating damage caused by insertion of bent blades
- Complies with California Code of Regulation, which requires shrouding for devices exceeding 300 volts
- Lockout/tagout hole allows compliance to OSHA regulation 29 CFR 1910.147
- Allows engagement with Mechanical Interlock Enclosure which virtually prevents make and break under load

*Note: All screws are #10 multiple drive head.
Works with Mechanical Interlocks, see page B-43 for additional information.*



Housing Design

- Impact resistant shroud made of engineered thermoplastic protects blades against bending or breaking



Housing Design

- Engineered thermoplastic housing is impact and corrosion resistant, making it suitable for heavy duty industrial environments
- Accepts conventional NEMA locking plugs



Safety

- External keying on plug devices allows quick mating of devices
- Lockout/tagout hole allows compliance with OSHA regulation 29 CFR 1910.147



Safety-Shroud® Twist-Lock® Receptacles

- The Safety-Shroud Twist-Lock single gang receptacles were designed to mount in virtually all standard and FS/FD type boxes, allowing easy conversion of existing NEMA locking receptacles to Safety-Shroud Twist-Lock receptacles



Identification

- Catalog number and color-coded voltage rating are visible even when in use
- Alignment arrows with lock and unlock symbols provide a visual indication that devices are properly connected

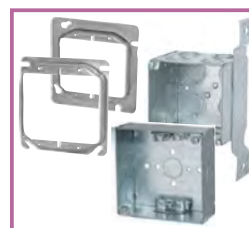

Boxes Available

- The semi-flush receptacles can be installed onto 4" or 4 1/2" square steel wall boxes, which are 2 1/2" deep with 1 or 2-gang 1/2" raised device mud rings. See catalog Section Y for more information.

Twist-Lock® Devices



Compatibility and Environmental Protection Chart

Twist-Lock® Receptacles



Twist-Lock® Connector Bodies



Twist-Lock® Plugs

 Watertight Safety-Shroud	YES Type 4X, Type 12	YES Type 4X, Type 12K	YES Type 1	NO	NO	YES Type 4X, Type 12	YES Type 1
 Safety-Shroud	YES Type 1	YES Type 1	YES Type 1	NO	NO	YES Type 1	YES Type 1
 Insulgrip	YES Type 1	NO	YES Type 1	YES Type 3R	YES Type 1	YES Type 1	YES Type 1

Twist-Lock® Inlets

 NEMA	NA	NA	NA	NA	NA	NO	YES Type 1
 Watertight Safety-Shroud	NA	NA	NA	NA	NA	YES Type 4X, Type 12	YES Type 1

- Type 1** Indoor
- Type 3R** Raintight
- Type 4X** Hose-directed water and corrosion resistant
- Type 12** Dust tight, drip-proof without knockouts
- Type 12K** Dust tight, drip-proof with knockouts
- YES** Interchangeable
- NO** Does not interchange
- NA** Not Applicable

Note: See Technical section for full description of enclosure types.

20 Amp, 250 Volts
2 Pole, 2 Wire, Non-Grounding



20A 250V
NEMA L2-20P
2 HP

Plugs

Description	Cord Dia.	Catalog Number
Black and white nylon, polarized, multiple drive screws.	.220"-.720" (5.6-18.3)	HBL7102C

Note: See page B-51 for accessories.

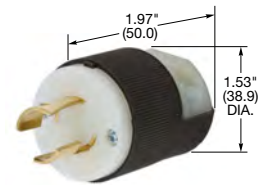

HBL7102C

Flanged Inlets

Description	Catalog Number
Nylon casing, back wired, polarized, multiple drive screws.	HBL8815C

Note: See page B-50 for accessories.

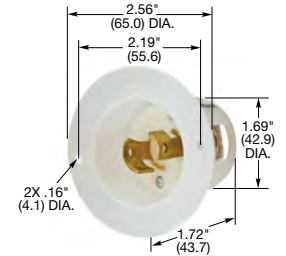

HBL8815C



20A 250V
NEMA L2-20R
2 HP

Connector Bodies

Description	Cord Dia.	Catalog Number
Black and white nylon, multiple drive screws.	.220"-.720" (5.6-18.3)	HBL7101C

Note: See page B-51 for accessories.



HBL7101C

Receptacles

Description	Catalog Number
Single, black phenolic.	HBL7210B
Single, mounted on 4" (101.6) round box cover, black phenolic.	HBL7217B

Note: See pages B-50 and B-51 for accessories.

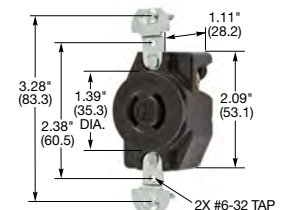

HBL7210B

Flanged Receptacles

Description	Catalog Number
Insulgrip nylon casing, back wired, multiple drive screws.	HBL8809C
Metal flange, stainless steel casing, black phenolic, exposed terminals.	HBL3226

Note: See pages B-50 and B-51 for accessories.

Only receptacles and plugs are HP rated.
 HP ratings are AC only.



HBL8809C

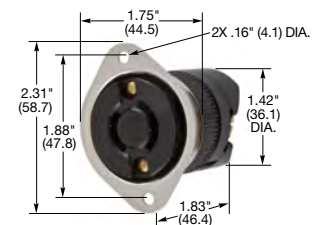

HBL3226

Dimensions in Inches (mm)

20 Amp, 125, 250 Volts and 277 Volts AC 2 Pole, 3 Wire, Grounding

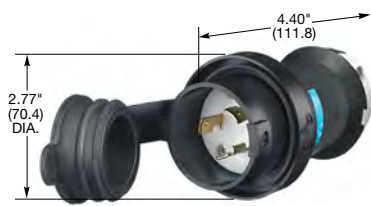

HBL2321SW



HBL2321S



HBL2311



HBL2311ST



HBL2325SW

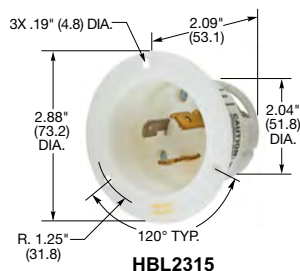

HBL2315

Plugs

Watertight Safety-Shroud®

Description	Cord Dia.	Catalog Number	IP66 SUITABILITY	UL Type 4x, 12
Black Valox® housing, white Valox® clamps.	.360"-.930" (9-24)	HBL2311SW	HBL2321SW	HBL2331SW

Safety-Shroud®

Description	Cord Dia.	Catalog Number	IP20 SUITABILITY
Black and white nylon body, white Valox® shroud. Can be used with the Insulgrip Connector Bodies.	.360"-.930" (9-24)	HBL2311S	HBL2321S HBL2331S

Insulgrip®

Description	Cord Dia.	Catalog Number	IP20 SUITABILITY
Black and white nylon.	.360"-.930" (9-24)	HBL2311	HBL2321 HBL2331
Black and white nylon, spring termination	.360"-.930" (9-24)	HBL2311ST	HBL2321ST HBL2331ST
Corrosion resistant, yellow nylon.	.360"-.930" (9-24)	HBL23CM11	HBL23CM21 -
All black nylon.	.360"-.930" (9-24)	HBL2311BK	HBL2321BK -
All black nylon, spring termination	.360"-.930" (9-24)	HBL2311STBK	HBL2321STBK -
Cord clamps with removable inserts. All black nylon.	.360"-.930" (9-24)	HBL2311EBK	HBL2321EBK -

Note: See page B-52 for accessories.

Valise®

Description	Cord Dia.	Catalog Number	IP20 SUITABILITY	UL	CSA
Yellow nylon.	.325"-.720" (8.26-18.3)	HBL2311VY	HBL2321VY	HBL2331VY	
Corrosion resistant, yellow nylon.	.325"-.720" (8.26-18.3)	HBL23CM11V	-	-	
Black nylon.	.325"-.720" (8.26-18.3)	HBL2311VBK	HBL2321VBK	HBL2331VBK	

Note: See page B-53 for accessories.

Flanged Inlets

Watertight Safety-Shroud®

Description	Catalog Number	IP66 SUITABILITY	UL Type 4x, 12
Gray Valox® housing and flange.	HBL2315SW	HBL2325SW	HBL2335SW
Gray Valox® housing and flange, reverse service (Not shown).	-	HBL2325SWR	-

Note: See page B-56 for accessories.

Insulgrip®

Description	Catalog Number	IP20 SUITABILITY
Nylon casing, back wired.	HBL2315	HBL2325 HBL2335
Nylon casing, spring termination	HBL2315ST	HBL2325ST HBL2335ST

Note: See page B-52 for accessories.

See pages B-69 and B-70 for technical information on Twist-Lock and Watertight Safety-Shroud devices.
See page B-74 for technical information on Valise® plugs and connectors.



HBL2315ST

Valox® is a trademark of SABIC Innovative Plastics, acquired from General Electric Company.

20A 125V NEMA L5-20P 1 HP	20A 250V NEMA L6-20P 2 HP	20A 277V AC NEMA L7-20P 2 HP



HBLMITL - For use with Watertight Safety-Shroud receptacles, see page B-41.

Twist-Lock® Devices



**20 Amp, 125, 250 Volts and 277 Volts AC
2 Pole, 3 Wire, Grounding**

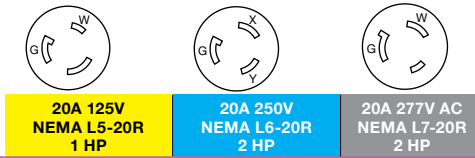

Connector Bodies

Watertight Safety-Shroud® IP66 SUITABILITY UL Type 4x, 12

Description	Cord Dia.	Catalog Number		
Black Valox® housing, white Valox® clamps.	.360"-.930" (9-24)	HBL2313SW	HBL2323SW	HBL2333SW

Insulgrip® IP20 SUITABILITY

Description	Cord Dia.	Catalog Number		
Black and white nylon.	.360"-.930" (9-24)	HBL2313	HBL2323	HBL2333
Black and white nylon, spring termination	.360"-.930" (9-24)	HBL2313ST	HBL2323ST	HBL2333ST
Spring termination, all black		HBL2313STBK	HBL2323STBK	-
Corrosion resistant, yellow nylon.	.360"-.930" (9-24)	HBL23CM13	HBL23CM23	-
All black nylon.	.360"-.930" (9-24)	HBL2313BK	HBL2323BK	-
Cord clamps with removable inserts. All black nylon.	.360"-.930" (9-24)	HBL2313EBK	HBL2323EBK	-

Note: See page B-52 for accessories.

Valise® IP20 SUITABILITY

Description	Cord Dia.	Catalog Number		
Yellow nylon.	.325"-.720" (8.26-18.3)	HBL2313VY	HBL2323VY	-
Black nylon.	.325"-.720" (8.26-18.3)	HBL2313VBK	HBL2323VBK	HBL2333VBK

Note: See page B-53 for accessories.

Receptacles

Watertight Safety-Shroud® IP66 SUITABILITY UL Type 4x, 12

Description	Catalog Number		
Gray Valox® housing and flange, back wired.	HBL2310SW	HBL2320SW	HBL2330SW

Note: See page B-54 for accessories.

Safety-Shroud® Twist-Lock® IP20 SUITABILITY

Description	Catalog Number		
Gray Valox® angle housing, one gang, back wired.	HBL2310AR	HBL2320AR	HBL2330AR
Gray Valox® surface mounting, one gang, back wired.	HBL2310SR	HBL2320SR	HBL2330SR
Gray Valox® semi-flush, two gang, back wired.	HBL2310SR2	HBL2320SR2	HBL2330SR2

Single Flush Receptacles IP20 SUITABILITY

Description	Catalog Number		
Black nylon face, back and side wired.	HBL2310	HBL2320	HBL2330
Black nylon face, spring terminals.	HBL2310ST	HBL2320ST	-
Blue nylon face, back and side wired.	HBL2310M7	HBL2320M4	-
Red nylon face, spring terminals	HBL2310STR	HBL2320STR	-
Isolated ground, orange nylon face, back and side wired.	IG2310	IG2320	-
Isolated ground, orange nylon face, spring termination	IG2310ST	-	-
Corrosion resistant, yellow nylon face, back and side wired.	HBL23CM10	-	-
Ring terminal connection.	HBL2310RT	HBL2320RT	-

Note: See page B-52 for accessories.

Insulgrip® Flanged Receptacles

Description	Catalog Number		
Nylon casing, back wired.	HBL2316	HBL2326	HBL2336
Nylon casing, back wire, spring termination	HBL2316ST	HBL2326ST	-

Note: See page B-52 for accessories.

Valox® is a trademark of SABIC Innovative Plastics, acquired from General Electric Company.

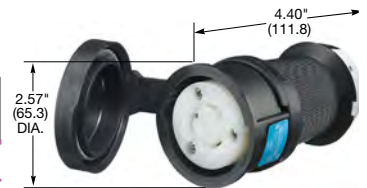

HBL2323SW



HBL2313



HBL2313ST

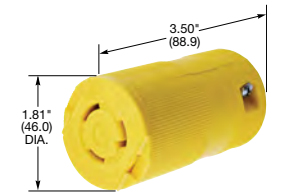

HBL2313VY



HBL2320SW

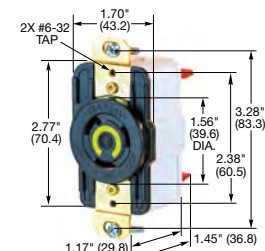

HBL2310ST

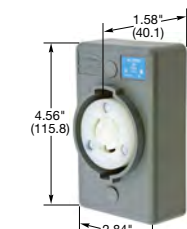

HBL2320SR

Dimensions in Inches (mm)

20 Amp, 125/250, 3Ø 250 and 3Ø 480 Volts AC
3 Pole, 4 Wire, Grounding

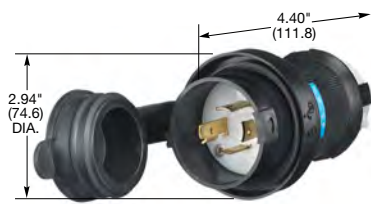

HBL2421SW



HBL2421S

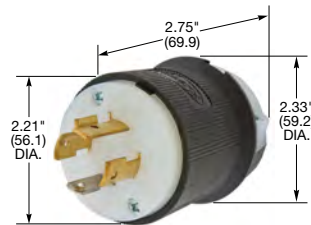

HBL2411



HBL2425SW

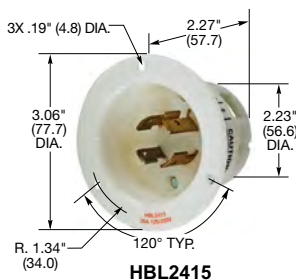

HBL2415

Dimensions in Inches (mm)

Plugs

Watertight Safety-Shroud®

Description	Cord Dia.	IP66 SUITABILITY		
		UL Type 4x, 12		
Black Valox® housing, white Valox® clamps.	.350"-1.150" (9-29)	HBL2411SW	HBL2421SW	HBL2431SW

Safety-Shroud®

Description	Cord Dia.	IP20 SUITABILITY		
		UL Type 4x, 12		
Black and white nylon body, white Valox® shroud. Can be used with the Insulgrip Connector Bodies.	.350"-1.150" (9-29)	HBL2411S	HBL2421S	HBL2431S

Note: See page B-52 for accessories.

Insulgrip®

Description	Cord Dia.	IP20 SUITABILITY		
		UL Type 4x, 12		
Black and white nylon.	.350"-1.150" (9-29)	HBL2411	HBL2421	HBL2431
Black and white nylon, spring termination.	.350"-1.150" (9-29)	HBL2411ST	HBL2421ST	HBL2431ST
Corrosion resistant, yellow nylon.	.350"-1.150" (9-29)	HBL24CM11	HBL24CM21	HBL24CM31
All black nylon.	.350"-1.150" (9-29)	HBL2411BK	-	-
All black nylon, spring termination	.350"-1.150" (9-29)	HBL2411STBK	-	-

Note: See page B-52 for accessories.

Flanged Inlets

Watertight Safety-Shroud®

Description	IP66 SUITABILITY		
	UL Type 4x, 12		
Gray Valox® housing and flange.	HBL2415SW	HBL2425SW	HBL2435SW

Note: See page B-54 for accessories.

Insulgrip®

Description	IP20 SUITABILITY		
	UL Type 4x, 12		
Nylon casing, back wired.	HBL2415	HBL2425	HBL2435
Nylon casing, spring termination.	HBL2415ST	HBL2425ST	HBL2435ST

Note: See page B-52 for accessories.

See pages B-69 and B-70 for technical information on Twist-Lock and Watertight Safety-Shroud devices.

HBLMITL - For use with Watertight Safety-Shroud receptacles, see page B-41.



Valox® is a trademark of SABIC Innovative Plastics, acquired from General Electric Company.

Twist-Lock® Devices



**20 Amp, 125/250, 3Ø 250 and 3Ø 480 Volts AC
3 Pole, 4 Wire, Grounding**



**20A 125/250V AC
NEMA L14-20R
2 (1) HP**

**20A 3Ø 250V AC
NEMA L15-20R
3 HP**

**20A 3Ø 480V AC
NEMA L16-20R
5 HP**

Connector Bodies

Watertight Safety-Shroud®

IP66 SUITABILITY UL Type 4x, 12

Description	Cord Dia.	Catalog Number			
Black Valox® housing, white Valox® clamps.	.350"-1.150" (9-29)	HBL2413SW	HBL2423SW	HBL2433SW	



HBL2423SW

Insulgrip®

IP20 SUITABILITY

Description	Cord Dia.	Catalog Number			
Black and white nylon.	.350"-1.150" (9-29)	HBL2413	HBL2423	HBL2433	
Black and white nylon, spring termination	.350"-1.150" (9-29)	HBL2413ST	HBL2423ST	HBL2433ST	
Spring termination, all black		HBL2413STBK	-	-	
Corrosion resistant, yellow nylon.	.350"-1.150" (9-29)	HBL24CM13	HBL24CM23	HBL24CM33	
All black nylon.	.350"-1.150" (9-29)	HBL2413BK	-	-	



HBL2413

Note: See page B-52 for accessories.

Receptacles

Watertight Safety-Shroud®

IP66 SUITABILITY UL Type 4x, 12

Description	Catalog Number			
Gray Valox® housing and flange, back wired.	HBL2410SW	HBL2420SW	HBL2430SW	

Note: See page B-54 for accessories.



HBL2413ST

Safety-Shroud® Twist-Lock®

IP20 SUITABILITY

Description	Catalog Number			
Gray Valox® angle housing, one gang, back wired.	HBL2410AR	HBL2420AR	HBL2430AR	
Gray Valox® surface mounting, one gang, back wired.	HBL2410SR	HBL2420SR	HBL2430SR	
Gray Valox® semi-flush, two gang, back wired.	HBL2410SR2	HBL2420SR2	HBL2430SR2	



HBL2420SW

Single Flush Receptacles

IP20 SUITABILITY

Description	Catalog Number			
Black nylon face, back and side wired.	HBL2410	HBL2420	HBL2430	
Black and white nylon, spring termination.	HBL2410ST	HBL2420ST	HBL2430ST	
Isolated ground, orange nylon face, back and side wired.	IG2410	IG2420	-	
Isolated Ground, spring termination	IG2420ST	-	-	
Ring terminal connection.	HBL2410RT	HBL2420RT	-	

Note: See page B-52 for accessories.

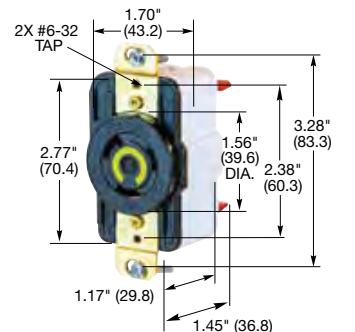

HBL2430ST

Insulgrip® Flanged Receptacles

Description	Catalog Number			
Nylon casing, back wired.	HBL2416	HBL2426	HBL2436	
Nylon casing, back wire, spring terminatio	HBL2416ST	HBL2426ST	HBL2436ST	

Note: See page B-52 for accessories.

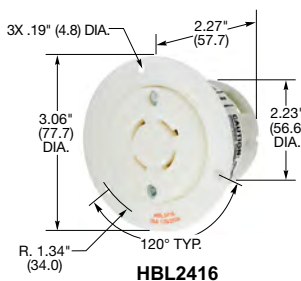

HBL2416

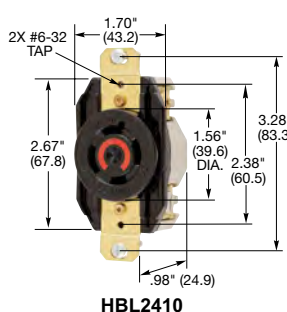

HBL2410

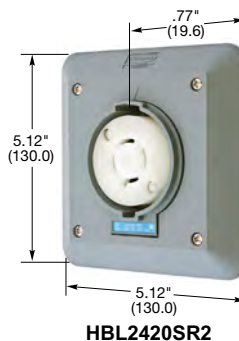

HBL2420SR2



HBL2420SR

Dimensions in Inches (mm)

Valox® is a trademark of SABIC Innovative Plastics, acquired from General Electric Company.

20 Amp, 347, 480, 600 and 125/250 Volts AC
2 Pole, 3 Wire, Grounding and 3 Pole, 3 Wire, Non-Grounding

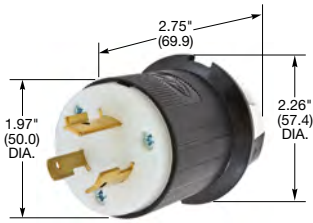

HBL2341



HBL2341ST

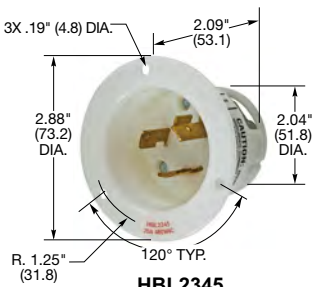

HBL2345



HBL2343

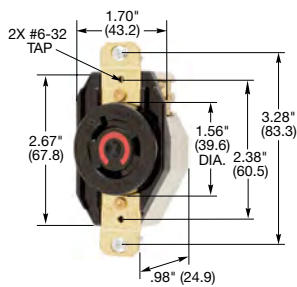

HBL2340

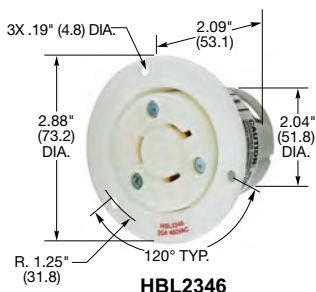

HBL2346

Dimensions in Inches (mm)

IP20
SUITABILITY



Plugs

Description	Cord Dia.	Catalog Number	20A 347V AC NEMA L24-20P	20A 480V AC NEMA L8-20P 3 HP	20A 600V AC NEMA L9-20P	20A 125/250V AC NEMA L10-20P 2 (1) HP
Black and white nylon.	.360"-.930" (9-24)	HBL3721	HBL2341	HBL2351	—	—
Black and white nylon, spring termination	—	—	HBL2341ST	—	—	—
Black and white nylon (Not shown).	.300"-1.050" (7.6-26.7)	—	—	—	—	HBL2361

Note: See page B-52 for accessories.

Flanged Inlets

Description	Catalog Number	20A 347V AC NEMA L24-20R	20A 480V AC NEMA L8-20R 3 HP	20A 600V AC NEMA L9-20R	20A 125/250V AC NEMA L10-20R 2 (1) HP
Nylon casing, back wired.	HBL3725	HBL2345	HBL2355	HBL2365	—
Nylon casing, spring termination.	—	HBL2345ST	—	—	—

Note: See page B-52 for accessories.

IP20
SUITABILITY



Connector Bodies

Description	Cord Dia.	Catalog Number	20A 347V AC NEMA L24-20R	20A 480V AC NEMA L8-20R 3 HP	20A 600V AC NEMA L9-20R	20A 125/250V AC NEMA L10-20R 2 (1) HP
Black and white nylon.	.360"-.930" (9-24)	HBL3723	HBL2343	HBL2353	—	—
Black and white nylon, spring termination	.360"-.930" (9-24)	—	HBL2343ST	—	—	—
Black and white nylon (Not shown).	.300"-1.050" (7.6-26.7)	—	—	—	—	HBL2363

Note: See page B-52 for accessories.

Single Flush Receptacles

Description	Catalog Number	20A 347V AC NEMA L24-20R	20A 480V AC NEMA L8-20R 3 HP	20A 600V AC NEMA L9-20R	20A 125/250V AC NEMA L10-20R 2 (1) HP
Black nylon face, back and side wired.	HBL3720	HBL2340	HBL2350	HBL2360	—
Watertight Safety-Shroud®, gray Valox® housing and flange, back and side wired, (Not shown).	—	HBL2340SW	—	—	—
Isolated ground, orange nylon face, back and side wired.	—	IG2340	—	—	—

Note: See page B-52 for accessories.

Flanged Receptacles

Description	Catalog Number	20A 347V AC NEMA L24-20R	20A 480V AC NEMA L8-20R 3 HP	20A 600V AC NEMA L9-20R	20A 125/250V AC NEMA L10-20R 2 (1) HP
Nylon casing, back wired.	HBL3726	HBL2346	HBL2356	HBL2366	—

Note: See page B-52 for accessories.

See page B-69 for technical information.

See page B-39 for switched enclosure.

See page B-42 for Add-A-Shroud® kit. For use with connector bodies.

Only receptacles and plugs up to 480V AC are HP rated.

HP ratings are AC only.

Valox® is a trademark of SABIC Innovative Plastics, acquired from General Electric Company.

20 Amp, 3ØY 120/208, 277/480 and 347/600 Volts AC 4 Pole, 4 Wire, Non-Grounding

IP20
SUITABILITY



20A 3ØY 120/208V AC
NEMA L18-20P
2 HP

20A 277/480V AC
NEMA L19-20P
5 HP

20A 347/600V AC
NEMA L20-20P

Plugs

Description	Cord Dia.	Catalog Number	Catalog Number	Catalog Number
Black and white nylon.	.350"-1.150" (9-29)	HBL2441	HBL2451	HBL2461

Note: See page B-52 for accessories.

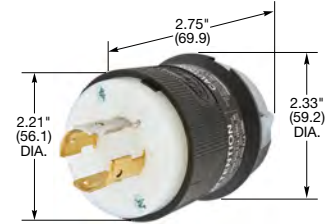

HBL2441

Flanged Inlets

Description	Catalog Number	Catalog Number	Catalog Number
Nylon casing, back wired.	HBL2445	HBL2455	HBL2465

Note: See page B-52 for accessories.

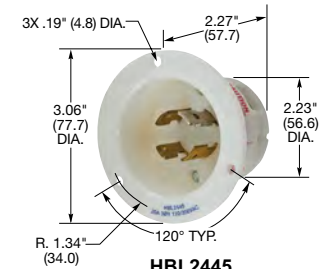

HBL2445

IP20
SUITABILITY



20A 3ØY 120/208V AC
NEMA L18-20R
2 HP

20A 277/480V AC
NEMA L19-20R
5 HP

20A 347/600V AC
NEMA L20-20R

Connector Bodies

Description	Cord Dia.	Catalog Number	Catalog Number	Catalog Number
Black and white nylon.	.350"-1.150" (9-29)	HBL2443	HBL2453	HBL2463

Note: See page B-52 for accessories.



HBL2443

Single Flush Receptacles

Description	Catalog Number	Catalog Number	Catalog Number
Black nylon face, back and side wired.	HBL2440	HBL2450	HBL2460

Note: See page B-52 for accessories.

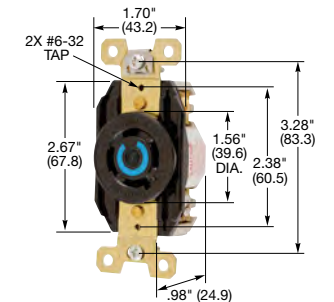

HBL2440

Flanged Receptacles

Description	Catalog Number	Catalog Number	Catalog Number
Nylon casing, back wired.	HBL2446	HBL2456	HBL2466

Note: See page B-52 for accessories.

See page B-69 for technical information.

See page B-39 for switched enclosure.

See page B-42 for Add-A-Shroud® kit. For use with connector bodies.

Only receptacles and plugs up to 480V AC are HP rated.

HP ratings are AC only.

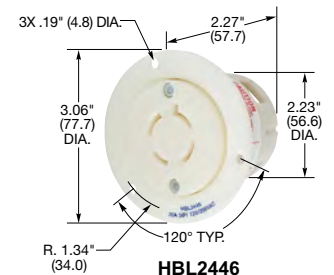

HBL2446

Dimensions in Inches (mm)

**20 Amp, 3ØY 120/208, 277/480 and 347/600 Volts AC
4 Pole, 5 Wire, Grounding**

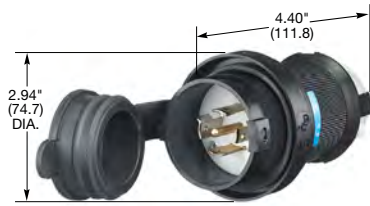

HBL2511SW



HBL2511S

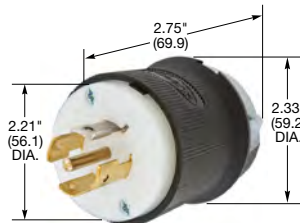

HBL2511

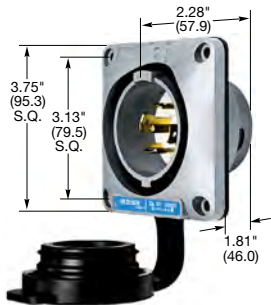

HBL2515SW

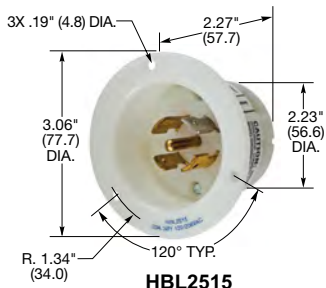

HBL2515

Dimensions in Inches (mm)

Plugs

Watertight Safety-Shroud®

Description	Cord Dia.	Catalog Number	20A 3ØY 120/208V AC NEMA L21-20P 2 HP	20A 3ØY 277/480V AC NEMA L22-20P 5 HP	20A 3ØY 347/600V AC NEMA L23-20P
Black Valox® housing, white Valox® clamps.	.350"-1.150" (9-29)	HBL2511SW	IP66 SUITABILITY	UL Type 4x, 12	

Safety-Shroud®

Description	Cord Dia.	Catalog Number	IP20 SUITABILITY
Black and white nylon body, white Valox® shroud. Can be used with the Insulgrip Connector Bodies.	.350"-1.150" (9-29)	HBL2511S	

Note: See page B-40 for accessories.

Insulgrip®

Description	Cord Dia.	Catalog Number	IP20 SUITABILITY
Black and white nylon.	.350"-1.150" (9-29)	HBL2511	HBL2521 HBL2531
Black and white nylon, spring termination.	.350"-1.150" (9-29)	HBL2511ST	HBL2521ST -
All black nylon.	.350"-1.150" (9-29)	HBL2511BK	- -
All black nylon, spring termination	.350"-1.150" (9-29)	HBL2511STBK	- -
Corrosion resistant, yellow nylon.	.350"-1.150" (9-29)	HBL25CM11	- -
Black and white for flat cable.	.350"-1.150" (9-29)	HBL2511FC	- -

Note: See page B-52 for accessories.

Flanged Inlets

Watertight Safety-Shroud®

Description	Catalog Number	IP66 SUITABILITY	UL Type 4x, 12
Gray Valox® housing and flange.	HBL2515SW	-	-

Note: See page B-52 for accessories.

Insulgrip®

Description	Catalog Number	IP20 SUITABILITY
Nylon casing, back wired.	HBL2515	HBL2525 HBL2535
Nylon casing, spring termination.	HBL2515ST	HBL2525ST -

Note: See page B-52 for accessories.

See pages B-69 and B-70 for technical information on Twist-Lock and Watertight Safety-Shroud devices.

Twist-Lock® 3-Phase Circuit Tester

Description	Rating	Catalog Number	IP66 SUITABILITY	UL Type 4x, 12
3-Phase Circuit Tester.	3Ø 120/208V AC Min. Voltage: 90V AC	HBL3PT2511	-	-

Note: Testers in other NEMA configurations can be developed upon request. See page B-53 for additional circuit testers.



HBL3PT2511

Valox® is a trademark of SABIC Innovative Plastics, acquired from General Electric Company.

HBLMITL - For use with Watertight Safety-Shroud receptacles, see page B-41.



Twist-Lock® Devices



**20 Amp, 3ØY 120/208, 277/480 and 347/600 Volts AC
4 Pole, 5 Wire, Grounding**



20A 3ØY 120/208V AC NEMA L21-20R 2 HP	20A 3ØY 277/480V AC NEMA L22-20R 5 HP	20A 3ØY 347/600V AC NEMA L23-20R
---	---	-------------------------------------

Connector Bodies

Watertight Safety-Shroud®

IP66 SUITABILITY UL Type 4x, 12

Description	Cord Dia.	Catalog Number		
Black Valox® housing, white Valox® clamps.	.350"-1.150" (9-29)	HBL2513SW	-	-



Insulgrip®

IP20 SUITABILITY

Description	Cord Dia.	Catalog Number			
Black and white nylon.	.350"-1.150" (9-29)	HBL2513	HBL2523	HBL2533	
Black and white nylon, spring termination	.350"-1.150" (9-29)	HBL2513ST	HBL2523ST	-	
Spring termination, all black		HBL2513STBK	-	-	
All black nylon.	.350"-1.150" (9-29)	HBL2513BK	-	-	
Corrosion resistant, yellow nylon.	.350"-1.150" (9-29)	HBL25CM13	-	-	
Black and white for flat cable.	.350"-1.150" (9-29)	HBL2513FC	-	-	



Note: See page B-52 for accessories.

Receptacles

Watertight Safety-Shroud®

IP66 SUITABILITY UL Type 4x, 12

Description	Catalog Number		
Gray Valox® housing and flange, back wired.	HBL2510SW	-	-

Note: See page B-54 for accessories.

Safety-Shroud® Twist-Lock®

IP20 SUITABILITY

Description	Catalog Number		
Gray Valox® angle housing, one gang, back wired.	HBL2510AR	-	-
Gray Valox® surface mounting, one gang, back wired.	HBL2510SR	-	-
Gray Valox® semi-flush, two gang, back wired.	HBL2510SR2	-	-



Single Flush Receptacles

IP20 SUITABILITY

Description	Catalog Number			
Black nylon face, back and side wired.	HBL2510	HBL2520*	HBL2530*	
Black and white nylon, spring termination.	HBL2510ST	HBL2520ST	-	
Isolated ground, orange nylon face, back and side wired.	IG2510	-	-	

Note: See page B-52 for accessories.

*Not Fed Spec.

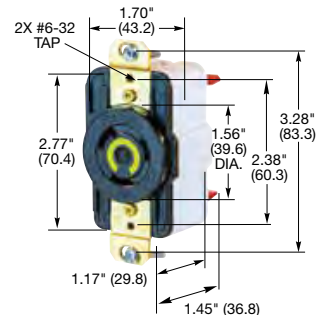

Insulgrip® Flanged Receptacles

Description	Catalog Number			
Nylon casing, back wired.	HBL2516	HBL2526	HBL2536	
Nylon casing, back wire, spring termination	HBL2516ST	HBL2526ST	-	
Black nylon casing, back wire, spring termination	HBL2516STBK	-	-	

Note: See page B-52 for accessories.

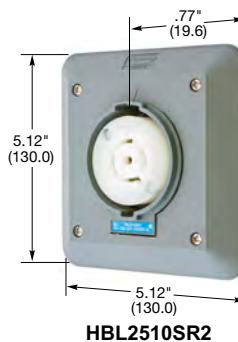
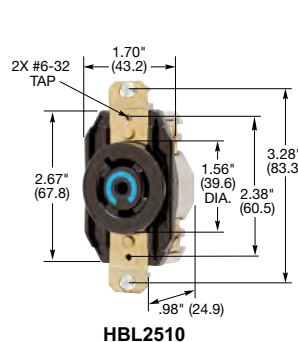
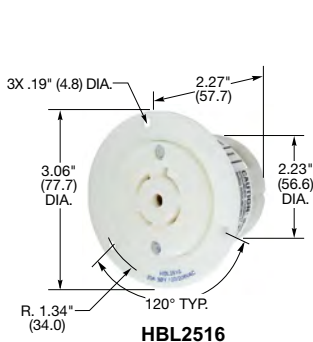

Valox® is a trademark of SABIC Innovative Plastics, acquired from General Electric Company.

Dimensions in Inches (mm)

30 Amp, 125, 250 Volts and 277 Volts AC 2 Pole, 3 Wire, Grounding



30A 125V NEMA L5-30P 2 HP	30A 250V NEMA L6-30P 2 HP	30A 277V AC NEMA L7-30P 3 HP
---------------------------------	---------------------------------	------------------------------------

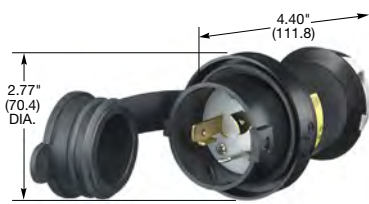

HBL2611SW



HBL2621S

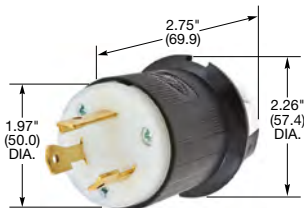

HBL2621



HBL2611ST



HBL2615SW

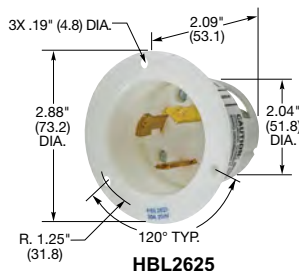

HBL2625

Plugs

Watertight Safety-Shroud®

IP66 SUITABILITY UL Type 4x, 12

Description	Cord Dia.	Catalog Number		
Black Valox® housing, white Valox® clamps.	.325"-.930" (9-24)	HBL2611SW	HBL2621SW	–

Safety-Shroud®

IP20 SUITABILITY

Description	Cord Dia.	Catalog Number		
Black and white nylon body, white Valox® shroud. Can be used with the Insulgrip Connector Bodies.	.360"-.930" (9-24)	HBL2611S	HBL2621S	–

Note: See page B-40 for accessories.

Insulgrip®

IP20 SUITABILITY

Description	Cord Dia.	Catalog Number		
Black and white nylon.	.360"-.930" (9-24)	HBL2611	HBL2621	HBL2631
Black and white nylon, spring termination		HBL2611ST	HBL2621ST	–
Heat stabilized, gray nylon, 220° F (104° C).	.360"-.930" (9-24)	HBL2611F	HBL2621F	–
Corrosion resistant, yellow nylon.	.360"-.930" (9-24)	HBL26CM11	HBL26CM21	–
All black nylon.	.360"-.930" (9-24)	HBL2611BK	HBL2621BK	–
All black nylon, spring termination	.360"-.930" (9-24)	HBL2611STBK	HBL2621STBK	–
Cord clamps with removable inserts. All black nylon.	.360"-.930" (9-24)	–	HBL2621EBK	–

Note: See page B-52 for accessories.

Valise®

IP20 SUITABILITY

Description	Cord Dia.	Catalog Number		
Yellow nylon.	.590"-.930" (15.0-23.6)	HBL2611VY	HBL2621VY	–
Corrosion resistant, yellow nylon.	.590"-.930" (15.0-23.6)	HBL26CM11V	–	–
Black nylon.	.590"-.930" (15.0-23.6)	HBL2611VBK	HBL2621VBK	–

Note: See page B-53 for accessories.

Flanged Inlets

Watertight Safety-Shroud®

IP66 SUITABILITY UL Type 4x, 12

Description	Catalog Number		
Gray Valox® housing and flange.	HBL2615SW	HBL2625SW	–
Reverse service, gray Valox® housing and flange (use with HBL2613SR), (Not shown).	HBL2615SWR	–	–

Note: See page B-54 for accessories.

Insulgrip®

IP20 SUITABILITY

Description	Catalog Number		
Nylon casing, back wired.	HBL2615	HBL2625	HBL2635
Nylon casing, spring termination	HBL2615ST	HBL2625ST	–
Heat stabilized, gray nylon, 220° F (104° C).	HBL2615F	HBL2625F	–
Nylon casing, weather protective, die cast aluminum, back wired, self closing lift cover.	HBL2615M3	–	–

Note: See page B-52 for accessories.

See pages B-69 and B-70 for technical information on Twist-Lock and Watertight Safety-Shroud devices.
See page B-74 for technical information on Valise plugs and connectors.

Dimensions in Inches (mm)

Valox® is a trademark of SABIC Innovative Plastics, acquired from General Electric Company.

30 Amp, 125, 250 Volts and 277 Volts AC 2 Pole, 3 Wire, Grounding



30A 125V NEMA L5-30R 2 HP	30A 250V NEMA L6-30R 2 HP	30A 277V AC NEMA L7-30R 3 HP
---------------------------------	---------------------------------	------------------------------------

Connector Bodies

Watertight Safety-Shroud®

Description	Cord Dia.	IP66 SUITABILITY		UL Type 4x, 12
		Catalog Number		
Black Valox® housing, white Valox® clamps.	.360"-.930" (9-24)	HBL2613SW	HBL2623SW	—
Reverse service, black Valox® housing, white Valox® clamps (use with HBL2615SWR), (Not shown).	.360"-.930" (9-24)	HBL2613SR	—	—

Insulgrip®

Description	Cord Dia.	IP20 SUITABILITY		
		Catalog Number		
Black and white nylon.	.360"-.930" (9-24)	HBL2613	HBL2623	HBL2633
Black and white nylon, spring termination	.360"-.930" (9-24)	HBL2613ST	HBL2623ST	—
Spring termination, all black		HBL2613STBK	HBL2623STBK	—
Heat stabilized, gray nylon, 220° F (104° C).	.360"-.930" (9-24)	HBL2613F	HBL2623F	—
Corrosion resistant, yellow nylon.	.360"-.930" (9-24)	HBL26CM13	HBL26CM23	—
All black nylon.	.360"-.930" (9-24)	HBL2613BK	HBL2623BK	—

Note: See page B-52 for accessories.

Valise®

Description	Cord Dia.	IP20 SUITABILITY		
		Catalog Number		
Yellow nylon.	.590"-.930" (15.0-23.6)	HBL2613VY	HBL2623VY	—
Corrosion resistant, yellow nylon.	.590"-.930" (15.0-23.6)	HBL26CM13V	—	—
Black nylon.	.590"-.930" (15.0-23.6)	HBL2613VBK	HBL2623VBK	—
Cord clamps with removable inserts. All black nylon.	.360"-.930" (9-24)	—	HBL2623EBK	—

Note: See page B-53 for accessories.

Receptacles

Watertight Safety-Shroud®

Description	IP66 SUITABILITY		UL Type 4x, 12
	Catalog Number		
Gray Valox® housing and flange, back wired.	HBL2610SW	HBL2620SW	—

Note: See page B-54 for accessories.

Safety-Shroud® Twist-Lock®

Description	IP20 SUITABILITY		
	Catalog Number		
Gray Valox® angle housing, one gang, back wired.	HBL2610AR	HBL2620AR	—
Gray Valox® surface mounting, one gang, back wired.	HBL2610SR	HBL2620SR	—
Gray Valox® semi-flush, two gang, back wired.	HBL2610SR2	HBL2620SR2	—

Single Flush Receptacles

Description	IP20 SUITABILITY		
	Catalog Number		
Black nylon face, back and side wired.	HBL2610	HBL2620	HBL2630
Black nylon face, spring terminals.	HBL2610ST	HBL2620ST	—
Blue nylon face, back and side wired.	HBL2610M6	HBL2620M6	—
Isolated ground, orange nylon face, back and side wired.	IG2610	IG2620	—
Isolated ground, orange nylon face, spring termination	IG2610ST	IG2620ST	—
Corrosion resistant, yellow nylon face, back and side wired.	HBL26CM10	HBL26CM20	—
Ring terminal connection.	HBL2610RT	HBL2620RT	—

Note: See page B-52 for accessories.

Insulgrip® Flanged Receptacles

Description	IP20 SUITABILITY		
	Catalog Number		
Nylon casing, back wired.	HBL2616	HBL2626	HBL2636
Nylon casing, back wire, spring termination	HBL2616ST	HBL2626ST	—
Heat stabilized, gray nylon, 220° F (104° C).	HBL2616F	HBL2626F	—

Note: See page B-52 for accessories.

Valox® is a trademark of SABIC Innovative Plastics, acquired from General Electric Company.

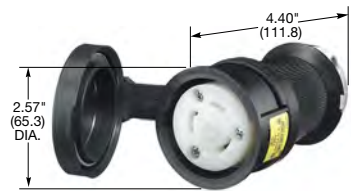

HBL2613SW



HBL2623



HBL2613ST

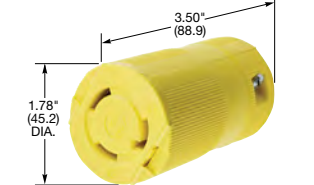

HBL2613VY



HBL2610SW

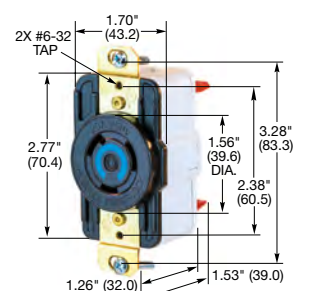

HBL2610ST

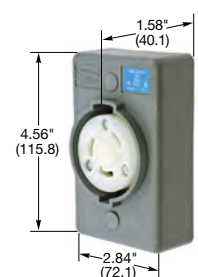

HBL2620SR

Dimensions in Inches (mm)

30 Amp, 125/250 and 3Ø 250 Volts AC
3 Pole, 3 Wire, Non-Grounding and 3 Pole, 4 Wire, Grounding



30A 125/250V AC NEMA L10-30P	30A 125/250V AC NEMA L14-30P 2 (2) HP	30A 3Ø 250V AC NEMA L15-30P 3 HP
---------------------------------	---	--

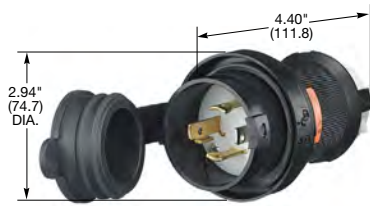

HBL2711SW



HBL2711S



HBL2711



HBL2715SW

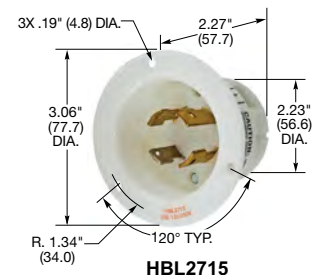

HBL2715

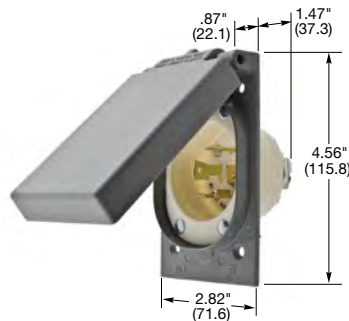

HBL2715M3



HBLMITL - For use with Watertight Safety-Shroud receptacles and reverse service inlet, see page B-41.

Plugs

Watertight Safety-Shroud®

IP66 SUITABILITY UL Type 4x, 12

Description	Cord Dia.	Catalog Number		
Black Valox® housing, white Valox® clamps.	.350"-1.150" (9-29)	-	HBL2711SW	HBL2721SW

Safety-Shroud®

IP20 SUITABILITY

Description	Cord Dia.	Catalog Number		
Black and white nylon body, white Valox® shroud. Can be used with the Insulgrip Connector Bodies.	.350"-1.150" (9-29)	-	HBL2711S	HBL2721S

Note: See page B-40 for accessories.

Insulgrip®

IP20 SUITABILITY

Description	Cord Dia.	Catalog Number		
Black and white nylon.	.350"-1.150" (9-29)	-	HBL2711	HBL2721
Black and white nylon, spring termination.	.350"-1.150" (9-29)	-	HBL2711ST	HBL2721ST
Black and white nylon, (Not shown).	.300"-.950" (7.6-24.1)	HBL2661	-	-
Corrosion resistant, yellow nylon.	.350"-1.150" (9-29)	-	HBL27CM11	HBL27CM21
All black nylon.	.350"-1.150" (9-29)	-	HBL2711BK	-
All black nylon, spring termination	.350"-1.150" (9-29)	-	HBL2711STBK	-

Note: See page B-52 for accessories.

Flanged Inlets

Watertight Safety-Shroud®

IP66 SUITABILITY UL Type 4x, 12

Description	Catalog Number		
Gray Valox® housing and flange.	-	HBL2715SW	HBL2725SW
Reverse service, gray Valox® housing and flange (use with HBL2713SR), (Not shown).	-	HBL2715SWR	-

Note: See page B-54 for accessories.

Insulgrip®

IP20 SUITABILITY

Description	Catalog Number		
Nylon casing, back wired.	-	HBL2715	HBL2725
Nylon casing, spring termination.	-	HBL2715ST	HBL2725ST
Nylon casing, back wired, (Not shown).	HBL2665	-	-
Nylon casing, weather protective, die cast aluminum, back wired, self closing lift cover.	-	HBL2715M3	-

Note: See page B-52 for accessories.

See pages B-69 and B-70 for technical information on Twist-Lock and Watertight Safety-Shroud devices.

Dimensions in Inches (mm)

Valox® is a trademark of SABIC Innovative Plastics, acquired from General Electric Company.

**30 Amp, 125/250 and 3Ø 250 Volts AC
3 Pole, 3 Wire, Non-Grounding and
3 Pole, 4 Wire, Grounding**



**30A 125/250V AC
NEMA L10-30R**

**30A 125/250V AC
NEMA L14-30R
2 (2) HP**

**30A 3Ø 250V AC
NEMA L15-30R
3 HP**

Connector Bodies

Watertight Safety-Shroud®

IP66 SUITABILITY UL Type 4x, 12

Description	Cord Dia.	Catalog Number		
Black Valox® housing, white Valox® clamps.	.350"-1.150" (9-29)	-	HBL2713SW	HBL2723SW
Reverse service, black Valox® housing, white Valox® clamps (use with HBL2715SWR), (Not shown).	.350"-1.150" (9-29)	-	HBL2713SR	-



HBL2713SW

Insulgrip®

IP20 SUITABILITY

Description	Cord Dia.	Catalog Number		
Black and white nylon.	.350"-1.150" (9-29)	-	HBL2713	HBL2723
Black and white nylon, spring termination	.350"-1.150" (9-29)	-	HBL2713ST	HBL2723ST
Spring termination, all black			HBL2713STBK	-
Black and white nylon, (Not shown).	.300"-.950" (7.6-24.1)	HBL2663	-	-
Corrosion resistant, yellow nylon.	.350"-1.150" (9-29)	-	HBL27CM13	HBL27CM23
All black nylon.	.350"-1.150" (9-29)	-	HBL2713BK	-



HBL2713

Note: See page B-52 for accessories.

Receptacles

Watertight Safety-Shroud®

IP66 SUITABILITY UL Type 4x, 12

Description	Catalog Number		
Gray Valox® housing and flange, back wired.	-	HBL2710SW	HBL2720SW

Note: See page B-54 for accessories.

Safety-Shroud® Twist-Lock®

IP20 SUITABILITY

Description	Catalog Number		
Gray Valox® angle housing, one gang, back wired.	-	HBL2710AR	HBL2720AR
Gray Valox® surface mounting, one gang, back wired.	-	HBL2710SR	HBL2720SR
Gray Valox® semi-flush, two gang, back wired.	-	HBL2710SR2	HBL2720SR2



HBL2710SW

Single Flush Receptacles

IP20 SUITABILITY

Description	Catalog Number		
Black nylon face, back and side wired.	-	HBL2710	HBL2720
Black and white nylon, spring termination.	-	HBL2710ST	HBL2720ST
Black nylon face, back and side wired, (Not shown).	HBL2660	-	-
Isolated ground, orange nylon face, back and side wired.	-	IG2710	IG2720
Isolated ground, orange face, spring termination	-	IG2710ST	IG2720ST
Ring terminal connection.	-	HBL2710RT	HBL2720RT

Note: See page B-52 for accessories.

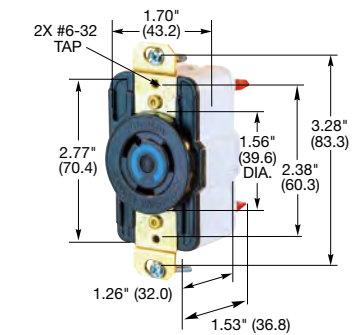

HBL2720ST

Insulgrip® Flanged Receptacles

Description	Catalog Number		
Nylon casing, back wired.	-	HBL2716	HBL2726
Nylon casing, back wire, spring termination	-	HBL2716ST	HBL2726ST

Note: See page B-52 for accessories.

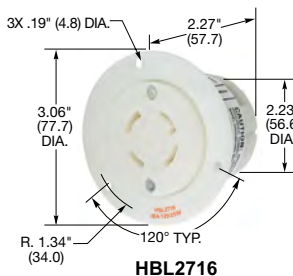

HBL2716

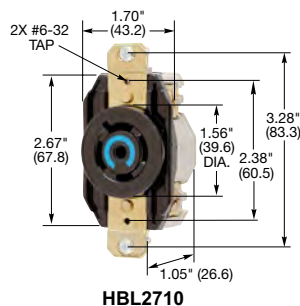

HBL2710

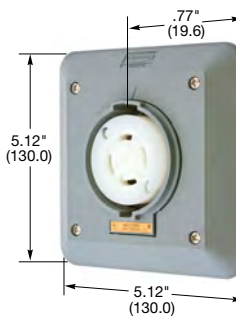

HBL2710SR2

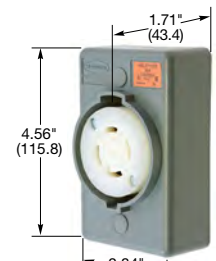

HBL2710SR

Valox® is a trademark of SABIC Innovative Plastics, acquired from General Electric Company.

Dimensions in Inches (mm)

**30 Amp, 3Ø 480 and 3Ø 600 Volts AC
3 Pole, 4 Wire, Grounding**

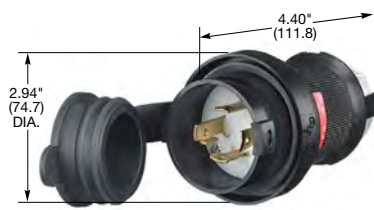

HBL2731SW

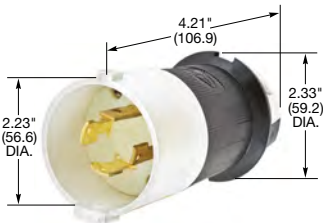

HBL2731S



HBL2731



HBL2735SW

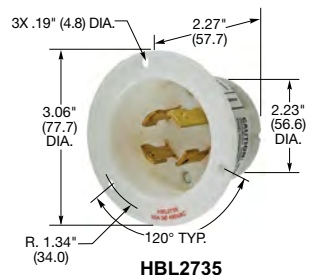

HBL2735

Dimensions in Inches (mm)

Plugs

Watertight Safety-Shroud®

Description	Cord Dia.	Catalog Number	IP66 SUITABILITY	UL Type 4x, 12
Black Valox® housing, white Valox® clamps.	.350"-1.150" (9-29)	HBL2731SW	HBL2741SW	

Safety-Shroud®

Description	Cord Dia.	Catalog Number	IP20 SUITABILITY
Black and white nylon body, white Valox® shroud. Can be used with the Insulgrip Connector Bodies.	.350"-1.150" (9-29)	HBL2731S	HBL2741S

Note: See page B-42 for accessories.

Insulgrip®

Description	Cord Dia.	Catalog Number	IP20 SUITABILITY
Black and white nylon.	.350"-1.150" (9-29)	HBL2731	HBL2741
Black and white nylon, spring termination.	.350"-1.150" (9-29)	HBL2731ST	-
Corrosion resistant, yellow nylon.	.350"-1.150" (9-29)	HBL27CM31	HBL27CM41

Note: See page B-52 for accessories.

Flanged Inlets

Watertight Safety-Shroud®

Description	Catalog Number	IP66 SUITABILITY	UL Type 4x, 12
Gray Valox® housing and flange.	HBL2735SW	HBL2745SW	

Note: See page B-54 for accessories.

Insulgrip®

Description	Catalog Number	IP20 SUITABILITY
Nylon casing, back wired.	HBL2735	HBL2745
Nylon casing, spring termination.	HBL2735ST	-

Note: See page B-52 for accessories.

See pages B-69 and B-70 for technical information on Twist-Lock and Watertight Safety-Shroud devices.



30A 3Ø 480V AC
NEMA L16-30P
10 HP

30A 3Ø 600V AC
NEMA L17-30P



HBLMITL - For use with Watertight Safety-Shroud receptacles, see page B-41.

Valox® is a trademark of SABIC Innovative Plastics, acquired from General Electric Company.

**30 Amp, 3Ø 480 and 3Ø 600 Volts AC
3 Pole, 4 Wire, Grounding**



30A 3Ø 480V AC NEMA L16-30R 10 HP	30A 3Ø 600V AC NEMA L17-30R
---	--------------------------------

Connector Bodies

Watertight Safety-Shroud®

Description	Cord Dia.	IP66 SUITABILITY	UL Type 4x, 12
Black Valox® housing, white Valox® clamps.	.350"-1.150" (9-29)	HBL2733SW	HBL2743SW



HBL2733SW

Insulgrip®

Description	Cord Dia.	IP20 SUITABILITY	Catalog Number
Black and white nylon.	.350"-1.150" (9-29)	HBL2733	HBL2743
Black and white nylon, spring termination	.350"-1.150" (9-29)	HBL2733ST	—
Corrosion resistant, yellow nylon.	.350"-1.150" (9-29)	HBL27CM33	HBL27CM43



HBL2733

Note: See page B-52 for accessories.

Receptacles

Watertight Safety-Shroud®

Description	IP66 SUITABILITY	UL Type 4x, 12
Gray Valox® housing and flange, back wired.	HBL2730SW	HBL2740SW

Note: See page B-54 for accessories.



HBL2733ST

Safety-Shroud® Twist-Lock®

Description	IP20 SUITABILITY	Catalog Number
Gray Valox® angle housing, one gang, back wired.	HBL2730AR	HBL2740AR
Gray Valox® surface mounting, one gang, back wired.	HBL2730SR	HBL2740SR
Gray Valox® semi-flush, two gang, back wired.	HBL2730SR2	HBL2740SR2



HBL2730SW

Single Flush Receptacles

Description	IP20 SUITABILITY	Catalog Number
Black nylon face, back and side wired.	HBL2730	HBL2740
Black and white nylon, spring termination.	HBL2730ST	—

Note: See page B-52 for accessories.

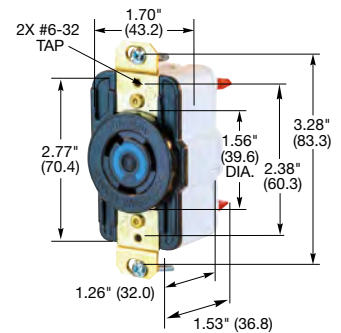

HBL2730ST

Insulgrip® Flanged Receptacles

Description	Catalog Number	
Nylon casing, back wired.	HBL2736	HBL2746
Nylon casing, back wire, spring termination	HBL2736ST	—

Note: See page B-52 for accessories.

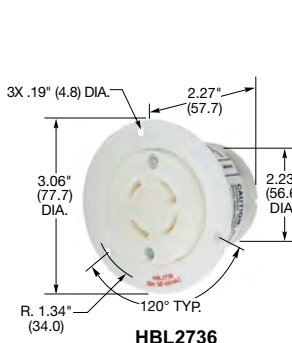

HBL2736

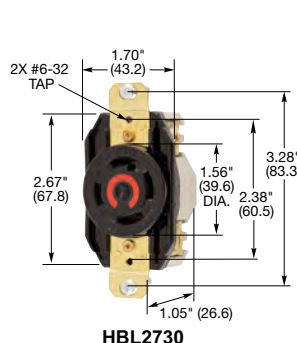

HBL2730

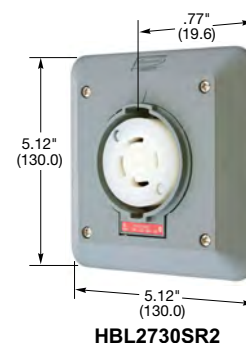

HBL2730SR2

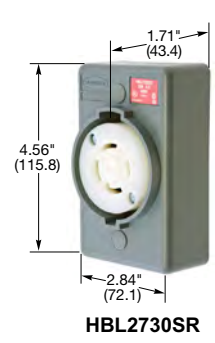

HBL2730SR

Valox® is a trademark of SABIC Innovative Plastics, acquired from General Electric Company.

Dimensions in Inches (mm)

**30 Amp, 3ØY 120/208, 277/480 and 347/600 Volts AC
4 Pole, 5 Wire, Grounding**



HBL2811SW

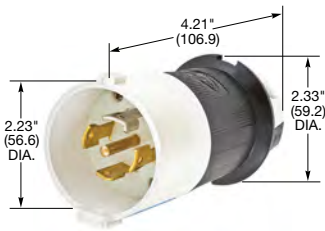

HBL2811S

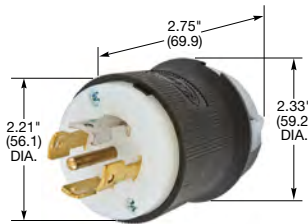

HBL2811



HBL2815SW

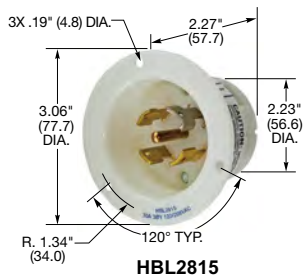

HBL2815

Dimensions in Inches (mm)



**30A 3ØY
120/208V AC
NEMA L21-30P
3 HP**



**30A 3ØY
240/415V AC
NEMA L26-30P**



**30A 3ØY
277/480V AC
NEMA L22-30P
10 HP**



**30A 3ØY
347/600V AC
NEMA L23-30P**

Plugs

Watertight Safety-Shroud®

IP66 SUITABILITY

UL Type 4x, 12

Description	Cord Dia.	Catalog Number			
Black Valox® housing, white Valox® clamps.	.350"-1.150" (9-29)	HBL2811SW	HBL2801	HBL2821SW	HBL2831SW

Safety-Shroud®

IP20 SUITABILITY

Description	Cord Dia.	Catalog Number			
Black and white nylon body, white Valox® shroud. Can be used with the Insulgrip Connector Bodies.	.350"-1.150" (9-29)	HBL2811S	-	-	-

Note: See page B-52 for accessories.

Insulgrip®

IP20 SUITABILITY

Description	Cord Dia.	Catalog Number			
Black and white nylon.	.350"-1.150" (9-29)	HBL2811	-	HBL2821	HBL2831
Black and white nylon, spring termination.	.350"-1.150" (9-29)	HBL2811ST	-	HBL2821ST	-
Corrosion resistant, yellow nylon.	.350"-1.150" (9-29)	HBL28CM11	-	-	-
Black and white for flat cable.	.350"-1.150" (9-29)	HBL2811FC	-	-	-
All black nylon.	.350"-1.150" (9-29)	HBL2811BK	-	-	-
All black nylon, spring termination.	.350"-1.150" (9-29)	HBL2811STBK	-	-	-

Note: See page B-52 for accessories.

Flanged Inlets

Watertight Safety-Shroud®

IP66 SUITABILITY

UL Type 4x, 12

Description	Catalog Number		
Gray Valox® housing and flange.	HBL2815SW	HBL2805	-

Note: See page B-54 for accessories.

Insulgrip®

IP20 SUITABILITY

Description	Catalog Number			
Nylon casing, back wired.	HBL2815	-	HBL2825	HBL2835
Nylon casing, spring termination.	HBL2815ST	-	HBL2825ST	-

Note: See page B-52 for accessories.

See pages B-69 and B-70 for technical information on Twist-Lock and Watertight Safety-Shroud devices.

Twist-Lock® 3-Phase Circuit Tester



Description	Rating	Catalog Number		
3-Phase Circuit Tester	3Ø 120/208V AC Min. Voltage: 90V AC	HBL3PT2811	-	-

Note: Testers in other NEMA configurations can be developed upon request.

See page B-53 for additional circuit testers.



HBL3PT2811

Valox® is a trademark of SABIC Innovative Plastics, acquired from General Electric Company.

HBLMITL - For use with Watertight Safety-Shroud receptacles, see page B-41.



30 Amp, 3ØY 120/208, 277/480 and 347/600 Volts AC 4 Pole, 5 Wire, Grounding



30A 3ØY 120/208V AC NEMA L21-30R 3 HP	30A 3ØY 240/415V AC NEMA L26-30R	30A 3ØY 277/480V AC NEMA L22-30R 10 HP	30A 3ØY 347/600V AC NEMA L23-30R
--	--	---	--

Connector Bodies

Watertight Safety-Shroud®

IP66 SUITABILITY

UL Type 4x, 12

Description	Cord Dia.	Catalog Number			
Black Valox® housing, white Valox® clamps.	.350"-1.150" (9-29)	HBL2813SW	HBL2803	HBL2823SW	–

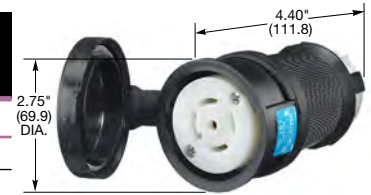

HBL2813SW

Insulgrip®

IP20 SUITABILITY

Description	Cord Dia.	Catalog Number			
Black and white nylon.	.350"-1.150" (9-29)	HBL2813	–	HBL2823	HBL2833
Black and white nylon, spring termination	.350"-1.150" (9-29)	HBL2813ST	–	HBL2823ST	–
Spring termination, all black		HBL2813STBK	–	–	–
Corrosion resistant, yellow nylon.	.350"-1.150" (9-29)	HBL28CM13	–	–	–
Black and white for flat cable.	.350"-1.150" (9-29)	HBL2813FC	–	–	–
All black nylon.	.350"-1.150" (9-29)	HBL2813BK	–	–	–



HBL2813ST



HBL2813

Note: See page B-52 for accessories.

Receptacles

Watertight Safety-Shroud®

IP66 SUITABILITY

UL Type 4x, 12

Description	Catalog Number			
Gray Valox® housing and flange, back wired.	HBL2810SW	–	HBL2820SW	HBL2830SW

Note: See page B-54 for accessories.



HBL2810SW

Safety-Shroud® Twist-Lock®

IP20 SUITABILITY

Description	Catalog Number			
Gray Valox® angle housing, one gang, back wired.	HBL2810AR	–	–	–
Gray Valox® surface mounting, one gang, back wired.	HBL2810SR	–	–	–
Gray Valox® semi-flush, two gang, back wired.	HBL2810SR2	–	–	–

Single Flush Receptacles

IP20 SUITABILITY

Description	Catalog Number			
Black nylon face, back and side wired.	HBL2810	HBL2800	HBL2820	HBL2830
Black and white nylon, spring termination	HBL2810ST	–	HBL2820ST	–
Isolated ground, orange nylon face, back and side wired.	IG2810	–	–	–
Ring terminal connection.	HBL2810RT	–	–	–

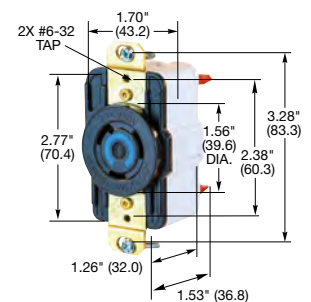

HBL2820ST

Note: See page B-52 for accessories.

Insulgrip® Flanged Receptacles

Description	Catalog Number			
Nylon casing, back wired.	HBL2816	–	HBL2826	HBL2836
Nylon casing, back wire, spring termination	HBL2816ST	–	HBL2826ST	–
Black nylon casing, back wire, spring termination	HBL2816STBK	–	–	–

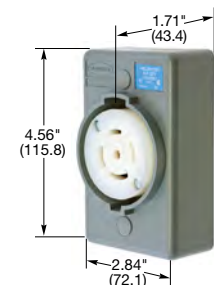

HBL2810SR

Note: See page B-52 for accessories.

Valox® is a trademark of SABIC Innovative Plastics, acquired from General Electric Company.

Dimensions in Inches (mm)

30 Amp, 3ØY 120/208, 277/480 and 347/600 Volts AC 4 Pole, 4 Wire, Non-Grounding

IP20
SUITABILITY



30A 3ØY 120/208V AC
NEMA L18-30P
3 HP

30A 3ØY 277/480V AC
NEMA L19-30P
10 HP

30A 3ØY 347/600V AC
NEMA L20-30P

Plugs



HBL2751

Description	Cord Dia.	Catalog Number
Black and white nylon.	.350"-1.150" (9-29)	HBL2751 HBL2761 HBL2771

Note: See page B-53 for accessories.

Flanged Inlets

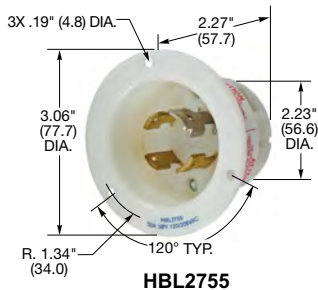

HBL2755

Description	Catalog Number
Nylon casing, back wired.	HBL2755 HBL2765 HBL2775

Note: See page B-52 for accessories.

IP20
SUITABILITY



30A 3ØY 120/208V AC
NEMA L18-30R
3 HP

30A 3ØY 277/480V AC
NEMA L19-30R
10 HP

30A 3ØY 347/600V AC
NEMA L20-30R

Connector Bodies



HBL2753

Description	Cord Dia.	Catalog Number
Black and white nylon.	.350"-1.150" (9-29)	HBL2753 HBL2763 HBL2773

Note: See page B-52 for accessories.

Single Flush Receptacles

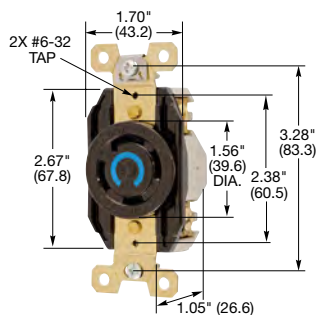

HBL2750

Description	Catalog Number
Black nylon face, back and side wired.	HBL2750 HBL2760 HBL2770

Note: See page B-52 for accessories.

Flanged Receptacles

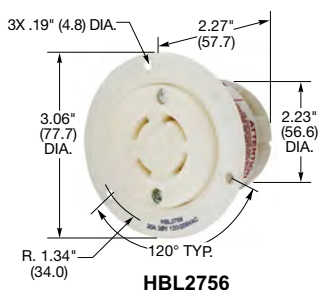

HBL2756

Description	Catalog Number
Nylon casing, back wired.	HBL2756 HBL2766 HBL2776

Note: See page B-52 for accessories.

See page B-69 for technical information on Twist-Lock devices.

Dimensions in Inches (mm)

30 Amp, 480 and 600 Volts AC 2 Pole, 3 Wire, Grounding

IP20
SUITABILITY



30A 240V AC
NEMA L25-30P

30A 480V AC
NEMA L8-30P
5 HP

30A 600V AC
NEMA L9-30P

Plugs

Description	Cord Dia.	Catalog Number
Black and white nylon.	.325"-.930" (8.25-24)	HBL2601 HBL2641 HBL2651

Note: See page B-52 for accessories.

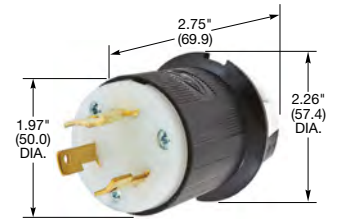

HBL2651

Flanged Inlets

Description	Catalog Number
Nylon casing, back wired.	HBL2605 HBL2645 HBL2655

Note: See page B-52 for accessories.

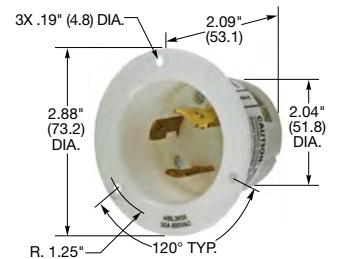

HBL2655

Connector Bodies

IP20
SUITABILITY



30A 240V AC
NEMA L25-30R

30A 480V AC
NEMA L8-30R
5 HP

30A 600V AC
NEMA L9-30R

Description	Cord Dia.	Catalog Number
Black and white nylon.	.325"-.930" (8.25-24)	HBL2603 HBL2643 HBL2653

Note: See page B-52 for accessories.



HBL2653

Single Flush Receptacles

Description	Catalog Number
Black nylon face, back and side wired.	HBL2600 HBL2640 HBL2650

Note: See page B-52 for accessories.

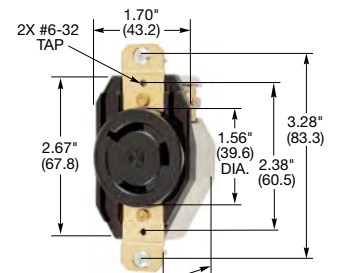

HBL2650

Flanged Receptacles

Description	Catalog Number
Nylon casing, back wired.	— HBL2646 HBL2656

Note: See page B-52 for accessories.

See page B-69 for technical information on Twist-Lock devices.

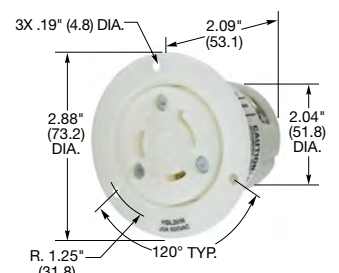

HBL2656

Dimensions in Inches (mm)

Twist-Lock® Devices

Features and Benefits

Switched Safety Enclosures

The Switched Twist-Lock® and Hubbell® Enclosures integrate a receptacle and a switch to produce distinct advantages for the user. This enclosure replaces box, switch, cover and all in a compact design that meets Type 3R Rainproof or 12K Dust-tight requirements.

The receptacle is angled downward for a low profile, and it maintains a low profile while accommodating either a 20 or 30 Amp Twist-Lock receptacle or 30 Amp, 4 wire Hubbell receptacle. The enclosure can be used in top, bottom or back feed applications. The handle is designed to be locked in the OFF position for lockout protection.

Hubbell has developed the Switched Safety Enclosure because users want to be able to disconnect higher voltage devices confidently. Hubbell responded with a line of Switched Safety Enclosures for Twist-Lock and Hubbell receptacles.

The provision of the integral switch and the receptacle in a compact, non-metallic enclosure encourages the safe operating practice of disconnecting at the switch rather than the plug and receptacle.

For plants and factories in a wide variety of industries, as well as light industrial facilities, Hubbell's Switched Enclosures offer an upgrade that's convenient, compact and easy to install.



Housing Design

- Angled 20 or 30 amp Hubbell Twist-Lock receptacle provides low profile and helps control cable arc of bend
- Large receptacle gasketless door and hinge assembly
- Enclosure back is designed for top, bottom or back feed options

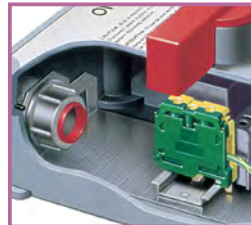

Internal Design

- Horsepower rated switch
- Heavy duty internal frame bonds conduit and all grounds and has a DIN rail to accommodate the switch



Safety

- Lockable handle provides lockout protection for greater safety and complies with OSHA lockout requirements

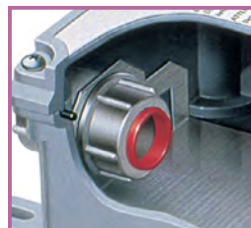

Wiring

- Premolded conduit entry hole is offset to prevent water condensation from falling directly on interior electrical components



Installation

- Moveable feet may be used in horizontal or vertical position or may be removed and premarked holes drilled for Type 1 or 3R installations

Twist-Lock® Devices

Switched Twist-Lock® and Hubbellock® Enclosures



UL Listed, CSA Certified
Type 3R and 12K Enclosure Rating

IP54
SUITABILITY

Switched Enclosure Ready for Twist-Lock® Receptacle Addition

Ideal unit for stockroom. This single unit provides the complete enclosure ready to accept any Hubbell 20 or 30A Twist-Lock receptacle.

Description	Ratings	Catalog Number
Switched Twist-Lock enclosure accommodates any NEMA 2 pole, 3 wire to 4 pole, 5 wire grounding receptacle (sold separately).	Amperage, voltage, and horsepower ratings will be determined by the choice of the NEMA 20 or 30A Twist-Lock receptacle selected.	SETL3
Auxiliary contact.	"Break After Main Break", 1 set of n/o contacts, 1 set of n/c contacts.	HBLAC1
Auxiliary contact.	"Break Before Main Break", 1 set of n/o contacts.	HBLAC2

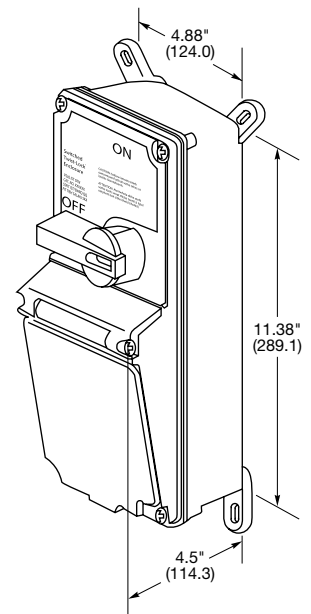

SETL3

Switched Enclosure Complete with Twist-Lock® Receptacle

Completely pre-wired with a Twist-Lock receptacle, these application oriented combinations are available to satisfy your needs.

Description	Amps	Voltage	NEMA Config.	Horsepower	Switched Enclosure	Use Twist-Lock Plug
Switched Twist-Lock enclosure with a pre-wired HBL2720 receptacle.	30	3Ø 240V AC	L15-30R	3	SE2720A	HBL2721
Switched Twist-Lock enclosure with a pre-wired HBL2730 receptacle.	30	3Ø 480V AC	L16-30R	10	SE2730A	HBL2731



SE2720A

Switched Enclosure Ready for Hubbellock® Receptacle Addition

Ideal unit for stockroom. This single unit provides the complete enclosure ready to accept your 30A, 4 wire Hubbellock receptacle choice.

Description	Ratings	Catalog Number
Switched enclosure for use with 3 pole 4 wire 30A Hubbellock receptacle (sold separately).	Amperage, voltage, and horsepower ratings will be determined by the choice of the 4 wire Hubbellock receptacle selected.	SEHBL3
Auxiliary contact.	"Break After Main Break", 1 set of n/o contacts, 1 set of n/c contacts.	HBLAC1
Auxiliary contact.	"Break Before Main Break", 1 set of n/o contacts.	HBLAC2



HBLAC1

HBLAC2

Replacement Mounting Feet

Description	Catalog Number
For 30A switches.	HBLRFT1^Δ

Note: ^Δ Package of 10 feet and 10 screws.
See page B-72 for technical information on Switched Safety Enclosures.



HBLRFT1

Dimensions in Inches (mm)

Twist-Lock® Devices

Features and Benefits

Mechanical Interlock Switched Safety Enclosures

Hubbell offers the only mechanical interlock for Twist-Lock®. This new, unfused mechanical interlock for Watertight Safety-Shroud® Twist-Lock® integrates a watertight receptacle with a linked disconnect switch to provide a mechanically interlocked receptacle. This virtually eliminates the possibility of making or breaking the circuit while under load or making a casual or “lazy” connection.

The switch cannot be turned ON until the plug is properly inserted and locked, and the plug cannot be removed until the switch is turned OFF. All these protective features are included in a compact Type 4X hose-directed water and corrosion resistant enclosure that allows for top, bottom or back feed options.

The non-metallic enclosure is nonconductive, yet has an internal frame to assure ground continuity with metallic conduit.

In addition, this interlock works with all Safety-Shroud Twist-Lock Plugs. The new unfused mechanical interlock for Watertight Safety-Shroud Twist-Lock can be locked out as a method of compliance with OSHA lockout/tagout regulations.



Housing Design

- Angled 20 or 30 amp Hubbell Watertight Safety-Shroud Twist-Lock receptacle provides watertight, low profile and mechanical interlock capabilities (ordered separately)
- Enclosure back is designed for top, bottom or back feed options

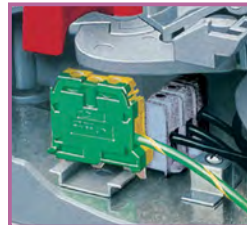

Internal Design

- Horsepower rated switch
- Heavy duty internal frame bonds conduit and all grounds and has a DIN rail to accommodate the switch



Safety

- Lockable handle provides lockout protection for greater safety and complies with OSHA lockout requirements
- Heavy duty interlock linkage prevents make and break under load

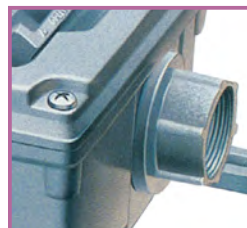

Wiring

- Premolded conduit entry hole is offset to prevent water condensation from falling directly on interior electrical components, while speeding installation by making it easier to pull conductors



Installation

- Moveable feet may be used in horizontal or vertical position or may be removed and premarked holes drilled for Type 1 or 3R installations

Twist-Lock® Devices

Mechanical Interlock Switched Safety Enclosures



UL Listed, CSA Certified TYPE 4,
4X and TYPE 12K Enclosure Rating

IP66
SUITABILITY

Mechanical Interlock Ready for Twist-Lock® Receptacle Addition

This unit is a complete enclosure ready to accept any 20 or 30A Watertight Safety-Shroud Twist-Lock Receptacle.

Description	Ratings	Catalog Number
Mechanical Interlock accommodates 20A or 30A Watertight Safety-Shroud Twist-Lock receptacles.	Amperage and voltage ratings will be determined by the choice of the Watertight Safety-Shroud Twist-Lock selected. Supplied with 3/4" NPT Hub.	HBLMITL

Accepts the following Watertight Safety-Shroud® Twist-Lock® Receptacles: 20 Amp

Rating	Voltage AC	NEMA Config.	Max. HP Rating*	Receptacle Catalog Number	Use Watertight Safety-Shroud Twist-Lock Plug
2 Pole, 3 Wire	120	L5-20	1	HBL2310SW	HBL2311SW
	208-240	L6-20	2.5	HBL2320SW	HBL2321SW
	277	L7-20	3	HBL2330SW	HBL2331SW
3 Pole, 4 Wire	120/240	L14-20	2.5	HBL2410SW	HBL2411SW
	240 3Ø	L15-20	5 (3@208V)	HBL2420SW	HBL2421SW
	480 3Ø	L16-20	10	HBL2430SW	HBL2431SW
4 Pole, 5 Wire	120/208 3ØY	L21-20	3	HBL2510SW	HBL2511SW

30 Amp

2 Pole, 3 Wire	120	L5-30	1	HBL2610SW	HBL2611SW
	208-240	L6-30	3	HBL2620SW	HBL2621SW
	277	L7-30	3	HBL2710SW	HBL2711SW
3 Pole, 4 Wire	240 3Ø	L15-30	7.5	HBL2720SW	HBL2721SW
	480 3Ø	L16-30	15	HBL2730SW	HBL2731SW
	600 3Ø	L17-30	15	HBL2740SW	HBL2741SW
4 Pole, 5 Wire	120/208 3ØY	L21-30	7.5	HBL2810SW	HBL2811SW
	277/480	L22-30	7.5	HBL2820SW	HBL2821SW
	347/600	L23-30	7.5	HBL2830SW	HBL2831SW

30 Amp Reverse Service

2 Pole, 3 Wire	120	L5-30	1	HBL2615SWR	HBL2613SR
3 Pole, 4 Wire	120/240	L14-30	3	HBL2715SWR	HBL2713SR
3 Pole, 4 Wire	240 3Ø	L15-30	7.5	HBL2725SWR	HBL2723SR

Auxiliary Contacts

Description	Ratings	Catalog Number
Auxiliary contact.	"Break After Main Break", 1 set of n/o contacts, 1 set of n/c contacts.	HBLAC1
Auxiliary contact.	"Break Before Main Break", 1 set of n/o contacts.	HBLAC2

Replacement Parts

Description	Catalog Number
Ground block.	HBL30RGB
Neutral block.	HBL30RNB
Replacement switch.	HBLDS3RS

Replacement Mounting Feet

Description	Catalog Number
For 30A switches.	HBLRFT1^A

Note: *HP ratings for the final unit are determined by the HP rating of the switch, limited by the full load current capability of the receptacle at 80% of rated current, number of phases and line voltage. HP ratings listed above are AC only.

^APackage of 10 feet and 10 screws.

See page B-73 for technical information on Mechanical Interlock Enclosures.

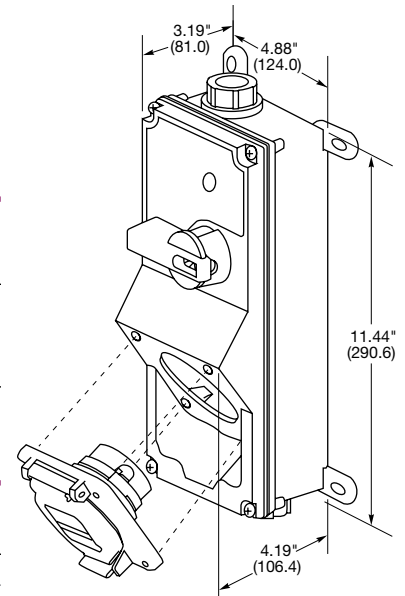

HBLMITL



HBL2620SW



HBL2713SR



HBLAC1



HBLAC2



HBL30RGB



HBL30RNB



HBLRFT1

Dimensions in Inches (mm)

Twist-Lock® Devices

ADD-A-SHROUD® and Adapters



Safety-Shroud® Twist-Lock® – 20 and 30 Amp

The Add-A-Shroud® devices allow conversion of existing 20A and 30A 3 to 5 wire Hubbell Insulgrip® Twist-Lock devices to a Safety-Shroud Twist-Lock plug. These devices provide a convenient and cost-effective way to convert existing Hubbell Insulgrip Twist-Lock plugs to Safety-Shroud Twist-Lock plugs. The Safety-Shroud Twist-Lock plug permits engagement with the Hubbell Mechanical Interlock Enclosure which virtually prevents make and break under load.

Add-A-Shroud® Catalog Number HBLSS3

For conversion of all 3 wire Hubbell Insulgrip Twist-Lock Devices.

Rating	Voltage AC	NEMA Config. Reference Number	Plug Catalog Number	Add-A-Shroud Catalog Number
20A, 2 Pole 3 Wire Grounding	125V	L5-20	HBL2311	HBLSS3
	250V	L6-20	HBL2321	HBLSS3
	277V AC	L7-20	HBL2331	HBLSS3
	480V AC	L8-20	HBL2341	HBLSS3
	600V AC	L9-20	HBL2351	HBLSS3
30A, 2 Pole 3 Wire Grounding	125V	L5-30	HBL2611	HBLSS3
	250V	L6-30	HBL2621	HBLSS3
	277V AC	L7-30	HBL2631	HBLSS3
	480V AC	L8-30	HBL2641	HBLSS3
	600V AC	L9-30	HBL2651	HBLSS3



HBLSS3



HBLSS45

Add-A-Shroud® Catalog Number HBLSS45

For conversion of all 4 and 5 wire Hubbell Insulgrip Twist-Lock Devices.

Rating	Voltage AC	NEMA Config. Reference Number	Plug Catalog Number	Add-A-Shroud Catalog Number
20A, 3 Pole 4 Wire Grounding	125/250V AC	L14-20	HBL2411	HBLSS45
	3Ø 250V AC	L15-20	HBL2421	HBLSS45
	3Ø 480V AC	L16-20	HBL2431	HBLSS45
30A, 3 Pole 4 Wire Grounding	125/250V AC	L14-30	HBL2711	HBLSS45
	3Ø 250V AC	L15-30	HBL2721	HBLSS45
	3Ø 480V AC	L16-30	HBL2731	HBLSS45
	3Ø 600V AC	L17-30	HBL2741	HBLSS45
20A, 4 Pole 5 Wire Grounding	3ØY 120/208V AC	L21-20	HBL2511	HBLSS45
	3ØY 277/480V AC	L22-20	HBL2521	HBLSS45
	3ØY 347/600V AC	L23-20	HBL2531	HBLSS45
30A, 4 Pole 5 Wire Grounding	3ØY 120/208V AC	L21-30	HBL2811	HBLSS45
	3ØY 277/480V AC	L22-30	HBL2821	HBLSS45
	3ØY 347/600V AC	L23-30	HBL2831	HBLSS45



WTSS234



WTSS234SS



WTSS310



WTSS310SS

Watertight Safety Shroud - Deluxe Cord Grip and Metallic Liquidtight Conduit Fitting Adapters

Adapter for Use with 3/4" NPT Fittings

Description	Cord Dia.	Catalog Number
3 Wire, Anodized Aluminum	.250" - .750"	WTSS234
3 Wire, Stainless Steel	.250" - .750"	WTSS234SS
4 and 5 Wire, Anodized Aluminum	.250" - .750"	WTSS334
4 and 5 Wire, Stainless Steel	.250" - .750"	WTSS334SS

Adapter for Use with 1" NPT Fittings

Description	Cord Dia.	Catalog Number
4 and 5 Wire, Anodized Aluminum	.375" - 1.00"	WTSS310
4 and 5 Wire, Stainless Steel	.375" - 1.00"	WTSS310SS

Twist-Lock® Devices

Non-NEMA 10 Amp, 250 Volts, 15 Amp 125 Volts 3 Pole, 3 Wire, Non-Grounding and 2 Pole, 3 Wire, Grounding

For Replacement Use Only

IP20
SUITABILITY



Not Grounded
Not UL listed

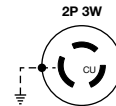

Grounded
Not UL listed

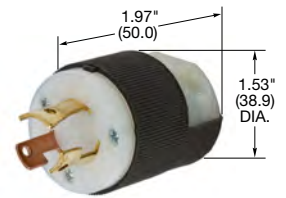

HBL7567C

Plugs

Description	Cord Dia.	Catalog Number	
Black and white nylon. Multiple drive screws.	230"-.720" (5.8-18.3)	HBL7567C	—
Yellow and white nylon. Multiple drive screws.	230"-.720" (5.8-18.3)	HBL7567CY	—

Note: See page B-51 for accessories.

Flanged Inlets

Description	Catalog Number	
Stainless steel casing.	HBL7556	HBL7556G

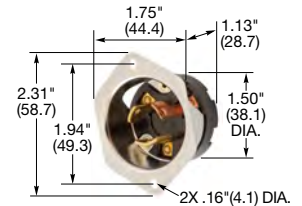

HBL7556

For Replacement Use Only

IP20
SUITABILITY



Not Grounded
Not UL listed

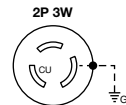

Grounded
Not UL listed



HBL7565C

Connector Bodies

Description	Cord Dia.	Catalog Number	
Insulgrip connector, black and white nylon. Multiple drive screws.	230"-.720" (5.8-18.3)	HBL7565C	—
Insulgrip connector, yellow and white nylon. Multiple drive screws.	230"-.720" (5.8-18.3)	HBL7565CY	—
Black phenolic.	.296"-.625" (7.5-15.9)	HBL7555	HBL7555G

Note: See page B-51 for accessories.

Receptacles

Description	Catalog Number	
Duplex, black RTP*, back and side wired.	HBL7580	HBL7580G
Single, black phenolic, back and side wired.	HBL7582	HBL7582G

Note: See page B-50 for accessories.

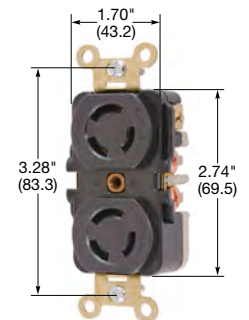

HBL7580

Flanged Receptacles

Description	Catalog Number	
Stainless steel casing.	HBL7557	HBL7557G

Note: *RTP is an abbreviation for reinforced thermoplastic.

The devices shown on this page are not listed by Underwriters Laboratories Inc. and are for replacement use only in existing installations.

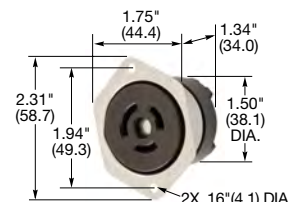

HBL7557

CAUTION: To avoid electrical shock, review premises carefully and do not use if slot or blade configuration (design) is already in a circuit having a rating differing from the rating of this device.

Dimensions in Inches (mm)

Twist-Lock® Devices

Non-NEMA 20 Amp, 250, 125/250 Volts and 3ØY 120/208 Volts AC
2 Pole, 3 Wire, Grounding and
3 Pole, 3 Wire, Non-Grounding



HBL9965C

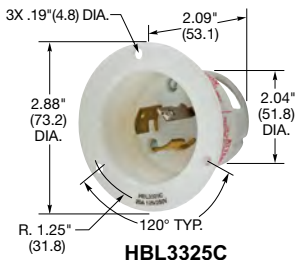

HBL3325C



HBL7411C



HBL7408C

For Replacement Use Only

IP20
SUITABILITY

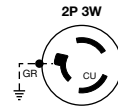

20A 250V
Non-NEMA
Not UL Listed

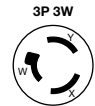

20A 125/250V
Non-NEMA
Not UL Listed

Plugs

Description	Cord Dia.	Catalog Number	
Black and white nylon.	.360"-.930" (9-24)	HBL9965GCB	HBL9965C
Corrosion resistant, yellow nylon.	.360"-.930" (9-24)	—	HBL99CM65C

Note: See page B-52 for accessories.

Flanged Inlets

Description	Catalog Number
Nylon casing, back wired.	— HBL3325C

Note: See page B-52 for accessories.

For Replacement Use Only

IP20
SUITABILITY

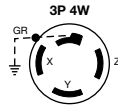

20A 3Ø 250V AC
Non-NEMA
Not UL Listed

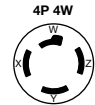

20A 3Ø Y
120/208V AC
Non-NEMA
Not UL Listed

Plugs

Description	Cord Dia.	Catalog Number	
Black and white nylon.	.350"-1.150" (9-29)	HBL7411GCB	HBL7411C

Note: See page B-52 for accessories.

Flanged Inlets

Description	Catalog Number
Nylon casing, back wired.	— HBL7408C

Note: See page B-52 for accessories.

The devices shown on this page are not listed by Underwriters Laboratories Inc. and are for replacement use only in existing installations.

Dimensions in Inches (mm)

CAUTION: To avoid electrical shock, review premises carefully and do not use if slot or blade configuration (design) is already in a circuit having a rating differing from the rating of this device.

Twist-Lock® Devices

Non-NEMA 20 Amp, 250, 125/250 Volts and 3ØY 120/208 Volts AC 2 Pole, 3 Wire, Grounding and 3 Pole, 3 Wire, Non-Grounding

For Replacement Use Only

IP20
SUITABILITY

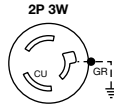

20A 250V
Non-NEMA
Not UL Listed



20A 125/250V
Non-NEMA
Not UL Listed

Connector Bodies

Description	Cord Dia.	Catalog Number
Black and white nylon.	.360"-.930" (9-24)	HBL7314GCB HBL7314C
Corrosion resistant, yellow nylon.	.360"-.930" (9-24)	— HBL73CM14C

Note: See page B-52 for accessories.



HBL7314C

Single Flush Receptacles

Description	Catalog Number
Black nylon face, back wired.	HBL7310BG HBL7310B

Note: See page B-52 for accessories.

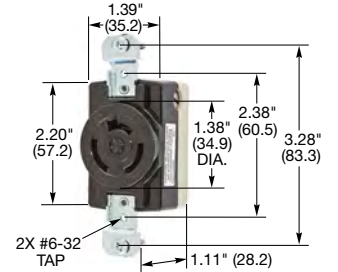

HBL7310B

Flanged Receptacles

Description	Catalog Number
Nylon casing, back wired.	— HBL3326C

Note: See page B-52 for accessories.

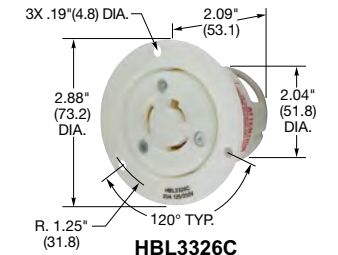

HBL3326C

For Replacement Use Only

IP20
SUITABILITY

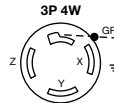

20A 3Ø 250V AC
Non-NEMA
Not UL Listed



20A 3Ø Y
120/208V AC
Non-NEMA
Not UL Listed

Connector Bodies

Description	Cord Dia.	Catalog Number
Black and white nylon.	.350"-1.150" (9-29)	HBL7413GCB HBL7413C

Note: See page B-52 for accessories.



HBL7413GCB

Single Flush Receptacles

Description	Catalog Number
Black thermoset, back wired.	HBL7410BG HBL7410B
Mounted on a 4" (101.6) round metal cover.	— HBL7417B

Note: See page B-52 for accessories.

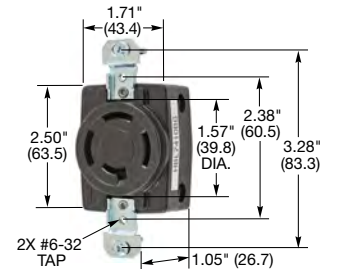

HBL7410BG

Flanged Receptacles

Description	Catalog Number
Nylon casing, back wired.	— HBL7409C

Note: See page B-52 for accessories.

The devices shown on this page are not listed by Underwriters Laboratories Inc. and are for replacement use only in existing installations.

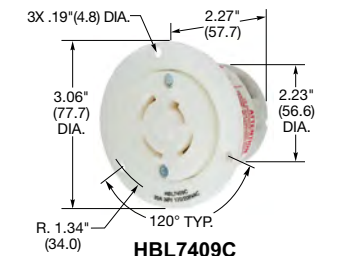

HBL7409C

Dimensions in Inches (mm)

CAUTION: To avoid electrical shock, review premises carefully and do not use if slot or blade configuration (design) is already in a circuit having a rating differing from the rating of this device.

Non-NEMA 20 Amp, 250 Volts, 10 Amp, 600 Volts AC 4 Pole, 5 Wire, Grounding

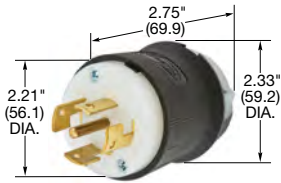

HBL3521C

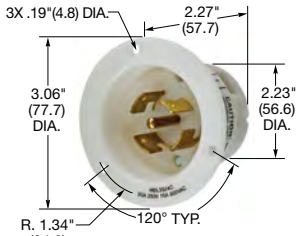

HBL3524C



HBL3523C

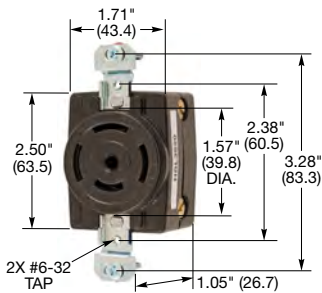

HBL3520



HBL3525C

Dimensions in Inches (mm)

For Replacement Use Only

IP20
SUITABILITY



Plugs

Description	Cord Dia.	Catalog Number
Black and white nylon.	.350"-1.150" (9-29)	HBL3521C
Black and white nylon, spring termination		HBL3521CST

Note: See page B-52 for accessories.

Flanged Inlets

Description	Catalog Number
Insulgrip nylon casing, back wired.	HBL3524C

Note: See page B-52 for accessories.

IP20
SUITABILITY



Connector Bodies

Description	Cord Dia.	Catalog Number
Black and white nylon.	.350"-1.150" (9-29)	HBL3523C
Black and white nylon, spring termination		HBL3523CST

Note: See page B-52 for accessories.

Single Flush Receptacles

Description	Catalog Number
Black thermoset, back wired.	HBL3520

Note: See page B-52 for accessories.

Flanged Receptacles

Description	Catalog Number
Insulgrip nylon casing, back wired.	HBL3525C

Note: See page B-52 for accessories.

CAUTION: To avoid electrical shock, review premises carefully and do not use if slot or blade configuration (design) is already in a circuit having a rating differing from the rating of this device.

Twist-Lock® Devices

**Non-NEMA 30 Amp, 250, 125/250 Volts and 3ØY 120/208 Volts AC
2 Pole, 3 Wire, Grounding and
3 Pole, 3 Wire, Non-Grounding**

For Replacement Use Only

IP20
SUITABILITY

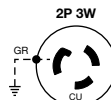

Insulgrip® Plugs

Description	Cord Dia.	Catalog Number
Black and white nylon.	.360"-.930" (9-24)	HBL3331GC HBL3331C

Note: See page B-52 for accessories.

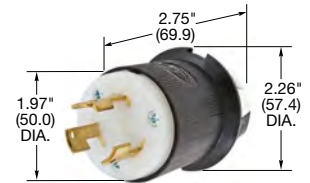

HBL3331GC

Insulgrip® Flanged Inlets

Description	Catalog Number
Nylon casing, back wired.	— HBL3334C

Note: See page B-52 for accessories.

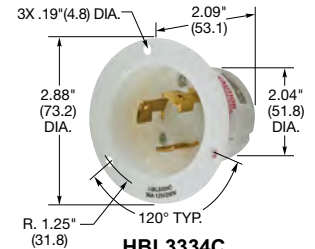

HBL3334C

For Replacement Use Only

IP20
SUITABILITY

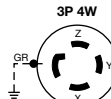

Insulgrip® Plugs

Description	Cord Dia.	Catalog Number
Black and white nylon.	.350"-1.150" (9-29)	HBL3431GCB HBL3431C

Note: See page B-52 for accessories.

The devices shown on this page are not listed by Underwriters Laboratories Inc. and are for replacement use only in existing installations.



HBL3431C

CAUTION: To avoid electrical shock, review premises carefully and do not use if slot or blade configuration (design) is already in a circuit having a rating differing from the rating of this device.

Dimensions in Inches (mm)

Twist-Lock® Devices

**Non-NEMA 30 Amp, 250, 125/250 Volts and 3ØY 120/208 Volts AC
2 Pole, 3 Wire, Grounding and
3 Pole, 3 Wire, Non-Grounding**



HBL3333GC

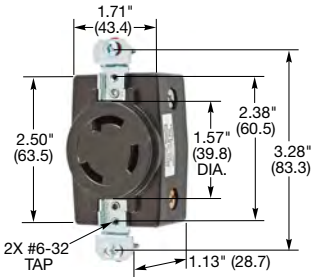

HBL3330G

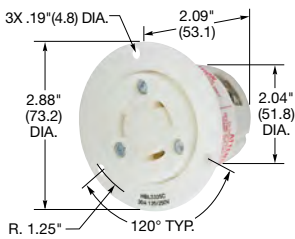

HBL3335C



HBL3433C

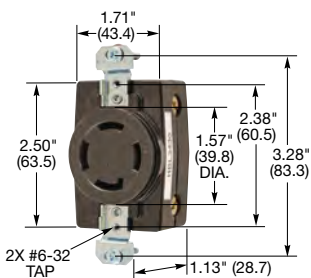

HBL3430

For Replacement Use Only

IP20
SUITABILITY

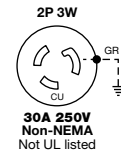

Insulgrip® Connector Bodies

Description	Cord Dia.	Catalog Number
Black and white nylon.	.360"- .930" (9-24)	HBL3333GC HBL3333C

Note: See page B-52 for accessories.

Single Flush Receptacles

Description	Catalog Number
Black thermoset, back wired.	HBL3330G HBL3330

Note: See page B-52 for accessories.

Insulgrip® Flanged Receptacles

Description	Catalog Number
Nylon casing, back wired.	— HBL3335C

Note: See page B-52 for accessories.

For Replacement Use Only

IP20
SUITABILITY

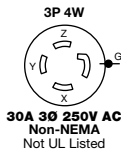

Insulgrip® Connector Bodies

Description	Cord Dia.	Catalog Number
Black and white nylon.	.350"-1.150" (9-29)	HBL3433GCB HBL3433C

Note: See page B-52 for accessories.

Single Flush Receptacles

Description	Catalog Number
Black thermoset, back wired.	HBL3430G HBL3430

Note: See page B-52 for accessories.

Insulgrip® Flanged Receptacles

Description	Catalog Number
Nylon casing, back wired.	HBL3435CM2 —

Note: See page B-52 for accessories.

The devices shown on this page are not listed by Underwriters Laboratories Inc. and are for replacement use only in existing installations.

CAUTION: To avoid electrical shock, review premises carefully and do not use if slot or blade configuration (design) is already in a circuit having a rating differing from the rating of this device.

Dimensions in Inches (mm)

Non-NEMA 30 Amp, 250 Volts DC Max. and 600 Volts AC Max. 50 - 400Hz
Non-NEMA 20 Amp, 3ØY 120/208 Volts AC 400Hz

Variload® Twist-Lock® Devices

In many large plants and laboratories the number of circuits of different ratings and frequency is greater than the number of blade configurations available in conventional wiring devices.

Prior to NEMA configuration standardization the solution was “Variload® Twist-Lock®” devices with four non-interchangeable center pin and slot configurations that can be assigned within the same premises to circuits of same voltage, frequency and supply (AC or DC), in accordance with NEC® 406.4(F) and 406.8 and with CE Code, Part I, Rule 26-700(3).

30A, 250V DC Max. and 600V AC Max. 50 - 400Hz

Center Pin Configuration	Plugs	Flanged Inlets	Connector Bodies	Receptacles
	HBL45115	–	HBL45135	HBL45105
	HBL45215	–	HBL45235	HBL45205
	HBL45315	–	HBL45335	HBL45305

20A 3ØY, 120/208V AC Only, 400Hz

Center Pin Configuration	Plugs	Flanged Inlets	Connector Bodies	Receptacles
	HBL45915†	HBL45985CL†	HBL45935†	HBL45905†

Note: †UL Listed only.

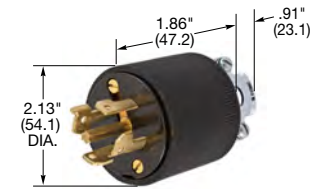

HBL45315

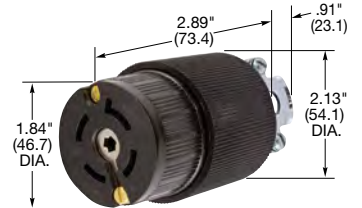

HBL45335

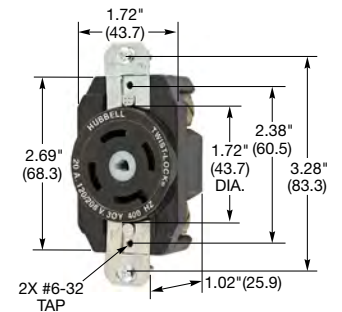

HBL45305

Receptacle Wallplates

Description	Catalog Number
Single Receptacle with Face Dia. 1.74" (44.2)	SS725
Stainless steel 302/304, .035 in. (0.9), horizontal brushed finish.	



SS725

IP55*
SUITABILITY

Weatherproof Boots

Description	Catalog Number
Seal-Tite® black elastomer for Variload® plugs.	HBL6027**
Seal-Tite® black elastomer for Variload® connector bodies.	HBL6028**

Note: *When installed and used properly with plug and connector body combinations.
 ** Weatherproof boots not UL Listed, nor CSA Certified.



HBL6027



HBL6028

CAUTION: To avoid electrical shock, review premises carefully and do not use if slot or blade configuration (design) is already in a circuit having a rating differing from the rating of this device.

Dimensions in Inches (mm)

Accessories for 15 Amp 2 and 3 Wire Devices



P8



SS7



HBL5206WO



HBL5221



HBL7423WO



WP1

Wallplates, 1-Gang

Description	Color	Duplex Receptacles	Single Receptacles with Face Dia. 1.40" (35.6)
Nylon, smooth.	Brown Ivory	P8 P8I	P7 P7I
Stainless steel 302/304, .035 in. (0.9), horizontal brushed finish.		SS8	SS7
Stainless steel 430, .035 in. (0.9), horizontal brushed finish.		SS8L	SS7L
Brass .04 in. (1.0), horizontal brushed finish.		SB8	SB7
Aluminum .05 in. (1.3), horizontal brushed finish.		SA8	SA7

IP44
SUITABILITY

Weatherproof Covers

Description	Duplex Receptacles	Single Receptacles with Face Dia. 1.40" (35.6)
Cast aluminum, for standard horizontal box mount.	HBL5205WO	–
Same as above except FS/FD box mount.	HBL5206WO	–
Cast aluminum vertical FS/FD box mount.	–	HBL7420
Gray thermoplastic, vertical standard box mount, corrosion resistant.	HBL5222	–
Same as above except yellow.	HBL52CM22	–
Gray thermoplastic, vertical FS/FD box mount, corrosion resistant.	HBL5221	HBL7423WO
Yellow thermoplastic, vertical FS/FD box mount, corrosion resistant.	HBL52CM21	HBL74CM23WO
White thermoplastic, vertical FS/FD box mount, corrosion resistant.	HBL52CM21W	–

IP44
SUITABILITY

Weatherproof Covers for 15A Nylon Flanged Receptacles and Inlets

Description	Duplex Receptacles	Single Receptacles with Face Dia. 1.40" (35.6)
Gray thermoplastic, corrosion resistant.	–	WP1

*Note: All weatherproof covers listed above are UL Listed for wet and damp locations with cover closed.
Those with suffix WO are UL Listed with cover open.
See page O-21 for additional information on weatherproof covers.*

Twist-Lock® Devices

Accessories for 15 Amp 2 and 3 Wire Devices

- Tinted lid is aesthetically pleasing in any location. High-impact, polycarbonate while-in-use cover will not rust or corrode; cover is NEMA 3R rated
- Compact 2-gang design



HBLPKL520

- Locking receptacle prevents unintentional disconnection of mating pump plug

Pool Kit Contains:

- Heavy duty, industrial grade locking receptacle NEMA L5-20, 20A 125V
- Single-pole switch (20A, 120-277V AC)
- Two gang, 2 inch deep die-cast aluminum weatherproof box with (4) 3/4 inch threaded outlets
- Two gang, weatherproof while-in-use cover
- Includes mounting hardware, gasket, wire connector and (3) closure plugs
- Complete assembly instructions

Pool Pump Kit

Description	Catalog Number
Pool pump receptacle kit.	HBLPKL520



HBL6023



HBL6024



HBL7529A

IP55*
SUITABILITY

Weatherproof, Seal-Tite®, Triple Seal Boots for 15A Insulgrip® Devices

Description	For 3 Wire Devices	For 3 Wire EdgeConnect™ Devices
"Black elastomer boot for plugs when used in a cord set and connector bodies when used with a flange inlet"	HBL6023	HBL6023ST
Same as above except yellow elastomer.	HBL60CM23	HBL60CM23ST
Black elastomer boot for connector bodies when used in cord sets.	HBL6024	HBL6024ST
Same as above except yellow elastomer.	HBL60CM24	HBL60CM24ST

Note: *When installed and used properly with plug and connector body combinations.

PLUGOUT® Lockout Devices

Description	Catalog Number
Lockout device for 15A and 20A straight blade plugs.	HLDMP
Lockout device for attachable 20 and 30A plugs, straight body or angle types, with or without weatherproof covers.	HLD

Note: See section BB for additional information on PLUGOUT Lockout devices.

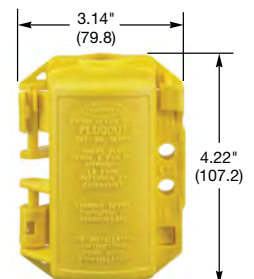

HLDMP

Dimensions in Inches (mm)

Accessories for 20 and 30 Amp 3, 4 and 5 Wire Devices



P720BK



SS720

Wallplates, 1-Gang

Description	Color	Single Receptacles with Face Dia. 1.60" (40.6)
Nylon, smooth.	Black	P720BK
Stainless steel 302/304, .035 in. (0.9), horizontal brushed finish.		SS720
Brass .04 in. (1.0), horizontal brushed finish.		SB720

IP44
SUITABILITY

Weatherproof Covers

Description	Single Receptacles with Face Dia. 1.60" (40.6)
Cast aluminum, for FS/FD box mounting.	HBL7420
Gray thermoplastic, for FS/FD box mounting, corrosion resistant.	HBL7425WOA
Same as above except yellow.	HBL74CM25WOA

IP44
SUITABILITY

Weatherproof Covers for Flanged Inlets and Flanged Receptacles

Description	Single Receptacles with Face Dia. 1.60" (40.6)
Gray thermoplastic, corrosion resistant.	WP2

Note: Weatherproof covers are UL Listed for wet and damp location with cover closed. Those with suffix WOA are UL Listed with cover open. See page O-21 for additional information on weatherproof covers.



HBL7425WOA



HBL2899

Closure Cover for 3 Wire Flanged Inlets

Description	Catalog Number
Rubber closure plug.	HBL2899

Note: Closure cover not UL Listed, CSA Certified.



Twist-Lock® Circuit Testers

Description	Rating	20 Amp		30 Amp	
		Configuration	Catalog Number	Configuration	Catalog Number
3-Phase Circuit Tester	3Ø 120/208V AC Min. Volt.: 90V AC	NEMA L21-20P 	HBL3PT2511	NEMA L21-30P 	HBL3PT2811
Circuit Tester	125V	NEMA L5-20P 	HBLT2311	NEMA L5-30P 	HBLT2611 HBLT26CM11 (Marine)
	250V	NEMA L6-20P 	HBLT2321	NEMA L6-30P 	HBLT2621
Circuit Tester	277V	NEMA L7-20P 	HBLT2331		
	125/250V	NEMA L14-20P 	HBLT2411	NEMA L14-30P 	HBLT2711
Circuit Tester	347V	NEMA L24-20P 	HBLT3721		
	128/208V AC	Non-NEMA	HBLT3521		

Note: Testers in other NEMA configurations can be developed upon request.



HBL3PT2511



HBLT26CM11



HBLSTRB

Single Flush Receptacles

Description	Catalog Number
Removal Bridge, for use with all Twist-Lock Edge Series receptacles	HBLSTRB

Dimensions in Inches (mm)

Twist-Lock® Devices

Accessories for 20 and 30 Amp 3, 4 and 5 Wire Devices

Insulgrip® Plug and Connector Body Latching Kit

The Hubbell latching kit provides both improved safety and security through a double locking feature that makes unintentional disconnection virtually impossible – even under high vibration situations. The plug and connector body lock once when first connected, then again when you push the special position locking slide into place.



SK2

Insulgrip® Latching Kit

Description	For 3 Wire Devices	For 4 & 5 Wire Devices
For all 20A and 30A Twist-Lock Insulgrip plugs and connectors.	SK2	SK3

Valise®

IP55*
SUITABILITY

Weatherproof, Seal-Tite®, Triple Seal Boots

Description	For 3 Wire Devices	For 4 & 5 Wire Devices
Yellow Seal-Tite® elastomer triple seal cover for use with Valise plugs when used in cord set and Valise connector bodies when used with flanged inlet.	HBL60CM31V	–
Yellow Seal-Tite® elastomer triple seal cover for use with Valise connector bodies.	HBL60CM32V	–



HBL60CM31V

Note: *When installed and used properly with plug and connector body combinations.

Insulgrip®

IP55*
SUITABILITY

Weatherproof, Seal-Tite®, Triple Seal Boots

Description	For 3 Wire Devices	For 3 Wire EdgeConnect™ Devices	For 4 & 5 Wire Devices	For 4 & 5 Wire EdgeConnect™ Devices
"Black elastomer boot for plugs when used in a cord set and connector bodies when used in flanged inlets."	HBL6031	HBL6031ST	HBL6035	HBL6035ST
Same as above except yellow.	HBL60CM31	HBL60CM31ST	HBL60CM35	HBL60CM35ST
Black elastomer boot for connector bodies when used in a cord set.	HBL6032	HBL6032ST	HBL6036	HBL6036ST
Same as above except yellow	HBL60CM32	HBL60CM32ST	HBL60CM36	HBL60CM36ST



HBL6032

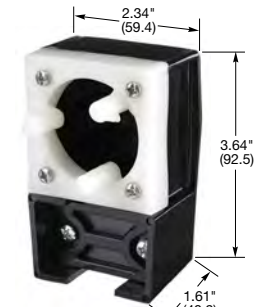

HBL3WAA

Angle Adapter

Description	For 3 Wire Devices	For 4 & 5 Wire Devices
Nylon, angle adapter for Insulgrip plugs and connector bodies, cord grip range .325"-.930" (8.3-24).	HBL3WAA	HBL45WAA

PLUGOUT® Lockout Devices

Description	For 3 Wire Devices	For 4 & 5 Wire Devices
Lockout device for attachable 20 and 30A locking plugs, straight body or angle types, with or without weatherproof covers.	HLD	HLD
Lockout device for 20 and 30A 3 wire angle plugs and watertight Safety-Shroud® Twist-Lock® plugs.	HLD2	HLD2

Note: See section BB for additional information on PLUGOUT Lockout devices.
*When installed and used properly with plug and connector body combinations.

For quick visual identification of circuits or configurations.

Colored Cord Clamps*

Description	Color	For 3 Wire Devices	For 4 & 5 Wire Devices
For use with 20A and 30A Insulgrip® Twist-Lock® Plugs and Connectors. Cord diameter: 3 wire .350"-.930" (9-24), 4 & 5 wire .350" – 1.150" (9-29)	Black	HBLTL2CCBK	HBLTL3CCBK
	Blue	HBLTL2CCBL	HBLTL3CCBL
	Brown	HBLTL2CCBR	HBLTL3CCBR
	Dark Blue	HBLTL2CCDB	HBLTL3CCDB
	Green	HBLTL2CCGR	HBLTL3CCGR
	Orange	HBLTL2CCOR	HBLTL3CCOR
	Red	HBLTL2CCRD	HBLTL3CCRD
	Teal	HBLTL2CCTL	HBLTL3CCTL
	White	HBLTL2CCWH	HBLTL3CCWH
	Yellow	HBLTL2CCYL	HBLTL3CCYL

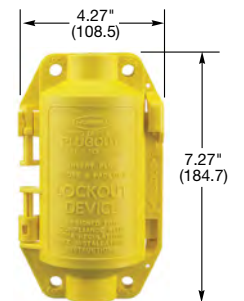

HLD



Note: *Clamp only. Contains no screws. Order in increments of 10. Not UL Listed or CSA Certified.

Dimensions in Inches (mm)

Twist-Lock® Devices

Safety-Shroud® Twist-Lock® Accessories

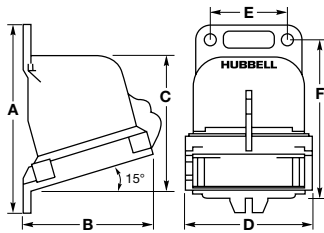

Non-Metallic Angle Box

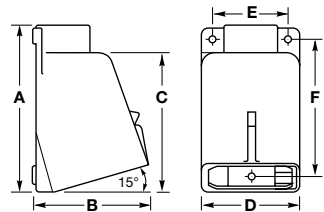

Metallic Angle Box

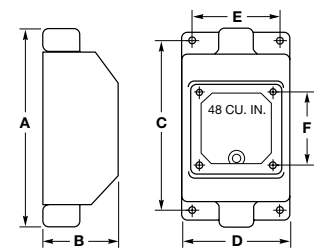

Metallic Feed Thru Box

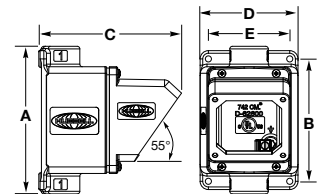

AB203055

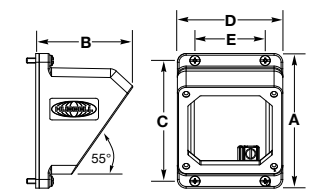

AA203055



HBL2030AP



AA2030PS

Dimensions in Inches (mm)

15° Angle Non-Metallic Back Box

Description	NPT Hub Size	A Inch (mm)	B Inch (mm)	C Inch (mm)	D Inch (mm)	E Inch (mm)	F Inch (mm)	Cubic Inch Capacity	Catalog Number
For 20A and 30A Watertight Safety-Shroud Twist-Lock Receptacles and Inlets.	1"	5.67" (144.0)	4.44" (112.8)	4.05" (102.9)	3.91" (99.3)	2.35" (59.7)	4.92" (125.0)	30.00"	BB2030N

Note: Hub is not included; order Racor part number 1704. This box meets IP69k requirement and Type 4X requirements when installed with a watertight conduit hub.

15° Angle Metallic Back Boxes

Description	NPT Hub Size	A Inch (mm)	B Inch (mm)	C Inch (mm)	D Inch (mm)	E Inch (mm)	F Inch (mm)	Cubic Inch Capacity	Catalog Number
For 20A and 30A Watertight Safety-Shroud Twist-Lock Receptacles and Inlets.	¾"	5.13" (130.2)	4.00" (101.6)	4.19" (106.4)	3.75" (95.3)	3.00" (76.2)	4.00" (101.6)	30.00"	BB201W
	1"	5.13" (130.2)	4.00" (101.6)	4.19" (106.4)	3.75" (95.3)	3.00" (76.2)	4.00" (101.6)	30.00"	BB301W

Metallic Feed Thru Back Boxes

Description	NPT Hub Size	A Inch (mm)	B Inch (mm)	C Inch (mm)	D Inch (mm)	E Inch (mm)	F Inch (mm)	Cubic Inch Capacity	Catalog Number
For 20A and 30A Watertight Safety-Shroud Twist-Lock Receptacles and Inlets.	¾"	8.25" (209.6)	3.06" (77.8)	7.14" (181.4)	4.50" (114.3)	3.75" (95.3)	3.13" (79.5)	48.00"	FT202W
	1"	8.25" (209.6)	3.06" (77.8)	7.14" (181.4)	4.50" (114.3)	3.75" (95.3)	3.13" (79.5)	48.00"	FT302W

Note: These boxes are cast aluminum and are finished with enamel paint. These boxes withstand a 500-hour salt spray test as well as UL raintight and external icing tests. NPT (metric designator).

55° Angle Metallic Adapter and Back Box

Description	NPT Hub Size	A Inch (mm)	B Inch (mm)	C Inch (mm)	D Inch (mm)	E Inch (mm)	F Inch (mm)	Cubic Inch Capacity	Catalog Number
For 20A and 30A Watertight Safety-Shroud Twist-Lock Receptacles and Inlets.	1"	6.80" (172.4)	5.63" (142.9)	6.60" (167.0)	4.50" (114.3)	3.74" (95.0)	-	45.27"	AB203055

55° Angle Metallic Adapter with Grounding Lug

Description	A Inch (mm)	B Inch (mm)	C Inch (mm)	D Inch (mm)	E Inch (mm)	F Inch (mm)	Cubic Inch Capacity	Catalog Number
For 20A and 30A Watertight Safety-Shroud Twist-Lock Receptacles and Inlets.	4.89" (124.2)	3.33" (84.8)	4.29" (109.1)	3.75" (95.3)	2.50" (63.5)	-	25.00"	AA203055

Straight Watertight Wall Box Adapter

Description	Catalog Number
Adapts 20A and 30A Watertight Safety-Shroud Twist-Lock receptacles and inlets to 2-gang, device mount, FD boxes.	HBL2030AP

Non-Watertight Angle Wall Box Adapter

Description	Catalog Number
Adapts 20A and 30A Watertight Safety-Shroud Twist-Lock receptacles to 1- or 2-gang standard wall boxes (4" or 4 1/16" square).	AA2030PS

Twist-Lock® Devices

Features and Benefits

50 Amp Plugs and Connector Bodies

Hubbell's 50 amp Twist-Lock® devices feature a heavy duty design built for heavy duty applications. These Hubbell 50 amp Twist-Lock plugs and connector bodies are built to go where you need power, even in some of the harshest environments.

On the outside, 50 amp plugs and connectors are made of super tough nylon for better impact resistance. On the plug, the stainless steel shroud not only provides protection and durability, but safety as well. That's because the rigid construction restricts distortion, thus minimizing the possibility of mating incorrect devices.

On the inside are the kinds of features that separate Hubbell from all the rest. The cord grip has been designed with offset gripping jaws to securely hold the conductors – not just the cord jacket. Hubbell's box terminals speed wiring and provide a superior termination. The plug's thermoplastic polyester interior provides excellent heat resistance without compromising strength.

In all, it's the combination of function and performance that Hubbell demands of all its products. That is why we will never add a feature that compromises performance.



Housing Design

- Housing assembly latch slotted to fit standard flat-blade screwdriver providing secure assembly and fast disassembly for wiring
- Super tough nylon housing offers better impact qualities

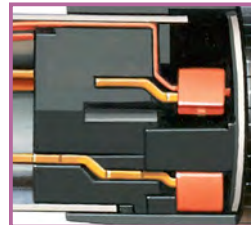

Internal Design

- Thermoplastic polyester interior provides heat resistance and impact strength
- 6/6 nylon nose – thermoplastic polyester terminal cover provides heat resistance in terminal area and impact strength of nose piece



Safety

- Stainless steel shroud restricts mismatching with the wrong device
- Padlock capable shroud allows compliance to OSHA lockout/tagout regulation 29 CFR 1910.147

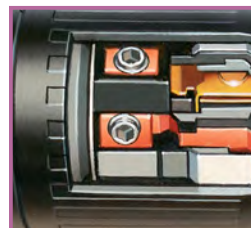

Terminals

- Box terminal with hex socket threaded slug is superior because it permits high clamping pressure on conductors without damaging strands



Installation

- Three-piece thermoplastic cord clamp assembly with stainless steel fast lead screws provides a more consistent, durable grip. Sealed cable entry keeps out moisture and dust

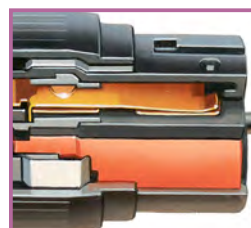

Contacts

- One-piece grounding contact on 4-wire devices provides a more reliable grounding system for a safer device

50 Amp, 125, 250 Volts and 480 Volts AC



CS8265C

IP20
SUITABILITY



50A 125V
UL/CSA



50A 250V
UL/CSA



50A 480V AC
UL/CSA

Plugs

Description	Cord Dia.	Catalog Number		
Nylon housing, thermoplastic polyester interior.	.830"-1.250" (21.08-31.75)	CS6361C	CS8265C	CS8465C

Note: See page B-60 for accessories.

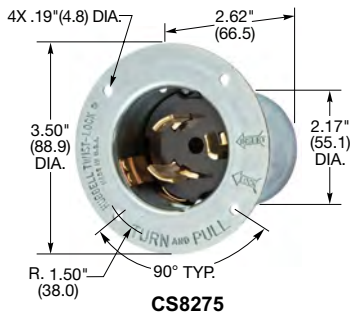

CS8275

Flanged Inlets

Description	Catalog Number		
Zinc plated steel casing, thermoset interior.	CS6377	CS8275	CS8475†

Note: †Not CSA Certified.



CS8264C

IP20
SUITABILITY



50A 125V
UL/CSA



50A 250V
UL/CSA



50A 480V AC
UL/CSA

Connector Bodies

Description	Cord Dia.	Catalog Number		
Nylon housing, thermoplastic polyester interior.	.830"-1.250" (21.08-31.75)	CS6360C	CS8264C	CS8464C

Note: See page B-60 for accessories.

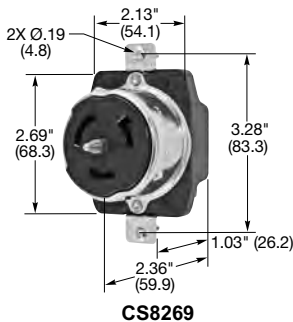

CS8269

Receptacles

Description	Catalog Number		
Black phenolic.	CS6370	CS8269	CS8469†

Note: See page B-60 for accessories.
†Not CSA Certified.

Dimensions in Inches (mm)

50 Amp, 125/250, 3Ø 250 Volts and 3Ø 480 Volts AC

Plugs

IP20
SUITABILITY



50A
125/250V AC
UL/CSA



50A
3Ø 250V AC
UL/CSA



50A
3Ø 480V AC
UL/CSA

Description	Cord Dia.	Catalog Number		
Nylon cover, thermoplastic polyester interior.	.830"-1.250" (21.08-31.75)	CS6365C	CS8365C	CS8165C

Note: See page B-60 for accessories.



CS6365C

Flanged Inlets

Description	Catalog Number		
Zinc plated steel casing, thermoset interior.	CS6375	CS8375	CS8175
Zinc plated steel casing, thermoset interior with lift cover.	CS6375M2	-	-
Gray Valox® housing and flange.	HBL6375S*	-	-

Note: *Type 3R, (Not shown).

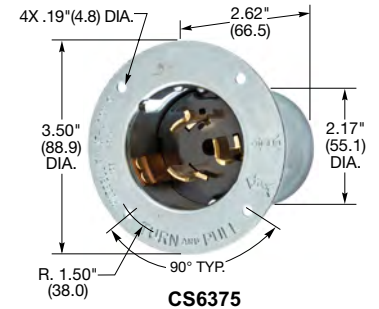

CS6375

Connector Bodies

IP20
SUITABILITY



50A
125/250V AC
UL/CSA



50A
3Ø 250V AC
UL/CSA



50A
3Ø 480V AC
UL/CSA

Description	Cord Dia.	Catalog Number		
Nylon cover, thermoplastic polyester interior.	.830"-1.250" (21.08-31.75)	CS6364C	CS8364C	CS8164C
Insulgrip® Connector with conduit adapter. Capable of accepting metallic or non-metallic conduit fittings.	½" NPT Size	-	CS8364CA05	-
	¾" NPT Size	-	CS8364CA34	-
	1" NPT Size	-	CS8364CA10	-

Note: See page B-60 for accessories.

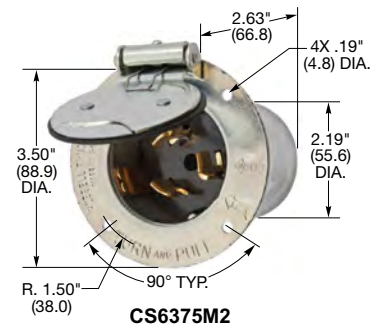

CS6375M2

Receptacles

Description	Catalog Number		
Black phenolic.	CS6369	CS8369	CS8169

Note: See page B-60 for accessories.



CS6364C



CS8364CA05



CS8364CA05
(Rear View)

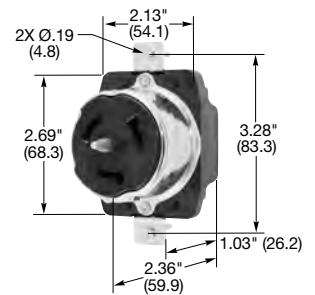

CS6369

Valox® is a trademark of SABIC Innovative Plastics, acquired from General Electric Company.

Dimensions in Inches (mm)

50 Amp, 250 Volts DC and 600 Volts AC



HBL3763C

IP20
SUITABILITY



Plugs

Description	Cord Dia.	Catalog Number
Nylon housing, thermoplastic polyester interior.	.830"-1.250" (21.08-31.75)	HBL3763C

Note: See page B-60 for accessories.



HBL3777

Flanged Inlets

Description	Catalog Number
Zinc plated steel casing, thermoset interior.	HBL3777
Zinc plated steel casing, thermoset interior with lift cover.	HBL3767

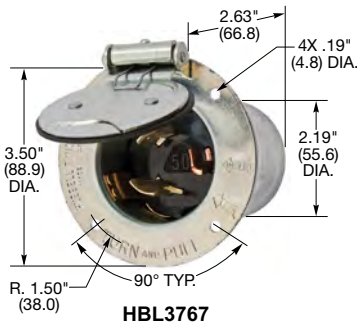

HBL3767

IP20
SUITABILITY



Connector Bodies

Description	Cord Dia.	Catalog Number
Nylon housing, thermoplastic polyester interior.	.830"-1.250" (21.08-31.75)	HBL3762C

Note: See page B-60 for accessories.

Receptacles

Description	Catalog Number
Black phenolic.	HBL3771

Note: See page B-60 for accessories.



HBL3762C

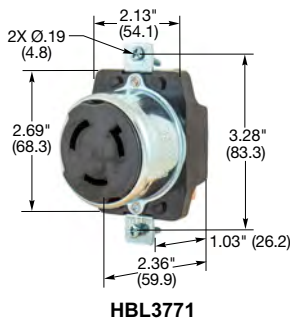

HBL3771

Dimensions in Inches (mm)

50 Amp, 250 Volts DC and 600 Volts AC

Plugs

Description	Cord Dia.	Catalog Number	
Nylon cover, thermoplastic polyester interior.	.830"-1.250" (21.08-31.75)	HBL3765C	HBL7765C

Note: See page B-60 for accessories.

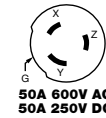

HBL3765C

Flanged Inlets

Description	Catalog Number
Zinc plated steel casing, thermoset interior.	HBL3775 HBL7958
Zinc plated steel casing, thermoset interior with lift cover.	HBL3768 HBL7968

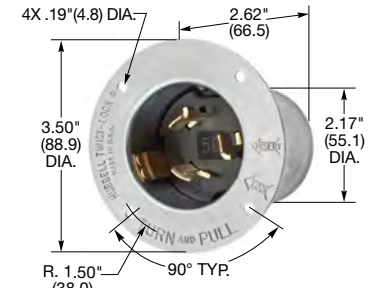

HBL3775

Connector Bodies

Description	Cord Dia.	Catalog Number	
Nylon cover, thermoplastic polyester interior.	.830"-1.250" (21.08-31.75)	HBL3764C	HBL7764C

Note: See page B-60 for accessories.

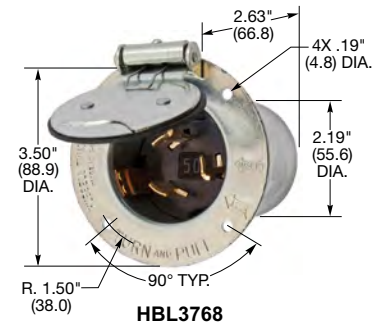

HBL3768

Receptacles

Description	Catalog Number
Black phenolic.	HBL3769 HBL7379

Note: See page B-60 for accessories.



HBL3764C

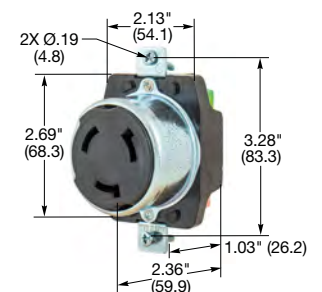

HBL3769

Important Note: Catalog numbers **HBL7765C**, **HBL7958**, **HBL7968**, **HBL7764C**, **HBL7379** are for replacement use only. See other singly rated 50A Twist-Lock® devices in this section. **HBL3700 series Twist-Lock devices do not interchange with any other devices in this section.**

Dimensions in Inches (mm)

IP44
SUITABILITY

Weatherproof Receptacle Lift Cover Plates for FS/FD Box Mounting

Description	Catalog Number
Corrosion resistant, gray thermoplastic.	HBL7774WO
Same as above except yellow.	HBL77CM74WO
Cast aluminum.	HBL7770

Note: See page O-21 for additional information on weatherproof covers.



HBL7770

Receptacle Plates for FS/FD Box Mounting

Description	Catalog Number
Cast aluminum with lift cover.	HBL7382**
Same as above less lift cover.	HBL7383*
Stainless steel, single gang, wallplate.	SS750[^]



SS750

Receptacle 1/2" Raised Cover

Description	Catalog Number
Galvanized Steel fits 4" square or 2-gang box.	HBL50SC[^]



HBL50SC

Conduit Adapters for 50A Twist-Lock® Plugs and Connectors

Description	NPT Thread Size	Catalog Number
Thermoplastic housing, conduit adapters for use with CS style 50A Twist-Lock® devices. Available in 1/2", 3/4" and 1" NPT thread sizes.	1/2"	CS50CA05
	3/4"	CS50CA34
	1"	CS50CA10

IP55**
SUITABILITY

Weatherproof Boots

Description	Catalog Number
Seal-Tite® triple seal black elastomeric cover for plugs when used in a cord set and connector bodies when used with flanged inlets.	HBL7716C[†]
Seal-Tite triple seal black elastomeric cover for connector bodies when used with cord sets.	HBL7717C[†]



CS50CA34

Inlet Closure Plug

Description	Catalog Number
Black closure plug.	HBL4892[†]

Replacement Parts

Description	Catalog Number
Cord clamp Kit.	HBLCSCK

Note: •Will only fit non-"CS" type 50A Twist-Lock receptacles.

*Not UL Listed "WDL Closed".

**When installed and used properly with plug and connector body combinations.

[^]IP20 SUITABILITY.

[†]Not UL Listed.



HBL7716C



HBL7717C



HBL4892



HBLCSCK

Twist-Lock® Devices

Features and Benefits

Hubbellock® Plugs and Connector Bodies

The Hubbellock devices feature an exclusive design unlike any other in the industry. The unique design is built to provide the safest heavy duty device even in some of the harshest environments. These Hubbellock plugs and connector bodies are built with a super tough nylon housing for high impact resistance and a one of kind interior design for superior safety that Hubbell is known for.

The male contacts are molded into the nose for damage resistance and completely eliminate the chance of deformity. Additionally, the plug as well as the connector retains power mechanical cord grips that not only secure the cable but also clamp down on the conductors in order to provide unrivaled strain relief.

Inside the connector is Hubbell's unique safety design. With unparallelled box terminations the connector interior holds a spring-loaded safety shutter to provide the ultimate arc protection. Furthermore the exceptional heat and impact resistance is maintained by the thermoplastic interior contributing to a longer lasting device.

In all, the one of a kind function of the Hubbellock devices provide a safe and dependable performance in the most demanding applications.



Note: The cut-away views below are construction elements pertaining specifically to the 30A Hubbellock series. While the Hubbellock contact interface design applies to all, there are construction elements that are different, depending on the amperage.



Housing Design

- Insulated non-metallic housing enhances safety and abuse resistance
- Impact resistance in the interior of the female device comes from a strong thermoplastic material

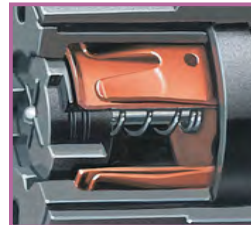

Internal Design

- No "lazy" connections because a spring-loaded safety shutter automatically ejects the plug if it hasn't been properly locked into the female device. This eliminates teasing of the contacts, a major cause of contact burn-up
- Arcs are snuffed out, when devices are mated or unmated under load, by spring-loaded safety shutter



Safety

- Enhanced safety because access to live female contacts is restricted by the spring-loaded safety shutter

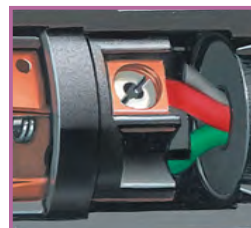

Terminals

- Superior wire terminations are assured with box terminals and screws with pressure pads. This design captures stray wire strands and permits more clamping pressure on the wire without damaging it. Loosening of terminations and resulting heat build-up are greatly reduced

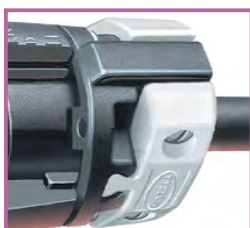

Installation

- Three-piece thermoplastic clamp assembly with fast-lead stainless screws provides a more consistent durable grip. Grommets provide a sealed cable entry that protects against the entry of moisture and dust

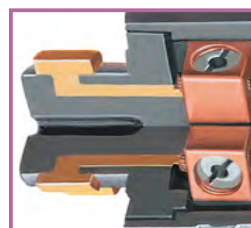

Contacts

- Positive locking is ensured by the nose of the plug being keyed into a detent in female device. This lock is independent of the contacts or a separate mechanical lock
- Longer contact life is assured by supplementary springs. Other devices rely just on contacts themselves to provide proper contact pressure

20 Amp, 125 Volts

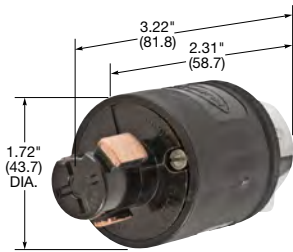

HBL23035B

IP30
SUITABILITY



20A 125V

Plug

Description	Cord Dia.	Catalog Number
Nylon housing, thermoset interior.	.320"-.660" (8.12-16.5)	HBL23035B



HBL23032B

Connector Body

Description	Cord Dia.	Catalog Number
Nylon housing, thermoset interior.	.320"-.660" (8.12-16.5)	HBL23032B

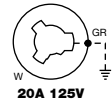

20A 125V

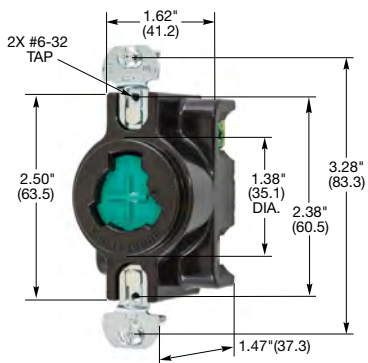

HBL23030

Receptacle

Description	Catalog Number
Black phenolic, back wired.	HBL23030

Note: Devices listed above are not interchangeable with any other Hubbell device listed in this catalog.



20A 125V



HBL7423WO

Accessories

Weatherproof Covers

Description	Catalog Number
Gray polycarbonate for FS/FD box mounting, corrosion resistant. IP44 SUITABILITY.	HBL7423WO
Same as above except yellow.	HBL74CM23WO
Cast aluminum, lift cover for indoor use only.	HBL23007
Stainless steel 302/304, single receptacle wallplate.	SS7
Stainless steel 430, single receptacle wallplate.	SS7L



HBL23007

Dimensions in Inches (mm)

Twist-Lock® Devices

20 Amp, 125 Volts AC or DC, 10 Amp, 250 Volts DC, 480 Volts AC

Plug

Description	Cord Dia.	Catalog Number
Nylon housing, thermoset interior.	.320"-.660" (8.12-16.5)	HBL23005GB

IP30
SUITABILITY

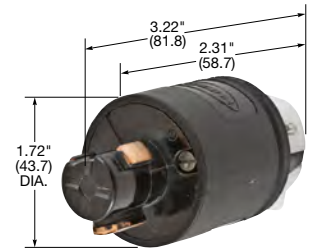

HBL23005GB

Connector Body

Description	Cord Dia.	Catalog Number
Nylon housing, thermoset interior.	.320"-.660" (8.12-16.5)	HBL23002GB

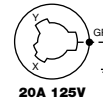

HBL23002GB

Receptacle

Description	Catalog Number
Black phenolic, back wired.	HBL23000G

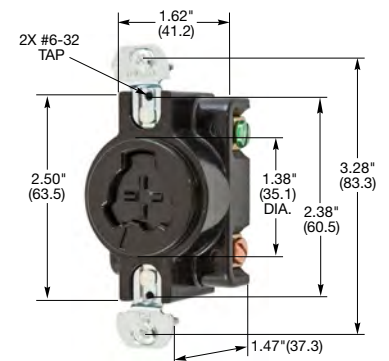
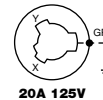

HBL23000G

Accessories

Weatherproof Covers

Description	Catalog Number
Gray polycarbonate for FS/FD box mounting, corrosion resistant. IP44 SUITABILITY.	HBL7423WO
Same as above except yellow.	HBL74CM23WO
Cast aluminum, lift cover for indoor use only.	HBL23007
Stainless steel 302/304, single receptacle wallplate.	SS7
Stainless steel 430, single receptacle wallplate.	SS7L



HBL7423WO



HBL23007

Dimensions in Inches (mm)

30 Amp, 600 and 480 Volts AC, 20 Amp, 250 Volts DC



HBL21415B



HBL20445B



HBL25415B

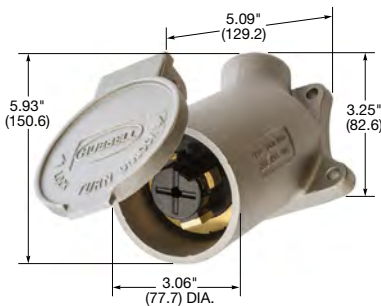

HBL21447

IP30
SUITABILITY

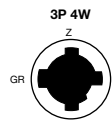

30A 600V AC
20A 250V DC

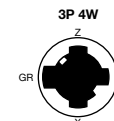

30A 480V AC

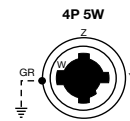

30A 600V AC
20A 250V DC

Plugs

Description	Cord Dia.	Catalog Number		
Black nylon housing, thermoplastic interior.	.700"-1.200" (17.78-30.5)	HBL21415B	-	-
Same as above except corrosion resistant.	.700"-1.200" (17.78-30.5)	HBL21CM415B	-	-
Red nylon housing, thermoset interior.	.700"-1.200" (17.78-30.5)	-	HBL20445B†	-
Black nylon housing, thermoset interior, steel shroud.	.700"-1.200" (17.78-30.5)	-	-	HBL25415B

Note: See page B-68 for accessories.

†Not CSA Certified.

Flanged Inlets

Description	Catalog Number		
Weathertight, corrosion resistant, nickel plated brass plate, for FS/FD box mounting.	HBL22CM428	-	-
Black phenolic interior, aluminum housing, for FS/FD box mounting (not shown).	HBL20418	-	-
Aluminum angle housing, with ¼" NPT hub for surface mounting.	HBL21447	-	-



SEHBL3 - Switched enclosure for use with 3 pole 4 wire 30A Hubbell receptacle. Receptacle not included. See page B-41 for additional information.

Dimensions in Inches (mm)

30 Amp, 600 and 480 Volts AC, 20 Amp, 250 Volts DC

IP30
SUITABILITY

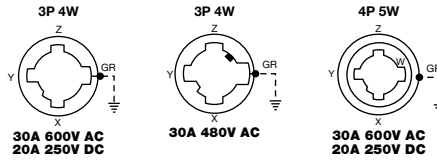

Connector Bodies

Description	Cord Dia.	Catalog Number		
Black nylon housing, thermoplastic interior.	.700"-1.200" (17.78-30.5)	HBL21414B	-	-
Same as above except corrosion resistant.	.700"-1.200" (17.78-30.5)	HBL21CM414B	-	-
Red nylon housing, thermoset interior.	.700"-1.200" (17.78-30.5)	-	HBL20444B	-
Black nylon housing, thermoplastic interior.	.700"-1.200" (17.78-30.5)	-	-	HBL25414B

Note: See page B-68 for accessories.



Receptacles

Description	Catalog Number		
Black phenolic.	HBL20403		
Weathertight, corrosion resistant, nickel plated brass plate, for FS/FD box mounting. IP44 SUITABILITY.	HBL22CM427	-	-
Aluminum angle housing, with 3/4" NPT hub for surface mounting. IP44 SUITABILITY.	HBL21420		
Black phenolic, red center insert.	-	HBL20443	-
Black phenolic interior, aluminum housing, blue finish, for FS/FD box mounting.	-	-	HBL25403
Black phenolic interior, aluminum weatherproof housing, blue finish for FS/FD box mounting. IP44 SUITABILITY.	-	-	HBL25250

Note: See page B-68 for accessories.

Receptacle Accessories

Description	Catalog Number
Thermoplastic, wet and damp locations with cover "open", gray.	HBL7428WOG*
Thermoplastic, wet and damp locations with cover "open", yellow.	HBL7428WOY*
Thermoplastic, wet and damp locations with cover "open", red.	HBL7428WOR*
Cast aluminum, wet locations only when cover "closed" and damp locations, lift cover plate.	HBL20405
Cast aluminum, wet locations only when cover "closed" and damp locations, red finish.	HBL20446
302/304 stainless, single gang, smooth. NOT weatherproof.	SS737

Note: *Features two #6-32 threaded inserts to back mount device to cover.

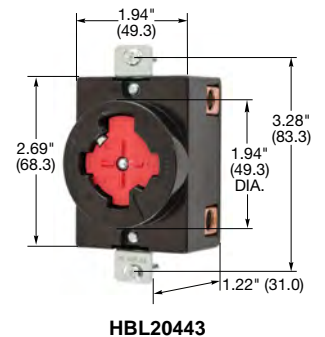
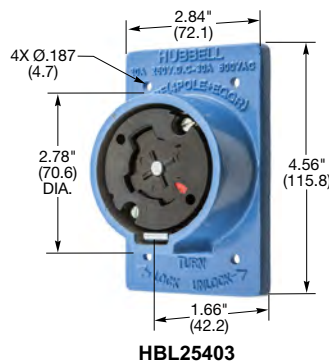
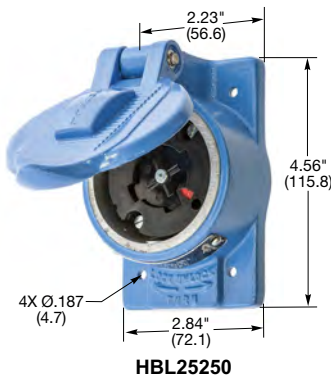

Dimensions in Inches (mm)

60 Amp, 600 Volts AC

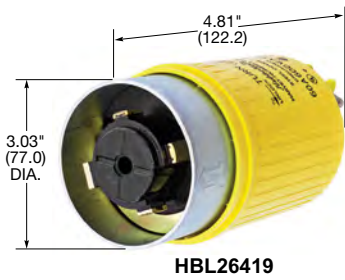

HBL26419

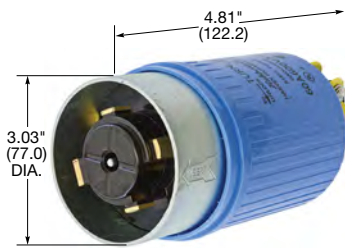

HBL26519

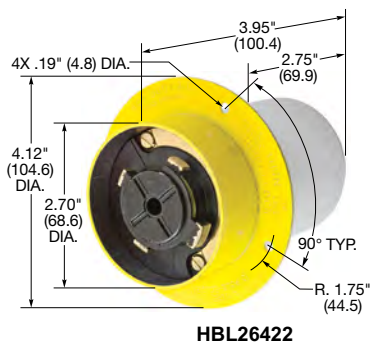

HBL26422

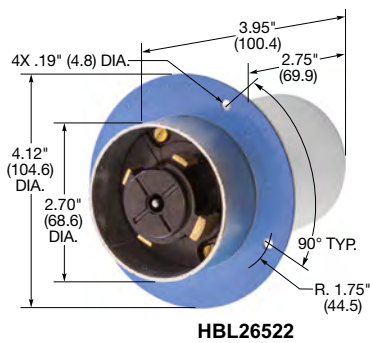

HBL26522

IP30
SUITABILITY

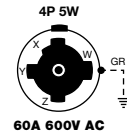
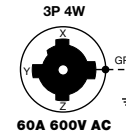

Plugs

Description	Cord Dia.	Catalog Number	
Black phenolic interior with yellow thermoplastic sleeve over steel housing.	.920"-1.450" (23.36-36.83)	HBL26419	—
Black phenolic interior with blue thermoplastic sleeve and steel housing.	1.00"-1.50" (25.40-38.10)	—	HBL26519

IP30
SUITABILITY

Flanged Inlets

Description	Catalog Number	
Black phenolic interior with steel housing and flange.	HBL26422	—
Black phenolic interior with steel housing and flange with blue finish.	—	HBL26522

Dimensions in Inches (mm)

60 Amp, 600 Volts AC

IP30
SUITABILITY

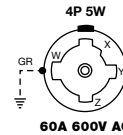
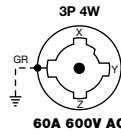

Connector Bodies

Description	Cord Dia.	Catalog Number	
Black phenolic interior with yellow thermoplastic sleeve over steel cover.	.920"-1.450" (23.36-36.83)	HBL26418	—
Black phenolic interior with blue thermoplastic sleeve over steel cover.	1.00"-1.50" (25.40-38.10)	—	HBL26516

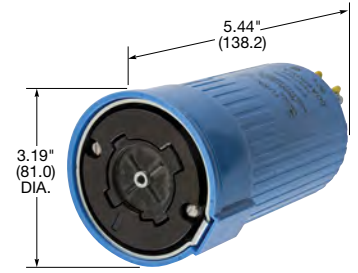
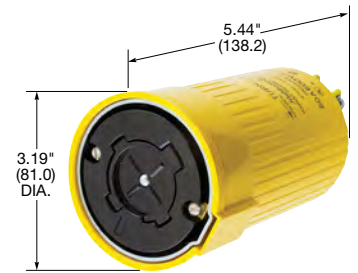

IP44
SUITABILITY

Receptacles

Description	Catalog Number	
Black phenolic interior with short aluminum housing and lift cover.	HBL26410	—
Black phenolic interior with long aluminum housing and lift cover.	HBL26420	—
Black phenolic interior with long aluminum housing with lift cover and blue finish.	—	HBL26520

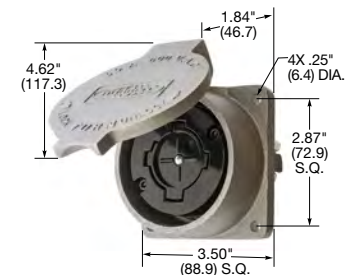

IP30
SUITABILITY

Flanged Receptacles

Description	Catalog Number	
Black phenolic interior with steel housing and flange.	HBL26421	—
Black phenolic interior with steel housing and flange with blue finish.	—	HBL26521

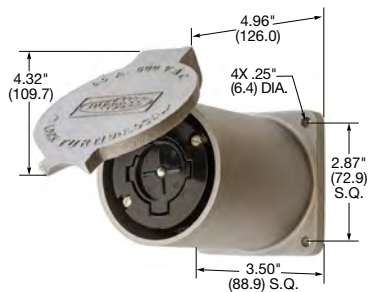

Receptacle Box and Adapter Plates (Box requires one adapter)

Description	Catalog Number
Box, cast aluminum, only for 60A Hubbellock receptacles.	HBL26401
Straight adapter plate.	HBL26402
45° adapter plate.	HBL26404

Note: Straight or angle adapter plate must be used when mounting a 60A receptacle to HBL26401 box. Cannot be used with round flanged receptacles and inlets. See page B-68 for additional information.

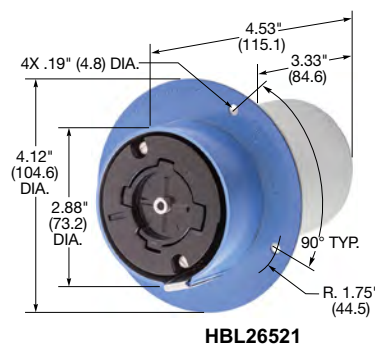
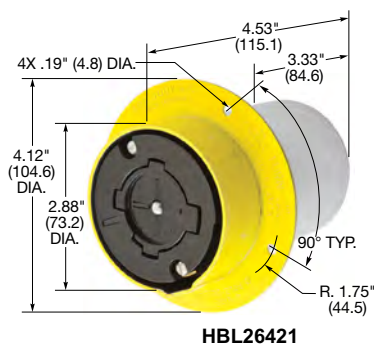

Dimensions in Inches (mm)

Hubbellok® Accessories



HBL20405



SEHBL3



SAB34



HBL20424B



HBL20425B



H660A

30 Amp Hubbellok® Accessories

Receptacle Plates for FS/FD Box Mounting

Description	Catalog Number
Thermoplastic, wet and damp locations with cover "open", gray.	HBL7428WOG*
Thermoplastic, wet and damp locations with cover "open", yellow.	HBL7428WOY*
Thermoplastic, wet and damp locations with cover "open", red.	HBL7428WOR*
Cast aluminum, wet location only when cover "closed" and damp locations, lift cover plate.	HBL20405
Cast aluminum, wet location only when cover "closed" and damp locations, red finish.	HBL20446
302/304 stainless, single gang, smooth. NOT weatherproof.	SS737

Note: *Features two #6-32 threaded inserts to back mount device to cover.

Switched Enclosure

IP54
SUITABILITY

Description	Catalog Number
Switched enclosure for use with 30A 3 pole 4 wire Hubbellok receptacle. Receptacle not included.	SEHBL3

Note: For more information on switched enclosures see page B-38.

Liquidtight Metallic Conduit Adapters

Description	Catalog Number
Adapter for use with 1/2" NPT conduit fittings.	SAB12
Adapter for use with 3/4" NPT conduit fittings.	SAB34

Boots

Description	Catalog Number
"Mini" boot for 4 wire Hubbellok connector body.	HBL20424B†
"Mini" boot for 4 wire Hubbellok plug.	HBL20425B†

Note: †Not UL Listed or CSA Certified.

60 Amp Hubbellok® Accessories

Receptacle Box and Adapter Plates (Box requires one adapter)

Description	Catalog Number
Box, cast aluminum, only for 60A Hubbellok receptacles.	HBL26401
Straight adapter plate.	HBL26402
45° adapter plate.	HBL26404

Note: Straight or angle adapter plate must be used when mounting a 60A receptacle to HBL26401 box. Cannot be used with round flanged receptacles and inlets.

Kellems® Cable Grip

Description	Cord Diameter	Catalog Number
Cable grip.	.830"-1.000" (21.1-25.4)	H660A
Cable grip (not shown).	1.000"-1.140" (25.4-28.9)	H661A
Cable grip (not shown).	1.125"-1.328 (28.6-33.7)	H662A

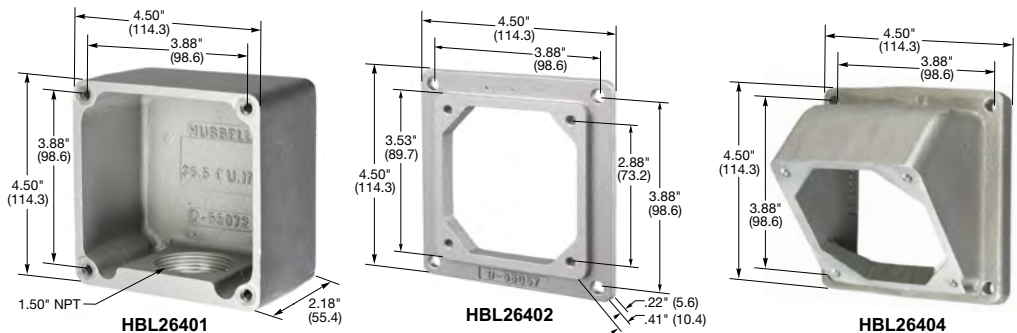

Dimensions in Inches (mm)

Twist-Lock® Devices

Technical Information

15-30 Amp Twist-Lock and Safety-Shroud® Devices

Specifications

Listings

Listed to UL Standard 498 (Attachment Plugs and Receptacles).

Fed. Spec. W-C-596 (Insulgrip® and Safety-Shroud®).

Certified to CSA Standard C22.2 No.42 (General Use Receptacles, Attachment Plugs and Similar Wiring Devices).

Plugs and Connector Bodies (Insulgrip®)

15-30A

Blade/Contact Carrier	Natural (white) nylon
Terminal Retainer	Clear polycarbonate
Cover (Housing)	Black nylon (yellow in "CM" devices)
Cord Clamp	Natural (white) nylon
Dust Shield	EPDM
Blades/Contacts	Brass
Terminal Clamp	Cold rolled steel – nickel plated
Terminal Screws	15A (8-32), 20-30A (10-32) Brass (white finish on neutral screw when used)
Grounding Screw	Brass (green finish)
Cord Clamp Screws	Steel, zinc plated
Body Holding Screws	Steel, zinc plated

Flanged Inlet/Receptacles

15-30A

Flanged Casing	Natural (white) nylon
Blade/Contact Carrier	Natural (white) nylon
Terminal Retainer	Clear polycarbonate
Blades/Contacts	Brass
Drive Screws	Steel, zinc plated
Terminal Clamp	Cold rolled steel, nickel plated
Terminal Screws	15A (8-32), 20-30A (10-32) Brass (white finish on neutral screw when used)
Grounding Screw	Brass (green finish)
Mounting Screws	Nickel plated brass round head screws
Screw Sizes	15A: 6-32, 3/8" long 20A and 30A: 8-32, 7/16" long

Receptacle, Single

15A

20A and 30A

Cover (Top)	Nylon (Black)	Nylon (Black)
Base	RTP (Black)	RTP (Natural)
Contact Springs	.031" Brass	.040" Brass
Clamp	.031" Brass	.040" Brass
Ground Contact	.031" Brass	.040" Brass
Ground Shunt	–	.015" Brass
Bridge (Mounting Strap)	.050" Steel, zinc plated	–
End Plates (Mounting)	–	.050" Brass
Back Plate	–	.040" Brass
Terminal Screws	Brass (8-32)	Brass (10-32) (white finish on neutral screw when used)
Grounding Screw	Brass (Green)	Bronze (Green)
Flat Head Mounting Screws	Steel, zinc plated	Steel, zinc plated
Auto Ground Clip	Stainless steel	Stainless steel (Used only on IG receptacle)

Safety-Shroud® Receptacles Angle, Surface Semi-Flush

20-30A

Housing and Mounting Flange	Gray Valox®
Mounting Plate (Angle Housing Only)	Galvanized steel
Body Contact Carrier	Natural (white) nylon
Terminal Retainer	Clear polycarbonate
Body Holding Screws	Steel, zinc plated
Contact Springs	Brass
Spring Binding Plate	Brass
Terminal Clamp	Steel, nickel plated .080" curved, scalloped
Terminal Screws	10-32 Brass (white finish on neutral screw when used)
Grounding Screw	Brass (green finish)
Mounting Plate Screws	Steel, zinc plated
Wallplate Mounting Screws	Steel, zinc plated

Safety-Shroud® Twist-Lock® Plug

20-30A

Insulgrip Plug with Safety-Shroud installed	
Safety-shroud	White Valox®
Cord Clamp	White nylon

Performance (Twist-Lock® and Safety Shroud Devices)

Electrical	
Dielectric Voltage	Withstands 2,000V minimum.
Max. Working Voltage	600 Volts RMS.
Current Interrupting	Certified for current interrupting at full rated current.
Temperature Rise Fed. Spec.	Max 30°C temperature rise at full rated current after 250 cycles of overload at 200% of rated current at a power factor of 75% (WC 596).

Mechanical (Twist-Lock® and Safety Shroud Devices)

Cord Accommodation (Plugs and connectors only)	Round portable service cords of diameters commensurate with the device rating as defined in UL Standard 62, CSA C22.2 No. 49.
Cord Grip Accommodation (Insulgrip)	15A: .230"-.720" (5.8-18.3); 20A and 30A 3W: .360"-.930" (9-24); 20A and 30A 4W-5W: .350"-1.150" (9-29).
Terminal Identification	Terminals identified in accordance with UL 498 (X, Y, Z, White, Green).
Terminal Accommodation	20A and 30A, #16-#8 AWG. 15A, #18-#10 AWG. Solid or stranded copper wire only.
Product Identification	Ratings are a permanent part of the device housing.

Environmental (Twist-Lock® and Safety Shroud Devices)

Flammability (Enclosure)	HB or better per UL94/CSA 22.2 No. 0.17.
Plugs, Connectors, Flanged Receptacles and Flanged Inlets Receptacles (Box Mount)	V2 or better.
Operating Temperatures	Maximum Continuous 75°C. Minimum -40°C (w/o impact).

Valox® is a trademark of SABIC Innovative Plastics, acquired from General Electric Company.

Technical Information

20 and 30 Amp Watertight Safety-Shroud® Twist-Lock® Devices

Specifications

Listings

Listed to UL Standard 498 (Attachment Plugs and Receptacles).

Certified to CSA Standard No.42 (General Use Receptacles, Attachment Plugs and Similar Wiring Devices).
Fed. Spec. WC-596.

UL Listed, CSA Certified to Type 4, 4X and Type 12.

Part	Materials
Watertight Safety-Shroud® Plug (Insulgrip®)	20 and 30A
Blade Holder	Natural (white) nylon
Terminal Retainer	Clear polycarbonate
Cover (Housing)	Black Valox®
Cord Clamp	White Valox®
Blades	Brass
Terminal Clamp	Steel, nickel plated .080" curved scalloped
Terminal Screws	10-32 brass (white finish on neutral screw when used) multiple drive head
Grounding Screw	Brass (green finish) combination head
Cord Clamp Screws	Stainless steel 302/304, combination head
Body Holding Screws	Stainless steel 302/304, combination head
Closure Cap and Strap	Neoprene EPDM Blend

Watertight Safety-Shroud® Connector (Insulgrip®) 20 and 30A

Body Contact Carrier	Natural (white) nylon
Terminal Retainer	Clear polycarbonate
Contact Spring	Brass
Spring Binding Plate	Brass
Cover (Housing)	Black Valox®
Cord Clamp	White Valox®
Terminal Clamp	Steel, nickel plated .080" curved scalloped
Terminal Screws	10-32 brass (white finish on neutral screws when used) multiple drive head
Grounding Screw	Brass (green finish) combination head
Cord Grip Screws	Stainless steel 302/304, combination head
Body Holding Screws	Stainless steel 302/304, combination head
Closure Cap and Strap	Polypropylene with Neoprene gasket

Watertight Safety-Shroud Receptacle, Single* 20 and 30A

Housing and Flange	Gray Valox
Body Contact Carrier	Natural (white) nylon
Terminal Retainer	Clear polycarbonate
Drive Screws	Steel, zinc plated
Contact Spring	Brass
Spring Binding Plate	Brass
Terminal Clamp	Steel, nickel plated .080" curved, scalloped
Flange Gasket	Closed-cell neoprene foam
Lid Gasket	Closed-cell neoprene foam
Cover Hinge Pin	Stainless steel 302/304
Cover Spring	Stainless steel 302/304
Terminal Screws	10-32 brass (white finish on neutral screw when used) multiple drive head
Grounding Screw	Brass (green finish) combination head
Mounting Screws	Stainless steel 302/304 combination head

Watertight Safety-Shroud® Flanged Inlet 20 and 30A

Housing and Flange	Gray Valox
Blade Holder	Natural (white) nylon
Terminal Retainer	Clear polycarbonate
Blades	Brass
Drive Screws	Steel, zinc plated
Terminal Clamp	Steel, nickel plated .080" curved scalloped
Terminal Screws	10-32 brass (white finish on neutral screw when used) multiple drive head
Grounding Screw	Brass (green finish) combination head
Closure Cap	Neoprene EPDM blend
Mounting Screws	Stainless steel 302/304 combination head

Performance

Electrical	
Dielectric Voltage	Withstands 2,000V minimum.
Max. Working Voltage	600 Volts RMS.
Current Interrupting	Certified for current interrupting at full rated current.
Temperature Rise	Max 30°C temperature rise at full rated current after 250 cycles of overload at 200% of rated current at a power factor of 75% (WC 596).

Mechanical	
Cord Accommodation (Plugs and connectors only)	Round portable service cords of diameters commensurate with the device rating as defined in UL Standard 62, CSA C22.2 No. 49. 20 and 30A, 3W: .32"-.93" (8.1-24.0mm) #16-3 Type SJ-#8-3 Type S, SO; 20 and 30A, 4W: .35"-1.15" (9.0-29.2mm) #16-4 Type SJ-#8-4 Type S, SO; 20 and 30A, 5W: .35"-1.15" (9.0-29.2mm) #16-5 Type S, SO - #8-5 Type S, SO. Terminals identified in accordance with UL 498 (X, Y, Z, White, Green).
Cord Grip Accommodation	#16- #8 AWG solid or stranded copper wire only.
Terminal Identification	Ratings are a permanent part of the device blade holder, and are also labeled on device color coded by voltage, visible in use. Catalog No. I.D. is on device visible in use.
Terminal Accommodation	
Product Identification	

Environmental	
Moisture Resistance	Type 4, 4X, 12, IP66 suitability.
Flammability (Enclosure)	V0 per UL94 or CSA 22.2 No. 0.17.
Operating Temperatures	Maximum Continuous 75°C; Minimum -40°C (w/o impact).

Note: *Suitable for use as a flanged receptacle.

Valox® is a trademark of SABIC Innovative Plastics, acquired from General Electric Company.

Twist-Lock® Devices

Technical Information

50 Amp Twist-Lock® Devices

Specifications

Listings

Listed to UL Standard 498 (Attachment Plugs and Receptacles).
 Certified to CSA Standard No. 42 (General Use Receptacles, Attachment Plugs and Similar Wiring Devices).

Part	Materials
Plug (Twist-Lock)	50A
Blade Holder	Thermoplastic polyester (black)
Power Blades	Brass
Terminal Set Screw	Stainless steel
Terminal Retainer	Thermoplastic polyester
Front and Rear (housing)	Supertough nylon
Cord Clamp	Thermoplastic polyester (white)
Seal	Neoprene
Seal Cup	Nylon
Box Terminal	Copper
Latches	Supertough nylon
Ground Contact Spring	One piece copper/nickel
Cord Clamp Screws	302/304 Stainless steel
Shroud	302/304 Stainless steel

Part	Materials
Connector (Twist-Lock)	50A
Contact Nose	Nylon (black)
Terminal Retainer	Thermoplastic polyester (black)
Terminal Set Screw	302/304 Stainless steel
Contact Spring	Brass
Assembly Ring	302/304 Stainless steel
Front and Rear (housing)	Supertough nylon (black)
Latches	Supertough nylon (white)
Cord Clamp	Thermoplastic polyester (white)
Box Terminal	Copper
Contact Holder	Thermoplastic polyester (black)
Ground Contact	One piece copper/nickel

Seal Cup	Nylon
Cord Grip screws	302/304 Stainless steel
Seal	Neoprene

Part	Materials
Flanged Inlet	50A
Flanged Casing	.062" Steel, zinc plate
Blade Holder	Phenolic
Pressure Screws	Steel, zinc plate
Blades	.100" Brass
Ground Spring	.025" Bronze
Terminals	.050" Steel, brass finish
Grounding Terminal	.062" Copper, green finish
Round Head Screws	Steel, zinc plate

Part	Materials
Receptacle	50A
Body	Phenolic
Face	Phenolic
Contact Springs	.100" Brass alloy
Contact Binding Plates	.100" Brass
Ground Contact	.031" Brass
Insulator	.093" Laminated phenolic
Bridge (Mounting Strap)	.062" Steel, zinc plate
Pressure Screws	Steel, zinc plate
Terminals	.050" Steel
Casing	.062" Steel, zinc plate
Center Pin (CS Devices)	Steel, zinc plate

Product Identification

Ratings	Molded into face for all devices and stamped into stainless steel shroud on plug devices.
Catalog Number	Molded into face for plug and connector bodies and stamped into stainless steel shroud on plug devices.

Performance

Electrical

Dielectric Voltage	Withstands 2,000V minimum.
Max. Working Voltage	600 Volts RMS.
Current Interrupting	Certified for current interrupting at full rated current.
Temperature Rise	Max. 30°C temperature rise at full rated current after 50 cycles of overload at 150% rated DC current (UL 498).

Mechanical

Terminal Accommodation	#8 AWG min. - #4 AWG max. Solid or stranded copper wire only.
Cord Grip Accommodation	Round cords types: S, SO, ST .830"-1.250" (21.08-31.75).

Environmental

Flammability	UL 94 V0 for Receptacles and Inlets. HB or better for Plugs and Connectors.
Operating Temperatures	Maximum continuous 75°C; minimum -40°C (w/o impact).

Note: Please consult the factory for product dimensions and specifications for other products listed in this catalog.

Twist-Lock® Devices

Technical Information

Switched Twist-Lock® and Hubbellock® Enclosures

Specifications

Typical Specifications

Manufacturer's Identification	Hubbell SETL3/SEHBL3-SE2730A.
Description	Lockable Switched Enclosure. This unit is a complete enclosure ready to accept any 20 or 30A Twist-Lock or 30A Hubbellock receptacle.
Electrical Type	2 Pole + Earth through 4 Pole and Earth.
Rating	20 or 30A, 125V through 3ØY 347/600V AC.
Configuration	NEMA Locking L5-20R through L23-30R.
Enclosure Type	Outdoor – Type 3R (Rainproof, Sleet, External Ice), IP54 suitability. Indoor – Type 12K (Dust-tight, Falling Dirt, Noncorrosive Liquids, with Knockout).
Enclosure Material	Non-metallic enclosure suitable for metallic conduit.

Materials

Part	Materials
Base	Valox®
Top	Valox®
Handle	Valox®
Conduit Hub	Zinc ¾" watertight
Enclosure Gasket	Neoprene
Shaft	Valox®
Shaft Seal	Molded neoprene
Frame	Galvanized steel
Lift Cover	Valox®
Enclosure Screws	Stainless steel 300 series
Hinge Spring and Pin	Stainless steel 300 series

Performance

Electrical	
Dielectric Voltage	Withstands 3,000V minimum.
Max. Working Voltage	600V RMS.
Current Interrupting	Certified for current interrupting at full rated current and voltage.
Short Circuit Withstand	Suitable for use on a circuit capable of delivering not more than 10,000 RMS symmetrical amperes at the voltage rating of the receptacle.
Operations	Mechanical 10,000 cycles; Electrical 6,000 cycles.

Mechanical	
Impact Resistance	In accordance with UL 746C.
Terminal Identification	In accordance with UL, CSA and international conventions.
Product Identification	Identification and ratings are part of external label and receptacle face.
Weight	3.5 pounds.
Mounting	External fully adjustable feet.

Environmental	
Moisture Resistance	Outdoor – Type 3R (Rainproof, Sleet, External Ice), IP54 suitability. Indoor – Type 12K (Dust-tight, Falling Dirt, Noncorrosive Liquids, with Knockout).
Flammability	UL94 – 5 VA and V0 classification.
Operating Temperature	Maximum continuous +75°C; Minimum continuous -40°C.
UV Resistance	All materials are UV stabilized.

Note: This device provides on/off switched control of a plug connected load and includes lockout provision: ON-OFF control knob (in the OFF position) accepts up to a 5/16" (8.0) diameter shackle of suitable padlock lockout device to isolate energy from the receptacle and cord connected equipment as a method of compliance to OSHA Lockout/Tagout Regulation 29CFR Part 1910.147.

Valox® is a trademark of SABIC Innovative Plastics, acquired from General Electric Company.

Twist-Lock® Devices

Technical Information

Mechanical Interlock Switched Safety Enclosures

Specifications

Typical Specifications

Manufacturer's Identification	Hubbell HBLMITL.
Description	Circuit-Lock Mechanical Interlock.
Electrical Type	2 Pole + Earth through 4 Pole and Earth.
Rating	Up to 30A, 3Ø 600V AC.
Enclosure Type	Outdoor – 4X (Watertight, Washdown); Indoor – 12K (Dust-tight, Falling Dirt and noncorrosive liquids with knockout. IP66 suitability.
Enclosure Material	Non-metallic enclosure suitable for metallic conduit.

Materials

Part	Material
Base	Valox®
Top	Valox®
Handle	Valox®
Conduit Hub	Zinc ¾" watertight
Enclosure Gasket	Neoprene
Shaft	Valox®
Shaft Seal	Neoprene
Frame	Galvanized steel
Enclosure Screws	Stainless steel 300 series

Performance

Electrical

Dielectric Voltage	Withstands 3,000V Min.
Max. Working Voltage	600V RMS.
Current Interrupting	Certified for current interrupting at full rated current voltage.
Short Circuit Withstand Rating	Suitable for use on a circuit capable of delivering not more than 10,000 RMS symmetrical amperes at the voltage rating of the receptacle.
Operations	Mechanical 10,000 cycles; Electrical 6,000 cycles.

Mechanical

Impact Resistance	In accordance with UL 746C.
Terminal Identification	In accordance with UL, CSA.
Product Identification	Identification and ratings are part of the external label and receptacle face.
Weight	3.5 pounds.
Mounting	External full adjustable feet.

Environmental

Moisture Resistance	Outdoor – 4X (Hose-Directed Water, Corrosion Resistance), IP66 suitability.
Flammability	Meets UL 94V0 material classification.
Operating Temperature	Maximum continuous +75°C; Minimum continuous -40°C.
UV Resistance	All exposed materials are UV stabilized.

Valox® is a trademark of SABIC Innovative Plastics, acquired from General Electric Company.

Technical Information

Valise® Plugs and Connectors

Specifications

Plugs
Typical Specification - Catalog No. HBL4723VY.
Description - Straight Body Plug
Type - 2 Pole, 3 Wire, Grounding
Rating - 15 and 20A 125V, 250V, and 277V AC, 30A 125 and 250V
Certification - UL Listed File E1706, CSA Certified
IP SUITABILITY - IP20

Connector Bodies
Typical Specification- Catalog No. HBL4729VY
Description - Straight Body Connector
Type - 2 Pole, 3 Wire, Grounding
Rating - 15 and 20A 125V, 250V, and 277V AC, 30A 125 and 250V
Certification - UL Listed File E1706, CSA Certified
IP SUITABILITY - IP20

Part	Material
Plug	15, 20 and 30A
Housing	Nylon
Blades	Brass
Ground Blade	Brass
Terminal Screws	Steel multiple drive
Cable Inserts	Polyphenylene Oxide
Terminal Clamps	CR Steel
Body Holding Screws	Steel multiple drive

Part	Material
Connector	15, 20 and 30A
Housing	Nylon
Contact and Ground Springs	Brass
Terminal Screws	Steel multiple drive
Cable Inserts	Polyphenylene Oxide
Terminal Clamps	CR Steel
Body Holding Screws	Steel multiple drive

Performance

Electrical	
Dielectric Voltage	Withstands 2,000V minimum.
Max. Working Voltage	125V, 250V or 277V AC as rated.
Current Interrupting	Certified for full rated current.
Temperature Rise	Max. 30°C temperature rise at full rated current after 50 cycles of overload at 150% rated DC current.
Mechanical	
Terminal Identification	Screw Color per UL 498 (Brass, White and Green).
Terminal Accommodation	15A-18 to 12AWG. Solid or stranded copper wire only. 20A-18 to 10AWG. Solid or stranded copper wire only. 30A-14 to 8AWG. Solid or stranded copper wire only.
Product Identification	Molded rating on device face.
Torque	12 in-lb terminal screws, 7 in-lb assembly screws.
Cord Range	
15A	.220" to .660" (5.6mm to 16.8mm).
20A	.325" to .720" (8.26mm to 18.3mm).
30A	.590" to .930" (15.0mm to 23.6mm).
Environmental	
Flammability	UL 94HB.
Operating Temperature	Maximum continuous 75°C, minimum -40°C (w/o impact).
Standards	
Listed to UL Standard UL498	
Certified to CSA Standard C22.2 No. 42	

SECTION C

Table of Contents



Watertight Devices



FD Boxes and Angled Adapters



GFCI Protected FD Box



Product	Page
Watertight Safety-Shroud® Twist-Lock® Devices	
20A and 30A Devices	C-3
Accessories	C-4
Watertight Devices	
15A and 20A, Straight Blade Devices	C-6
15A Twist-Lock® Devices	C-6
20A and 30A, Twist-Lock® Devices	C-7
Accessories	C-8

Product	Page
FD Boxes and Angled Adapters	C-9
GFCI Protected FD Box	C-10
Portable Outlet Boxes and Covers	C-11
Heavy Duty Portable Outlet Boxes and Plates	C-12
Dimensions	C-13
Technical Information	C-14

Watertight Devices

Features and Benefits

Watertight Safety-Shroud® Twist-Lock® System

- Virtually eliminates bent and broken plug blades, leading to longer equipment life
- Extends life of mating receptacles by eliminating damage caused by insertion of bent blades
- Extra protection for personnel by significantly reducing chance of inadvertent contact with blades when connecting or disconnecting energized receptacles and connector bodies
- Reduces exposure to arcing when connecting or disconnecting plugs under load
- Compliance with California Code of Regulations, Title 8, Article 51, subsection 2510.7(b), which requires shrouding for devices exceeding 300 volts
- Lockout/tagout hole allows compliance with OSHA regulation 29 CFR 1910.147



Note: Works with Mechanical Interlocks, see page B-41 for additional information.



Housing Design

- One-piece, engineered thermoplastic housing is impact-resistant for heavy duty industrial environments
- Blades are recessed for protection against bending and breaking
- Closure cap is included for environmental seal when device is not in use

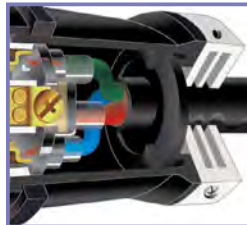

Assembly

- Cord grip screw recess minimizes screwdriver slippage
- All screws are #10 multiple drive head



Cord Range

- Assorted TPE seal glands can accommodate a wide range of cord sizes from #16-3 Type SJ to #8-5 Type S, SO
- Sealing gland and thermoplastic guard prevents water ingress from entering the device at the cord end



Panel or Box Mount Receptacles and Inlets

- High impact, thermoplastic housing for heavy duty industrial environments
- Mounting screw recesses minimize screwdriver slippage
- Accepts all mating NEMA locking plugs and most connector bodies, allowing interchangeability with existing devices



Identification

- Catalog number and color-coded voltage rating are easily visible even when in use
- Alignment arrows and lock and unlock symbols provide a visual indication that devices are properly connected



Spring-Loaded Cover

- One-step, push-to-close, spring-loaded cover with latch allows for fast opening and closing of lift cover
- Result: Environmental sealing is assured

Watertight Safety-Shroud® Twist-Lock® Devices



	NEMA Rating Color Coded by Voltage	Plug/ Connector	Poles/Wires	Plug	Connector	Flanged Inlet	Receptacle
20 Amp	NEMA L5-20 20A 125V		2P/3W	HBL2311SW	HBL2313SW	HBL2315SW	HBL2310SW
	NEMA L6-20 20A 250V		2P/3W	HBL2321SW	HBL2323SW	HBL2325SW	HBL2320SW
	NEMA L7-20 20A 277V AC		2P/3W	HBL2331SW	HBL2333SW	HBL2335SW	HBL2330SW
	NEMA L14-20 20A 125/250V AC		3P/4W	HBL2411SW	HBL2413SW	HBL2415SW	HBL2410SW
	NEMA L15-20 20A 3Ø 250V AC		3P/4W	HBL2421SW	HBL2423SW	HBL2425SW	HBL2420SW
	NEMA L16-20 20A 3Ø 480V AC		3P/4W	HBL2431SW	HBL2433SW	HBL2435SW	HBL2430SW
	NEMA L21-20 20A 3ØY 120/208V AC		4P/5W	HBL2511SW	HBL2513SW	HBL2515SW	HBL2510SW
30 Amp	NEMA L5-30 30A 125V		2P/3W	HBL2611SW	HBL2613SW	HBL2615SW	HBL2610SW
	NEMA L6-30 30A 250V		2P/3W	HBL2621SW	HBL2623SW	HBL2625SW	HBL2620SW
	NEMA L14-30 30A 125/250V AC		3P/4W	HBL2711SW	HBL2713SW	HBL2715SW	HBL2710SW
	NEMA L15-30 30A 3Ø 250V AC		3P/4W	HBL2721SW	HBL2723SW	HBL2725SW	HBL2720SW
	NEMA L16-30 30A 3Ø 480V AC		3P/4W	HBL2731SW	HBL2733SW	HBL2735SW	HBL2730SW
	NEMA L17-30 30A 3Ø 600V AC		3P/4W	HBL2741SW	HBL2743SW	HBL2745SW	HBL2740SW
	NEMA L21-30 30A 3ØY 120/208V AC		4P/5W	HBL2811SW	HBL2813SW	HBL2815SW	HBL2810SW

Mechanical Interlock Switched Safety Enclosure

Description	Catalog Number
Unfused mechanical interlock integrates a watertight safety shroud receptacle with a linked disconnect switch. See page B-41 for additional information.	HBLMITL

Specifications

Listings	
Listed to UL Standard 498 Certified to CSA Standard No.42 Fed. Spec. WC-596	
Environmental	
Moisture Resistance	UL Type 4, 4X, 12, IP66 suitability
Flammability (Enclosure)	V0 per UL94 or CSA 22.2 No. 0.17
Operating Temperatures	Maximum Continuous 75°C; Minimum -40°C (without impact)



HBLMITL

Watertight Devices

Accessories

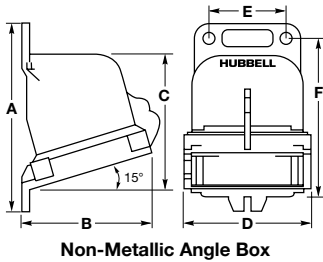

Non-Metallic Angle Box

15° Angle Non-Metallic Back Box

Description	NPT Hub Size	A Inch (mm)	B Inch (mm)	C Inch (mm)	D Inch (mm)	E Inch (mm)	F Inch (mm)	Cubic Inch Capacity	Catalog Number
For 20A and 30A Watertight Safety-Shroud Twist-Lock Receptacles and Inlets.	1"	5.67" (144.0)	4.44" (112.8)	4.05" (102.9)	3.91" (99.3)	2.35" (59.7)	4.92" (125.0)	30.00"	BB2030N

Note: Hub is not included; order Raco part number 1704. This box meets IP69k requirement and Type 4X requirements when installed with a watertight conduit hub.

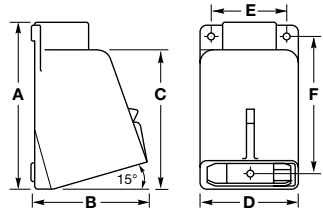

Metallic Angle Box

15° Angle Metallic Back Boxes

Description	NPT Hub Size	A Inch (mm)	B Inch (mm)	C Inch (mm)	D Inch (mm)	E Inch (mm)	F Inch (mm)	Cubic Inch Capacity	Catalog Number
For 20A and 30A Watertight Safety-Shroud Twist-Lock Receptacles and Inlets.	¾"	5.13" (130.2)	4.00" (101.6)	4.19" (106.4)	3.75" (95.3)	3.00" (76.2)	4.00" (101.6)	30.00"	BB201W
	1"	5.13" (130.2)	4.00" (101.6)	4.19" (106.4)	3.75" (95.3)	3.00" (76.2)	4.00" (101.6)	30.00"	BB301W

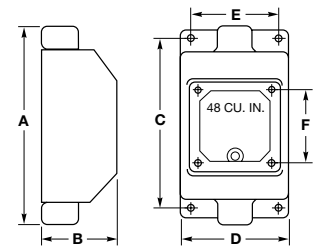

Metallic Feed Thru Box

Metallic Feed Thru Back Boxes

Description	NPT Hub Size	A Inch (mm)	B Inch (mm)	C Inch (mm)	D Inch (mm)	E Inch (mm)	F Inch (mm)	Cubic Inch Capacity	Catalog Number
For 20A and 30A Watertight Safety-Shroud Twist-Lock Receptacles and Inlets.	¾"	8.25" (209.6)	3.06" (77.8)	7.14" (181.4)	4.50" (114.3)	3.75" (95.3)	3.13" (79.5)	48.00"	FT202W
	1"	8.25" (209.6)	3.06" (77.8)	7.14" (181.4)	4.50" (114.3)	3.75" (95.3)	3.13" (79.5)	48.00"	FT302W

Note: These boxes are cast aluminum and are finished with enamel paint. These boxes withstand a 500-hour salt spray test as well as UL raintight and external icing tests. NPT (metric designator).

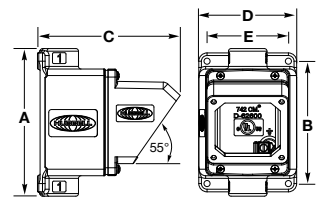

AB203055

55° Angle Metallic Adapter and Back Box

Description	NPT Hub Size	A Inch (mm)	B Inch (mm)	C Inch (mm)	D Inch (mm)	E Inch (mm)	F Inch (mm)	Cubic Inch Capacity	Catalog Number
For 20A and 30A Watertight Safety-Shroud Twist-Lock Receptacles and Inlets.	1"	6.80" (172.4)	5.63" (142.9)	6.60" (167.0)	4.50" (114.3)	3.74" (95.0)	-	45.27"	AB203055

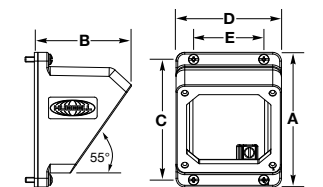

AA203055

55° Angle Metallic Adapter with Grounding Lug

Description	A Inch (mm)	B Inch (mm)	C Inch (mm)	D Inch (mm)	E Inch (mm)	F Inch (mm)	Cubic Inch Capacity	Catalog Number
For 20A and 30A Watertight Safety-Shroud Twist-Lock Receptacles and Inlets.	4.89" (124.2)	3.33" (84.8)	4.29" (109.1)	3.75" (95.3)	2.50" (63.5)	-	25.00"	AA203055



HBL2030AP

Straight Watertight Wall Box Adapter

Description	Catalog Number
Adapts 20A and 30A Watertight Safety-Shroud Twist-Lock receptacles and inlets to 2-gang, device mount, FD boxes.	HBL2030AP



AA2030PS

Non-Watertight Angle Wall Box Adapter

Description	Catalog Number
Adapts 20A and 30A Watertight Safety-Shroud Twist-Lock receptacles to 1- or 2-gang standard wall boxes (4" or 4 1/16" square).	AA2030PS

Dimensions in Inches (mm)

Watertight Devices

Features and Benefits

Watertight Devices

- The triple bypass seal provides a Watertight UL Type 4X and IP69K seal where devices are mated
- The cone seal at the cable entrance provides protection from water ingress
- Strongest strain relief for any Watertight device on the market, utilizing the patented Gotcha ring and collapsible bushing combination
- Nickel plated brass contacts and stainless steel screws provide corrosion resistance for metallic components
- Impact resistant, smooth, thermoplastic elastomer body helps collection point and aids in easy debris removal
- Floating cap rings allows for easy removal of dirt and debris



Industry's First Devices

Superior water ingress protection uniquely designed for the most extreme wash down procedures, withstanding hot and high pressure water, in addition to excessively dusty environments.



Housing Design

- LED version illuminates to let you know that the device is wired properly
- Smooth body design minimizes collection points simplifying the wash down process
- Strain relief nut always seals on the body regardless of cable size, eliminating areas of debris collection



Assembly

- Keyed interior for easy installation
- All stainless steel hardware and corrosion resistant connection points



Cord Range

- Hubbell's patented Gotcha® ring and collapsible bushing yields the industry's best strain relief
- Cone seal adjusts to any cable range
- Unique cone seal prevents dirt and debris from collecting at the cable entrance



Terminals

- High conductivity brass termination



Protection

- Triple bypass seal keeps water away from electrical connections and works with previously installed devices
- Free-floating cap allows unwanted material to wash away during sanitation



Plug Blades

- Corrosion resistant connection points

Features and Benefits

UL Type 4, 4X

IP65,66,67,69k*
SUITABILITY

Watertight Receptacles with Lift Covers

Hubbell Watertight receptacles with lift covers provide an impact resistant UL Type 4X seal combined with corrosion resistant metallic components. These universal covers can house any NEMA listed straight blade receptacles as well as any NEMA listed Twist-Lock® receptacles. The Watertight receptacles can either be mounted to FD/FS boxes (see page C-9) or panel mounted to a flat surface. Combined, this makes a diversified product with the high quality needed in industrial, wet and wash down applications.



Housing Design

- Impact resistant PBT material lid and cover plate
- Thermoplastic elastomer seal
- Lockable cover meets OSHA Lockout/Tagout regulations



Assembly

- Stainless steel mounting hardware
- Stainless steel hinge spring and pin



HBL14W47AWC



HBL15W47A



HBL60W47



HBL60W47D

15 Amp and 20 Amp Straight Blade Devices

	Rating	Plug/ Connector	Poles/ Wires	Color	Plug	Connector	Receptacle with Lift Cover	Duplex Recept. with Lift Cover
15 Amp	NEMA 5-15 15A 125V		2P/3W	Yellow Black Clear	HBL14W47A HBL14W47BK HBL14W47AWC	HBL15W47A HBL15W47BK HBL15W47AWC	HBL60W47 HBL60W47BK —	HBL60W47D — —
	NEMA 6-15 15A 250V		2P/3W	Yellow	HBL14W49	HBL15W49	HBL60W49	HBL60W49D
20 Amp	NEMA 5-20 20A 125V		2P/3W	Yellow Clear	HBL14W33A HBL14W33AWC	HBL15W33A HBL15W33AWC	HBL60W33 —	HBL60W33D —
	NEMA 6-20 20A 250V		2P/3W	Yellow	HBL14W48	HBL15W48	HBL60W48	HBL60W48D

15 Amp Twist-Lock® Devices

	Rating	Plug/ Connector	Poles/ Wires	Color	Plug	Connector	Receptacle with Lift Cover	Duplex Recept. with Lift Cover
15 Amp	NEMA L5-15 15A 125V		2P/3W	Yellow Black Clear	HBL24W47A HBL24W47BK HBL24W47AWC	HBL25W47A HBL25W47BK HBL25W47AWC	HBL65W47 — —	HBL65W47D — —
	NEMA L6-15 15A 250V		2P/3W	Yellow	HBL24W49	HBL25W49	HBL65W49	HBL65W49D
	NEMA L7-15 15A 277V AC		2P/3W	Yellow Black	HBL24W34 HBL24W34BK	HBL25W34 HBL25W34BK	HBL65W34 —	HBL65W34D —

Note: *Single and duplex receptacles while in use, not with cover closed.

20 Amp and 30 Amp Twist-Lock® Devices

	Rating	Plug/Connector	Poles/Wires	Color	Plug	Connector	Receptacle with Lift Cover
20 Amp	NEMA L5-20 20A 125V		2P/3W	Yellow Black Clear	HBL26W47 HBL26W47BK HBL26W47WC	HBL27W47 HBL27W47BK HBL27W47WC	HBL67W47 — —
	NEMA L6-20 20A 250V		2P/3W	Yellow Black	HBL26W48 HBL26W48BK	HBL27W48 HBL27W48BK	HBL67W48 HBL67W48BK
	NEMA L7-20 20A 277V AC		2P/3W	Yellow	HBL26W49	HBL27W49	HBL67W49
	NEMA L14-20 20A 125/250V AC		3P/4W	Yellow	HBL26W74	HBL27W74	HBL67W74
	NEMA L15-20 20A 3Ø 250V AC		3P/4W	Yellow Black	HBL26W75 HBL26W75BK	HBL27W75 HBL27W75BK	HBL67W75 HBL67W75BK
	NEMA L16-20 20A 3Ø 480V AC		3P/4W	Yellow Black	HBL26W76 HBL26W76BK	HBL27W76 HBL27W76BK	HBL67W76 HBL67W76BK
	NEMA L21-20 20A 3ØY 120/208V AC		4P/5W	Yellow Black	HBL26W81 HBL26W81BK	HBL27W81 HBL27W81BK	HBL67W81 —
	NEMA L22-20 20A 3ØY 277/480V AC		4P/5W	Yellow	HBL26W82	HBL27W82	HBL67W82
	NEMA L23-20 20A 3ØY 347/600V		4P/5W	Yellow	HBL26W83	HBL27W83	HBL67W83
	20A 125/250V Non-NEMA		3P/3W	Yellow	HBL26W08	HBL27W08	HBL67W08
	20A 3ØY 120/208V AC Non-NEMA		4P/4W	Yellow	HBL26W09	HBL27W09	HBL67W09
30 Amp	NEMA L5-30 30A 125V		2P/3W	Yellow Black	HBL28W47 HBL28W47BK	HBL29W47 HBL29W47BK	HBL69W47 —
	NEMA L6-30 30A 250V		2P/3W	Yellow Black	HBL28W48 —	HBL29W48 —	HBL69W48 HBL69W48BK
	NEMA L7-30 30A 277V AC		2P/3W	Yellow	HBL28W49	HBL29W49	HBL69W49
	NEMA L14-30 30A 125/250V AC		3P/4W	Yellow	HBL28W74	HBL29W74	HBL69W74
	NEMA L15-30 30A 3Ø 250V AC		3P/4W	Yellow Black	HBL28W75 HBL28W75BK	HBL29W75 HBL29W75BK	HBL69W75 HBL69W75BK
	NEMA L16-30 30A 3Ø 480V AC		3P/4W	Yellow Black	HBL28W76 HBL28W76BK	HBL29W76 HBL29W76BK	HBL69W76 HBL69W76BK
	NEMA L17-30 30A 3Ø 600V AC		3P/4W	Yellow	HBL28W77	HBL29W77	HBL69W77
	NEMA L18-30 30A 3ØY 120/208V AC		4P/4W	Yellow	HBL28W78	HBL29W78	—
	NEMA L21-30 30A 3ØY 120/208V AC		4P/5W	Yellow Black	HBL28W81 HBL28W81BK	HBL29W81 HBL29W81BK	HBL69W81 —
	NEMA L22-30 30A 3ØY 277/480V AC		4P/5W	Yellow	HBL28W82	HBL29W82	HBL69W82
	NEMA L23-30 30A 3ØY 347/600V AC		4P/5W	Yellow	HBL28W83	HBL29W83	HBL69W83
	30A 125/250V Non-NEMA		3P/3W	Yellow	HBL28W08	HBL29W08	HBL69W08
	30A 3ØY 120/208V AC Non-NEMA		4P/4W	Yellow	HBL28W09	HBL29W09	—



HBL24W47A



HBL25W47A



HBL26W47WC



HBL27W47WC



HBL26W47



HBL27W47BK



HBL27W47



HBL67W48

Note: *Single and duplex receptacles while in use, not with cover closed.



UL Type 4X Watertight Lift Covers



HBL6500

	Description	Color	Lift Cover
Lift Cover Assembly	For use with 15A or 20A straight blade receptacles and 15A Twist-Lock® receptacles; receptacle not included.	Yellow Black	HBL6500 HBL6500BK
	For use with 20A Twist-Lock® receptacles; receptacle not included. <i>Note: When mating with HBL26W09, 20A Non-NEMA plug, use HBL6800 cover.</i>	Yellow Black	HBL6700 HBL6700BK
	For use with 30A Twist-Lock® receptacles; receptacle not included.	Yellow Black	HBL6800 HBL6800BK



HBL28W75IN



HBL29W75IN

Interiors

Device	125V		3Ø 250V AC		3Ø 480V AC	
	Plug	Receptacle	Plug	Receptacle	Plug	Receptacle
15A Straight Blade Locking	HBL14W47IN HBL24W47IN	HBL15W47IN —	— —	— —	— —	— —
20A Locking	—	HBL27W47IN	HBL26W75IN	—	HBL26W76IN	HBL27W76IN
30A Locking	—	—	HBL28W75IN	HBL29W75IN	HBL28W76IN	HBL29W76IN

Bushings, Cone Seals and Closure Caps



HBLWTB1

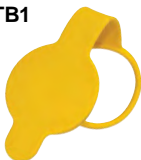

HBL50W50

Device	Bushings	Cone Seals	Closure Caps	
			Yellow	Black
15A Straight Blade Locking	HBLWTB1 HBLWTB1	HBLWTCS1 HBLWTCS1	HBL50W50 HBL50W50	HBL50W50BK HBL50W50BK
20A Straight Blade Locking	HBLWTB1 HBLWTB2	HBLWTCS1 HBLWTCS2	HBL50W50 HBL50W52	HBL50W50BK HBL50W52BK
30A Locking	HBLWTB3	HBLWTCS3	HBL50W54	HBL50W54BK

Features and Benefits

UL Type 4X

IP65,66,69k*
SUITABILITY



FD Boxes and Angled Adapters

Hubbell FD boxes and angled adapters are made of high impact resistant material. They are the only NEC[®] compliant box system that has enough wiring room for a 50A Twist-Lock[®] device. The stainless steel mounting and grounding bracket provides corrosion resistance, necessary in direct wash down applications. The FD Boxes are UL Type 4X rated when used with Watertight Lift Covers, i.e. HBL6500 or HBL6700 as well as with a blank plate such as HBL60CM88. The box and angled adapter can either be purchased separately or as a kit. The FD box and Adapter can be used with any single or duplex receptacle up to a 50A Twist-Lock[®].



Housing Design

- 30 cu. in. FD box made of high impact thermoplastic material
- 3/4" NPT and 1" NPT threaded hub options
- Stainless steel mounting/grounding bracket
- External mounting feet, accepts #10 screw



Adapter

- 55° angle adapter (15 cu. in.)
- External mounting feet, accepts #8 screw
- Accepts duplex and single receptacles up to a 50A Twist-Lock[®]

FD Boxes and Angled Adapters

	Description	Catalog Number
Boxes	(2) 3/4" NPT Hubs, FD Box, Yellow	HBL60CM83A
	(2) 3/4" NPT Hubs, FD Box, White	HBL60CM83WA
	(2) 3/4" NPT Hubs, FD Box, Gray	HBL6083
	(2) 1" NPT Hubs, FD Box, Yellow	HBL60CM84A
	(2) 1" NPT Hubs, FD Box, White	HBL60CM84WA
	(2) 1" NPT Hubs, FD Box, Gray	HBL6084
Adapters	55° Angle Adapter, Yellow	HBL60CM55
	55° Angle Adapter, White	HBL60CM55W
	55° Angle Adapter, Gray	HBL6055
Kits	(2) 3/4" NPT Hubs, Box/Adapter Kit, Yellow	HBL60CM83AK
	(2) 3/4" NPT Hubs, Box/Adapter Kit, White	HBL60CM83WAK
	(2) 3/4" NPT Hubs, Box/Adapter Kit, Gray	HBL6083AK
	(2) 1" NPT Hubs, Box/Adapter Kit, Yellow	HBL60CM84AK
	(2) 1" NPT Hubs, Box/Adapter Kit, White	HBL60CM84WAK
	(2) 1" NPT Hubs, Box/Adapter Kit, Gray	HBL6084AK
Covers	Blank Cover Plate, Yellow	HBL60CM88
	Blank Cover Plate, White	HBL60CM88W
	Blank Cover Plate, Gray	HBLP14FS



Note: *Plug, receptacle and FD box required for IP69K rating.
Angled adapters are not UL/CSA listed or UL Type 4X.

NEC[®] is a registered trademark of the National Fire Protection Association (NFPA).

Features and Benefits

UL Type 4X

GFCI Protected FD Box

The GFCI protected FD box provides a UL Type 4X GFCI enclosure made for wet and damp locations for 30A 120V and 240V Watertight receptacles. The GFCI response time does not exceed .025 seconds ensuring a safe circuit shut down if the current were to deviate from its path. Auto resetting GFCI box, when connected to an FD box by utilizing a PolyTuff® liquid tight conduit provides advanced safety features for Watertight devices.



GFCI Housing Design

- UL enclosure Type 4X, for wet and damp locations. Components are UL and CSA listed
- 30A, 120V and 240V with auto reset
- GFCI response time is .025 sec. Max.
- Grounded neutral protection trips if ground and neutral touch at load side



FD Box

- Utilizes PolyTuff® liquidtight conduit and fittings
- UL enclosure Type 4X, for wet and damp locations. Components are UL and CSA listed
- For use with single and duplex watertight receptacles (single phase only)

Note: Watertight receptacles purchased separately.

GFCI Protected FD Box

	Description	Catalog Number
FD Box	Watertight FD Box, GFCI Module, 30A 120V, Yellow	HBLWTGF120
	Watertight FD Box, GFCI Module, 30A 240V, Yellow	HBLWTGF240



HBLWTGF120
HBLWTGF240

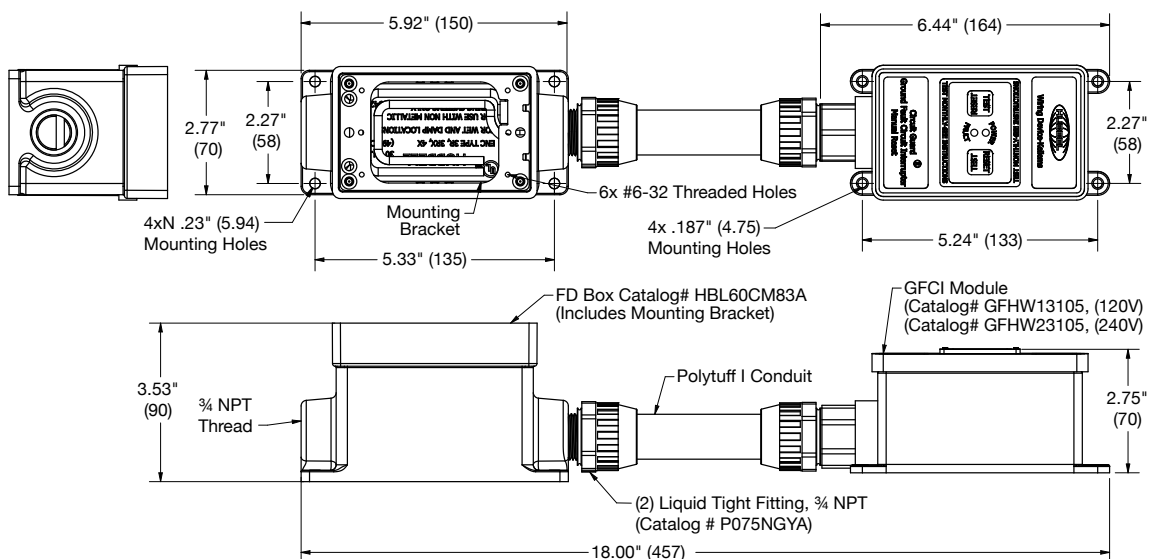

Dimensions in Inches (mm)

Features and Benefits

Box Suitable for Wet and Damp Locations

IP44
SUITABILITY

Portable Outlet Boxes and Covers for Boxes and Panels

The thermoplastic elastomer material of the Portable Outlet Box provides a strong housing with enough capacity for multiple devices to fit, with cord feed through options available. The impact resistant PBT covers add to the durability of the box and the devices inside. There are several cord connectors available ranging from standard to deluxe, providing unmatched strain relief. The covers provide a UL Type 3R weather resistant seal suitable for wet and damp locations. Portable Outlet Boxes are available as pre-assembled or can be configured as needed.

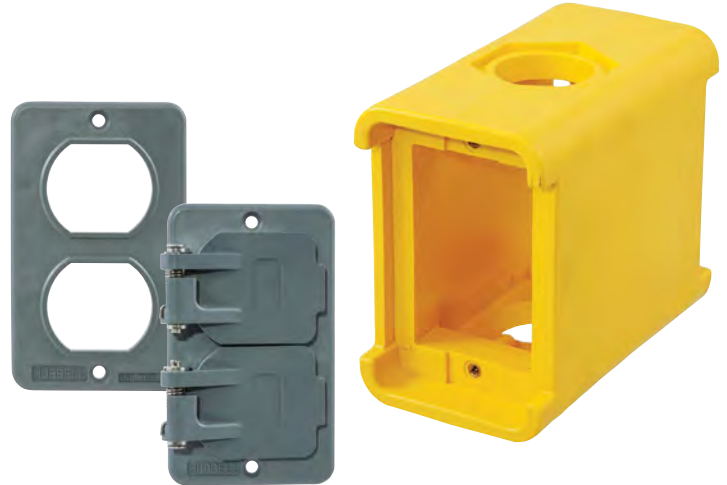

Housing Design

- Fully thermoplastic elastomer housing exceeds UL crush requirements
- Wiring room large enough to accommodate the broadest range of device requirements in one size box
- Extended wall protects lift covers from impact damage
- Brass inserts for maximum strength



Covers

- Impact resistant PBT material
- UL Type 3R seal on a panel or on a portable outlet box
- Stainless steel hinge and spring

Pre-Assembled Portable Outlet Boxes (with Cord Connector Installed)

	Description	Cord Range Inches (mm)	Catalog Number
Boxes	Portable Outlet Box, Deep, Yellow	.38"-.50" (9.7-12.7)	HBL3099
	Portable Outlet Box, Deep, Feed Thru, Yellow	.38"-.50" (9.7-12.7)	HBL3090F
	Portable Outlet Box, Deep, Yellow with (2) duplex plates	.38"-.50" (9.7-12.7)	HBL3000



Configurable Portable Outlet Boxes

	Empty Box Options	Catalog Number	Cord Range Inches (mm)	Cord Connector Options		Deluxe Cord Connectors
				Gray Nylon	Black Nylon	
Boxes	Outlet Box, Yellow	HBL3080	.38"-.50" (9.7-12.7)	SHC1039CR	—	—
	Outlet Box, Black	HBL3080BK	.50"-.63" (12.7-15.9)	SHC1040CR	SHC2040CR	CG810NM
	Feed Thru Box, Yellow	HBL3080F	.63"-.75" (15.9-19.0)	SHC1041CR	SHC2041CR	074011341
	Feed Thru Box, Black	HBL3080FBK	.75"-.88" (19.0-22.2)	SHC1042CR	SHC2042CR	074011342
			.88"-.1.00" (22.2-25.4)	SHC1043CR	SHC2043CR	074011343
			.59"-.1.00" (15.0-25.4)	SEC100GA	SEC100BA	—



Covers for Portable Outlet Boxes and Panels

	Description	UL Type 3R	UL Type 1
Box Covers	Outlet box cover, duplex receptacle	HBL3056	HBL3051
	Outlet box cover, 1.39" diameter receptacle	HBL3057	HBL3052
	Outlet box cover, 1.572" diameter receptacle	HBL3058	HBL3055
	Outlet box cover; GFCI	HBL3061	HBL3060
	Outlet box coverplate, blank	HBL3054	—





HBLPOB1



White POB



Cover Plates



Deluxe Cord Grips (purchased separately)



Gray Nylon Cord Connector

Heavy Duty Portable Outlet Boxes and Cover Plates

Description	Catalog Number
Box with cord strain relief, with one blank cover plate.	HBLPOB1
White box with cord strain relief, one blank white cover plate.	HBLPOB1L
Box with cord strain relief, with one blank cover plate, black.	HBLPOB1BK
Box with cord strain relief, with two duplex (indoor) cover plates.	HBLPOB1D
White box with cord strain relief, with two white duplex (indoor) cover plates.	HBLPOB1DL
Box with cord strain relief, with two duplex (indoor), yellow cover plates.	HBLPOB1DY
Blank, non-metallic FS cover plate with foam gasket, gray.	HBLP14FS
Blank, non-metallic FS cover plate with foam gasket, white.	HBLP14FSL
Duplex, non-metallic FS cover plate, gray.	HBLP8FS
Duplex, non-metal FS cover plate, white.	HBLP8FSL
Duplex, non-metallic FS cover plate, yellow.	HBLP8FSY
Single receptacle (1.39"), non-metallic FS cover plate, gray.	HBLP7FS
Single receptacle (1.56"), non-metallic FS cover plate, gray.	HBLP720FS
Rectangular opening, non-metallic FS cover plate, gray.	HBLP26FS
Rectangular opening, non-metallic FS cover plate, White.	HBLP26FSL

Other Cover Plates and Devices

which may be used with Heavy Duty Portable Outlet Boxes

Description	Catalog Number
Duplex cover plate, weatherproof.	HBL5221, HBL52CM21
Single receptacle (1.39") cover plate, weatherproof.	HBL7423WO, HBL74CM23WO
Single receptacle (1.56") cover plate, weatherproof.	HBL7425WOA, HBL74CM25WOA
Safety-Shroud Twist-Lock® surface receptacles.	HBL2310SR, HBL2320SR, HBL2330SR, HBL2610SR, HBL2620SR

Note: Standard product gray, CM yellow.

Deluxe Cord Grips Straight Male Thread Nylon Fittings, Stainless Steel Mesh, Liquidtight, for Insulated Cables

Grip Diameter Range Inches (cm.)	Thread Size NPT (inches)	Form Size	Catalog Number
.375"-.500" (.97-1.27)	¾"	F3	074011335
.500"-.625" (1.27-1.59)	¾"	F3	074011336
.625"-.750" (1.59-1.90)	¾"	F3	074011337

Nylon Cord Connector Straight Male Thread

Grip Diameter Range Inches (cm.)	Thread Size NPT (inches)	Form Size	Catalog Number
.375"-.500" (.97-1.27)	¾"	F3	SHC1035CR
.500"-.625" (1.27-1.59)	¾"	F3	SHC1036CR
.625"-.750" (1.59-1.90)	¾"	F3	SHC1037CR

Specifications for Heavy Duty Portable Outlet Boxes and Cover Plates

UL Listed	UL 514C, UL467 and UL50 Enclosures Types 1, 3R.
CSA Certified	C22.2 No. 18 and C22.2 No. 94 Enclosures Types 1, 3R and C22.2 No. 0.4 (Impedance).
Box Specifications:	
Moisture Resistance	Wet and damp locations, Enclosure Type 3R when used with weatherproof cover plates. Dry, indoors locations, Enclosure Type 1 with all other cover plates. UL 94V-0, 94-5VA classification.
Flammability	80°C maximum; -35°C minimum.
Operating Temperature	All materials are UV stabilized.
UV Resistance	in accordance with UL 514C, UL50, C22.2 No. 18 and C22.2 No. 94.
Impact and Crush Resistance	Valox®.
Material	Nylon nut; Nylon Gotcha® ring; Neoprene grommet.
Cord Connector Materials	.38" to .75" diameter.
Cord Diameter Range	Brass.
Bonding Strap Material	Brass.
Threaded Inserts	Brass.
Grounding Screw Material	Brass.
Indoor Cover Plate Screws Material	Zinc Plated Steel.
Outdoor Cover Plate Screws Material	Stainless Steel.
Cover Plate Gasket Material	UL recognized closed-cell foam (aging and oil resistant).

Dimensions

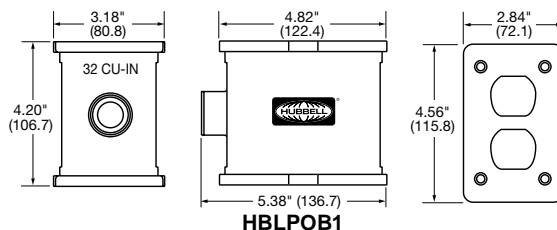

Valox® is a trademark of SABIC Innovative Plastics, acquired from General Electric Company.

Dimensions in Inches (mm)

Watertight Devices

Plugs and Connectors Inches (mm)

		15A & 20A Straight Blade	15A Non-NEMA Straight Blade	15A Twist-Lock®	20A Twist-Lock®	30A Twist-Lock®
Plugs	A	1.85" (47.07)	1.63" (41.40)	1.85" (47.07)	2.51" (63.70)	2.77" (70.41)
	B	3.16" (80.27)	2.68" (68.00)	3.21" (81.46)	3.96" (100.69)	3.94" (99.98)
Connectors	C	1.85" (47.07)	1.80" (46.00)	1.85" (47.07)	2.51" (63.70)	2.77" (70.41)
	D	4.42" (112.14)	4.00" (102.00)	4.62" (117.22)	5.69" (144.55)	5.67" (144.00)

Note: For HBL26W09 and HBL27W09 use 30A Twist-Lock® dimensions.



Receptacles with Lift Covers Inches (mm)

	15A & 20A Straight Blade	15A Twist-Lock®	20A Twist-Lock®	20A Non-NEMA	30A Twist-Lock®	30A Non-NEMA
A	4.56" (115.9)	4.56" (115.9)	4.56" (115.9)	4.56" (115.9)	4.56" (115.9)	4.56" (115.9)
B	3.10" (78.7)	3.10" (78.7)	3.10" (78.7)	3.10" (78.7)	3.10" (78.7)	3.10" (78.7)
C	1.20" (30.6)	1.20" (30.6)	1.20" (30.6)	1.20" (30.6)	1.20" (30.6)	1.20" (30.6)
D	3.25" (82.6)	3.25" (82.6)	3.25" (82.6)	3.25" (82.6)	3.25" (82.6)	3.25" (82.6)
E	1.88" (47.6)	1.88" (47.6)	1.88" (47.6)	1.88" (47.6)	1.88" (47.6)	1.88" (47.6)
F	1.26" (32.0)	1.46" (37.1)	1.72" (43.7)	2.26" (57.4)	1.72" (43.7)	1.97" (50.0)
G	1.63" (41.4)	1.63" (41.4)	2.25" (57.2)	2.25" (57.2)	2.25" (57.2)	2.25" (57.2)
H	5.00" (127.0)	5.00" (127.0)	5.00" (127.0)	5.00" (127.0)	5.00" (127.0)	5.00" (127.0)

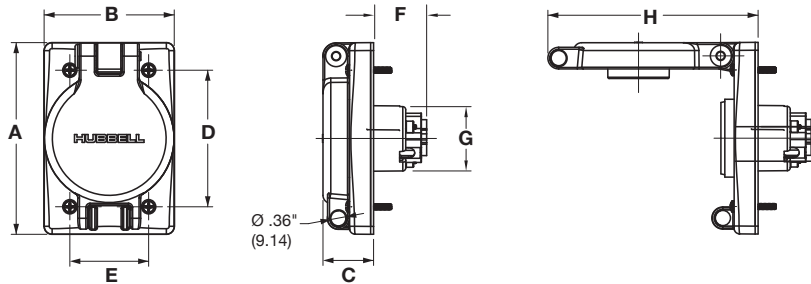

Portable Outlet Boxes Inches (mm)

	Pre-Assembled	Configurable
A	4.30" (109.2)	4.30" (109.2)
B	5.00" (127.0)	5.00" (127.0)
C	2.77" (70.4)	2.77" (70.4)
D	3.28" (83.3)	3.28" (83.3)
E	5.79" (147.0)	—
F	7.28" (184.9)	—

Box Covers Inches (mm)

	Covers
A	3.78" (96.0)
B	2.28" (57.9)
C	0.27" (6.9)
D	3.28" (83.3)
E	1.87" (47.5)
F	3.25" (82.6)

Note: Style shown is representative of all openings.

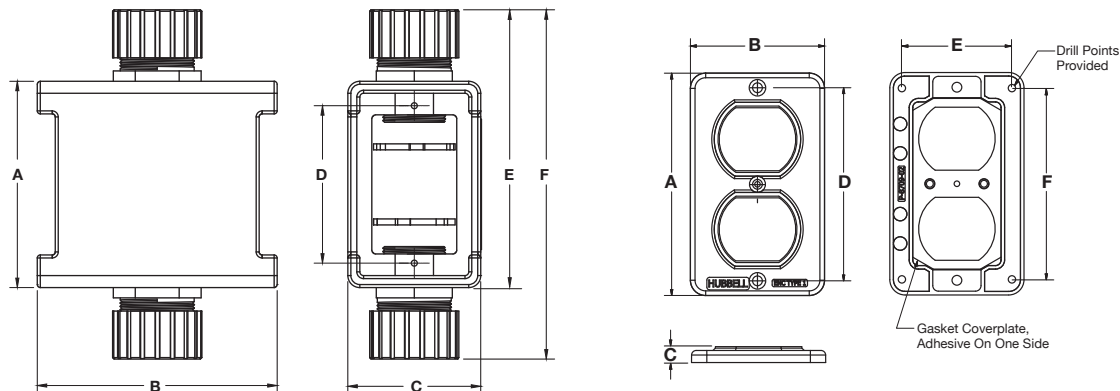

Dimensions in Inches (mm)

Watertight Devices

Materials

Plug/Connector

Part	Materials
Blade/Contact Carrier	Nylon, white
Terminal Retainer	Polycarbonate, clear
Housing	Thermoplastic elastomer
Housing Insert	Nylon, white
Strain Relief Nut	PBT thermoplastic, gray
Blades/Contacts	Brass, nickel plated
Terminal Screws	Brass
Terminal Screw Size	#8-32 15A/20A Straight Blade and 15A Twist-Lock®; #10-32 20A and 30A Twist-Lock
Assembly Screws	Stainless Steel
Bushings	Thermoplastic elastomer, black
Gotcha Ring	Nylon
Cone Seal	Thermoplastic elastomer, black
Closure Cap	Thermoplastic elastomer

Receptacle Assembly

Part	Materials
Base, Flip Lid and Backplate	PBT
Seal Collar	Thermoplastic elastomer
Mounting Screws	Stainless Steel
Spring and Hinge Pin	Stainless Steel

Portable Outlet Box and Accessories

Part	Materials
Box Enclosure	Thermoplastic elastomer
Strain Relief Nut	PBT
Grommet	Thermoplastic elastomer
Gotcha Ring	Nylon
Locknut	Steel, zinc plate
Threaded Inserts	Brass
Receptacle Screw	Stainless steel
Cover Plate	PBT
Cover Plate Seal	Neoprene
Cover Plate Spring	Stainless steel
Hinge Pin	Stainless steel
Hinge Bracket	Zinc plated steel
Rivets	Zinc plated steel

Specifications

Listings (Plug/Connector and Flip Lid Assembly)

Listed to UL498
 Certified to CSA C22.2 No. 42
 Meets NEMA WD-1, WD-6, and ANSI standards
 IP66 Suitability
 NSF Certified (Plugs, Connectors and Receptacles)

FD Box/Adapter

Part	Materials
Box Enclosure	PBT
Ground Bracket	316 Stainless Steel
Ground Screw	Brass
Angle Adapter	PBT

Environmental

Box	UL Type 4X (with UL Type 4X receptacle assembly) UL Type 3R (with weatherproof cover plate)
-----	--

Performance

Electrical

Dielectric Voltage	
Connectors:	2000V AC if rated 300V or less; 3000V AC if rated above 300V
Plugs:	2500V AC if rated 300V or less; 3500V AC if rated above 300V
Max Working Voltage	As marked
Current Interrupting	Rated for current interruption per UL498
Temperature Rise	30°C max per UL498 at rated current

Mechanical

Cord and terminal accommodations:

Plugs and Connectors

15 and 20A Straight Blade and 15A Locking	16/3 SJ to 10/3 SJ, 18/3 S to 12/3 S, (Ø.325" to Ø625") (Ø8.3mm to Ø15.9 mm)
20A Locking Except HBL26W09 & HBL27W09	Min. Cord: 16/3 SJ, 18/3 S, 18/4 SJ, 18/4 S, 18/5 S, (Ø.325") (Ø8.3 mm) Max. Cord: 10/3 S, 10/4 S, 10/5 S (.875") (22.2 mm)
30A Locking Including HBL26W09 & HBL27W09	Min Cords: 12/3 SJ, 16/3 S, 14/4 SJ, 18/4 S, 18/5 S, (Ø.375") (Ø9.5 mm) Max Cord: 8/3 S, 8/4 S, 10/5 S (1.125") (28.6 mm)

Receptacles – use solid or stranded building wire or flexible cord only as outlined below:

All Straight Blade	18 AWG to 10 AWG
15A Locking	18 AWG to 10 AWG
20A and 30A Locking	18 AWG to 8 AWG

Portable Outlet Boxes

Cord Range	.38" to .68" (HBL3099, HBL3090F, HBL3000) and .38" to 1.00" with user-specified cord connector
Wiring Volume	19.0 in ³

Environmental

Moisture Resistance	UL Listed to 3R, 3RX, 4, 4X, 6, 6P, 12 (Plugs and connectors); 3R, 3RX, 4, 4X (Receptacles); Wet and Damp Locations (Portable outlet boxes); Covers (POB) UL Type 3R and Wet Locations cover closed
Flammability	UL94V0 (boxes, covers, and plates); UL94V2 (Plugs, connectors, and interiors); UL94HB (Caps, bushings, and cone seals) -40°C (without impact) to +60°C continuous
Operating Temperatures	All exposed materials are UV stabilized
UV Resistance	

SECTION D

Table of Contents

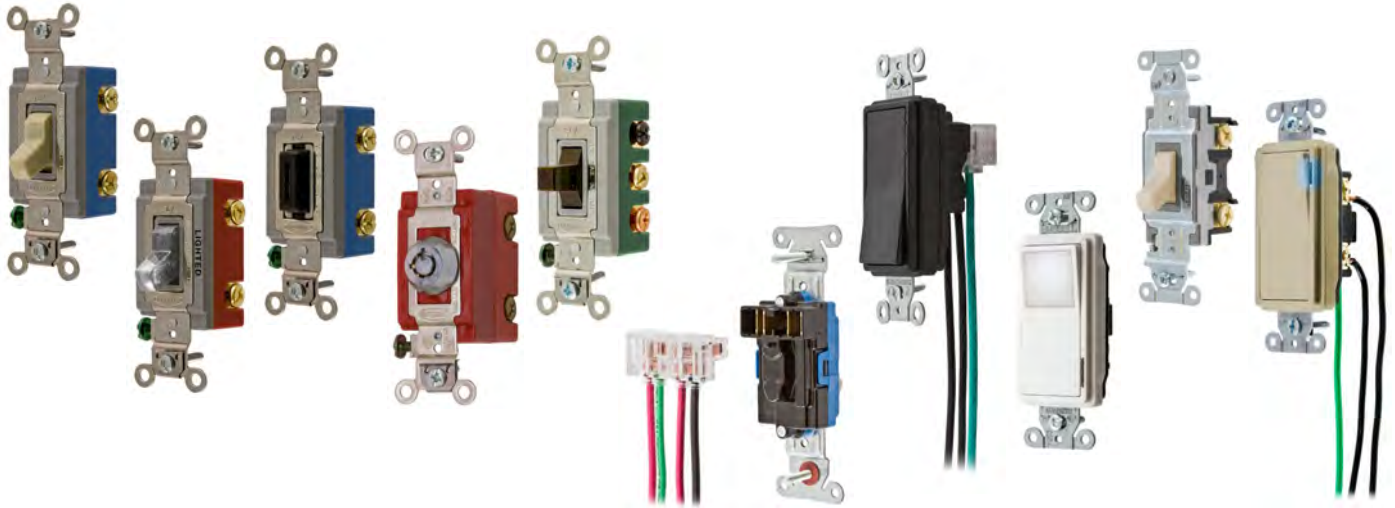

HBL® Extra Heavy Duty Industrial Grade Switches



SNAPConnect® Toggle and Decorator Switches



Pre-Wired/Leaded Commercial Switches

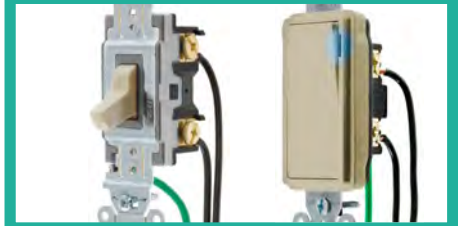

Product	Page	Product	Page
HBL® Extra Heavy Duty Industrial Grade Series		Weatherproof Series, Illuminated and Night Light	D-15
Toggle and Locking Type	D-3	Low Voltage, Maintained and Momentary Contact	D-16
Toggle Type Illuminated and Pilot Light	D-4	Switch Accessories	
3-Position, 2-Circuit Center OFF	D-4	Pilot Light, SWITCHOUT® Lockout Device and	
Toggle 347V and PresSwitch®	D-5	Weatherproof Switch Covers for Toggle Switches	D-17
Hubbell-PRO Heavy Duty Industrial Series	D-6	Nylon, Snap-On and Metal Wallplates	D-18
SNAPConnect® Heavy Duty Series		Certification Chart	D-19
SNAPConnect® Toggle	D-8	Dimmers	
SNAPConnect® Decorator	D-9	Slide and Rotary Control Dimmers	D-20
EdgeConnect™		Dimmer Ganging and Derating	D-21
HBL® Extra Heavy Duty Industrial Series	D-11	Heavy Duty Panel Mount and Bat Handle Switches	D-22
Toggle Specification Grade Commercial Series	D-11	Technical Information	D-24
Style Line® Decorator Specification			
Grade Commercial Series	D-12		
Specification Grade Commercial Series			
Toggle and Framed Toggle	D-13		
Pre-Wired/Leaded and Style Line® Decorator	D-14		

Switches

Features and Benefits

HBL® Extra Heavy Duty Industrial Grade

The HBL® Switch provides the safest and most reliable design for heavy-duty Industrial environments.

- 15, 20 and 30 Amp 120/277V AC
- Single Pole, Double Pole, 3-Way and 4-Way
- Illuminated and Pilot with LED
- Locking Both Standard and Rotary
- 3 Position Momentary and Maintained
- Abuse Resistant Nylon Toggle



Housing Design

- One-piece design engineered thermoset base for superior heat dissipation
- One-piece design high impact-resistant thermoplastic front for heavy-duty industrial environments
- Stainless steel automatic grounding clip assures grounding continuity between mounting strap and metal wall box



Wiring Design

- Back wire entrance points for terminations accept two wires for feed through capability avoiding pigtail
- Large brass binding head screws with deep slots secure wire connections
- Strip gauge for accurate wiring



Bridge Design

- One-piece bridge with integral grounding terminal with #8 brass screw allows compliance to NEC®
- Steel nickel plated mounting strap provides a superior corrosion resistant finish
- Thread cleaning captive mounting screw

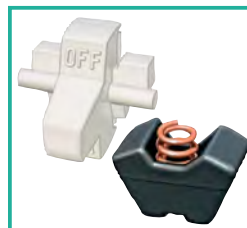

Toggle

- Heavy duty nylon toggle resists abuse and chemical attack making it suitable for use in the toughest environments
- Elastomer rocker assures quiet operation and precise timing
- Permanently lubricated assembly provides long life and trouble free operation



Identification

- Color coded base identifies amperage when terminating connections, 15A (Blue), 20A (Red) and 30A (Green)
- Prominent amperage marking allows easy identification of rating



Contacts

- One-piece rivetless copper alloy spring contact arm and terminal plate assures proper contact alignment reducing heat rise
- Large silver alloy contacts reduce contact erosion and prevent welding, providing long life

NEC® is a registered trademark of the National Fire Protection Association (NFPA).

HBL® Extra Heavy Duty Industrial Series, 15A, 120/277V AC

Description	Toggle Color	Single Pole	Double Pole	Three Way	Four Way
Toggle, back and side wired.	Black	HBL1201BK	—	HBL1203BK	HBL1204BK
	Brown	HBL1201	HBL1202	HBL1203	HBL1204
	Gray	HBL1201GY	—	HBL1203GY	HBL1204GY
	Ivory	HBL1201I	HBL1202I	HBL1203I	HBL1204I
	Light Almond	HBL1201LA	—	—	—
	Red	HBL1201R	—	—	—
	White	HBL1201W	—	HBL1203W	HBL1204W

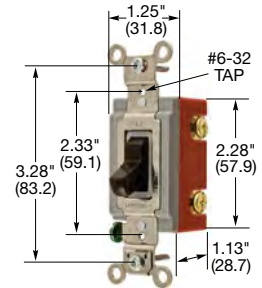

HBL1221

20A, 120/277V AC

Description	Toggle Color	Single Pole	Double Pole	Three Way	Four Way	
Toggle, back and side wired.	Black	HBL1221BK	HBL1222BK	HBL1223BK	HBL1224BK	
	Brown	HBL1221	HBL1222	HBL1223	HBL1224	
	Gray	HBL1221GY	HBL1222GY	HBL1223GY	HBL1224GY	
	Ivory	HBL1221I	HBL1222I	HBL1223I	HBL1224I	
	Light Almond	HBL1221LA	HBL1222LA	HBL1223LA	HBL1224LA	
	Red	HBL1221R	HBL1222R	HBL1223R	HBL1224R	
		White	HBL1221W	HBL1222W	HBL1223W	HBL1224W

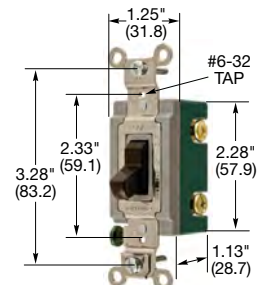

HBL3031

30A, 120/277V AC

Description	Key Guide Color	Single Pole	Double Pole	Three Way	Four Way
Nylon toggle.	Brown	HBL3031	HBL3032	HBL3033	—
	Ivory	HBL3031I	HBL3032I	HBL3033I	—
	White	—	HBL3032W	—	—

HBL® Extra Heavy Duty Industrial Locking Series, 15A, 120/277V AC

Description	Key Guide Color	Single Pole	Double Pole	Three Way	Four Way
Key Guide, back and side wired.	Black	HBL1201L	HBL1202L	HBL1203L	HBL1204L
	Gray	HBL1201LG	HBL1202LG	HBL1203LG	HBL1204LG
	Ivory	HBL1201LI	HBL1202LI	HBL1203LI	HBL1204LI
	White	HBL1201LW	HBL1202LW	HBL1203LW	HBL1204LW
Key for Locking switch.		HBL1209			

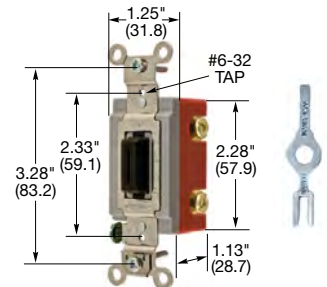

HBL1221L and Key

20A, 120/277V AC

Description	Key Guide Color	Single Pole	Double Pole	Three Way	Four Way
Key Guide, back and side wired.	Black	HBL1221L	HBL1222L	HBL1223L	HBL1224L
	Gray	HBL1221LG	HBL1222LG	HBL1223LG	HBL1224LG
	Ivory	HBL1221LI	HBL1222LI	HBL1223LI	HBL1224LI
	White	HBL1221LW	HBL1222LW	HBL1223LW	HBL1224LW
Key for Locking switch.		HBL1209			

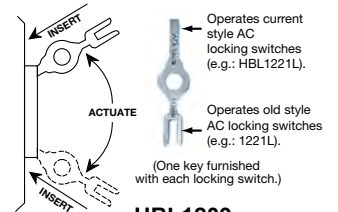

HBL1209

HBL® Extra Heavy Duty Industrial AC Barrel Key Locking Switch†, 20A, 120/277V AC

Description	Key Guide Color	Single Pole	Double Pole	Three Way	Four Way
Chrome operator, back and side wired.	Chrome	HBL1221RK^L*	HBL1222RK^L*	HBL1223RK^L*	HBL1224RK^L*
Replacement Barrel Key.		HBL1209RKL			

Note: Keys are supplied with each locking switch. For extra keys order HBL1209.

^{*}Not Fed. Spec.

[†]See Wallplate section, page O-17 for locking switch wallplates.

See page D-15 for accessories and page D-16 for wallplates.

See page D-22 for technical information.

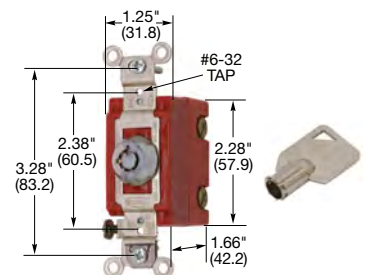

HBL1222RK^L and Key

Dimensions in Inches (mm)

HP Conversion Chart

	120V	208V	240V	277V AC
15A	.5HP	1.5HP	2HP	2HP
20A	1HP	2HP	2HP	2HP
30A	2HP	2HP	2HP	2HP

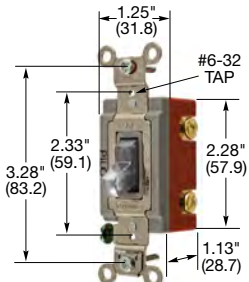

HBL1221ILC

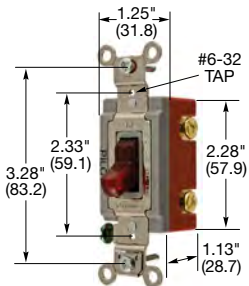

HBL1221PL

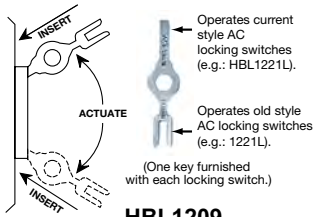

HBL1209

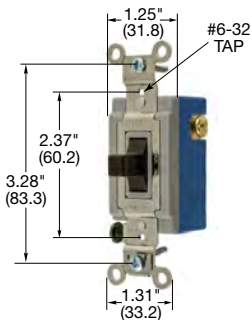

HBL1381

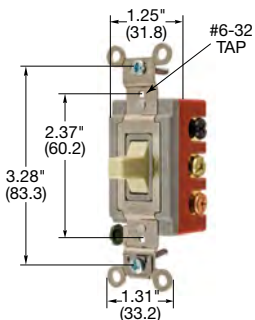

HBL1386I

Dimensions in Inches (mm)

HBL® Extra Heavy Duty Industrial Series, Illuminated Toggle Switches, Light ON with Load OFF

Description	Toggle Color	Rating	Single Pole	Double Pole	Three Way
Nylon toggle, back and side wired.	Ivory	15A 120/277V AC	HBL1201IL	—	HBL1203IL
	Ivory	20A 120/277V AC	HBL1221IL	—	HBL1223IL
	Clear		HBL1221ILC	—	HBL1223ILC
	Red		HBL1221ILR	—	—

HBL® Extra Heavy Duty Industrial Series, Pilot Light Switches, Light ON with Load ON

Description	Toggle Color	Rating	Single Pole	Double Pole	Three Way
Nylon toggle, back and side wired.	Red	15A 120/277V AC	HBL1201PL	—	HBL1203PL
	Red	20A 120/277V AC	HBL1221PL	HBL1222PL	HBL1223PL
	Clear		HBL1221PLC	—	HBL1223PLC
	Green		HBL1221PLG	—	—
	Red	30A 120/277V AC	HBL3031PL	HBL3032PL	—

HBL® Extra Heavy Duty Industrial Series, Momentary Contact, Specification Grade, Three Position, Two Circuit, Center OFF

Description	Toggle Color	15A, 120/277V AC	20A, 120/277V AC
Nylon toggle, back and side wired.	Brown	HBL1556	HBL1557
	Gray	HBL1556GY	HBL1557GY
	Ivory	HBL1556I	HBL1557I
	Light Almond	HBL1556LA	HBL1557LA
	Red	HBL1556R	—
	White	HBL1556W	HBL1557W
Key guide, back and side wired.	Black	HBL1556L	HBL1557L
	Gray	HBL1556LG	HBL1557LG
	Ivory	HBL1556LI	HBL1557LI
	White	HBL1556LW	HBL1557LW
Key for Locking switch.		HBL1209	

HBL® Extra Heavy Duty Industrial Series, Maintained Contact, Specification Grade, Three Position, Two Circuit, Center OFF, Single Pole, Double Throw

Description	Toggle Color	15A 120/277V AC	20A 120/277V AC	30A 120/277V AC
Nylon toggle, back and side wired.	Brown	HBL1381	HBL1385	—
	Ivory	HBL1381I	HBL1385I	—
	White	—	HBL1385W	—

Three Position, Two Circuit, Center OFF, Double Pole, Double Throw

Description	Toggle Color	15A 120/277V AC	20A 120/277V AC	30A 120/277V AC
Nylon toggle, back and side wired.	Brown	HBL1382	HBL1386	HBL1388
	Ivory	HBL1382I	HBL1386I	HBL1388I
Locking.		—	HBL1386L	—
Key for Locking switch.		—	HBL1209	—

Note: Keys are supplied with each locking switch. For extra keys order HBL1209. See page D-15 for accessories and page D-16 for wallplates. See page D-22 for technical information.

HP Conversion Chart

	120V	208V	240V	277V AC
15A	.5HP	1.5HP	2HP	2HP
20A	1HP	2HP	2HP	2HP
30A	2HP	2HP	2HP	2HP

Switches

HBL® Extra Heavy Duty Industrial Series, 15A, 347V AC



Description	Toggle Color	Single Pole	Double Pole	Three Way	Four Way
Nylon toggle, back and side wired.	Brown	HBL18201CN	—	HBL18203CN	—
	Ivory	HBL18201ICN	—	HBL18203ICN	HBL18204ICN
	White	HBL18201WCN	—	HBL18203WCN	—
Locking.		HBL18201LCN	—	HBL18203LCN	—
Key for Locking switch.		HBL1209*			

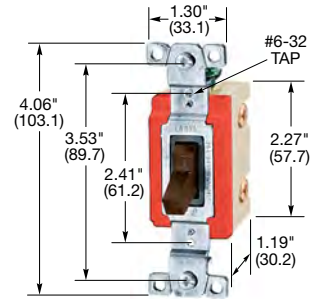

HBL18221CN

20A, 347V AC

Description	Toggle Color	Single Pole	Double Pole	Three Way	Four Way
Nylon toggle, back and side wired.	Brown	HBL18221CN	—	HBL18223CN	—
	Ivory	HBL18221ICN	—	HBL18223ICN	—
	White	HBL18221WCN	—	HBL18223WCN	—

PresSwitch® Specification Grade Push Button, Standard Type 20A, 120/277V AC



Description	Toggle Color	Single Pole	Double Pole	Three Way	Four Way
Nylon actuator, side wired only.	Brown	HBL1281	HBL1282	HBL1283*	HBL1284*
	Ivory	HBL1281I	HBL1282I	HBL1283I*	HBL1284I*

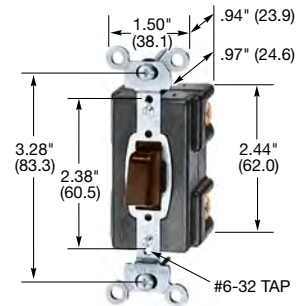

HBL1281

Momentary Type** 20A, 120/277V AC

Description	Toggle Color	Single Pole	Double Pole	Three Way	Four Way
Circuit normally closed, side wired only.	Brown	HBL1281MC*	—	—	—
Circuit normally open, side wired only.	Brown	HBL1281MO*	—	—	—

Illuminated and Pilot Light PresSwitch®, 120V AC Lighted Actuator, Light ON with Load OFF**



Description	Toggle Color	Single Pole	Double Pole	Three Way	Four Way
15A, nylon actuator.	Ivory	—	—	—	HBL1259I*
20A, nylon actuator.	Ivory	HBL1287I	—	HBL1288I*	—

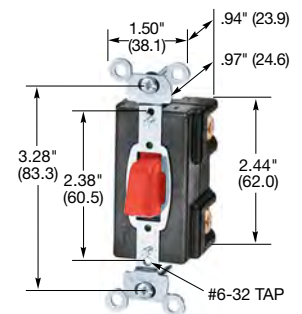

HBL1287

Pilot Light Actuator, Light ON with Load ON, 20A, 120V AC



Description	Toggle Color	Single Pole	Double Pole	Three Way	Four Way
Nylon actuator.	Red	HBL1297	—	HBL1298*	—

Note: Keys are supplied with each locking switch. For extra keys order HBL1209.

*Not UL Listed, CSA Certified.

**Not HP rated.

See page D-15 for accessories and page D-16 for wallplates.

See page D-22 for technical information.

HP Conversion Chart

	120V	208V	240V	277V AC
15A	.5HP	1.5HP	2HP	2HP
20A	1HP	2HP	2HP	2HP
30A	2HP	2HP	2HP	2HP

Dimensions in Inches (mm)

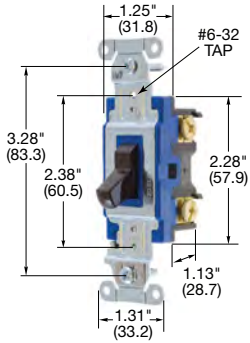

1201BK

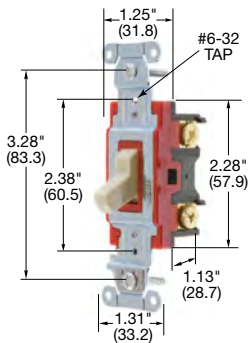

1221I

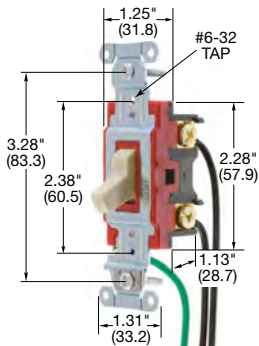

1221PWI

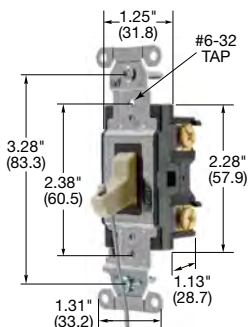

HBL1221IHCS

Dimensions in Inches (mm)

Hubbell-PRO Heavy Duty Industrial Series, 15A, 120/277V AC

Description	Toggle Color	Single Pole	Double Pole	Three Way	Four Way
Toggle, back and side wired.	Black	1201BK	—	1203BK	—
	Brown	1201B	—	1203B	—
	Gray	1201GY	—	1203GY	—
	Ivory	1201I	—	1203I	—
	Light Almond	1201LA	—	1203LA	—
	White	1201W	—	1203W	—

20A, 120/277V AC

Description	Toggle Color	Single Pole	Double Pole	Three Way	Four Way
Toggle, back and side wired.	Black	1221BK	1222BK	1223BK	1224BK
	Brown	1221B	1222B	1223B	1224B
	Gray	1221GY	1222GY	1223GY	1224GY
	Ivory	1221I	1222I	1223I	1224I
	Light Almond	1221LA	1222LA	1223LA	1224LA
	Red	1221R	1222R	1223R	1224R
	White	1221W	1222W	1223W	1224W

Hubbell-PRO Pre-Wired/Leaded Heavy Duty Industrial Series, 20A, 120/277V AC - 8 Inch #12 AWG THHN

Description	Toggle Color	Single Pole	Double Pole	Three Way	Four Way
Toggle, Pre-wired leads.	Black	1221PWBK	1222PWBK	1223PWBK	1224PWBK
	Brown	1221PWB	1222PWB	1223PWB	1224PWB
	Gray	1221PWGY	1222PWGY	1223PWGY	1224PWGY
	Ivory	1221PWI	1222PWI	1223PWI	1224PWI
	Light Almond	1221PWLA	1222PWLA	1223PWLA	1224PWLA
	Red	1221PWR	1222PWR	1223PWR	1224PWR
	White	1221PWW	1222PWW	1223PWW	1224PWW

Hubbell-PRO Hospital Call Switch with Lanyard, 20A, 120/277V AC

Description	Toggle Color	Single Pole	Double Pole	Three Way	Four Way
Toggle, back and side wired.	Gray	HBL1221GHCS	—	—	—
	Ivory	HBL1221IHCS	—	—	—
	White	HBL1221WHCS	—	—	—

Note: See page D-15 for accessories and page D-16 for wallplates.
See page D-22 for technical information.

HP Conversion Chart

	120V	208V	240V	277V AC
15A	.5HP	1.5HP	2HP	2HP
20A	1HP	2HP	2HP	2HP

Switches

Features and Benefits

SNAPConnect® Heavy Duty Toggle and Decorator Series

SNAPConnect® Devices offer superior installation efficiency for new construction and renovations, while delivering safe, reliable connections. Instead of conventional wiring methods, SNAPConnect's modular connector is installed during rough-in in lieu of pigtails. Once the walls are up, the protective covering is removed and the terminal is simply snapped into the SNAPConnect device for a consistent connection every time. Once installed, SNAPConnect's modular design enables simple device change-out by maintenance personnel.

- SNAPConnect® Eliminates Exposed Live Terminals on the Device
- Complete Trim-Out in Less Than One Minute
- Abuse Resistant Nylon Toggle for Heavy Use Applications
- Stainless Steel Autoground
- Large Silver Alloy Contacts Reduce Contact Erosion Providing Long Life
- Many of these Products are Assembled in USA, Please Contact Hubbell with any Certification Requirements



Housing Design

- Thermoplastic top and base material
- Steel, zinc plated bridge is corrosion resistant
- Thread cleaning captive mounting screw



Assembly

- SNAPConnect® eliminates exposed live terminals on the device
- Termination method uses a SNAP-In Connector. Wiring the connector into the wall box can be done prior to trim out; changing or replacing switches is also a "SNAP"



LED Technology

- Pilot and Illuminated versions use LEDs for longer life



Pigtailed Connectors

- Clear right angle terminal, 6 inch leads, solid or stranded wire
 - 3 wire connector for single pole and single pole illuminated
 - 4 wire connector for single pole pilot light switch
 - 4 wire connector for three way and three way illuminated

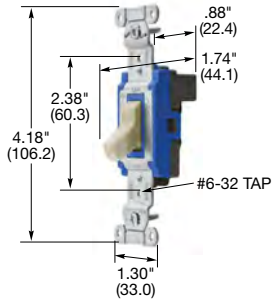

SNAP1201INA

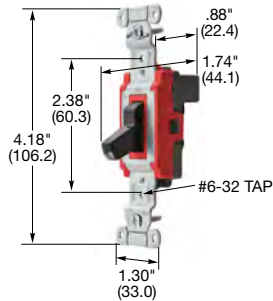

SNAP1221BKNA

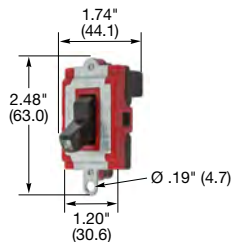

SNAPSWJUMP

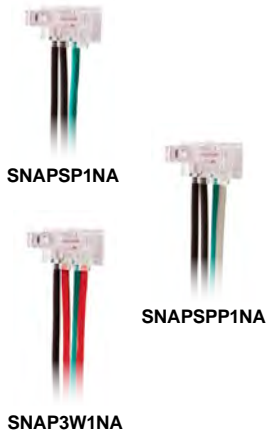

HP Conversion Chart

	120V	208V	240V	277V AC
15A	.5HP	1.5HP	2HP	2HP
20A	1HP	2HP	2HP	2HP

Dimensions in Inches (mm)

SNAPConnect® Specification Grade Toggle Series, 15A, 120/277V AC

Description	Toggle Color	Single Pole	Double Pole	Three Way	Four Way
SNAPConnect® Toggle.	Black	SNAP1201BKNA	—	SNAP1203BKNA	—
	Brown	SNAP1201BRNA	—	SNAP1203BRNA	—
	Gray	SNAP1201GYNA	—	SNAP1203GYNA	—
	Ivory	SNAP1201INA	—	SNAP1203INA	—
	Lt. Almond	SNAP1201LANA	—	SNAP1203LANA	—
	Red	SNAP1201RNA	—	SNAP1203RNA	—
	White	SNAP1201WNA	—	SNAP1203WNA	—

20A, 120/277V AC

Description	Toggle Color	Single Pole	Double Pole	Three Way	Four Way
SNAPConnect® Toggle.	Black	SNAP1221BKNA	—	SNAP1223BKNA	—
	Brown	SNAP1221BRNA	—	SNAP1223BRNA	—
	Gray	SNAP1221GYNA	—	SNAP1223GYNA	—
	Ivory	SNAP1221INA	—	SNAP1223INA	—
	Lt. Almond	SNAP1221LANA	—	SNAP1223LANA	—
	Red	SNAP1221RNA	—	SNAP1223RNA	—
	White	SNAP1221WNA	—	SNAP1223WNA	—

Illuminated, Light ON with Load OFF, 15A, 120/277V AC

Description	Toggle Color	Single Pole	Double Pole	Three Way	Four Way
Illuminated, Light ON with Load OFF, Toggle, Blue LED.	Black	SNAP1201LBKNA	—	SNAP1203LBKNA	—
	Ivory	SNAP1201LINA	—	SNAP1203LINA	—
	Red	SNAP1201LRNA	—	SNAP1203LRNA	—
	White	SNAP1201LWNA	—	SNAP1203LWNA	—

20A, 120/277V AC

Description	Toggle Color	Single Pole	Double Pole	Three Way	Four Way
Illuminated, Light ON with Load OFF, Toggle, Blue LED.	Black	SNAP1221LBKNA	—	SNAP1223LBKNA	—
	Ivory	SNAP1221LINA	—	SNAP1223LINA	—
	Red	SNAP1221LRNA	—	SNAP1223LRNA	—
	White	SNAP1221LWNA	—	SNAP1223LWNA	—

Pilot, Light ON with Load ON, 15A, 120/277V AC

Description	Toggle Color	Single Pole	Double Pole	Three Way	Four Way
Pilot, Light ON with Load ON, Toggle, Red LED.	Black	SNAP1201PLBKNA	—	—	—
	Ivory	SNAP1201PLINA	—	—	—
	Red	SNAP1201PLRNA	—	—	—
	White	SNAP1201PLWNA	—	—	—

20A, 120/277V AC

Description	Toggle Color	Single Pole	Double Pole	Three Way	Four Way
Pilot, Light ON with Load ON, Toggle, Red LED.	Black	SNAP1221PLBKNA	—	—	—
	Ivory	SNAP1221PLINA	—	—	—
	Red	SNAP1221PLRNA	—	—	—
	White	SNAP1221PLWNA	—	—	—

Jumper/Tester

Description	Catalog Number
Jumper/Tester for Single Pole Circuits, Black Toggle, Blue LED Indicator.	SNAPSWJUMP
Jumper/Tester for Three Way Circuits, Black Toggle, Blue LED Indicator.	SNAP3WJUMP

SNAPConnect® Switch Pigtailed Connector

Description	3 Wire Connector for Single Pole and Single Pole Illuminated	4 Wire Connector for Single Pole with Pilot Light	4 Wire Connector for 3 Way and 3 Way Illuminated
Clear right angle terminal, 6 inch leads, solid wire.	SNAPSP1NA	SNAPSP1NA	SNAP3W1NA
Clear right angle terminal, 6 inch leads, stranded wire.	SNAPSP2NA	SNAPSP2NA	SNAP3W2NA

Note: See page D-15 for accessories and page D-16 for wallplates.
See page D-22 for technical information.

Many of these products are Assembled in USA, as indicated, and many are Buy American Compliant. Please contact Hubbell with any certification requirements.

SNAPConnect® Specification Grade Style Line® Decorator Series, 15A, 120/277V AC

Description	Toggle Color	Single Pole	Double Pole	Three Way	Four Way
SNAPConnect® Rocker.	Black	SNAP2101BKNA	—	SNAP2103BKNA	—
	Brown	SNAP2101BRNA	—	SNAP2103BRNA	—
	Gray	SNAP2101GYNA	—	SNAP2103GYNA	—
	Ivory	SNAP2101INA	—	SNAP2103INA	—
	Lt. Almond	SNAP2101LANA	—	SNAP2103LANA	—
	Red	SNAP2101RNA	—	SNAP2103RNA	—
	White	SNAP2101WNA	—	SNAP2103WNA	—

20A, 120/277V AC

Description	Toggle Color	Single Pole	Double Pole	Three Way	Four Way
SNAPConnect® Rocker.	Black	SNAP2121BKNA	—	SNAP2123BKNA	—
	Brown	SNAP2121BRNA	—	SNAP2123BRNA	—
	Gray	SNAP2121GYNA	—	SNAP2123GYNA	—
	Ivory	SNAP2121INA	—	SNAP2123INA	—
	Lt. Almond	SNAP2121LANA	—	SNAP2123LANA	—
	Red	SNAP2121RNA	—	SNAP2123RNA	—
	White	SNAP2121WNA	—	SNAP2123WNA	—

Illuminated, Light ON with Load OFF, 15A, 120/277V AC

Description	Toggle Color	Single Pole	Double Pole	Three Way	Four Way
Illuminated, Light ON with Load OFF, Rocker, Blue LED.	Black	SNAP2101ILBKNA	—	SNAP2103ILBKNA	—
	Ivory	SNAP2101ILINA	—	SNAP2103ILINA	—
	Red	SNAP2101ILRNA	—	SNAP2103ILRNA	—
	White	SNAP2101ILWNA	—	SNAP2103ILWNA	—

20A, 120/277V AC

Description	Toggle Color	Single Pole	Double Pole	Three Way	Four Way
Illuminated, Light ON with Load OFF, Rocker, Blue LED.	Black	SNAP2121ILBKNA	—	SNAP2123ILBKNA	—
	Ivory	SNAP2121ILINA	—	SNAP2123ILINA	—
	Red	SNAP2121ILRNA	—	SNAP2123ILRNA	—
	White	SNAP2121ILWNA	—	SNAP2123ILWNA	—

Pilot, Light ON with Load ON, 15A, 120/277V AC

Description	Toggle Color	Single Pole	Double Pole	Three Way	Four Way
Pilot, Light ON with Load ON, Rocker, Red LED.	Black	SNAP2101PLBKNA	—	—	—
	Ivory	SNAP2101PLINA	—	—	—
	Red	SNAP2101PLRNA	—	—	—
	White	SNAP2101PLWNA	—	—	—

20A, 120/277V AC

Description	Toggle Color	Single Pole	Double Pole	Three Way	Four Way
Pilot, Light ON with Load ON, Rocker, Red LED.	Black	SNAP2121PLBKNA	—	—	—
	Ivory	SNAP2121PLINA	—	—	—
	Red	SNAP2121PLRNA	—	—	—
	White	SNAP2121PLWNA	—	—	—

Jumper/Tester

Description	Catalog Number
Jumper/Tester for Single Pole Circuits, Black Toggle, Blue LED Indicator.	SNAPSWJUMP
Jumper/Tester for Three Way Circuits, Black Toggle, Blue LED Indicator.	SNAP3WJUMP

SNAPConnect® Switch Pigtailed Connector

Description	3 Wire Connector for Single Pole and Single Pole Illuminated	4 Wire Connector for Single Pole with Pilot Light	4 Wire Connector for 3 Way and 3 Way Illuminated
Clear right angle terminal, 6 inch leads, solid wire.	SNAPSP1NA	SNAPSP1NA	SNAP3W1NA
Clear right angle terminal, 6 inch leads, stranded wire.	SNAPSP2NA	SNAPSP2NA	SNAP3W2NA

Note: See page D-15 for accessories and page D-16 for wallplates.
See page D-22 for technical information.

Many of these products are Assembled in USA, as indicated, and many are Buy American Compliant. Please contact Hubbell with any certification requirements.

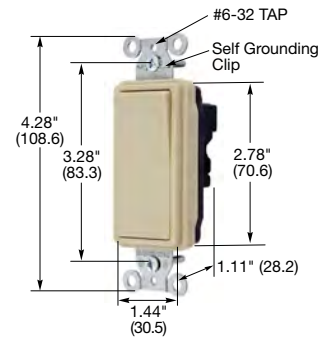

SNAP2101INA

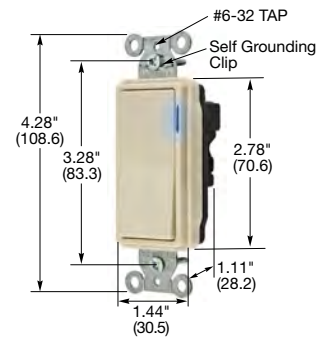

SNAP2121ILINA

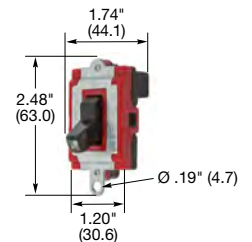

SNAPSWJUMP



HP Conversion Chart

	120V	208V	240V	277V AC
15A	.5HP	1.5HP	2HP	2HP
20A	1HP	2HP	2HP	2HP

Dimensions in Inches (mm)

Switches

Features and Benefits

EdgeConnect™

Hubbell's innovative, patented EdgeConnect™ devices with screwless terminations are the fastest termination devices on the market. Strong steel springs continuously apply pressure to wires, ensuring a strong connection in the most abusive environments.

Designed with easy termination access in the back of the device with laser etched terminal markings for clear identification of correct wiring.

Funneled wire entry to direct conductor strands as well as molded in leverage points for easy unwiring.



The terminations are tight from day one and stay tight, gripping hard to keep the power flowing even through high vibration environments that can steadily work wires loose and cause unscheduled downtime.

Similar performance is also demonstrated in the face of related industrial threats such as temperature cycling and strand relaxation. No matter what the environment, with EdgeConnect™ devices you won't have to go back and retighten—just install once and you're all set.

Wires secured with Hubbell's EdgeConnect™ screwless termination devices not only stay tight, they actually dig in and get tighter in the face of the relentless vibration from industrial equipment which constantly threatens the integrity of traditional connections.

IT'S ABOUT **PERFORMANCE**



Speed

80% faster terminations



Durability

Built to withstand the industry's harshest environments



Performance

Terminations are 25-60% stronger when subjected to vibration



Patented

The only screwless termination in an industrial NEMA wiring device

Dimensions in Inches (mm)

EdgeConnect™ HBL® Extra Heavy Duty Industrial Series, 15A, 120/277V AC

Description	Toggle Color	Single Pole	Three Way
Toggle, Spring Termination.	Black	HBL1201STBK	HBL1203STBK
	Brown	HBL1201ST	HBL1203ST
	Gray	HBL1201STGY	HBL1203STGY
	Ivory	HBL1201STI	HBL1203STI
	Light Almond	HBL1201STLA	HBL1203STLA
	Red	HBL1201STR	HBL1203STR
	White	HBL1201STW	HBL1203STW

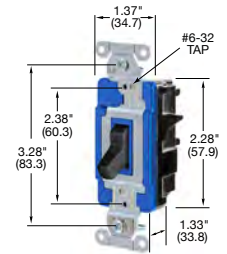

HBL1201STBK

20A, 120/277V AC

Description	Toggle Color	Single Pole	Three Way
Toggle, Spring Termination.	Black	HBL1221STBK	HBL1223STBK
	Brown	HBL1221ST	HBL1223ST
	Gray	HBL1221STGY	HBL1223STGY
	Ivory	HBL1221STI	HBL1223STI
	Light Almond	HBL1221STLA	HBL1223STLA
	Red	HBL1221STR	HBL1223STR
	White	HBL1221STW	HBL1223STW

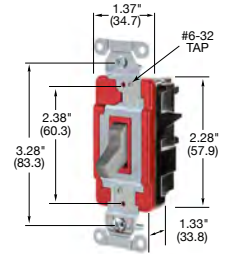

HBL1223STGY

EdgeConnect™ HBL® Extra Heavy Duty Industrial Series, Illuminated Toggle Switches, Light ON with Load OFF, 15A, 120/277V AC

Description	Toggle Color	Single Pole	Three Way
Nylon toggle, Spring Termination.	Black	HBL1201STILBK	HBL1203STILBK
	Brown	HBL1201STIL	HBL1203STIL
	Gray	HBL1201STILGY	HBL1203STILGY
	Ivory	HBL1201STILI	HBL1203STILI
	Light Almond	HBL1201STILLA	HBL1203STILLA
	Red	HBL1201STILR	HBL1203STILR
	White	HBL1201STILW	HBL1203STILW
	Clear	HBL1201STILC	HBL1203STILC

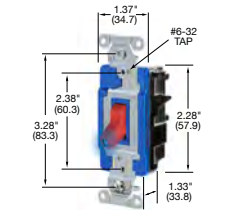

HBL1201STILR

20A, 120/277V AC

Description	Toggle Color	Single Pole	Three Way
Nylon toggle, Spring Termination.	Black	HBL1221STILBK	HBL1223STILBK
	Brown	HBL1221STIL	HBL1223STIL
	Gray	HBL1221STILGY	HBL1223STILGY
	Ivory	HBL1221STILI	HBL1223STILI
	Light Almond	HBL1221STILLA	HBL1223STILLA
	Red	HBL1221STILR	HBL1223STILR
	White	HBL1221STILW	HBL1223STILW
	Clear	HBL1221STILC	HBL1223STILC

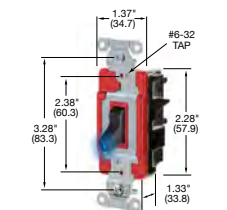

HBL1223STILBK

EdgeConnect™ Toggle Specification Grade Commercial Series, 15A, 120/277V AC

Description	Toggle Color	Single Pole	Three Way
Toggle, Spring Termination.	Black	CSB115STBK	CSB315STBK
	Brown	CSB115ST	CSB315ST
	Gray	CSB115STGY	CSB315STGY
	Ivory	CSB115STI	CSB315STI
	Light Almond	CSB115STLA	CSB315STLA
	Red	CSB115STR	CSB315STR
	White	CSB115STW	CSB315STW

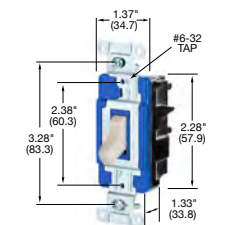

CSB115STLA

Dimensions in Inches (mm)

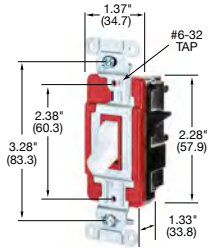

CSB120STW

20A, 120/277V AC

Description	Toggle Color	Single Pole	Three Way
Toggle, Spring Termination.	Black	CSB120STBK	CSB320STBK
	Brown	CSB120ST	CSB320ST
	Gray	CSB120STGY	CSB320STGY
	Ivory	CSB120STI	CSB320STI
	Light Almond	CSB120STLA	CSB320STLA
	Red	CSB120STR	CSB320STR
	White	CSB120STW	CSB320STW

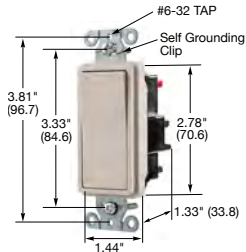

DS115STLA

EdgeConnect™ Style Line® Decorator Specification Grade Commercial Series, 15A, 120/277V AC

Description	Toggle Color	Single Pole	Three Way
Nylon toggle, Spring Termination.	Black	DS115STBK	DS315STBK
	Brown	DS115ST	DS315ST
	Gray	DS115STGY	DS315STGY
	Ivory	DS115STI	DS315STI
	Light Almond	DS115STLA	DS315STLA
	Red	DS115STR	DS315STR
	White	DS115STW	DS315STW

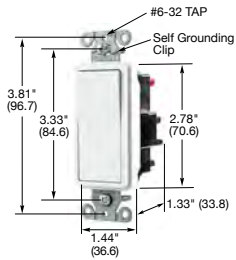

DS320STW

20A, 120/277V AC

Description	Toggle Color	Single Pole	Three Way
Rocker, Spring Termination.	Black	DS120STBK	DS320STBK
	Brown	DS120ST	DS320ST
	Gray	DS120STGY	DS320STGY
	Ivory	DS120STI	DS320STI
	Light Almond	DS120STLA	DS320STLA
	Red	DS120STR	DS320STR
	White	DS120STW	DS320STW



DS320STILBK

EdgeConnect™ Style Line® Decorator Specification Grade Commercial Series, Illuminated, Light ON with Load OFF 20A, 120/277V AC

Description	Toggle Color	Single Pole	Three Way
Rocker, with Blue LED, Spring Termination.	Black	DS120STILBK	DS320STILBK
	Brown	DS120STIL	DS320STIL
	Gray	DS120STILGY	DS320STILGY
	Ivory	DS120STILI	DS320STILI
	Light Almond	DS120STILLA	DS320STILLA
	Red	DS120STILR	DS320STILR
	White	DS120STILW	DS320STILW

Dimensions in Inches (mm)

Features and Benefits

Specification Grade Commercial Series

Toggle, rocker and specialty switches - Hubbell designs and manufactures these switches in a wide variety of styles and colors.

- 15 and 20 Amp 120/277V AC
- Single Pole, Double Pole, 3-Way and 4-Way
- Illuminated and Pilot with LED
- Night Light
- Style Line® Decorator
- Low voltage DC offering



Housing Design

- Engineered thermoplastic housing is impact-resistant for heavy-duty commercial environments
- Stainless steel automatic grounding staple assures grounding continuity between mounting strap and metal wall box



Wiring Design

- Back wire entrance points for terminations accept two wires for feed through capability avoiding pigtail
- Large brass binding head screws with deep slots secure wire connections
- Strip gauge for accurate wiring



Bridge Design

- One-piece bridge with integral grounding terminal with #8 brass screw allows compliance to NEC®
- Steel zinc plated mounting strap provides protection against corrosion
- Thread cleaning captive mounting screw

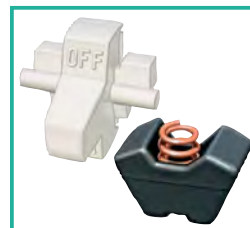

Toggle

- Heavy duty nylon toggle resists abuse and chemical attack making it suitable for use in the toughest environments
- Elastomer rocker assures quiet operation and precise timing
- Permanently lubricated assembly provides long life and trouble free operation



Identification

- Prominent amperage marking on mounting strap allows easy identification of rating



Contacts

- Copper alloy spring contact arm and terminal plate assures proper contact alignment reducing heat rise
- Silver alloy contacts reduce contact erosion and prevent welding, providing long life

NEC® is a registered trademark of the National Fire Protection Association (NFPA).

Toggle Specification Grade Commercial Series, 15A, 120/277V AC

Description	Toggle Color	Single Pole	Double Pole	Three Way	Four Way
Toggle, back and side wired.	Black	CSB115BK	CSB215BK	CSB315BK	CSB415BK
	Brown	CSB115	CSB215	CSB315	CSB415
	Gray	CSB115GY	CSB215GY	CSB315GY	CSB415GY
	Ivory	CSB115I	CSB215I	CSB315I	CSB415I
	Light Almond	CSB115LA	CSB215LA	CSB315LA	CSB415LA
	White	CSB115W	CSB215W	CSB315W	CSB415W

20A, 120/277V AC

Description	Toggle Color	Single Pole	Double Pole	Three Way	Four Way
Toggle, back and side wired.	Black	CSB120BK	CSB220BK	CSB320BK	CSB420BK
	Brown	CSB120	CSB220	CSB320	CSB420
	Gray	CSB120GY	CSB220GY	CSB320GY	CSB420GY
	Ivory	CSB120I	CSB220I	CSB320I	CSB420I
	Light Almond	CSB120LA	CSB220LA	CSB320LA	CSB420LA
	Red	CSB120R	CSB220R	CSB320R	CSB420R
	White	CSB120W	CSB220W	CSB320W	CSB420W

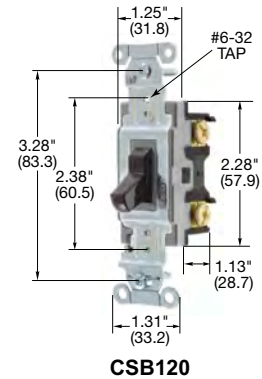

Toggle Specification Grade Commercial Series, 15A, 120/277V AC

Description	Toggle Color	Single Pole	Double Pole	Three Way	Four Way
Toggle, side wired only.	Black	CS115BK	—	CS315BK	—
	Brown	CS115	—	CS315	—
	Gray	CS115GY	—	CS315GY	—
	Ivory	CS115I	—	CS315I	—
	Light Almond	CS115LA	—	CS315LA	—
	White	CS115W	—	CS315W	—

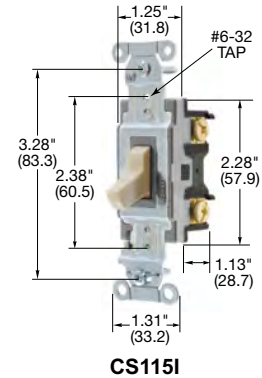

20A, 120/277V AC

Description	Toggle Color	Single Pole	Double Pole	Three Way	Four Way
Toggle, side wired only.	Black	CS120BK	—	CS320BK	—
	Brown	CS120	—	CS320	—
	Gray	CS120GY	—	CS320GY	—
	Ivory	CS120I	—	CS320I	—
	Light Almond	CS120LA	—	CS320LA	—
	White	CS120W	—	CS320W	—

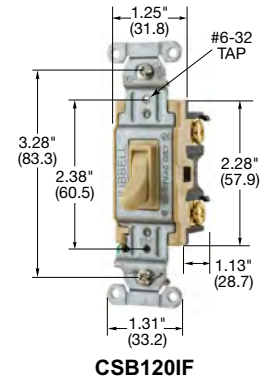

Framed Toggle Specification Grade Commercial Series, 20A, 120V AC

Description	Toggle Color	Single Pole	Double Pole	Three Way	Four Way
Nylon toggle, back and side wired.	Ivory	CSB120IF	—	CSB320IF	—
	Light Almond	CSB120LAF	—	CSB320LAF	—
	White	CSB120WF	—	CSB320WF	—

Note: See page D-13 for pre-wired/leaded devices.
See page D-15 for accessories and page D-16 for wallplates.
See page D-22 for technical information.

HP Conversion Chart

	120V	208V	240V	277V AC
15A	.5HP	1.5HP	2HP	2HP
20A	1HP	2HP	2HP	2HP

Dimensions in Inches (mm)



**Pre-Wired/Leaded Toggle Spec. Grade Commercial Series,
15A, 120/277V AC - 8" #12 AWG THHN**

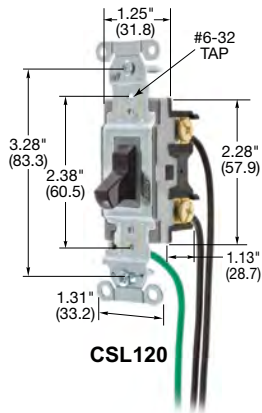

CSL120

Description	Toggle Color	Single Pole	Double Pole	Three Way	Four Way
Toggle, Nylon, Pre-wired leads.	Black	CSL115BK	CSL215BK	CSL315BK	CSL415BK
	Brown	CSL115	CSL215	CSL315	CSL415
	Gray	CSL115GY	CSL215GY	CSL315GY	CSL415GY
	Ivory	CSL115I	CSL215I	CSL315I	CSL415I
	Light Almond	CSL115LA	CSL215LA	CSL315LA	CSL415LA
	White	CSL115W	CSL215W	CSL315W	CSL415W

20A, 120/277V AC

Description	Toggle Color	Single Pole	Double Pole	Three Way	Four Way
Toggle, Nylon, Pre-wired leads.	Black	CSL120BK	CSL220BK	CSL320BK	CSL420BK
	Brown	CSL120	CSL220	CSL320	CSL420
	Gray	CSL120GY	CSL220GY	CSL320GY	CSL420GY
	Ivory	CSL120I	CSL220I	CSL320I	CSL420I
	Light Almond	CSL120LA	CSL220LA	CSL320LA	CSL420LA
	Red	CSL120R	CSL220R	CSL320R	CSL420R
	White	CSL120W	CSL220W	CSL320W	CSL420W

**Pre-Wired/Leaded Decorator Spec. Grade Commercial Series,
15A, 120/277V AC - 8" #12 AWG THHN**

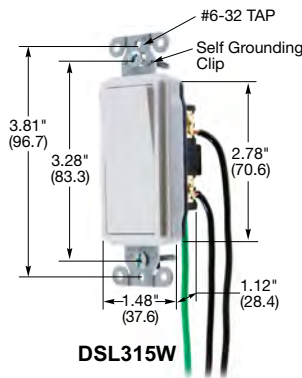

DSL315W

Description	Rocker Color	Single Pole	Double Pole	Three Way	Four Way
Rocker, Polycarbonate, Pre-wired leads.	Black	DSL115BK	—	DSL315BK	—
	Brown	DSL115	—	DSL315	—
	Gray	DSL115GY	—	DSL315GY	—
	Ivory	DSL115I	—	DSL315I	—
	Light Almond	DSL115LA	—	DSL315LA	—
	White	DSL115W	—	DSL315W	—

20A, 120/277V AC

Description	Rocker Color	Single Pole	Double Pole	Three Way	Four Way
Rocker, Polycarbonate, Pre-wired leads.	Black	DSL120BK	DSL220BK	DSL320BK	DSL420BK
	Brown	DSL120	DSL220	DSL320	DSL420
	Gray	DSL120GY	DSL220GY	DSL320GY	DSL420GY
	Ivory	DSL120I	DSL220I	DSL320I	DSL420I
	Light Almond	DSL120LA	DSL220LA	DSL320LA	DSL420LA
	White	DSL120W	DSL220W	DSL320W	DSL420W

Note: See page D-15 for accessories and page D-16 for wallplates.
See page D-22 for technical information.

**Style Line® Decorator Specification Grade Commercial Series,
15A, 120/277V AC**

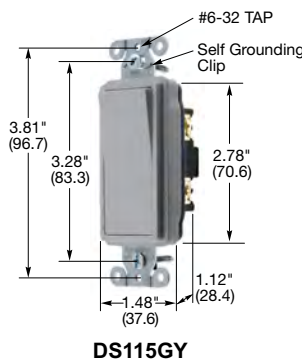

DS115GY

Description	Rocker Color	Single Pole	Double Pole	Three Way	Four Way
Rocker, back and side wired.	Black	DS115BK	—	DS315BK	—
	Brown	DS115	—	DS315	—
	Gray	DS115GY	—	DS315GY	—
	Ivory	DS115I	—	DS315I	—
	Light Almond	DS115LA	—	DS315LA	—
	White	DS115W	—	DS315W	—

20A, 120/277V AC

Description	Rocker Color	Single Pole	Double Pole	Three Way	Four Way
Rocker, back and side wired.	Black	DS120BK	DS220BK	DS320BK	DS420BK
	Brown	DS120	DS220	DS320	DS420
	Gray	DS120GY	DS220GY	DS320GY	DS420GY
	Ivory	DS120I	DS220I	DS320I	DS420I
	Light Almond	DS120LA	DS220LA	DS320LA	DS420LA
	Red	DS120R	DS220R	DS320R	DS420R
	White	DS120W	DS220W	DS320W	DS420W

HP Conversion Chart

	120V	208V	240V	277V AC
15A	.5HP	1.5HP	2HP	2HP
20A	1HP	2HP	2HP	2HP

Dimensions in Inches (mm)

Features and Benefits

Rocker Weatherproof Series

Hubbell designs and manufactures these weatherproof switches for wet and damp applications.

- 20 Amp 120/277V AC
- Single Pole / 3-Way Capable
- NEMA TYPE 3R



Style Line® Decorator Weatherproof Series, 20A, 120/277V AC



Description	Color	Single Pole / Three Way
Rocker, Weatherproof, self-grounding, back and side wired.	Gray	RSD120WPGY
	Light Almond	RSD120WPLA
	White	RSD120WPW

Style Line® Decorator Specification Grade Commercial Series, Illuminated, Light ON with Load OFF 20A, 120/277V AC

Description	Rocker Color	Single Pole	Double Pole	Three Way	Four Way
Rocker, with Blue LED, back and side wired.	Black	DS120ILBK	—	DS320ILBK	—
	Ivory	DS120IL	—	DS320IL	—
	Light Almond	DS120ILLA	—	—	—
	Red	DS120ILR	—	—	—
	White	DS120ILW	—	DS320ILW	—

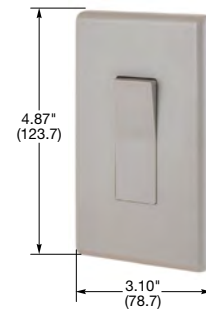

RSD120WPGY

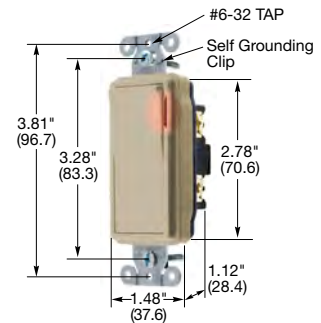

DS120PLI

Style Line® Decorator Specification Grade Commercial Series, Pilot, Light ON with Load ON 20A, 120/277V AC

Description	Rocker Color	Single Pole	Double Pole	Three Way	Four Way
Rocker, with Red LED, back and side wired.	Black	DS120PLBK	—	—	—
	Ivory	DS120PLI	—	—	—
	White	DS120PLW	—	—	—

Note: See page D-12 for pre-wired/leaded devices.
See page D-15 for accessories and page D-16 for wallplates.
See page D-22 for technical information.

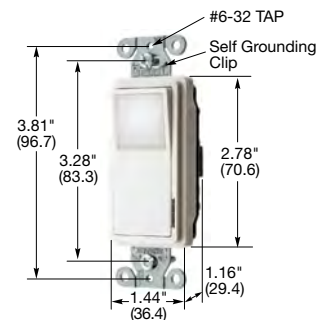

DS120NLWH

Style Line® Decorator Spec. Grade Commercial Series with Nightlight, 20A, 120V AC

Description	Rocker Color	Single Pole	Double Pole	Three Way	Four Way
Rocker, with Nightlight, self-grounding, push, back and side wired.	Black	DS120NLBK	—	—	—
	Brown	DS120NLBR	—	—	—
	Gray	DS120NLGY	—	—	—
	Ivory	DS120NLIV	—	—	—
	Light Almond	DS120NLLA	—	—	—
	White	DS120NLWH	—	—	—

Note: Light glows through the top portion of the rocker when switch is in the OFF position. Does not require a neutral wire.

HP Conversion Chart

	120V	208V	240V	277V AC
15A	.5HP	1.5HP	2HP	2HP
20A	1HP	2HP	2HP	2HP

Dimensions in Inches (mm)

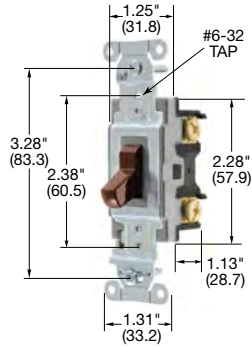

CSB120BRLV

Maintained Contact Toggle, Specification Grade, 5A, 24V DC

Description	Toggle Color	Single Pole	Double Pole	Three Way	Four Way
Nylon toggle, back and side wired.	Black	CSB120BKLV	—	CSB320BKLV	—
	Brown	CSB120BRLV	—	CSB320BRLV	—
	Gray	CSB120GYLV	—	CSB320GYLV	—
	Ivory	CSB120ILV	—	CSB320ILV	—
	Light Almond	CSB120LALV	—	CSB320LALV	—
	Red	CSB120RLV	—	CSB320RLV	—
	White	CSB120WHLV	—	CSB320WHLV	—

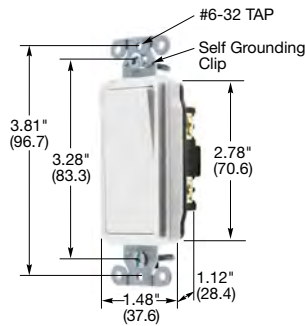

DS120WLV

Maintained Contact Decorator, Specification Grade, 5A, 24V DC

Description	Toggle Color	Single Pole	Double Pole	Three Way	Four Way
Nylon decorator, back and side wired.	Black	DS120BKLV	—	DS320BKLV	—
	Brown	DS120LV	—	DS320LV	—
	Gray	DS120GYLV	—	DS320GYLV	—
	Ivory	DS120ILV	—	DS320ILV	—
	Light Almond	DS120LALV	—	DS320LALV	—
	Red	DS120RLV	—	DS320RLV	—
	White	DS120WLV	—	DS320WLV	—

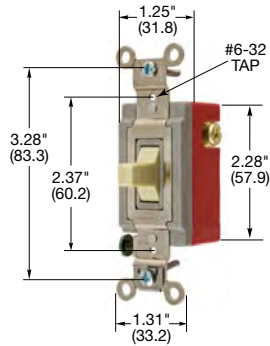

HBL1557ILV

Momentary Contact, Specification Grade, Single Pole, Double Throw, Center OFF 5A, 24V DC

Description	Toggle Color	Single Pole	Double Pole	Three Way	Four Way
Nylon toggle, back and side wired.	Brown	HBL1557LV	—	—	—
	Gray	HBL1557GYLV	—	—	—
	Ivory	HBL1557ILV	—	—	—
	Red	HBL1557RLV	—	—	—
	White	HBL1557WLV	—	—	—

Note: See page D-12 for pre-wired/leaded devices.
See page D-15 for accessories and page D-16 for wallplates.
See page D-22 for technical information.

HP Conversion Chart

	120V	208V	240V	277V AC
15A	.5HP	1.5HP	2HP	2HP
20A	1HP	2HP	2HP	2HP

Switches

Accessories

Pilot Light, 120/277V AC

IP44
SUITABILITY



Description	Catalog Number
Red neon pilot light, back and side wired, fits standard switch wallplate.	HBL1220RJ



HBL1220RJ

Brass Locking Cover Attachment for Switches Available in Master Keying and Straight Keying Systems

Description	Catalog Number
Straight keying (all locks alike). Appropriate for most applications. Straight cylinder type lock, each HBL96061 ordered operates on the same key. All locks are keyed alike.	HBL96061*
Same as above except in dull chrome finish to match stainless steel plates.	HBL96061DCH*
Straight keying (individual). Straight cylinder type lock, each HBL96062 ordered operates on a different key. All locks are keyed differently and individually. This type cannot be master keyed.	HBL96062*

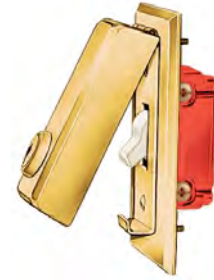

HBL96061

Shown with cover and switch (sold separately)

SWITCHOUT® Lockout Device

Description	Catalog Number
Yellow, nylon toggle switch lockout device (Two devices per package).	HSLDPK2*



Weatherproof Wallplates

Description	Catalog Number
Clear bubble wallplate, silicone rubber for use with all general purpose AC toggle and PresSwitch® switches. Fits both FS/FD and standard boxes.	HBL1795
Cast aluminum lift cover with fiber shield. For standard toggle and PresSwitch® switches. Fits only FS/FD boxes.	HBL7420



HSLDPK2

Weatherproof Wallplates for PresSwitch® Switches



Description	Catalog Number
Gray neoprene PresSwitch® wallplate. Fits FS/FD and standard boxes.	HBL1750
Same as above except yellow.	HBL17CM50
Gray neoprene PresSwitch® wallplate with 125V red pilot light. Fits only FS/FD boxes.	HBL1785
Same as above except yellow.	HBL17CM85

Note: *Not UL Listed or CSA Certified.
Each locking wallplate is supplied with two keys.
See section BB for additional information on safety lockout devices.
See section O for additional wallplates.

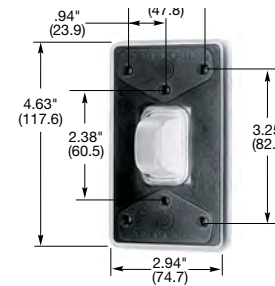

HBL1795



HBL7420

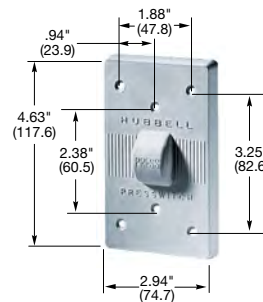

HBL1750

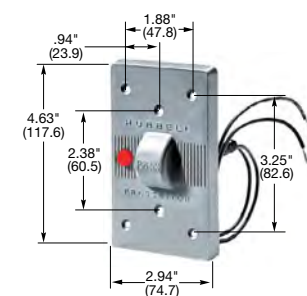

HBL1785

Dimensions in Inches (mm)

Accessories



Toggle Switch Non-metallic Wallplates

Description	Color	1-Gang		2-Gang	
		Standard	Snap-On	Standard	Snap-On
Thermoplastic, standard size, smooth satin finish.	Gray	P1GY	—	P2GY	—
	Ivory	P1I	NPS1I	P2I	NPS2I
	Light Almond	P1LA	NPS1LA	P2LA	NPS2LA
	White	P1W	NPS1W	P2W	NPS2W

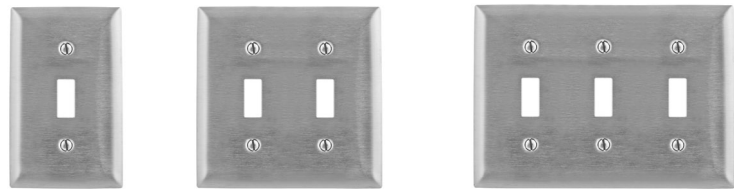

Toggle Switch Metal Wallplates

Description	Color	1-Gang	2-Gang	3-Gang
		Metal, standard size, smooth lacquer finish.	Aluminum Brass Stainless Steel, 302/304 Stainless Steel, 430	SA1 SB1 SS1 SS1L

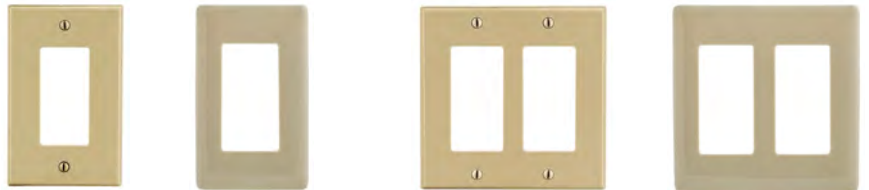

Style Line® Decorator Switch Non-metallic Wallplates

Description	Color	1-Gang		2-Gang	
		Standard	Snap-On	Standard	Snap-On
Thermoplastic, standard size, smooth satin finish.	Gray	P26GY	—	P262GY	—
	Ivory	P26I	NPS26I	P262I	NPS262I
	Light Almond	P26LA	NPS26LA	P262LA	NPS262LA
	White	P26W	NPS26W	P262W	NPS262W

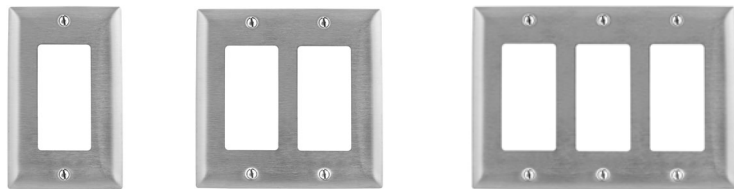

Style Line® Decorator Switch Metal Wallplates

Description	Color	1-Gang	2-Gang	3-Gang
		Metal, standard size, smooth lacquer finish.	Aluminum Brass Stainless Steel, 302/304 Stainless Steel, 430	① SB26 SS26 SS26L

Note: See section O for additional wallplates.

*Brass plated.

① Available as a custom metal wallplate. See wallplate section for additional information.

Switches

Certification Chart

UL, CSA, and Fed. Spec. Listing Data

Catalog Number	WS896 Listed	UL Listed UL20	CSA Certified	Catalog Number	WS896 Listed	UL Listed UL20	CSA Certified
1201	Yes	Yes	Yes	HBL1224	Yes	Yes	Yes
1203	Yes	Yes	Yes	HBL1221L	Yes	Yes	Yes
1221	Yes	Yes	Yes	HBL1222L	Yes	Yes	Yes
1222	Yes	Yes	Yes	HBL1223L	Yes	Yes	Yes
1223	Yes	Yes	Yes	HBL1224L	Yes	Yes	Yes
1224	Yes	Yes	Yes	HBL1221IL	Yes	Yes	Yes
1221PW	Yes	Yes	Yes	HBL1223IL	Yes	Yes	Yes
1222PW	Yes	Yes	Yes	HBL1221PL	Yes	Yes	Yes
1223PW	Yes	Yes	Yes	HBL1222PL	Yes	Yes	Yes
1224PW	Yes	Yes	Yes	HBL1223PL	Yes	Yes	Yes
CS115	Yes	Yes	Yes	HBL1221RKL	No	Yes	Yes
CS315	Yes	Yes	Yes	HBL1222RKL	No	Yes	Yes
CS120	Yes	Yes	Yes	HBL1223RKL	No	Yes	Yes
CS320	Yes	Yes	Yes	HBL1224RKL	No	Yes	Yes
CSB115	Yes	Yes	Yes	HBL1259I	No	No	No
CSB215	Yes	Yes	Yes	HBL1281	No	Yes	Yes
CSB315	Yes	Yes	Yes	HBL1282	No	Yes	Yes
CSB415	Yes	Yes	Yes	HBL1283	No	No	No
CSB120	Yes	Yes	Yes	HBL1284	No	No	No
CSB220	Yes	Yes	Yes	HBL1287I	No	Yes	Yes
CSB320	Yes	Yes	Yes	HBL1288I	No	No	No
CSB420	Yes	Yes	Yes	HBL1281MO	No	No	No
CSL115	Yes	Yes	Yes	HBL1281MC	No	No	No
CSL215	Yes	Yes	Yes	HBL1297	No	Yes	Yes
CSL315	Yes	Yes	Yes	HBL1298	No	No	No
CSL415	Yes	Yes	Yes	HBL1381	No	Yes	Yes
CSL120	Yes	Yes	Yes	HBL1382	No	Yes	Yes
CSL220	Yes	Yes	Yes	HBL1385	No	Yes	Yes
CSL320	Yes	Yes	Yes	HBL1386	No	Yes	Yes
CSL420	Yes	Yes	Yes	HBL1386L	No	Yes	Yes
DS115	No	Yes	Yes	HBL1388	No	Yes	Yes
DS315	No	Yes	Yes	HBL1556	No	Yes	Yes
DS120	No	Yes	Yes	HBL1557	No	Yes	Yes
DS220	No	Yes	Yes	HBL1556L	No	Yes	Yes
DS320	No	Yes	Yes	HBL1557L	No	Yes	Yes
DS420	No	Yes	Yes	HBL3031	Yes	Yes	Yes
DS120IL	No	Yes	Yes	HBL3032	Yes	Yes	Yes
DS320IL	No	Yes	Yes	HBL3033	Yes	Yes	Yes
DS120PL	No	Yes	Yes	HBL3031PL	Yes	Yes	Yes
DSL115	No	Yes	Yes	HBL3031PL	Yes	Yes	Yes
DSL215	No	Yes	Yes	HBL3032PL	Yes	Yes	Yes
DSL315	No	Yes	Yes	SNAP1201	No	Yes	Yes
DSL415	No	Yes	Yes	SNAP1201IL	No	Yes	Yes
DSL120	No	Yes	Yes	SNAP1201PL	No	Yes	Yes
DSL220	No	Yes	Yes	SNAP1203	No	Yes	Yes
DSL320	No	Yes	Yes	SNAP1203IL	No	Yes	Yes
DSL420	No	Yes	Yes	SNAP1221	No	Yes	Yes
HBL1201	Yes	Yes	Yes	SNAP1221IL	No	Yes	Yes
HBL1202	Yes	Yes	Yes	SNAP1221PL	No	Yes	Yes
HBL1203	Yes	Yes	Yes	SNAP1223	No	Yes	Yes
HBL1204	Yes	Yes	Yes	SNAP1223	No	Yes	Yes
HBL1201IL	Yes	Yes	Yes	SNAP1223IL	No	Yes	Yes
HBL1203IL	Yes	Yes	Yes	SNAP2101	No	Yes	Yes
HBL1201PL	Yes	Yes	Yes	SNAP2101IL	No	Yes	Yes
HBL1203PL	Yes	Yes	Yes	SNAP2101PL	No	Yes	Yes
HBL1201L	Yes	Yes	Yes	SNAP2103	No	Yes	Yes
HBL1202L	Yes	Yes	Yes	SNAP2103IL	No	Yes	Yes
HBL1203L	Yes	Yes	Yes	SNAP2121	No	Yes	Yes
HBL1204L	Yes	Yes	Yes	SNAP2121IL	No	Yes	Yes
HBL1221	Yes	Yes	Yes	SNAP2121PL	No	Yes	Yes
HBL1222	Yes	Yes	Yes	SNAP2123	No	Yes	Yes
HBL1223	Yes	Yes	Yes	SNAP2123IL	No	Yes	Yes

Note: Catalog numbers above represent all colors and variations.

Switches

Slide and Rotary Control Dimmers

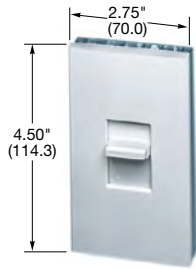

AS103
1000W Dimmer
Fits Single-Gang Wall Boxes

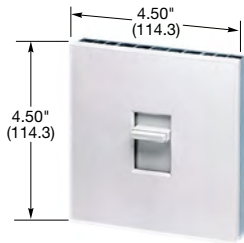

AS203
2000W Dimmer
Fits Single-Gang Wall Boxes

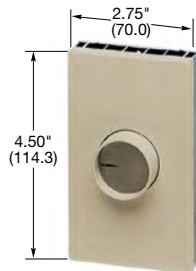

AR101
1000W Dimmer
Fits Single-Gang Wall Boxes

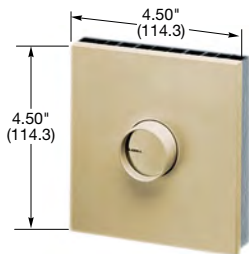

AR201
2000W Dimmer
Fits Single-Gang Wall Boxes

Architectural Grade, Incandescent Preset Slide Control Dimmers

Description	Color	Rating	Catalog Number
Single pole/three way - preset.	White	1000W, 120V AC, 60Hz	AS103
Single pole/three way - preset.	White	2000W, 120V AC, 60Hz	AS203

Accessories

Description	Color	Catalog Number
Small wallplate kit for 600W and 1000W models.	Ivory	AS11
Includes non-metallic trimplate and slide.	White	AS1W
Large wallplate kit for 1500W and 2000W models.	Ivory	AS21
Includes non-metallic trimplate and slide.	White	AS2W

Note: The dimmers listed above can be wired for single pole or three way applications.
See page D-19 for ganging and derating.

Architectural Grade, Incandescent Rotary Control Dimmers

Description	Color	Rating	Catalog Number
Single pole - push ON/OFF.	Beige	1000W, 120V AC, 60Hz	AR101
Three way - push ON/OFF.	Beige		AR103
Single pole, rotary ON/OFF.	Beige	2000W, 120V AC, 60Hz	AR201

Accessories

Description	Color	Catalog Number
Small wallplate kit for 600W and 1000W models.	Beige	AR1BE
Includes non-metallic trimplate and knob.	White	AR1W
Large wallplate kit for 1500W and 2000W models.	Beige	AR2BE
Includes non-metallic trimplate and knob.	White	AR2W

Note: See page D-19 for ganging and derating.

Switches

Dimmer Ganging and Derating

Architectural Grade Slide and Rotary Series Number of Switchboxes Required with Dimmer Side Sections Intact

	Number of Large Controls (1500W and 2000W)	Number of Small Controls (600W and 1000W)						
		0	1	2	3	4	5	6
0	0	0	1	1+1	4	1+4	7	1+7
1	1	1	3	5	6	8	9	11
2	2	4	6	7	9	10	12	13
3	3	6	8	10	11	13	14	16
4	4	9	11	12	14	15	17	18

Number of Gangs Required

Note: When ganging an even number of small controls with no side sections removed (plus numbers in chart), use gangable switchboxes with tapped ears as shown below. Do not use plaster rings or gangbox covers. Space an additional switchbox 3/4 in. apart from the other switchbox(es). A 3/4 in. close nipple is recommended as a spacer between the switchboxes.

Example of 4-Gang Installation

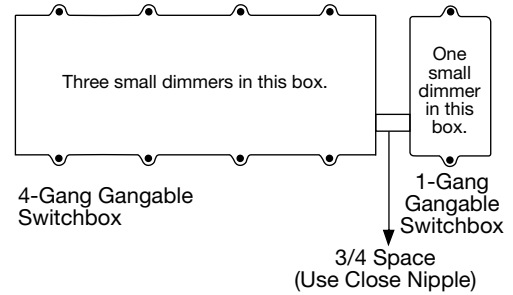

Number of Switchboxes Required with Side Sections Removed

	Number of Large Controls (1500W and 2000W)	Number of Small Controls (600W and 1000W)						
		0	1	2	3	4	5	6
0	0	0	1	2	3	4	5	6
1	1	1	3	4	5	6	7	8
2	2	3	5	6	7	8	9	10
3	3	5	7	8	9	10	11	12
4	4	7	9	10	11	12	13	14

Number of Gangs Required

Note: When removing side sections, remove only inner side sections. Do not remove side sections on outer ends of gang. The same installation rules apply to rotary dimmers (not shown).

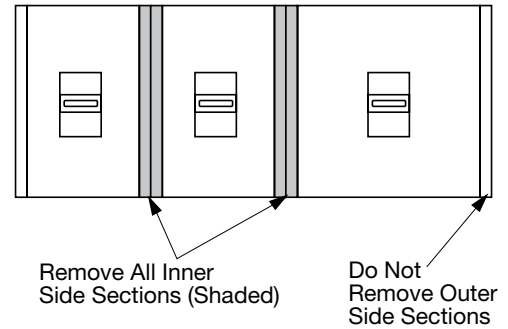

Derating Chart

No Side Sections Removed	One Side Section Removed	Both Side Sections Removed
600W	600W	500W
1000W	900W	700W
1500W	1250W	1000W
2000W	1800W	1500W

Note: When ganging any combination of small and large controls, place a small control on one extreme end of the gang, and a large control at the other end of the gang. When ganging with side sections intact, use offset mounting holes. When ganging with side sections removed, use center mounting holes. Allow a 1/8 in. gap (space) between controls for ease in attaching the faceplate.

Specification Grade Slide and Rotary Series Switchboxes Required: Side Sections Removed

Derating Chart

1 Dimmer In Wall Box	2 Dimmers In Wall Box	3 Or More Dimmers In Wall Box
600W	500W	400W
1000W	800W	650W
5A fan speed	4A fan speed	3A fan speed

Heavy Duty Panel Mount



HBL11



HBL123SP

10A 250V AC 20A 125V AC Horsepower Rated 3/4 HP, 125-250V AC

Description		Terminal	Catalog Number
Single pole/ single throw.		Screw Spade	HBL11 HBL11SP
Single pole/ single throw momentary.		Screw Spade	HBL11M HBL11SPM
Single pole/ double throw.		Screw Spade	HBL12 HBL12SP
Single pole/ double throw 3-position center OFF.		Screw Spade	HBL123 HBL123SP
Single pole/ double throw 3-position center OFF momentary.		Screw Spade	HBL123MM HBL123SPMM

Note: All threaded stems 1/32 in.-32 thread.

10A 240V AC 15A 120V AC

Description		Terminal	Catalog Number
Single pole/ single throw.		Screw	HBL118

Note: 1/32 in.-32 thread.

4A 250V 8A 125V 10A 120V AC 1/3 HP 120V AC

Description		Terminal	Catalog Number
Single pole/ single throw.		#18 Std. AWG Copper Wire Leads 105° C Black.	HBL11WL

Note: 1/32 in.-32 thread, keyway .080 x .035.

Specifications

- Impact Resistant Thermoplastic Body.
- Fine Silver Contacts.
- Knurled Nut, Hex Nut And Strap All Nickel Plated.
- Keyed Brass Bushing Nickel Plated.
- Brass Toggle Nickel Plated.
- Choice of Terminal Design: .250 in. (6.3) Male Tab Spade Type or 6/32 Screw Type.
- UL Recognized.

Dimensions in Inches (mm)

Heavy Duty Panel Mount

10A 250V AC 20A 125V AC Horsepower Rated 1½ HP, 125-250V AC

Description	Terminal	Catalog Number
Double pole/ single throw.	Screw Spade	HBL21 HBL21SP
Double pole/ single throw.	Screw Spade	HBL22 HBL22SP
Double pole/ double throw 3-position center OFF.	Screw Spade	HBL223 HBL223SP
Double pole/ double throw 3-position center OFF momentary.	Screw Spade	HBL223MM HBL223SPMM
Silicone rubber boot.	Screw Spade	SSB1

Note: All threaded stems 1/32 in.-32 thread.
See AA-35 for additional information on 12V DC tapered handle switches.



HBL21



HBL223



SSB1

4A 250V 8A 125V 10A 120V AC 1/3 HP 120V AC

Description	Terminal	Catalog Number
Single pole/ single throw.	#18 Std. AWG Copper Wire Leads 105° C Black.	HBL11PBWL

Note: 1/32 in.-32 thread, keyway .080 x .035.



HBL11PBWL

Dimensions in Inches (mm)

Standard Toggle Type Switches

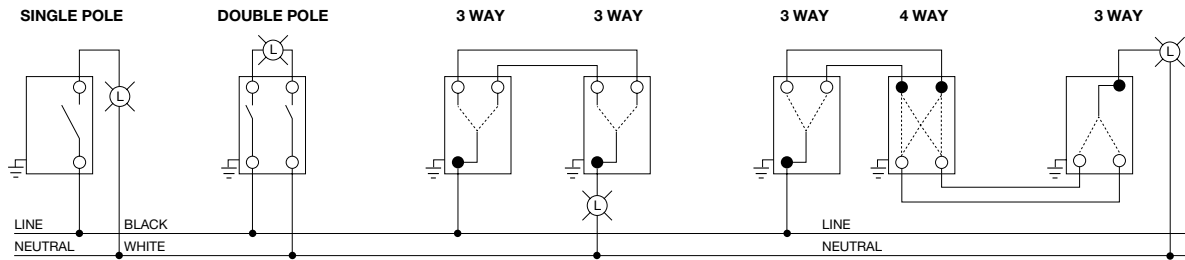

Illuminated Switches (light ON with load OFF)

Pilot Light Switches (light ON with load ON)

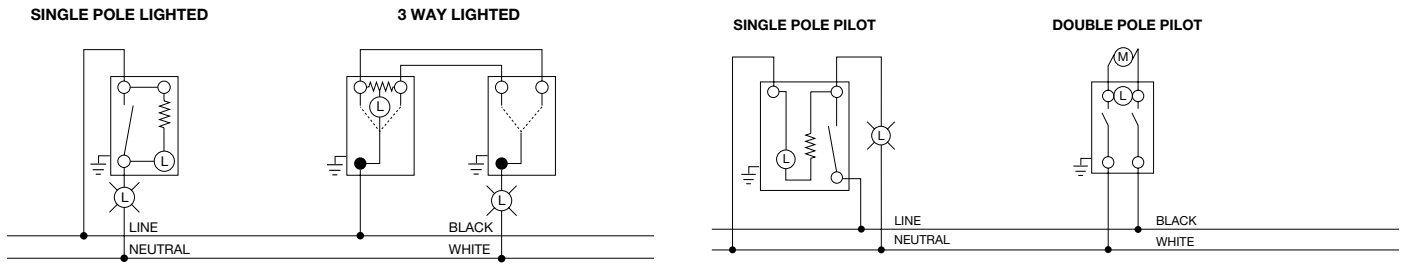

Three Way Pilot Switches

Three Position Switches, Momentary and Maintained

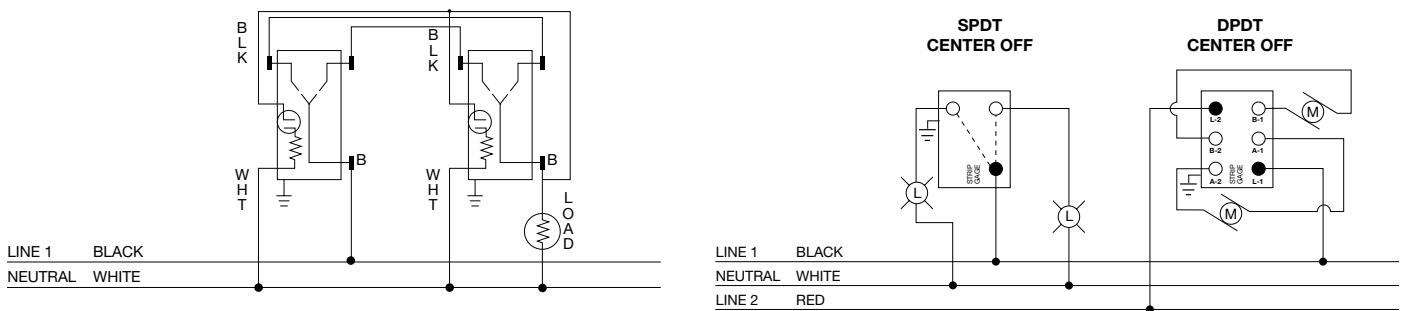

Specifications - HBL® Extra Heavy Duty Industrial Grade Switches (SP, DP, 3-Way, 4-Way)

Listings	Component	Material
UL Listed	Base	Thermoset, Color Coded by Amperage
CSA Certified	Top	Thermoset, Gray
Verified to Fed. Spec. W-S-896,	Toggle	Nylon
SP, DP, 3-way and 4-way	Terminals	Brass
	Terminal Screws	Brass
	Mounting Bridge	Nickel Plated Steel
	Contacts	Silver Alloy
	Moveable Contact Arm	Brass
	Rocker	Elastomer
	Ground Terminal	Nickel-Plated Steel
	Ground Screw	Brass
	Automatic Grounding Clip	Stainless Steel

Performance Data

Electrical	
Dielectric Voltage	Withstands 1500V AC minimum for 1 minute
Max. Working Voltage	277V AC
Overload	Minimum 4.8 times rated current for 100 cycles
Temperature Rise	30°C maximum at rated current
Max. Continuous Current	15A, 20A, 30A
Endurance	50,000 cycles min., tungsten filament lamp load Fed. Spec. #WS896, SP, DP, 3-way and 4-way
Mechanical	
Terminal Accommodations	#14 AWG min. - #10 AWG max. solid and stranded copper wire only
Environmental	
Flammability	UL 94V-2
Operating Temperature	Max. continuous: 75°C; Min. continuous: -40°C without impact

SECTION E

Table of Contents



Wall Switch Sensors



MAXX™ Harsh Environment Occupancy Sensors



WL-Series Wireless Sensors and Controls



Product	Page
Hubbell Energy Efficiency Solutions	
Energy Consumption and Standards Compliance	E-2
The Right Technology for the Right Application	E-3
Space Control - Wall Switch Sensors	
Adaptive Technology	E-5
Passive Infrared and Digital Timers	E-6
Ceiling, Wall and End Mount High/Low Bay Sensors	
Low Voltage and Line Voltage Ceiling Sensors	E-8
Low Voltage Switches and Control Units	E-8
Daylight Harvesting and Dimming Controls	E-10
Extreme Temperatures Sensors and OPTIMYZER® Watertight End Mount PIR Sensor	
Extreme Temperature PIR Ceiling Sensor	E-11
OPTIMYZER® Watertight End Mount PIR Sensor	E-11

Product	Page
Automatic Receptacle Control Solutions	
Wired and Wireless Methodologies	E-13
Energy Codes and Standards	E-13
Wired Switched Receptacles and Control Units	E-13
Wireless Switched Receptacles and Control Units	E-13
Specifications, Coverage Patterns and Wiring Schematics	E-21

Energy Consumption and Standards Compliance

Electricity consumption in commercial buildings has changed dramatically over the past decade. Energy efficient lighting sources like LEDs have reduced their contribution on a commercial building's total electricity consumption from 40% to approximately 17%. Today plug and process loads consume up to 30% of a typical commercial building's energy costs. Energy Efficiency Codes & Standards are becoming more stringent in an effort to reduce energy consumption in all areas of commercial buildings.

Hubbell Load:Logic® series of control devices offers a broad range of space, centralized and distributed controls that meet the latest codes and standards and qualify for LEED certification points. Hubbell devices feature ease of installation, setup, operation and commissioning process. The result is an "install-and-forget" experience.

Additional features include:

- Occupancy or time-based controls
- Manual ON mode requires user operation to turn lights ON but automatically turns lights OFF when a space is unoccupied after a specified period of time
- Daylight Harvesting sensors for dimming or to keep the lights OFF when natural light is sensed
- Automatic receptacle control

Commercial Buildings Electricity Consumption

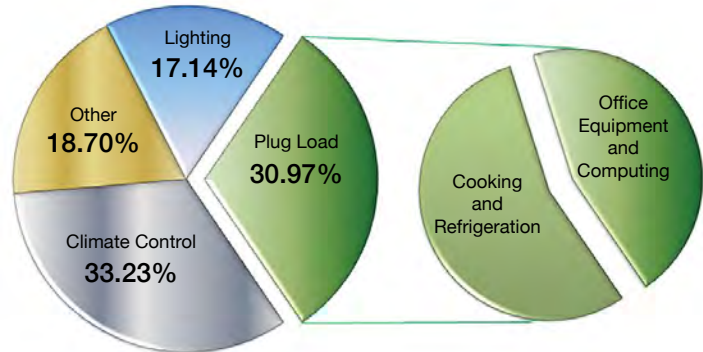

Electrical bill impact for a typical office building



Adaptive Technology Provides Better Control

Hubbell's patented breakthrough in advanced control feature smart microprocessors constantly monitoring the controlled area and adjust the sensitivity and timer based on environmental history.

- Lower energy costs and utility bills
- No need to manually adjust for occupancy changes

Backed by Hubbell Service and Support

Hubbell Energy Efficiency Solutions focuses on environmental stewardship, innovative products and efficient building operations. Hubbell also offers superior service and support with:

- Detailed online e-learning courses
- Product selection guide to assist in choosing the right technology
- Online specification assistance
- Highly knowledgeable network of trained professionals and staff
- BIM models and 3D coverage patterns



Energy Efficiency Solutions

The Right Technology for the Right Application

Passive Infrared (PIR)



Requires a clear, unobstructed line of sight for detection, because it senses occupancy as movement of heat emitted from the body against the background space. A segmented Fresnel lens divides the coverage area into zones. Movement across zones is interpreted as occupancy.

Ultrasonic (US)



Senses occupancy by emitting an ultrasonic high-frequency sound wave (32 kHz to 45 kHz), sensing the frequency of the reflected signal, and then determining occupancy based on a change in frequency. While this has a limited range, it detects small motions and does not require a clear line of sight.

Dual Technology

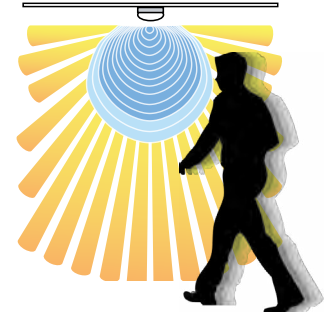

Combines PIR and US technology, minimizing the risk of lights turning ON when the space is unoccupied. Once occupancy is detected by both technologies within the space lights are turned ON, only one technology is necessary to keep the lights ON.



Features and Benefits

Adaptive Dual (Ultrasonic and Passive Infrared)

Combines PIR and US technology, minimizing the risk of lights turning ON when the space is unoccupied. Once occupancy is detected by both technologies within the space lights are turned ON, only one technology is necessary to keep the lights ON.

Adaptive technology provides better control. Hubbell's patented breakthrough in advanced control feature smart microprocessors constantly monitoring the controlled area and adjust the sensitivity and timer based on environmental history.

The optimum choice when performance is paramount.

Standard Passive Infrared

Requires a clear, unobstructed line of sight for detection, because it senses occupancy as movement of heat emitted from the body against the background space. A segmented Fresnel lens divides a coverage area into zones. Movement across zones is interpreted as occupancy.

Excellent for small room control.



Adaptive Series



Housing Design

- Steel mounting strap
- High impact molded plastics
- Color matching tamper resistant lens



Coverage and Electrical Ratings

- Dual technology - 1,000 sq. ft. Ultrasonic only - 400 sq. ft.
- 120/277V AC 50/60 Hz; no neutral required; 24V DC, 33mA
- Zero-arc point switching
- Compatible with CFL/LED and motor loads



Operation

- Selectable Auto or Manual ON operating modes
- Vacancy only version
- Dual relay version for bi-level switching or lighting/fan control applications
- Photocell for extra energy savings

WS Series



Housing Design

- Plated steel mounting strap
- High Impact molded plastics
- Recessed tamper resistant lens
- Night light option



Coverage and Electrical Ratings

- High density PIR - 1,200 sq. ft.
- WS1000 series - 120V AC 60Hz
- WS2000 series - 120/277V AC 60Hz; multi-way capable
- No neutral required
- Compatible with CFL/LED and motor loads



Operation

- WS2000 series - Selectable Auto or Manual ON operating modes
- Vacancy only version
- Dual relay version for bi-level switching or lighting/fan control applications
- Photocell for extra energy savings

Adaptive Technology Wall Switch Sensors

800W Incandescent/Electronic Ballast, 5A LED, 1/6 HP at 120V AC, 1800W Electronic Ballast, 5A LED, 1/6 HP at 277V AC.

Dual (Ultrasonic and Passive Infrared)

Description	Color	Single Circuit		Dual Circuit	
		1 button	Auto control with no button	2 buttons	Auto control with no button
Selectable Manual/ Auto ON	Ivory	AD2000I1	AD2000I1N	AD2000I22	AD2000I22
	Light Almond	AD2000LA1	AD2000LA1N	AD2000LA22	AD2000LA22
	White	AD2000W1	AD2000W1N	AD2000W22	AD2000W22
Manual ON (Vacancy)	Ivory	AD2001I1	—	AD2001I22	—
	Light Almond	AD2001LA1	—	AS2001LA22	—
	White	AD2001W1	—	AD2001W22	—
Selectable Manual/Auto ON with neutral wire	Ivory	ADN2000I1	—	ADN2000I2	—
	White	ADN2000W1	—	ADN2000W2	—



Passive Infrared

Description	Color	Single Circuit		Dual Circuit	
		1 button		2 buttons	
Selectable Manual/ Auto ON.	Ivory	AP2000I1		AP2000I22	
	Light Almond	AP2000LA1		AP2000LA22	
	White	AP2000W1		AP2000W22	
Selectable Manual/ Auto ON with neutral wire	Ivory	APN2000I1		—	
	White	APN2000W1		—	
Manual ON (Vacancy)	Ivory	AP2001I1		AP2001I22	
	Light Almond	AP2001LA1		AP2001LA22	
	White	AP2001W1		AP2001W22	





AD2240W1
AD2241W1

Dual (Ultrasonic and Passive Infrared)

24V DC, 33mA. Requires a CU300xx series control unit.

Description	Color	Single Circuit		Dual Circuit
		1 button		2 buttons
Selectable Manual/ Auto ON.	Ivory	AD2240I1		AD2240I2
	Light Almond	AD2240LA1		AD2240LA2
	White	AD2240W1		AD2240W2
Manual ON (Vacancy).	Ivory	AD2241I1		AD2241I2
	Light Almond	AD2241LA1		AD2241LA2
	White	AD2241W1		AD2241W2

Note: Wallplate sold separately. See page E-23 for technical specifications, coverage patterns and wiring schematics.



WS2000W
WS1000W



WS1020NW
WS1021NW

Passive Infrared

Manual time delay adjustment.

Description	Color	Standard			
		with Nightlight	with Neutral	with Nightlight and Neutral	
Manual adjusting; selectable manual/auto ON operation; dual-voltage 120/277V AC; multi-way capable.	Gray	WS2000GY	WS2000NGY	—	—
	Ivory	WS2000I	WS2000NI	WS2004I	WS2004NI
	Light Almond	WS2000LA	WS2000NLA	—	—
	White	WS2000W	WS2000NW	WS2004W	WS2004NW
Manual adjusting; selectable manual/auto ON operation; 120V AC only.	Ivory	WS1000I	WS1000NI	—	—
	Light Almond	WS1000LA	WS1000NLA	—	—
	White	WS1000W	WS1000NW	—	—
Manual adjusting; manual ON operation; 120V AC only.	Ivory	WS1001I	WS1001NI	—	—
	Light Almond	WS1001LA	WS1001NLA	—	—
	White	WS1001W	WS1001NW	—	—
Manual adjusting; auto ON operation; dual circuit; 120V AC only.	Gray	WS1020GY	WS1020NGY	—	—
	Ivory	WS1020I	WS1020NI	WS1024I	WS1024NI
	Light Almond	WS1020LA	WS1020NLA	WS1024LA	WS1024NLA
	White	WS1020W	WS1020NW	WS1024W	WS1024NW
Manual adjusting; manual ON operation; dual circuit; 120V AC only.	Gray	WS1021GY	WS1021NGY	—	—
	Ivory	WS1021I	WS1021NI	WS1025I	WS1025NI
	Light Almond	WS1021LA	WS1021NLA	WS1025LA	WS1025NLA
	White	WS1021W	WS1021NW	WS1025W	WS1025NW

Note: See page E-24 for technical specifications, coverage patterns and wiring schematics.



DT2000W

Digital Timer

Description	Color	Catalog Number
DIP switch enable preset intervals for 2 and 4 hours. User adjustable up to 24 hours. 3-way capable, 960W @ 120V AC and 1200W @ 277V AC.	White	DT2000W



WSTA120

Programmable Timer

Description	Color	Catalog Number
Wall Switch Programmable Timer with Astronomical Clock, Features 3 Interchangeable cover colors: Gray, Light Almond and White. Compatible in SP and 3-Way configurations, 120V AC, neutral wire required.	White	WSTA120



DT5030W

Count Down Timers

Description	Color	30 Minutes:	60 Minutes:	12 Hours:
		OFF, 5, 10, 20, 30	OFF, 15, 30, 45, 60	OFF, 2, 4, 8, 12
1000W @ 120V AC and 1400W @ 277V AC.	Ivory	DT5030I	DT5060I	DT5012I
	Light Almond	DT5030LA	DT5060LA	DT5012LA
	White	DT5030W	DT5060W	DT5012W

Features and Benefits

Dual (Ultrasonic and Passive Infrared)

Combines PIR and Ultrasonic technology, minimizing the risk of lights turning ON when the space is unoccupied. Once occupancy is detected by both technologies within the space lights are turned ON, only one technology is necessary to keep the lights ON.

Adaptive technology provides better control. Hubbell's patented breakthrough in advanced control feature smart microprocessors constantly monitoring the controlled area and adjust the sensitivity and timer based on environmental history.

The absolute choice for advanced control and precise performance.



Passive Infrared

Passive infrared sensors are specifically designed for long-range major motion activity sensitivity, making them ideal for large open areas.

Various models are suitable for indoor and outdoor applications where NEMA 4X rating is required. Other units are suitable for extreme temperatures areas providing unsurpassed flexibility for almost every application.

Ceiling Mount



Housing Design

- High-impact, plastic (UL94, 5VA)
- 12-element segmented Fresnel lens; 32kHz ultrasonic transmitter and receiver
- Mounting base provided



Coverage and Ratings

- Up to 2,000 sq. ft. between 8ft and 12ft mounting height. 24V DC active high-logic control signal
- Option of a N/O + N/C contacts; SPDT; 500 mA rated @ 24V DC; three-wire isolated relay for HVAC or energy management systems integration



Operation

- Self adjusting sensitivity thresholds and timers; automatic false ON/false OFF corrections, strong airflow compensation mode
- Compatible with Hubbell's distributed and centralized control systems

Wall Mount



Housing Design

- High-impact, plastic (UL94, 5VA)
- 12-element segmented Fresnel lens; 32kHz ultrasonic transmitter and receiver
- Mounting base provided



Coverage and Ratings

- Up to 1,600 sq. ft. between 8ft and 12ft mounting height. (30ft for high bay, aisle model) 24V DC active high-logic control signal
- Option of a N/O + N/C contacts; SPDT; 500 mA rated @ 24V DC; three-wire isolated relay for HVAC or energy management systems integration



Operation

- Self adjusting sensitivity thresholds and timers. Automatic false ON/false OFF corrections airflow compensation mode
- Compatible with Hubbell's distributed and centralized control systems



ATD2000C

Dual (Ultrasonic and Passive Infrared) Ceiling Sensors

Combines the excellent minor motion detection of ultrasonic with the outstanding passive infrared (PIR) long-range major motion detection.

Description	Voltage	Coverage Area	
		2000 sq. ft. (360°)	1000 sq. ft. (180°)
Low voltage sensor with photocell and isolated relay.	24V DC	ATD2000CRP	ATD1000CRP
Low voltage sensor.	24V DC	ATD2000C	—
Line voltage sensor.	120-277V AC	ATD2000CL	ATD1000CL



ATD1000CRP

Passive Infrared Ceiling Sensors

Outstanding long range major motion detection.

Description	Voltage	Coverage Area
		1500 sq. ft. (360°)
Low voltage sensor with photocell and isolated relay.	24V DC	ATP1500CRP
Low voltage sensor.	24V DC	ATP1500C
Line voltage sensor.	120-277V AC	ATP1500CL

Note: All Low voltage ceiling sensors must use a CU series control unit. See page E-10 for details.

Line voltage ceiling sensors suitable for occupancy (auto-on) applications only. Use low voltage ceiling sensors and low voltage switches with CU series control units (E-10) for vacancy (manual on) applications.

See pages E-25 to E-28 for technical specifications, coverage patterns and wiring schematics.

For Assembled in USA units Add suffix "U".



ATP1500C

Dual (Ultrasonic and Passive Infrared) Wall Mount Sensors

Description	Color	Coverage	Catalog Number
Low voltage sensor 32kHz with photocell and isolated relay.	Office White	1600 sq. ft.	ATD1600WRP



ATD1600WRP

Passive Infrared Wall Mount Sensors

Description	Color	Coverage	Catalog Number
Low voltage sensor with photocell and isolated relay.	Office White	1600 sq. ft.	ATP1600WRP
Low voltage sensor for aisle and high bay applications, with photocell and isolated relay.	Office White	120 linear feet	ATP120HBRP

Note: All wall mount sensors must use a CU series control units. See page E-10 for details.

See pages E-25 to E-28 for technical specifications, coverage patterns and wiring schematics.

For Assembled in USA units Add suffix "U"



ATP1600WRP

Low Voltage Switches

Single gang design, momentary or latching operation. Compatible with all Hubbell low voltage sensors and Load:Logic® Centralized and Distributed Control Systems. 100mA @ 30V DC max.

Description	Color	Catalog Number
Low voltage switch, latching, 1 button.	Ivory	DSL3011
	Light Almond	DSL30LA1
	White	DSL30W1
Low voltage switch, momentary, 1 button.	Ivory	DSM3011
	Light Almond	DSM30LA1
	White	DSM30W1
Low voltage switch, momentary, 2 buttons.	Ivory	DSM3012
	Light Almond	DSM30LA2
	White	DSM30W2

Note: Wallplate sold separately.



DSL30W1
DSM30W1

Emergency Lighting Controls

20 Amps, 120/277V AC, NC isolated contacts UL924 listed for emergency circuits. 0-10V dimming override.

Description	Catalog Number
Emergency lighting control unit.	CU300ELC
Remote test switch with engraved wallplate.	RTPB10W

Note: See page E-26 for technical specifications.



CU300ELC



RTPB10W

Control Units

The CU300 series provides 24V DC power supply for sensors or sensor/Add-A-Relay combinations. The control units contain an internal relay for the control of an external load. Control units are plenum rated cULus Listed.

Description	Catalog Number
Auto ON operation, 100-277V AC, 50/60Hz for use with 1 to 4 ATD, ATU, ATP and AD2240 series sensors.	CU300A
Manual ON operation, 100-277V AC, 50/60Hz for use with 1 to 4 ATD, ATU, ATP and AD2240 series sensors.	CU300M
Auto or manual ON operation, 100-277V AC, 50/60Hz for use with 1 to 6 ATD, ATU, ATP, AHP and AD2240 series sensors, heavy duty latching relay for reactive loads and automatic receptacle control.	CU300HD

Note: See page E-26 for technical specifications.
For Assembled in USA units Add suffix "U".



CU300A



CU300HD

Add-A-Relay

Hubbell AAR Add-A-Relay contains an internal relay for control of an external load. The AAR requires a 24V DC power supply from the Hubbell CU series control unit. AAR units are typically used when multiple zone control is desired or the load exceed the maximum load rating of a single control unit.

Description	Catalog Number
Auto ON operation, 120-277V AC, 50/60Hz. Requires a CU300 series control unit; suitable for lighting loads.	AAR
Auto or manual ON operation, 100-277V AC 50/60Hz. Requires a CU300 series, heavy duty latching relay; suitable for automatic receptacle control applications.	AAR20P

Note: See page E-26 for technical specifications.



AAR



AAR20P

0-10V Adaptive Technology Wall Switch Sensor

Description	Color	Voltage	PIR	Dual (PIR & US)
Dimming selectable auto ON/auto OFF manual ON/auto OFF, current sinking capacity, 30mA.	Ivory		APD2000I1	ADD2000I1
	Light Almond		APD2000LA1	ADD2000LA1
	White		APD2000W1	ADD2000W1
Dimming manual ON/auto OFF (Vacancy) only, current sinking capacity, 30mA.	Ivory		APD2001I1	ADD2001I1
	Light Almond		APD2001LA1	ADD2001LA1
	White		APD2001W1	ADD2001W1



APD2000W1
APD2001W1

ADD2000W1
ADD2001W1

Low Voltage Switches with 0-10V Dimming

Single gang design, momentary, latching or a combination operation. Compatible with Hubbell CU300 series control units and IEC60929 Annex E.2 compliant dimming ballasts/LED drivers. Ideal for single zone dimming applications.

Description	Color	Voltage	Momentary, 3 button	Latching, 3 button	1 Latching, 1 Momentary, 4 button
Low voltage switch, 0-10V dimmer, current sinking capacity, 30mA.	Gray	24V DC	DSM010GY	DSL010GY	DSC010GY
	Ivory		DSM010I	DSL010I	DSC010I
	Light Almond		DSM010LA	DSL010LA	DSC010LA
	White		DSM010W	DSL010W	DSC010W

Note: See page E-34 for technical specifications.



DSM010I

Features and Benefits

MAXX™ Harsh Environment Sensing Devices

MAXX™ products are designed to withstand these harsh environments manufactured with cold and heat resistant components. These sensors tolerate extremes of weather and applications. MAXX™ products provide users with methods to reduce energy usage in harsh environments where other commercial grade products can't.

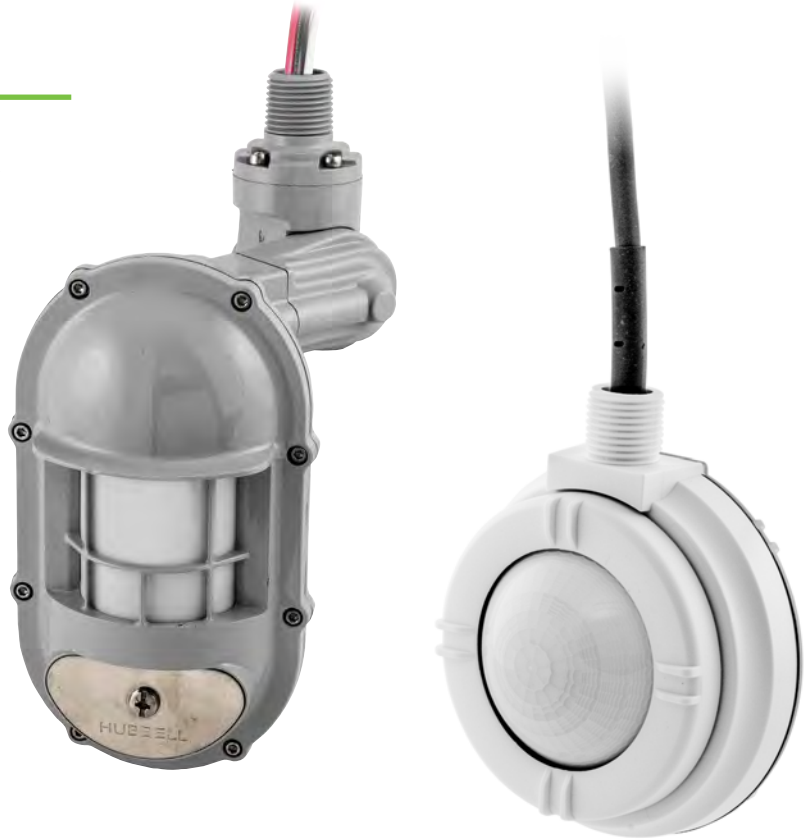

Pendant Mount



Housing Design

- IP66, TYPE 4X, outdoor rated
- Housing manufactured from chemical resistant thermoplastic
- Multiple mounting kits for existing work boxes and hubs; pendant or wall mounting flexibility

Fixture Mount



Housing Design

- IP65, NEMA 3R watertight, and outdoor rated
- Fixture or work box mounting with 1/2" threaded nipple



Protection

- Integrated lens guard protects against accidental damage
- Photocell makes sure lights stay OFF when there is sufficient daylight
- Isolated relay provides signalling to HVAC and ventilation systems



Coverage and Electrical Ratings

- Digital passive infrared (PIR) sensor
- Two (upward/downward) photocells options for daylight harvesting
- Supplied with 360° lens; aisle, end-of-aisle and 180° lenses available separately
- -40°F to 149°F (-40°C to 65°C) operating temperature range; compatible with CFL/LED and motor loads



Access Cover

- Stainless steel hardware and settings access cover

TYPE 4X Outdoor, Passive Infrared Wall Mount Sensor

Description	Voltage	Catalog Number
PIR sensor, with isolated relay and photocell.	24V DC	AHP1600WRP

Note: For use with CU300HD (100-277V AC, 50/60Hz) control unit.
See page E-26 for technical specifications and coverage patterns.



AHP1600WRP

Extreme Temperatures Passive Infrared Ceiling Mounted Sensor

Use ACIPE to make NEMA 4X watertight.

Description	Voltage	Catalog Number
Sensor with isolated relay and photocell.	24V DC	AHP1500CRP
IP66, NEMA 4X enclosure.	—	ACIPE

Note: For use with CU300HD (100-277V AC, 50/60Hz) control unit.
See page E-25 for technical specifications and coverage patterns.



**AHP1500CRP
with ACIPE**

Heavy Duty Control Unit

The CU300 series provides 24V DC power supply for sensors or sensor/Add-A-Relay combinations. The control units contain an internal relay for the control of an external load. Control units are plenum rated cULus Listed.

Description	Catalog Number
Auto or manual ON operation, 100-277V AC, 50/60Hz, heavy duty latching relay.	CU300HD
Auto or manual ON operation, 100-277V AC, 50/60Hz. Requires a CU300 series, heavy duty latching relay.	AAR20P

Note: See page E-26 for technical specifications.
For Assembled in USA units Add suffix "U".



CU300HD

OPTIMYZER® Watertight High Bay and Low Bay PIR Sensors with Photocells

IP65, NEMA 3R, outdoor rated, -40°F to 149°F (-40°C to 65°C) operating temperature range.

Description	Voltage	Standard	0-10V Dimming
Single relay end mount.	120-347V AC	HBSXT13	HBSXT14D
2 relays end mount.	120-347V AC	HBSXT23	—
1 double pole relay end mount.	208, 240V AC	HBSXT28	—
1 double pole relay end mount.	480V AC	HBSXT48	—
Low voltage end mount.	24V DC	HBSXT24*	HBSXT24D*
Single relay surface mount.	120-480V	—	HBSXT14DSM
Low voltage surface mount.	24V DC	—	HBSXT24DSM*

Note: 360° high bay lens included. Low bay lens options sold separately, see below for details.
*For use with CU300HD (120/277V AC, 50/60Hz) control unit.
See pages E-29 and E-30 for technical specifications and coverage patterns.



HBSXT24D

Replacement Lenses

Description	High Bay	Low Bay
180° lens.	HBRLXT180	LBRLXT180
360° lens.	HBRLXT360	LBRLXT360
Aisle lens.	HBRLXTA	LBRLXTA
End of aisle lens.	HBRLXTEA	LBRLXTEA



HBRLXT180

HBRLXT360



HBRLXTA

HBRLXTEA

New Codes and Standards mandates that 50% of all receptacles in private offices, open offices and computer classrooms must be automatically controlled by occupancy or time based schedules. This also includes outlets in modular furniture. Hubbell provides solutions for compliance that are cost effective and installer friendly. Find out more design resources at www.hubbell-wiring.com/energy.aspx

Wired

Utilizing low voltage wiring provides installers with a familiar method of wiring and installation. Specify Hubbell's new load control receptacle to meet this requirement. Utilize alternating outlet or split receptacle wiring as required to control at least 50% of the outlets in the space.

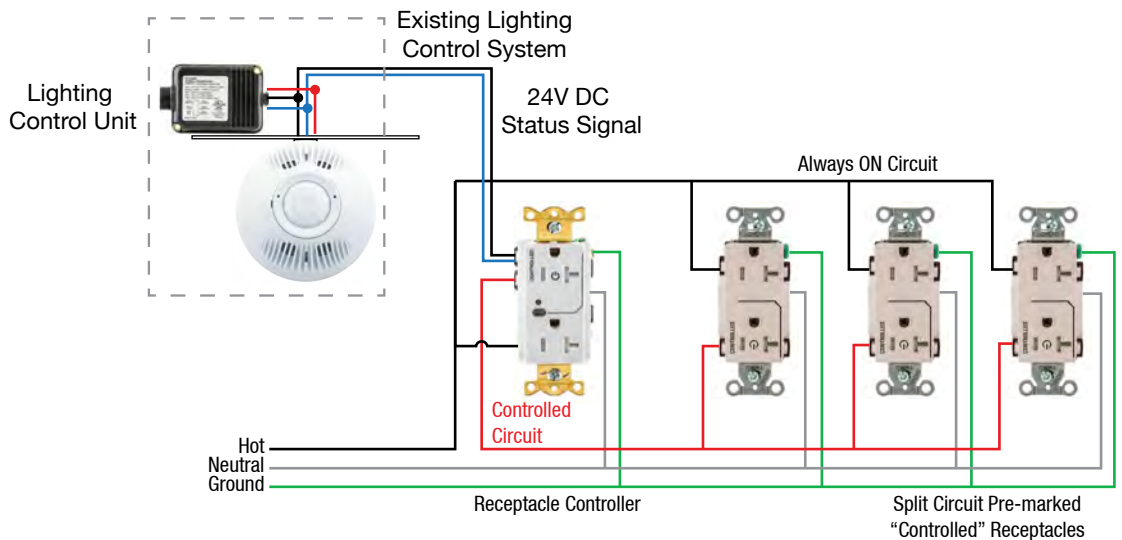

Codes and Standards



ASHRAE Standard 90.1 2019

Standard 90.1 requires that at least 50 percent of all 125V, 15A and 20A receptacles in private offices, open offices and classrooms be controlled by an automatic control device. Controlled receptacles need to be marked to differentiate them from non-controlled receptacles.



California Title 24 Building Energy Efficiency Standards 2019

Section 130.5(d) of California Energy Commission Title 24, Part 6 - 2019 code requires receptacles to have automatic shutoff controls in certain spaces in all buildings.



2020 National Electrical Code®

NEC® Section 406.3(E) requires that all nonlocking, 125 V, 15A and 20A receptacles controlled by an automatic control device or by an automatic energy management system must be marked with the ⏻ symbol and the word "CONTROLLED".

Clear Connect® is a registered trademark of Lutron Electronics Co., Inc.

Wired

Switched Receptacles for Automatic Receptacle Control

Description	Color	15A		20A	
		Split Circuit	Fully Controlled	Split Circuit	Fully Controlled
Auto ON/Auto OFF control. Capable of controlling additional receptacles downstream.	Black	HBL5262LC1BK	HBL5262LC2BK	HBL5362LC1BK	HBL5362LC2BK
	Brown	HBL5262LC1	HBL5262LC2	HBL5362LC1	HBL5362LC2
	Gray	HBL5262LC1GY	HBL5262LC2GY	HBL5362LC1GY	HBL5362LC2GY
	Green	HBL5262LC1GN	HBL5262LC2GN	HBL5362LC1GN	HBL5362LC2GN
	Ivory	HBL5262LC1I	HBL5262LC2I	HBL5362LC1I	HBL5362LC2I
	Lt. Almond	HBL5262LC1LA	HBL5262LC2LA	HBL5362LC1LA	HBL5362LC2LA
	White	HBL5262LC1W	HBL5262LC2W	HBL5362LC1W	HBL5362LC2W

Note: See page E-31 for technical information. Special order for hospital grade devices.



HBL5362LC2W

Heavy Duty Control Unit

The CU300 series provides 24V DC power supply for sensors or sensor/Add-A-Relay combinations. The control units contain an internal relay for the control of an external load. Control units are plenum rated cULus Listed.

Description	Catalog Number
Auto or manual ON operation, 100-277V AC, 50/60Hz for use with 1 to 6 ATD, ATU, ATP, AHP and AD2240 series sensors, heavy duty latching relay for reactive loads and automatic receptacle control.	CU300HD
Auto or Manual ON operation, 100-277V, AC 50/60Hz. Requires a CU300 series, heavy duty latching relay; suitable for automatic receptacle control applications.	AAR20P

Note: See page E-26 for technical specifications and wiring schematics.



CU300HD

Wireless

Switched Receptacles for Automatic Receptacle Control

Description	Color	15A		20A	
		Split Circuit	Fully Controlled	Split Circuit	Fully Controlled
Wireless receiver Auto ON/Auto OFF. Capable of controlling additional receptacles downstream.	Black	HBL5262RFC1BK	HBL5262RFC2BK	HBL5362RFC1BK	HBL5362RFC2BK
	Brown	HBL5262RFC1	HBL5262RFC2	HBL5362RFC1	HBL5362RFC2
	Gray	HBL5262RFC1GY	HBL5262RFC2GY	HBL5362RFC1GY	HBL5362RFC2GY
	Green	HBL5262RFC1GN	HBL5262RFC2GN	HBL5362RFC1GN	HBL5362RFC2GN
	Ivory	HBL5262RFC1I	HBL5262RFC2I	HBL5362RFC1I	HBL5362RFC2I
	Lt. Almond	HBL5262RFC1LA	HBL5262RFC2LA	HBL5362RFC1LA	HBL5362RFC2LA
	White	HBL5262RFC1W	HBL5262RFC2W	HBL5362RFC1W	HBL5362RFC2W

Note: See page E-31 for technical information. Special order for hospital grade devices.



HBL5262RFC1W

Adaptive Technology Wall Switch Sensors

Electrical	AD2000, APD2000, AP2000 Series
Power Supply	120/277V AC, 50/60Hz
Load Capacity	800W Incandescent, 1000W Electronic Ballast, 5A LED
120V AC	1800W Electronic Ballast, 5A LED
277V AC	
Motor Load	1/6HP
Power Requirements	24V DC nominal, 33mA from Hubbell CU series control unit (AD2240 Series)
Agency Approvals	UL and cUL Listed

Physical	
Housing	High impact plastic (UL 94-5V)
Lens	Dual element pyrometer and 12 element cylindrical hard lens (AP2000 only)
Dimensions	Face 2.57"H x 1.71"W, 0.53"D (from wall out)
Mounting Height	42 to 54 inches above floor

Environmental	
Operating	32° F to 104°F (0°C to 40°C); 0% to 95% non-condensing relative humidity

Controls	
Time Delay	Digital, adaptive 4 to 30 minutes, 20 minutes default
Ambient Light	Adjustable ambient light override, 10 to 500 foot candles
Front Press Switch	Auto/OFF
Sensitivity	Adaptive 0% to 100%
Service Switch	Air gap OFF
Dimming	0-10V, Sink up to 30mA (APD2000 series only)

Sensing Indicator	
Passive Infrared	Red LED (AD & AP series only)
Ultrasonic	Green LED (AD & AU series only)

Wall Switches Coverage Patterns

Minor Motion: ■ Ultrasonic ■ PIR
 Major Motion: ■ Ultrasonic ■ PIR

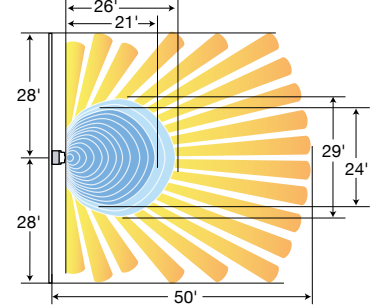

AD2000 Series

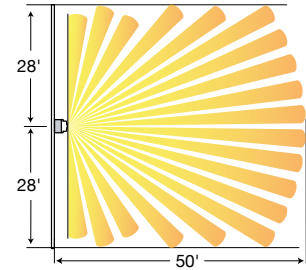

AP2000 Series

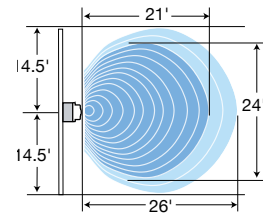

AU2000 Series

Wiring Schematic AD, AU, AP, 2000 Series Wall Switch Sensors

Single Circuit Wiring

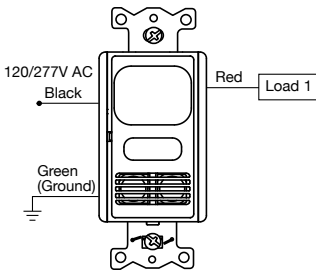

Two Circuit Sensor, Wired for Two Loads

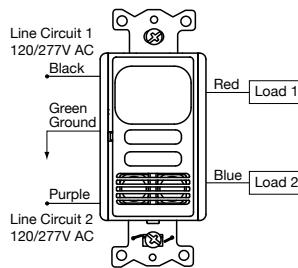

Wall Switch Sensors with Neutral Wires

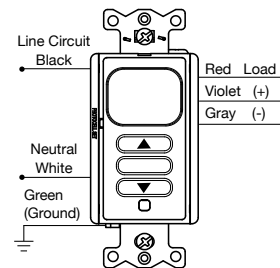

Single Circuit Sensors, Wired as 3-Way Sensors*

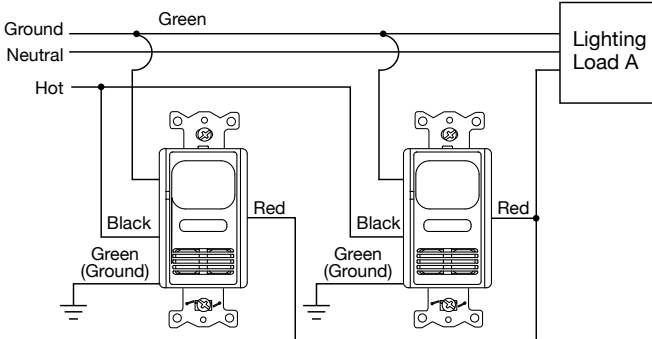

Low Voltage Wall Switch Sensors*

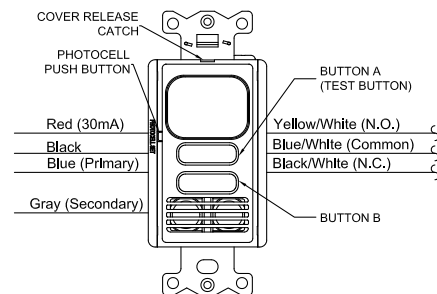

Note: *Load can not exceed the rating of one switch.
 Sensor is shipped with all DIP switches in the OFF position (factory default).

Adaptive Technology PIR Wall Switches WS2000, WS1000 and WS1020 Series

Electrical	WS2000 Series	WS1000/WS1020 Series
Power Supply	120/277V AC, 60Hz	120V AC, 60Hz
Load Capacity		
Incandescent	1000 watts	5A/600 watts
120V Ballast, CFL, LED	1000 watts, 1/6HP	5A/600 watts, 1/6HP
277V Ballast, CFL, LED	1800 watts	N/A
Agency Approvals	cULus Listed	cULus Listed
Warranty	5 years	5 years

Physical

Housing	Flame retardant UL 94 V-0 ABS
Lens	Polyethylene
Dimensions	Face 2.59"H x 1.30"W, 0.61"D (from wall out)
Mounting Height	42 to 54 inches above floor

Environmental

Operating	32°F to 122°F (0°C to 50°C) with rate of change not exceeding 20°F (11°C) per hour; 20% to 90% non-condensing relative humidity
Storage	-40°F to 150°F (-40°C to 65°C); 20% to 90% non-condensing relative humidity

Controls	WS1000/WS2000 Series	WS1001/WS1020 Series
Time Delay	Manual 6 seconds to 20 minutes	
Ambient Light	Digital, pushbutton, 10 to 500 foot candles	N/A
Front Press Switch	ON/OFF	ON/OFF
Service Switch	OFF (service) Vac (manual ON) Occ (auto ON)	OFF (service) ON (service)

Sensing Indicator

Passive Infrared	Red LED
------------------	---------

Wall Switches Coverage Patterns

Minor Motion: ■ PIR Major Motion: ■ PIR

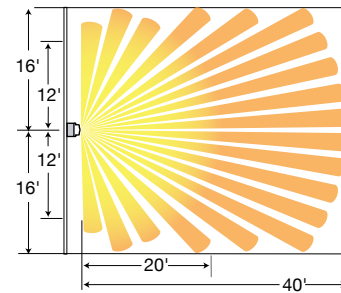

WS2000, WS1000 and WS1020 Series

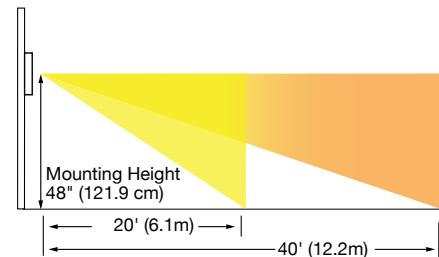

Vertical Coverage
WS2000, WS1000 and WS1020 Series

Wiring Schematic WS2000, WS1000 and WS1020 Series Wall Switches

WS2000 Series Wall Switch Sensors

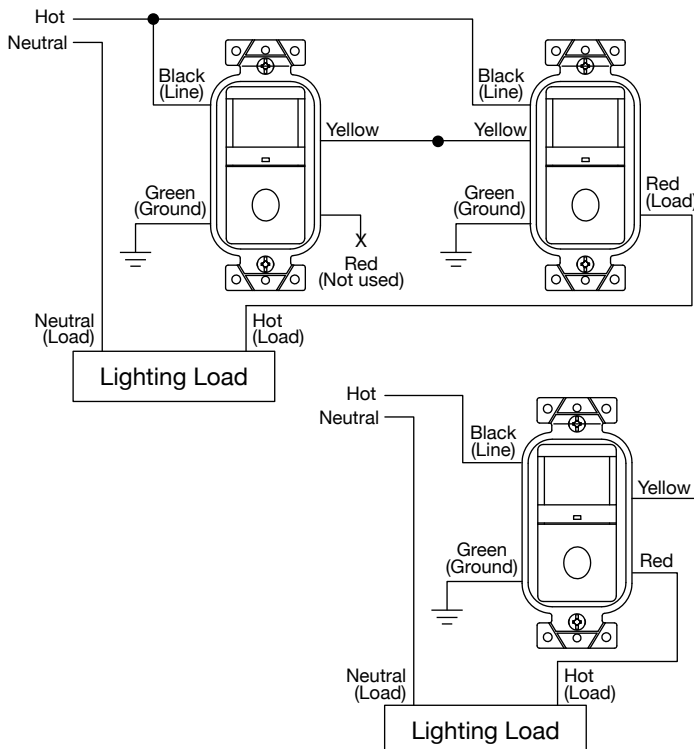

WS1020 Series Wall Switch Sensors

Dual Circuit Sensor, Wired for Dual Circuits

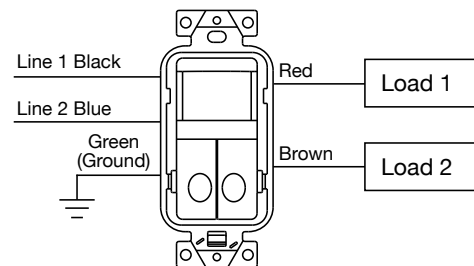

Energy Efficiency Solutions

Adaptive Dual Technology, Ultrasonic and Passive Infrared Ceiling and Wall Mount Sensors ATD, AHP and ATP Series

Electrical		
Power Requirements	24V DC nominal, 33mA from Hubbell CU series control unit	
Isolated Relay (sensors with RP suffix)	Relay: N/O + N/C contacts; 500mA rated @ 24V DC; 3-wire isolated relay	
Agency Approvals	UL and cUL Listed	
Physical		
	Ceiling Sensors	Wall Mount Sensors
Housing	Flame retardant UL 94 V-0 ABS	Flame retardant UL 94 V-0 ABS
Protection	NEMA 4X, when used with ACIPE	NEMA 4X, IP66, outdoor use rated (AHP only)
Lens	Polyethylene	Polyethylene
Dimensions	1.5"H x 4.5"Diameter	6"H x 2"W x 1.5"D
Color	Office white	Office white; Gray (AHP series)
Mounting Height	8 to 12 feet	8 to 12 feet, 8 to 30 feet (ATP120HB series)
Environmental		
Operating	32°F to 104°F (0°C to 40°C) with rate of change not exceeding 20°F (11°C) per hour; 0% to 95% non-condensing relative humidity	
	-40°F to 149°F (-40°C to 65°C) with rate of change not exceeding 20°F (11°C) per hour; 0% to 95% non-condensing relative humidity (AHP series)	
Storage	-20°F to 150°F (-29°C to 65°C); 0% to 95% non-condensing relative humidity	
Controls		
Time Delay	Test (8 seconds), adaptive 8 to 40 minutes	
Ambient Light	1 to 1000 foot candles	
Sensitivity	Adaptive 0 to 100%	
Sensing Indicators		
Ultrasonic (ATD and ATU Series)	Green LED	
Passive Infrared (ATD, AHP and ATP Series)	Red LED	

Ceiling Sensors Coverage Patterns

Minor Motion: ■ Ultrasonic ■ PIR Major Motion: ■ Ultrasonic ■ PIR

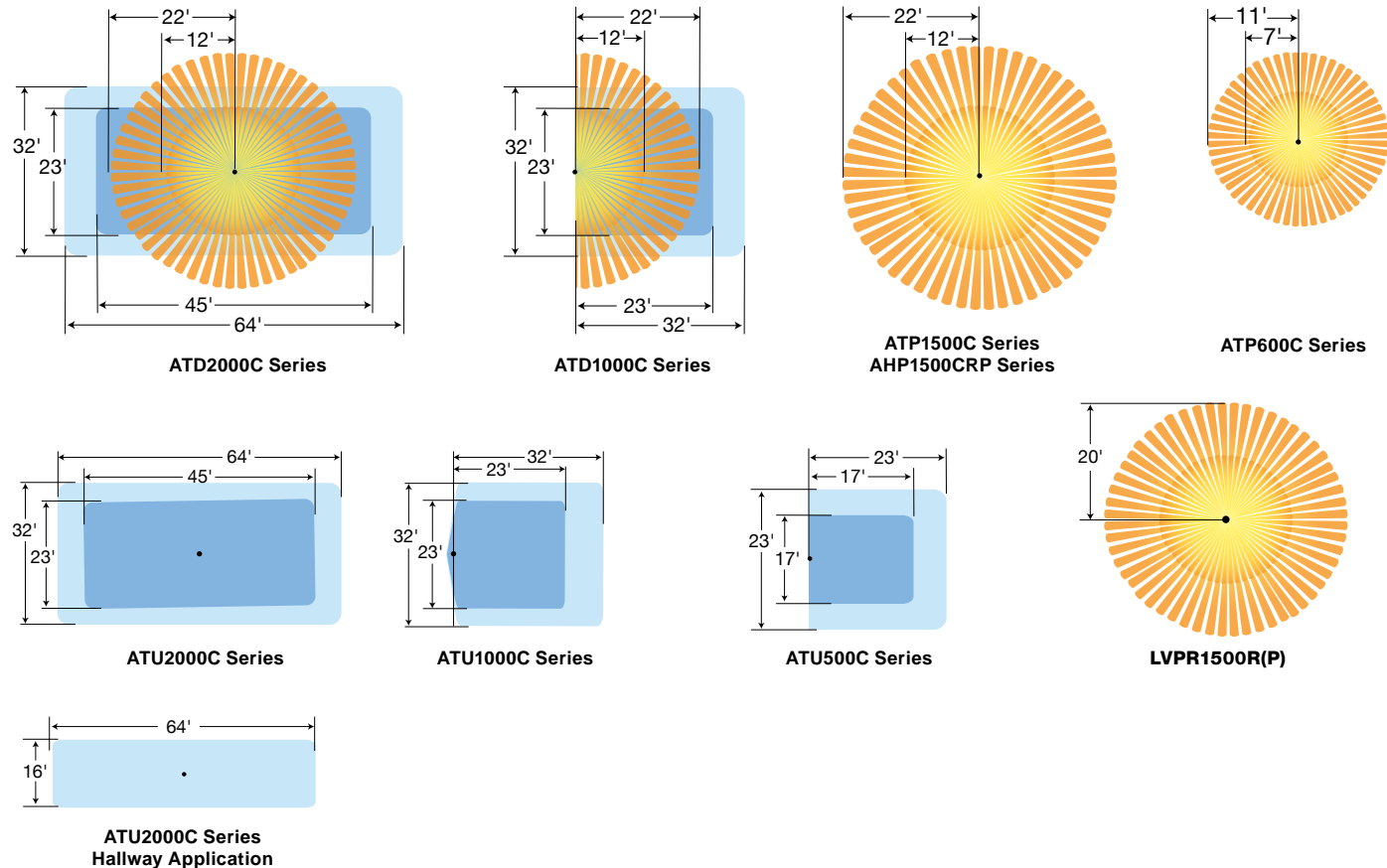

Wall Mount Sensors Coverage Patterns

Minor Motion: ■ Ultrasonic ■ PIR Major Motion: ■ Ultrasonic ■ PIR

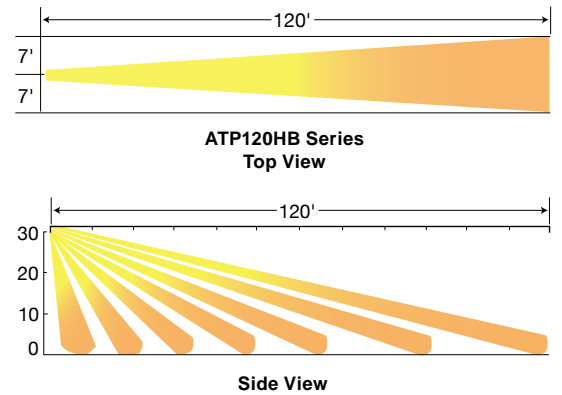
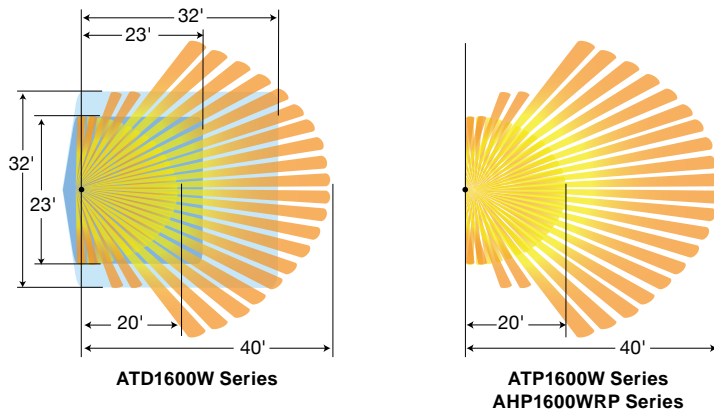

Control Units - CU300A or CU300M and CU300HD Series

Electrical	CU300A or CU300M	CU300ELC	CU300HD
Power Supply	100-277V AC, 50/60Hz	100-277V AC	100-277V AC, 50/60Hz
Power Output	24V DC, 150mA	N/A	24V DC, 250mA
Load Capacity	16A, 8A LED	16A	20A
Motor Loads	1HP	1HP	1HP @ 120V 2HP @ 240/277V
AT Sensor/AAR Capacity	1 to 4 combined		1 to 6 combined
Agency Approvals	UL and cUL Listed	cULus Listed	cULus Listed
Physical			
Housing	Flame retardant UL94-5VA thermoplastic	Flame retardant UL94-5VA thermoplastic	
Dimensions	3.69"L x 2.33"W x 1.36"H	4.00"L x 3.4"W x 1.73"H	
Color	Black	Black	
Environmental			
Operating	32°F to 104°F (0°C to 40°C); 0% to 90% non-condensing relative humidity		-40°F to 149°F (-40°C to 65°C). Below 32°F (0°C) must use suitably rated non-metallic enclosure. 0% to 90% humidity, non-condensing
Storage	-20°F to 150°F (-29°C to 65°C); 0% to 90% non-condensing relative humidity		

Add-A-Relay Control Units

Electrical	AAR	AAR20P
Power Input	24V DC nominal, 33mA from Hubbell CU series control unit	24V DC nominal, 50mA from Hubbell CU300HD series control unit
Load Capacity	16A, 120/277V AC, 8A LED	20A, 100-277V AC
Motor Loads	1800 watts	Motor Loads
1HP @ 120V	2400 watts	1HP @ 120V
2HP @ 240/277V	2400 watts	2HP @ 240/277V
Operation Mode	Auto ON/Auto OFF	Selectable Auto ON/Auto OFF or Manual ON/Auto OFF
Agency Approvals	UL and cUL Listed	cULus Listed
Physical		
Housing	Flame retardant UL94-5V thermoplastic	Flame retardant UL94-5VA thermoplastic
Dimensions	3.69"L x 2.33"W x 1.36"H	4.00"L x 3.4"W x 1.73"H
Color	Black	Black
Environmental		
Operating	32°F to 104°F (0°C to 40°C); 0% to 90% non-condensing relative humidity	-40°F to 149°F (-40°C to 65°C). Below 32°F (0°C) must use suitably rated non-metallic enclosure. 0% to 90% humidity, non-condensing
Storage	-20°F to 150°F (-29°C to 65°C); 0% to 90% non-condensing relative humidity	

Energy Efficiency Solutions

Ceiling and Wall Mount Sensors ATD, ATP Series

Single lighting circuit 1 to 4 sensors wired to control unit with optional override OFF switch application.

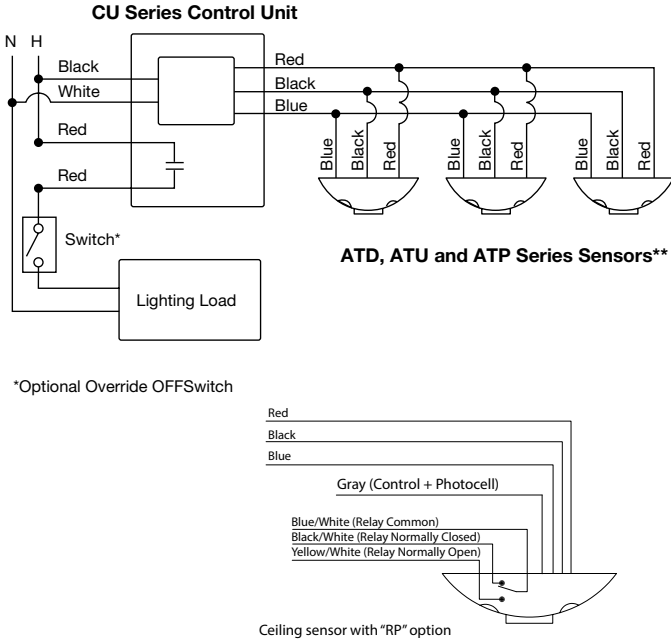

Single lighting circuit with 0-10V dimming and automatic receptacle control application.

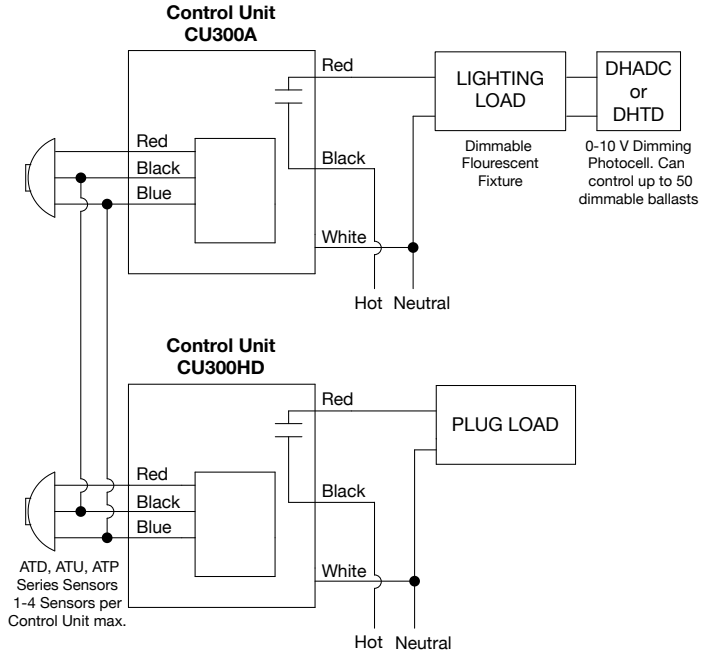

Bi-level lighting circuit and automatic receptacle control application.

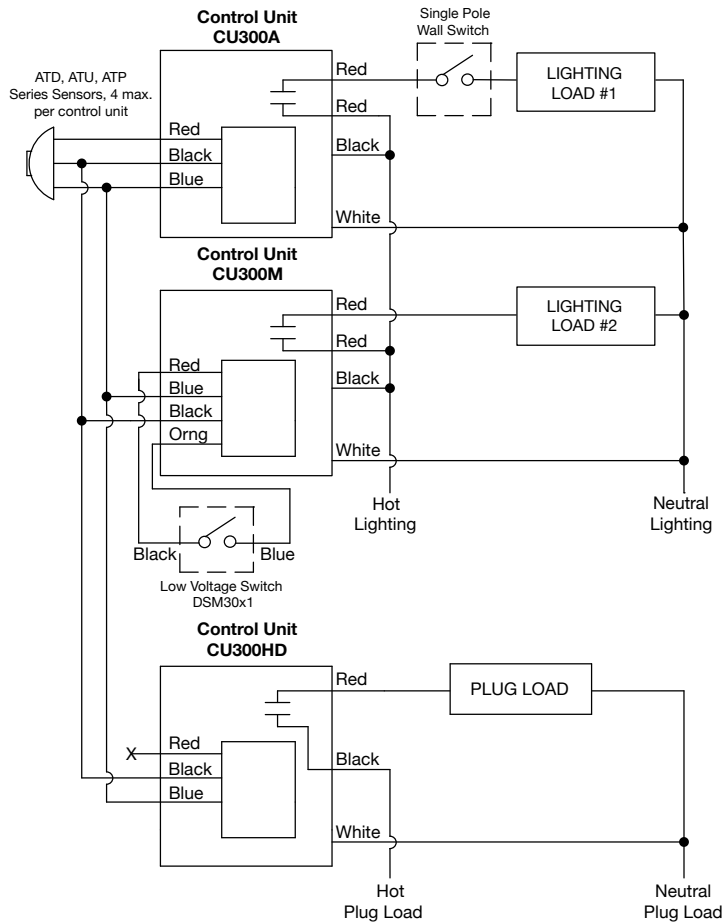

Two lighting circuits and automatic receptacle control application.

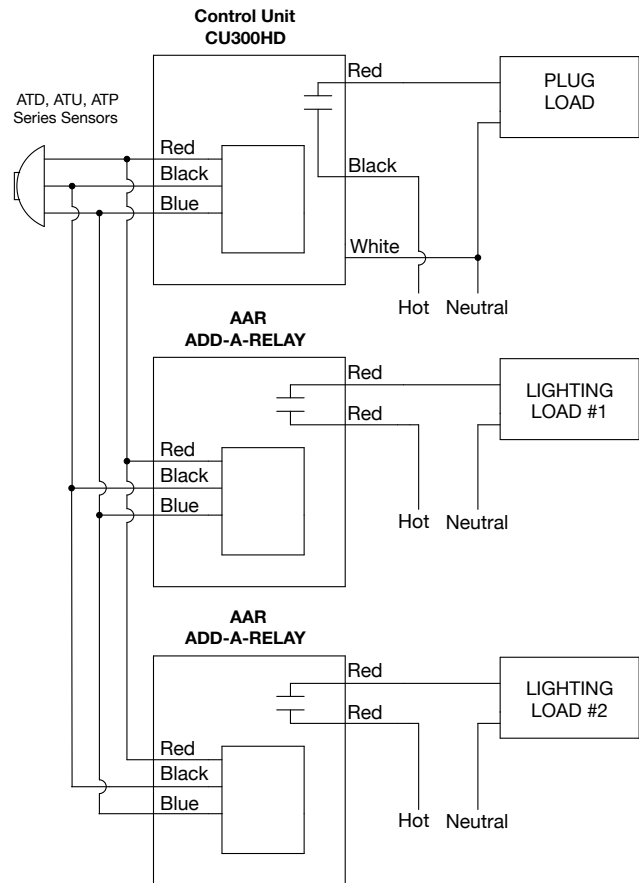

Energy Efficiency Solutions

Adaptive Technology Dual, Ultrasonic, and Passive Infrared Ceiling and Wall Mount Sensors ATD, ATU and ATP Series

Single Circuit, Dual Level Switching Application:

1 to 4 sensors wired to control unit with optional override off switches.

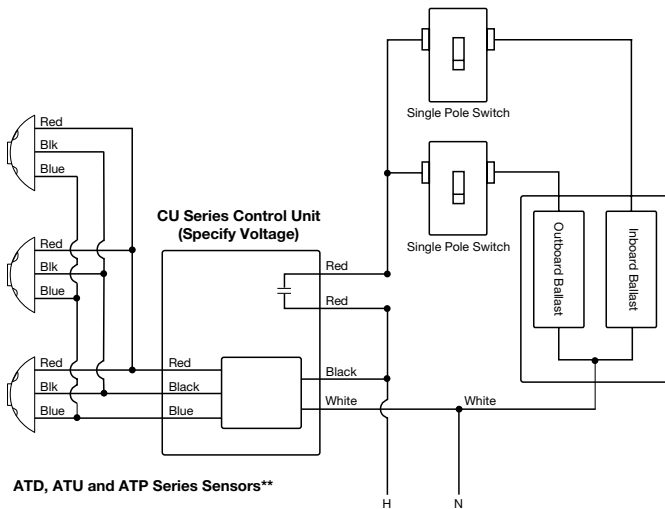

ATD, ATU and ATP Series Sensors**

Single Circuit, 3-Way Switching Application:

1 to 4 sensors wired to control unit with optional override off switches.

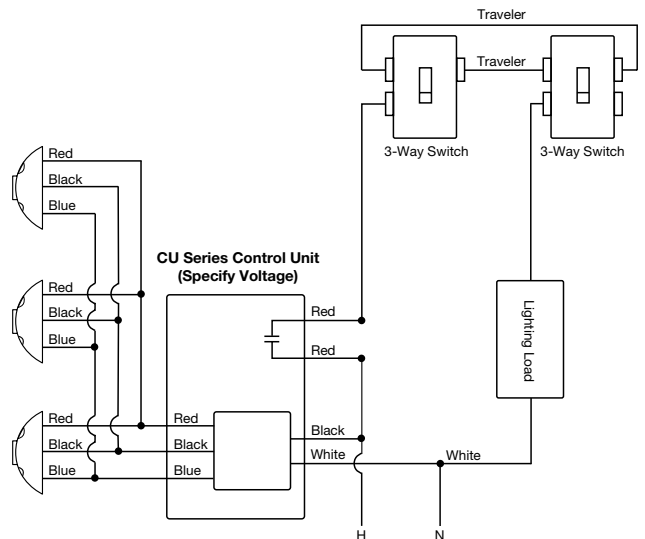

ATD, ATU and ATP Series Sensors**

Multi-Circuit Application:

1 to 4 sensors wired to control unit that is wired to a multi-pole lighting contactor.

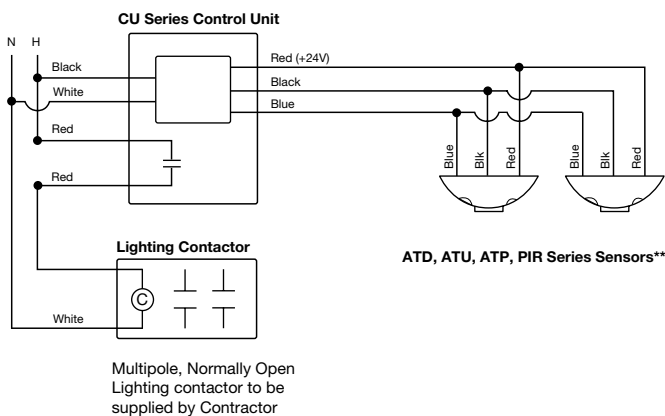

ATD, ATU, ATP, PIR Series Sensors**

Multipole, Normally Open Lighting contactor to be supplied by Contractor

Single Circuit, 4-Way Switching Application:

1 to 4 sensors wired to control unit with optional override off switches.

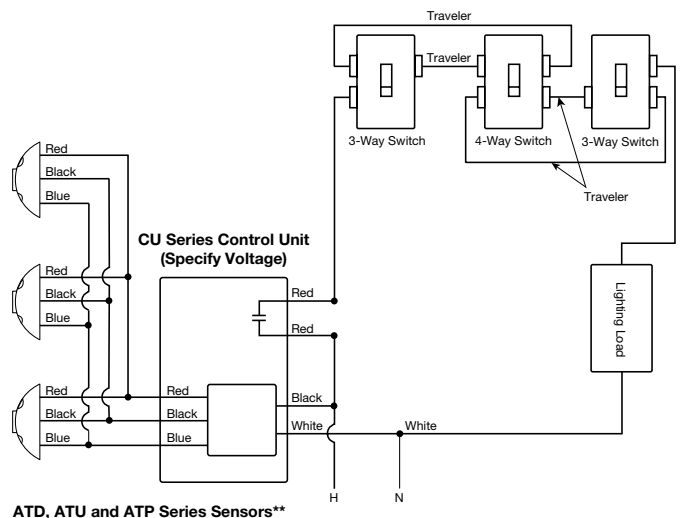

ATD, ATU and ATP Series Sensors**

Note: **For wiring sensors with isolated relay and photocell option (models with "RP" suffix): Photocell Option: Cap off Blue sensor wire. Connect Gray sensor wire to Blue control unit wire. Isolated Relay Option: Common-Blue/White wire, Normally Closed-Black/White wire, Normally Open-Yellow/White wire.

OPTIMYZER® High Bay and Low Bay End Mount PIR Sensors

User Interface	(1) twelve pin DIP switch
Timer time-outs	Primary: 8-second test mode, 4, 8, 16 and 30 minute time-outs Secondary: (Can be disabled) 30, 60 and 90 minute time-outs
Passive infrared	Dual element pyrometer and spherical Fresnel lens
Daylight sensor	Dual element pyrometer and spherical Fresnel lens designed for robust detection of a walking person*
Coverage	360° lens provided, 180° aisle and end-of-aisle lenses also available
Load ratings (Line voltage units)	120V AC: 800W ballast or tungsten, 5 LED 208/240V AC: 1200W ballast 277V AC: 1200W ballast, 5 LED 480V AC: 2400W ballast 347V AC: 1500W ballast ¼ HP motor load @ 120V AC, ½ HP @ 347V AC
Low voltage sensors (Output)	24V DC nominal, 33mA from Hubbell CU series control unit Relay: N/O + N/C contacts; 500mA rated @ 24V DC; 3-wire isolated relay
0-10V Dimming	Capable of sinking up to 30mA (Dimming series)
Dimming presets unoccupied	70%, 60%, 50%, 20% (Dimming series)
Full OFF timer delay enabled	After 60 minutes in the Unoccupied low level state, sensor will turn lighting OFF
Full OFF timer delay disabled	Sensor will maintain low level setting when there is no occupancy (Dimming series)
Operating environment	Indoor use only models Operating temperature: (standard version) 32°F to 149°F (0°C to 65°C); Relative humidity (non-condensing): 0% to 95% Indoor and outdoor use (Watertight) IP65 models HBSXT series Operating temperature: -40°F to 149°F (-40°C to 65°C)
Construction	Casing: High-impact injection-molded thermoplastic
Size and weight	Size: 4.0" Diameter x 1.5" Height; Weight: 7 oz.
Color	White
Mounting	Mounts directly to end of a fixture through an extended ½ inch chase nipple for deeper body fixtures, an optional Extender Adapter (HMHBSA available separately) positions the sensor flush or below the bottom of the reflector for a full field of view
Certifications	cULus Listed, indoor models Conforms to UL STD 508, UL STD 244A, and IP65 (Watertight) models HBSXT series
Warranty	5 year limited

Note: *When used with program start ballast, a 1-2 second delay from occupancy detection to lamp turn-on may be experienced.

Coverage Pattern

Minor Motion: ■ PIR Major Motion: ■ PIR

HMHB Series

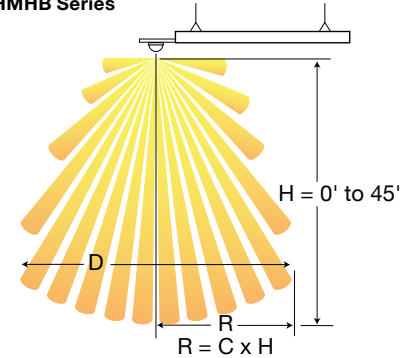

Lens Coverage

C = 1.4 @ 00-30 and 1.1 @ 30-45 (FT)

Height (H)	Radius (R)	Diameter (D)
18	25.2	50.4
20	28	56
24	33.6	67.2
28	39.2	78.4
30	42	84
32	35.2	70.4
36	39.6	79.2
40	44	88
42	46.2	92.4
45	49.5	99

OPTIMYZER® Low Mount Lens Modification Coverage Patterns

Minor Motion: ■ PIR Major Motion: ■ PIR

Top View

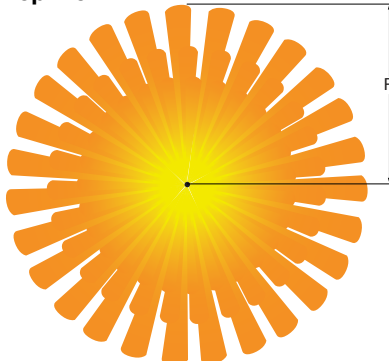

LBRL360

Side View

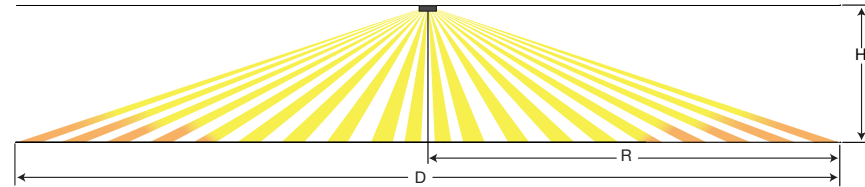

Lens Coverage
3:1 Ratio (FT)

Height (H)	Radius (R)	Diameter (D)
8	24	48
10	30	60
12	36	72
14	42	84
16	48	96

Energy Efficiency Solutions

OPTIMYZER® High Bay and Low Bay End Mount PIR Sensors, Low Voltage Sensor with Control Unit

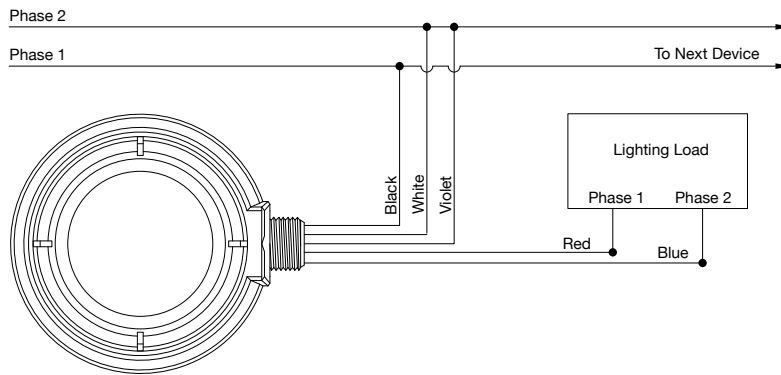
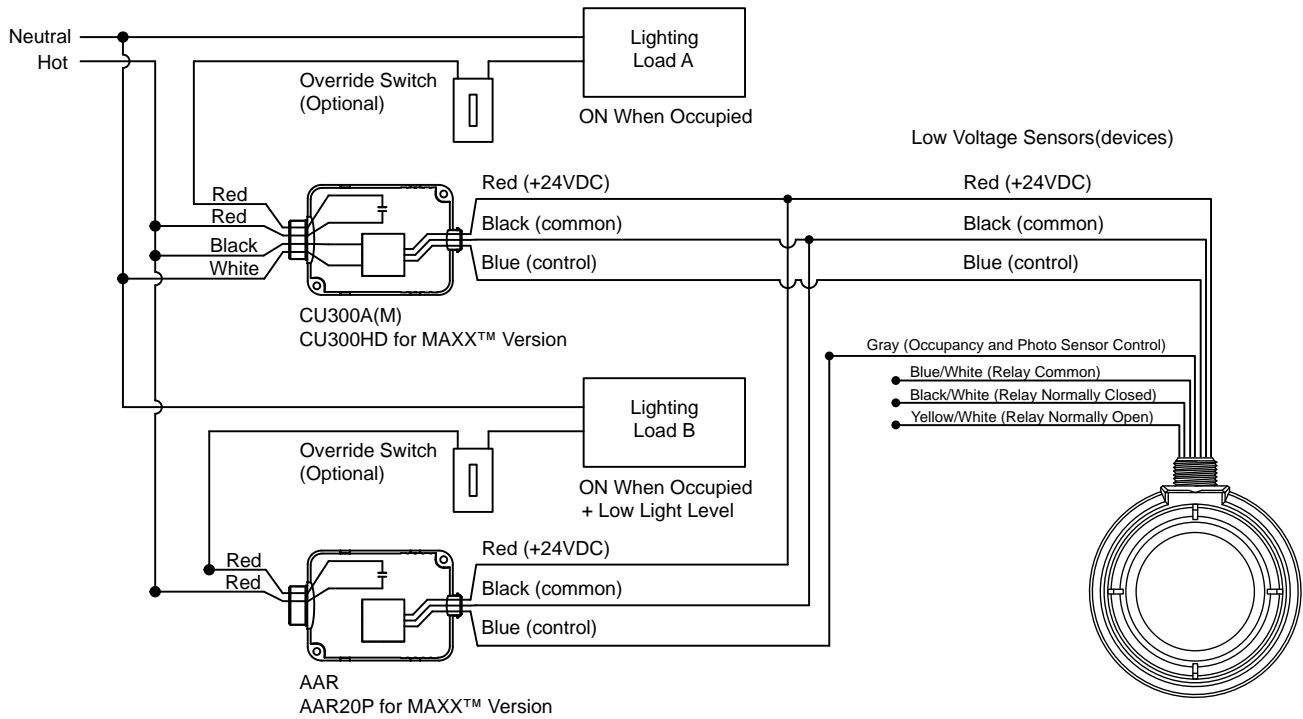

OPTIMYZER® High Bay and Low Bay End Mount PIR Sensors, Dual Relay, Single Fixture

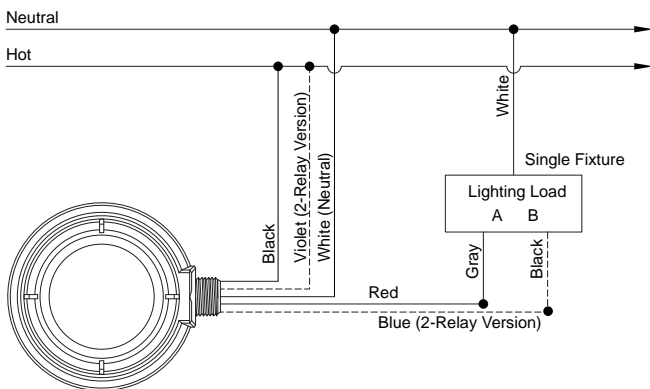

OPTIMYZER® High Bay and Low Bay End Mount PIR Sensors, Dual Relay, Two Fixtures

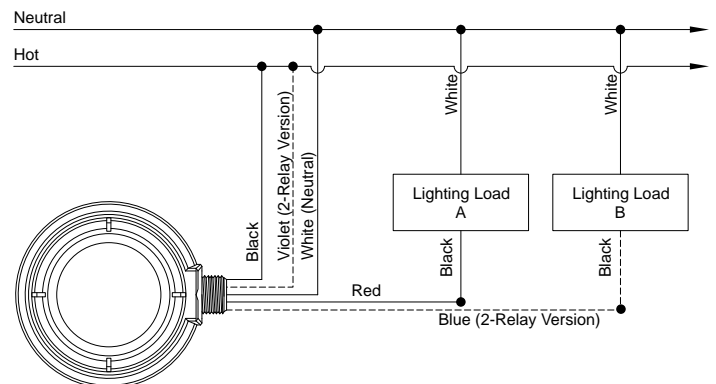



HBL5362LC2W

HBL2172LC2W

HBL® Heavy Duty Style Line® Specification Grade and Hospital Grade Straight Blade Switched Duplex Receptacles

Specifications

Receptacle	Part	Description
Typical Specification - Catalog No. HBL5262LC1, HBL2172LC1	Receptacle	15A (Always Hot), 8.3A (Switched)
Manufacturer's Identification - Hubbell HBL5262LC1 Receptacle	Top	Nylon
Description - Straight Blade Switched Duplex Receptacle	Base	Nylon
Type - 2 Pole, 3 Wire Grounding	Power Contacts	0.031 in. (0.8) Brass
Rating - Uncontrolled (Always Hot) 15A, 125V	Wire Clamp	0.062 in. (1.6) Steel-Nickel Finish
- Controlled (Switched) Tungsten 8.3A, CFL & LED: 3.75A	Mounting Strap	0.047 in. (1.2) Brass
Motor Load: 1/2HP	Line Terminal Screws	#8-32 Brass, Multiple Drive
Certification - cULus 498B SA: UL File No. E481574	Ground Screw	#8-32 Brass, Multiple Drive
Fed. Spec. WC596G	Center Assembly Staple	0.040 in. (1) Steel (Galvanized)
	Automatic Self-Grounding Staple	Stainless Steel
	Mounting Screws	Zinc Plated Steel

Specifications

Receptacle	Part	Description
Typical Specification - Catalog No. HBL5362LC1, HBL2182LC1	Receptacle	20A (Always Hot), 12.5A (Switched)
Manufacturer's Identification - Hubbell HBL5362LC1 Receptacle	Top	Nylon
Description - Straight Blade Switched Duplex Receptacle	Base	Nylon
Type - 2 Pole, 3 Wire Grounding	Power Contacts	0.031 in. (0.8) Brass
Rating - Uncontrolled (Always Hot) 20A, 125V	Wire Clamp	0.062 in. (1.6) Steel-Nickel Finish
- Controlled (Switched) Tungsten 12.5A, CFL & LED: 5A	Mounting Strap	0.047 in. (1.2) Brass
Motor Load: 1HP	Line Terminal Screws	#8-32 Brass, Multiple Drive
Certification - cULus 498B SA: UL File No. E481574	Ground Screw	#8-32 Brass, Multiple Drive
Fed. Spec. WC596G	Automatic Self-Grounding Staple	Stainless Steel
	Mounting Screws	Zinc Plated Steel

Performance

Electrical (Always Hot Receptacle)

Dielectric Voltage	Withstands 2,000V minimum.
Max. Working Voltage	125V AC
Current Interrupting	Certified for current interrupting at full current.
Temperature Rise	Max 30°C temperature rise at full rated current after 50 cycles of overload at 150% of rated current at power factor of 75%.

Mechanical

Terminal Identification	Terminals identified in accordance with UL498 and CSA (Brass, White, Green).
Terminal Accomodation	#14-10 AWG stranded or solid copper conductor only.
Product Identification	Ratings are a permanent part of the device.

Environmental

Flammability	UL94V-2
Operating Temperature	32°F (0°C) to 104°F (40°C)

Low Voltage Switches with 0-10V Dimming

Specifications

Base Catalogs: DSM30xx, DSL30xx, DSC010xx, DSM010xx, DSL010xx
 Compatible with Hubbell Wiring Device-Kellems CU300HD, CU300M control units, AAR20P relay packs.
 0-10V Dimming Series compatible with IEC60929 Annex E.2 compliant LED Drivers
 Accepts Hubbell Wiring Device-Kellems NPS26 and NP26 series decorator style wall plates (Not Included)
 Two-year warranty

Electrical Ratings

100mA @ 30VDC
 0-10V Dimming Series: Current Sinking Capacity: 100mA
 Available in Latching, Momentary, and Combination (DSC010series) of both configurations

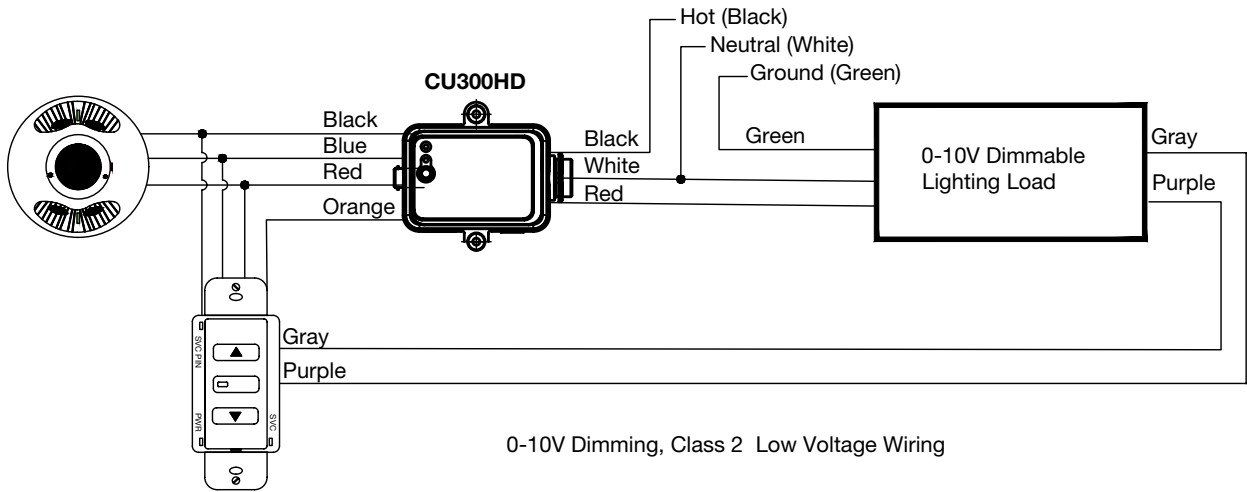

Clear Connect® is a registered trademark of Lutron Electronics Co., Inc.

CU300ELC Unit Wired with Control Unit CU300HD

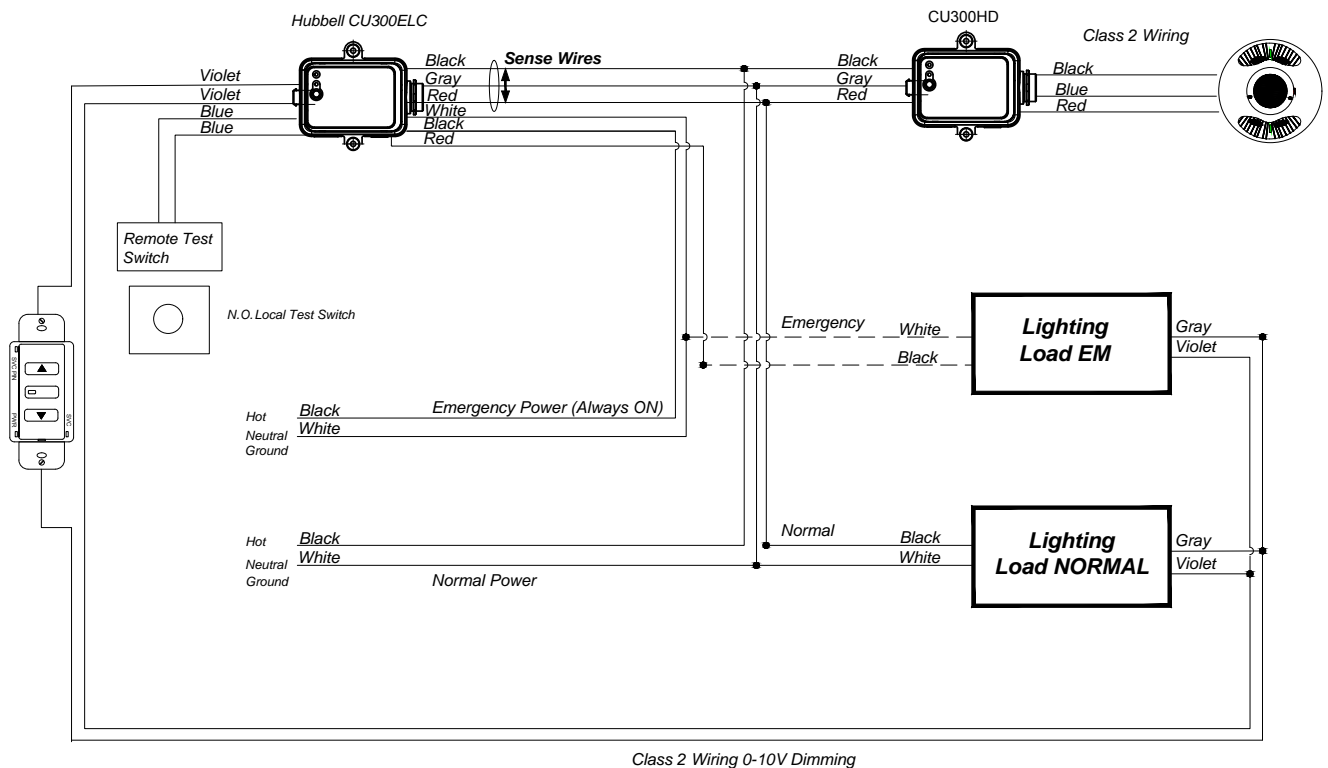

SECTION F

Table of Contents



Circuit-Lock® Unfused Disconnect Switches



Fused Disconnects, MotorQuick® and VFDs



Hazardous Locations

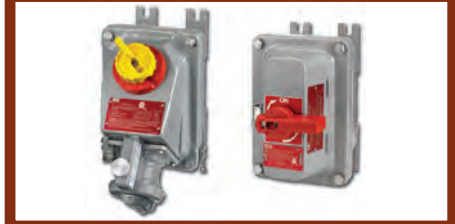

Product	Page	Product	Page
Products at a Glance	F-2	Ratings Quick Reference Guide	F-19
New Innovations		Hazardous Locations	
inSIGHT™ Phase Indicating Disconnect Switches	F-3	Unfused Disconnect Switches	F-21
Circuit-Lock® Switched Disconnect Enclosures		600V AC Manual Toggle Controllers/Disconnects	F-23
Non-Metallic Sloped Switched Units	F-5	NEMA 1 Disconnect Switches	F-24
Stainless Steel, Square Top and Sloped Top Units	F-7	NEMA 3 and 3R Disconnect Switches	F-25
Accessories and Replacement Parts	F-8	Manual Motor Controllers	
Dimensions and Specifications	F-9	30 Amp, 600 Volts AC	F-26
Non-Metallic Labelless Circuit-Lock	F-10	40, 50, 60 and 85 Amp, 600 Volts AC	F-27
Dimensions and Specifications	F-11	NEMA 4X Disconnect Switches	F-28
MotorQuick® Disconnect Switches		Pendant Pushbutton Stations	
Cost of Ownership Analysis	F-12	CPB2 and PBS Series	F-29
Labelless Disconnect Switches and Accessories	F-13	Accessories and Replacement Parts	F-30
Dimensions and Specifications	F-14		
200 Amp Disconnect Switches	F-15		
Circuit-Lock® Fused Disconnect Switches			
30 and 60 Amp Units	F-17		
Horsepower Ratings and Specifications	F-18		

Switched Disconnects and Enclosures

Products at a Glance

UL508/UL60947 Circuit-Lock® Motor Disconnects



Labelless Circuit-Lock® Disconnect Switches

- Non-metallic and stainless steel options
- Available in 30, 60 and 100 Amp versions
- IP69k and Type 4X, 12K water ingress protection
- Permanent labelless markings
- Available with six highly visible LED Indicators
- Certified by NSF for hygiene in Food Processing applications
- Highly visible red handle which meets OSHA LO/TO capabilities
- Accepts up to 2 auxiliary contacts
- Cover cannot be removed with switch in the "ON" position



Enhanced Features:

- **inSIGHT** - LED indicators provide visual confirmation of power by phase
- **MotorQuick**® - Plug and play functionality to reduce Total Cost of Ownership
- **VFDs** - Factory installed auxiliary contact for safe disconnecting in VFD applications
- **JOG** - Factory installed Jog switch for point of use communication to PLC/VFD
- **Stainless Steel Sloped Top** - 15° rounded top aids run-off by minimizing horizontal surfaces



UL98 Circuit-Lock® Motor Disconnects



200A Circuit-Lock® Disconnect Switches

- Non-metallic & stainless steel
- Type 4X, 12
- Accepts up to 2 auxiliary contacts
- OSHA Compliant Lockout/Tagout handle
- Unable to open the cover when "ON"; cover locked when energized



Circuit-Lock® 30 and 60 Amp Fused Disconnect Switches

- Non-metallic enclosure meets UL 50E Type 4X (watertight) 12 (dust-tight) and IP66 suitability requirements
- Removable door for ease of wiring and installation
- Switch accepts Class "J" fuses and up to 2 auxiliary contacts

UL98 and UL508 Disconnect Switches



Hazardous Locations

- Compact NEMA 4X enclosure and footprint allows easy installation in tight locations
- Top and bottom drilled and tapped conduit entrances
- For use as motor disconnects

UL508 Switches



Disconnect Switches

- Thermoset body provides high resistance to electrical arc tracking
- Withstands high temperatures
- Provides long-life reliability

Features and Benefits

Non-Metallic Sloped Circuit-Lock® Switched Disconnect Enclosures

NEC section 430.102(B) requires each motor controller to have a disconnect within line of sight from the motor and driven equipment. Hubbell's Circuit-Lock® Unfused Disconnect Switches are UL listed as a manual motor controller and also "suitable as a motor disconnect" and meet these code requirements.

Continued Hubbell Excellence:

- Constructed from corrosion and impact resistant UV stabilized non-metallic material
- IP69k and Type 4X, 12K water ingress protection
- Certified by NSF for hygiene in food processing applications
- Highly visible red handle which meets OSHA Lockout/Tagout capabilities
- Adjustable mounting feet are now 40% stronger to help prevent nuisance breakage
- Product ratings are permanently laser-marked and will not wash off Truly captive screws prevent lost screws



Rounded Sloped Top Enhanced Features:

- Rounded slope top aids run-off by minimizing horizontal surfaces
- Top feed version available
- Installation Free inSIGHT
- Improved conformal coated inSIGHT LED board
- Improved gasketing... longer lasting
- Closed Loop Lock Out / Tag Out
- Flat for side feed
- Accepts up to 3 Auxiliary Contacts
- 4th Pole solutions

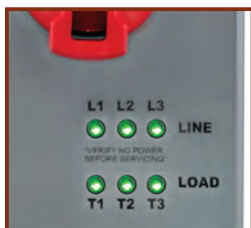

LED Indicators

- Six highly visible integral phase identification LEDs
- External LEDs provide secondary means of visual confirmation of make/break on all phases



Variable Frequency Drive (VFD)

- Integrates a verified break before break auxiliary contact factory installed in our HBLDS series
- Prevents downtime from out of sequence equipment shutdowns



Jog Switch

- Cost savings by utilizing existing space in the motor disconnect enclosure reducing parts and labor costs
- Convenience by having point of use control circuit to PLC within line of sight of the motor
- Added safety by allowing maintenance personnel the functionality to "Try Out" after Lockout/Tagout



MotorQuick® Version

- Significantly reduces the time it takes to replace motors by combining the plug-and-play technology of the LINKOSITY® power system
- Motor rotation can be pre-checked in a maintenance shop to further speed the installation

New Innovations

Circuit-Lock® 30A Disconnects with LED Indicators

Hubbell's new 30A Circuit-Lock Disconnect with integral phase indication LEDs redefines the benchmark for safety by providing insight into the enclosure while in use. Six highly visible LEDs (3 line side/3 load side) communicate the electrical status of the switch by phase. This voltage detection feature significantly improves existing safety and maintenance procedures by visually providing personnel critical information prior to removing the enclosure cover; e.g. a welded contact or dropped phase.

Installation of inSIGHT has never been easier. The improved design only requires termination of a single ground wire. No additional effort is required for the next level of safety.

inSIGHT™

Insight (n): the power or act of seeing into a situation

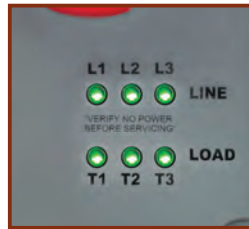

- Six highly visible integral phase identification LEDs provide secondary means of visual confirmation of make/break on all phases
- High visibility red handle can be locked in the OFF position to comply with OSHA Lockout/Tag out requirements
- Secondary confirmation of opening of load side contacts



in TOUCH

Self Terminating Diagnostic LEDs

- The backside of the cover includes self terminating diagnostic LEDs. No more wire harness or tabs to terminate. Only a single ground wire.
- Modernized circuit board is completely conformal coated withstanding moisture

Non-Metallic Sloped Switched Disconnect Enclosures

Description	30 Amp	60 Amp	100 Amp
Disconnect switch.	HBLDS30	HBLDS60	HBLDS100
Disconnect switch with HBLAC1 auxiliary contact.	HBLDS30AC	HBLDS60AC	HBLDS100AC
Disconnect switch for use with variable frequency drives.	HBLDS30VFD	HBLDS60VFD	HBLDS100VFD
Disconnect switch without conduit knockout or conduit fitting.	HBLDS30NK	—	—



HBLDS30

Non-Metallic Sloped Switched Disconnects with Jog Switch

Description	30 Amp	60 Amp	100 Amp
Disconnect switch.	HBLDS30J	HBLDS60J	HBLDS100J
Disconnect switch with HBLAC1 auxiliary contact.	HBLDS30ACJ	—	—
Disconnect switch for use with variable frequency drives.	HBLDS30VFDJ	—	—
Disconnect switch with Jog switch and LEDs.	HBLDS30PJ	HBLDS60PJ	HBLDS100PJ



HBLDS30VFD

Non-Metallic Sloped Switched Disconnect Switches with LEDs

Description	30 Amp	60 Amp	100 Amp
Non-Metallic disconnect switch with LEDs	HBLDS30P	HBLDS60P	HBLDS100P
Non-Metallic disconnect switch with HBLAC1 auxiliary contact	HBLDS30PAC	HBLDS60PAC	HBLDS100PAC

Note: *Certified by NSF, International.

LED version for use with 3Ø Y and delta configurations.

Top Feed Non-Metallic Sloped Switched Disconnect Enclosures*

Description	30 Amp	60 Amp	100 Amp
Disconnect switch.	HBLDS30T	HBLDS60T	HBLDS100T
Disconnect switch with HBLAC1 auxiliary contact.	HBLDS30TAC	HBLDS60TAC	HBLDS100TAC
Disconnect switch for use with variable frequency drives.	HBLDS30TVFD	HBLDS60TVFD	HBLDS100TVFD
Disconnect switch without conduit knockout or conduit fitting.	HBLDS30TNK	—	—



HBLDS30RS

Top Feed Non-Metallic Sloped Switched Disconnects with Jog Switch*

Description	30 Amp	60 Amp	100 Amp
Disconnect switch.	HBLDS30TJ	HBLDS60TJ	HBLDS100TJ
Disconnect switch with HBLAC1 auxiliary contact.	HBLDS30TACJ	—	—
Disconnect switch for use with variable frequency drives.	HBLDS30TVFDJ	—	—
Disconnect switch with Jog switch and LEDs.	HBLDS30TPJ	HBLDS60TPJ	HBLDS100TPJ

Top Feed Non-Metallic Sloped Switched Disconnect Switches with LEDs*

Description	30 Amp	60 Amp	100 Amp
Non-Metallic disconnect switch with LEDs	HBLDS30TP	HBLDS60TP	HBLDS100TP
Non-Metallic disconnect switch with HBLAC1 auxiliary contact	HBLDS30TPAC	HBLDS60TPAC	HBLDS100TPAC

Note: *Top feed versions include a single flat and drill point for top feed applications.

LED version for use with 3Ø Y and delta configurations.



HBLRFT1

Accessories:

¾" NEMA Type 3,3R, 4X and 12 zinc Conduit Hub	HUB75
1 ¼" NEMA Type 3,3R, 4X and 12 zinc Conduit Hub	HUB125A
¾" Grounding Plate for side feed applications	HBLDS34GP*
Additional Pole for up to 30A applications	HBL4P

*May require an additional ground block.

Replacement Accessories

	Switch	Mounting Feet	Ground Block	Neutral Block
For 30A switches	HBLDS3RS	HBLRFT1	HBL30RGB	HBL30RNB
For 60A switches	HBLDS60100RS	HBLRFT2	HBL60100RGB	HBL60RNB
For 100A switches	HBLDS60100RS	HBLRFT2	HBL60100RGB	HBL100RNB
For HBLDS33ACNK	HBLDS33ACRS	HBLRFT1	HBL30RGB	HBL30RNB



HBLAC1



HBLAC2

Features and Benefits

Stainless Steel Circuit-Lock® Unfused Switched Disconnect Enclosures*

NEC section 430.102(B) requires each motor controller to have a disconnect within line of sight from the motor and driven equipment. Hubbell's Circuit-Lock® Unfused Disconnect Switches are UL listed as a manual motor controller and also "suitable as a motor disconnect" and meet these code requirements.

- Formed in nonporous 304 stainless steel
- IP69k and Type 4X, 12K water ingress protection
- Certified by NSF for hygiene in food processing applications
- Fixed offset 1/4 inch mounting feet meet NEC airspace requirements for metal enclosures
- Labelless markings on the cover
- Highly visible red handle which meets OSHA Lockout/Tagout capabilities
- Cover cannot be removed with switch in the "ON" position
- Accepts up to 2 Auxiliary contacts

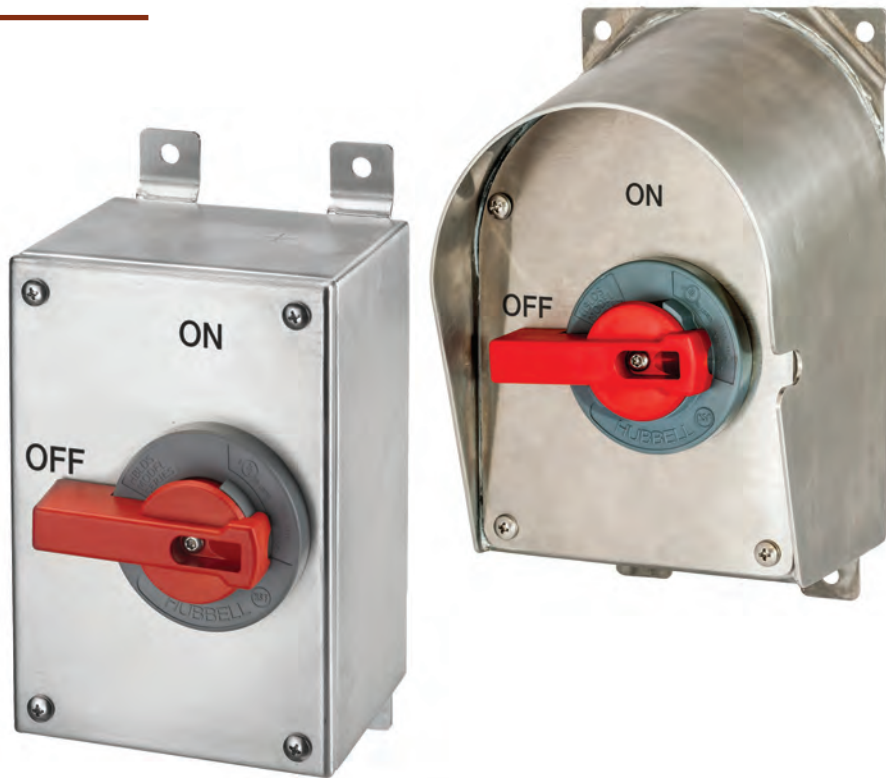

More than ever food and beverage processing facilities see the value of investing in intelligent design and following best practices in hygiene.

The sloped top enclosure is consistent with these best practices. Horizontal surfaces have been minimized to assist with getting it clean and keeping it clean.



LED Indicators

- Six highly visible integral phase identification LEDs
- External LEDs provide secondary means of visual confirmation of make/break on all phases



Housing Design

- Sloped top design sheds water and debris
- Fully shrouded handle prevents damage to the handle
- Captive screws prevent lost screws



Jog Switch

- Cost Savings by utilizing existing space in the motor disconnect enclosure reducing parts and labor costs
- Convenience by having point of use control circuit to PLC within line of sight of the motor
- Added Safety by allowing maintenance personnel the functionality to "Try Out" after Lockout/Tagout

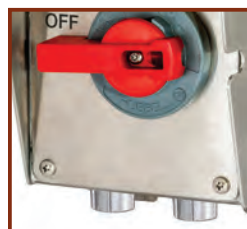

Labor Savings

- 15° Sloped Top version available pre-drilled with 3/4 inch stainless steel hubs for bottom feed applications
- Ample gutter space for hassle free installation

Stainless Steel Circuit-Lock® Unfused Switched Disconnect Enclosures*

Description	30 Amp	60 Amp	100 Amp
Square Top disconnect switch.	HBLDS3SS	HBLDS6SS	HBLDS10SS
Square Top disconnect switch with HBLAC1 auxiliary contact.	HBLDS3SSAC	HBLDS6SSAC	HBLDS10SSAC
Square Top disconnect switch for use with variable frequency drives.	HBLDS3SSVFD	HBLDS6SSVFD	HBLDS10SSVFD
Sloped Top disconnect switch.	HBLDS3SSR	HBLDS6SSR	HBLDS10SSR
Sloped Top disconnect switch with HBLAC1 auxiliary contact.	HBLDS3SSRAC	HBLDS6SSRAC	HBLDS10SSRAC
Sloped Top disconnect switch for use with variable frequency drives.	HBLDS3SSRVFD	HBLDS6SSRVFD	HBLDS10SSRVFD
Sloped Top disconnect, Pre-drilled 4X with (2) 3/4 inch stainless steel hubs.	HBLDS3SSR2K	—	—
Sloped Top enclosure, Blank.	HBLDSSRNK3	HBLDSSRNK6	—



HBLDS3SS



HBLDS3SSJ

Stainless Steel Disconnects with Jog Switch

Description	30 Amp	60 Amp	100 Amp
Square Top disconnect	HBLDS3SSJ	HBLDS6SSJ	HBLDS10SSJ
Square Top disconnect with Jog switch and LEDs	—	HBLDS6SSPJ	HBLDS10SSPJ
Sloped Top disconnect	HBLDS3SSRJ	HBLDS6SSRJ	HBLDS10SSRJ
Sloped Top disconnect with Jog switch and LEDs	HBLDS3SSRPJ	HBLDS6SSRPJ	HBLDS10SSRPJ

Unfused Disconnect Switches with LEDs

Description	30 Amp	60 Amp	100 Amp
Stainless Steel square top disconnect switch with LEDs	HBLDS3SSP	HBLDS6SSP	HBLDS10SSP
Stainless Steel square top disconnect switch with HBLAC1 auxiliary contact	—	HBLDS6SSPAC	—
Stainless Steel sloped top disconnect switch with LEDs	HBLDS3SSRP	HBLDS6SSRP	HBLDS10SSRP
Stainless Steel sloped top disconnect switch with HBLAC1 auxiliary contact	—	HBLDS6SSRPAC	HBLDS10SSRPAC

Note: *Certified by NSF, International.
For use with 3Ø Y configurations only.



HBLDS3SSR

Stainless Steel Conduit Hubs

Description	Catalog Number
3/4 inch stainless steel conduit hub.	HUB75SS
1 1/4 inch stainless steel conduit hub.	HUB125SS



HBLDS3SSRPJ

Auxiliary Contacts for 30, 60 and 100 Amp Switch, NEMA A600 Pilot Duty

Description	Catalog Number
"Break After Main Break", 1 set of n/o contacts, 1 set of n/c contacts.	HBLAC1**
"Break Before Main Break", 1 set of n/o contacts for use with variable frequency drives.	HBLAC2**
"Break After Main Break", 2 sets of n/o contacts, 2 sets of n/c contacts	HBLAC11

Note: *Certified by NSF, International.

**Up to two auxiliary contacts per enclosure. Not for use with HBLDS33ACNK.
30A Units are supplied with one 3/4 in. NPT Raintight conduit fitting.
60A and 100A Units are supplied with two 1 1/4 in. NPT Raintight conduit fittings.



HUB125SS

HUB75SS



HBLAC1

HBLAC2



HBLDSSRNK3



HBLDS30RCP

Non-Metallic Sloped Replacement Covers

Description		30 Amp	60 Amp	100 Amp
For Non-Metallic Sloped Top Disconnects - HBLDS30, HBLDS60 and HBLDS100 variations	Standard	HBLDS30RC	HBLDS60RC	HBLDS100RC
	with LEDs	HBLDS30RCP	HBLDS60RCP	HBLDS100RCP
(Works with Fully Rounded and Round Top feed versions)	with Jog switch	HBLDS30RCJ	HBLDS60RCJ	HBLDS100RCJ
	with LEDs and Jog	HBLDS30RCPJ	HBLDS60RCPJ	—



HBLDS30RC

Stainless Steel Replacement Covers

Description		30 Amp	60 Amp	100 Amp
For square top disconnect switches.	Standard	HBLDS3SSRC	HBLDS6SSRC	HBLDS10SSRC
	with LEDs.	HBLDS3SSRCP	HBLDS6SSRCP	HBLDS10SSRCP
	with Jog switch.	HBLDS3SSRCJ	HBLDS6SSRCJ	HBLDS10SSRCJ
	with LEDs and Jog.	—	HBLDS6SSRCPJ	HBLDS10SSRCPJ
For sloped top disconnect switches.	Standard	HBLDS3SSRRC	HBLDS6SSRRC	HBLDS10SSRRC
	with LEDs.	HBLDS3SSRRCP	HBLDS6SSRRCP	HBLDS10SSRRCP
	with Jog switch.	HBLDS3SSRRCJ	HBLDS6SSRRCJ	HBLDS10SSRRCJ
	with LEDs and Jog.	—	HBLDS6SSRRCPJ	HBLDS10SSRRCPJ



HBLDS3SSRC

Variable Frequency Drive Diagram

When installing a disconnect in series with a VFD it is critical to include the correct auxiliary contact. Through extensive testing, Hubbell has determined the timing of our early break auxiliary contact HBLAC2 safely disconnects the power by signaling the VFD that the motor disconnect is being turned OFF. The VFD then executes a coast-to-stop preventing any damage to the disconnect switch and the VFD output device.

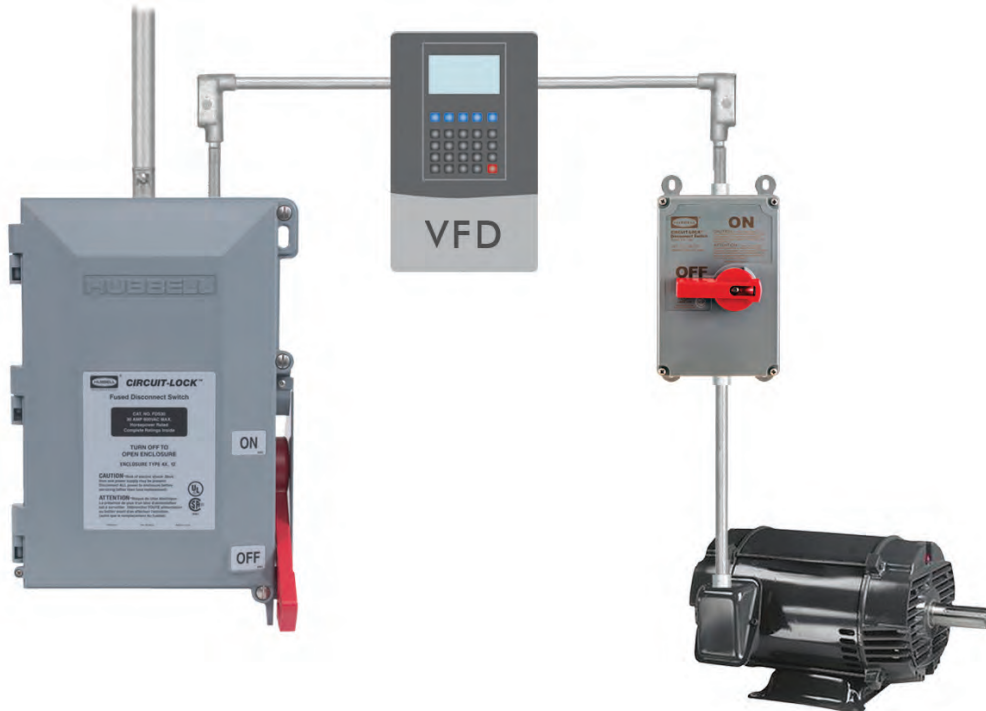

HBLDS3SSRRC



HBLDS3SSRRCP

Switched Disconnects and Enclosures

Dimensions

Key	Sloped Non-Metallic				Stainless Steel, Square Top				Stainless Steel, Sloped Top			
	30A		60A/100A		30A		60A/100A		30A		60A/100A	
	inch	(mm)	inch	(mm)	inch	(mm)	inch	(mm)	inch	(mm)	inch	(mm)
A	6	(152)	7.75	(197)	—	—	—	—	—	—	—	—
B	5.3	(135)	7.3	(185)	4.87	(124)	7.30	(185)	5.41	(137)	7.66	(195)
C	4.12	(105)	4.75	(121)	3.30	(84)	5.50	(140)	4.50	(114)	6.45	(164)
D	6.62	(168)	8	(203)	—	—	—	—	—	—	—	—
E	8.17	(208)	10.85	(276)	7.05	(179)	10.30	(262)	8.60	(218)	11.41	(290)
F	8.5	(216)	11	(279)	8.38	(213)	11.63	(296)	8.22	(209)	11.17	(284)
G	4.12	(105)	6.05	(154)	5.39	(137)	5.93	(151)	4.92	(125)	6.10	(155)

Horsepower Ratings

Voltage	30A	30A*	60A	100A
1Ø 120V AC	1	1	7.5	7.5
1Ø 200–240V AC	3	2.5	15	15
1Ø 480V AC	5	5	30	30
3Ø 200–240V AC	7.5	5	30	30
3Ø 480V AC	15	10	50	50
3Ø 600V AC	15	10	50	50

Note: *HBLDS33ACNK.

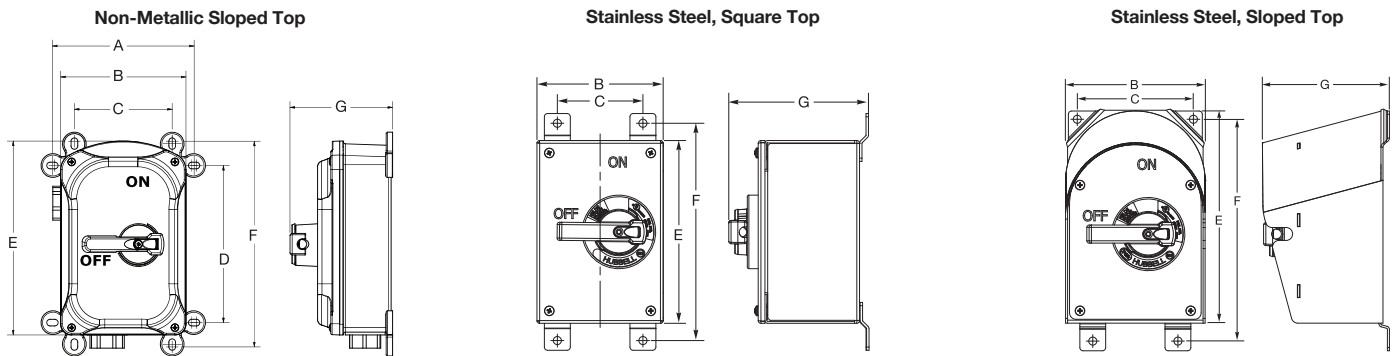

Circuit-Lock® Unfused Disconnect Switches

Specifications

Moisture Resistance

Indoor and Outdoor – Type 4X (Wash down, Corrosion resistant);
Indoor – 30, 60A and 100A Type 12 (Dust-tight, Falling Dirt, Noncorrosive Liquids).
UL94-5VA and V0 Classification.

Flammability

Operating Temperature

Maximum Continuous 75°C; Minimum Continuous -40°C without impact.

UV Resistance

All materials are UV stabilized.

Dielectric Voltage

Withstands 3000V AC minimum.

Max. Working Voltage

600V AC RMS.

Current Interrupting

Certified for current interrupting at full rated current and voltage.

Short Circuit Current Ratings (SCCR):
(Motor Disconnect)

- 30/60/100A: Suitable for use on a circuit capable of delivering not more than 10kA RMS symmetrical, 600V AC max.
- 30A: Suitable for use on a circuit capable of delivering not more than 65kA RMS symmetrical, 600V AC max. when protected by Class J fuses rated 30A max.
- 60/100A: Suitable for use on a circuit capable of delivering not more than 65kA RMS symmetrical, 600V AC max. when protected by Class J fuses rated 100A max.

Terminal Identification

In accordance with UL, CSA and international conventions.

Product Identification

Identification and ratings are part of external label.

Mounting

Non-Metallic - External fully adjustable feet. Stainless Steel - Feet are fixed.

Impact Resistance

In accordance with UL 746C.

Materials

Part	Non-Metallic	Stainless Steel
Base	PBT	#14 Gauge Type 304 Stainless Steel
Top	PBT	#14 Gauge Type 304 Stainless Steel
Handle	PBT	PBT
Conduit Hub	Zinc 30A Unfused - ¾ in. Zinc 60/100A Unfused - 1¼ in.	Zinc 30A - ¾ in. Zinc 60/100A - 1¼ in.
Enclosure Gasket	Neoprene	Neoprene
Shaft (Unfused)	PBT	PBT
Shaft Seal	Molded Neoprene	Molded Neoprene
Frame	Galvanized Steel	N/A
Enclosure Screws	Stainless Steel 300 Series	Stainless Steel

Dimensions in Inches (mm)

Features and Benefits

Non-Metallic Labelless Circuit-Lock® Switched Disconnect Enclosures

NEC section 430.102(B) requires each motor controller to have a disconnect within line of sight from the motor and driven equipment. Hubbell's Circuit-Lock® Unfused Disconnect Switches are UL listed as a manual motor controller and also "suitable as a motor disconnect" and meet these code requirements.

- Constructed from corrosion and impact resistant UV stabilized non-metallic material
- IP69k and Type 4X, 12K water ingress protection
- Certified by NSF for hygiene in food processing applications
- Highly visible red handle which meets OSHA Lockout/Tagout capabilities
- Cover cannot be removed with switch in the "ON" position
- Accepts up to 2 Auxiliary contacts
- Reversible interior accommodates top or bottom conduit opening



Enhanced Features:

- Adjustable mounting feet are now 40% stronger to help prevent nuisance breakage
- Product ratings are permanently laser-marked to the HBLDS3 devices and will not wash off
- Truly captive screws prevent lost screws
- Now shipped from factory as bottom feed for quicker installation in 4X applications



LED Indicators

- Six highly visible integral phase identification LEDs
- External LEDs provide secondary means of visual confirmation of make/break on all phases



Variable Frequency Drive (VFD)

- Integrates a verified break before break auxiliary contact factory installed in our HBLDS series
- Prevents downtime from out of sequence equipment shutdowns



Jog Switch

- Cost savings by utilizing existing space in the motor disconnect enclosure reducing parts and labor costs
- Convenience by having point of use control circuit to PLC within line of sight of the motor
- Added safety by allowing maintenance personnel the functionality to "Try Out" after Lockout/Tagout



MotorQuick® Version

- Significantly reduces the time it takes to replace motors by combining the plug-and-play technology of the LINKOSITY® power system
- Motor rotation can be pre-checked in a maintenance shop to further speed the installation

Switched Disconnects and Enclosures

Non-Metallic Labelless Circuit-Lock® Switched Disconnect Enclosures*

Description	30 Amp	60 Amp	100 Amp
Disconnect switch.	HBLDS3	HBLDS6	HBLDS10
Disconnect switch with HBLAC1 auxiliary contact.	HBLDS3AC	HBLDS6AC	HBLDS10AC
Disconnect switch for use with variable frequency drives.	HBLDS3VFD	HBLDS6VFD	HBLDS10VFD
Disconnect switch without conduit knockout or conduit fitting.	HBLDS3NK	—	—
Disconnect switch with HBLAC1 auxiliary contact without conduit knockout or conduit fitting.	HBLDS3ACNK	—	—
Disconnect switch with 3 auxiliary contacts, without conduit knockouts. Break before main break – 1 set “normally open”, 1 set “normally closed”. Break after main break – 2 sets “normally open”, 1 set “normally closed”.	HBLDS33ACNK	—	—



HBLDS3

Non-Metallic Labelless Disconnects with Jog Switch*

Description	30 Amp	60 Amp	100 Amp
Disconnect switch.	HBLDS3J	HBLDS6J	HBLDS10J
Disconnect switch with HBLAC1 auxiliary contact.	HBLDS3ACJ	—	—
Disconnect switch for use with variable frequency drives.	HBLDS3VFDJ	—	—
Disconnect switch with Jog switch and LEDs.	HBLDS3PJ	HBLDS6PJ	HBLDS10PJ



HBLDS3VFD

Unfused Disconnect Switches with LEDs*

Description	30 Amp	60 Amp	100 Amp
Non-Metallic disconnect switch with LEDs	HBLDS3P	HBLDS6P	HBLDS10P
Non-Metallic disconnect switch with HBLAC1 auxiliary contact	HBLDS3PAC	HBLDS6PAC	HBLDS10PAC

Note: *Certified by NSF, International.

LED version for use with 3Ø Y configurations only.



HBLDS3J

Auxiliary Contacts for 30, 60 and 100 Amp Switch, NEMA A600 Pilot Duty

Description	Catalog Number
“Break After Main Break”, 1 set of n/o contacts, 1 set of n/c contacts.	HBLAC1**
“Break Before Main Break”, 1 set of n/o contacts for use with variable frequency drives.	HBLAC2**

Note: **Up to two auxiliary contacts per enclosure. Not for use with HBLDS33ACNK.

30A Units are supplied with one 3/4 in. NPT Raintight conduit fitting.

60A and 100A Units are supplied with two 1 1/4 in. NPT Raintight conduit fittings.

Replacement Accessories

	Switch	Mounting Feet	Ground Block	Neutral Block
For 30A switches	HBLDS3RS	HBLRFT1	HBL30RGB	HBL30RNB
For 60A switches	HBLDS60100RS	HBLRFT2	HBL60100RGB	HBL60RNB
For 100A switches	HBLDS60100RS	HBLRFT2	HBL60100RGB	HBL100RNB
	HBLDS33ACRS	HBLRFT1	HBL30RGB	HBL30RNB

Non-Metallic

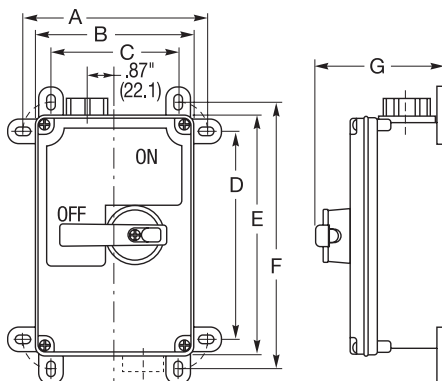

Dimensions

Key	Labelless Non-Metallic			
	30A		60A/100A	
	inch	(mm)	inch	(mm)
A	6.00	(152)	7.75	(197)
B	5.12	(130)	6.87	(175)
C	4.12	(105)	4.75	(121)
D	6.62	(168)	8.00	(203)
E	7.62	(194)	9.95	(253)
F	8.50	(216)	11.00	(279)
G	4.12	(105)	5.94	(151)



HBLDS3P

Switched Disconnects and Enclosures

Plug and Play Technology

MotorQuick® significantly reduces the time it takes to replace motors by combining the plug-and-play technology of the LINKOSITY® power system with the versatility of Circuit-Lock® motor disconnect switches. Quick disconnect terminations will reduce motor change-out time by approximately 65%. Keeping spare motors

already pre-wired with a LINKOSITY® inlet enables wiring to be done off-line when it is convenient, not critical. Motor rotation can be pre-checked in a maintenance shop to further speed the installation. The net result is that equipment is up and running in a fraction of the time, helping improve the bottom line.



MotorQuick® Cost of Ownership Analysis

Traditional Motor Changeout

Catalog Number	Total Material Cost	Labor Cost/ Hr	Downtime	Total Labor Cost	Downtime Cost/hr	Total Downtime Cost	Total Cost
HBL1389D	\$106.00	\$53.00	1 hour	\$53.00	\$750.00	\$750.00	\$909.00
HBLDS3	\$185.00	\$53.00	1 hour	\$53.00	\$750.00	\$750.00	\$988.00

MotorQuick® Motor Changeout

Catalog Number	Total Material Cost	Labor Cost/ Hr	Downtime	Total Labor Cost	Downtime Cost/hr	Total Downtime Cost	Total Cost	Total Savings
HBL1389MQ*	\$299.00	\$53.00	20 minutes	\$17.67	\$750.00	\$250.00	\$566.67	\$342.33
HBLDS30MQ	\$411.00	\$53.00	20 minutes	\$17.67	\$750.00	\$250.00	\$678.67	\$309.33

Note: *MotorQuick catalog numbers are based on the average cost of the various designs.



IP67
SUITABILITY

Housing Design

- Thermoplastic Cover on Plated Steel Base
- NEMA 1 Enclosure
- Pre-wired with LINKOSITY® Components
- Crush and Impact Resistance of MC Cable



HBL1389MQ5

Housing Design

- High Impact PBT Enclosure
- Type 4X Enclosure
- Permanent Labelless Marking
- Lockable Handle to Meet OSHA Lockout/Tagout Regulations
- Cable Ratings: TC-ER, MTW, STOOW



HBLDS30MQ5

MotorQuick® Disconnect Switches

Type 1 Non-Metallic Enclosure 30A 3 Pole 600V AC	Catalog Number	
HBL1389D with one pre-wired LINKOSITY® female receptacle (load side).	HBL1389MQR	
HBL1389D with 5 foot pre-wired LINKOSITY® female cable (load side).	HBL1389MQ5	
HBL1389D with one pre-wired LINKOSITY® male receptacle (line side) and one pre-wired LINKOSITY® female receptacle (load side).	HBL1389MQR2	
Type 4X Non-Metallic Labelless Enclosure 30A 3 Pole 600V AC	Catalog Number	
HBLDS3 with one pre-wired LINKOSITY® female receptacle (load side).	HBLDS30MQR	
HBLDS3 with 5 foot pre-wired LINKOSITY® female cable (load side).	HBLDS30MQ5	
HBLDS3 with one pre-wired LINKOSITY® male receptacle (line side) and one pre-wired LINKOSITY® female receptacle (load side).	HBLDS30MQR2	
Type 4X Stainless Steel Enclosure 30A 3 Pole 600V AC	Catalog Number	
HBLDS3SS with one pre-wired LINKOSITY® female receptacle (load side).	HBLDS3SSRMQR	
HBLDS3SS with 5 foot pre-wired LINKOSITY® female cable (load side).	HBLDS3SSRMQ5	
HBLDS3SS with one pre-wired LINKOSITY® male receptacle (line side) and one pre-wired LINKOSITY® female receptacle (load side).	HBLDS3SSRMQR2	
	Sloped Top	Square Top
HBLDS3SS with one pre-wired LINKOSITY® female receptacle (load side).	HBLDS3SSRMQR	HBLDS3SSMQR
HBLDS3SS with 5 foot pre-wired LINKOSITY® female cable (load side).	HBLDS3SSRMQ5	HBLDS3SSMQ5
HBLDS3SS with one pre-wired LINKOSITY® male receptacle (line side) and one pre-wired LINKOSITY® female receptacle (load side).	HBLDS3SSRMQR2	HBLDS3SSMQR2



HBL1389MQR2



HBLDS30MQR



HBLDS3SSRMQR



HBLDS3SSMQR

Accessories

Description	Catalog Number
3P 4W LINKOSITY® male receptacle for installation on motor.	RM3004PA001
3P 4W LINKOSITY® female receptacle for installation in switch.	RF3004PA001
3P 4W LINKOSITY® double ended (male/female) 5-50 foot cable.	PH3004PAxxx*
3P 4W LINKOSITY® single ended (female) 5-50 foot cable.	PF3004PAxxx*
Cord connector, ¼ in. NPT .63-.75 in. (16.0-19.1) diameter.	SHC1037CR
Lock-on cover for LINKOSITY® connections.	PH2030C

Note: *Cables available from 5-50 feet in 5 foot increments. To purchase larger cable, replace the **xxx** with the required length in feet. (Examples: PH3004PA005 = 5 foot cable, PH3004PA050 = 50 foot cable.)

Sample Set Up

(1) HBLDS3MQR + (1) PH3004PAxxx + (1) RM3004PA001 = Total Set Up**

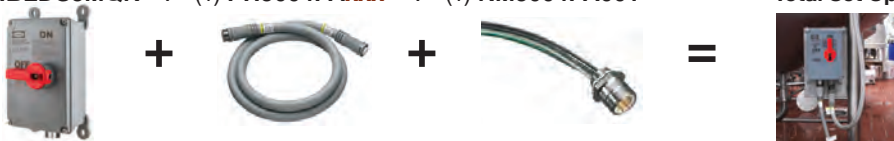

Note: ** Retrofit parts available for pre-existing disconnect switch installations. Please consult factory for availability.



PH2030C

Switched Disconnects and Enclosures

Dimensions

Type 1

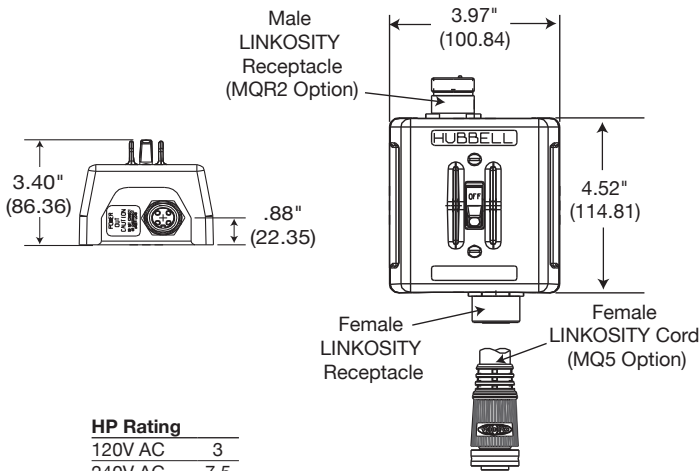

HP Rating	
120V AC	3
240V AC	7.5
480V AC	15
600V AC	20

Type 4X

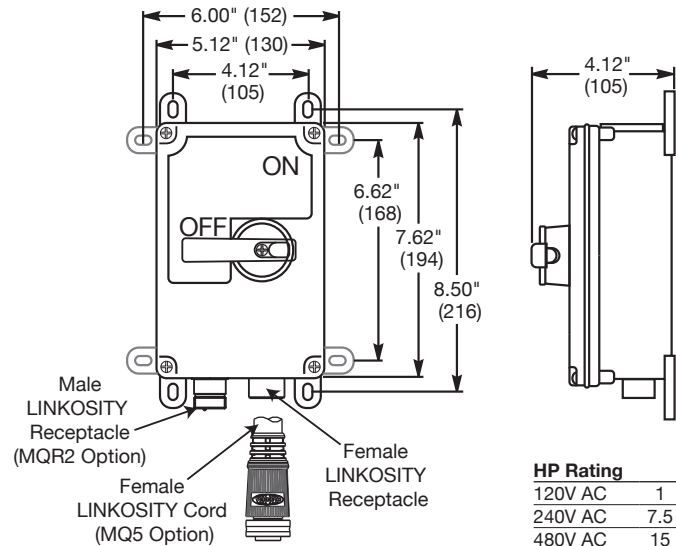

HP Rating	
120V AC	1
240V AC	7.5
480V AC	15
600V AC	15

Hubbell-PRO 30 & 60A Motor Disconnects

Hubbell-PRO motor disconnects are value engineered for commercial and light duty applications. They are available in 30A and 60A versions with optional early break auxiliary contacts for use with VFDs and other auxiliary equipment.

Features

- UL 508 / UL 60947-4-1
- HP Rated
- Type 4X, 12
- Accepts up to 2 Auxiliary Contacts
- OSHA Compliant LO/TO Handle
- Compact, Installation Friendly Enclosure



Ordering Information

Catalog Number	Amps	Description	HP Rating			NO & NC Aux Contacts*	2 NO Aux Contacts*
			240 3ØVAC	480 3ØVAC	600 3ØVAC		
MD30	30 Amp	Disconnect Enclosure	7.5	15	15	MDAC2	MDAC2NO
MD30XL	30 Amp	XL Disconnect Enclosure	7.5	15	15	MDAC2	MDAC2NO
MD60	60 Amp	Disconnect Enclosure	20	40	40	MDAC2	MDAC2NO

*Break before main action

30 Amp Accessories

30 Amp	Catalog Number
Ground Module	MDGB
Neutral Pole	MDNB
30A Additional Pole	MD4P

60 Amp Accessories

60 Amp	Catalog Number
Ground Module	MD60GB
Neutral Pole	MD60NB

Materials

Cover	Polycarbonate
Base	Polycarbonate
Handle	Polycarbonate
Assy. Screws	Stainless Steel

Dimensions in Inches (mm)

Switched Disconnects and Enclosures

Features and Benefits

Circuit-Lock® 200A Disconnect Switches

Hubbell's 200A Disconnect Switches are the latest addition to the Circuit-Lock® family of switched enclosures. The enclosures are designed to withstand harsh environments with exposure to water, chemicals, oils and frequent washdowns. Available in non-metallic or stainless steel, the enclosures are UL Listed Type 4X and 12.

- UL 98 Rated Switch
- Non-Metallic and Stainless Steel
- Type 4X, 12
- Accepts up to 2 Auxiliary Contacts
- Highly Visible Red Rotary Handle
- OSHA Compliant Lockout/Tagout Handle
- Unable to Open the Cover when ON; Cover Locked when Energized
- 200kA SCCR Rating when Protected by a Class "J" Fuse

Designed to Withstand Harsh Environments



HBLDS20

HBLDS20SS

Circuit-Lock® 200A Disconnect Switches

Description	Catalog Number
200A non-metallic disconnect.	HBLDS20
200A stainless steel disconnect.	HBLDS20SS
N/O auxiliary contact - "Break Before Main".	HBLAC200
200A replacement switch.	HBLDS20RS
200A replacement handle.	HBL200HDL

Materials - 200A Disconnect Switches

Description	Non-Metallic		Stainless Steel	
	Material	Finish	Material	Finish
Enclosure	FR Polyester	—	14 Ga. 304 SST	Smooth Grain
Handle	Plastic	Red/Yellow	Plastic	Red/Yellow
Switch	Plastic	—	Plastic	—
Backplate	12 Ga. Aluminum	None	14 Ga. 304 SST	304 Ann 2B
Terminals	Aluminum	Tin Plated	Aluminum	Tin Plated
Fasteners	Steel	Zinc Plated	Steel	Zinc Plated
Mounting Feet	—	—	304 SST	—

HP Ratings

Voltage	Std HP	Max HP*
120 VAC 1Ø	1.5	10
208-240 VAC 1Ø	3.0	10
240 VAC 3Ø	7.5	75
480 VAC 3Ø	15.0	150
600 VAC 3Ø	15.0	200
120/ 208 VAC 3ØY	7.5	15
277/480 VAC 3ØY	15.0	30
347/ 600 VAC 3ØY	15.0	40

Note: *When used with time delay fuses.

Dimensions

Non-Metallic

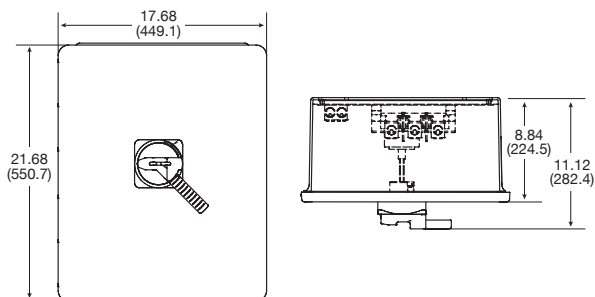

Stainless Steel

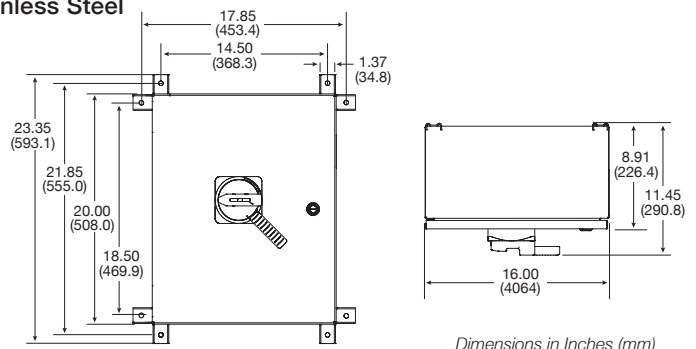

Dimensions in Inches (mm)

Switched Disconnects and Enclosures

Features and Benefits

Circuit-Lock® 30 and 60 Ampere Fused Disconnect Switches

The Circuit-Lock Fused Disconnect Switch provides fused switched control of a directly wired load. The switch cannot be turned ON unless the enclosure cover is closed. The fuses cannot be accessed until the switch is turned OFF. The fuse holder accepts Class “J” fuses. This enclosure is non-metallic and is listed for Outdoor/Indoor (Type 4X Wash down, Corrosion resistant). The handle can be locked in the OFF position to comply with OSHA Lockout/Tagout regulations.

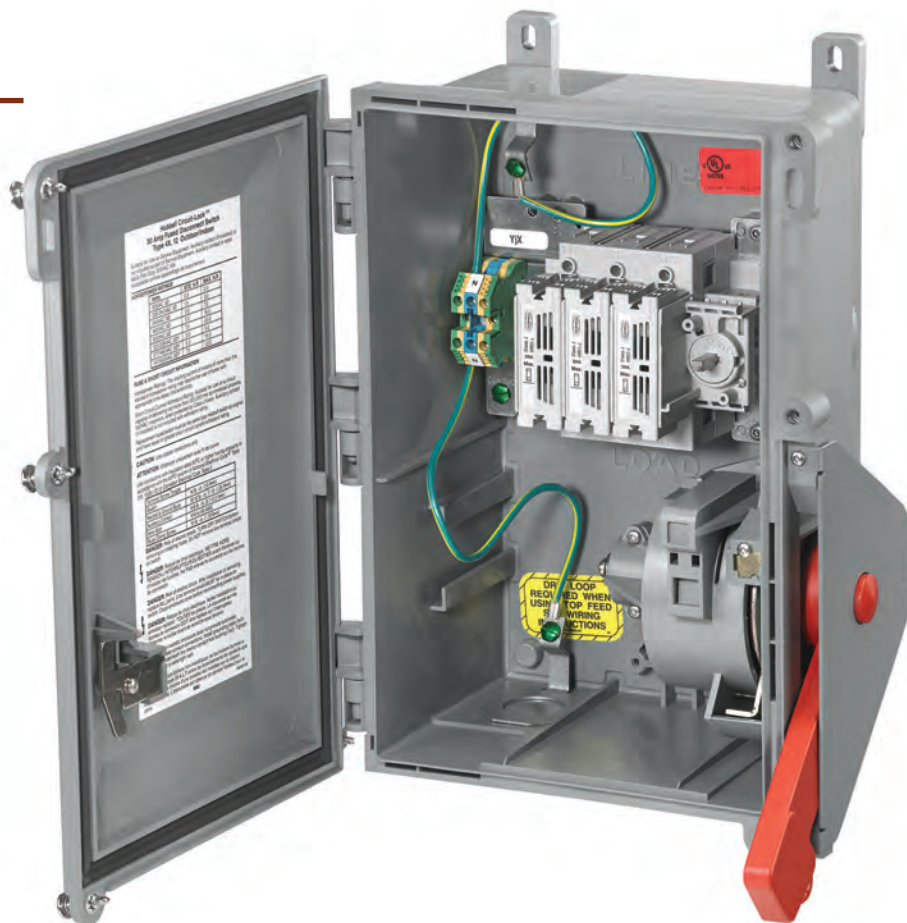

Housing Design

- Non-metallic enclosure meets UL 50E Type 4X (watertight) 12 (dust-tight) and IP66 suitability requirements
- Enclosure is molded of rugged PBT to resist abuse, corrosion and enhance safety
- Stainless steel ¼ in. turn door fasteners for quick, easy access to fuses.



Internal Design

- Fused disconnect switches accept Class “J” fuses
- Internal frame automatically bonds all grounds
- Captured neoprene gasket provides a watertight seal between cover and base



Safety

- Enclosure door can be locked to prevent unauthorized access. Additionally, if the switch is ON, the door cannot be opened
- Lockable highly visible red handle to meet OSHA lockout/tagout
- Safety interlocked fuse access door

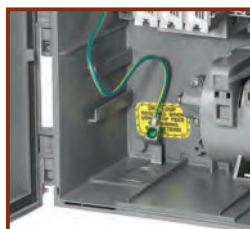

Interior

- Removable door for ease of wiring and installation
- Three molded-in conduit drill points are located on the top, bottom and back surface of enclosure. Conduit hub provided: 30A 1 in. NPT, 60A 1¼ in. NPT



Installation

- Conduit hub and adjustable mounting feet are supplied with each Circuit-Lock® fused disconnect switch.
- Adjustable mounting feet (4) can be mounted in any of three positions for ease of installation



Switch

- Compact Fused Disconnect Switch accepts Class “J” fuses. Fuse holders are top mounted for easy access. The switch accepts auxiliary contacts for control circuit applications including the ON/OFF control of remote pilot lights or signal for programmable controllers.

IP66
SUITABILITY

30 and 60 Amp Fused Disconnect Switches

Description	Catalog Number
30A Circuit-Lock fused disconnect switch.	FDS30*
60A Circuit-Lock fused disconnect switch.	FDS60*

Note: *Class "J" fuses not included.



FDS30

Auxiliary Contacts

Description	Black Style Switch Catalog Number	Gray Style Switch Catalog Number
Auxiliary contact, normally open, A600 pilot duty, break before break.	ACFSNO	HBLACFSNO
Auxiliary contact, normally closed, A600 pilot duty, break before break.	ACFSNC	HBLACFSNC

Note: Auxiliary contacts are specific to the style switch noted and are NOT interchangeable.

Gray Style Switch



HBLACFSNO

HBL30MIFRS

Replacement Switches

Description	Gray Style Switch Catalog Number
For 30A fused switches.	HBL30MIFRS
For 60A fused switches. Gray Style switch will retro fit Black Style switch.	HBL60MIFRS

Watertight Closure Plug Kits

Description	Catalog Number
For 30A Circuit-Lock® unfused and fused Pin and Sleeve mechanical interlocks.	MICPK30
For 60 and 100A Circuit-Lock® unfused and fused Pin and Sleeve mechanical interlocks.	MICPK60

Black Style Switch



ACFSNO

Replacement Mounting Feet

Description	Catalog Number
Replacement mounting feet and screws for 30 and 60A fused mechanical interlocks.	HBLRFT2^A

Note: 30A Units supplied with two 1 in. NPT raintight conduit fittings.
60A Units supplied with two 1¼ in. NPT raintight conduit fittings.
^A Package of 10 feet and 10 screws.



HBLRFT2



MICPK30

Dimensions

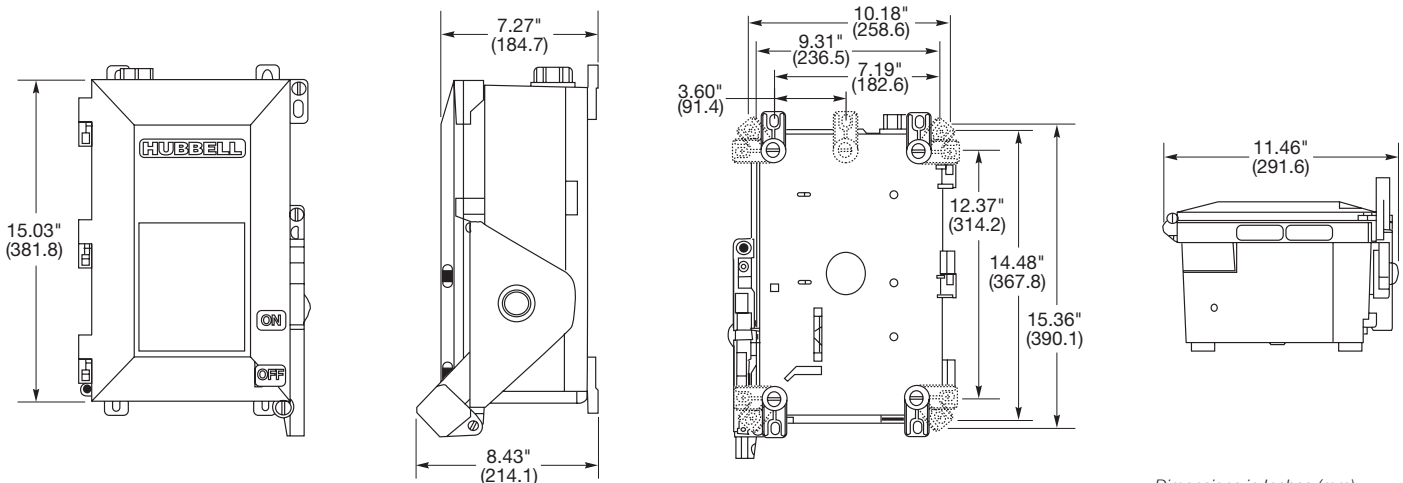

Dimensions in Inches (mm)

Switched Disconnects and Enclosures

Horsepower Ratings

Ratings	Volts	Standard HP	Maximum HP*	Catalog Number
30A	120V AC	0.5	2	FDS30
600V AC	208-240V AC	1.5	3	
Max.	3Ø 240V AC	3	7.5	
	3Ø 480V AC	5	15	
	3Ø 600V AC	7.5	20	
	3Ø Y 120/208V AC	3	5	
	3Ø Y 277/480V AC	5	15	
	3Ø Y 347/600V AC	7.5	20	
60A	120V AC	1.5	3	FDS60
600V AC	208-240V AC	3	7.5	
Max.	3Ø 240V AC	7.5	15	
	3Ø 480V AC	15	30	
	3Ø 600V AC	15	50	
	3Ø Y 120/208V AC	7.5	15	
	3Ø Y 277/480V AC	15	30	
	3Ø Y 347/600V AC	15	40	

Note: *Requires time delay fuses.

Fuse and Short Circuit Information

Horsepower Ratings	The starting current of motors of more than the standard horsepower rating may require the use of fuses with appropriate time-delay characteristics.
Short Circuit Withstand Rating	Suitable for use on a circuit capable of delivering not more than 200,000 RMS symmetrical amperes at the voltage rating of receptacle when protected by Class "J" fuses.

Note: Replacement fused switch must be the same type Hubbell switch as original and have equal or greater short circuit current withstand rating.

Circuit-Lock® Fused Disconnect Switch

Specifications

Moisture Resistance	Indoor and Outdoor – Type 4X (Wash down, Corrosion resistant); Indoor – Type 12 (Dust-tight, Falling Dirt, Noncorrosive Liquids).
Flammability	UL94-5VA and V0 Classification.
Operating Temperature	Maximum Continuous 75°C; Minimum Continuous -40°C without impact.
UV Resistance	All materials are UV stabilized.
Dielectric Voltage	Withstands 3000V AC minimum.
Max. Working Voltage	600V AC RMS.
Impact Resistance	In accordance with UL 746C.
Terminal Identification	In accordance with UL, CSA and international conventions.
Product Identification	Identification and ratings are part of external label.
Mounting	External fully adjustable feet.
Fuse Types	UL Listed, Class "J"; CSA Certified, HRCI-J.

Materials

Part	Material
Base	PBT
Door	PBT
Handle	PBT
Conduit Hub	Zinc, 30A Fused – 1 in., 60A Fused – 1¼ in.
Enclosure Gasket	Neoprene
Shaft	Brass
Shaft Seal	Neoprene
Frame	Galvanized Steel
Ground Plate	Galvanized Steel
Enclosure Screws	Stainless Steel 300 Series

Switched Disconnects and Enclosures

Ratings Quick Reference Guide

Circuit-Lock® Switched Enclosures

Amp Description	Phase	Poles	HP				Catalog Number
			120	240	480	600	
30 TYPE 1 Non-Metallic	3	3	3	7.5	15	20	HBL1389MQR
TYPE 1 Non-Metallic	3	3	3	7.5	15	20	HBL1389MQ5
TYPE 1 Non-Metallic	3	3	3	7.5	15	20	HBL1389MQR2
NEMA 1 Aluminum	1	2	2	5	10	15	HBL1372
NEMA 1 Aluminum	3	3	3	7.5	15	20	HBL1379
NEMA 1 Non-Metallic	1	2	2	5	10	15	HBL1392
NEMA 1 Non-Metallic	3	3	3	7.5	15	20	HBL1389
NEMA 3/3R Non-Metallic	1	2	2	5	10	15	HBL13R22
NEMA 3/3R Non-Metallic	3	3	3	7.5	15	20	HBL13R23
NEMA 3R Die Cast Aluminum	1	2	2	5	10	15	HBL13R12
NEMA 3R Die Cast Aluminum	3	3	3	7.5	15	20	HBL13R13
NEMA 3R Aluminum	1	2	2	5	10	15	HBL13R92
NEMA 3R Aluminum	3	3	3	7.5	15	20	HBL13R89
IP69k TYPE 4X Labelless Non-Metallic	3	3	1	7.5	15	15	HBLDS3
IP69k TYPE 4X Labelless Non-Metallic	3	3	1	7.5	15	15	HBLDS3AC
IP69k TYPE 4X Labelless Non-Metallic	3	3	1	7.5	15	15	HBLDS3NK
IP69k TYPE 4X Labelless Non-Metallic	3	3	1	7.5	15	15	HBLDS3ACNK
IP69k TYPE 4X Labelless Non-Metallic	3	3	1	5	10	10	HBLDS33ACNK
TYPE 4X Labelless Non-Metallic	3	3	1	7.5	15	15	HBLDS3MQR
TYPE 4X Labelless Non-Metallic	3	3	1	7.5	15	15	HBLDS3MQ5
TYPE 4X Labelless Non-Metallic	3	3	1	7.5	15	15	HBLDS3MQR2
IP69k TYPE 4X Stainless Steel	3	3	1	7.5	15	15	HBLDS3SS
IP69k TYPE 4X Stainless Steel	3	3	1	7.5	15	15	HBLDS3SSAC
IP69k TYPE 4X Stainless Steel	3	3	1	7.5	15	15	HBLDS3SSVFD
TYPE 4X Stainless Steel	3	3	1	7.5	15	15	HBLDS3SSMQR
TYPE 4X Stainless Steel	3	3	1	7.5	15	15	HBLDS3SSMQ5
IP69k TYPE 4X, 12 and IP69k Sloped, SS	3	3	1	7.5	15	15	HBLDS3SSR
IP69k TYPE 4X, 12 and IP69k Sloped, SS	3	3	1	7.5	15	15	HBLDS3SSR2K
IP69k TYPE 4X, 12 and IP69k Sloped, SS	3	3	1	7.5	15	15	HBLDS3SSRVFD
IP69k TYPE 4X, 12 and IP69k Sloped, SS	3	3	1	7.5	15	15	HBLDS3SSRAC
IP69k TYPE 4X, 12 and IP69k Sloped, SS	3	3	1	7.5	15	15	HBLDS3SSRMQR
IP69k TYPE 4X, 12 and IP69k Sloped, SS	3	3	1	7.5	15	15	HBLDS3SSRMQ5
IP69k TYPE 4X, 12 and IP69k Sloped, SS	3	3	1	7.5	15	15	HBLDS3SSRMQR2
TYPE 4X Non-Metallic Fused Disconnect	3	3	1	7.5	15	20	FDS30
NEMA 4X Stainless Steel	3	3	3	7.5	15	20	HBL13S33D
NEMA 4X Non-Metallic	3	3	3	7.5	15	20	HBL13X33D
60 NEMA 3R Aluminum	1	2	—	10	15	20	HBL16R92D
NEMA 3R Aluminum	3	3	—	10	25	30	HBL16R93D
IP69k TYPE 4X Non-Metallic	3	3	7.5	30	50	50	HBLDS6
IP69k TYPE 4X Non-Metallic	3	3	7.5	30	50	50	HBLDS6AC
IP69k TYPE 4X Stainless Steel	3	3	7.5	30	50	50	HBLDS6SS
IP69k TYPE 4X Stainless Steel	3	3	7.5	30	50	50	HBLDS6SSAC
IP69k TYPE 4X, 12 and IP69k Sloped, SS	3	3	7.5	30	50	50	HBLDS6SSR
IP69k TYPE 4X, 12 and IP69k Sloped, SS	3	3	7.5	30	50	50	HBLDS6SSRVFD
IP69k TYPE 4X, 12 and IP69k Sloped, SS	3	3	7.5	30	50	50	HBLDS6SSRAC
TYPE 4X Non-Metallic Fused Disconnect	3	3	3	15	30	40	FDS60
NEMA 4X Stainless Steel	3	3	—	10	25	30	HBL16S63D
NEMA 4X Non-Metallic	3	3	—	10	25	30	HBL16X63D
100 IP69k TYPE 4X Non-Metallic	3	3	7.5	30	50	50	HBLDS10
IP69k TYPE 4X Non-Metallic	3	3	7.5	30	50	50	HBLDS10AC
IP69k TYPE 4X Stainless Steel	3	3	7.5	30	50	50	HBLDS10SS
IP69k TYPE 4X Stainless Steel	3	3	7.5	30	50	50	HBLDS10SSAC
IP69k TYPE 4X, 12 and IP69k Sloped, SS	3	3	7.5	30	50	50	HBLDS10SSR
IP69k TYPE 4X, 12 and IP69k Sloped, SS	3	3	7.5	30	50	50	HBLDS10SSRVFD
IP69k TYPE 4X, 12 and IP69k Sloped, SS	3	3	7.5	30	50	50	HBLDS10SSRAC
200 Type 4X, 12 Non-Metallic			10	75	150	200	HBLDS20
Type 4X, 12 Stainless Steel			10	75	150	200	HBLDS20SS

Note: HP ratings apply to Jog and LED versions.



HBL1379



HBL1389



HBL1392



HBL1372



HBLDS3



FDS30



HBLDS3P



HBLDS3J



HBLDS3MQR



HBLDS3MQ5



HBLDS3SS



HBLDS3SSR



HBLDS20



HBLDS20SS

Features and Benefits

Hazardous Location

Non-Fused Disconnect Switches

Hubbell's hazardous location line of non-fused disconnect switches are typically used for applications with the presence of flammable gasses or vapors, ignitable dusts and fibers. They are also suitable for use in outdoor or indoor damp, wet and dirty locations or in areas where frequent wash downs, heavy rain, or water spray routinely occurs. These switches are compact in size to reduce cost and make it easier to position on the wall or piece of equipment. The enclosures are made of copper-free aluminum and have a polyester/epoxy finish to prevent corrosion. The highly visible handles can be locked out to comply with OSHA Lockout/Tagout regulations.

Class I, Div. 1 & 2, Groups B,C,D

Class I, Zones 1 & 2, Groups IIB+ H2, IIA

Class II, Div. 1 & 2, Groups E,F,G

Class III, NEMA 3, 4, 4X, 7(B,C,D), 9(E,F,G)

Applications

- Grain manufacturing and storage
- Industrial chemical and gas manufacturing
- Petroleum refining
- Fertilizer manufacturing
- Vehicle repair/paint shops
- Coal mining
- Cotton and fabric mills



Housing Design

- Copper-free aluminum construction with electrostatically applied polyester/epoxy finish to prevent corrosion
- Compact NEMA 4X enclosure and footprint allows easy installation in tight locations
- Top and bottom drilled and tapped conduit entrances



Internal Design

- Gasketed flange with O-ring located inside bolt circle to seal out moisture
- Bodies have top and bottom drilled and tapped conduit entrances for power connection



Safety

- Lockable handle to meet OSHA Lockout/Tagout regulations
- For use as motor disconnects



Safety

- Lockable handle to meet OSHA Lockout/Tagout regulations
- Large visible rotary handle with "ON-OFF" indicator allows a quick means of disconnecting power
- For use as motor disconnects



Installation

- Fewer cover bolts reduces installation and maintenance time
- Removable ductile mounting lugs adjust to irregular mounting surfaces
- 316 Stainless steel bolts



Switch

- Disconnects contain UL98 certified switch
- MI include UL508/UL60947 disconnect switch
- Optional to add one (1) N/O "Break Before Main Break" auxiliary contact

Standard Materials/Finish

- Enclosures: Copper-free aluminum (less than 4/10 of 1% copper content)
- Cover Bolts: 316 Stainless Steel
- Finish: Grey Powder Polyester painted exterior, electrostatically applied
- Ratings: 600V AC, 230V DC 30–100 Amp
- Optional to include up to one (1) N/O “Break Before Main Break” auxiliary contact



HBLB7NFD13A



HBLB7NFD26A

Unfused Hazardous Location Disconnect Switches

Description	30 Amp	60 Amp	100 Amp
3 Pole disconnect switch.	HBLB7NFD13A	HBLB7NFD26A	HBLB7NFD21A
3 Pole disconnect switch with auxiliary contact.	HBLB7NFD13AA	HBLB7NFD26AA	HBLB7NFD21AA
“Break Before Main Break”, 1 set of n/o contacts for use with variable frequency drives.	HBLB7AC2		

Note: 30A bodies have 1 inch top and bottom drilled and tapped conduit entrances.
60A and 100A bodies have 1-1/2 inch top and bottom drilled and tapped conduit entrances.

Disconnect Horsepower Ratings

Switch Amps/Phase	Single Phase HP			Three Phase HP			DC HP	Terminal Wire Size	Conduit Sizes	Catalog Number
	120V AC	230V AC	208V AC	230V AC	480V AC	600V AC	230V DC			
30A / 3P	2	5	10	10	20	30	1	#14-10	1 NPT	HBLB7NFD13A
60A / 3P	3	7.5	20	20	40	40	10	#14-4	1½ NPT	HBLB7NFD26A
100A / 3P	5	15	25	30	50	50	20	#8-1	1½ NPT	HBLB7NFD21A

Dimensions

	Outside Box			Inside Box				Mounting Dimensions			
	A	B	C	D	E	F	G	H	I	J	K
30 Amp	5¾	8½ ₁₆	6½ ₁₆	3⅝	5	5	3	8	–	–	1
60 & 100 Amp	8	13	7	4	9	6	2	11	6	7	1

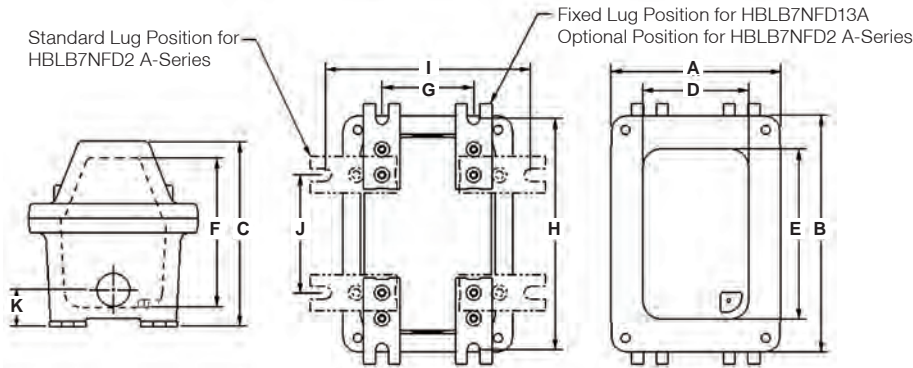

Non-Fused UL1686 Hazardous Location Mechanical Interlocks and Plugs

Amp	Circuit	Mechanical Interlock	Metallic Plug	Insulgrip Plug
30 Amp	2W 3P	HBLVSQ3023	HBLVP3385	HBL330PS2W
600V AC	3W 4P	HBLVSQ3034	HBLVP3485	HBL430PS2W
60 AMP	2W 3P	HBLVSQ6023	HBLVP6385	HBL360PS2W
600V AC	3W 4P	HBLVSQ6034	HBLVP6485	HBL460PS2W

Note: Early break contact comes standard with mechanical interlocks.

HBLVSQ 30 Amp models come standard with 1 inch drilled and tapped conduit openings top and bottom plus two 1 inch x 3/4 inch reducers and one 3/4 inch close-up plug for maximum flexibility. 60 amp models come with one 1 1/2 inch opening on top and bottom and one 1 1/2 inch close-up plug.

See page G-44 for Dimensions on Mechanical Interlocks and Plugs.



HBLVSQ3034



HBLVP3485



HBL430PS2W

Horsepower Ratings (VAC)*

Amp	Circuit	120	240	480	600	Catalog Number
30 Amp	1Ø	2	5	10	15	HBLVSQ3023
	3Ø	3	7.5	15	20	HBLVSQ3034
60 Amp	1Ø	–	10	15	20	HBLVSQ6023
	3Ø	–	10	25	30	HBLVSQ6034

Note: *Internal switch only.

Dimensions in Inches (mm)

Switched Disconnects and Enclosures

Features and Benefits

30A AC Manual Toggle Controllers/Disconnects

The most complete offering of Circuit-Lock® controllers rated “Suitable as Motor Disconnect” with top horsepower and high amperage ratings in such a compact device.



Ample wiring room for installation with # 10AWG
In a Standard FD Box



Housing Design

- Withstands high temperatures
- Excellent dimensional stability
- Superior dielectric strength



Internal Design

- Strong ON/OFF action with quick-make, slow break operation
- Provides long-life reliability
- 10,000 Amp high fault short circuit withstand rating



Installation Efficiencies

- Slim body is 34% smaller than legacy design
- Easily fits in to FD box with #10AWG

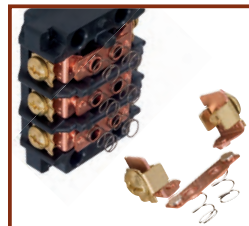

Contacts

- Four large silver alloy contacts per pole has excellent conductivity with maximum longevity
- 100% Copper contact arm has high heat management and reliability



Installation

- #10 Brass terminal screw with clamping plate for secure back or side wiring (30A only)
- Front and back wiring steel screws and copper terminals



Switch

- Lubrication-free controller with continued ON/OFF cycling even in harsh, dust and high heat environments

Switched Disconnects and Enclosures

600V AC Manual Toggle Controllers/Disconnects

For use in almost any industrial environment. Ideal component switch for motor control and as a disconnect. Toggle controllers can be built into equipment and enclosures for either box or panel-mount installation.

Amp	Poles	ToggleType	Wire	HP Rating				Catalog Number
				120V AC 1Ø	240V AC 3Ø	480V AC 3Ø	600V AC 3Ø	
30	2	Standard	Back/Side	2	5	10	15	HBL7832
	2	Short	Back/Side	2	5	10	15	HBL7832S
	3	Standard	Back/Side	3	7.5	15	20	HBL7810
	3	Short	Back/Side	3	7.5	15	20	HBL7810S
40	2	Standard	Side	2	5	10	15	HBL7842D
	3	Standard	Side	3	7.5	15	20	HBL7843D
50	2	Standard	Side	2	5	10	15	HBL7852D
	3	Standard	Side	3	7.5	15	25	HBL7853D
60	2	Standard	Back	—	10	15	20	HBL7862D
	3	Standard	Back	—	10	25	30	HBL7863D
	2	Standard	Front	—	10	15	20	HBL7862FWD
	3	Standard	Front	—	10	25	30	HBL7863FWD
85	2	Standard	Back	—	10	15	20	HBL7882D
	3	Standard	Back	—	10	25	40	HBL7883D
Optional Side Guard, for close wall applications and finger safe environments.								HBLFG30*

Note: *For 30A, 40A and 50A controllers.



Specifications

Electrical Performance		
Dielectric Voltage	Min. 2,200V AC minimum for 1 minute	
Electrical Life	Min. 6,000 Cycles at rated switch load	
Max. Working Voltage	600V AC RMS	
Switches	10,000 RMS	
Short Circuit	30A & 40A	60A max. when protected by J fuses
Withstand Rating	50A	50A max. when protected by J fuses
as Motor Disconnect	60A & 85A	80A max. when protected by J fuses
Short Circuit	30A	60A max when protected by RK5 fuses
Withstand Rating		
as Motor Controller	40A – 85A	125A max. RK5 fuses
Mechanical		
Mechanical Life	Min. 10,000 minimum cycles	
Terminal	Switch Rating	AWG Max.
Accommodations	30A	#10
	40A & 50A	#8**
	60A & 85A	#4
Wire Type	Solid and stranded copper wire only.	
Terminal Torque	30A – 50A	20 inch pounds
Switch Rating	60A – 85A	25 inch pounds
Environmental		
Flammability	UL94HB/VO	
Operating Temp.	Max. 75°C	
	Min. -40°C continuous without impact	
Listings		
UL 508	Industrial Control File #E70402	
CSA-C22.2 No.14	LR-46186	

Note: **Use listed certified ring terminal.

Dimensions

30 Amp Standard Toggles

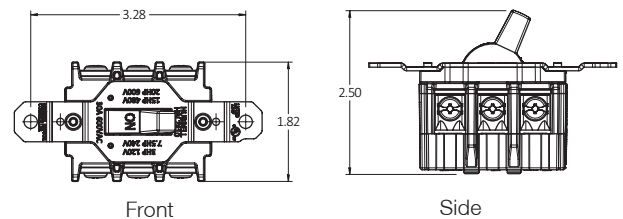

40 and 50 Amp Standard Toggles

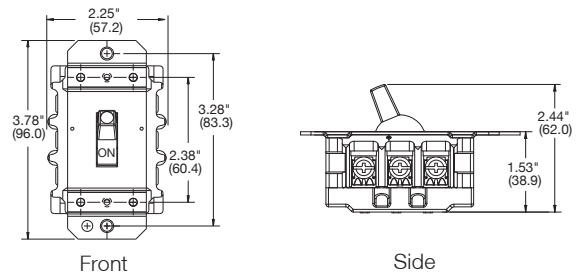

60 and 85 Amp Standard Toggles

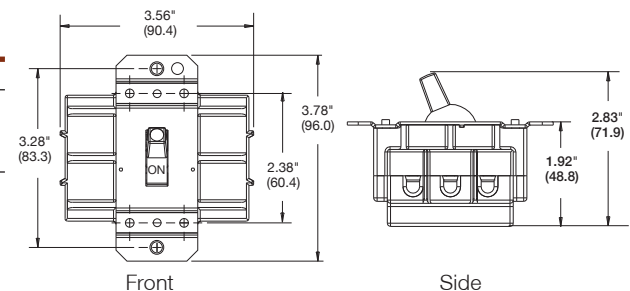

Dimensions in Inches (mm)

Switched Disconnects and Enclosures

NEMA 1 Disconnect Switches

Housing Design

- Thermoplastic cover on a plated steel base
- Durable, non-conductive cover
- Wiring conduit knockouts
- 1/2" and 3/4" NPT
- Top, bottom or back wire entry points
- Surface mount control
- Switch can be locked in the OFF position as a method of compliance with OSHA lockout/tagout



Housing Design

- All aluminum cover and base
- Base is pre-drilled for rear surface mounting
- Wiring conduit knockouts
- 1/2" and 3/4" NPT
- Top, bottom or back wire entry points
- Surface mount control
- Switch can be locked in the OFF position as a method of compliance with OSHA lockout/tagout



HBL1389D



HBL1379D



HBL1390



HBL1370

Circuit-Lock® NEMA 1 Enclosures with Switch

Ideal for use in industrial environments, i.e. conveyer systems, industrial fans, etc.

Amp	Poles	Enclosure Material	HP Rating				Catalog Number
			120V AC 1Ø	240V AC 3Ø	480V AC 3Ø	600V AC 3Ø	
30	2	Thermoplastic	2	5	10	15	HBL1392
30	3	Thermoplastic	3	7.5	15	20	HBL1389
30	2	Aluminum	2	5	10	15	HBL1372
30	3	Aluminum	3	7.5	15	20	HBL1379

Note: See page F-21 for technical information.

Circuit-Lock® NEMA 1 Enclosures without Switch

For use with switches shown on page F-21.

Description	Cover Material	Base Material	No. Equipment Grounds	Catalog Number
For use with 30A switch.	Thermoplastic	Steel	1	HBL1390
For use with 30A switch.	Aluminum	Aluminum	2	HBL1370

Dimensions

HBL1370, HBL1372 and HBL1379

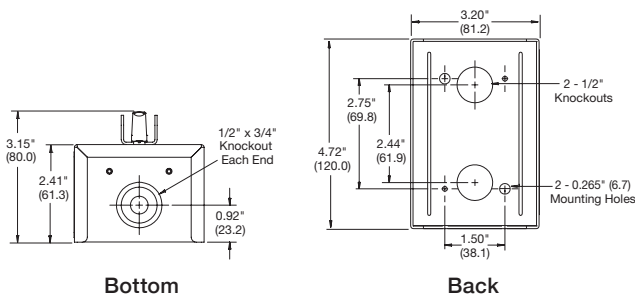

Dimensions in Inches (mm)

HBL1390, HBL1389 and HBL1392

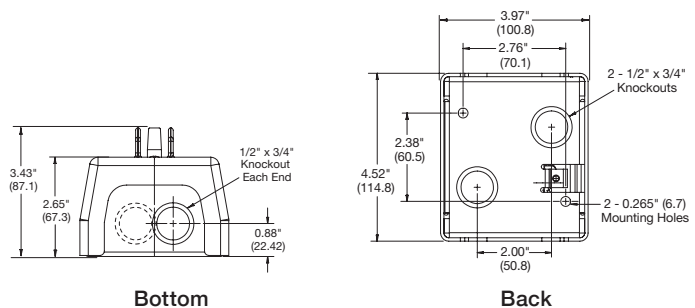

Switched Disconnects and Enclosures

Circuit-Lock® NEMA 3 and 3R Enclosures with Switch

Ideal for use on outdoor equipment.

Amp	Poles	Enclosure Material	Water Ingress	HP Rating				Catalog Number
				120V AC 1Ø	240V AC 3Ø	480V AC 3Ø	600V AC 3Ø	
30	2	Thermoplastic	3	2	5	10	15	HBL13R22
30	3	Thermoplastic	3	3	7.5	15	20	HBL13R23
30	2	Aluminum	3/3R	2	5	10	15	HBL13R12
30	3	Aluminum	3/3R	3	7.5	15	20	HBL13R13

Note: See page F-21 for technical information.
*Drill weephole to alter from NEMA 3 to NEMA 3R.



Dimensions

HBL13R22 and HBL13R23

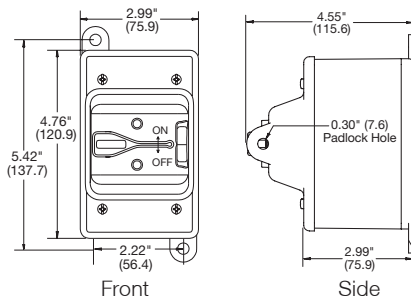

HBL13R12 and HBL13R13

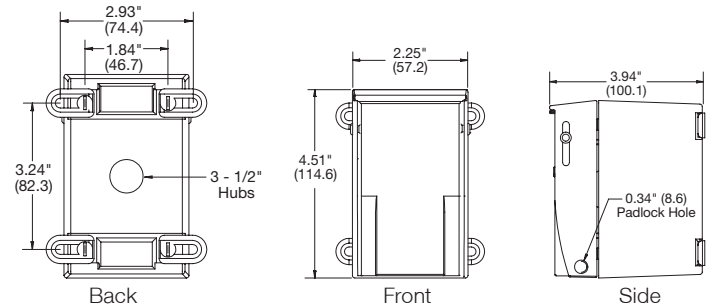

Circuit-Lock® NEMA 3R Enclosures with Switch

Ideal for use in outdoor environments.

Amp	Poles	Enclosure Material	HP Rating				Catalog Number
			120V AC 1Ø	240V AC 3Ø	480V AC 3Ø	600V AC 3Ø	
30	2	Aluminum	2	5	10	15	HBL13R92
30	3	Aluminum	3	7.5	15	20	HBL13R89
60	2	Aluminum	—	10	15	20	HBL16R92D
60	3	Aluminum	—	10	25	30	HBL16R93D

Note: For switch specifications refer to page F-21.



Circuit-Lock® NEMA 3R Enclosures without Switch

For use with switches shown on page F-21.

Description	Enclosure Material	Catalog Number
For use with 30A switch.	Aluminum	HBL13R90
For use with 60A switch.	Aluminum	HBL16R90

Dimensions

HBL13R90, HBL13R89 and HBL13R92

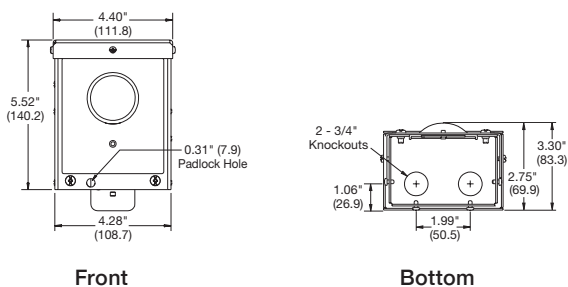

HBL16R90, HBL16R92D and HBL16R93D

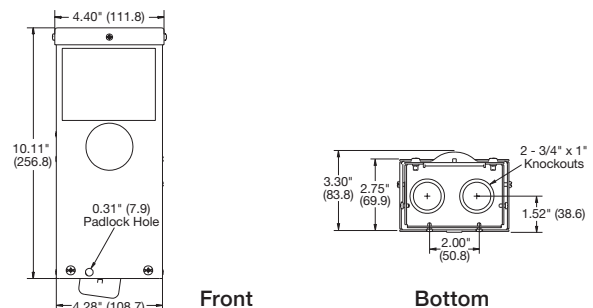

Dimensions in Inches (mm)

Switched Disconnects and Enclosures

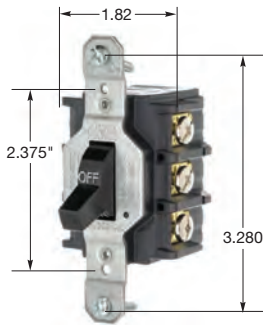

HBL7810

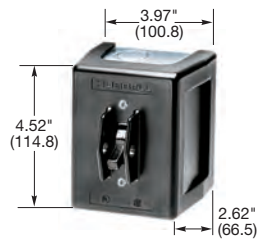

HBL1389

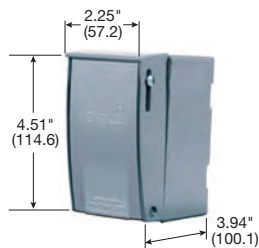

HBL13R13

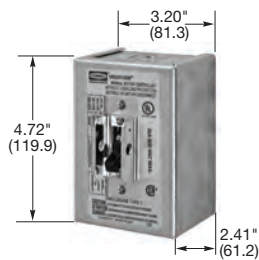

HBL1379

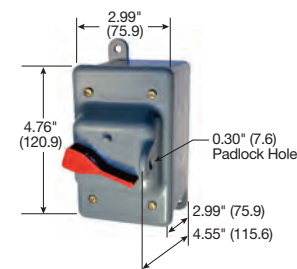

HBL13R23

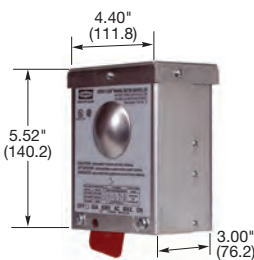

HBL13R89



HBL13S33D

30A 600V AC Manual Motor Controllers, Double Pole

Description	Catalog Number
30A, double pole, single throw, AC manual motor controller, black nylon handle, side and back wired.	HBL7832
30A, double pole, single throw, AC manual motor controller, black nylon handle, short toggle.	HBL7832S
HBL7832D in HBL1390 Type 1 enclosure with non-metallic cover, ½ in. and ¾ in. knockouts on top, bottom and back of steel frame.	HBL1392
HBL7832D in HBL1370 metal Type 1 enclosure.	HBL1372
HBL7832D in NEMA 3R non-metallic enclosure.	HBL13R22
HBL7832D in HBL13R90 metal Type 3R enclosure.	HBL13R92
HBL7832D in NEMA 3R flip-lid enclosure.	HBL13R12

Note: See page F-21 for technical information.

30A 600V AC Manual Motor Controllers, Three Pole

Description	Catalog Number
30A, three pole, single throw, AC manual motor controller, black nylon handle, side and back wired.	HBL7810
30A, three pole, single throw, AC manual motor controller, black nylon handle, short toggle.	HBL7810S
HBL7810D in HBL1390 Type 1 enclosure with non-metallic cover, ½ in. and ¾ in. knockouts on top, bottom and back of steel frame.	HBL1389
HBL7810D in HBL1370 metal Type 1 enclosure.	HBL1379
HBL7810D in NEMA 3R non-metallic enclosure.	HBL13R23
HBL7810D in HBL13R90 metal Type 3R enclosure.	HBL13R89
HBL7810D in NEMA 3R flip-lid enclosure.	HBL13R13
30A, 600V, three pole, rotary controller in NEMA 4X stainless steel enclosure.	HBL13S33D
30A, 600V, three pole, rotary controller in NEMA 4X non-metallic enclosure.	HBL13X33D

Note: See page F-21 for technical information.

Motor Rating

Product	120V AC	240V AC	480V AC	600V AC	Phase
30A Double Pole	2HP	5HP	10HP	15HP	1
30A Three Pole	3HP	7½HP	15HP	20HP	3
40A Double Pole	2HP	5HP	10HP	15HP	1
40A Three Pole	3HP	7½HP	15HP	20HP	3
50A Double Pole	2HP	5HP	10HP	15HP	1
50A Three Pole	3HP	7½HP	15HP	25HP	3
60A Double Pole	-	10HP	15HP	20HP	1
60A Three Pole	-	10HP	25HP	30HP	3
85A Double Pole	-	10HP	15HP	20HP	1
85A Three Pole	-	10HP	25HP	40HP	3

Dimensions in Inches (mm)

Switched Disconnects and Enclosures

IP44*
SUITABILITY

40A 600V AC Manual Motor Controllers

Description	Catalog Number
40A, double pole, single throw, AC manual motor controller, black nylon handle, side wired.	HBL7842D
40A, three pole, single throw, AC manual motor controller, black nylon handle, side wired.	HBL7843D

Note: See page F-21 for technical information.

50A 600V AC Manual Motor Controllers

Description	Catalog Number
50A, double pole, single throw, AC manual motor controller, black nylon handle, side wired.	HBL7852D
50A, three pole, single throw, AC manual motor controller, black nylon handle, side wired.	HBL7853D

Note: See page F-21 for technical information.

60A 600V AC Manual Motor Controllers

Description	Catalog Number
60A, double pole, single throw, AC manual motor controller, black nylon handle, back wired.	HBL7862D
Same as HBL7862D except front wired.	HBL7862FWD
HBL7862FWD in Type 3R enclosure.	HBL16R92D
60A, three pole, single throw, AC manual motor controller, black nylon handle, back wired.	HBL7863D
Same as HBL7863D except front wired.	HBL7863FWD
HBL7863FWD in a Type 3R enclosure.	HBL16R93D
60A, 600V, three pole, rotary controller in NEMA 4X stainless steel enclosure.	HBL16S63D
60A, 600V, three pole, rotary controller in NEMA 4X non-metallic enclosure.	HBL16X63D

Note: See page F-21 for technical information.

85A 600V AC Manual Motor Controllers

Description	Catalog Number
85A, double pole, single throw, AC manual motor controller, black nylon handle, back wired.	HBL7882D
85A, three pole, single throw, AC manual motor controller, black nylon handle, back wired.	HBL7883D

Note: See page F-21 for technical information.

Motor Controller Accessories

Description	Catalog Number
Finger Guards, fit 30A, 40A and 50A controllers.	HBLFG30
Auxiliary Contacts, NO/Common/NC, for use in rotary switches only.	HBLAUX

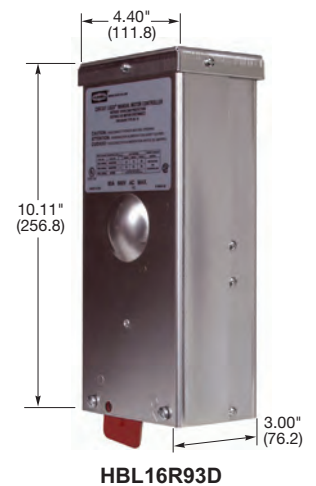
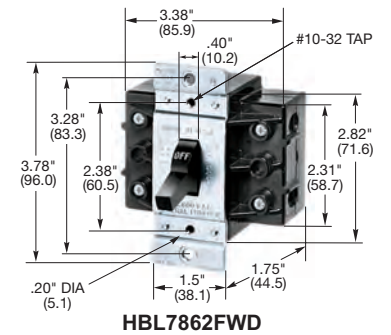
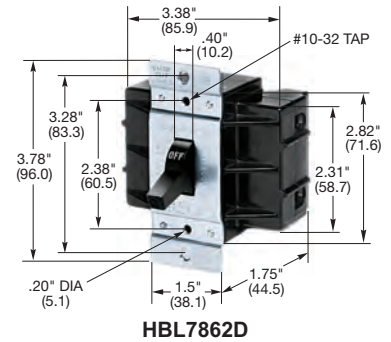

Dimensions in Inches (mm)

Switched Disconnects and Enclosures

NEMA 4X Disconnect Switches

Housing Design

- Thermoplastic 4X Non-metallic enclosures
- Un-drilled case allows custom placement of wire entry
- Switch can be locked in the OFF position as a method of compliance with OSHA lockout/tagout



Housing Design

- 304 Stainless steel enclosure chemical and corrosion resistant
- PBT handle and collar chemical and impact resistant
- Hinged cover with removable continuous pin
- Un-drilled case allows custom placement of wire entry
- Switch can be locked in the OFF position as a method of compliance with OSHA lockout/tagout



HBL13S33D
(Door open)

Interior Design

- Interlocking shaft and handle prevents cover removal when switch is ON
- Poured in closed cell neoprene gasket
- Up to 2 optional auxiliary contacts for PLCs and external indicators



Circuit-Lock® NEMA 4X Enclosures with Switch and Accessories

Ideal for use in environments where wash-down is necessary, i.e. food processing, laboratories, etc.

Amp	Poles	Enclosure Material	HP Rating				Catalog Number
			120V AC 1Ø	240V AC 3Ø	480V AC 3Ø	600V AC 3Ø	
30	3	Stainless Steel	3	7.5	15	20	HBL13S33D
30	3	Non-Metallic	3	7.5	15	20	HBL13X33D
60	3	Stainless Steel	—	10	25	30	HBL16S63D
60	3	Non-Metallic	—	10	25	30	HBL16X63D
Finger Guard option for 30A switch.							HBLFG30
NO/Comon/NC auxiliary contact, 10A 120/250V AC for 30 and 60 Amp switches.							HBLAUX



HBL16S63D



HBL13X33D

Dimensions

HBL13S33D

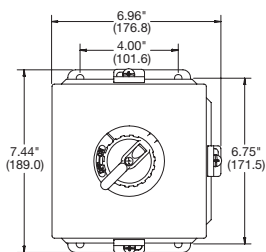

Front

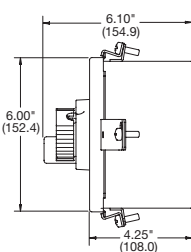

Side

Dimensions in Inches (mm)

HBL16S63D

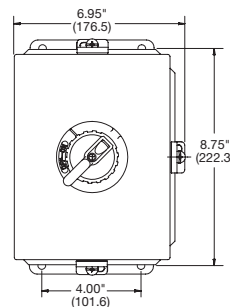

Front

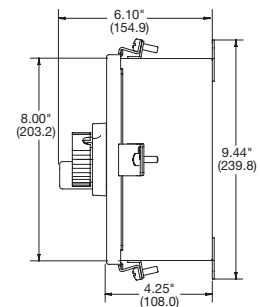

Side

IP55
SUITABILITY

CPB Series Compact Pendant Stations, Two Button, NEMA 4X

Description	Catalog Number
Single-speed normally open-normally closed without mechanical interlock.	CPB20
Single-speed with mechanical interlock between pushbuttons.	CPB21
Single-speed with mechanical interlock between pushbuttons, black housing.	CPB21BK
Two-speed with mechanical interlock between pushbuttons.	CPB22

Note: Included with product: nylon cord grip and sealing washer (must be installed to achieve NEMA 4X rating).
 Indication label pack. Cord dia. range .375-.625 in. (9.5-15.9)
 Ambient temperatures: 25°F to 140°F (32°C to 60°C).
 Typical applications: Package electric motor hoists. Remote control of machinery.



CPB21

Contact Ratings, CPB Series

Single-Speed	Voltage	Current
AC	120V	6A
35% PF	240V	3A
DC	125V	1.1A
IND	250V	.55A
Two-Speed	Voltage	Current
AC	120V	3A
35% PF	240V	1.5A

Wiring Diagram CPB2 Series

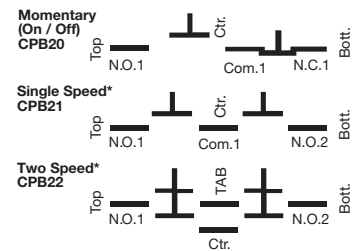

*Mechanical "floating ball" interlock prevents activating both Pushbuttons simultaneously.

IP44
SUITABILITY

PBS Series Heavy Duty Pendant Pushbutton Stations, NEMA 3R

Description	Catalog Number
2 button, single speed.	PBS2
2 button, two speed.	PBS22
4 button, single speed.	PBS4
4 button, two speed.	PBS42
6 button, single speed.	PBS6
6 button, two speed.	PBS62
8 button, single speed.	PBS8
8 button, two speed.	PBS82

Product Dimensions, PBS Series

Style	A	Approx. Wt. Assembled	Catalog Number
2 button	7.88" (200.0)	2.5 lbs	PBS2
4 button	13.69" (347.6)	4.5 lbs	PBS4
6 button	18.0" (457.2)	5.5 lbs	PBS6
8 button	22.31" (566.7)	7.5 lbs	PBS8

Note: Housing: Yellow vinyl rubber.



PBS4

PBS6

Contact Interrupting Ratings, PBS Series

Two-Speed Single Break	Voltage	Current
AC	120V	6A
35% PF	240V	3A
DC	125V	.4A
IND	250V	.2A
Single-Speed Double Break	Voltage	Current
AC	120V	6A
35% PF	240V	3A
DC	125V	1.1A
IND	250V	.55A

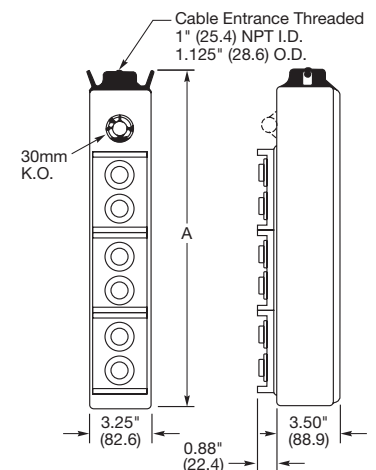

Dimensions in Inches (mm)

Switched Disconnects and Enclosures



PG2



PG6



MS2



MS5

Replacement Inserts

When the insert switches are in need of replacement, simply unplug the old insert and plug in a new one.

Description	Catalog Number
Single speed insert momentary N.O. and N.C.	PG2
ON-OFF insert (no mechanical interlock). Momentary, start-stop, reset-stop.	PG6
2 or 3 speed insert, momentary. Used to a maximum of 3 speed points.	MS2
5 speed insert, momentary. Used to a maximum of 5 speed points. For five speed applications replace an existing terminal board with the TB5 terminal board and replace an existing insert with the five speed (MS5) insert.	MS5

Conversion Inserts

In addition to single speed and two speed applications, pre-assembled units can be adapted to handle other applications.

Description	Catalog Number
Terminal board, required for each insert switch PG2, PG6 and MS2.	TB2
Terminal board, required for insert switch MS5.	TB5



TB2



TB5

Accessories

Description	Catalog Number
Indicator labels for replacement package contains 1 each: hoist, trolley, bridge, forward-reverse, raise-lower, in-out, right left, east-west, north-south, reset-stop, start-stop, power, main hoist, auxiliary hoist, ON-OFF, up-down.	PBSLP
Rubber button cover for replacement purposes.	PBSBC
120V red pilot light for 4, 6, and 8 button units only.	PBSPL1*

Note: *Each pendant station can accommodate one of the pilot light in the 1.20 in. (30.6) diameter mounting hole.



PBSLP



PBSBC

Kellems® Deluxe Aluminum Cord Fitting

Outdoor or indoors where subject to moisture, splash or submersion. Kellems grips provide strain relief for multi-conductor cable.

Description	Cord Range	Catalog Number
Kellems grip.	.750"-.875" (19-22.2)	07401023
Kellems grip.	.875"-1.00" (22.2-25.4)	07401025



PBSPL1



07401023

SECTION G

Table of Contents



**Advantage™ Series
Switch-Rated Devices**



**HBL® Watertight
IEC Pin and Sleeve**



**Circuit-Lock® Unfused and
Fused Mechanical Interlocks**



Product	Page
Products at a Glance	G-2
Configurations Chart	G-3
IEC Pin and Sleeve	
Advantage™ Series Switch-Rated Devices	G-4
Watertight Devices	G-8
Corrosion Resistant Devices	G-12
Data Center Pin and Sleeve	G-13
Horsepower Ratings	G-15
Back Boxes & Accessories	G-28
Dimensions	G-34
Hubbell-PRO Commercial Pin and Sleeve Devices	G-16
Watertight Series North American Ratings	G-17
Watertight Series International Ratings	G-18
Splashproof Series North American Ratings	G-19
Splashproof Series International Ratings	G-20
Unfused Circuit-Lock® Mechanical Interlocks	
Devices and “Reverse Service”	G-21
Accessories and Dimensions	G-23
Fused Circuit-Lock® Mechanical Interlocks	
Devices and Accessories	G-25
Dimensions	G-27

Product	Page
Low Profile Pin and Sleeve	
Devices and Specifications	G-30
Dimensions	G-32
IEC Pin and Sleeve Terminal Identification	G-33
UL 1686 C1 Insulgrip® Pin and Sleeve	
Style I and Style II Devices	G-38
“Reverse Service” Style I and II Devices	G-41
Back Boxes and Accessories	G-42
Dimensions	G-43
Insulgrip® Mechanical Interlocks	
Style II, Fused and Unfused Devices	G-47
Dimensions	G-48
Hazardous Location Devices	
Mechanical Interlocks and Plugs	G-49
Dimensions	G-50

Pin and Sleeve Devices/Mechanical Interlocks

Products at a Glance



Advantage™ Series Pin and Sleeve Switch-Rated Devices

- Advantage™ series devices are approved as disconnecting means for both motor circuitry and branch circuits
- Robust and durable housing, UV-stabilized, impact and corrosion-resistant PBT housing is designed to withstand harsh industrial environments



IEC Watertight Devices

- Provide safe and dependable performance in the most demanding environments
- Heavy duty non-conductive nylon construction provides impact and corrosion protection
- Thermoset polyester contact carriers withstand high temperatures and provide resistance to electrical tracking



Corrosion Resistant Devices

- This superior grade of IEC and Insulgrip devices are ideal for the most demanding environments
- Nickel-plated brass on the IEC and nickel-plated Tellurium copper on the Insulgrip contacts prevent corrosion and heat rise



Hubbell-PRO Commercial Pin and Sleeve

- Value engineered to balance price and performance
- Complete offering of IP44 and IP67 devices
- Multiple installation efficiencies include Edge screwless terminations



Insulgrip® NEMA 4X UL 1686 C1 Devices

- Metallic where you want it and non-metallic where you need it
- This tough product line is NEMA 4X rated for use in the harshest environments
- Devices are fully interchangeable with other manufacturers of UL1686 C1 devices



Circuit-Lock® Mechanical Interlocks

- IEC pin and sleeve devices are color coded by voltage for easy identification
- Available in either fused or non-fused versions
- IEC reverse service units available for safely connecting generators



Back Boxes and Accessories

- A complete line of metallic and non-metallic back boxes, angle adapters, closure caps and liquidtight adapters are available
- Accessories aid with installation efficiencies and support the various applications in which the products are used



Hazardous Location Devices

- Copper-free aluminum construction with electrostatically applied polyester/epoxy finish to prevent corrosion
- Large visible rotary handle with ON/OFF indicator allows a quick means of disconnecting power

Pin and Sleeve Devices/Mechanical Interlocks

IEC Configurations Chart

Singly Rated Configurations

Hubbell Pin and Sleeve products are designed and manufactured to meet the International Standard IEC 60309-1 and IEC 60309-2. This device standard calls out a singly rated, non-interchangeable configuration for every voltage and type of service throughout the world. Pin and sleeve device housings are color coded by voltage rating.

Voltage

The voltage is determined by the location of the female ground contact relative to the housing keyway. Simply by manufacturing the device with a ground contact in a certain "clock" position, the device will be rated for a particular voltage system. The diagram shows the keying position and the color coding that is associated with each voltage.

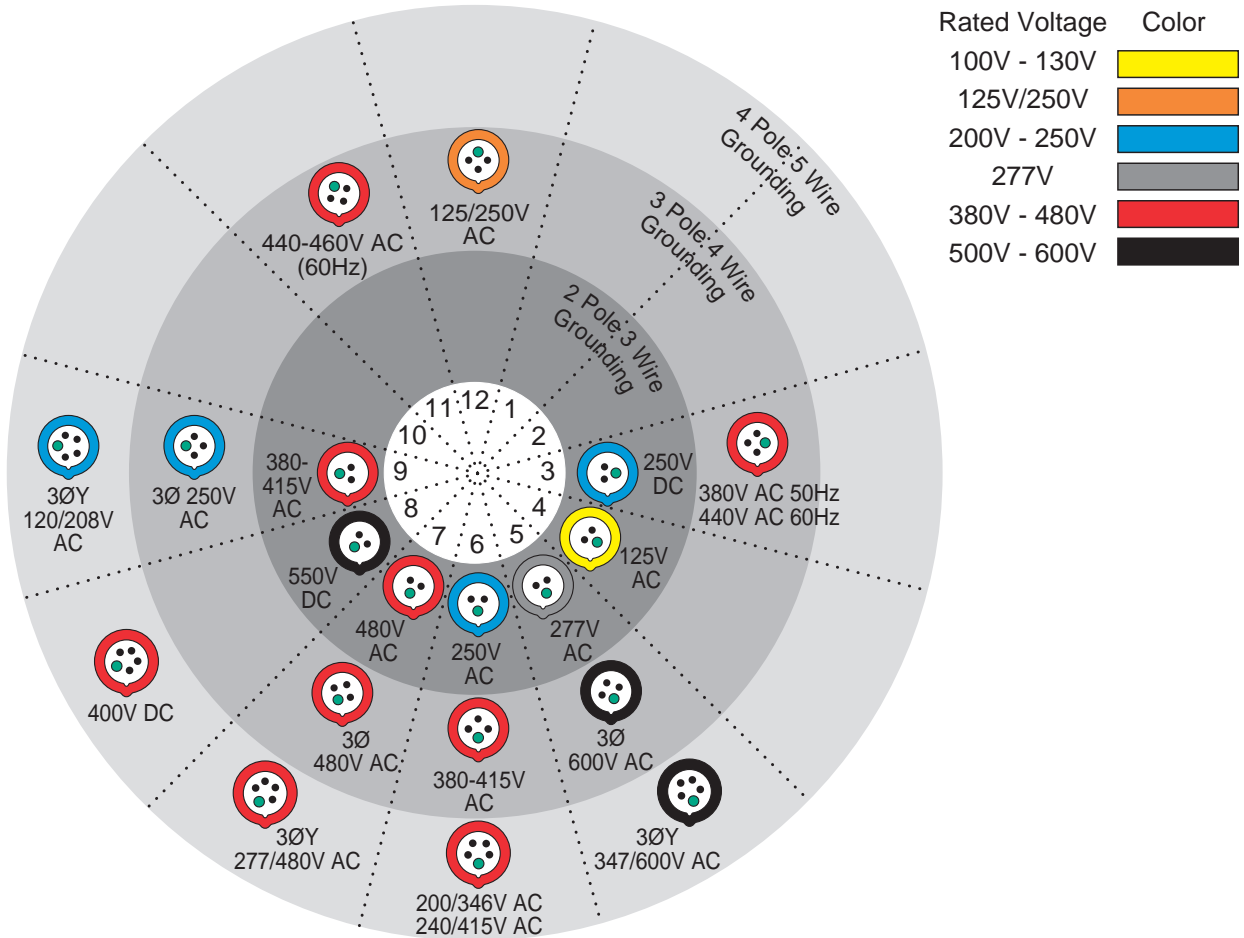

Typical IEC Pin and Sleeve Catalog Number

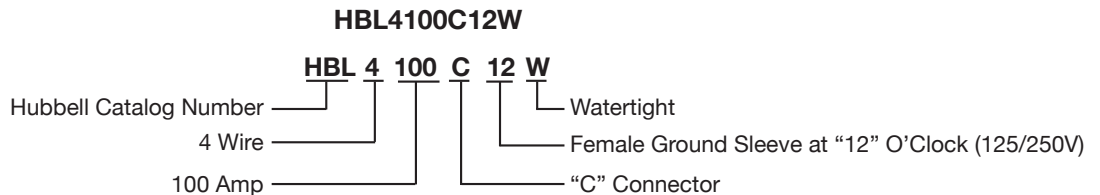

Explanation

- | | | | | | |
|---|--|--|---|--|--|
| <p>1 (HBL) Designates Hubbell Catalog Number</p> | <p>2 First Digit
3-3 wire
4-4 wire
5-5 wire</p> | <p>3 Next Series Of Digits
Preceding a letter
20-20 Amp
30-30 Amp
60-60 Amp
100-100 Amp</p> | <p>4 Letter
P-Plug
R-Receptacle
C-Connector
B-Inlet
MI-Mechanical Interlock
MIF-Mechanical Interlock Fused</p> | <p>5 Last Digit(s)
After the letter. This denotes the position of the ground sleeve and the assigned voltage in the receptacle as it relates to the hours of the clock. This is done to eliminate interchangeability between devices with different voltages.</p> | <p>6 Letter: W
Watertight</p> |
|---|--|--|---|--|--|

Features and Benefits

Advantage™ Series Pin and Sleeve Switch-Rated

Hubbell Wiring Device-Kellems Advantage™ Series Pin and Sleeve Switch-Rated Devices are IEC 60309-2 compatible devices that are approved as a disconnecting means for motor and branch circuits. Compact design, this device is similar in size to standard IEC 60309-2 devices. Robust and durable housing, UV-stabilized, impact and corrosion-resistant PBT housing is designed to withstand harsh industrial environments. Stainless steel hardware provides superior corrosion resistance in wet and harsh environments. Receptacles mount to standard Hubbell IEC Pin and Sleeve back boxes.



Housing Design

- Rugged one-piece housing, thick wall construction protects internal components, eliminates joints preventing infiltration of contaminants
- IEC pin and sleeve devices are color coded by voltage for easy identification

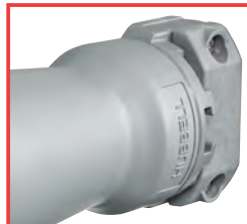

Heavy Duty External Cord Grips

- Provides maximum cord retention to maintain unstressed terminations
- Pocketed recess for screws deters slippage of the screwdriver and are conveniently located on the same side for easy installation



Ease of Use

- Ergonomic design puts the Advantage™ into the palm of your hands with the easy-to-use leverage grip design from Hubbell



Spring-Loaded Cover

- Spring-loaded to the open position, reminding users that the cover must be secured to ensure maximum ingress protection
- Impact resistant cover arm compact and durable internal swing arm is fully shrouded protecting it from damage



Spring-Loaded Disconnect Button

- Oversized for easy actuation with gloved hands



Full Line of Accessories

- Advantage series receptacles have same mounting pattern as our standard receptacles, for non-metallic and metallic back boxes (see page G-14)
- Full offering of liquidtight adapters (see page G-15)

Features and Benefits

Advantage™ Series Pin and Sleeve Switch-Rated

The Advantage™ Series has a UL witnessed IP69k and 4X,12 environmental rating, two power-indicating LEDs, continuous ground engagement, labelless laser markings and a compact and ergonomic design.

Hubbell's Pin and Sleeve connections have always been safe – that hasn't changed. The Advantage™ series simply has more... Advantages.



The Hubbell Advantages



Sleek and Modern Design

- The ergonomic device is easy to keep clean making it ideal for hygienic food processing facilities



Permanent Labelless Markings

- Product ratings are laser-marked into the device and will not wash off for easy permanent identification



Continuous Ground Engagement

- Unswitched feed-through ground pin is first-to-make and last-to-break followed by switched neutral and phase contact(s)

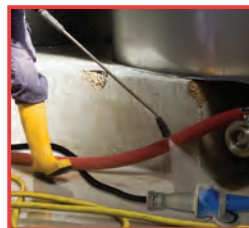

Superior Water Ingress Protection

- UL witnessed IP69k and UL Type 4X and 12. Device is built to withstand wet and harsh environments



IEC 60309 Singularity Rated Device

- Mates with existing installed base of IEC 60309-2 pin and sleeve devices. Color coded by voltage for easy identification of mating devices



Power Indicating LED Lights

- Highly visible and long lasting green LED lights on both sides of the device provide visual verification of power when connected





Rating				Pin and Sleeve Devices					Accessories		
Amps	Poles and Wires	Configuration Recept./ Conn.	Plug/ Inlet	AC Voltage	Connector	Receptacle	HP	Mating Plug**	IP67 Inlet	Back Boxes	Closure Caps
30	2P 3W			125V	HBLS330C4W	HBLS330R4W	2	HBL330P4W	HBL330B4W	BB2030N	PC3430
32	2P 3W			100-130V	HBLS332C4W	HBLS332R4W	2	HBL332P4W	HBL332B4W	BB2030N	PC3430
30	2P 3W			250V	HBLS330C6W*	HBLS330R6W*	5	HBL330P6W*	HBL330B6W*	BB2030N	PC3430
32	2P 3W			220-240V							
30	2P 3W			480V	HBLS330C7W	HBLS330R7W	10	HBL330P7W	HBL330B7W	BB2030N	PC3430
30	3P 4W			125/250V	HBLS430C12W	HBLS430R12W	2	HBL430P12W	HBL430B12W	BB2030N	PC3430
30/32	3P 4W			3Ø 250V	HBLS430C9W*	HBLS430R9W*	10	HBL430P9W*	HBL430B9W*	BB2030N	PC3430
30	3P 4W			3Ø 480V	HBLS430C7W	HBLS430R7W	20	HBL430P7W	HBL430B7W	BB2030N	PC3430
30	3P 4W			3Ø 600V	HBLS430C5W	HBLS430R5W	30	HBL430P5W	HBL430B5W	BB2030N	PC3430
30/32	3P 4W			380-415V	HBLS430C6W*	HBLS430R6W*	7.5	HBL430P6W*	HBL430B6W*	BB2030N	PC3430
32	3P 4W			380-440V	HBLS432C3W	HBLS432R3W	10	HBL432P3W	HBL432B3W	BB2030N	PC3430
30	4P 5W			3ØY 347/600V	HBLS530C5W	HBLS530R5W	30	HBL530P5W	HBL530B5W	BB2030N	PC530
30	4P 5W			200/346- 240/415V	HBLS530C6W*	HBLS530R6W*	7.5	HBL530P6W*	HBL530B6W*	BB2030N	PC530
32	4P 5W			220/380V 240/415V							
30	4P 5W			3ØY 277/480V	HBLS530C7W	HBLS530R7W	20	HBL530P7W	HBL530B7W	BB2030N	PC530
30/32	4P 5W			3ØY 120/208V	HBLS530C9W*	HBLS530R9W*	10	HBL530P9W*	HBL530B9W*	BB2030N	PC530
60	2P 3W			125V	HBLS360C4W	HBLS360R4W	3	HBL360P4W	HBL360B4W	BB60N	PC60
60	2P 3W			250V	HBLS360C6W*	HBLS360R6W*	7.5	HBL360P6W*	HBL360B6W*	BB60N	PC60
63	2P 3W			220-240V							
60	2P 3W			480V	HBLS360C7W	HBLS360R7W	15	HBL360P7W	HBL360B7W	BB60N	PC60
60	3P 4W			125/250V	HBLS460C12W	HBLS460R12W	3	HBL460P12W	HBL460B12W	BB60N	PC60
60/63	3P 4W			3Ø 250V	HBLS460C9W*	HBLS460R9W*	10	HBL460P9W*	HBL460B9W*	BB60N	PC60
60	3P 4W			3Ø 480V	HBLS460C7W	HBLS460R7W	30	HBL460P7W	HBL460B7W	BB60N	PC60
60	3P 4W			3Ø 600V	HBLS460C5W	HBLS460R5W	40	HBL460P5W	HBL460B5W	BB60N	PC60
60/63	3P 4W			380-415V	HBLS460C6W*	HBLS460R6W*	10	HBL460P6W*	HBL460B6W*	BB60N	PC60
60	4P 5W			3ØY 347/600V	HBLS560C5W	HBLS560R5W	40	HBL560P5W	HBL560B5W	BB60N	PC60
60/63	4P 5W			200/346- 240/415V	HBLS560C6W*	HBLS560R6W*	10	HBL560P6W*	HBL560B6W*	BB60N	PC60
60	4P 5W			3ØY 277/480V							
60/63	4P 5W			3ØY 120/208V	HBLS560C9W*	HBLS560R9W*	10	HBL560P9W*	HBL560B9W*	BB60N	PC60

Note: *Certain IEC configurations allow for a single product to be certified as both a North American (Series 2) and International amperage (Series 1). These products are marked accordingly with both the UL Listing and UL Classified markings.

**Mating plug or inlet required to maintain 4X/IP69k ratings when used with ADVANTAGE™ series connections.
 ADVANTAGE™ series receptacles have the same mounting pattern as standard Hubbell IEC pin and sleeve.
 See page G-28 for back boxes and G-29 for accessories.

Rating				Pin and Sleeve Devices					Accessories		
Amps	Poles and Wires	Configuration Recep./ Conn.	Plug/ Inlet	AC Voltage	Connector	Receptacle	HP	Mating Plug**	Inlet**	Back Boxes	Closure Caps
100	3P 4W			3Ø 600V	HBLS4100C5W	HBLS4100R5W	50	HBL4100P5W	HBL4100B5W	BB100N	PC100
100	3P 4W			380-415V	HBLS4100C6W*	HBLS4100R6W*	15	HBL4100P6W	HBL4100B6W	BB100N	PC100
100	3P 4W			3Ø 480V	HBLS4100C7W	HBLS4100R7W	40	HBL4100P7W	HBL4100B7W	BB100N	PC100
100	3P 4W			3Ø 250V	HBLS4100C9W*	HBLS4100R9W*	15	HBL4100P9W	HBL4100B9W	BB100N	PC100
100	3P 4W			125/250V	HBLS4100C12W	HBLS4100R12W	10; 3	HBL4100P12W	HBL4100B12W	BB100N	PC100
100	4P 5W			3ØY 347/600V	HBLS5100C5W	HBLS5100R5W	50	HBL5100P5W	HBL5100B5W	BB100N	PC100
100	4P 5W			200/346- 240/415V	HBLS5100C6W*	HBLS5100R6W*	15	HBL5100P6W	HBL5100B6W	BB100N	PC100
100	4P 5W			3ØY 277/480V	HBLS5100C7W	HBLS5100R7W	40	HBL5100P7W	HBL5100B7W	BB100N	PC100
100	4P 5W			3ØY 120/208V	HBLS5100C9W*	HBLS5100R9W*	15	HBL5100P9W	HBL5100B9W	BB100N	PC100

Note: *Certain IEC configurations allow for a single product to be certified as both a North American (Series 2) and International amperage (Series 1). These products are marked accordingly with both the UL Listing and UL Classified markings.

**Mating plug or inlet required to maintain 4X/IP69k ratings when used with ADVANTAGE™ series connections.

Advantage™ Pin and Sleeve Communication Circuit

Hubbell's innovative Advantage™ Series Switch-Rated pin and sleeve are available with three optional Control Contacts. These break before main contacts can be used to communicate with auxiliary devices such as PLCs and VFDs.

Control circuit versions are available in 3 pole 4 wire configurations and have a voltage range of 125V up to 600V. To help support facility control, the oversized ground contact is clocked at either 5 or 7 o'clock to help prevent mismatching of unlike voltages.



Rating				Pin and Sleeve Devices							Accessories	
Amps	Poles And Wires	Configuration		AC Voltage	Connector	Receptacle	HP	Mating Plug	IP67 Inlet	Back Boxes	Closure Caps	
		Recep./ Conn.	Plug/ Inlet									
30	3P 4W			Max 600V AC	HBLS430C7WC	HBLS430R7WC	20	HBL430P7WC	HBL430B7WC	BB2030N	PC530	
30	3P 4W			Max 600V AC	HBLS430C5WC	HBLS430R5WC	30	HBL430P5WC	HBL430B5WC	BB2030N	PC530	
60	3P 4W			Max 600V AC	HBLS460C7WC	HBLS430R7WC	30	HBL460P7V02	HBL460B7WC	BB60N	PC60	
60	3P 4W			Max 600V AC	HBLS460C5WC	HBLS430R5WC	40	HBL460P5WC	HBL460B5WC	BB60N	PC60	

Wiring Schematic

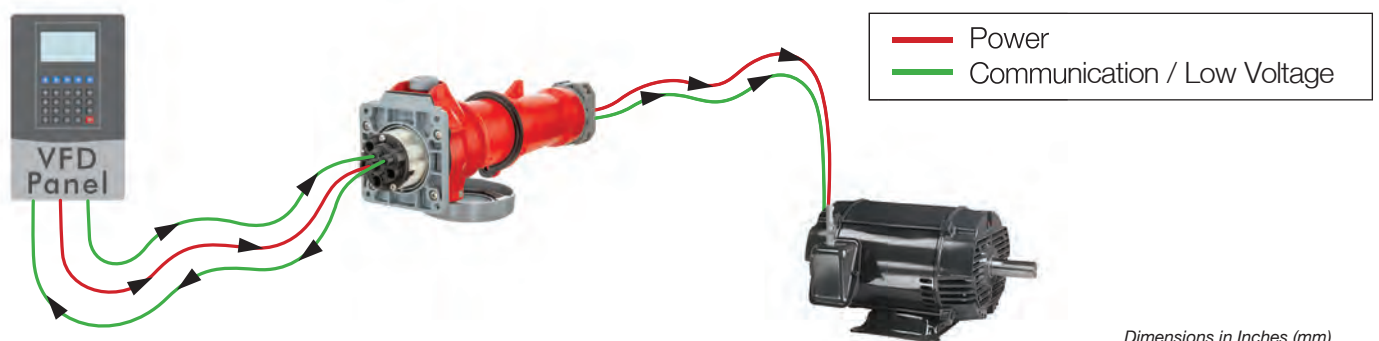

Dimensions in Inches (mm)

Features and Benefits

TYPE 4X, 12

Watertight Devices

Hubbell's IEC 60309 Pin and Sleeve plugs, connectors, inlets and receptacles are the highest performing products available. The HBL® series of IEC pin and sleeve were designed for the demanding North American market. Hubbell was the first and is still only manufacturer of IEC 60309 devices in the USA and have numerous innovative features noted below.

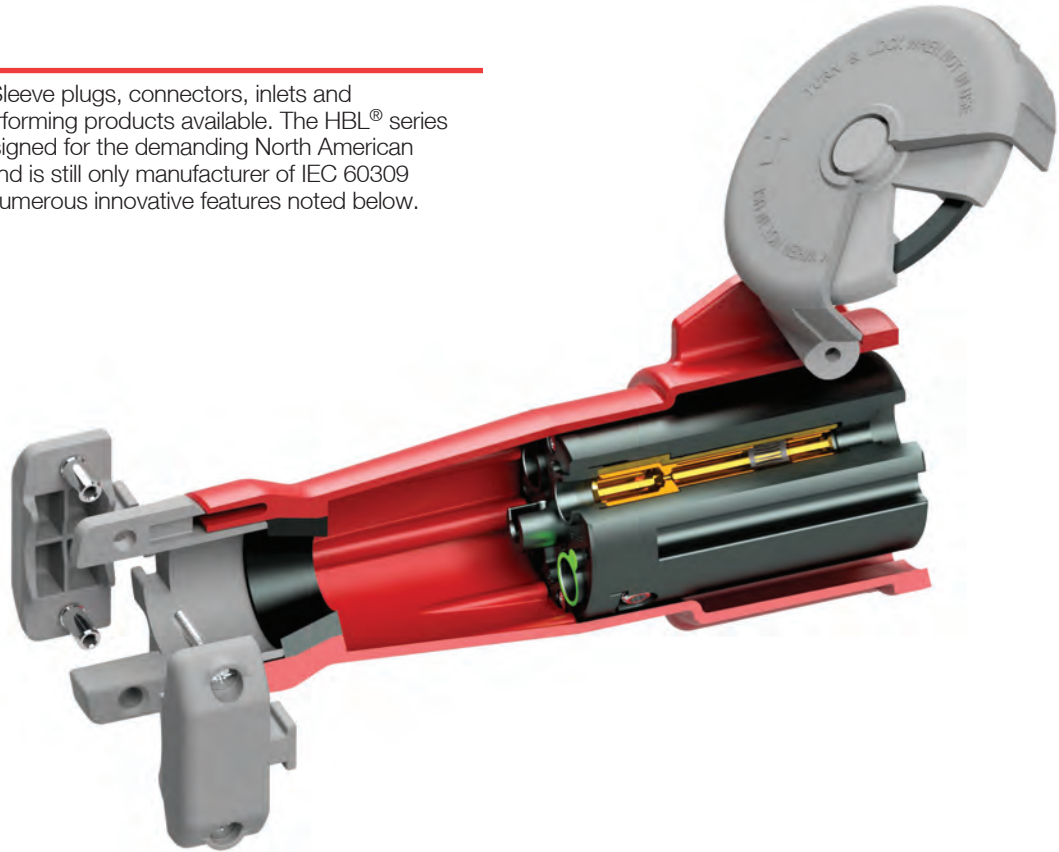

Housing Design

- Insulated non-metallic housing, super tough, non-conductive and chemical resistant for heavy duty industrial environments
- IEC pin and sleeve devices are color coded by voltage for easy identification
- Self-closing gasketed cover, detents into position to fully close automatically



Liquidtight Conduit Adapters

- Aluminum or non-metallic adapters are available to provide a means for attaching flexible liquidtight metal conduit to rear of Hubbell Pin and Sleeve plug or connector

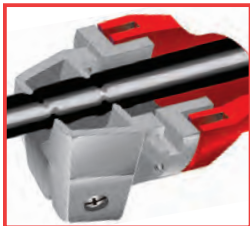

Powerful Mechanical Cord Grip

- Hubbell's design incorporates two molded-in teeth to securely grip the outer cable jacket, and internal conductors to prevent slippage and strain on terminations
- Captive barrel nuts ease assembly and allow higher tightening torque for maximum cord retention

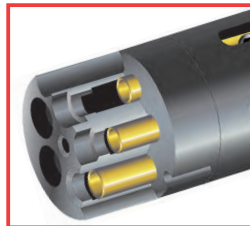

Sequential Contact Engagement

- Ground makes first and breaks last. Neutral makes second and breaks second (to prevent a momentary over-voltage on components connected phase to neutral)
- Phase contacts make last and break first

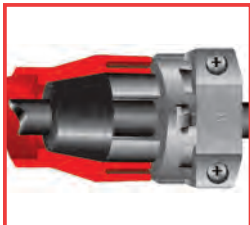

Watertight Cord Entrance

- The tapered bore entrance creates high compression forces on sealing gland, providing a watertight seal around cord
- Individual solid neoprene glands are supplied to match a full range of cord sizes and assure watertight performance

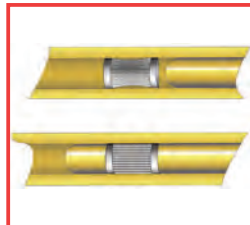

Multi-Contact Spring

- (60/63 and 100/125 Amp) Recessed within the female sleeve, provides and maintains high unit pressure on mating pins to minimize temperature rise
- Broaches oxide film to achieve low resistance contact for cooler operation

Features and Benefits

TYPE 4X, 12

Watertight Devices

The IEC line of plugs and connectors are made with a rugged super tough, one-piece housing. The thermoset polyester contact carrier provides a high resistance to electrical tracking. They withstand higher temperatures which may result from overload or arcing. The heavy-duty, external cord grip provides superior strain relief on the conductors. Hubbell's horsepower rated plugs and receptacles meet NEC 430.109(F) requirements and recognized as an approved disconnecting/"line of sight" disconnecting means.

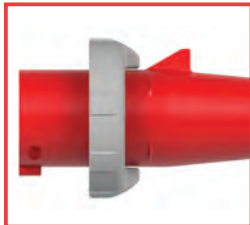
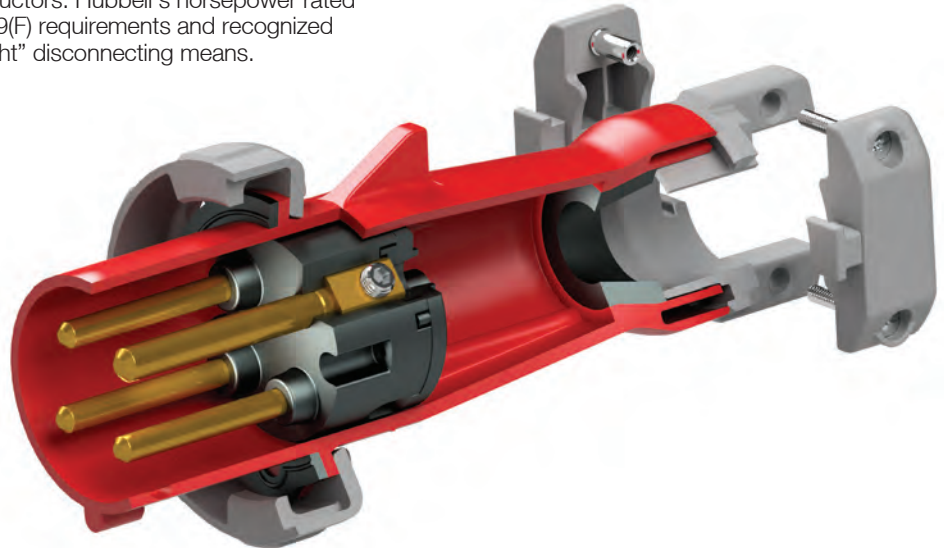

Housing Design

- Rugged one-piece housing, thick wall construction protects internal components, eliminates joints preventing infiltration of contaminants
- Amperage/voltage rating and catalog number molded in housing for easy identification



Shrouded Pins

- Super tough plug shroud protects pins from deforming from physical abuse
- Protects the user from the possibility of touching live contacts during insertion and withdrawal of mating parts
- Solid one-piece pins, machined from solid brass for longer life and reliable electrical contact



Safety

- Lockout/Tagout, tapered opening on plug shroud accommodates up to $\frac{3}{8}$ inch (9.7mm) lock shackle diameter

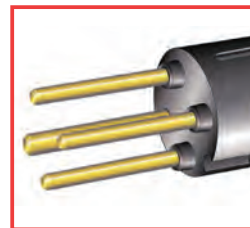

Thermoset Polyester Contact Carrier

- Molded thermoset polyester provides high resistance to electrical tracking
- Withstands higher temperatures which may result from overload or arcing
- Thermoset properties provide dimensional stability for this critical assembly

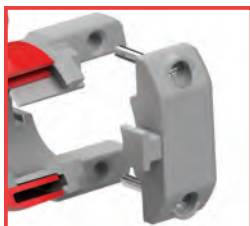

Cord Grips

- Heavy duty external cord grips provide maximum cord retention to maintain secure terminations

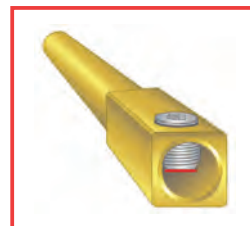

Swivel Pressure Pads

- 16/20 and 30/32 Amp devices feature patented swiveling pressure pad terminal screws and prevent damage to conductor strands. 60/63 and 100/125 Amp devices feature large hex-head stainless steel screws which provide higher torque levels for secure terminations

Rating					Watertight Devices				Accessories			Replacement Interiors	
Amps	Poles and Wires	Configuration Recept./ Conn.	Plug/ Inlet	AC Voltage	Receptacle	Plug	Connector	Inlet	Back Boxes		Closure Caps	Recept./ Conn.	Plug/ Inlet
									Non-Metallic	Metallic*			
16	2P 3W			100-130V	HBL316R4W	HBL316P4W	HBL316C4W	HBL316B4W†	BB2030N	BB201W BB301W	PC320	IN320BF	IN320BM
20	2P 3W			125V	HBL320R4W	HBL320P4W	HBL320C4W	HBL320B4W	BB2030N	BB201W BB301W	PC320	IN320AF	IN320AM
16/20	2P 3W			220-240V 250V	HBL320R6W	HBL320P6W	HBL320C6W	HBL320B6W	BB2030N	BB201W BB301W	PC320	IN320BF	IN320BM
20	2P 3W			480V	HBL320R7W	HBL320P7W	HBL320C7W	HBL320B7W	BB2030N	BB201W BB301W	PC320	IN320BF	IN320BM
20	3P 4W			125/250V	HBL420R12W	HBL420P12W	HBL420C12W	HBL420B12W	BB2030N	BB201W BB301W	PC420	IN420CF	IN420CM
16/20	3P 4W			380-415V	HBL420R6W	HBL420P6W	HBL420C6W	HBL420B6W	BB2030N	BB201W BB301W	PC420	IN420DF	IN420DM
	3P 4W			3Ø 250V	HBL420R9W	HBL420P9W	HBL420C9W	HBL420B9W	BB2030N	BB201W BB301W	PC420	IN420DF	IN420DM
20	3P 4W			3Ø 480V	HBL420R7W	HBL420P7W	HBL420C7W	HBL420B7W	BB2030N	BB201W BB301W	PC420	IN420DF	IN420DM
20	3P 4W			3Ø 600V	HBL420R5W	HBL420P5W	HBL420C5W	HBL420B5W	BB2030N	BB201W BB301W	PC420	IN420DF	IN420DM
16/20	4P 5W			220/380V 240/415V	HBL520R6W	HBL520P6W	HBL520C6W	HBL520B6W	BB2030N	BB201W BB301W	PC520	IN520EF†	IN520EM
	4P 5W			3ØY 120/208V	HBL520R9W	HBL520P9W	HBL520C9W	HBL520B9W	BB2030N	BB201W BB301W	PC520	IN520EF†	IN520EM
20	4P 5W			3ØY 277/480V	HBL520R7W	HBL520P7W	HBL520C7W	HBL520B7W	BB2030N	BB201W BB301W	PC520	IN520EF†	IN520EM
20	4P 5W			3ØY 347/600V	HBL520R5W	HBL520P5W	HBL520C5W	HBL520B5W	BB2030N	BB201W BB301W	PC520	IN520EF†	IN520EM
30	2P 3W			125V	HBL330R4W	HBL330P4W	HBL330C4W	HBL330B4W	BB2030N	BB201W BB301W	PC3430	IN330AF	IN330AM†
30/32	2P 3W			220-240V 250V	HBL330R6W	HBL330P6W	HBL330C6W	HBL330B6W	BB2030N	BB201W BB301W	PC3430	IN330BF	IN330BM
30	2P 3W			480V	HBL330R7W	HBL330P7W	HBL330C7W	HBL330B7W	BB2030N	BB201W BB301W	PC3430	IN330BF	IN330BM
30	3P 4W			125/250V	HBL430R12W	HBL430P12W	HBL430C12W	HBL430B12W	BB2030N	BB201W BB301W	PC3430	IN430CF	IN430CM
30/32	3P 4W			380-415V	HBL430R6W	HBL430P6W	HBL430C6W	HBL430B6W	BB2030N	BB201W BB301W	PC3430	IN430DF	IN430DM
	3P 4W			3Ø 250V	HBL430R9W	HBL430P9W	HBL430C9W	HBL430B9W	BB2030N	BB201W BB301W	PC3430	IN430DF	IN430DM
30	3P 4W			3Ø 480V	HBL430R7W	HBL430P7W	HBL430C7W	HBL430B7W	BB2030N	BB201W BB301W	PC3430	IN430DF	IN430DM
30	3P 4W			3Ø 600V	HBL430R5W	HBL430P5W	HBL430C5W	HBL430B5W	BB2030N	BB201W BB301W	PC3430	IN430DF	IN430DM
30/32	4P 5W			220/380V 240/415V	HBL530R6W	HBL530P6W	HBL530C6W	HBL530B6W	BB2030N	BB201W BB301W	PC530	IN530EF	IN530EM
	4P 5W			3ØY 120/208V	HBL530R9W	HBL530P9W	HBL530C9W	HBL530B9W	BB2030N	BB201W BB301W	PC530	IN530EF	IN530EM
30	4P 5W			3ØY 277/480V	HBL530R7W	HBL530P7W	HBL530C7W	HBL530B7W	BB2030N	BB201W BB301W	PC530	IN530EF	IN530EM
30	4P 5W			3ØY 347/600V	HBL530R5W	HBL530P5W	HBL530C5W	HBL530B5W	BB2030N	BB201W BB301W	PC530	IN530EF	IN530EM
32	2P 3W			100-130V	HBL332R4W†	HBL332P4W†	HBL332C4W†	HBL332B4W†	BB2030N	BB201W BB301W	PC3430	IN330BF	IN330BM
32	3P 4W			380V 50Hz 440V 60Hz	HBL432R3W	HBL432P3W	HBL432C3W	HBL432B3W†	BB2030N	BB201W BB301W	PC3430	IN430DF	IN430DM

Note: See page G-28 and G-29 for back boxes and accessories, G-34 and G-35 for product dimensions, G-14 and G-15 for product specifications and HP ratings.

See page G-29 for closure caps, purchased separately. PC320, PC420, PC520, PC3430, PC530 are not UL or CSA.

*These boxes are cast aluminum, suitable for IP54 requirements and are finished with enamel paint.

†Consult factory.

See 20, 30, 60 & 100 amp offering for additional dual rated devices for use at either 16A or 20A, 30A or 32A, 60A or 63A and 100A or 125A.

Rating					Watertight Devices				Accessories		Replacement Interiors		
Amps	Poles and Wires	Configuration Recept./ Conn.	Plug/ Inlet	AC Voltage	Receptacle	Plug	Connector	Inlet	Back Boxes Non-Metallic	Back Boxes Metallic	Closure Caps	Recept./ Conn.	Plug/ Inlet
60	2P 3W			125V	HBL360R4W	HBL360P4W	HBL360C4W	HBL360B4W	BB60N	BB601W BB602W	PC60	IN360AF	IN360AM
60/63	2P 3W			220-240V 250V	HBL360R6W	HBL360P6W	HBL360C6W	HBL360B6W	BB60N	BB601W BB602W	PC60	IN360BF	IN360BM†
60	2P 3W			480V	HBL360R7W	HBL360P7W	HBL360C7W	HBL360B7W	BB60N	BB601W BB602W	PC60	IN360BF	IN360BM†
60	3P 4W			125/250V	HBL460R12W	HBL460P12W	HBL460C12W	HBL460B12W	BB60N	BB601W BB602W	PC60	IN460CF	IN460CM
60/63	3P 4W			380-415V	HBL460R6W	HBL460P6W	HBL460C6W	HBL460B6W	BB60N	BB601W BB602W	PC60	IN460DFS	IN460DMS
	3P 4W			3Ø 250V	HBL460R9W	HBL460P9W	HBL460C9W	HBL460B9W	BB60N	BB601W BB602W	PC60	IN460DF	IN460DM
60	3P 4W			3Ø 480V	HBL460R7W	HBL460P7W	HBL460C7W	HBL460B7W	BB60N	BB601W BB602W	PC60	IN460DF	IN460DM
60	3P 4W			3Ø 600V	HBL460R5W	HBL460P5W	HBL460C5W	HBL460B5W	BB60N	BB601W BB602W	PC60	IN460DF	IN460DM
60/63	4P 5W			220/380V 240/415V	HBL560R6W	HBL560P6W	HBL560C6W	HBL560B6W	BB60N	BB601W BB602W	PC60	IN560EFS†	IN560EMS
	4P 5W			3ØY 120/208V	HBL560R9W	HBL560P9W	HBL560C9W	HBL560B9W	BB60N	BB601W BB602W	PC60	IN560EF	IN560EM†
60	4P 5W			3ØY 277/480V	HBL560R7W	HBL560P7W	HBL560C7W	HBL560B7W	BB60N	BB601W BB602W	PC60	IN560EF	IN560EM†
60	4P 5W			3ØY 347/600V	HBL560R5W	HBL560P5W	HBL560C5W	HBL560B5W	BB60N	BB601W BB602W	PC60	IN560EF	IN560EM†
100	2P 3W			125V	HBL3100R4W	HBL3100P4W	HBL3100C4W	HBL3100B4W	BB100N	BB1001W BB1002W	PC100	IN3100AF	IN3100AM
100	2P 3W			250V	HBL3100R6W	HBL3100P6W	HBL3100C6W	HBL3100B6W	BB100N	BB1001W BB1002W	PC100	IN3100BF	IN3100BM†
100	2P 3W			480V	HBL3100R7W	HBL3100P7W	HBL3100C7W	HBL3100B7W	BB100N	BB1001W BB1002W	PC100	IN3100BF	IN3100BM†
100	3P 4W			125/250V	HBL4100R12W	HBL4100P12W	HBL4100C12W	HBL4100B12W	BB100N	BB1001W BB1002W	PC100	IN4100CF†	IN4100CM
100/ 125	3P 4W			380-415V	HBL4100R6W	HBL4100P6W	HBL4100C6W	HBL4100B6W	BB100N	BB1001W BB1002W	PC100	IN4100DFS	IN4100DMS
	3P 4W			3Ø 250V	HBL4100R9W	HBL4100P9W	HBL4100C9W	HBL4100B9W	BB100N	BB1001W BB1002W	PC100	IN4100DF	IN4100DM
100	3P 4W			3Ø 480V	HBL4100R7W	HBL4100P7W	HBL4100C7W	HBL4100B7W	BB100N	BB1001W BB1002W	PC100	IN4100DF	IN4100DM
100	3P 4W			3Ø 600V	HBL4100R5W	HBL4100P5W	HBL4100C5W	HBL4100B5W	BB100N	BB1001W BB1002W	PC100	IN4100DF	IN4100DM
100/ 125	4P 5W			220/380V 240/415V	HBL5100R6W	HBL5100P6W	HBL5100C6W	HBL5100B6W	BB100N	BB1001W BB1002W	PC100	IN5100EFS	IN5100EMS
	4P 5W			3ØY 120/208V	HBL5100R9W	HBL5100P9W**	HBL5100C9W	HBL5100B9W	BB100N	BB1001W BB1002W	PC100	IN5100EF	IN5100EM
100	4P 5W			3ØY 277/480V	HBL5100R7W	HBL5100P7W	HBL5100C7W	HBL5100B7W	BB100N	BB1001W BB1002W	PC100	IN5100EF	IN5100EM
100	4P 5W			3ØY 347/600V	HBL5100R5W	HBL5100P5W	HBL5100C5W	HBL5100B5W	BB100N	BB1001W BB1002W	PC100	IN5100EF	IN5100EM

Note: See page G-28 and G-29 for back boxes and accessories, G-34 and G-35 for product dimensions, G-14 and G-15 for product specifications and HP ratings.
 See page G-29 for closure caps, purchased separately. PC60 and PC100 are not UL or CSA.
 *These boxes are cast aluminum, suitable for IP54 requirements and are finished with enamel paint.
 **Short housing plug HBL5100P9WSH. IP22 suitability.
 †Consult factory.

Corrosion Resistant Devices that Withstand the Most Abusive Environments

Hubbell offers a superior grade of 100A IEC Pin and Sleeve designed for use in the most demanding environments. These devices feature nickel plated solid brass pins for long life and reliable electrical contact in the most corrosive environments. They have a high visibility yellow supertough nylon housing. The heavy duty external cord clamps provide maximum cord retention to maintain secure terminations. The screws and fasteners are made from stainless steel.



- Food Processing
- Factory
- Water Treatment
- Washdown
- Temporary Power
- Meat Packing
- Construction
- Agriculture
- Outdoor Entertainment

Standard Service

Rating					Watertight Devices			Accessories		
Amps	Poles And Wires	Configuration Recept./ Conn.	Plug	AC Voltage	Receptacle	Plug	Connector	Back Boxes Non-Metallic	Back Boxes Metallic*	Closure Caps
100	3P 4W			125/250V	M4100R12	M4100P12	M4100C12	BB100N	BB1001W BB1002W	PC100
	4P 5W			3ØY 120/208V	M5100R9	M5100P9	M5100C9	BB100N	BB1001W BB1002W	PC100
	4P 5W			3ØY 277/480V	M5100R7	M5100P7	M5100C7	BB100N	BB1001W BB1002W	PC100

"Reverse Service"

Rating					Watertight Devices			Accessories		
Amps	Poles And Wires	Configuration Conn.	Inlet	AC Voltage	Inlet	Plug	Connector	Back Boxes Non-Metallic	Back Boxes Metallic*	Closure Caps
100	3P 4W			125/250V	M4100B12R	—	M4100C12R	BB100N	BB1001W BB1002W	PC100
	4P 5W			3ØY 120/208V	M5100B9R	—	M5100C9R	BB100N	BB1001W BB1002W	PC100
	4P 5W			3ØY 277/480V	M5100B7R	—	M5100C7R	BB100N	BB1001W BB1002W	PC100

Note: *These boxes are cast aluminum, suitable for IP54 requirements and are finished with enamel paint. See page AA-19 for corrosion resistant cord sets.

Pin and Sleeve Devices/Mechanical Interlocks

Data Center DC Rated Pin and Sleeve Devices

TYPE 4X, 12



In today's environmentally conscious world, energy savings is a pinnacle part of going green. DC (Direct Current) is being used to reduce power consumption and decrease the amount of infrastructure needed to energize specific types of data center equipment. Electrical devices provide a means of connecting DC power.

Hubbell is the first manufacturer to introduce a series of IEC Pin and Sleeve devices configured for the UL1686 eight o'clock ground position for DC voltage (Disconnecting use only). Hubbell's IEC DC rated pin and sleeve line has been qualified by UL to the requirements of DC voltage. The thermoset polyester contact carrier provide high resistance to electrical tracking, it withstands higher temperatures for this type of demanding application. The solid one-piece pins are machined from solid brass for longer life and reliable electrical contact. In addition, the heavy-duty external cord grips provide maximum cord retention to maintain secure terminations. Finally, the super tough, color coded, non-conductive V-0 rated PBT housing is heavy duty for safety and protecting the internal components.



Rating					Watertight Devices		
Amps	Poles And Wires	Configuration Recep./ Conn.	Plug	DC Voltage	Receptacle	Plug	Connector
30	2P 3W			550V			
60	2P 3W			550V	HBL360R8WDC*	HBL360P8V0DC	HBL360C8V0DC
100	2P 3W			550V	HBL3100R8WDC	HBL3100P8V0DC	HBL3100C8V0DC
	4P 5W			400V	HBL5100R8WDC	HBL5100P8V0DC	HBL5100C8V0DC

Note: *Inlet available - HBL360B8WDC.

Dual Certified Pin and Sleeve Devices

TYPE 4X, 12



Hubbell's dual certified pin and sleeve devices are ideal for the data center and high tech server industry. They are UL Listed to UL1682 for the North American market and are UL Classified Certified for the European and International market. Customers can use the same plug and connector for multiple electrical configurations. They reduce the number of SKU's end users have to use if they sell to both domestic and overseas customers. These devices are IP67 rated, RoHs compliant and showcase all the inherent safety benefits of their V-0 rated PBT housing and internal components.

Rating					Watertight Devices			
Amps	Poles And Wires	Configuration Recep./ Conn.	Plug	AC Voltage	Receptacle	Plug	Connector	Inlet
30/32	3P 4W			380-415V				
	4P 5W			200/346V 240/415V	HBL530R6V02	HBL530P6V02	HBL530C6V02	HBL530B6V02
60/63	3P 4W			380-415V	HBL460R6V02	HBL460P6V02	HBL460C6V02	HBL460B6V02
	4P 5W			200/346V 240/415V	HBL560R6V02	HBL560P6V02	HBL560C6V02	HBL560B6V02

Pin and Sleeve Devices/Mechanical Interlocks

Advantage Series Specifications

Temperature Rise	< 30°C
Dielectric Voltage	Min 2,200V AC
Electrical Life	Min 6,000 Cycles at rated switch load (p.f.= .75-.80)
Max Working Voltage	600V AC
Current Interrupting	Certified for current interrupting at full rated current and voltage
Horsepower Locked Rotor Test	50 Operations at 600% of full load motor current (p.f.= .40-.50)
Short Circuit	100kA when protected by Class J fuse. Also 125A RK1 fuse for 100A devices only
Endurance	Min 10,000 mating cycles
Flammability	V-0
Operating Temperature	Max Continuous +75°C; Min continuous -40°C
Environmental	Type 4X, 12 and IP69k
UV Resistance	All materials are UV stabilized

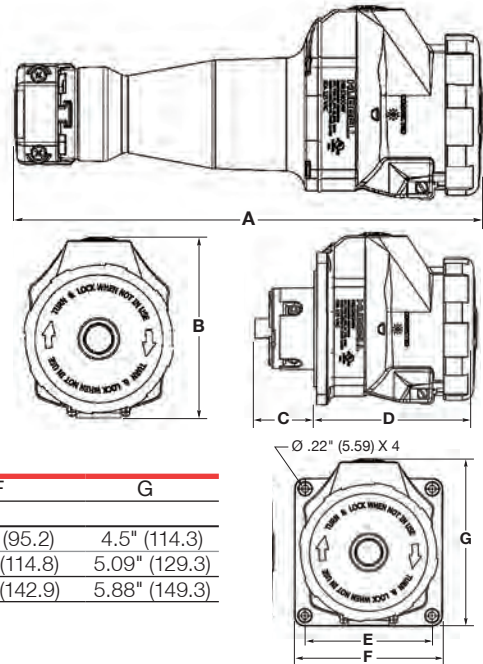

Dimensions

Description	Connector		Receptacle				
	A	B	C	D	E	F	G
30A	9.9" (251.5)	4.5" (114.3)	1.06" (27.2)	3.83" (97.3)	3.13" (79.4)	3.75" (95.2)	4.5" (114.3)
60A	12.22" (310.4)	5.17" (131.3)	1.85" (47.0)	4.77" (121.2)	3.88" (98.6)	4.52" (114.8)	5.09" (129.3)
100A	15.89" (403.6)	5.63" (142.9)	3.08" (78.2)	5.03" (127.6)	4.87" (123.7)	5.63" (142.9)	5.88" (149.3)

Watertight Materials

Part	Material	Part	Material
Plug		Inlet	
Housing	PBT	Housing	PBT
Locking Ring	PBT	Locking Ring	PBT
Sealing Gasket	Solid Neoprene	Mounting Flange	PBT
Cord Clamp	PBT	Mounting Screws	Stainless Steel (300 Series)
Gland Cap	PBT	Contact Carrier	High-Impact Thermoset
Gland	Solid Neoprene	Retainer	High-Impact Thermoset
Cord Clamp Screws	Stainless Steel (300 Series)	Ground, Phase Pins	Brass (M-Series - Nickel-plated brass)
Clamp Nut	Nickel-Plated Brass	Terminal Screws	Stainless Steel (300 Series)
Gland Clamp Screws	Stainless Steel (300 Series)	Assembly Screws (2)	Stainless Steel (300 Series)
Contact Carrier	High-Impact Thermoset	Gaskets	Solid Neoprene
Retainer	High-Impact Thermoset	Receptacle	
Ground, Phase Pins	Brass (M-Series - Nickel-plated brass)	Housing	PBT
Terminal Screws	Stainless Steel (300 Series)	Mounting Flange	PBT
Assembly Screws	Stainless Steel (300 Series)	Arm Spring	Stainless Steel (17-7 type)
Connector Body		Cover Arm	PBT
Housing	PBT	Cover	PBT
Cord Clamps	PBT	Cover Screw	Nickel-plated brass
Glands	Solid Neoprene	Gaskets	Solid Neoprene
Cover Arms	PBT	Mounting Screws	Stainless Steel (300 Series)
Arm Springs	Stainless Steel (17-7 type)	Terminal Screws	Stainless Steel (300 Series)
Covers	PBT	Phase, Ground Sleeves	Brass
Cover Screw	Nickel-plated brass	Sleeve Spring	20A and 30A Stainless Steel (300 Series); others are Beryllium Copper multi-contact inserts with silver plating
Gaskets	Solid Neoprene		
Contact Carrier	High-Impact Thermoset		
Retainer	High-Impact Thermoset		
Phase, Ground Sleeves	Brass		
Sleeve Spring	20A and 30A Stainless Steel (300 Series); others are Beryllium Copper multi-contact inserts with silver plating		
Terminal Screws	Stainless Steel (300 Series)		
Assembly Screws	Stainless Steel (300 Series)		

Specifications

Typical Specification	
Manufacturer's Identification	Hubbell HBL520P9W
Description	Plug, Power Supply
Type	3 Pole + Neutral + Earth
Rating	20A, 120/208V AC, 3 Phase WYE
Configuration	UL 1686 C2, IEC 60309-2, Clock Position 9, Watertight
Certification	UL Listed, File E146032 Receptacles and Inlets, E146033 Plugs and Connectors, UL Standard UL1682 and UL 1686C2, CSA Certified File LR280C for Plugs, Connectors Inlets and LR285C for Receptacle CSA Standard C22.2 No. 182.1, UL Classified to IEC 60309-1 IEC 60309-2

Listed to standard UL1682/CSA C22.2 No. 182.1-02, Plugs, Receptacles and cable connectors of the Pin and Sleeve Type.

UL Classified to IEC Standards 60309-1 (Plugs, Socket Outlets, and Couplers for Industrial Purposes) for Series I (European) rated voltages and services.

When used with cord, these devices require no further investigation by UL for equipment Classification to IEC 435 or IEC 380.

PBT is a trademark of SABIC Innovative Plastics, acquired from General Electric Company.

Pin and Sleeve Devices/Mechanical Interlocks

Performance

Electrical

Dielectric Withstand Voltage	3000V AC.
Max. Working Voltage	600V RMS (i.e., minimum creepage distance 10 millimeters, minimum clearance 8 millimeters, per IEC 60309-1 for devices rated over 500V).
Current Interrupting	Certified for current interrupting at full rated current (Except DC rated devices).
Temperature Rise	Max. 30°C temperature rise at full rated current after 50 cycles of overload at 150% of rated current at a power factor of 75%.
Endurance	5,000 connect and disconnect cycles with load for 16A and 20A, 1,000 cycles with load and 1,000 cycles without load for 30A, 32A, 60A and 63A, and 250 cycles with load and 250 cycles without load for 100A and 125A.

Mechanical

Impact Resistance	Per CSA C22.2 No. 182.1 / UL1682.
Cord Grip Cable Retention	Per CSA C22.2 No. 182.1 / UL1682.
Cord Accommodation	Round portable service cords of diameters commensurate with the device rating as defined in UL Standard 62, CSA C22.2 No. 49 and the harmonized <HAR> European Standards.
Terminal Identification	Terminals identified in accordance with North American and IEC conventions.
Product Identification	Identification and ratings are a permanent part of the device housing.

Environmental

Moisture Resistance	Watertight per IEC 60309-1.
Ingress Protection	TYPE 4X, 12 and IP69K.
Flammability	V.0.
Operating Temperatures	Maximum Continuous 75°C; Minimum - 40°C without impact.

Materials

Housings	PBT.
All Other Materials	Resistant to corrosion and chemical attack.

Note: Specification sheets for all other Pin and Sleeve catalog numbers are available upon request.

Horsepower Ratings for Hubbell IEC Pin and Sleeve Devices*

Single Phase

Amps	Wire Count	Voltage	Clock	Catalog Number	HP Rating
20	3	125V	4	HBL320x4W	1
20	3	250V	6	HBL320x6W	2
20	3	480V	7	HBL320x7W	5
20	4	125/250 (208L-L)	12	HBL420x12W	2
20	4	125/250 (250L-L)	12	HBL420x12W	2
20	4	125/250 (125L-N)	12	HBL420x12W	1
30	3	125V	4	HBL330x4W	2
30	3	250V	6	HBL330x6W	3
30	3	480V	7	HBL330x7W	7.5
30	3	550VDC	8	HBL330X8	N/A
30	4	125/250 (208L-L)	12	HBL430x12W	3
30	4	125/250 (250L-L)	12	HBL430x12W	3
30	4	125/250 (125L-N)	12	HBL430x12W	2
60	3	125V	4	HBL360x4W	2
60	3	250V	6	HBL360x6W	3
60	3	480V	7	HBL360x7W	7.5
60	3	250VDC	3	HBL360x3W	N/A
60	3	550VDC	8	HBL360x8W	N/A
60	4	125/250 (208L-L)	12	HBL460x12W	3
60	4	125/250 (250L-L)	12	HBL460x12W	3
60	4	125/250 (125L-N)	12	HBL460x12W	2
100	3	125V	4	HBL3100x4W	5
100	3	250V	6	HBL3100x6W	15
100	3	480V	7	HBL3100x7W	30
100	3	250VDC	3	HBL3100x3W	N/A
100	3	550VDC	8	HBL3100x8W	N/A
100	4	125/250 (208L-L)	12	HBL4100x12W	10
100	4	125/250 (250L-L)	12	HBL4100x12W	15
100	4	125/250 (125L-N)	12	HBL4100x12W	5

3-Phase

Amps	Wire Count	Voltage	Clock	Catalog Number	HP Rating
20	4	3Ø 250V	9	HBL420x9W	5
20	4	3Ø 480V	7	HBL420x7W	10
20	4	3Ø 600V	5	HBL420x5W	10
20	4	3Ø 380-415V	6	HBL420x6W	7.5
20	5	3ØY 120/208V	9	HBL520x9W	3
20	5	3ØY 277/480V	7	HBL520x7W	10
20	5	3ØY 347/600V	5	HBL520x5W	10
20	5	3Ø 240/415V	6	HBL520x6W	5
30	4	3Ø 250V	9	HBL430x9W	7.5
30	4	3Ø 480V	7	HBL430x7W	15
30	4	3Ø 600V	5	HBL430x5W	20
30	5	3ØY 120/208V	9	HBL530x9W	5
30	5	3ØY 277/480V	7	HBL530x7W	15
30	5	3ØY 347/600V	5	HBL530x5W	20
30	4	3Ø 380/415V	6	HBL430x6W	10
30	5	3Ø 200/346-240/415	6	HBL530x6W	10
60	4	3Ø 250V	9	HBL460x9W	7.5
60	4	3Ø 480V	7	HBL460x7W	20
60	4	3Ø 600V	5	HBL460x5W	25
60	4	3Ø 380-415VAC	6	HBL460x6W	10
60	5	3ØY 120/208V	9	HBL560x9W	7.5
60	5	3ØY 277/480V	7	HBL560x7W	20
60	5	3ØY 347/600V	5	HBL560x5W	25
60	5	3Ø 200/346-240/415	6	HBL560x6W	10
100	4	3Ø 250V	9	HBL4100x9W	15
100	4	3Ø 480V	7	HBL4100x7W	40
100	4	3Ø 600V	5	HBL4100x5W	50
100	4	3Ø 380-415V	6	HBL4100x6W	30
100	5	3ØY 200/346-240/415V	6	HBL5100x6W	30
100	5	400VDC	8	HBL5100x8W	N/A
100	5	3ØY 120/208V	9	HBL5100x9W	15
100	5	3ØY 277/480V	7	HBL5100x7W	40
100	5	3ØY 347/600V	5	HBL5100x5W	50

Note: *Horsepower Ratings are NOT standardized amongst different Pin and Sleeve manufacturers.

Pin and Sleeve Devices/Mechanical Interlocks

Hubbell-PRO Commercial Pin and Sleeve Devices

Hubbell has the IEC Pin and Sleeve Solution — No Matter what Environment or Application! Hubbell-PRO pin and sleeve is value engineered for commercial and light duty applications. Devices are UL certified conforming to IEC 60309, UL 1682 and are dual-rated where applicable. North American devices are offered in 20A, 30A, 60A and 100A; European devices are available in 16A, 32A, 63A and 125A versions. A complete line of watertight and splash proof versions are available. Numerous features provide installation efficiencies including Edge Series Screwless terminations, glandless water ingress protection, bulk packs and NPT threaded versions for adapter free installations for liquid light applications.



IP67



IP44



Liquid Tight

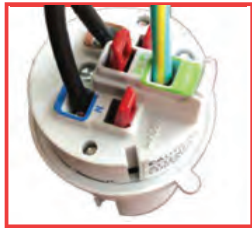

Edge Series Screwless Terminations

- Strong spring continuously applies pressure as strands relax
- Eliminates timely step of ferrules
- No Torque screwdriver required



Glandless Water Ingress Protection –

- Integral and permanently attached to the device
- Available in either IP44 or IP67 Water ingress protection



Dual Rated Devices

- Single SKU certified for use in North America and Internationally
- Accepts full range of UL and VDE approved cable



Back Boxes and accessories

- A complete line of metallic and non-metallic back boxes
- Adapter plates allow receptacles and inlets to be mounted to Hubbell Back Boxes



Screwless Two Piece Housing 60A – 125A devices

- Single Push Tab Secures Housing & IP67 Rating



Liquid Tight Versions:

- Integral NPT threaded back housing directly accepts liquid tight fittings

Pin and Sleeve Devices/Mechanical Interlocks

Watertight Series North American Ratings



Amps	Dual Rated:	Ratings	Watertight IP67 Suitability			
			Inlet*	Connector	Plug	Receptacle
16 & 20		2P/3W, 20A 125V AC	C320B4WA	C320C4WA	C320P4WA	C320R4WA
	Dual Rated:	2P/3W, 20A 250V AC/16A 220-240V	C320B6WA	C320C6WA	C320P6WA	C320R6WA
		2P/3W, 20A 480V AC	C320B7WA	C320C7WA	C320P7WA	C320R7WA
		3P/4W, 20A 3P 600V	C420B5WA	C420C5WA	C420P5WA	C420R5WA
	Dual Rated:	2P/3W, 20A 250V AC/16A 220-240V	C420B6WA	C420C6WA	C420P6WA	C420R6WA
		3P/4W, 20A 3P 480V	C420B7WA	C420C7WA	C420P7WA	C420R7WA
	Dual Rated:	3P/4W, 16/20A 3P 250 VAC	C420B9WA	C420C9WA	C420P9WA	C420R9WA
		4P/5W, 20A 347/600V	C520B5WA	C520C5WA	C520P5WA	C520R5WA
	Dual Rated:	4P/5W, 16/20A 200-415V AC	C520B6WA	C520C6WA	C520P6WA	C520R6WA
		4P/5W, 20A 277/480V	C520B7WA	C520C7WA	C520P7WA	C520R7WA
Dual Rated:	4P/5W, 16/20A 120/208V	C520B9WA	C520C9WA	C520P9WA	C520R9WA	
30 & 32		2P/3W, 30A 125V AC	C330B4WA	C330C4WA	C330P4WA	C330R4WA
	Dual Rated:	2P/3W, 30A 250V/32A 220-240V	C330B6WA	C330C6WA	C330P6WA	C330R6WA
		2P/3W, 30A 480V AC	C330B7WA	C330C7WA	C330P7WA	C330R7WA
		3P/4W, 30A 3P 600V	C430B5WA	C430C5WA	C430P5WA	C430R5WA
	Dual Rated:	3P/4W, 30/32A 380-415V AC	C430B6WA	C430C6WA	C430P6WA	C430R6WA
		3P/4W, 30A 3P 480V	C430B7WA	C430C7WA	C430P7WA	C430R7WA
	Dual Rated:	3P/4W, 30/32A 3P 250 VAC	C430B9WA	C430C9WA	C430P9WA	C430R9WA
		4P/5W, 30A 347/600V	C530B5WA	C530C5WA	C530P5WA	C530R5WA
	Dual Rated:	4P/5W, 30/32A 200-415V AC	C530B6WA	C530C6WA	C530P6WA	C530R6WA
		4P/5W, 30A 277/480V	C530B7WA	C530C7WA	C530P7WA	C530R7WA
Dual Rated:	4P/5W, 30/32A 120/208V	C530B9WA	C530C9WA	C530P9WA	C530R9WA	
60 & 63		2P/3W, 60A 125V AC	C360B4WA	C360C4WA	C360P4WA	C360R4WA
	Dual Rated:	2P/3W, 60A 250V/63A 220-240V	C360B6WA	C360C6WA	C360P6WA	C360R6WA
		2P/3W, 60A 480V AC	C360B7WA	C360C7WA	C360P7WA	C360R7WA
		3P/4W, 60A 3P 600V	C460B5WA	C460C5WA	C460P5WA	C460R5WA
	Dual Rated:	3P/4W, 60/63A 380-415V AC	C460B6WA	C460C6WA	C460P6WA	C460R6WA
		3P/4W, 60A 3P 480V	C460B7WA	C460C7WA	C460P7WA	C460R7WA
	Dual Rated:	3P/4W, 60/63A 3P 250 VAC	C460B9WA	C460C9WA	C460P9WA	C460R9WA
		4P/5W, 60A 347/600V	C560B5WA	C560C5WA	C560P5WA	C560R5WA
	Dual Rated:	4P/5W, 60/63A 200-415V AC	C560B6WA	C560C6WA	C560P6WA	C560R6WA
		4P/5W, 60A 277/480V	C560B7WA	C560C7WA	C560P7WA	C560R7WA
Dual Rated:	4P/5W, 60/63A 120/208V	C560B9WA	C560C9WA	C560P9WA	C560R9WA	

See page G-28 for Back Boxes and G-36 for product dimensions.

* Adapter plates required for mounting to Hubbell back boxes. 20& 30A use AP2030, 60A use AP60 and 100A use AP100.

Pin and Sleeve Devices/Mechanical Interlocks

Watertight Series North American Ratings (Cont'd)



Amps	Dual Rated:	Ratings	Watertight IP67 Suitability			
			Inlet*	Connector	Plug	Receptacle*
100 & 125	Dual Rated:	2P/3W, 100A 250V AC/125A 220-240V	C3100B6WA	C3100C6WA	C3100P6WA	C3100R6WA
		2P/3W, 100A 480V AC	C3100B7WA	C3100C7WA	C3100P7WA	C3100R7WA
		3P/4W, 100A 3P 600V	C4100B5WA	C4100C5WA	C4100P5WA	C4100R5WA
	Dual Rated:	3P/4W, 100/125A 380-415V AC	C4100B6WA	C4100C6WA	C4100P6WA	C4100R6WA
		3P/4W, 100A 3P 480V	C4100B7WA	C4100C7WA	C4100P7WA	C4100R7WA
	Dual Rated:	3P/4W, 100/125A 3P 250 VAC	C4100B9WA	C4100C9WA	C4100P9WA	C4100R9WA
		4P/5W, 100A 347/600V	C5100B5WA	C5100C5WA	C5100P5WA	C5100R5WA
	Dual Rated:	4P/5W, 100/125A 200-415V AC	C5100B6WA	C5100C6WA	C5100P6WA	C5100R6WA
		4P/5W, 100A 277/480V	C5100B7WA	C5100C7WA	C5100P7WA	C5100R7WA
	Dual Rated:	4P/5W, 100/125A 120/208V	C5100B9WA	C5100C9WA	C5100P9WA	C5100R9WA

Watertight Series International Ratings



Amps	Ratings	Watertight IP67 Suitability			
		Inlet*	Connector	Plug	Receptacle*
16A	2P/3W, 16A 100-130V	C316B4WA	C316C4WA	C316P4WA	C316R4WA
	2P/3W, 16A 220-240V	C316B6WA	C316C6WA	C316P6WA	C316R6WA
	2P/3W, 16A 380-415V	C416B6WA	C416C6WA	C416P6WA	C416R6WA
	4P/5W, 16A 200-415V	C516B6WA	C516C6WA	C516P6WA	C516R6WA
32A	2P/3W, 32A 100-130V	C332B4WA	C332C4WA	C332P4WA	C332R4WA
	2P/3W, 32A 220-240V	C332B6WA	C332C6WA	C332P6WA	C332R6WA
	3P/4W, 32A 380-480V	C432B3WA	C432C3WA	C432P3WA	C432R3WA
	3P/4W, 32A 380-415V	C432B6WA	C432C6WA	C432P6WA	C432R6WA
	4P/5W, 32A 200-415V	C532B6WA	C532C6WA	C532P6WA	C532R6WA
63A	2P/3W, 63A 220-240V	C363B6WA	C363C6WA	C363P6WA	C363R6WA
	3P/4W, 63A 380-415V	C463B6WA	C463C6WA	C463P6WA	C463R6WA
	4P/5W, 63A 200-415V	C563B6WA	C563C6WA	C563P6WA	C563R6WA
125A	2P/3W, 125A 220-240V	C3125B6WA	C3125C6WA	C3125P6WA	C3125R6WA
	3P/4W, 125A 380-415V	C4125B6WA	C4125C6WA	C4125P6WA	C4125R6WA
	4P/5W, 125A 200-415V	C5125B6WA	C5125C6WA	C5125P6WA	C5125R6WA

See page G-28 for Back Boxes and G-36 for product dimensions.

* Adapter plates required for mounting to Hubbell back boxes. 20& 30A use AP2030, 60A use AP60 and 100A use AP100.

Pin and Sleeve Devices/Mechanical Interlocks

Splashproof Series North American Ratings

Amps	Ratings	Splashproof IP44 Suitability			
		Inlet*	Connector	Plug	Receptacle*
16 & 20	2P/3W, 20A 125V AC	C320B4SA	C320C4SA	C320P4SA	C320R4SA
	Dual Rated 2P/3W, 20A 250V AC/16A 220-240V	C320B6SA	C320C6SA	C320P6SA	C320R6SA
	2P/3W, 20A 480V AC	C320B7SA	C320C7SA	C320P7SA	C320R7SA
	3P/4W, 20A 3Ø 600V	C420B5SA	C420C5SA	C420P5SA	C420R5SA
	Dual Rated 2P/3W, 20A 250V AC/16A 220-240V	C420B6SA	C420C6SA	C420P6SA	C420R6SA
	3P/4W, 20A 3Ø 480V	C420B7SA	C420C7SA	C420P7SA	C420R7SA
	Dual Rated 3P/4W, 16/20A 3P 250 VAC	C420B9SA	C420C9SA	C420P9SA	C420R9SA
	4P/5W, 20A 347/600V	C520B5SA	C520C5SA	C520P5SA	C520R5SA
	Dual Rated 4P/5W, 16/20A 200-415V AC	C520B6SA	C520C6SA	C520P6SA	C520R6SA
	4P/5W, 20A 277/480V	C520B7SA	C520C7SA	C520P7SA	C520R7SA
Dual Rated 4P/5W, 16/20A 120/208V	C520B9SA	C520C9SA	C520P9SA	C520R9SA	
30 & 32	2P/3W, 30A 125V AC	C330B4SA	C330C4SA	C330P4SA	C330R4SA
	Dual Rated 2P/3W, 30A 250V AC/32A 220-240V	C330B6SA	C330C6SA	C330P6SA	C330R6SA
	2P/3W, 30A 480V AC	C330B7SA	C330C7SA	C330P7SA	C330R7SA
	3P/4W, 30A 3Ø 600V	C430B5SA	C430C5SA	C430P5SA	C430R5SA
	Dual Rated 3P/4W, 30/32A 380-415V AC	C430B6SA	C430C6SA	C430P6SA	C430R6SA
	3P/4W, 30A 3Ø 480V	C430B7SA	C430C7SA	C430P7SA	C430R7SA
	Dual Rated 3P/4W, 30/32A 3P 250 VAC	C430B9SA	C430C9SA	C430P9SA	C430R9SA
	4P/5W, 30A 347/600V	C530B5SA	C530C5SA	C530P5SA	C530R5SA
	Dual Rated 4P/5W, 30/32A 200-415V AC	C530B6SA	C530C6SA	C530P6SA	C530R6SA
	4P/5W, 30A 277/480V	C530B7SA	C530C7SA	C530P7SA	C530R7SA
Dual Rated 4P/5W, 30/32A 120/208V	C530B9SA	C530C9SA	C530P9SA	C530R9SA	
60 & 63	2P/3W, 60A 125V AC	C360B4SA	C360C4SA	C360P4SA	C360R4SA
	Dual Rated 2P/3W, 60A 250V AC/63A 220-240V	C360B6SA	C360C6SA	C360P6SA	C360R6SA
	2P/3W, 60A 480V AC	C360B7SA	C360C7SA	C360P7SA	C360R7SA
	3P/4W, 60A 3Ø 600V	C460B5SA	C460C5SA	C460P5SA	C460R5SA
	Dual Rated 3P/4W, 60/63A 380-415V AC	C460B6SA	C460C6SA	C460P6SA	C460R6SA
	3P/4W, 60A 3Ø 480V	C460B7SA	C460C7SA	C460P7SA	C460R7SA
	Dual Rated 3P/4W, 60/63A 3P 250 VAC	C460B9SA	C460C9SA	C460P9SA	C460R9SA
	4P/5W, 60A 347/600V	C560B5SA	C560C5SA	C560P5SA	C560R5SA
	Dual Rated 4P/5W, 60/63A 200-415V AC	C560B6SA	C560C6SA	C560P6SA	C560R6SA
	4P/5W, 60A 277/480V	C560B7SA	C560C7SA	C560P7SA	C560R7SA
Dual Rated 4P/5W, 60/63A 120/208V	C560B9SA	C560C9SA	C560P9SA	C560R9SA	

See page G-28 for Back Boxes. Dimensions are available online.

* Adapter plates required for mounting to Hubbell back boxes. 20 & 30A use AP2030, 60A use AP60 and 100A use AP100.

Pin and Sleeve Devices/Mechanical Interlocks



Splashproof Series International Ratings

Amps	Ratings	Splashproof IP44 Suitability			
		Inlet	Connector	Plug	Receptacle
16A	2P/3W, 16A 100-130V	C316B4SA	C316C4SA	C316P4SA	C316R4SA
	2P/3W, 16A 220-240V	C316B6SA	C316C6SA	C316P6SA	C316R6SA
	2P/3W, 16A 380-415V	C416B6SA	C416C6SA	C416P6SA	C416R6SA
	4P/5W, 16A 200-415V	C516B6SA	C516C6SA	C516P6SA	C516R6SA
32A	2P/3W, 32A 100-130V	C332B4SA	C332C4SA	C332P4SA	C332R4SA
	2P/3W, 32A 220-240V	C332B6SA	C332C6SA	C332P6SA	C332R6SA
	3P/4W, 32A 380-480V	C432B3SA	C432C3SA	C432P3SA	C432R3SA
	3P/4W, 32A 380-415V	C432B6SA	C432C6SA	C432P6SA	C432R6SA
	4P/5W, 32A 200-415V	C532B6SA	C532C6SA	C532P6SA	C532R6SA
63A	2P/3W, 63A 220-240V	C363B6SA	C363C6SA	C363P6SA	C363R6SA
	3P/4W, 63A 380-415V	C463B6SA	C463C6SA	C463P6SA	C463R6SA
	4P/5W, 63A 200-415V	C563B6SA	C563C6SA	C563P6SA	C563R6SA

Liquid Tight Versions

Amps	Ratings	1/2" Conduit Fitting		3/4" Conduit Fitting	
		IP44 Connector	IP67 Connector	IP44 Connector	IP67 Connector
30A	5H 3Ø 347/600 VAC	C530C5SLT12	C530C5WLT12	C530C5SLT34	C530C5WLT34
30A/32A	6H 3Ø 200/346-240/415 VAC	C530C6SLT12	C530C6WLT12	C530C6SLT34	C530C6WLT34
30A	7H 3ØY 277/480 VAC	C530C7SLT12	C530C7WLT12	C530C7SLT34	C530C7WLT34
30A/32A	9H 3ØY 120/208VAC	C530C9SLT12	C530C9WLT12	C530C9SLT34	C530C9WLT34
Amps	Ratings	3/4" Conduit Fitting		1" Conduit Fitting	
		IP44 Connector	IP67 Connector	IP44 Connector	IP67 Connector
60A	4H 125 VAC	C360C4SLT100	C360C4WLT100	C360C4SLT100	C360C4WLT100
60A/63A	6H 250 VAC	C360C6SLT100	C360C6WLT100	C360C6SLT100	C360C6WLT100
60A	7H 480 VAC	C360C7SLT100	C360C7WLT100	C360C7SLT100	C360C7WLT100
60A	5H 3ØY347/600 VAC	C460C5SLT100	C460C5WLT100	C460C5SLT100	C460C5WLT100
60A/63A	6H 3Ø 200/346 -240/415 VAC	C460C6SLT100	C460C6WLT100	C460C6SLT100	C460C6WLT100
60A	7H 3Ø 480 VAC	C460C7SLT100	C460C7WLT100	C460C7SLT100	C460C7WLT100
60A/63A	9H 3ØY 120/208 VAC	C460C9SLT100	C460C9WLT100	C460C9SLT100	C460C9WLT100
60A	5H 3Ø 347/600 VAC	C560C5SLT100	C560C5WLT100	C560C5SLT100	C560C5WLT100
60A/63A	6H 3Ø 200/346-240/415 VAC	C560C6SLT100	C560C6WLT100	C560C6SLT100	C560C6WLT100
60A	7H 3ØY 277/480 VAC	C560C7SLT100	C560C7WLT100	C560C7SLT100	C560C7WLT100
60A/63A	9H 3ØY 120/208VAC	C560C9SLT100	C560C9WLT100	C560C9SLT100	C560C9WLT100

Dimensions available online

* Mating plugs are certified for installation on cable only.

Pin and Sleeve Devices/Mechanical Interlocks

Features and Benefits

IP67
SUITABILITY

Unfused Circuit-Lock® Pin and Sleeve Mechanical Interlocks

The National Electrical Code (NEC®) requires a separate disconnect means within sight of all motor loads. The NEC requires the disconnecting means in a motor-circuit be listed as “Suitable as Motor Disconnect” if the motor is rated greater than 2 HP.

Hubbell’s revolutionary Circuit-Lock interlock incorporates the disconnect switch and receptacle in one compact, non-metallic and economical unit. Removing the plug and locking it out provides a visual means of verifying equipment has been disconnected. All Circuit-Lock mechanical interlocks can be locked out as a method of compliance with the OSHA Lockout/Tagout regulation.

The switch cannot be turned ON until the plug is completely engaged, and the plug cannot be removed until the switch is turned OFF. At the same time, it eliminates the possibility of making or breaking the circuit under load or making a casual or “lazy” connection. The non-metallic enclosure can be connected to the metallic conduit and not interfere with the ground continuity.

In addition, these horsepower rated units are durable, watertight and easy to install. And they are compatible with IEC 60309-2 plugs. These Circuit-Lock units are available in 20, 30, 60 and 100A models, and in 3, 4 and 5 wire configurations that are designed to the IEC 60309-1 and 60309-2 standards.

Hubbell’s Circuit-Lock Mechanical Interlocks are also available in “Reverse Service” versions. These units incorporate the disconnect switch and reverse service receptacle (inlet) in one compact, non-metallic and economical unit. These units are available in 30, 60 and 100A models, 4 wire configurations.



Housing Design

- Insulated non-metallic housing, super tough, non-conductive and chemical resistant for heavy duty industrial environments
- IEC pin and sleeve devices are color coded by voltage for easy identification
- Self-closing gasketed cover, detents into position to fully close automatically

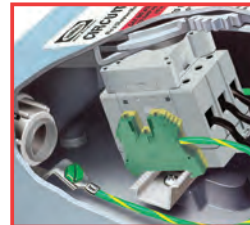

Interior Design

- Large gears enclosed in a gear box assembled on one plane to eliminate possible gear jumping
- Horsepower rated disconnect switch handles large motor loads
- DIN rail mounted switch for easy installation and replacement



Safety

- Lockable handle to meet OSHA Lockout/Tagout regulations
- Two-stage interlocking mechanism to help defeat tampering
- Watertight conduit hub and grounding plate for use on metallic conduit (IP67 suitability)



Liftcover

- Replaceable spring-loaded liftcover with gasket for a watertight seal
- Pre-wired IEC Pin and Sleeve receptacle
- Reverse service has dependable solid brass pins for longer life and reliable electrical contact

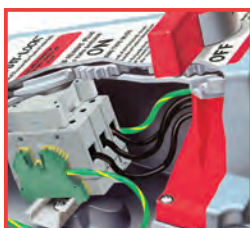

Identification

- Color coded rating pad and receptacle mount to signify voltage



Installation

- Comes with brass inserts and stainless steel screws for higher torque and better sealing
- Three molded-in conduit drill points are located on top, bottom and back surface of enclosure
- Adjustable mounting feet are ductile to allow mounting on irregular surfaces

NEC® is a registered trademark of the National Fire Protection Association (NFPA).

Pin and Sleeve Devices/Mechanical Interlocks



IP67
SUITABILITY

Enclosure Type 4X, 12

Rating					Unfused Circuit-Lock® Devices		Reverse Service	
Amps	Poles and Wires	Configuration Recept.	Plug	AC Voltage	Mechanical Interlock	Mating Plug	Mechanical Interlock	Mating Plug
20	3P 4W			120/240V			—	—
	3P 4W			3Ø 240V			—	—
	3P 4W			3Ø 480V			—	—
	3P 4W			3Ø 600V			—	—
30	2P 3W			120V			—	—
	2P 3W			240V			—	—
	2P 3W			480V			—	—
	3P 4W			120/240V			—	—
	3P 4W			3Ø 240V				
	3P 4W			3Ø 480V				
	3P 4W			3Ø 600V				
	4P 5W			3ØY 120/208V			—	—
	4P 5W			3ØY 277/480V			—	—
	4P 5W			3ØY 347/600V			—	—
32	3P 4W			380V 50HZ-440V 60HZ			—	—
60	2P 3W			120V			—	—
	2P 3W			240V			—	—
	2P 3W			480V			—	—
	3P 4W			120/240V				
	3P 4W			3Ø 240V				
	3P 4W			3Ø 480V				
	3P 4W			3Ø 600V				
	4P 5W			3ØY 120/208V			—	—
	4P 5W			3ØY 277/480V			—	—
	4P 5W			3ØY 347/600V			—	—
100	2P 3W			240V			—	—
	3P 4W			120/240V				
	3P 4W			3Ø 240V				
	3P 4W			3Ø 480V				
	3P 4W			3Ø 600V				
	4P 5W			3ØY 120/208V			—	—

Note: 20, 30 and 32A – 1 inch NPT hub supplied; 60 and 100A – 1¼ inch hub supplied.

Pin and Sleeve Devices/Mechanical Interlocks



HBLAC1

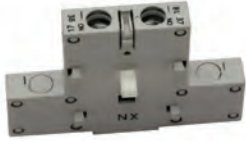

HBLAC2



HBL30RGB

HBL30RNB



MICPK30



CA3430MI



HBL30MIRS



HBLRFT2

Dimensions in Inches (mm)

Auxiliary Contacts for 20, 30, 32, 60 and 100A Switch, NEMA A600 Pilot Duty

Description	Catalog Number
"Break After Main Break", 1 set of n/o contacts, 1 set of n/c contacts.	HBLAC1
"Break Before Main Break", 1 set of n/o contacts.	HBLAC2

Ground Block

Description	Catalog Number
For 20, 30 and 32A switches.	HBL30RGB
For 60 and 100A switches.	HBL60100RGB

Neutral Block

Description	Catalog Number
For 20, 30 and 32A switches.	HBL30RNB
For 60A switches.	HBL60RNB
For 100A switches.	HBL100RNB

Watertight Closure Plug Kits

Description	Catalog Number
For 20, 30 and 32A Circuit-Lock Unfused and Fused Pin and Sleeve mechanical interlocks.	MICPK30
For 60 and 100A Circuit-Lock Unfused and Fused Pin and Sleeve mechanical interlocks.	MICPK60

Replacement Flip Covers

Description	Catalog Number
For 20A mechanical interlocks.	CA420MI
For 30 and 32A, 3 and 4 wire mechanical interlocks.	CA3430MI
For 30A, 5 wire mechanical interlocks.	CA530MI
For 60A mechanical interlocks.	CA60MI
For 100A mechanical interlocks.	CA100MI

Replacement Switches

Description	Catalog Number
For 20A mechanical interlocks.	HBLDS3RS
For 30 and 32A mechanical interlocks.	HBL30MIRS
For 60 and 100A mechanical interlocks.	HBLDS60100RS

Replacement Mounting Feet

Description	Catalog Number
For 20, 30, 32, 60 and 100A mechanical interlocks.	HBLRFT2*

Dimensions

KEY	20A and 30A Inches (mm)	60A Inches (mm)	100A Inches (mm)
A	7.75" (196.9)	7.75" (196.9)	7.75" (196.9)
B	6.87" (174.5)	6.87" (174.5)	6.87" (174.5)
C	4.75" (120.7)	4.75" (120.7)	4.75" (120.7)
D	1.02" (25.9)	1.02" (25.9)	1.02" (25.9)
E	1.60" (40.6)	1.46" (37.1)	1.46" (37.1)
F	11.00" (279.4)	12.75" (323.9)	12.75" (323.9)
G	8.75" (222.3)	8.75" (222.3)	8.75" (222.3)
H	8.00" (203.2)	9.75" (247.7)	9.75" (247.7)
I	10.12" (257.0)	11.87" (301.5)	11.87" (301.5)
J	6.88" (174.8)	6.88" (174.8)	6.88" (174.8)
K	1.93" (49.0)	2.09" (53.1)	2.09" (53.1)
L	11.25" (285.8)**	13.65" (346.7)	13.65" (346.7)
M	7.75" (196.9)	8.60" (218.4)	9.30" (236.2)
HUB SIZE	1.00" NPT	1.25" NPT	1.25" NPT

Note: *Package of 10 feet and 10 screws.

**30 and 32A, 3 and 4W = 11.50" (292.1);
30A, 5W = 11.59" (294.4).

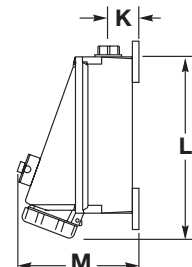
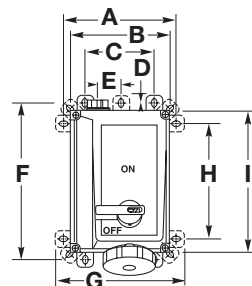
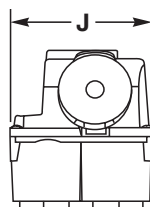

Pin and Sleeve Devices/Mechanical Interlocks

Typical Specifications

Manufacturer's Identification	Hubbell HBL430MI7W
Description	Circuit-Lock® Pin and Sleeve Mechanical Interlock
Electrical Type	3 Pole + Earth
Rating	30A, 480V AC, 3 Phase
Configuration	IEC 60309-2, UL1686 C2, Clock position 7
Enclosure Type	Indoor and Outdoor - 4X (Watertight, Washdown); Indoor - 12 (Dust-tight, Falling Dirt and Noncorrosive Liquids)
Ingress Protection	IP67 Suitability
Enclosure Material	Non-metallic, enclosure suitable for metallic conduit
Certification	UL Listed, CSA Certified

Note: This device provides on/off switched control of a plug connected load and includes an interlocking feature to prevent the plug from being disconnected while the receptacle is energized. The switch cannot be turned "ON" until the plug is inserted properly, and the plug cannot be removed until the switch is turned "OFF."

Materials

Part	Material	Part	Material
Base	PBT	Top	PBT
Handle	PBT	Conduit Hub	Zinc
Enclosure Gasket	Neoprene	Shaft	PBT
Shaft Seal	Neoprene	Ground Plate	Galvanized Steel
Enclosure Screws	Stainless Steel 300 Series	Enclosure Inserts	Brass
Hinge Pins	Nickel Plated Brass	Hinge Spring	Stainless Steel 300 Series

Performance

Electrical	
Dielectric Voltage	Withstands 3,000V AC Min.
Max. Working Voltage	600V AC RMS.
Current Interrupting	Certified for current interrupting at full rated current and voltage.
Short Circuit Withstand Rating	Suitable for use on a circuit capable of delivering not more than 10,000 RMS symmetrical amperes at the voltage rating of the receptacle. 20A and 30A models: Suitable for use on a circuit capable of delivering not more than 65,000 RMS symmetrical amperes, 600V when protected by class "J" fuses rated 30A.
Operations	Mechanical 10,000 cycles, electrical 6,000 cycles.

Operations

Mechanical

Impact Resistance	In accordance with UL 746C.
Terminal Identification	In accordance with UL, CSA and international conventions.
Product Identification	Identification and ratings are part of the external label and molded into the receptacle mount.
Mounting	External adjustable feet.

Environmental

Moisture Resistance	Indoor and Outdoor - 4X (Watertight, Washdown); Indoor - 12 (Dust-tight, Falling Dirt and Noncorrosive Liquids).
Ingress Protection	IP69K Suitability.
Flammability	UL94-5VA and V-0 Classification.
Operating Temperature	Max. Continuous +75°C; Min. Continuous -40°C.
UV Resistance	All materials are UV stabilized.

Horsepower Ratings

Amps	AC Voltage Rating	Horsepower	Mechanical Interlock	Mating Plug
20	120/240V AC	2	HBL420MI12W	HBL420P12W
20	3Ø 240V AC	5	HBL420MI9W	HBL420P9W
20	3Ø 480V AC	10	HBL420MI7W	HBL420P7W
20	3Ø 600V AC	10	HBL420MI5W	HBL420P5W
30	120V AC	2	HBL330MI4W	HBL330P4W
30	240V AC	3 (208-240V AC)	HBL330MI6W	HBL330P6W
30	480V AC	7.5	HBL330MI7W	HBL330P7W
30	120/240V AC	3 (208-240V AC)	HBL430MI12W	HBL430P12W
30	3Ø 600V AC	20	HBL430MI5W	HBL430P5W
30	3Ø 480V AC	15	HBL430MI7W	HBL430P7W
30	3Ø 250V AC	7.5	HBL430MI9W	HBL430P9W
30	3ØY 347/600V AC	20	HBL530MI5W	HBL530P5W
30	3ØY 277/480V AC	15	HBL530MI7W	HBL530P7W
30	3ØY 120/208V AC	5	HBL530MI9W	HBL530P9W
32	380V AC 50Hz – 440V AC 60Hz	15 (440V AC 3Ø 60Hz)	HBL432MI3W	HBL432P3W
60	120V AC	3	HBL360MI4W	HBL360P4W
60	240V AC	7.5 (208-240V AC)	HBL360MI6W	HBL360P6W
60	480V AC	20	HBL360MI7W	HBL360P7W
60	120/240V AC	7.5 (208-240V AC)	HBL460MI12W	HBL460P12W
60	3Ø 600V AC	40	HBL460MI5W	HBL460P5W
60	3Ø 480V AC	30	HBL460MI7W	HBL460P7W
60	3Ø 250V AC	15	HBL460MI9W	HBL460P9W
60	3ØY 347/600V AC	40	HBL560MI5W	HBL560P5W
60	3ØY 277/480V AC	30	HBL560MI7W	HBL560P7W
60	3ØY 120/208V AC	15	HBL560MI9W	HBL560P9W
100	240V AC	15 (10 @ 208V AC)	HBL3100MI6W	HBL3100P6W
100	120/240V AC	15	HBL4100MI12W	HBL4100P12W
100	3Ø 600V AC	50	HBL4100MI5W	HBL4100P5W
100	3Ø 480V AC	50	HBL4100MI7W	HBL4100P7W
100	3Ø 250V AC	25 (208-240V AC)	HBL4100MI9W	HBL4100P9W
100	3ØY 120/208V AC	20	HBL5100MI9W	HBL5100P9W

Pin and Sleeve Devices/Mechanical Interlocks

Features and Benefits

IP66
SUITABILITY

Fused Circuit-Lock® Pin and Sleeve Mechanical Interlocks

Hubbell Circuit-Lock® Pin and Sleeve Mechanical Interlocks are a revolutionary design that incorporates a disconnect switch and pin and sleeve receptacle in a compact non-metallic unit. These devices offer maximum safety by preventing users from mating or breaking a circuit under load—Hubbell's interlock mechanism detects the presence of a plug and prevents it from being removed when the switch is in the "ON" position.

It features a high visibility red handle that can be locked in the OFF position to meet OSHA lockout/tagout regulations. The enclosure door can be locked to prevent unauthorized access. The rugged, corrosion-resistant Type 4X PBT enclosure features adjustable mounting feet for flexible installation, while the receptacle's spring-loaded cover with gasket is dust tight and provides a watertight seal when turned and locked.

The patented Plug-Check™ mechanism detects the presence of the plug. It operates as a clutch to engage the handle with the switch and captures the plug. This action prevents the plug from being removed until the switch is turned OFF.



Housing Design

- Non-metallic enclosure meets UL 50E Type 4X (watertight), 12 (dust-tight) and IP66 suitability requirements. Enclosure is molded of rugged thermoplastic PBT to resist abuse, corrosion and enhance safety
- Stainless steel ¼ turn door fasteners for quick, easy access to fuses



Interior Design

- Compact Fused Disconnect Switch accepts **Class "J" fuses**. Fuse holders are top mounted for easy access
- The switch accepts auxiliary contacts for control circuit applications including the ON/OFF control of remote pilot lights or signal for programmable controllers



Safety

- High visibility red handle can be locked in the OFF position as a method of compliance with OSHA lockout requirements. Accepts up to a 5/16 inch padlock shackle
- Replaceable spring-loaded receptacle liftcover with gasket ensures dust tight rating; liftcover provides watertight seal when turned and locked



Contact Carrier

- Thermoset polyester contact carrier provides resistance to electrical tracking and withstands higher temperatures
- Thermoset properties provide excellent dimensional stability, low moisture absorption and superior dielectric strength



Enclosure Door

- Removable door for ease of wiring and installation
- Enclosure door can be locked to prevent unauthorized access. Additionally, if the switch is ON, the door cannot be opened



Installation

- Three molded-in conduit drill points are located on the top, bottom and back surface of enclosure. Conduit hub provided: 30A 1 in. NPT, 60A 1¼ in. NPT
- Conduit hub and adjustable mounting feet (4) are ductile to allow mounting on irregular surfaces

IP66
SUITABILITY

Enclosure Type 4X, 12

Rating		Fused Circuit-Lock® Devices				
Amps	Poles and Wires	Configuration Recep./ Conn.	Plug/ Inlet	AC Voltage	Mechanical Interlock	Mating Plug
30	3P 4W			120/240V	HBL430MIF12W	HBL430P12W
	3P 4W			3Ø 240V	HBL430MIF9W	HBL430P9W
	3P 4W			3Ø 480V	HBL430MIF7W	HBL430P7W
	3P 4W			3Ø 600V	HBL430MIF5W	HBL430P5W
	4P 5W			3ØY 277/480V	HBL530MIF7W	HBL530P7W
60	3P 4W			120/240V	HBL460MIF12W	HBL460P12W
	3P 4W			3Ø 240V	HBL460MIF9W	HBL460P9W
	3P 4W			3Ø 480V	HBL460MIF7W	HBL460P7W
	3P 4W			3Ø 600V	HBL460MIF5W	HBL460P5W
	4P 5W			3ØY 120/208V	HBL560MIF9W	HBL560P9W

Note: 30A – 1 inch NPT hub supplied; 60A – 1¼ inch hub supplied.



HBL430MIF12W

Gray Style Switch



HBLACFSNO

HBL30MIFRS

Black Style Switch

Replacement Auxiliary Contacts

Description	Black Style Switch Catalog Number	Gray Style Switch Catalog Number
Auxiliary contact, normally open, A600 pilot duty, break before break.	ACFSNO	HBLACFSNO
Auxiliary contact, normally closed, A600 pilot duty, break before break.	ACFSNC	HBLACFSNC

Note: Auxiliary contacts are specific to the style switch noted and are NOT interchangeable. All new installations are shipped with gray style switch.



ACFSNO

Replacement Switches

Description	Gray Style Switch Catalog Number
For 30A fused switches.	HBL30MIFRS
For 60A fused switches. Gray Style switch will retro fit Black Style switch.	HBL60MIFRS



MICPK30

Watertight Closure Plug Kits

Description	Catalog Number
For 30A Circuit-Lock® unfused and fused Pin and Sleeve mechanical interlocks.	MICPK30
For 60 and 100A Circuit-Lock® unfused and fused Pin and Sleeve mechanical interlocks.	MICPK60



CA3430MI

Replacement Flip Covers

Description	Catalog Number
For 30A, 3 and 4 wire mechanical interlocks.	CA3430MI
For 30A, 5 wire mechanical interlocks.	CA530MI
For 60A mechanical interlocks.	CA60MI



HBLRFT2

Replacement Mounting Feet

Description	Catalog Number
Replacement mounting feet and screws for 30 and 60A fused mechanical interlocks.	HBLRFT2 ^Δ

Note: ^ΔPackage of 10 feet and 10 screws.

Pin and Sleeve Devices/Mechanical Interlocks

Specifications

Typical Specifications

Manufacturer's Identification	Hubbell HBL460MIF7W
Description	Fused Circuit-Lock Pin and Sleeve Mechanical Interlock
Electrical Type	3 Pole + Earth
Rating	60A, 480V AC, 3 Phase
Configuration	IEC 60309-2, UL1686C2, Clock Position 7
Enclosure Type	Indoor and Outdoor - 4X (Watertight, Washdown) Indoor - 12 (Dust-tight, Falling dirt)
Certification	UL Listed for US and Canada

Materials

Part	Material
Base and Top	PBT
Handle	PBT
Conduit Hub	Zinc, 30A-1", 60A-1¼" NPT
Enclosure Gasket	Neoprene
Shaft	Brass
Shaft Seal	Neoprene
Ground Plate	Galvanized Steel
Enclosure Screws	Stainless Steel
Mounting Inserts	Brass
Hinge Pin	Nickel-Plated Brass
Hinge Spring	Stainless Steel

Note: This device provides fused switched control of a plug connected load and includes an interlocking feature to prevent the plug from being disconnected or the fuse door opened while the receptacle is energized. The switch cannot be turned on until the plug is inserted properly.

Performance

Electrical

Dielectric Voltage	Withstands 3,000V AC Min.
Max. Working Voltage	600V AC.
Current Interrupting	Certified for current interrupting at full rated current and voltage.
Short Circuit Withstand Rating	Suitable for use on a circuit capable of delivering not more than 200,000 RMS symmetrical amperes at the voltage rating of receptacle.

Operations

Mechanical 10,000 cycles minimum.

Mechanical

Impact Resistance	In accordance with UL 746C.
Terminal Identification	In accordance with UL, CSA and international conventions.
Product Ratings	Ratings are part of the external label and molded into the receptacle mount and color-coded.
Mounting	External adjustment feet.

Environmental

Moisture Resistance	Indoor and Outdoor - 4X (Watertight, Washdown); Indoor - 12 (Dust-tight, Falling dirt).
Ingress Protection	IP66 Suitability.
Flammability	UL94-5VA and V-0 Classification.
Operating Temperatures	Max. Continuous +75°C; Min. Continuous -40°C.
UV Resistance	All materials are UV stabilized.
Fuse Types	UL Listed Class "J". CSA Certified HRCI-J.

Horsepower Ratings

Amps	AC Voltage Rating	Standard	Maximum**	Mechanical Interlock	Use Pin and Sleeve Plug
30	3Ø 600V AC	7.5	20	HBL430MIF5W	HBL430P5W
30	3Ø 480V AC	5	15	HBL430MIF7W	HBL430P7W
30	3Ø 240V	3	7.5	HBL430MIF9W	HBL430P9W
30	120/240V AC	1.5*	3*	HBL430MIF12W	HBL430P12W
30	3ØY 277/480V	5	15	HBL530MIF7W	HBL530P7W
60	3Ø 600V AC	15	50	HBL460MIF5W	HBL460P5W
60	3Ø 480V AC	15	30	HBL460MIF7W	HBL460P7W
60	3Ø 240V AC	7.5	15	HBL460MIF9W	HBL460P9W
60	120/240V AC	3*	10*	HBL460MIF12W	HBL460P12W
60	3ØY 120/208V	7.5	15	HBL560MIF9W	HBL560P9W

Note: *208-240V AC L-L.

**Requires time delay fuses.

Dimensions

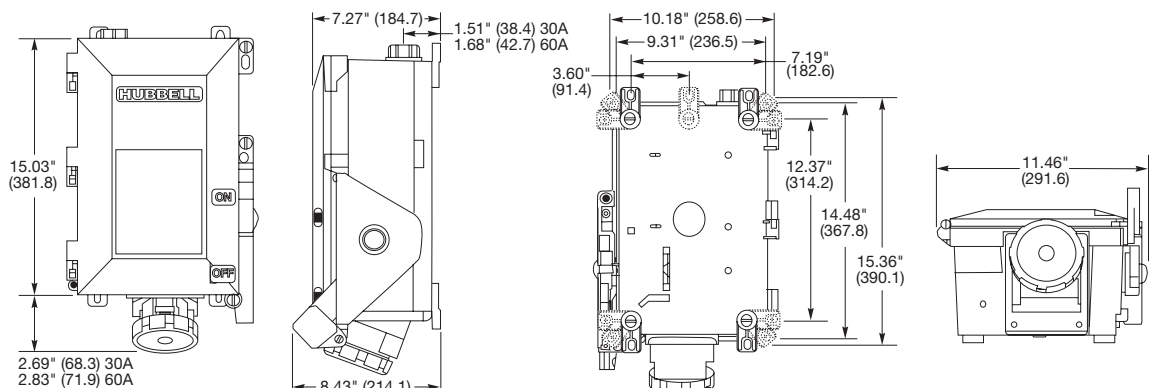

Dimensions in Inches (mm)



BB60N



BB301W



BB601WSS



CAP60



FW6010055



FT202W



FW60100



AA2030PS

Back Boxes

Hubbell manufactures an extensive line of back boxes for use with IEC Pin and Sleeve devices. Each back box is designed to give the user the maximum amount of wiring room while achieving grounding to metallic conduit. Hubbell back boxes are available in non-metallic and cast metal versions.

Non-Metallic 15° Angle Back Box

Description	NPT Hub Size*	Catalog Number
Back box for 16, 20, 30 and 32A devices.	1"	BB2030N
Back box for 60 and 63A devices.	1¼"	BB60N
Back box for 100 and 125A devices.	1½"	BB100N

Note: *Hub is not included; order one of the following Raco® part numbers: 1 in. = 1704, 1¼ in. = 1705, 1½ in. = 1706. These boxes meet IP69k requirement and Type 4X requirements when installed with a watertight conduit hub.

Metallic 15° Angle Back Box and Adapter**

Description	NPT Hub Size	Stainless Steel	Cast Iron
Back box for 16, 20, 30 and 32A devices.	¾"	BB201WSS	BB201W
	1"	BB301WSS	BB301W
Back box for 60 and 63A devices.	1¼"	BB601WSS	BB601W
	1½"	–	BB602W
Back box for 100 and 125A devices.	1½"	BB1001WSS	BB1001W
	2"	BB1002WSS	BB1002W
Angle adapter only for 60, 63, 100 and 125A devices.	–	–	AA6010015

Note: **These boxes are cast aluminum, suitable for IP54 requirements and are finished with enamel paint.

Adapter Plates

Required to mount Hubbell-PRO receptacles and inlets to Hubbell Back Boxes

Description	Catalog Number
For Use with 16A, 20A, 30A and 32A	CAP2030
For Use with 60A and 63A	CAP60
For Use with 100A and 125A	CAP100

Metallic 55° Angle Back Box and Adapter**

Description	NPT Hub Size	Catalog Number
Feed-thru box back box and adapter for 16, 20, 30 and 32A devices.	1"	AB203055
Angle adapter only.	–	AA203055
Back box and adapter for 60, 63, 100 and 125A devices.	1½"	FW6010055
Angle adapter only.	–	AA6010055

Note: **These boxes are cast aluminum, suitable for IP54 requirements and are finished with enamel paint.

Metallic Feed-Thru Back Box**

Description	NPT Hub Size	Catalog Number
Feed-thru box for 16, 20, 30 and 32A devices.	¾"	FT202W
	1"	FT302W

Note: **These boxes are cast aluminum, suitable for IP54 requirements and are finished with enamel paint.

Metallic Four-Way 15° Angle Back Box**

Description	NPT Hub Size	Catalog Number
Four-way box for 60, 63, 100 and 125A devices.	1½"	FW60100

Note: **These boxes are cast aluminum, suitable for IP54 requirements and are finished with enamel paint.

Straight Wall Box Adapter

Description	Catalog Number
Adapts 16, 20, 30 and 32A Watertight IEC Pin and Sleeve devices to 2-gang, device boxes and FD boxes.	HBL2030AP

Angle Wall Box Adapter

Description	Catalog Number
Adapts 16, 20, 30 and 32A Watertight IEC Pin and Sleeve devices to standard wall boxes.	AA2030PS

Note: Adapts 20 and 30A Watertight Pin and Sleeve receptacle to single, 2-gang standard wall box and 4 or 4¼ inch square for non-watertight applications.

Pin and Sleeve Devices/Mechanical Interlocks

Accessories

Closure Caps

Cap assemblies provide watertight sealing to a disconnected male IEC Pin and Sleeve plug or inlet. Manufactured of the same tough non-metallic material as the watertight IEC Pin and Sleeve devices for corrosion and abuse resistance.

Description	Catalog Number
Fits all 16 and 20A, 3 wire plugs and inlets.	PC320
Fits all 16 and 20A, 4 wire plugs and inlets.	PC420
Fits all 16 and 20A, 5 wire plugs and inlets.	PC520
Fits all 30 and 32A, 3 and 4 wire plugs and inlets.	PC3430
Fits all 30 and 32A, 5 wire plugs and inlets.	PC530
Fits all 60 and 63A plugs and inlets.	PC60
Fits all 100 and 125A plugs and inlets.	PC100



PC3430

Cover Assemblies

Replacement cover assemblies for use with watertight connector bodies and receptacles. Exact replacement cover assemblies required to maintain proper water ingress. They are not reverse compatible. Replacement covers are not interchangeable. Kit contains cover, arm assembly and installation tool.

Description	IP67 Catalog Number	IP69k/4X Catalog Number
Fits all 16 and 20A, 3 wire watertight female devices.	CA320	HBLCA320
Fits all 16 and 20A, 4 wire watertight female devices.	CA420	HBLCA420
Fits all 16 and 20A, 5 wire watertight female devices.	CA520	HBLCA520
Fits all 30 and 32A, 3 and 4 wire watertight female devices.	CA3430	HBLCA3430
Fits all 30 and 32A, 5 wire watertight female devices.	CA530	HBLCA530
Fits all 60 and 63A watertight female devices.	CA60	HBLCA60
Fits all 100 and 125A watertight female devices.	CA100	HBLCA100



CA60



HBLCA60

Cord Clamp and Locking Ring

Replacement cord clamp and locking ring for use with IEC plugs, connectors and inlets.

Description	Cord Clamp and Locking Ring	Locking Ring Only
Fits all 16 and 20A, 3 wire plugs, connectors and inlets.	CC320	LR320*
Fits all 16 and 20A, 4 wire plugs, connectors and inlets.	CC420	LR420*
Fits all 16 and 20A, 5 wire plugs, connectors and inlets.	CC520†	LR520*
Fits all 30 and 32A, 3 and 4 wire plugs, connectors and inlets.	CC3430	LR3430*
Fits all 30 and 32A, 5 wire plugs, connectors and inlets.	CC530†	LR530*
Fits all 60 and 63A plugs, connectors and inlets.	CC60	LR60*
Fits all 100 and 125A plugs, connectors and inlets.	CC100	LR100*

Note: *Locking Ring only for plugs and inlets.

†Consult factory.



CC3430



LR3430



SAB34

Liquidtight Adapters

Machined aluminum or non-metallic adapters are available to provide a means for attaching flexible liquidtight metal conduit to rear of a Hubbell Pin and Sleeve plug or connector. To install, remove cord grip and two gland cap screws. Use screws to attach adapter. Kellems® liquidtight conduit connectors are available to control arc of bend and to prevent conduit pull-out where vibration, motion or strain is present. These grips interface directly with Hubbell's liquidtight adapters and are available in a wide variety of NPT sizes and configurations. Consult your local code grounding requirements before using liquidtight adapters.

Rating of Hubbell Pin and Sleeve Device	Liquidtight Conduit Size	Liquidtight Adapters		Optional Kellems Liquidtight Conduit Grip
		Aluminum	Non-Metallic	
16 and 20 Amp 3 and 4 Wire	½" NPT	SAA12	—	074093402
	¾" NPT	SAA34	—	074093403
16 and 20 Amp 5 wire and 30 and 32 Amp 3 and 4 wire	½" NPT	SAB12	—	074093402
	¾" NPT	SAB34	—	074093403
	1" NPT	SAB100	—	074093404
30 and 32 Amp 5 wire and 60 and 63 Amp (all)	½" NPT	SAC12	SAC12NM	074093402
	¾" NPT	SAC34	SAC34NM	074093403
	1" NPT	SAC100	SAC100NM	074093404
	1¼" NPT	SAC125	—	074093405
100 and 125 Amp (all)	1¼" NPT	SAD125	—	074093405
	1½" NPT	SAD150	—	074093406



074093403

Features and Benefits

20 and 30 Amps Low Profile

Hubbell's Low Profile Pin and Sleeve devices were designed to save space without sacrificing pin and sleeve strength, safety and convenience. The small compact design of these plugs is ideal for indoor applications where space is at a premium.

These devices are fully interchangeable with standard IEC 60309 pin and sleeve. They are a perfect fit for tight situations frequently found in hotels, restaurants, convention centers, warehouses, assembly benches and offices.



Housing Design

- Nylon construction, both interior and exterior are made of tough, durable nylon
- Shrouded, recessed pins are protected from impact and abuse



Cord Grip

- Integrated cord grip limits strain on terminals, keeps cord connected



Safety

- Large markings for easy recognition results in ease of wiring on the assembly line or in the field
- Shroud protects personnel from exposure to arcing

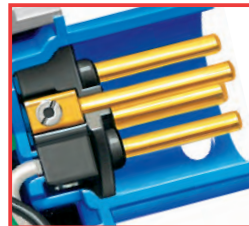

Brass Box Terminal

- Permits high clamping pressure on conductors without damaging wire strands for best electrical conductivity
- Solid one-piece pins construction, for long life, reliable electrical contact and maximum conductivity



Identification

- Color coding for quick, easy visual identification of mating devices
- Ratings and certification are molded into the nylon housing for easy identification and reordering



Split Sleeves

- Self-adjusting stainless steel springs assure constant contact pressure (20A and 30A). On 60A devices, Beryllium copper insert with multiple contact points assures easy insertion and a tight fit
- Stainless steel terminal screws resist rust and corrosion

Low Profile Devices

Rating					Devices		Cord Diameter	
Amps	Poles and Wires	Configuration Recep./ Plug/ Conn. Inlet	AC Voltage	Plug	Receptacle	Min. Inches	Max. Inches (mm)	
20	3P 4W		3Ø 250V			.350"	.710" (8.3 - 15.9)	
30	3P 4W		125/250V			.390"	.775" (9.9 - 19.7)	
30	3P 4W		3Ø 250V			.390"	.775" (9.9 - 19.7)	
60	3P 4W		3Ø 250V			.75"	1.25" (19.1 - 31.8)	
				With Cover:				
60	4P 5W		3ØY 120/208V			.89"	1.42" (22.6 - 36.1)	
100	4P 5W		3ØY 120/208V			1.34"	1.50" (34.0 - 38.1)	

Specifications

Electrical	
Dielectric Withstand Voltage	3000V AC
Max. Working Voltage	250V RMS
Current Interrupting	Certified for current interruption at full rated current.
Temperature Rise	Max. 30°C temperature rise at full rated current after 50 cycles of overload at 150% of rated current at a power factor of 75%.
Endurance	Up to 5,000 connect and disconnect cycles at full rated current and voltage.
Mechanical	
Impact Resistance	Per CSA C22.2 No. 182.1 / UL1682
Cord Grip Cable Retention	Per CSA C22.2 No. 182.1 / UL1682
Cord Accommodation	Round portable service cords of diameters commensurate with the device rating as defined in UL standard 62, CSA C22.2 No. 49 and the <HAR> European Standards.
Terminal Identification	Terminals identified in accordance with North American convention.
Product Identification	Ratings are a permanent part of the device housing.
Environmental	
Flammability	HB or better per UL94 or CSA C22.2 No. 0.17
Ingress Protection	IP22 Suitability
Operating Temperatures	Maximum Continuous 75° C; Minimum -40°C without impact

Application Guide

Agriculture	Indoor location and maintenance.
Chemical Processing	Indoor location and maintenance.
Construction	Indoors for added safety and abuse resistance.
Entertainment	Indoor location and maintenance.
Food Service	Food service areas where aesthetics and space are concerns.
Light Manufacturing	Indoor locations and maintenance.
Manufacturing	Light assembly areas, stamping operations and maintenance areas.
Military	Warehouse and maintenance areas.

Materials

Plug	Material
Case	PBT
Shroud	PBT
Pin Carrier 20 & 30A	PBT
Pin and Carrier 60A	High-Impact Thermoset
Pins	Brass CDA#360
Assembly Screws	Stainless Steel (300 series)
Terminal Screws	Stainless Steel (300 series)
Receptacle	
Body	PBT
Sleeve Carrier 20 & 30A	PBT
Sleeve Carrier 60A	High-Impact Thermoset
Sleeves	Brass CDA #360
Assembly Screws	Stainless Steel (300 series)
Terminal Screws	Stainless Steel (300 series)
Adapter Plate 20 & 30A	Galvanized Steel
Adapter Plate 60A	Aluminum
Wall Trim Plate	PBT
Panel Mount Trim Plate	Stainless Steel (300 series)

Note: See page G-29 for product dimensions.

Pin and Sleeve Devices/Mechanical Interlocks

Plug Dimensions

Type	A	B	C	D	Cord Range Diameter
L430P12	2.97" (75.4)	4.18" (106.2)	3.50" (88.9)	1.71" (43.4)	.390"-.775" (9.9-19.7)
A460P9	3.38" (85.9)	4.25" (108.0)	7.00" (177.8)	–	.75"-1.25" (19.1- 31.8)
A5100P9	4.92" (125.00)	5.07" (128.81)	8.60" (218.35)	–	1.34"-1.50" (34.0- 38.1)

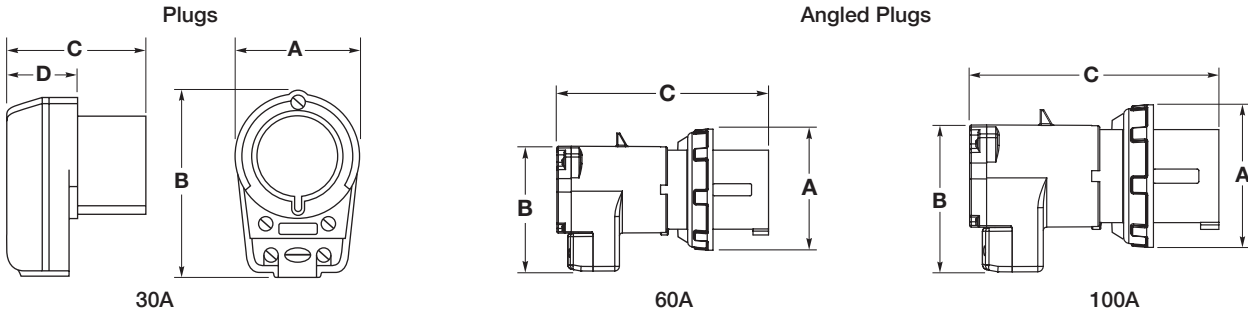

Wall Mount Receptacle Dimensions

Type	A	B	C	D	E	F
L420R9	2.60" (66.0)	2.81" (71.4)	2.28" (57.9)	2.38" (60.5)	–	–
L430R12	3.12" (79.2)	3.12" (79.2)	2.77" (70.4)	2.76" (70.1)	–	–
A460R9	4.50" (114.3)	4.50" (114.3)	4.48" (113.8)	–	3.62" (91.9)	.50" (12.7)

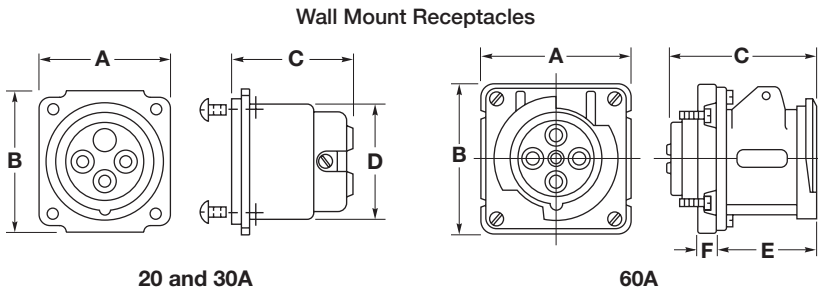

Adapter Plate (Included with "L" and "A" series receptacles)

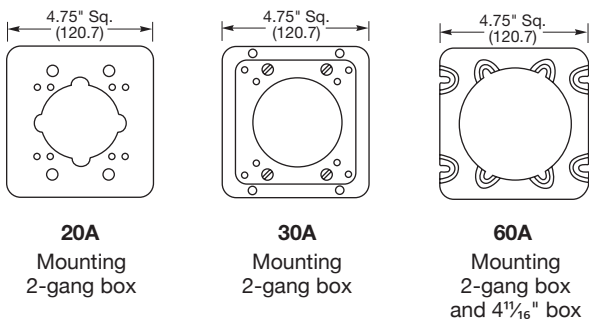

Panel Cutout

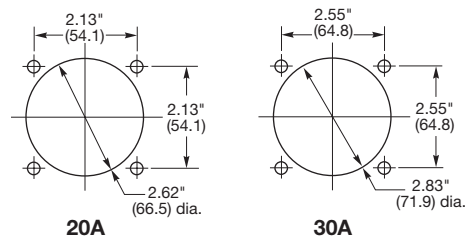

Dimensions in Inches (mm)

Pin and Sleeve Devices/Mechanical Interlocks

IEC Pin and Sleeve Terminal Identification – Rear View

Description	Rating		Terminal Marking Pattern*			
	Domestic	International	Receptacle and Connector		Plug and Inlet	
			Domestic	International	Domestic	International
3 Wire	125V AC 277V AC	100-130V				
3 Wire	250V AC 480V AC 600V AC	200-250V 380-415V AC				
4 Wire	125/250V AC 1ØY 120/208V	—				
4 Wire	(3Ø Δ) 250V AC 480V AC 600V AC	380-415V AC				
5 Wire	(3ØY) 120/208V AC 277/480V AC 347/600V AC	220/380V 50Hz 250/440V 60Hz 200/346V to 240/415V 50 and 60Hz				

Note: *Location of grounding contact position will change as clock positions assigned to specific voltages change.
 ★Pilot contacts supplied on 4 and 5 wire, 63 and 125 Amp international rated devices.

Pin and Sleeve Devices/Mechanical Interlocks

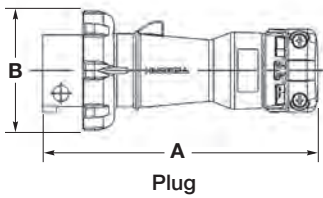

Plug

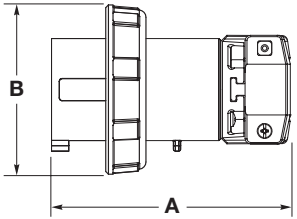

Short Housing Plug

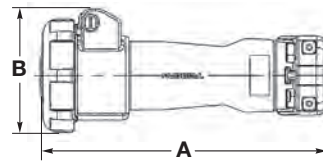

Connector Body

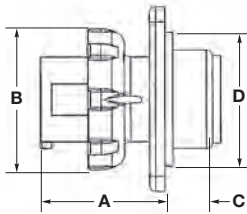

Inlet

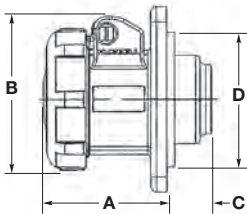

Receptacle

Dimensions in Inches (mm)

Plug Dimensions

Type	A	B	Cord Grip Range
HBL320P	6.61" (167.8)	2.87" (73.0)	.330"-.830" (8.4-21.1)
HBL420P	7.00" (177.8)	3.19" (81.0)	.330"-.830" (8.4-21.1)
HBL520P	7.65" (194.3)	3.50" (89.0)	.330"-.830" (8.4-21.1)
HBL330P	8.05" (204.5)	3.74" (95.0)	.375"-1.250" (9.5-31.8)
HBL430P	8.05" (204.5)	3.74" (95.0)	.375"-1.250" (9.5-31.8)
HBL530P	8.54" (216.9)	4.02" (102.0)	.500"-1.450" (12.7-36.8)
HBL360P, HBL460P, HBL560P	10.15" (257.8)	4.49" (114.0)	.500"-1.450" (12.7-36.8)
HBL3100P, HBL4100P, M4100P, HBL5100P, M5100P	12.63" (320.8)	4.92" (125.0)	1.065"-1.940" (27.1-49.3)

Short Housing Plug Dimensions

Type	A	B	Cord Grip Range
HBL5100P9WSH	8.30" (210.82)	4.92" (125.0)	1.065"-1.940" (27.1-49.3)

Connector Body Dimensions

Type	A	B	Cord Grip Range
HBL320C	7.21" (183.1)	3.10" (78.9)	.330"-.830" (8.4-21.1)
HBL420C	7.57" (192.3)	3.43" (87.2)	.330"-.830" (8.4-21.1)
HBL520C	8.24" (209.2)	3.71" (94.3)	.330"-.830" (8.4-21.1)
HBL330C	8.24" (209.2)	3.71" (94.3)	.375"-1.250" (9.5-31.8)
HBL430C	8.69" (220.6)	3.74" (95.0)	.375"-1.250" (9.5-31.8)
HBL530C	9.33" (237.0)	4.02" (102.1)	.500"-1.450" (12.7-36.8)
HBL360C, HBL460C, HBL560C	10.75" (272.9)	4.39" (111.5)	.500"-1.450" (12.7-36.8)
HBL3100C, HBL4100C, M4100C, HBL5100C, M5100C	13.14" (333.8)	5.06" (128.5)	1.065"-1.940" (27.1-49.3)

Inlet Dimensions

Type	A	B	C	D	E	F
HBL320B	2.54" (64.5)	1.85" (47.0)	1.14" (29.0)	2.72" (69.0)	3.75" (95.3)	3.13" (79.5)
HBL420B	2.54" (64.5)	2.11" (53.6)	1.14" (29.0)	2.72" (69.0)	3.75" (95.3)	3.13" (79.5)
HBL520B	2.54" (64.5)	2.41" (61.2)	1.14" (29.0)	2.72" (69.0)	3.75" (95.3)	3.13" (79.5)
HBL330B	2.99" (76.0)	2.49" (63.2)	1.04" (26.5)	2.72" (69.0)	3.75" (95.3)	3.13" (79.5)
HBL430B	2.99" (76.0)	2.49" (63.2)	1.04" (26.5)	2.72" (69.0)	3.75" (95.3)	3.13" (79.5)
HBL530B	2.99" (76.0)	2.75" (69.9)	1.04" (26.5)	2.80" (71.0)	3.75" (95.3)	3.13" (79.5)
HBL360B, HBL460B, HBL560B	4.04" (102.6)	2.97" (75.5)	1.18" (30.0)	3.46" (88.0)	4.50" (114.3)	3.88" (98.5)
HBL3100B, HBL4100B, M4100B, HBL5100B, M5100B	4.53" (115)	3.44" (87.5)	1.95" (49.5)	3.94" (100.0)	5.50" (139.7)	4.88" (124.0)

Receptacle Dimensions

Type	A	B	C	D	E	F
HBL320R	2.47" (62.8)	3.10" (78.9)	.91" (23.0)	2.71" (68.9)	3.75" (95.3)	3.13" (79.4)
HBL420R	2.46" (62.4)	3.43" (87.2)	.91" (23.0)	2.71" (68.9)	3.75" (95.3)	3.13" (79.4)
HBL520R	2.50" (63.4)	3.71" (94.3)	.90" (22.9)	2.71" (68.9)	3.75" (95.3)	3.12" (79.3)
HBL330R	2.74" (69.7)	3.74" (95.0)	1.04" (26.5)	2.71" (68.9)	3.75" (95.3) SQ	4X 3.13" (79.4) SQ
HBL430R	2.74" (69.7)	3.74" (95.0)	1.04" (26.5)	2.71" (68.9)	3.75" (95.3) SQ	4X 3.13" (79.4) SQ
HBL530R	2.75" (69.7)	4.02" (102.1)	1.04" (26.5)	2.83" (71.9)	3.75" (95.3) SQ	3.13" (79.4) SQ
HBL360R, HBL460R, HBL560R	3.67" (93.2)	4.39" (111.5)	1.57" (40.0)	3.45" (87.7)	4.50" (114.3) SQ	3.88" (98.4) SQ
HBL3100R, HBL4100R, M4100R, HBL5100R, M5100R	3.78" (96.1)	5.07" (128.7)	2.30" (58.5)	3.93" (99.8)	4.87" (123.7) SQ	5.50" (139.7) SQ

Note: 20, 30, 60 and 100A devices are dimensionally equivalent to 16, 32, 63 and 125A devices, respectively.

Pin and Sleeve Devices/Mechanical Interlocks

Non-Metallic 15° Angle Back Box

Description	NPT Hub Size	A Inch (mm)	B Inch (mm)	C Inch (mm)	D Inch (mm)	E Inch (mm)	F Inch (mm)	Cubic Inch Capacity	Catalog Number
Back box for 16, 20, 30 & 32A devices.	1"	5.67" (144.0)	4.44" (112.8)	4.05" (102.9)	3.91" (99.3)	2.35" (59.7)	4.92" (125.0)	30.00"	BB2030N
Back box for 60 & 63A devices.	1¼"	7.76" (197.0)	5.16" (131.0)	5.87" (149.0)	4.72" (120.0)	2.99" (76.0)	6.94" (176.0)	70.00"	BB60N
Back box for 100 & 125A devices.	1½"	8.21" (209.0)	6.23" (158.0)	6.31" (160.3)	5.71" (145.0)	3.99" (101.0)	7.41" (188.0)	120.00"	BB100N

Note: *Hub is not included; order one of the following *Raco*® part numbers: 1 inch = 1704, 1¼ inch = 1705, 1½ inch = 1706. These boxes meet IP67 requirement and Type 4X requirements when installed with a watertight conduit hub.

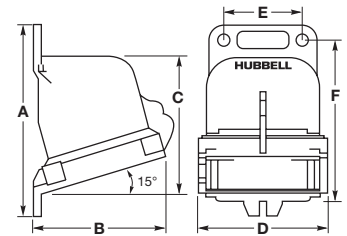

Non-Metallic Angle Box

Metallic 15° Angle Back Box

Description	NPT Hub Size	A Inch (mm)	B Inch (mm)	C Inch (mm)	D Inch (mm)	E Inch (mm)	F Inch (mm)	Cubic Inch Capacity	Catalog Number
Back box for 16, 20, 30 & 32A devices.	¾"	5.12" (130.2)	4.00" (101.6)	4.19" (106.4)	3.75" (95.3)	3.00" (76.2)	4.00" (101.6)	30.00"	BB201W
Back box for 16, 20, 30 & 32A devices.	1"	5.12" (130.2)	4.00" (101.6)	4.19" (106.4)	3.75" (95.3)	3.00" (76.2)	4.00" (101.6)	30.00"	BB301W
Back box for 60 & 63A devices.	1¼"	7.25" (184.2)	5.25" (133.4)	6.00" (152.4)	4.50" (114.3)	3.75" (95.3)	6.19" (157.2)	80.00"	BB601W
Back box for 60 & 63A devices.	1½"	7.25" (184.2)	5.25" (133.4)	6.00" (152.4)	4.50" (114.3)	3.75" (95.3)	6.19" (157.2)	80.00"	BB602W
Back box for 100 & 125A devices.	1½"	8.12" (206.4)	6.75" (171.5)	6.88" (174.6)	5.50" (139.7)	4.75" (120.7)	6.94" (176.2)	130.00"	BB1001W
Back box for 100 & 125A devices.	2"	8.12" (206.4)	6.75" (171.5)	6.88" (174.6)	5.50" (139.7)	4.75" (120.7)	6.94" (176.2)	130.00"	BB1002W

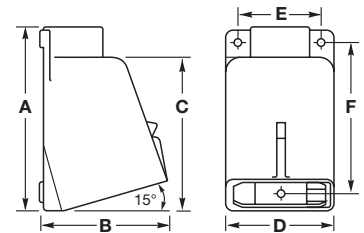

Metallic 15° Angle Box

Metallic 55° Angle Back Box and Adapter

Description	NPT Hub Size	A Inch (mm)	B Inch (mm)	C Inch (mm)	D Inch (mm)	E Inch (mm)	F Inch (mm)	Cubic Inch Capacity	Catalog Number
Feed-thru box and angle adapter for 16, 20, 30 & 32A devices.	1"	6.80" (172.4)	6.60" (167.0)	5.63" (142.9)	4.50" (114.3)	3.74" (95.0)	–	42.27"	AB203055
Angle adapter for 16, 20, 30 & 32A devices.	–	4.89" (124.3)	3.33" (84.6)	4.29" (109.0)	3.75" (95.2)	2.50" (63.5)	–	25.00"	AA203055
Back box and angle adapter for 60, 63, 100 & 125A devices.	1½"	8.50" (215.9)	8.00" (202.9)	7.75" (196.8)	6.90" (174.8)	6.00" (152.4)	–	100.00"	FW6010055
Angle adapter for 60, 63, 100 & 125A devices.	–	6.75" (171.4)	4.48" (113.7)	6.00" (152.4)	6.75" (171.4)	6.00" (152.4)	–	79.00"	AA6010055

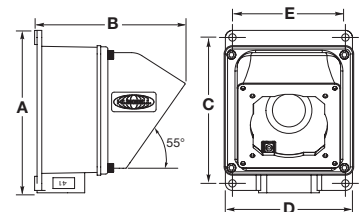

Metallic 55° Angle Box

Metallic Feed-Thru Back Box

Description	NPT Hub Size	A Inch (mm)	B Inch (mm)	C Inch (mm)	D Inch (mm)	E Inch (mm)	F Inch (mm)	Cubic Inch Capacity	Catalog Number
Feed-thru box for 16, 20, 30 & 32A devices.	¾"	8.25" (209.6)	3.06" (77.8)	7.14" (181.4)	4.50" (114.3)	3.75" (95.3)	3.13" (79.5)	48.00"	FT202W
Feed-thru box for 16, 20, 30 & 32A devices.	1"	8.25" (209.6)	3.06" (77.8)	7.14" (181.4)	4.50" (114.3)	3.75" (95.3)	3.13" (79.5)	48.00"	FT302W

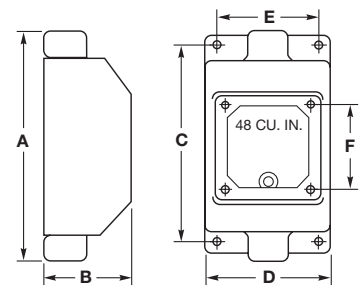

Metallic Feed-Thru Box

Metallic Four-Way 15° Angle Back Box

Description	NPT Hub Size	A Inch (mm)	B Inch (mm)	C Inch (mm)	D Inch (mm)	E Inch (mm)	F Inch (mm)	Cubic Inch Capacity	Catalog Number
Four-way box for 60, 63, 100 & 125A devices.	1½"	8.75" (222.3)	9.75" (247.7)	7.75" (196.9)	6.75" (171.5)	6.00" (152.4)	–	210.00"	FW60100

Note: These boxes are cast aluminum, suitable for IP54 requirements and are finished with enamel paint. These boxes withstand a 500-hour salt spray test as well as UL rain tight and external icing test.

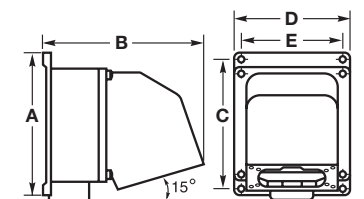

Metallic Four-Way Angle Box

Dimensions in Inches (mm)

Pin and Sleeve Devices/Mechanical Interlocks

Watertight Series

Product Dimensions Inches (mm)

Plug	A	B	C	D	E
	Inches (mm)	Inches (mm)	Inches (mm)	Inches (mm)	Inches (mm)
C320P	2.78" (70)	3.62" (94)	5.98" (152)	1.73" (44)	5.20" (132)
C420P	2.78" (70)	3.7" (94)	6.3" (160)	1.73" (44)	5.39" (137)
C520P	3.41" (86)	3.61" (92)	6.34" (161)	1.85" (47)	5.55" (141)
C330P, C430P	3.7" (94)	4.49" (114)	8.03" (204)	2.32" (59)	6.81" (173)
C530P	4.0" (101)	4.49" (114)	8.11" (206)	2.32" (59)	6.73" (171)
C360P, C460P, C560P	4.47" (114)	6.0" (153)	10.24" (260)	2.83" (72)	8.19" (208)
C3100P, C4100P, C5100P	4.94" (126)	6.73" (171)	12.13" (308)	3.58" (91)	9.88" (251)
C316P	2.78" (70)	3.62" (94)	5.21" (132)	1.73" (44)	4.53" (115)
C416P	2.78" (70)	3.62" (94)	5.21" (132)	1.85" (47)	4.3" (109)
C516P	3.41" (86)	3.62" (94)	5.43" (138)	1.73" (44)	4.26" (108)
C332P, C432P	3.7" (94)	4.49" (114)	6.54" (166)	2.32" (59)	5.44" (138)
C532P	4.0" (101)	4.49" (114)	6.54" (166)	2.32" (59)	5.16" (131)
C363P, C463P, C563P	4.47" (114)	6.0" (153)	8.44" (214)	2.83" (72)	6.39" (162)
C3125P, C4125P, C5125P	4.94" (126)	6.73" (171)	9.77" (248)	3.58" (91)	7.52" (191)

Connector

C320C	2.78" (70)	4.29" (109)	6.77" (172)	1.73" (44)	
C420C	3.09" (78)	4.29" (109)	6.89" (175)	1.85" (47)	
C520C	3.41" (86)	4.41" (112)	7.2" (183)	1.73" (44)	
C330C, C430C	3.7" (94)	5.35" (136)	8.78" (223)	2.32" (59)	
C530C	4.0" (101)	5.35" (136)	8.98" (228)	2.32" (59)	
C360P, C460P, C560P	4.37" (111)	6.85" (174)	11.06" (285)	2.83" (72)	
C3100C, C4100C, C5100C	4.92" (125)	7.44" (189)	12.83" (326)	3.58" (91)	
C316C	2.78" (70)	4.29" (109)	5.88" (149)	1.73" (44)	
C416C	3.7" (94)	4.29" (109)	5.88" (149)	1.85" (47)	
C516C	4.0" (101)	4.41" (112)	6.22" (157)	1.73" (44)	
C332C, C432C	4.37" (111)	5.35" (136)	7.44" (187)	2.32" (59)	
C532C	4.37" (111)	5.35" (136)	7.4" (187)	2.32" (59)	
C363C, C463C, C563C	4.37" (111)	6.85" (174)	9.29" (235)	2.83" (72)	
C3125C, C4125C, C5125C	4.92" (125)	7.44" (189)	10.48" (266)	3.58" (91)	

Receptacle

C316R, C320R	2.78" (70)	2.83" (72)	2.95" (75)	2.17" (55)	0.22" (5)
C416R, C420R	3.09" (78)	3.23" (82)	2.95" (75)	2.24" (57)	0.22" (5)
C516R, C520R	3.39" (86)	2.83" (72)	2.95" (75)	2.17" (55)	0.22" (5)
C330R, C430R, C332R, C432R	3.7" (94)	4.25" (108)	2.95" (75)	2.68" (68)	0.22" (5)
C530R, C532R	3.98" (101)	4.33" (110)	2.95" (75)	2.52" (64)	0.22" (5)
All 60A & 63A	4.37" (111)	5.2" (132)	3.94" (100)	2.95" (75)	0.26" (6)
All 100 & 125A	4.92" (125)	6.42" (163)	4.72" (120)	4.53" (115)	0.28" (7)

Inlet

C316B, C320B	3.35" (85)	0.25" (6)	4.06" (103)	3.31" (84)	3.5" (89)
C416B, C420B	3.35" (85)	0.25" (6)	4.29" (109)	3.46" (88)	3.7" (94)
C516B, C520B	3.35" (85)	0.25" (6)	4.53" (115)	3.66" (93)	3.9" (99)
C330B, C430B, C332B, C432B	3.35" (85)	0.25" (6)	4.72" (120)	3.78" (96)	4.06" (103)
C530B, C532B	3.35" (85)	0.25" (6)	5.28" (134)	4.17" (106)	4.45" (113)
All 60A & 63A	3.94" (100)	0.26" (7)	6.1" (155)	4.65" (118)	4.92" (125)
All 100 & 125A	4.72" (120)	0.26" (7)	5.91" (150)	5.12" (130)	5.35" (136)

Angled Receptacle

C316AR, C320AR	2.44" (62)	0.22" (5)	3.23" (82)	2.09" (53)	3.19" (81)
C416AR, C420AR	3.62" (92)	0.22" (5)	3.27" (83)	2.2" (56)	3.43" (87)
C516AR, C520AR	3.35" (85)	0.22" (5)	3.46" (88)	2.32" (59)	3.82" (97)
C330AR, C332AR, C430AR, C432AR	3.35" (85)	0.22" (5)	4.76" (121)	2.72" (69)	4.02" (102)
C530AR, C532AR	3.35" (85)	0.22" (5)	4.61" (117)	2.72" (69)	4.37" (111)
All 60AR	4.49" (114)	0.26" (6)	5.67" (144)	3.15" (80)	4.69" (119)
All 100AR	4.49" (114)	0.26" (6)	6.81" (173)	3.5" (89)	5.28" (134)

IP67 SUITABILITY

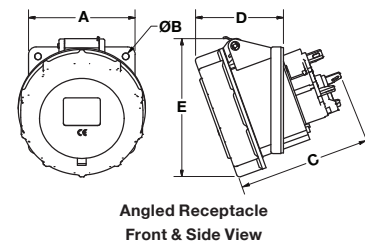
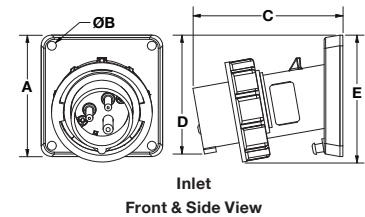
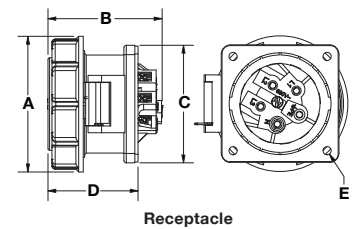
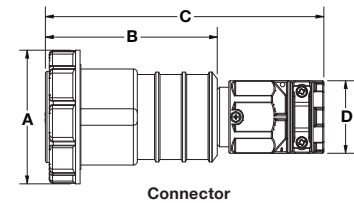
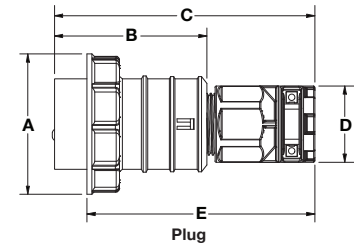

Pin and Sleeve Devices/Mechanical Interlocks

Ground Path

To reduce the likelihood of electrical shock, the National Electrical Code requires that non-current carrying metallic components be grounded. Insulgrip Pin and Sleeve wiring devices offer two styles of grounding.

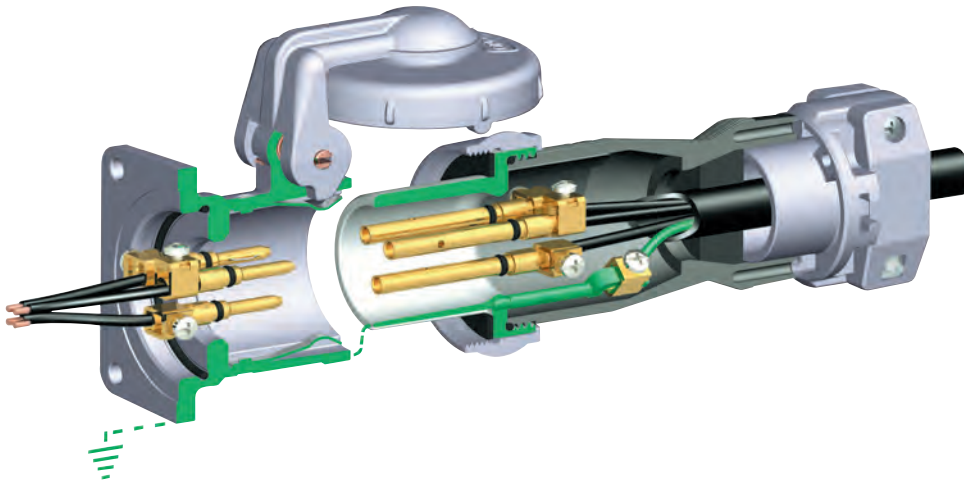

Style I

Receptacles achieve grounding by attaching the ground conductor to the ground screw inside the back box and utilizing the metallic receptacle shell as a ground source (see 3P 4W Style I illustration). Plugs and connectors establish grounding by means of connecting the flexible cable ground conductor to a ground terminal within each device, which, in turn, is grounded through the metallic plug or connector shroud. Any exposed metallic components are suitably grounded in the Style I offering.

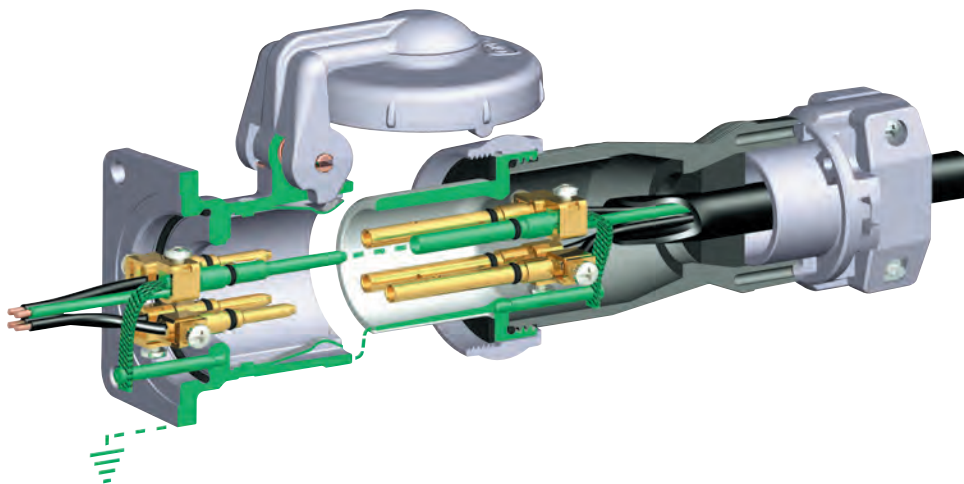

Style II

The Style II ground path offers two means of achieving the proper ground path. In addition to utilizing the same grounding method as in the Style I product, the Style II version incorporates a separate ground pin and sleeve (see 3P 4W Style II illustration). This provides a second ground path. The ground pin on Style II devices is longer than other pins, meaning that they “make first” and “break last,” assuring protection for people and equipment.

New Pole and Wire Terminology

Style I			Style II		
New	Old	No. of Contacts	New	Old	No. of Contacts
2P 3W	2W 2P	2	2P 3W	2W 3P	3
3P 4W	3W 3P	3	3P 4W	3W 4P	4
4P 5W	4W 4P	4			

Features and Benefits

UL 1686 C1 Insulgrip® Pin and Sleeve Devices

UL standard 1686-C1 configurations are uniform throughout the industry. That means Hubbell—the name that sets the standard for pin and sleeve performance, reliability, durability, innovation and ease of use should be your standard.

Hubbell's line of heavy duty Insulgrip® Pin and Sleeve wiring devices not only offers complete interchangeability, it delivers the goods when it comes to superior design and construction. Hubbell Insulgrip Pin and Sleeve devices are engineered and built to handle today's most demanding work environments, making Hubbell the unsurpassed heavyweight in the heavy duty market.

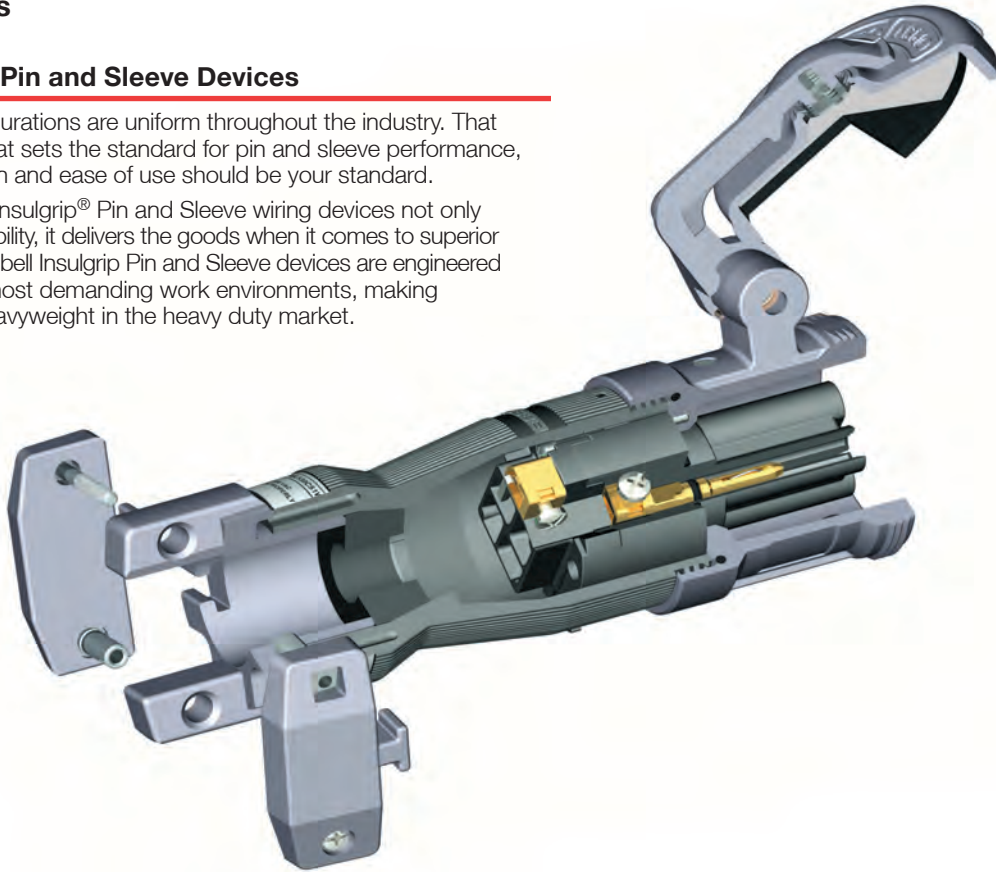

Housing Design

- Thermoplastic housing provides excellent insulating, impact, corrosion, and UV resistant properties. Protects users and internal components in the roughest of environments
- Spring-loaded, gasketed cover provides a UL Type 4X watertight, dust-tight seal on connectors and receptacles

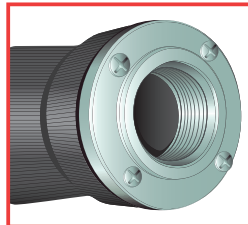

Liquidtight Conduit Adapters

- Machined aluminum adapters are available to provide a means for attaching flexible liquidtight metal conduit to rear of Hubbell Pin and Sleeve plug or connector



Powerful Mechanical Cord Grip

- Hubbell's design incorporates two molded-in teeth to securely grip the outer cable jacket, and internal conductors to prevent slippage and strain on terminations
- Captive barrel nuts ease assembly and allow higher tightening torque for maximum cord retention



Terminal Entrance Holes

- Large, square funneled entrance holes isolate each conductor to protect against shorts due to stray conductor strands
- Tapered hole provides a fast and easy guide into the termination chamber
- Pin chamber confines arcing within the interior chamber during make and break cycle of mating devices, minimizes arc tracking

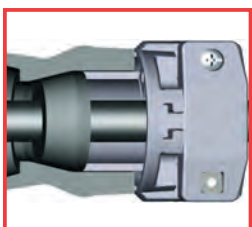

Watertight Cord Entrance

- The tapered bore entrance creates high compression forces on sealing gland, providing a watertight seal around cord
- Individual solid neoprene glands are supplied to match a full range of cord sizes and assure watertight performance



Anti-Vibration Box Terminals

- Interlocking box terminals ensure that terminal screws remain secure and cannot loosen
- The floating box is designed to obtain high-torque values without damaging stranded conductors

Features and Benefits

UL 1686 C1 Insulgrip® Pin and Sleeve Devices

Metallic where you want it, non-metallic where you need it. Different from traditional all-metallic devices, Hubbell Pin and Sleeve wiring devices are designed to provide metallic shrouding where you want it and a non-metallic housing where you need it.

What's more, Hubbell's watertight Insulgrip Pin and Sleeve wiring devices are designed with safety first and foremost. We created the line with plant facility maintenance personnel and a safer industrial work environment in mind. To greatly reduce the likelihood of electrical shock, we developed our exclusive nonmetallic watertight system, meaning that with Hubbell on the job, the mix of electricity and water isn't the threat it once was. So, whether the job calls for a welding outlet in a dry location or a motor disconnect in a wet location, step up to Hubbell Pin and Sleeve wiring devices.

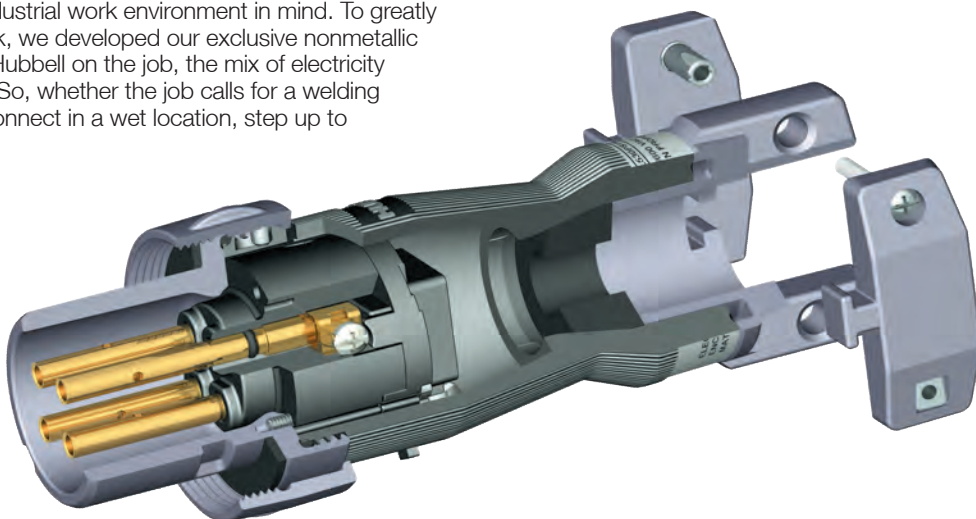

Housing Design

- Thermoplastic housing provides excellent insulating, impact, corrosion, and UV resistant properties. Protects users and internal components in the roughest of environments
- Locking ring provides a UL Type 4X watertight and dust-tight seal when the male and female devices are connected

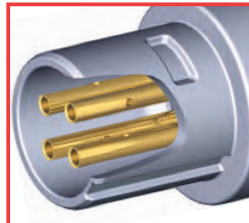

Shrouded Sleeves

- Housing seal provides a watertight and dust-tight seal when mated with receptacle or connector
- Protects the user from the possibility of touching live contacts during insertion and withdrawal of mating parts
- Shroud protects contact sleeves from deforming from physical abuse

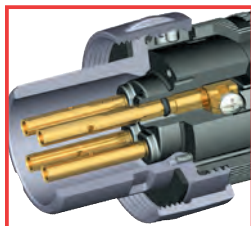

Interior Design

- Sleeve O-ring seal provides a watertight and dust-tight seal around the sleeves. Assures that contamination will not enter wire chamber
- All-brass sleeve contacts provide reliable electrical contact with mating pins, also with minimum heat build-up over time



Thermoset Polyester Contact Carrier

- Molded thermoset polyester provides high resistance to electrical tracking
- Withstands higher temperatures which may result from overload or arcing
- Thermoset properties provide dimensional stability for this critical assembly



Product Marking

- Catalog number and rating visible while in use. Markings are color coded differentiating Style I and Style II devices



Beryllium Copper Spring-Pin Design (Patented)

- Maintains high unit pressure on mating sleeves. Ensures reliable electrical contact while minimizing heat rise due to normal pin wear over time









Pin and Sleeve Devices/Mechanical Interlocks









30, 60, 100 and 200 Amp, 600/250 Volt AC/DC, 50-400 Hertz

TYPE 4X**

Rating				Style I Devices			Replacement Interiors	
Amps	Poles and Wires	Receptacle/Connector Configuration*	Maximum Voltage AC/DC	 Receptacle	 Plug	 Connector	 Connector & Receptacle	 Plug
30	2P 3W		600/250	HBL330RS1W	HBL330PS1W	HBL330CS1W	IN330FS1	IN330MS1
	3P 4W		600/250	HBL430RS1W	HBL430PS1W	HBL430CS1W	IN430FS1	IN430MS1
	4P 5W		600/250	HBL530RS1W	HBL530PS1W	HBL530CS1W	IN530FS1	IN530MS1
60	2P 3W		600/250	HBL360RS1W	HBL360PS1W	HBL360CS1W	IN360FS1	IN360MS1
	3P 4W		600/250	HBL460RS1W	HBL460PS1W	HBL460CS1W	IN460FS1	IN460MS1
	4P 5W		600/250	HBL560RS1W	HBL560PS1W	HBL560CS1W	IN560FS1	IN560MS1
100	2P 3W		600/250	HBL3100RS1W	HBL3100PS1W	HBL3100CS1W	IN3100FS1	IN3100MS1
	3P 4W		600/250	HBL4100RS1W	HBL4100PS1W	HBL4100CS1W	IN4100FS1	IN4100MS1
	4P 5W		600/250	HBL5100RS1W	HBL5100PS1W	HBL5100CS1W	IN5100FS1	IN5100MS1
200	3P 4W		600/250	HBL4200RS1W	HBL4200PS1W	HBL4200CS1W	IN4200FS1†	IN4200MS1†
	4P 5W		600/250	HBL5200RS1W	HBL5200PS1W	HBL5200CS1W	IN5200FS1†	IN5200MS1†

Rating				Style II Devices			Replacement Interiors	
Amps	Poles and Wires	Receptacle/Connector Configuration*	Maximum Voltage AC/DC	Receptacle	Plug	Connector	Connector & Receptacle	Plug
30	2P 3W		600/250	HBL330RS2W	HBL330PS2W	HBL330CS2W	IN330FS2	IN330MS2
	3P 4W		600/250	HBL430RS2W	HBL430PS2W	HBL430CS2W	IN430FS2	IN430MS2
60	2P 3W		600/250	HBL360RS2W	HBL360PS2W	HBL360CS2W	IN360FS2	IN360MS2
	3P 4W		600/250	HBL460RS2W	HBL460PS2W	HBL460CS2W	IN460FS2	IN460MS2
100	2P 3W		600/250	HBL3100RS2W	HBL3100PS2W	HBL3100CS2W	IN3100FS2	IN3100MS2
	3P 4W		600/250	HBL4100RS2W	HBL4100PS2W	HBL4100CS2W	IN4100FS2	IN4100MS2
200	2P 3W		600/250	HBL3200RS2W	HBL3200PS2W	HBL3200CS2W	IN3200FS2†	IN3200MS2†
	3P 4W		600/250	HBL4200RS2W	HBL4200PS2W	HBL4200CS2W	IN4200FS2†	IN4200MS2†

Rating				Corrosion Resistant Devices			Accessories	
Amps	Poles and Wires	Receptacle/Connector Configuration*	Maximum Voltage AC/DC	 Receptacle	 Plug	 Connector	 Back Boxes	 Angle Adapter
200	4P 5W		600/250	M5200RS1	M5200PS1	M5200CS1	MB2003W MB2004W	AA20045

Note: *CAUTION: To avoid electrical shock, review premises carefully and DO NOT use if Pin and Sleeve configuration (design) is already in a circuit having a rating differing from the rating of this device.

**While in use or with cover closed.

†Consult factory.

See page AA-19 for corrosion resistant cord sets.









Pin and Sleeve Devices/Mechanical Interlocks







30, 60, 100 and 200 Amp, 600/250 Volt AC/DC, 50-400 Hertz

TYPE 4X**

Rating				"Reversed Service" Style I Devices			Replacement Interiors	
Amps	Poles and Wires	Receptacle/ Connector Configuration*	Maximum Voltage AC/DC	 Receptacle	 Plug	 Connector	 Connector & Receptacle	 Plug
30	2P 3W		600/250	HBL330RS1WR	HBL330PS1WR	HBL330CS1WR	IN330MS1	IN330FS1
	3P 4W		600/250	HBL430RS1WR	HBL430PS1WR	HBL430CS1WR	IN430MS1	IN430FS1
	4P 5W		600/250	HBL530RS1WR	HBL530PS1WR	HBL530CS1WR	IN530MS1	IN530FS1
60	2P 3W		600/250	HBL360RS1WR	HBL360PS1WR	HBL360CS1WR	IN360MS1	IN360FS1
	3P 4W		600/250	HBL460RS1WR	HBL460PS1WR	HBL460CS1WR	IN460MS1	IN460FS1
	4P 5W		600/250	HBL560RS1WR	HBL560PS1WR	HBL560CS1WR	IN560MS1	IN560FS1
100	2P 3W		600/250	HBL3100RS1WR	HBL3100PS1WR	HBL3100CS1WR	IN3100MS1	IN3100FS1
	3P 4W		600/250	HBL4100RS1WR	HBL4100PS1WR	HBL4100CS1WR	IN4100MS1	IN4100FS1
	4P 5W		600/250	HBL5100RS1WR	HBL5100PS1WR	HBL5100CS1WR	IN5100MS1	IN5100FS1
200	3P 4W		600/250	HBL4200RS1WR	HBL4200PS1WR	HBL4200CS1WR	IN4200MS1†	IN4200FS1†
	4P 5W		600/250	HBL5200RS1WR	HBL5200PS1WR	HBL5200CS1WR	IN5200MS1†	IN5200FS1†

Rating				"Reversed Service" Style II Devices			Replacement Interiors	
Amps	Poles and Wires	Receptacle/ Connector Configuration*	Maximum Voltage AC/DC	Receptacle	Plug	Connector	Connector & Receptacle	Plug
30	2P 3W		600/250	HBL330RS2WR	HBL330PS2WR	HBL330CS2WR	IN330MS2	IN330FS2
	3P 4W		600/250	HBL430RS2WR	HBL430PS2WR	HBL430CS2WR	IN430MS2	IN430FS2
60	2P 3W		600/250	HBL360RS2WR	HBL360PS2WR	HBL360CS2WR	IN360MS2	IN360FS2
	3P 4W		600/250	HBL460RS2WR	HBL460PS2WR	HBL460CS2WR	IN460MS2	IN460FS2
100	2P 3W		600/250	HBL3100RS2WR	HBL3100PS2WR	HBL3100CS2WR	IN3100MS2	IN3100FS2
	3P 4W		600/250	HBL4100RS2WR	HBL4100PS2WR	HBL4100CS2WR	IN4100MS2	IN4100FS2
200	2P 3W		600/250	HBL3200RS2WR	HBL3200PS2WR	HBL3200CS2WR	IN3200MS2†	IN3200FS2†
	3P 4W		600/250	HBL4200RS2WR	HBL4200PS2WR	HBL4200CS2WR	IN4200MS2†	IN4200FS2†

Rating				"Reversed Service" Corrosion Resistant Devices			Accessories	
Amps	Poles and Wires	Receptacle/ Connector Configuration*	Maximum Voltage AC/DC	 Receptacle	 Plug	Connector	 Back Boxes	 Angle Adapter
200	4P 5W		600/250	M5200BS1R	M5200CS1R	—	MB2003W MB2004W	AA20045

Note: *CAUTION: To avoid electrical shock, review premises carefully and DO NOT use if Pin and Sleeve configuration (design) is already in a circuit having a rating differing from the rating of this device.
 **While in use or with cover closed.
 †Consult factory.
 See page AA-19 for corrosion resistant cord sets.

Pin and Sleeve Devices/Mechanical Interlocks



MB301W



MB304W

MB601003W



MB601006W



MB2003W



CC3430



ILR1



SAB34



074093403

Insulgrip Pin and Sleeve Metallic Back Boxes

Hubbell manufactures an extensive line of back boxes for use with UL 1686 Pin and Sleeve devices. Each back box is designed to give the user the maximum amount of wiring room while achieving grounding to metallic conduit.

Metallic 30° Angle Back Box*

Description	Amps	NPT Hub Size	Catalog Number
Back box for 30A devices.	30	3/4"	MB301W
	30	1"	MB302W

Metallic 15° Angle Back Box*

Description	Amps	NPT Hub Size	Catalog Number
Back box for 60A devices.	60	1"	MB601W
	60	1 1/4"	MB602W
	60	1 1/2"	MB603W

Metallic Feed-Thru Back Box*

Description	Amps	NPT Hub Size	Catalog Number
Straight feed-thru box for 30A devices.	30	3/4"	MB303W
	30	1"	MB304W
Straight feed-thru box for 60A devices.	60	1"	MB604W
	60	1 1/4"	MB605W
	60	1 1/2"	MB606W

Metallic Four-Way Angle Back Box*

Description	Amps	NPT Hub Size	Catalog Number
Four-way 15° angle box for 60 and 100A devices.	60/100	1 1/4"	MB601002W
	60/100	1 1/2"	MB601003W
	60/100	2"	MB601004W
Four-way 45° angle box for 200A devices.	200	2"	MB2003W
	200	2 1/2"	MB2004W
45° Angle adapter only for 200A devices.	200	-	AA20045

Metallic Four-Way Feed-Thru 15° Angle Back Box*

Description	Amps	NPT Hub Size	Catalog Number
Four-way feed-thru, 15° angle for 60 and 100A devices.	60/100	1 1/4"	MB601006W
	60/100	1 1/2"	MB601007W
	60/100	2"	MB601008W

Note: *These boxes are cast aluminum, suitable for IP54 requirements and are finished with enamel paint.

Replacement Cord Clamp and Locking Ring

Description	Used on	Cord Clamp Catalog Number	Locking Ring Catalog Number
Fits all 30A plugs and connectors.	All 3, 4, 5 wire	CC3430	ILR1**
Fits all 60A plugs and connectors.	4 wire (Style 2) and all 5 wire	CC60	ILR2**
	All 3 wire and 4 wire (Style 1)	CC60	ILR3**
Fits all 100A plugs and connectors.	4 wire (Style 2) and all 5 wire	CC100	ILR4**
	All 3 wire and 4 wire (Style 1)	CC100	ILR5**
Fits all 200A plugs and connectors.	All 3, 4, 5 wire	CC201	—

Note: **Locking Ring only.

Liquidtight Adapters

Rating of Hubbell Pin and Sleeve Device	Liquidtight Conduit Size	Hubbell Liquidtight Adapter	Optional Kellems Liquidtight Conduit Grip
30 Amp	1/2" NPT	SAB12	074093402
	3/4" NPT	SAB34	074093403
	1" NPT	SAB100	074093404
60 Amp	1" NPT	SAC100	074093404
	1 1/4" NPT	SAC125	074093405
100 Amp	1 1/4" NPT	SAD125	074093405
	1 1/2" NPT	SAD150	074093406

Pin and Sleeve Devices/Mechanical Interlocks

Plug Dimensions

Amps	Type	A		B		Cord Grip Range
		Style I	Style II	Style I	Style II	
30	330P	7.53" (191)	7.53" (191)	3.00" (76)	3.00" (76)	.375-1.20" (9.5-30.5)
	430P	7.53" (191)	7.53" (191)	3.00" (76)	3.00" (76)	.375-1.20" (9.5-30.5)
	530P	7.53" (191)		3.00" (76)		.375-1.20" (9.5-30.5)
60	360P	9.40" (239)	9.40" (239)	3.40" (86)	3.40" (86)	.500-1.45" (12.7-36.8)
	460P	9.40" (239)	9.40" (239)	3.40" (86)	3.70" (94)	.500-1.45" (12.7-36.8)
	560P	9.40" (239)		3.70" (94)		.500-1.45" (12.7-36.8)
100	3100P	10.70" (272)	10.70" (272)	3.70" (94)	3.70" (94)	.925-1.94" (27.0-49.3)
	4100P	10.70" (272)	10.90" (277)	3.70" (94)	4.00" (102)	.925-1.94" (27.0-49.3)
	5100P	10.90" (277)		4.00" (102)		.925-1.94" (27.0-49.3)
200	3200P		11.13" (282)		6.35" (161)	1.00-2.50" (25.4-63.5)
	4200P	11.13" (282)	11.13" (282)	6.35" (161)	6.70" (170)	1.00-2.50" (25.4-63.5)
	5200P	11.13" (282)		6.70" (170)		1.00-2.50" (25.4-63.5)

Connector Body Dimensions

Amps	Type	A		B		Cord Grip Range
		Style I	Style II	Style I	Style II	
30	330C	8.38" (213)	8.38" (213)	3.74" (95)	3.74" (95)	.375-1.20" (9.5-30.5)
	430C	8.38" (213)	8.38" (213)	3.74" (95)	3.74" (95)	.375-1.20" (9.5-30.5)
	530C	8.38" (213)		3.74" (95)		.375-1.20" (9.5-30.5)
60	360C	9.90" (251)	9.90" (251)	3.50" (89)	3.50" (89)	.500-1.45" (12.7-36.8)
	460C	9.90" (251)	10.10" (256)	3.50" (89)	3.80" (96)	.500-1.45" (12.7-36.8)
	560C	10.10" (256)		3.80" (96)		.500-1.45" (12.7-36.8)
100	3100C	11.70" (297)	11.70" (297)	4.50" (114)	4.50" (114)	.925-1.94" (27.0-49.3)
	4100C	11.70" (297)	11.90" (302)	4.50" (114)	4.70" (119)	.925-1.94" (27.0-49.3)
	5100C	11.90" (302)		4.70" (119)		.925-1.94" (27.0-49.3)
200	3200C		13.65" (346)		7.00" (177)	1.00-2.50" (25.4-63.5)
	4200C	13.65" (346)	13.65" (346)	7.00" (177)	7.39" (187)	1.00-2.50" (25.4-63.5)
	5200C	13.65" (346)		7.39" (187)		1.00-2.50" (25.4-63.5)

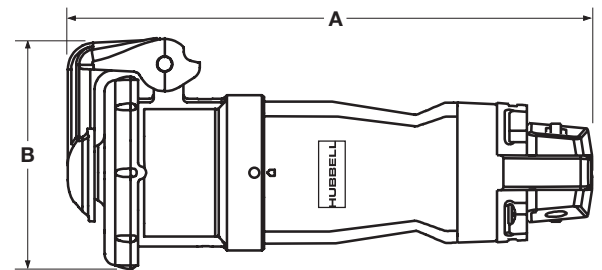
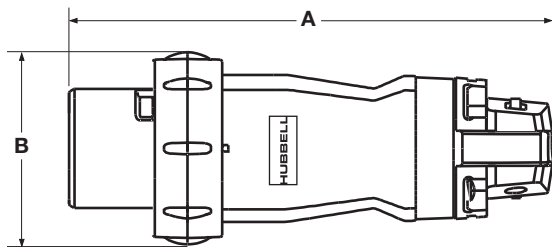

Receptacle Dimensions

Amps	Type	A		B		C		D		E	
		Style I	Style II	Style I	Style II	Style I	Style II	Style I	Style II	Style I	Style II
30	330R	2.72" (69)	2.72" (69)	3.40" (86)	3.40" (86)	3.89" (99)	3.89" (99)	3.19" (81)	3.19" (81)	1.37" (35)	1.37" (35)
	430R	2.72" (69)	2.72" (69)	3.40" (86)	3.40" (86)	3.89" (99)	3.89" (99)	3.19" (81)	3.19" (81)	1.37" (35)	1.37" (35)
	530R	2.72" (69)		3.40" (86)		3.89" (99)		3.19" (81)		1.37" (35)	
60	360R	3.50" (89)	3.50" (89)	4.25" (108)	4.25" (108)	4.66" (118)	4.66" (118)	4.42" (112)	4.42" (112)	1.54" (39)	1.54" (39)
	460R	3.50" (89)	3.50" (89)	4.25" (108)	4.25" (108)	4.66" (118)	4.66" (118)	4.42" (112)	4.42" (112)	1.54" (39)	1.54" (39)
	560R	3.50" (89)		4.25" (108)		4.66" (118)		4.42" (112)		1.54" (39)	
100	3100R	3.50" (89)	3.50" (89)	4.25" (108)	4.25" (108)	4.66" (118)	4.70" (119)	5.30" (135)	5.30" (135)	1.54" (39)	1.54" (39)
	4100R	3.50" (89)	3.50" (89)	4.25" (108)	4.25" (108)	4.66" (118)	4.70" (119)	5.30" (135)	5.30" (135)	1.54" (39)	1.54" (39)
	5100R	3.50" (89)		4.25" (108)		4.66" (118)		5.30" (135)		1.54" (39)	
200	3200R		6.50" (165)		7.00" (177)		5.63" (143)		7.76" (197)		.99" (25)
	4200R	6.50" (165)	6.90" (170)	7.00" (177)	7.39" (187)	5.63" (143)	5.63" (143)	7.76" (197)	7.76" (197)	.99" (25)	.99" (25)
	5200R	6.90" (170)		7.39" (187)		5.63" (143)		7.76" (197)		.99" (25)	

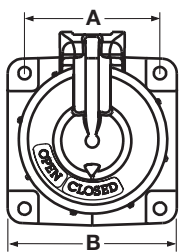

30, 60 and 100 Amp

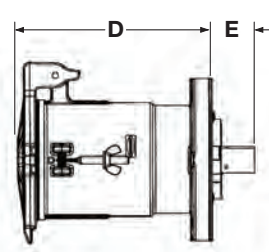
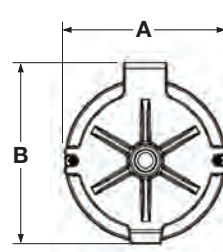
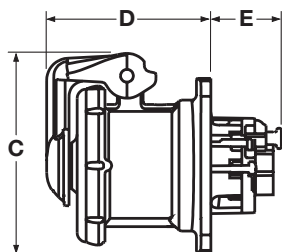

200 Amp

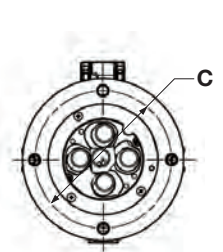

Dimensions in Inches (mm)

Pin and Sleeve Devices/Mechanical Interlocks

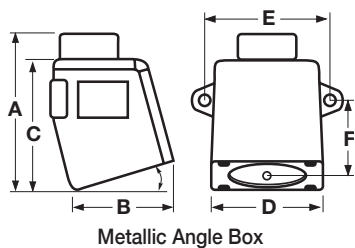

Metallic Angle Box

Metallic Angle Back Box

Description	NPT Hub Size	A Inch (mm)	B Inch (mm)	C Inch (mm)	D Inch (mm)	E Inch (mm)	F Inch (mm)	Catalog Number
30° Angle back box for 30A devices.	¾"	4.87" (124.0)	2.94" (75.0)	4.02" (102.0)	3.40" (86.0)	4.25" (108.0)	2.12" (54.0)	MB301W
	1"	4.87" (124.0)	2.94" (75.0)	4.02" (102.0)	3.40" (86.0)	4.25" (108.0)	2.12" (54.0)	MB302W
15° Angle back box for 60A devices.	1"	–	4.80" (121.9)	–	–	5.25" (133.4)	2.69" (68.3)	MB601W
	1¼"	–	4.80" (121.9)	–	–	5.25" (133.4)	2.69" (68.3)	MB602W
	1½"	–	4.80" (121.9)	–	–	5.25" (133.4)	2.69" (68.3)	MB603W

Metallic Feed-Thru Back Box

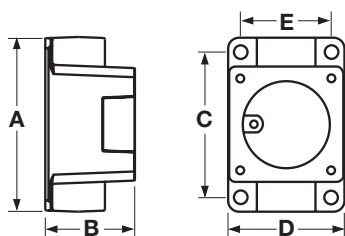

Metallic Feed-Thru Box

Description	NPT Hub Size	A Inch (mm)	B Inch (mm)	C Inch (mm)	D Inch (mm)	E Inch (mm)	F Inch (mm)	Catalog Number
Back box for 30A devices.	¾"	5.35" (136.0)	2.91" (74.0)	4.53" (115.0)	3.59" (91.0)	2.62" (67.0)	–	MB303W
	1"	5.35" (136.0)	2.91" (74.0)	4.53" (115.0)	3.59" (91.0)	2.62" (67.0)	–	MB304W
Back box for 60A devices.	1"	6.50" (165.1)	3.80" (97.0)	5.75" (146.1)	4.50" (114.3)	3.50" (88.9)	–	MB604W
	1¼"	6.50" (165.1)	3.80" (97.0)	5.75" (146.1)	4.50" (114.3)	3.50" (88.9)	–	MB605W
	1½"	6.50" (165.1)	3.80" (97.0)	5.75" (146.1)	4.50" (114.3)	3.50" (88.9)	–	MB606W

Metallic Four-Way Angle Back Box

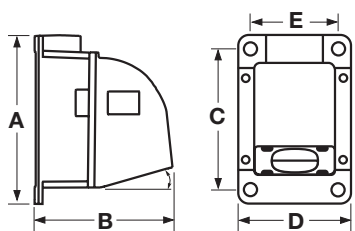

Metallic Four-Way Angle Box

Description	NPT Hub Size	A Inch (mm)	B Inch (mm)	C Inch (mm)	D Inch (mm)	E Inch (mm)	F Inch (mm)	Catalog Number
15° Angle four-way box for 60 and 100A devices.	1¼"	7.92" (201.0)	8.52" (216.0)	7.00" (178.0)	6.14" (156.0)	4.88" (124.0)	–	MB601002W
	1½"	7.92" (201.0)	8.52" (216.0)	7.00" (178.0)	6.14" (156.0)	4.88" (124.0)	–	MB601003W
	2"	7.92" (201.0)	8.52" (216.0)	7.00" (178.0)	6.14" (156.0)	4.88" (124.0)	–	MB601004W
45° Angle four-way box for 200A devices.	2"	10.82" (274.8)	9.86" (250.4)	9.50" (241.3)	8.17" (207.5)	6.75" (171.5)	–	MB2003W
	2½"	10.82" (274.8)	9.86" (250.4)	9.50" (241.3)	8.17" (207.5)	6.75" (171.5)	–	MB2004W
45° Angle adapter only for 200A devices.	–	8.00" (203.2)	6.00" (152.4)	7.00" (178.0)	8.00" (203.2)	7.00" (178.0)	–	AA20045

Metallic Four-Way Feed-Thru 15° Angle Back Box

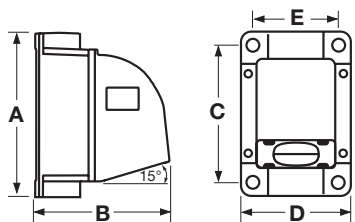

Metallic Feed-Thru Angle Box

Description	NPT Hub Size	A Inch (mm)	B Inch (mm)	C Inch (mm)	D Inch (mm)	E Inch (mm)	F Inch (mm)	Catalog Number
Four-way Feed-thru box for 60 and 100A devices.	1¼"	7.98" (202.7)	8.55" (217.2)	7.00" (178.0)	6.14" (156.0)	4.88" (124.0)	–	MB601006W
	1½"	7.98" (202.7)	8.55" (217.2)	7.00" (178.0)	6.14" (156.0)	4.88" (124.0)	–	MB601007W
	2"	7.98" (202.7)	8.55" (217.2)	7.00" (178.0)	6.14" (156.0)	4.88" (124.0)	–	MB601008W

Note: These boxes are cast aluminum, suitable for IP54 requirements and are finished with enamel paint.

Dimensions in Inches (mm)

Pin and Sleeve Devices/Mechanical Interlocks

Materials (30, 60, 100, and 200 Amp)

Plug	Material
Housing	PBT (200A Aluminum)
Plug Shroud	Aluminum
Cord Clamps	PBT (200A Aluminum)
Clamp Nut	Nickel Plated Brass
Gland Cap	PBT
Gland	Neoprene
O-Rings, Gaskets & Seals	Neoprene
Contact Carrier	Thermoset Polyester
Retainer	Thermoset Polyester
Sleeves	Brass (M-Series - Nickel-plated tellurium copper)
Box Terminal	Heat Treated & Zinc Plated Steel
Screws (Terminal, Assembly & Set)	Stainless Steel (300 Series)
Ground Standoff	Brass
Ground Bracket	Nickel Plated Spring Bronze
Locking Ring	Epoxy Painted Aluminum
Connector Body	
Housing	PBT (200 Amp Aluminum)
Connector Shroud	Epoxy Painted Aluminum
Cord Clamps	PBT
Clamp Nut	Nickel Plated Brass
Gland Cap	PBT (200A Aluminum)
Gland	Neoprene
O-Rings, Gaskets & Seals	Neoprene
Contact Carrier	Thermoset Polyester
Retainer	Thermoset Polyester
Pin	Brass (M-Series - Nickel-plated tellurium copper)
Pin Spring	Beryllium Copper
Box Terminal	Heat Treated & Zinc Plated Steel
Screws (Terminal, Assembly & Set)	Stainless Steel (300 Series)
Ground Standoff	Brass
Ground Bracket	Nickel Plated Spring Bronze
Cover	Epoxy Painted Aluminum
Cover Arm	Epoxy Painted Aluminum
Spring Guide	Stainless Steel (300 Series)
Springs (Arm & Wave)	Stainless Steel (300 Series)
Spring Washer	Stainless Steel (300 Series)
Hinge Bushing	Aluminum
Rivet	Aluminum
Receptacle	
Housing/Flange	Epoxy Painted Aluminum
O-Rings, Gaskets & Seals	Neoprene
Contact Carrier	Thermoset Polyester
Retainer	Thermoset Polyester
Pin	Brass (M-Series - Nickel-plated tellurium copper)
Pin Spring	Beryllium Copper
Box Terminal	Heat Treated & Zinc Plated Steel
Screws (Terminal, Assembly & Set)	Stainless Steel (300 Series)
Ground Standoff	Brass
Ground Bracket	Steel
Cover	Epoxy Painted Aluminum
Cover Arm	Epoxy Painted Aluminum
Spring Guide	Stainless Steel (300 Series)
Springs (Arm & Wave)	Stainless Steel (300 Series)
Spring Washer	Stainless Steel (300 Series)
Hinge Bushing	Aluminum
Rivet	Aluminum

Typical Specification

Manufacturer's ID	Hubbell HBL430PS2W
Description	Plug, Power Supply
Electrical Type	3 Pole + Earth
Max. Rating	30 Amp, 600V AC, 250V DC, 50-400Hz
Configuration	UL 1686, Watertight, C1 Configuration
Certification	UL Listed, UL Standard 1682, UL 50, and UL 1010 (plugs only), CSA Certified to CSA Spec. C22.2 No. 182.1, No. 94 and No. 159 (plugs only), UL Listed and CSA Certified Type 4X

Performance

Electrical	
Voltage	30, 60, 100 and 200 Amp, 600/250 Volt AC/DC, 50-400 Hertz
Dielectric Voltage	Withstands 3,000V AC.
Max. Working Voltage	600V AC RMS (i.e., minimum creepage and clearance distance of 6.4 millimeters, per UL 1682).
Current Interrupting	Certified for current interrupting at full rated current.
Temperature Rise	Max. 30°C temperature rise at full rated current after 50 cycles of overload at 150% of rated current.
Endurance	Up to 1,000 connect and disconnect cycles at full rated current and voltage.

Mechanical	
Impact Resistance	Per CSA C22.2, No. 182.1, UL 1682.
Cord Grip Cable Retention	Per CSA C22.2, No. 182.1, UL 1682.
Cord Accommodation	Round portable service cords of diameters commensurate with the device rating as defined in UL Standard 62, CSA C22.2 No. 49 and the harmonized <HAR> European Standards.
Terminal Identification	Terminals identified in accordance with UL 1686 (1, 2, 3, Green).
Product Identification	Identification and ratings are permanently fastened to the device housing.

Environmental	
Hose Down & Moisture Resistance	Type 3, 4, 4X per UL 50E and CSA 22.2, No. 94.
Flammability (Enclosure)	UL 94V-0 and CSA C22.2 No. 0.17.
Operating Temperatures	Maximum Continuous 75°C; Minimum -40°C without impact -25° with impact.
Hazardous Location (30, 60 & 100A) (plug only)	Class I, Division I & II, Groups B, C & D and Class II, Division I & II, Groups F & G per UL 1010 & CSA 22.2, No. 159.

Materials	
Housings	PBT 357 (200A Aluminum).
All Other Materials	Resistant to corrosion and chemical attack.

Watertight Application Guide

Industry	Watertight.
Agriculture	Outdoor for fans, heaters, pumps, etc.
Chemical Processing	Where subject to water, corrosion.
Construction	Outdoors subject to severe weather conditions.
Entertainment	Outdoors subject to severe weather.
Food Processing	Where subject to water, corrosion.
Food Service	Areas subject to wash downs & heavy cleaning.
Light Manufacturing	Subjected to cleaning, solvents & chemicals.
Manufacturing	Where subject to water, corrosion.
Military	Outdoor construction or maintenance.

Pin and Sleeve Devices/Mechanical Interlocks

Features and Benefits

Style II Insulgrip® Mechanical Interlocks

Hubbell Circuit-Lock® Pin and Sleeve Mechanical Interlocks are a revolutionary design that incorporates a disconnect switch and pin and sleeve receptacle in a compact non-metallic unit. These devices offer maximum safety by preventing users from mating or breaking a circuit under load—Hubbell's interlock mechanism detects the presence of a plug and prevents it from being removed when the switch is in the "ON" position.

It features a high visibility red handle that can be locked to meet OSHA lockout/tagout regulations, and the enclosure door can be locked to prevent unauthorized access. The rugged, corrosion-resistant Type 4X PBT enclosure features adjustable mounting feet for flexible installation, while the receptacle's spring-loaded cover with gasket is dust tight and provides a watertight seal when turned and locked.

The patented Plug-Check™ mechanism detects the presence of the plug. It operates as a clutch to engage the handle with the switch and captures the plug. This action prevents the plug from being removed until the switch is turned OFF.

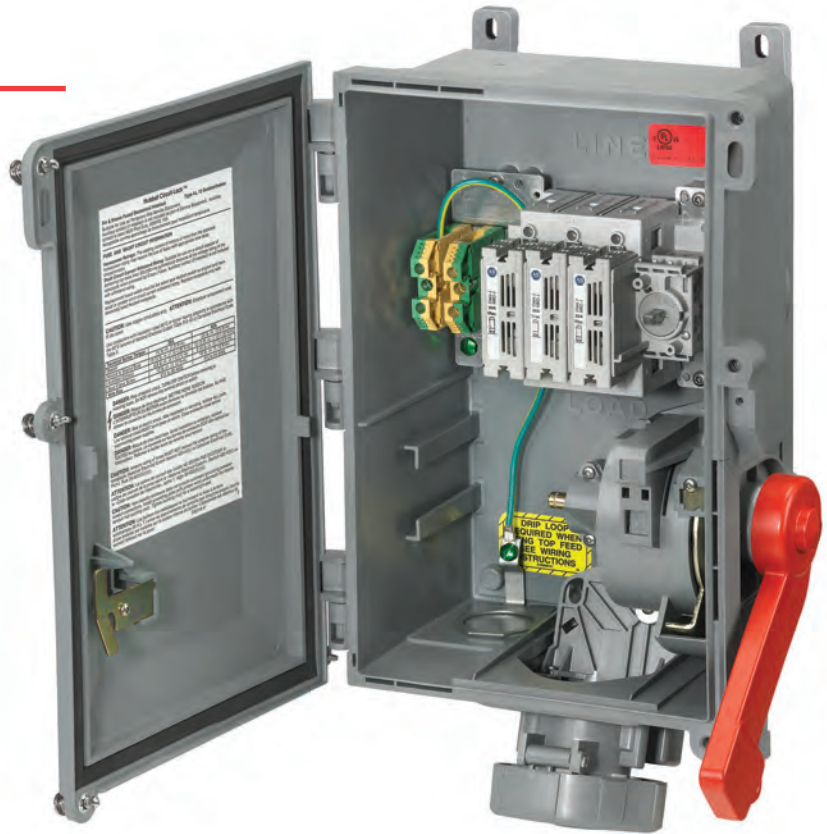

Housing Design

- Non-metallic enclosure meets UL 50E Type 4X (watertight), 12 (dust-tight) and IP66 suitability requirements. Enclosure is molded of rugged thermoplastic PBT to resist abuse, corrosion and enhance safety. All external hardware is stainless steel
- Stainless steel ¼ turn door fasteners for quick, easy access to fuses

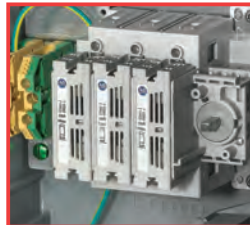

Interior Design

- Compact Fused Disconnect Switch accepts **Class "J" fuses**. Fuse holders are top mounted for easy access
- The switch accepts auxiliary contacts for control circuit applications including the ON/OFF control of remote pilot lights or signal for programmable controllers

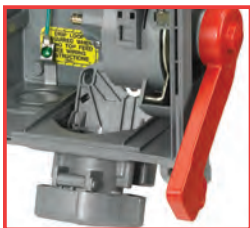

Safety

- High visibility red handle can be locked in the OFF position as a method of compliance with OSHA lockout requirements. Accepts up to a 3/16 inch padlock shackle
- Replaceable spring-loaded receptacle liftcover with gasket ensures dust tight rating; liftcover provides watertight seal when turned and locked



Contact Carrier

- Thermoset polyester contact carrier provides resistance to electrical tracking and withstands higher temperatures
- Thermoset properties provide excellent dimensional stability, low moisture absorption and superior dielectric strength



Enclosure Door

- Removable door for ease of wiring and installation
- Enclosure door can be locked to prevent unauthorized access. Additionally, if the switch is ON, the door cannot be opened



Installation

- Three molded-in conduit drill points are located on the top, bottom and back surface of enclosure. Conduit hub provided: 30A 1 in. NPT, 60A 1 1/4 in. NPT
- Conduit hub and adjustable mounting feet (4) are ductile to allow mounting on irregular surfaces

Style II - Fused

Rating				Fused Insulgrip® Mechanical Interlocks	
Amps	Poles and Wires	Receptacle/ Connector Configuration*	Maximum Voltage AC/DC	Mechanical Interlock	Mating Plug
30	3P 4W		600/250	 HBL430MIFS2W	 HBL430PS2W
60	3P 4W		600/250	 HBL460MIFS2W	 HBL460PS2W



HBL430MIFS2W

Style II - Unfused

Rating				Unfused Insulgrip® Mechanical Interlocks	
Amps	Poles and Wires	Receptacle/ Connector Configuration*	Maximum Voltage AC/DC	Mechanical Interlock	Mating Plug
30	3P 4W		600/250	 HBL430MIS2W	 HBL430PS2W
60	3P 4W		600/250	 HBL460MIS2W	 HBL460PS2W

Gray Style Switch



HBLACFSNO

HBL30MIFRS

Black Style Switch



ACFSNO

Note: 30A – 1 inch NPT hub supplied; 60A – 1¼ inch hub supplied.

***CAUTION:** To avoid electrical shock, review premises carefully and DO NOT use if Pin and Sleeve configuration (design) is already in a circuit having a rating differing from the rating of this device.

**While in use or with cover closed.

Replacement Auxiliary Contacts

Description	Black Style Switch	Gray Style Switch
Auxiliary contact, normally open, A600 pilot duty, break before break.	ACFSNO	HBLACFSNO
Auxiliary contact, normally closed, A600 pilot duty, break before break.	ACFSNC	HBLACFSNC

Note: Auxiliary contacts are specific to the style switch noted and are NOT interchangeable. All new installations are shipped with gray style switch.

Replacement Switches

Description	Gray Style Switch
For 30A fused switches.	HBL30MIFRS
For 60A fused switches. Gray Style switch will retro fit Black Style switch.	HBL60MIFRS
For 30A unfused switches.	HBL30MISRS
For 60A unfused switches. Gray Style switch will retro fit Black Style switch.	HBL60MISRS



MICPK30

Watertight Closure Plug Kits

Description	Catalog Number
For 30A Circuit-Lock® unfused and fused Pin and Sleeve mechanical interlocks.	MICPK30
For 60 and 100A Circuit-Lock® unfused and fused Pin and Sleeve mechanical interlocks.	MICPK60

Replacement Mounting Feet

Description	Catalog Number
Replacement mounting feet and screws for 30 and 60A fused mechanical interlocks.	HBLRFT2^A

Note: ^APackage of 10 feet and 10 screws.



HBLRFT2

Pin and Sleeve Devices/Mechanical Interlocks

Typical Specifications

Manufacturer's Identification	Hubbell HBL460MIFS2W
Description	Fused Insulgrip® Pin and Sleeve Mechanical Interlock
Electrical Type	3 Pole + Earth
Rating	60A, 250VDC/600VAC
Configuration	Per UL 1686 C1
Enclosure Type (UL 50E)	Indoor & Outdoor - 4X (Watertight, Washdown) Indoor - 12 (Dust Tight, Falling Dirt)
Ingress Protection Certification	IP66 Suitability UL Listed for US and Canada

Note: This device provides fused switched control of a plug connected load and includes an interlocking feature to prevent the plug from being disconnected or the door from opening while the receptacle is energized. The switch cannot be turned on until the plug is fully inserted.

Materials

Part	Material
Base, Door and Handle	PBT
Conduit Hub	Zinc, 30A – 1 in., 60A – 1¼ in. NPT
Enclosure Gasket and Shaft Seal	Neoprene
Shaft and Mounting Inserts	Brass
Ground Plate	Galvanized Steel
Enclosure Screws and Hinge Spring	Stainless Steel
Hinge Pin	Nickel-Plated Brass
Contact Carrier	Thermoset Polyester

Performance

Electrical	
Dielectric Voltage	Withstands 3,000VAC Min.
Max. Working Voltage	250VDC/600VAC.
Current Interrupting	Certified for current interrupting at full rated current and voltage.
Short Circuit Withstand Rating	Suitable for use on a circuit capable of delivering not more than 200,000 RMS symmetrical amperes at the voltage rating of receptacle.
Operations	Mechanical 10,000 cycles minimum.
Mechanical	
Impact Resistance	In accordance with UL 746C.
Terminal Identification	In accordance with UL, CSA and international conventions.
Product Ratings	Ratings are part of the external label and molded into the receptacle housing.
Mounting	External adjustable feet.
Environmental	
Moisture Resistance	Indoor & Outdoor - 4X (Watertight, Washdown); Indoor - 12 (Dust-tight, Falling dirt).
Ingress Protection	IP66 Suitability.
Flammability	UL94-5VA and V-0 Classification.
Operating Temperatures	Max. Continuous +60°C; Min. Continuous -40°C w/o impact.
UV Resistance	All exposed insulating materials are UV stabilized.
Fuse Types	UL Listed Class "J". CSA Certified HRCI-J.

Horsepower Ratings

30A Horsepower Ratings

3 Phase A.C.	Standard	Maximum*
200-240V	3	7.5
480V	5	15
600V	7.5	20

60A Horsepower Ratings

3 Phase A.C.	Standard	Maximum*
200-240V	7.5	15
480V	15	30
600V	15	50

*Note: *Requires time delay fuses.*

Dimensions

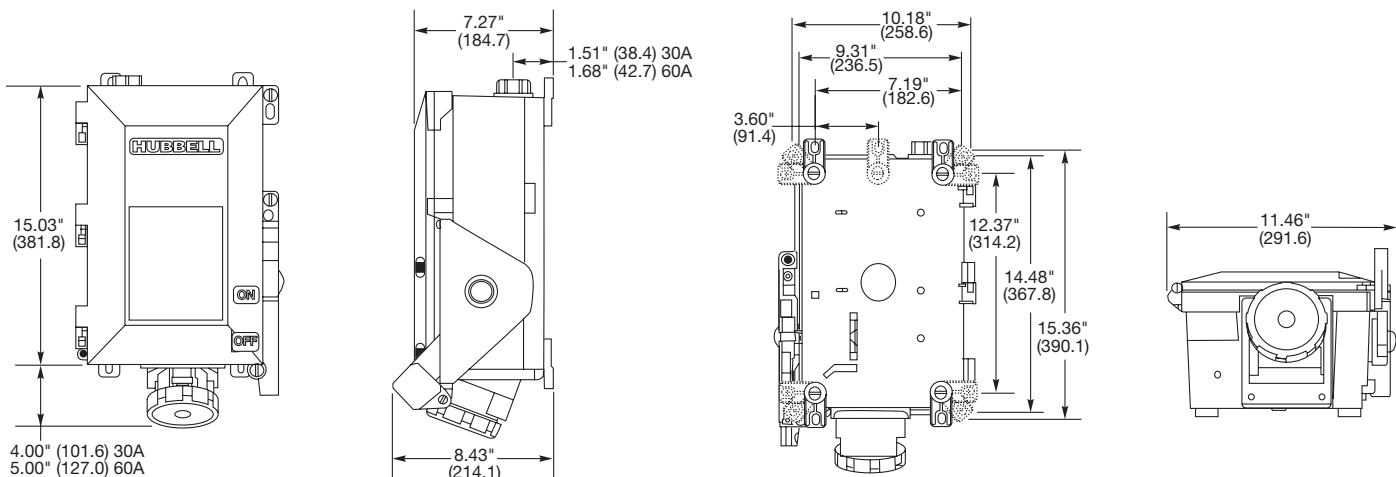

Note: 30A – 1 inch NPT hub supplied; 60A – 1¼ inch hub supplied.

Dimensions in Inches (mm)

Pin and Sleeve Devices/Mechanical Interlocks

Features and Benefits

Hazardous Location Non-Fused Mechanical Interlocks and Plugs

Hubbell's Hazardous Location Line of Non-Fused UL 1686 Mechanical Interlock Disconnect Switches are typically used for applications with the presence of flammable gasses or vapors, ignitable dusts and fibers. They are also suitable for use in outdoor or indoor damp, wet and dirty locations or in areas where frequent wash downs, heavy rain, or water spray routinely occurs.

These switches are compact in size to reduce cost and make it easier to position on the wall or piece of equipment. The enclosures are made of copper-free aluminum and have a polyester/epoxy finish to prevent corrosion. The high visibility handles can be locked out to comply with OSHA lock out/tag out regulations.

VSQ Hazardous Location Ratings

Class I, Div. 1 & 2, Groups B,C,D

Class I, Zones I & 2, Groups IIB+H2, IIA

Class II, Div. 1 & 2, Groups F & G

Class III

NEMA 3, 4, 4X, 7 (B,C,D), 9 (F,G)



Housing Design

- Copper-free aluminum construction with electrostatically applied polyester/epoxy finish to prevent corrosion
- Compact NEMA 4X enclosure and footprint allows easy installation in tight locations
- Feed-through construction



Internal Design

- Auxiliary contact (late-make early-break) contact rated 10 amp, 1/3 HP at 125/250V AC can be used for operating pilot lights or starter coils
- Internal switch horsepower rated as "suitable as a motor disconnect"



Safety

- Lockable handle to meet OSHA Lockout/Tagout regulations
- Large visible rotary handle with ON/OFF indicator allows a quick means of disconnecting power
- Handle mechanism is chemical resistant PBT thermoplastic



Plug Locking Ring

- NEMA 4X environmental rating with cover engaged or when mated with a 4X plug



Mechanism

- Plug and switch are interlocked. Switch cannot be turned ON without fully inserted plug. Plug cannot be removed with switch in ON position
- Plug held in place when switch is OFF for convenience. Pull operated release mechanism



Fully Interchangeable

- Product is UL1686 and is fully interchangeable with other UL1686 configured and listed devices

Pin and Sleeve Devices/Mechanical Interlocks



HBLVSQ3034

30 and 60 Amp Non-Fused UL1686 Mechanical Interlocks and Plugs

Amp	Circuit	Mechanical Interlock	Metallic Plug	Insulgrip Plug
30 Amp 600V AC	2W 3P	HBLVSQ3023	HBLVP3385	HBL330PS2W
	3W 4P	HBLVSQ3034	HBLVP3485	HBL430PS2W
60 AMP 600V AC	2W 3P	HBLVSQ6023	HBLVP6385	HBL360PS2W
	3W 4P	HBLVSQ6034	HBLVP6485	HBL460PS2W

Note: Early break contact comes standard with mechanical interlocks.

HBLVSQ 30 Amp models come standard with 1 inch drilled and tapped conduit openings top and bottom plus two 1 inch x 3/4 inch reducers and one 3/4 inch close-up plug for maximum flexibility. 60 amp models come with one 1 1/2 inch opening on top and bottom and one 1 1/2 inch close-up plug.



HBLVP3485



HBL430PS2W

Horsepower Ratings (VAC)*

Amp	Circuit	120	240	480	600	Catalog Number
30 Amp	1Ø	2	5	10	15	HBLVSQ3023
	3Ø	3	7.5	15	20	HBLVSQ3034
60 Amp	1Ø	-	10	15	20	HBLVSQ6023
	3Ø	-	10	25	30	HBLVSQ6034

Note: *Internal switch only.

Dimensions

Mechanical Interlocks	A	B	C	D	E	F
30A	5.75 (146)	10.50 (267)	9.75 (248)	3.75 (95)	3.13 (79)	8.13 (206)
60A	8.13 (206)	14.16 (360)	11.28 (287)	4.03 (102)	2.50 (64)	11.38 (289)

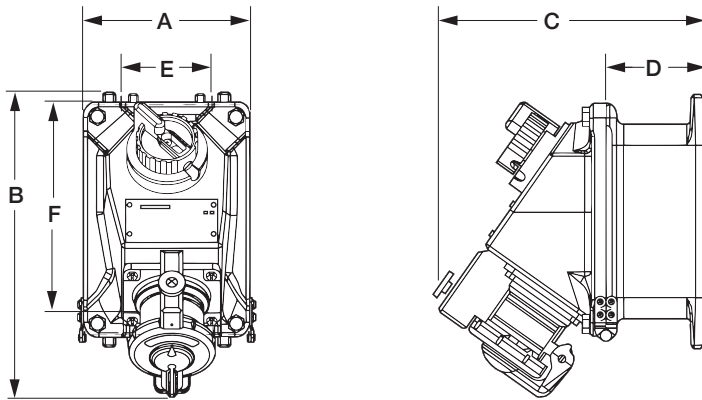

Plugs	A	B	C	D	E
30A Both	6.69 (170)	3.00 (76)	1.88 (48)	5.38 (137)	2.53 (64)
60A, 3 Pole	8.81 (224)	3.38 (86)	2.25 (57)	6.50 (165)	3.00 (76)
60A, 4 Pole	8.81 (224)	3.69 (94)	2.53 (64)	6.50 (165)	3.00 (76)

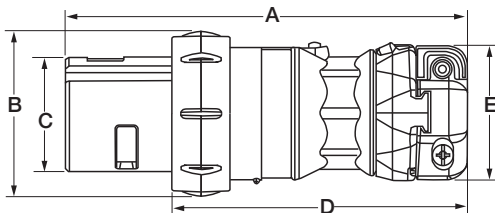

Dimensions in Inches (mm)

Wire Range	30A	60A
Reg. Stranded	#10 - #6	#6 - #4
Extra Flex	#10 - #8	#6 - #4
Grip Range	.55-1.2 (14-30)	.65-1.5 (16-38)

SECTION H

Table of Contents



Single Pole Inlines and Receptacles



Spider® II Temporary Power Boxes and Temporary Lighting



Stage Pin and Convention Center Pin and Sleeve Devices



Single Pole Devices	Page	Temporary Power	Page
Series 15 - 150 Amp, 600 Volts		Spider® II Temporary Power Boxes	
Features and Benefits	H-2	Features and Benefits	H-11
Inlines, Receptacles, Protective Caps and Weather Protective Covers	H-3	50A and 60A Spider® II Boxes	H-12
Tees, Gender Reversing Devices, Replacement Bodies and Accessories	H-4	Cable Sets, Receptacles and Replacement Parts	H-13
Specifications and Dimensions	H-5	Temporary Power Boxes and Power Cables	H-14
Series 16 - 300 and 400 Amp, 600 Volts		Heavy-Duty Portable Outlet Boxes and Cover Plates	H-15
Features and Benefits	H-2	Temporary Lighting	
Inlines and Receptacles	H-6	Construction Site Lighting	H-16
Receptacles, Terminals, Protective Caps and Weather Protective Covers	H-7	Maintenance Worklights, Accessories and Replacement Items	H-16
Tees, 3-Fers, Gender Reversing Devices, and Distribution Block	H-8	Confined Space Lighting	H-16
Replacement Parts, Snap Back Covers and Accessories	H-8	Stage Pin Devices	Page
Specifications and Dimensions	H-9	Features and Benefits	H-17
Series 18 - 300 and 400 Amp, 600 Volts		20, 60 & 100 Amp Devices	H-18
Features, 300 and 400 Amp Inlines	H-10	Convention Center Pin and Sleeve Devices	Page
Replacement Bodies and Accessories	H-10	Features and Benefits	H-19
Specifications and Dimensions	H-10	60 Amp Devices	H-20

Single Pole Devices and Temporary Power

Features and Benefits

Series 15 and 16 - 150, 300 and 400 Amp, 600 Volts

Hubbell Wiring Device-Kellems offers a full line of innovative, high quality, Series 15 and Series 16 single pole inlines, receptacles and accessories for the most demanding environments.

Single pole devices are the right choice for supplying temporary electrical power distribution for entertainment, theme parks, carnival equipment, concerts, movie making and numerous other applications requiring temporary power.

Single pole devices have been designed with ease of assembly and disassembly in mind, no special tools are required. A high strength non-conductive retaining screw is all that is needed to securely lock the contacts to the insulated sleeve.

UL Enclosure Types 3R, 4X and 12 Rating suitable for use in almost any environment.



Housing Design

- Insulgrip® style housing for superior gripping, conforms to the user's hand making it easy to connect and disconnect, even with gloves on
- Easily identifiable cable, cut off points for secure fit allows you to easily customize and cut the housing to the required/correct cable size
- Accommodates wide range of cables



Contacts

- Provides high contact pressure and vibration resistant connection, which helps reduce operating temperatures and extends product life
- High conductivity brass contact provides improved performance by helping to reduce operating temperatures and extends life



Safety

- Rounded corners reduce the possibility of catching or snagging on structures or equipment
- Non-conductive retaining screw locks contacts in place and allows for easy installation; prevents contact movement within housing
- Recessed mounting screw minimizes screwdriver slippage



Assembly

- Special screw thread requires fewer turns than most competitors and reduces the risk of a conductive screw being substituted
- Extra long non-conductive inner sleeve reduces force required to install housing over contacts; easier to rotate contact in body for installing retaining screw



Identification

- Lock symbol aids in the mating of devices and provides a clear indication that the devices are properly connected
- With lock indicator symbol making mating clear and simple; devices can lock 180° to prevent unintended disconnects



Installation

- Engineered body design makes installation simple with no need for additional tools and the non-metallic retaining screw helps to make operation safe for all involved
- Strip gauge molded into every inline and receptacle housing; simplifies installation and saves time

Series 15 - 150 Amp, 600 Volts

Enclosure Types
3R, 4X, 12



150 Amp Inlines

Description	Color	Male Inline
150 amp, thermoplastic elastomer, cable size #8 - #2 AWG.	Black	HBL15MBK
	White	HBL15MW
	Green	HBL15MGN
	Red	HBL15MR
	Blue	HBL15MBL
	Brown	HBL15MBN
	Orange	HBL15MO
	Yellow	HBL15MY
	Gray	HBL15MGY



150 Amp Inlines

Description	Color	Female Inline
150 amp, thermoplastic elastomer, cable size #8 - #2 AWG.	Black	HBL15FBK
	White	HBL15FW
	Green	HBL15FGN
	Red	HBL15FR
	Blue	HBL15FBL
	Brown	HBL15FBN
	Orange	HBL15FO
	Yellow	HBL15FY
	Gray	HBL15FGY

Receptacles, Stud Type Through Hole Mounting



Description	Color	Male Receptacles	Female Receptacles
150 amp, Panel Mount, thermoplastic, cable size #8 - #2 AWG.	Black	HBL15MRSBK	HBL15FRSBK
	White	HBL15MRSW	HBL15FRSW
	Green	HBL15MRSGN	HBL15FRSGN
	Red	HBL15MRSR	HBL15FRSR
	Blue	HBL15MRSBL	HBL15FRSBL
	Brown	HBL15MRSBN	HBL15FRSBN
	Orange	HBL15MRSO	HBL15FRSO
	Yellow	HBL15MRSY	HBL15FRSY
	Gray*	—	—

Note: *Gray is available upon request. Contact factory.

Receptacles, Double Set Screw Through Hole Mounting



Description	Color	Male Receptacles	Female Receptacles
150 amp, Panel Mount, thermoplastic, cable size #8 - #2 AWG.	Black	HBL15MRBK	HBL15FRBK
	White	HBL15MRW	HBL15FRW
	Green	HBL15MRGN	HBL15FRGN
	Red	HBL15MRR	HBL15FRR
	Blue	HBL15MRBL	HBL15FRBL
	Brown	HBL15MRBN	HBL15FRBN
	Orange	HBL15MRO	HBL15FRO
	Yellow	HBL15MRY	HBL15FRY
	Gray	HBL15MRGY	HBL15FRGY

Protective Caps



Description	Color	Fits Male Devices	Fits Female Devices
Fits 150 amp inlines and receptacles.	Black	HBL15MCAPBK	HBL15FCAPBK
	White	HBL15MCAPW	HBL15FCAPW
	Green	HBL15MCAPGN	HBL15FCAPGN
	Red	HBL15MCAPR	HBL15FCAPR
	Blue	HBL15MCAPBL	HBL15FCAPBL
	**	—	—

Note: **Additional colors are available upon request. Contact factory.

Weather Protective Covers



Description	Color	Catalog Number
Use with stud type or double set screw receptacles.	Clear	HBL15NCC
	Black	HBL15NCBK
	White	HBL15NCW
	Green	HBL15NCGN
	Red	HBL15NCR
	Blue	HBL15NCBL
	Brown	HBL15NCBN
	Orange	HBL15NCO
	Yellow	HBL15NCY

Series 15 - 150 Amp, 600 Volts

Enclosure Types
3R, 4X, 12

Tees



Color	Paralleling Tee (Male-Male-Female)	Tapping Tee (Female-Male-Female)
Black	HBL15PTBK	HBL15TBK
White	HBL15PTW	HBL15TW
Green	HBL15PTGN	HBL15TGN
Red	HBL15PTR	HBL15TR
Blue	HBL15PTBL	HBL15TBL

Gender Reversing Devices



Color	Double Male (Male-Male)	Double Female (Female-Female)
Black	HBL15DMBK*	HBL15DFBK*
White	HBL15DMW	HBL15DFW
Green	HBL15DMGN	HBL15DFGN
Red	HBL15DMR*	HBL15DFR*
Blue	HBL15DMBL*	HBL15DFBL*

Note: *UL 1691 restricts the use of male-to-male or female-to-female devices to Grounding (Green) or Neutral (White) conductors. Consult factory for availability of other non UL listed colors.

Replacement Bodies (25 Pack)



Color	Male Body	Female Body
Black	HBL15MBBK	HBL15FBBK
White	HBL15MBW	HBL15FBW
Green	HBL15MBGN	HBL15FBGN
Red	HBL15MBR	HBL15FBR
Blue	HBL15MBBL	HBL15FBL

Note: **Additional colors are available upon request. Contact factory.

Replacement Contacts (25 Pack)



Description	Male Pin	Female Sleeve
Contact, 150 amp	HBL15RCM	HBL15RCF

Accessories

Description	Catalog Number
Accessory Kit, retaining screw, copper foil, terminal screws and brass wire.	HBL15PK
Replacement retaining screw (100 pack).	HBL15RS
Copper foil (100 pack).	HBL15CF
Brass wire (100 pack).	HBL15BW
Terminal screw - inline (100 pack).	HBL15TS25
Terminal screw - panel mount (100 pack).	HBL15TS375
Ferrule #2 AWG (100 pack).	HBL15F2
Ferrule #4 AWG (100 pack).	HBL15F4



HBL15PK



HBL15RS



HBL15CF



HBL15BW



HBL15TS25



HBL15TS375



HBL15F2
HBL15F4

Single Pole Devices and Temporary Power

Series 15 - 150 Amp, 600 Volts

Specifications

Electrical	
Voltage Ratings	600V Maximum
Amperage Rating	150A Maximum
Mechanical	
Terminal Accommodation	Inline: #8 AWG to #2 AWG Receptacle: #8 AWG to #2 AWG
Product ID	Ratings are a permanent part of device
Base Compound	Inline: Thermoplastic Elastomer (TPE) Receptacle: Polybutylene Terephthalate (PBT)
Contact Material	Brass
Retaining Screw Material	Nylon

Certification / Environmental

UL and cUL Listed
 UL Enclosure Types 3R, 4X, 12
 UL1691 standard for single pole locking-type separable connectors
 National Electric Code (NEC®), ANSI/NFPA 70
 Flammability: HB per UL94 or CSA 22.2. 0.17

Conductor Ampacity Chart (Type SC/PPC Wire)

Cable Size	Ampacity*
#8	80
#6	105
#4	140
#2	190

Note: *90°C column NEC Table 400.5(A)(2).

Dimensions

Inlines

	A	B	C	D
Male	4.54" (115.3)	1.04" (26.4)	.86" (21.8)	3.22" (81.7)
Female	4.60" (116.8)	1.11" (28.2)	.68" (17.3)	3.28" (83.2)

Weatherproof Cover

	A	B	C
Series 15	2.03" (51.5)	1.14" (29.0)	1.49" (37.9)

Male Inline

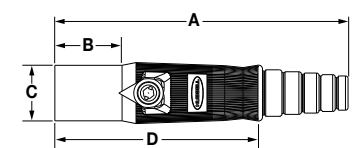

Female Inline

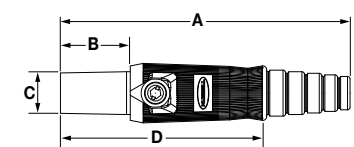

Panel Mount Receptacles

Threaded Stud	A	B	C	D	E	F	Mounting Hole	Termination
Male	1.86" (47.2)	1.37" (34.8)	2.82" (71.6)	.86" (22.0)	.80" (20.4)	1.20" (30.5)	Through 3x Ø .20"	5/16-18 Threaded Stud
Female	1.86" (47.2)	1.37" (34.8)	2.88" (73.1)	.86" (22.0)	.80" (20.4)	1.26" (32.0)	Through 3x Ø .20"	5/16-18 Threaded Stud
Double Set Screw	A	B	C	D	E	F	Mounting Hole	Termination
Male	1.86" (47.2)	1.37" (34.8)	2.90" (73.6)	.86" (22.0)	.88" (22.2)	1.20" (30.5)	Through 3x Ø .20"	(2) 5/32 Socket Head Set Screws
Female	1.86" (47.2)	1.37" (34.8)	2.95" (74.9)	.86" (22.0)	.87" (22.2)	1.26" (32.0)	Through 3x Ø .20"	(2) 5/32 Socket Head Set Screws

Weatherproof Cover

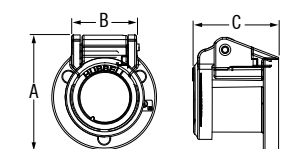

Tees

	A	B	C
Tapping Tee	2.67" (67.9)	4.28" (108.7)	.865" (21.9)
Paralleling Tee	2.67" (67.9)	4.22" (107.2)	.865" (21.9)

Gender Reversing Devices

	A	B	C
Double Male	4.22" (107.2)	.86" (21.8)	—
Double Female	4.22" (107.2)	1.05" (26.7)	.68" (17.3)

Tapping Tee

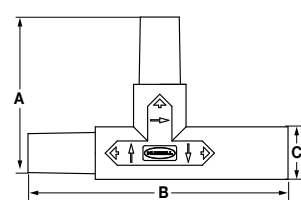

Paralleling Tee

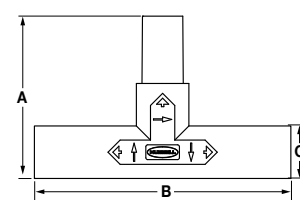

Gender Reversing - Double Male

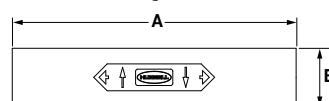

Gender Reversing - Double Female

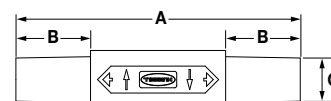

Threaded Stud (Male Shown)

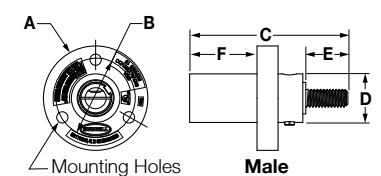

Double Set Screw (Male Shown)

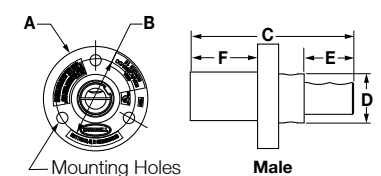

Series 16 - 300 and 400 Amp, 600 Volts

Enclosure Types
3R, 4X, 12



300 Amp Inlines

Description	Color	Male Inline	Female Inline
300 amp, thermoplastic elastomer, cable size #6 - 2/0 AWG.	Black	HBL300MBK	HBL300FBK
	White	HBL300MW	HBL300FW
	Green	HBL300MGN	HBL300FGN
	Red	HBL300MR	HBL300FR
	Blue	HBL300MBL	HBL300FBL
	Brown	HBL300MBN	HBL300FBN
	Orange	HBL300MO	HBL300FO
	Yellow	HBL300MY	HBL300FY
	Gray*	—	—

Note: *Gray is available upon request. Contact factory.



400 Amp Inlines

Description	Color	Male Inline	Female Inline
400 amp, thermoplastic elastomer, cable size 2/0 - 4/0 AWG.	Black	HBL400MBK	HBL400FBK
	White	HBL400MW	HBL400FW
	Green	HBL400MGN	HBL400FGN
	Red	HBL400MR	HBL400FR
	Blue	HBL400MBL	HBL400FBL
	Brown	HBL400MBN	HBL400FBN
	Orange	HBL400MO	HBL400FO
	Yellow	HBL400MY	HBL400FY
	Gray	HBL400MGY	HBL400FGY

Receptacles, Double Set Screw Through Hole Mounting



Description	Color	Male Receptacles	Female Receptacles
400 amp, Panel Mount, thermoplastic elastomer, cable size #4 - 4/0 AWG, mates with 300 and 400 amp Inlines.	Black	HBLMRBK	HBLFRBK
	White	HBLMRW	HBLFRW
	Green	HBLMRGN	HBLFRGN
	Red	HBLMRR	HBLFRR
	Blue	HBLMRBL	HBLFRBL
	Brown	HBLMRBN	HBLFRBN
	Orange	HBLMRO	HBLFR
	Yellow	HBLMRY	HBLFRY
	Gray	HBLMRGY	HBLFRGY

Angled Receptacles, Double Set Screw Through Hole Mounting



Description	Color	Male Receptacles	Female Receptacles
400 amp, Panel Mount, thermoplastic elastomer, cable size #4 - 4/0 AWG, mates with 300 and 400 amp Inlines.	Black	HBLMRABK	HBLFRABK
	White	HBLMRAW	HBLFRAW
	Green	HBLMRAGN	HBLFRAGN
	Red	HBLMRAR	HBLFRAR
	Blue	HBLMRABL	HBLFRABL
	Brown	HBLMRABN	HBLFRABN
	Orange	HBLMRAO	HBLFRAO
	Yellow	HBLMRAY	HBLFRAY
	Gray*	—	—

Note: *Gray is available upon request. Contact factory.

Receptacles, Stud Type Threaded Hole Mounting



Description	Color	Male Receptacles	Female Receptacles
400 amp Panel Mount, thermoplastic elastomer, mates with 300 and 400 amp Inlines.	Black	HBLMRSCBK	HBLFRSCBK
	White	HBLMRSCW	HBLFRSCW
	Green	HBLMRSCGN	HBLFRSCGN
	Red	HBLMRSCR	HBLFRSCR
	Blue	HBLMRSCBL	HBLFRSCBL
	Brown	HBLMRSCBN	HBLFRSCBN
	Orange	HBLMRSCO	HBLFRSCO
	Yellow	HBLMRSCY	HBLFRSCY

Receptacles, Extended Stud Type Threaded Hole Mounting



Description	Color	Male Receptacles	Female Receptacles
400 amp Panel Mount, thermoplastic elastomer, mates with 300 and 400 amp Inlines.	Black	HBLMRSCEBK	HBLFRSCEBK
	White	HBLMRSCEW	HBLFRSCEW
	Green	HBLMRSCEGN	HBLFRSCEGN
	Red	HBLMRSCEER	HBLFRSCEER
	Blue	HBLMRSCEBL	HBLFRSCEBL
	Brown	HBLMRSCEBN	HBLFRSCEBN
	Orange	HBLMRSCEO	HBLFRSCEO
	Yellow	HBLMRSCEY	HBLFRSCEY

Receptacles, Stud Type Through Hole Mounting



Description	Color	Male Receptacles	Female Receptacles
400 amp Panel Mount, thermoplastic elastomer, mates with 300 and 400 amp Inlines.	Black	HBLMRSBK	HBLFRSBK
	White	HBLMRSW	HBLFRSW
	Green	HBLMRSGN	HBLFRSGN
	Red	HBLMRSR	HBLFRSR
	Blue	HBLMRSBL	HBLFRSBL
	Brown	HBLMRSBN	HBLFRSBN
	Orange	HBLMRSO	HBLFRSO
	Yellow	HBLMRSY	HBLFRSY

Angled Receptacles, Stud Type Through Hole Mounting



Description	Color	Male Receptacles	Female Receptacles
400 amp Panel Mount, thermoplastic elastomer, mates with 300 and 400 amp Inlines.	Black	HBLMRASBK	HBLFRASBK
	White	HBLMRASW	HBLFRASW
	Green	HBLMRASGN	HBLFRASGN
	Red	HBLMRASR	HBLFRASR
	Blue	HBLMRASBL	HBLFRASBL
	Brown	HBLMRASBN	HBLFRASBN
	Orange	HBLMRASO	HBLFRASO
	Yellow	HBLMRASY	HBLFRASY

Series 16 - 300 and 400 Amp, 600 Volts

Enclosure Types
3R, 4X, 12

Receptacles, Bus Bar Threaded Hole Mounting



Description	Color	Male Receptacles	Female Receptacles
400 amp Panel Mount, thermoplastic elastomer, mates with 300 and 400 amp Inlines.	Black	HBLMRBBK	HBLFRBBK
	White	HBLMRBW	HBLFRBW
	Green	HBLMRBGN	HBLFRBGN
	Red	HBLMRBR	HBLFRBR
	Blue	HBLMRBBL	HBLFRBBL
	Brown	HBLMRBBN	HBLFRBBN
	Orange	HBLMRBO	HBLFRBO
	Yellow	HBLMRBY	HBLFRBY

Angled Receptacles, Bus Bar Through Hole Mounting



Description	Color	Male Receptacles	Female Receptacles
400 amp Panel Mount, thermoplastic elastomer, mates with 300 and 400 amp Inlines.	Black	HBLMRABBK	HBLFRABBK
	White	HBLMRABW	HBLFRABW
	Green	HBLMRABGN	HBLFRABGN
	Red	HBLMRABR	HBLFRABR
	Blue	HBLMRABBL	HBLFRABBL
	Brown	HBLMRABBN	HBLFRABBN
	Orange	HBLMRABO	HBLFRABO
	Yellow	HBLMRABY	HBLFRABY

Receptacles, Bus Bar, 2 Holes Threaded Hole Mounting



Description	Color	Male Receptacles	Female Receptacles
400 amp Panel Mount, thermoplastic elastomer, mates with 300 and 400 amp Inlines.	Black	HBLMRB2BK	HBLFRB2BK
	White	HBLMRB2W	HBLFRB2W
	Green	HBLMRB2GN	HBLFRB2GN
	Red	HBLMRB2R	HBLFRB2R
	Blue	HBLMRB2BL	HBLFRB2BL
	Brown	HBLMRB2BN	HBLFRB2BN
	Orange	HBLMRB2O	HBLFRB2O
	Yellow	HBLMRB2Y	HBLFRB2Y

Terminals, Offset Straight Style



Description	Color	Male Receptacles	Female Receptacles
400 amp Terminal, thermoplastic elastomer, mates with 300 and 400 amp Inlines.	Black	HBLMOSBK	HBLFOSBK
	White	HBLMOSW	HBLFOSW
	Green	HBLMOSGN	HBLFOSGN
	Red	HBLMOSR	HBLFOSR
	Blue	HBLMOSBL	HBLFOSBL
	Brown	HBLMOSBN	HBLFOSBN
	Orange	HBLMOSO	HBLFOSO
	Yellow	HBLMOSY	HBLFOSY

Note: Terminals are UL Type 1 only.

Angled Terminals, Offset Straight Style



Description	Color	Male Receptacles	Female Receptacles
400 amp Terminal, thermoplastic elastomer, mates with 300 and 400 amp Inlines.	Black	HBLMOABK	HBLFOABK
	White	HBLMOAW	HBLFOAW
	Green	HBLMOAGN	HBLFOAGN
	Red	HBLMOAR	HBLFOAR
	Blue	HBLMOABL	HBLFOABL
	Brown	HBLMOABN	HBLFOABN
	Orange	HBLMOAO	HBLFOAO
	Yellow	HBLMOAY	HBLFOAY

Note: Angled terminals are UL Type 1 only.

Protective Caps



Color	Fits Male Devices	Fits Female Devices
Black	HBLMCAPBK	HBLFCAPBK
White	HBLMCAPW	HBLFCAPW
Green	HBLMCAPGN	HBLFCAPGN
Red	HBLMCAPR	HBLFCAPR
Blue	HBLMCAPBL	HBLFCAPBL
Brown	HBLMCAPBN	HBLFCAPBN
Orange	HBLMCAPO	HBLFCAPO
Yellow	HBLMCAPY	HBLFCAPY

Weather Protective Lift Covers



Color	Catalog Number	All One Color Caps and Bodies
Clear	HBLNCC	—
Black	HBLNCBK	HBLNCABK
White	HBLNCW	HBLNCAW
Green	HBLNCGN	HBLNCAGN
Red	HBLNCR	HBLNCAR
Blue	HBLNCBL	HBLNCABL
Brown	HBLNCBN	HBLNCABN
Orange	HBLNCO	HBLNCAO
Yellow	HBLNCY	HBLNCAY

Single Pole Devices and Temporary Power



Series 16 - 300 and 400 Amp, 600 Volts

Enclosure Types
3R, 4X, 12

Tees and 3-Fers



Color	Paralleling Tee (Male-Male-Female)	Tapping Tee (Female-Male-Female)	3-Fer (Male-Female-Female-Female)	3-Fer (Female-Male-Male-Male)	Soft 3-Fer (Male-Female-Female-Female)	Soft 3-Fer (Female-Male-Male-Male)
Black	HBLPTBK	HBLTBK	HBLM3FBK	HBLF3MBK	HBLM3FSBK	—
White	HBLPTW	HBLTW	HBLM3FW	HBLF3MW	—	—
Green	HBLPTGN	HBLTGN	HBLM3FGN	HBLF3MGN	—	HBLF3MSGN
Red	HBLPTR	HBLTR	HBLM3FR	HBLF3MR	—	—
Blue	HBLPTBL	HBLTBL	HBLM3FBL	HBLF3MBL	—	—
Brown	HBLPTBN	HBLTBN	HBLM3FBN	HBLF3MBN	—	—
Orange	HBLPTO	HBLTO	HBLM3FO	HBLF3MO	—	—
Yellow	HBLPTY	HBLTY	HBLM3FY	HBLF3MY	—	—

Gender Reversing Devices



Color	Double Male (Male-Male)	Double Female (Female-Female)
Black	HBLDMBK	HBLDFBK
White	HBLDMW	HBLDFW
Green	HBLDMGN	HBLDFGN
Red	HBLDMR	HBLDFR
Blue	HBLDMBL	HBLDFBL
Brown	HBLDMBN	HBLDFBN
Orange	HBLDMO	HBLDFO
Yellow	HBLDMY	HBLDFY

Distribution Block



Description	Color	(1-Male, 6-Females)
400 amp Distribution Block, Single Conductor, Heavy Duty Industrial Grade, Pre-Wired, (1) Male to (6) Females.	Black	HBL7DBBK
	White	HBL7DBW
	Green	HBL7DBGN
	Red	HBL7DBR
	Blue	HBL7DBBL
	Brown	HBL7DBBN
	Orange	HBL7DBO
Yellow	HBL7DBY	

Replacement Bodies (10 Pack)



Color	Male Body	Female Body
Black	HBLMBBK	HBLFBBK
White	HBLMBW	HBLFBW
Green	HBLMBGN	HBLFBGN
Red	HBLMBR	HBLFBR
Blue	HBLMBBL	HBLFBBL
Brown	HBLMBBN	HBLFBBN
Orange	HBLMBO	HBLFBO
Yellow	HBLMBY	HBLFBY

Replacement Contacts (20 Pack)



Description	Male Pin	Female Sleeve
Contact, 300 amp	HBL300RCM	HBL300RCF
Contact, 400 amp	HBL400RCM	HBL400RCF

Snap Back Covers (3R Only)



Color	Through Hole Mounting	Threaded Mounting Holes
Black	HBLSCBK	HBLSCCBK
White	HBLSCW	HBLSCCW
Green	HBLSCGN	HBLSCCGN
Red	HBLSCR	HBLSCCR
Blue	HBLSCBL	HBLSCCBL
Brown	HBLSCBN	HBLSCCBN
Orange	HBLSCO	HBLSCCO
Yellow	HBLSCY	HBLSCCY

Accessories



Description	Catalog Number
Accessory Kit, retaining screw, copper foil, terminal screws and brass wire.	HBLPK
Replacement retaining screw (500 pack).	HBLRS
Copper foil (500 pack).	HBLCF
Brass wire (500 pack).	HBLBW
Terminal screw - inline (500 pack).	HBLTS
Terminal screw - panel mount (500 pack).	HBLTSR

Single Pole Devices and Temporary Power

Series 16 - 300 and 400 Amp, 600 Volts

Specifications

Electrical	Series 16	
Voltage Ratings	600V Maximum	
Amperage Rating	400A Maximum	
Mechanical	300A	400A
Terminal Accommodation	Inline: #6 to 2/0 AWG	Inline: 2/0 to 4/0 AWG Recept.: #4 to 4/0 AWG
Product ID	Ratings are a permanent part of device	
Base Compound	Thermoplastic Elastomer (TPE)	
Contact Material	Brass	
Retaining Screw Material	Nylon	

Certification / Environmental

UL and cUL Listed
 UL Enclosure Types 3R, 4X, 12
 UL1691 standard for single pole locking-type separable connectors
 National Electric Code (NEC), ANSI/NFPA 70
 Flammability: HB per UL94 or CSA 22.2. 0.17

Conductor Ampacity Chart (Type SC/PPC Wire)

Cable Size	Ampacity*	Cable Size	Ampacity*
#6	105	2/0	300
#4	140	4/0	405
#2	190		

Note: *90°C column NEC Table 400.5(A)(2).

Dimensions

Inlines

Description	A	B	C	D
Male	7.01" (178.0)	1.38" (35.1)	1.48" (37.6)	4.78" (121.4)
Female	7.10" (180.5)	1.44" (36.6)	1.06" (27.0)	4.90" (121.3)

Inline (Male Shown)

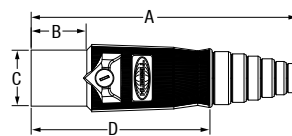

Snap Back Cover

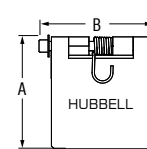

Threaded Stud (Male Shown)

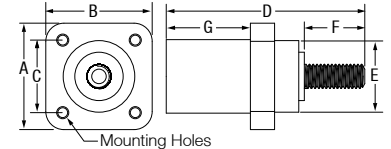

Panel Mount Receptacles

Threaded Stud	A	B	C	D	E	F	G	Mounting Hole	Termination
Male & Female with through hole mounting	2.20" (55.9)	2.20" (55.9)	1.50" (38.1)	4.10" (104.3)	1.48" (37.6)	1.25" (31.7)	1.74" (44.2)	Through 4x Ø .20"	1/2-13 UNC-2A Threaded Stud
Male & Female with threaded mounting holes	2.20" (55.9)	2.20" (55.9)	1.50" (38.1)	3.67" (93.2)	1.48" (37.6)	1.11" (28.2)	1.55" (39.4)	Threaded 4x #10-32	1/2-13 UNC-2A Threaded Stud
Double Set Screw	A	B	C	D	E	F	G	Mounting Hole	Termination
Male & Female with threaded mounting holes	2.20" (55.9)	2.20" (55.9)	1.50" (38.1)	4.10" (104.3)	1.48" (37.6)	1.36" (34.5)	1.74" (44.2)	Threaded 4x #10-32	(2) 7/32 Socket Head Set Screws
Bus Bar Type	A	B	C	D	E	F	G	Mounting Hole	Termination
Male & Female with threaded mounting holes	2.20" (55.9)	2.20" (55.9)	1.50" (38.1)	3.57" (90.7)	1.48" (37.6)	1.01" (25.7)	1.55" (39.4)	Threaded 4x #10-32	(1) 5/16-18 UNC-2B Threaded Hole
Offset Terminals	A	B	C	D	E	F	Mounting Hole	Termination	
Male terminal straight style	Ø 1.48" [37.6]	1.00" (25.4)	.38" (9.5)	3.89" (98.8)	1.75" (44.5)	2.14" (54.4)	Through .50" (12.7)	—	
Female terminal straight style	Ø 1.48" [37.6]	1.00" (25.4)	.38" (9.5)	3.68" (93.3)	1.75" (44.5)	1.93" (48.9)	Through .50" (12.7)	—	
Male terminal angled style	Ø 1.48" [37.6]	1.00" (25.4)	.38" (9.5)	3.98" (101.1)	2.06" (52.2)	2.14" (54.4)	Through .50" (12.7)	—	
Female terminal angled style	Ø 1.48" [37.6]	1.00" (25.4)	.38" (9.5)	3.76" (95.6)	2.06" (52.2)	1.93" (48.9)	Through .50" (12.7)	—	

Double Set Screw (Male Shown)

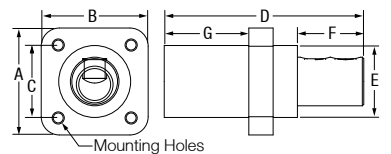

Bus Bar Type (Male Shown)

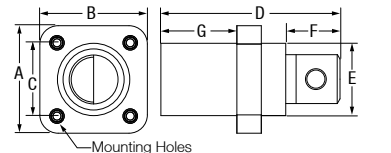

Offset Terminals (Male Shown)
Straight Style

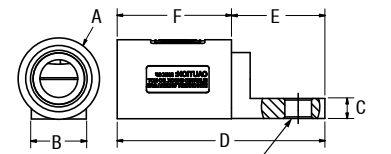

Angled Style

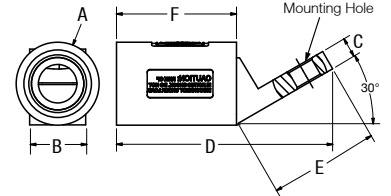

Covers

Description	A	B	C
Weatherproof Cover	2.20" (55.88)	1.16" (29.44)	2.03" (51.5)
Snap Back Cover to be used with receptacles	2.26" (57.4)	2.37" (60.2)	—

Weatherproof Cover

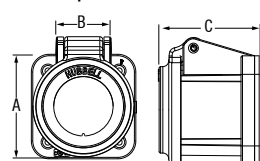

Gender Reversing Devices

Description	A	B	C
Double Male	4.65" (118.1)	1.48" (37.6)	—
Double Female	4.84" (122.9)	1.44" (36.6)	1.06" (27.0)

Gender Reversing - Double Male

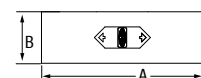

Gender Reversing - Double Female

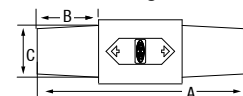

Tees and 3-Fers

Description	A	B	C
Tapping Tee	3.18" (80.8)	4.74" (120.4)	1.48" (37.6)
Paralleling Tee	3.18" (80.8)	4.65" (118.1)	1.48" (37.6)
3-Fer	5.88" (149.3)	5.78" (146.9)	1.48" (37.6)

Tapping Tee

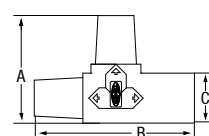

Paralleling Tee

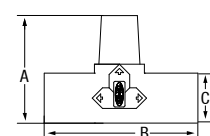

3-Fer

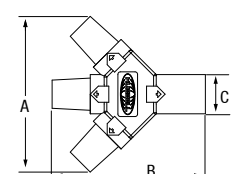

NEC® is a registered trademark of the National Fire Protection Association (NFPA).

Dimensions in Inches (mm)

Single Pole Devices and Temporary Power



Series 18 - 300 and 400 Amp, 600 Volts

Enclosure Types
3R, 4X, 12

- Enclosure Types 3R, 4X, 12
- Non-metallic safety retaining screw
- Easy to grip body design
- Accepts #6 to 4/0 AWG wire
- Replacement bodies available
- UL and cULus listed



300 Amp Inlines

Description	Color	Male Inline	Female Inline
Thermoplastic elastomer, cable size #6 - 2/0 AWG.	Black	HBL18300MBK	HBL18300FBK
	White	HBL18300MW	HBL18300FW
	Green	HBL18300MGN	HBL18300FGN
	Red	HBL18300MR	HBL18300FR
	Blue	HBL18300MBL	HBL18300FBL
	Brown	HBL18300MBN	HBL18300FBN
	Orange	HBL18300MO	HBL18300FO
	Yellow	HBL18300MY	HBL18300FY

400 Amp Inlines

Description	Color	Male Inline	Female Inline
Thermoplastic elastomer, cable size 2/0 - 4/0 AWG.	Black	HBL18400MBK	HBL18400FBK
	White	HBL18400MW	HBL18400FW
	Green	HBL18400MGN	HBL18400FGN
	Red	HBL18400MR	HBL18400FR
	Blue	HBL18400MBL	HBL18400FBL
	Brown	HBL18400MBN	HBL18400FBN
	Orange	HBL18400MO	HBL18400FO
	Yellow	HBL18400MY	HBL18400FY

Replacement Bodies (10 Pack)



Description	Color	Male Inline	Female Inline
Thermoplastic elastomer.	Black	HBL18MBBK	HBL18FBBK
	White	HBL18MBW	HBL18FBW
	Green	HBL18MBGN	HBL18FBGN
	Red	HBL18MBR	HBL18FBR
	Blue	HBL18MBBL	HBL18FBBL
	Brown	HBL18MBBN	HBL18FBBN
	Orange	HBL18MBO	HBL18FBO
	Yellow	HBL18MBY	HBL18FBY

Accessories



Description	Catalog Number
Series 18, replacement retaining screw (500 pack).	HBLRS
Copper foil (500 pack).	HBLCF
Brass wire (500 pack).	HBLBW

Specifications

Electrical	Series 18	
Voltage Ratings	600V Maximum	
Amperage Rating	400A Maximum	
Mechanical	300A	400A
Terminal Accommodation	Inline: #6 to 2/0 AWG	Inline: 2/0 to 4/0 AWG
Product ID	Ratings are a permanent part of device	
Base Compound	Thermoplastic Elastomer (TPE)	
Contact Material	Brass	
Retaining Screw Material	Nylon	

Certification / Environmental

Series 18
UL and cULus listed
UL Enclosure Types 3R, 4X, 12
UL 1691 standard for single pole locking-type separable connectors
National Electric Code (NEC), ANSI/NFPA 70
Flammability: HB per UL94 or CSA 22.2. 0.17

Conductor Ampacity Chart (Type SC/PPC Wire)

Cable Size	Ampacity*
#2	190
2/0	300
3/0	350
4/0	405

Note: *90°C column NEC Table 400.5(A)(2).

Dimensions

In Line Plugs

Description	A	B	C	D	E	F
Male	6.30" (159.9)	1.23" (31.1)	1.76" (44.6)	1.94" (49.3)	.77" (19.6)	.27" (6.9) (TYP)
Female	6.95" (176.5)	1.87" (47.6)	1.76" (44.6)	1.94" (49.3)	.77" (19.6)	.27" (6.9) (TYP)

Dimensions in Inches (mm)

Inline (Male)

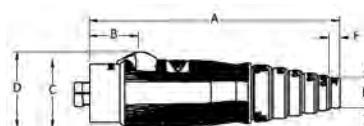

Inline (Female)

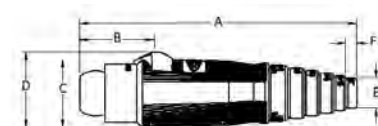

Single Pole Devices and Temporary Power

Features and Benefits

Spider® II Temporary Power Boxes

Hubbell's Spider® II temporary power distribution system sets the safety and performance standard for temporary power needs. Construction sites and outdoor events place more demands on electrical power than ever before. Hubbell's Spider box steps up to the challenge by offering advanced electrical and safety features. The Spider II box incorporates the most advanced ground fault module technology available in the industry today, ensuring safe and reliable distribution of electrical power for a wide variety of temporary power applications.

Breadth of line and durability, Hubbell manufactures a variety of Spider® II Boxes and temporary power products for both indoor and outdoor power and lighting applications. Hubbell's Spider products incorporate the most innovative wiring devices in the Hubbell Safety-Shroud® Twist-Lock® system. The shrouded Twist-Lock design extends the life of the plug by protecting the blades from abuse and more importantly, the shroud protects the user from arcing.



Housing Design

- Individual GFCI modules
- Gasketed latching receptacle lift covers
- Replaceable legs



Receptacles

- Six 20 amp straight blade or Twist-Lock® watertight receptacles, individually GFCI protected
- All Pin and Sleeve, Twist-Lock® and straight blade receptacles on each Spider box are protected when not in use by a gasketed, spring loaded flip lid



Safety

- Standard stab termination circuit breakers with gasketed lift cover
- Compact electronic supervisory circuit
- Detailed wiring diagram



Inlets

- Available with flush 50 amp Twist-Lock® inlet or 60 amp IEC reversed service Pin and Sleeve receptacle



Environmental Protection

- Spider® II boxes have earned a Type 3R metallic enclosure rating and heavy duty, abuse resistant legs for outdoor rainproof applications
- Provides UL Type 4X rating when the receptacles are used with Watertight Safety-Shroud® Twist-Lock® plugs



Certifications

- Hubbell's Spider® II Boxes meet NEC® requirements for personal protection against electrical shock on job sites and are listed to the latest UL1640 standard for portable power distribution equipment

NEC® is a registered trademark of the National Fire Protection Association (NFPA).

Single Pole Devices and Temporary Power

50A and 60A Spider® II Boxes



50A Spider® II



60A Spider® II



60A Class "L" Spider® II

Spider® II Temporary Power Boxes

Rating	Type	Qty	Receptacle Ratings	Receptacle Components	Protection		Catalog Number
					Overload	GFI	
30A, 120/240V AC (Maximum)	Straight Blade	7	20A, 125V	HBL53R61	Yes	Yes	SDSB1A
	Twist-Lock® (inlet)	1	30A, 120/240V	HBL2715SWR	No	No	
	Twist-Lock® (outlet)	1	30A, 120/240V	HBL2710	No	No	
50A, 120/240V AC (Maximum)	Straight Blade	7	20A, 125V	HBL53R61	Yes	Yes	SBSB1A
	Twist-Lock® (inlet)	1	50A, 125/250V	HBL6375S	No	No	
	Twist-Lock® (outlet)	1	50A, 125/250V	CS6369	No	No	
50A, 120/240V AC (Maximum)	Straight Blade	6	20A, 125V	HBL53R61	Yes	Yes	SBSB2
	Twist-Lock®	1	30A, 250V	HBL2620SW	Yes	Yes	
	Twist-Lock® (inlet)	1	50A, 125/250V	HBL6375S	No	No	
	Twist-Lock® (outlet)	1	50A, 125/250V	CS6369	No	No	
50A, 120/240V AC (Maximum)	Twist-Lock®	7	20A, 125V	HBL2310SW	Yes	Yes	SBTL1A
	Twist-Lock® (inlet)	1	50A, 125/250V	HBL6375S	No	No	
	Twist-Lock® (outlet)	1	50A, 125/250V	CS6369	No	No	
50A, 120/240V AC (Maximum)	Twist-Lock®	6	20A, 125V	HBL2310SW	Yes	Yes	SBTL2
	Twist-Lock®	1	30A, 250V	HBL2620SW	Yes	Yes	
	Twist-Lock® (inlet)	1	50A, 125/250V	HBL6375S	No	No	
	Twist-Lock® (outlet)	1	50A, 125/250V	CS6369	No	No	
60A, 3Ø 120/208V AC (Maximum)	Straight Blade	6	20A, 125V	HBL53R61	Yes	Yes	SCSB0*
	Pin and Sleeve (inlet)	1	60A, 3ØY 120/208V	HBL560B9R	No	No	
	Pin and Sleeve (outlet)	1	60A, 3ØY 120/208V	HBL560R9W	No	No	
60A, 3Ø 120/208V AC (Maximum)	Twist-Lock®	6	20A, 125V	HBL2310SW	Yes	Yes	SCTL0*
	Pin and Sleeve (inlet)	1	60A, 3ØY 120/208V	HBL560B9R	No	No	
	Pin and Sleeve (outlet)	1	60A, 3ØY 120/208V	HBL560R9W	No	No	

Class "L" Spider® II Temporary Power Boxes

Rating	Type	Qty	Receptacle Ratings	Receptacle Components	Protection		Catalog Number
					Overload	GFI	
60A, 3Ø 120/208V AC (Maximum)	Straight Blade	6	20A, 125V	HBL53R61	Yes	Yes**	SCSB0M2
	Class "L" (inlet)	1	60A, 3ØY, 120/208V	—	No	No	
	Class "L" (outlet)	1	60A, 3ØY, 120/208V	—	No	No	
60A, 3Ø 120/208V AC (Maximum)	Twist-Lock®	6	20A, 125V	HBL2310SW	Yes	Yes**	SCTL0M2
	Class "L" (inlet)	1	60A, 3ØY, 120/208V	—	No	No	
	Class "L" (outlet)	1	60A, 3ØY, 120/208V	—	No	No	

Note: *60A units are UL and cUL only.
**GFCI protection on 4 devices only.

Dimensions

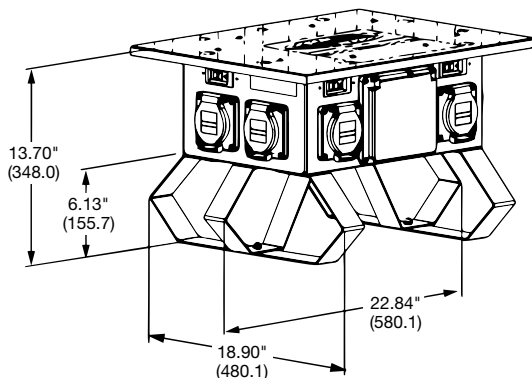

Dimensions in Inches (mm)

Specifications

Spider® II

Listing/Certification	UL1640 cUL and CSA, UL943
Environment	Indoor and outdoor wet and dry locations
Enclosure Type	3R, rainproof, suitable for use in damp locations
Code Compliance	NEC®, ANSI/NFPA 70

NEC® is a registered trademark of the National Fire Protection Association (NFPA).

Single Pole Devices and Temporary Power

Features and Benefits

Temporary Power Accessories

Hubbell's SR50 is comprised of a pre-wired 50A receptacle, mounted in a fully non-metallic watertight FD wall box.

This weather resistant, UL listed, assembly provides significant labor savings for the contractor, because it's pre-wired with a 50A Twist-Lock® receptacle, installation time is significantly reduced. The 4 hole mounting pattern of the new FD box also provides added security for the device.



Cable Sets, Plugs, and Receptacles

Description	Catalog Number
50A pre-wired wall mounted receptacle, with 2 ft. wire leads.	SR50
50A cord set - 50 ft. cable (input/output).	SCB50
50A cord set - 100 ft. cable (input/output).	SCB100
60A, 3Ø 120/208V Pin and Sleeve reversed service plug (female).	HBL560P9WR
60A, 3Ø 120/208V Pin and Sleeve plug (male).	HBL560P9W
60A, 3Ø 120/208V Pin and Sleeve wall mounted receptacle.	HBL560R9W
1¼" hub 15 deg. non-metallic angle back box for 60A receptacle.	BB601W
1½" hub 15 deg. metallic 4-way angle back box for 60A receptacle.	FW60100

Note: Consult factory for alternate cable lengths.



SR50

Replacement Parts

Description	Catalog Number
20A, 125V straight blade receptacle.	HBL53R61
20A, 125V Safety-Shroud Twist-Lock® receptacle.	HBL2310SW
30A, 250V Safety-Shroud Twist-Lock® receptacle.	HBL2620SW
30A, 125/250V Reverse Service Safety-Shroud connector.	HBL2713SR
30A, 125/250V Reverse Service inlet.	HBL2715SWR
50A, 125/250V Twist-Lock® receptacle.	CS6369
50A, 125/250V Twist-Lock® inlet.	HBL6375S
60A, 3Ø 120/208V Pin and Sleeve reversed service receptacle (inlet).	HBL560B9R
60A, 3Ø 120/208V Pin and Sleeve receptacle (outlet).	HBL560R9W
60A, 3Ø 120/208V Pin and Sleeve reversed service plug (female).	HBL560P9WR
60A, 3Ø 120/208V Pin and Sleeve plug (male).	HBL560P9W
GFCI module.	GFMST20
50A Spider supervisory kit.	SSK
60A Spider supervisory kit.	SSK60
Spider circuit breaker cover.	SCBC
Spider leg kit.	SLK
Spider leg kit, green.	SLKG
50A receptacle cover plate.	HBL77CM74WO



SCB50



HBL560R9W



HBL2310SW



SCBC



GFMST20



SSK



HBL77CM74WO



CS6369



HBL2713SR

Single Pole Devices and Temporary Power

Features and Benefits

Temporary Power Distribution Boxes and Temporary Power Cables

- Durable hi-visibility yellow powder coated steel construction
- Hubbell 50 amp Twist-Lock® receptacle and inlet
- Six 20 amp straight blade or Twist-Lock® covered receptacles
- Individual GFCI modules
- NEMA 3R enclosure
- Nesting leg design saves space in the warehouse and on the truck



TPDL – Twist-Lock®
TPDS – Straight Blade



TPC50 – 50' Cable
TPC100 – 100' Cable



Temporary Power Distribution Boxes

Rating	Type	Qty	Receptacle Rating	Protection		Catalog Number
				Overload	GFI	
50A, 120/240V AC (Maximum)	Twist-Lock®	6	20A, 125V	Yes	Yes	TPDL
	Twist-Lock®	1	30A, 250V	Yes	No	
	Twist-Lock® (Inlet)	1	50A, 125/250V	No	No	
	Twist-Lock® (Outlet)	1	50A, 125/250V	No	No	
50A, 120/240V AC (Maximum)	Straight Blade	6	20A, 125V	Yes	Yes	TPDS
	Twist-Lock®	1	30A, 250V	Yes	No	
	Twist-Lock® (Inlet)	1	50A, 125/250V	No	No	
	Twist-Lock® (Outlet)	1	50A, 125/250V	No	No	
Replacement GFCI module.						HBLCGFM20

Temporary Power Cables

Rating	Cable Type	Length	Male Device	Female Device	Weatherproof		Catalog Number
					Boot		
50A, 125/250V	6/3, 8/1	50 ft.	CS6365L	CS6364L	No		TPC50
50A, 125/250V	6/3, 8/1	100 ft.	CS6365L	CS6364L	No		TPC100

Specifications

Boxes	
Listings/Certifications	UL1640, UL943
Operation	Indoor and outdoor wet and dry locations
Enclosure Type	3R, rainproof, suitable for use in damp locations
Code Compliance	NEC®, ANSI/NFPA 70

Cables	
Listings/Certifications	Connectors: UL/CSA; Cable: MSHA
Operation	Indoor and outdoor wet and dry locations

Dimensions

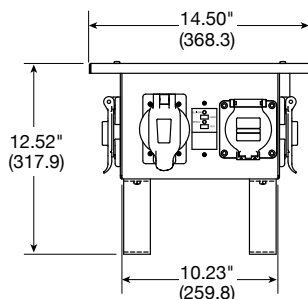

Dimensions in Inches (mm)

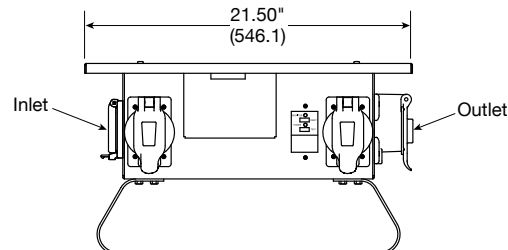

NEC® is a registered trademark of the National Fire Protection Association (NFPA).

Heavy-Duty Portable Outlet Boxes and Cover Plates

Description	Catalog Number
Box with cord strain relief, with one blank cover plate.	HBLPOB1
White box with cord strain relief, one blank white cover plate.	HBLPOB1L
Box with cord strain relief, with one blank cover plate, black.	HBLPOB1BK
Box with cord strain relief, with two duplex (indoor) cover plates.	HBLPOB1D
White box with cord strain relief, with two white duplex (indoor) cover plates.	HBLPOB1DL
Box with cord strain relief, with two duplex (indoor), yellow cover plates.	HBLPOB1DY
Blank, non-metallic FS cover plate with foam gasket, gray.	HBLP14FS
Blank, non-metallic FS cover plate with foam gasket, white.	HBLP14FSL
Duplex, non-metallic FS cover plate, gray	HBLP8FS
Duplex, non-metallic FS cover plate, white.	HBLP8FSL
Duplex, non-metallic FS cover plate, yellow.	HBLP8FSY
Single receptacle (1.39"), non-metallic FS cover plate, gray.	HBLP7FS
Single receptacle (1.56"), non-metallic FS cover plate, gray.	HBLP720FS
Rectangular opening, non-metallic FS cover plate, gray.	HBLP26FS
Rectangular opening, non-metallic FS cover plate, White.	HBLP26FSL



HBLPOB1



Cover Plates

Other Cover Plates and Devices

which may be used with Heavy-Duty Portable Outlet Boxes

Description	Catalog Number
Duplex cover plate, weatherproof.	HBL5221, HBL52CM21
Single receptacle (1.39") cover plate, weatherproof.	HBL7423WO, HBL74CM23WO
Single receptacle (1.56") cover plate, weatherproof.	HBL7425WOA, HBL74CM25WOA
Safety-Shroud Twist-Lock® surface receptacles.	HBL2310SR, HBL2320SR, HBL2330SR, HBL2610SR, HBL2620SR

Note: Standard product gray, CM yellow.

Deluxe Cord Grips Straight Male Thread

Nylon Fittings, Stainless Steel Mesh, Liquidtight, for Insulated Cables

Grip Diameter Range Inches (mm)	Thread Size NPT (inches)	Form Size	Catalog Number
.375"-.500" (9.5-12.7)	3/4"	F3	074011335
.500"-.625" (12.7-15.9)	3/4"	F3	074011336
.625"-.750" (15.9-19.0)	3/4"	F3	074011337



Deluxe Cord Grips
(purchased separately)

Gray Nylon Cord Connector Straight Male Thread

Grip Diameter Range Inches (mm)	Thread Size NPT (inches)	Form Size	Catalog Number
.375"-.500" (9.5-12.7)	3/4"	F3	SHC1035CR
.500"-.625" (12.7-15.9)	3/4"	F3	SHC1036CR
.625"-.750" (15.9-19.0)	3/4"	F3	SHC1037CR



**Gray Nylon
Cord Connector**

Specifications for Heavy-Duty Portable Outlet Boxes and Cover Plates

UL Listed	UL514C, UL467 and UL50 Enclosures Types 1, 3R.
CSA Certified	94 Enclosures Types 1, 3R and C22.2 No. 0.4 (Impedance).
Box Specifications:	
Moisture Resistance	Wet and damp locations, enclosure Type 3R when used with weatherproof cover plates; Dry, indoors locations, enclosure Type 1 with all other cover plates
Flammability	UL94V-0, 94-5VA classification
Operating Temperature	80°C maximum; -35°C minimum
UV Resistance	All materials are UV stabilized
Impact and Crush Resistance	In accordance with UL514C, UL50, C22.2 No. 18 and C22.2 No. 94
Material	Valox®
Cord Connector Materials	Nylon nut; nylon Gotcha® ring; neoprene grommet
Cord Diameter Range	.38" to .75" diameter
Bonding Strap Material	Brass
Threaded Inserts	Brass
Grounding Screw Material	Brass
Indoor Cover Plate Screws Material	Zinc plated steel
Outdoor Cover Plate Screws Material	Stainless steel
Cover Plate Gasket Material	UL recognized closed-cell foam (aging and oil resistant)

Dimensions

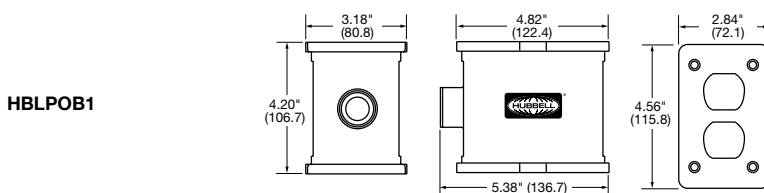

HBLPOB1

Valox® is a trademark of SABIC Innovative Plastics, acquired from General Electric Company.

Dimensions in Inches (mm)

Single Pole Devices and Temporary Power

Construction Site Lighting

Hubbell's outdoor approved construction site lighting line includes light strings for working in rugged environments.

We have light strings for all applications in a variety of models as well as a choice of metal or plastic guards. Light sockets are spaced 10 feet apart and all sockets, plugs, and connectors are molded for added durability. In addition, the highly impact-resistant material makes for easy transportation and storage when not in use. Bulbs can be incandescent, fluorescent or LED. Consider choosing LED lighting for a durable bulb that saves energy, provides instant illumination and are rated to last 50,000 hours.



HBL182S50LEDH



HBL143SJ100PS



HBLSTMC



HBLSTMG



HBLSTPG

LED Stringer Lights

Description	No. of Fixtures	Rating	Cord Type	Lumen Output	Cord Length	Catalog Number
90 LEDs per fixture, light string with magnetic base included.	1	15A 125V	#18/2 SJTW	450*	20 ft.	HBL182S20LED
90 LEDs per fixture, light string.	5	15A 125V	#18/2 SJTW	450*	50 ft.	HBL182S50LED
	10	15A 125V	#18/2 SJTW	450*	100 ft.	HBL182S100LED
60 LEDs per fixture, light string with magnetic base included.	1	15A 125V	#18/2 SJTW	1,100*	20 ft.	HBL182S20LEDH
	5	15A 125V	#18/2 SJTW	1,100*	50 ft.	HBL182S50LEDH
Magnetic clip bracket for LED light string.						HBLSTMC

Note: *Lumens per fixture.

A Type (Edison) Twist-Lock® and Straight Blade Light Strings

Description	Max Watts**	Rating	Cord Type	Fixtures	Cord Length	Catalog Number
Twist-Lock® light string; plastic guards.	150	20A 125V	#12/3 STJW	10	100 ft.	HBL123SJ100PT
Straight Blade light string; plastic guards.	150	15A 125V	#14/2 STJW	10	100 ft.	HBL142SJ100PS
	150	15A 125V	#14/3 STJW	10	100 ft.	HBL143SJ100PS
	150	15A 125V	#12/3 STJW	10	100 ft.	HBL123SJ100PS
Replacement plastic guard for temporary light strings.						HBLSTPG
Replacement heavy duty metal guard for temporary light strings.						HBLSTMG

Note: **Max watts per fixture. **HBL143SJ100PS** light strings are rated for 1875 Watts total. The total wattage must be considered when daisy chaining light strings to each other.

Maintenance and Work Lights

Choose Hubbell industrial work lights for maximum user safety. Portable work lights can be transported and re-mounted. Long cords allow free movement in work space.



LED Maintenance Worklights

Description	Outlet Rating	Rating	Wattage	Lumen Output	Cord Type	Cord Length	Catalog Number
LED Industrial maintenance light, 1 vertical hanging hook included.	N/A	15A 125V	20	2400	#16/3 SJEOW	25 ft.	HBLML2825L
LED worklight with end light feature.	N/A	15A 125V	9	920/120	#18/2 SJTOW	25 ft.	HBLWL25LED
LED worklight with end light feature and tool tap.	12 Amp	15A 125V	9	920/120	#16/3 SJTOW	25 ft.	HBLWL25LEDT



HBLML2825L



HBLWL25LED

Stage Pin Devices

Features and Benefits



20, 60 & 100 Amp Stage Pin Devices

Drawing on over a hundred years of expertise, Hubbell Wiring Device-Kellems sets the standard for innovation, performance, durability, safety and convenience. Our philosophy is never leaving well enough alone. We believe we can always make our products better—and the record shows we have.

When it comes to stage pin products, we listened...

The result is a removable sleeve that is highly heat stable and heat resistant. It does not allow the heat generated at the connection to negatively impact the device. Like phenolic devices of the past, this modern innovation will provide for a cool running device that is simple and convenient to wire.

The super tough engineered thermoplastic enclosure makes the device:

- Lightweight
- Impact resistant
- Easy to handle

Our design delivers 'The Best of Both Worlds!'



Male Inline
(Open to Show Contacts)



Housing Design

- Durable thermoplastic construction is lightweight, highly durable thermoplastic body for maximum impact resistance
- Ergonomic shape for easy insertion and withdrawal from mating devices



Contacts

- High performance brass contacts provide improved performance and extended life by reducing operating temperatures
- Heat resistant sleeves patent pending, highly stable and heat resistant contact shrouds provide phenolic functionality with a modern twist



Safety

- Highly secure terminations, stainless steel double set screws with fine pitch threads maximize termination strength for cooler running connections
- Ring terminal and double set screw termination options are available for 60A and 100A panel mounts



Wiring

- Simplified wiring, with removable contacts that snap back into place for greater wiring flexibility and simplicity
- Adjustable strain relief, accommodates the widest range of cables all in one device while exceeding UL requirements

Single Cable Sets and Breakouts in One Device

Device	Cable Combination	Device	Cable Combination
60A/125V	(3) #6 SC	100A/125V	(2) #4 SC
	(6) #6 SC		(4) #4 SC
	(2) #4 SC		(2) #2 SC
	#8/3		#6/3 AWG
	#6/3		#4/3 AWG
	TYPE W		TYPE W
	SOOW		TYPE W
	TYPE W		TYPE W



20 Amp Stage Pin Devices

Description	Voltage	Termination	Color	Catalog Number
Male Inline	125V	Double Set Screw	Black	HBL20SPM
Male Inline Bulk Pack			Black	HBL20SPMOEM
Male Inline			Clear	HBL20SPMC
Female Inline	125V	Double Set Screw	Black	HBL20SPF
Female Inline Bulk Pack			Black	HBL20SPFOEM
Female Inline			Clear	HBL20SPFC
Male Panel Mount (Inlet)	125V	Double Set Screw	Black	HBL20SPMR
Female Panel Mount				HBL20SPFR



60 Amp Stage Pin Devices

Description	Voltage	Termination	Color	Catalog Number
Male Inline	125V	Double Set Screw	Black	HBL60SPM
Female Inline				HBL60SPF
Male Panel Mount	125V	Double Set Screw Ring Terminal	Black	HBL60SPMR
Female Panel Mount				HBL60SPFR
				HBL60SPMRRT
				HBL60SPFRRT



100 Amp Stage Pin Devices

Description	Voltage	Termination	Color	Catalog Number
Male Inline	125V	Double Set Screw	Black	HBL100SPM
Female Inline				HBL100SPF
Male Panel Mount	125V	Double Set Screw Ring Terminal	Black	HBL100SPMR
Female Panel Mount				HBL100SPFR
				HBL100SPMRRT
				HBL100SPFRRT
Male Inline	250V	Double Set Screw	Yellow	HBL106SPM
Female Inline				HBL106SPF
Male Panel Mount	250V	Double Set Screw Ring Terminal	Yellow	HBL106SPMR
Female Panel Mount				HBL106SPFR
				HBL106SPMRRT
				HBL106SPFRRT



Convention Center Pin and Sleeve Devices

Features and Benefits

Convention Center Pin and Sleeve Devices

Hubbell's newest offering of 60A, 4P 5W, 277/480V AC, pin and sleeve devices are specifically designed and built to meet the demanding needs of Convention Centers and provide reliable performance for power distribution.

These devices are certified to UL 1682 & UL 2305, with a light-weight, low profile, polycarbonate construction, that mate with the current installed base, and are able to accept both round and flat cable.



Housing Design

- Manufactured in a durable light-weight polycarbonate construction to withstand heavy impact
- Full Line: Plug, Connector, Receptacle, and Inlet
- 60A, 4P 5W, 277/480V AC



Contacts

- Brass pins to maximize conductivity



Safety

- First to mate and last to break ground pin
- Mates with existing installed base



Wiring

- Single device that accepts both round and flat cable

Convention Center Pin and Sleeve Devices



HBL5607P



HBL5607C



HBL5607B



HBL5607R

Convention Center Pin and Sleeve Devices

Description	Catalog Number
Pin and Sleeve, 4P 5W, 60A 277/480V AC, Plug	HBL5607P
Pin and Sleeve, 4P 5W, 60A 277/480V AC, Connector	HBL5607C
Pin and Sleeve, 4P 5W, 60A 277/480V AC, Inlet	HBL5607B
Pin and Sleeve, 4P 5W, 60A 277/480V AC, Receptacle	HBL5607R

Specifications

Pole/Wire Configuration	4-pole, 5-wire grounding
Voltage Rating	60A, 277/480V AC
Material	Polycarbonate
Contacts	Brass

Product Dimensions Inches (mm)

Catalog Number	A	B	C	D
HBL5607P	6.36" (161.5)	3.46" (87.9)	—	—
HBL5607C	6.49" (164.8)	3.46" (87.9)	—	—
HBL5607B	3.75" (95.3)	3.37" (85.5)	2.38" (60.3)	3.25" (82.6)
HBL5607R	3.75" (95.3)	3.54" (89.9)	2.38" (60.3)	3.25" (82.6)

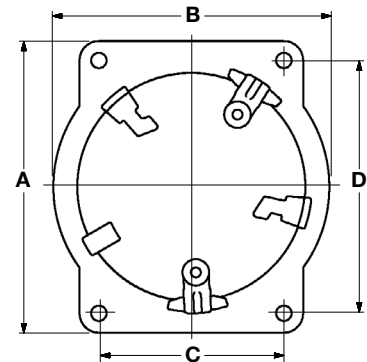
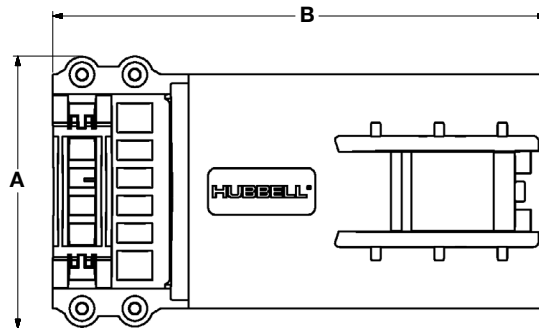

SECTION I

Table of Contents



LINKOSITY®
Power Components



MotorQuick®
Disconnect Switches





DRUB and PANEL-SAFE®



Product	Page
LINKOSITY® Power Components	
Power Components	I-2
Control Integration Components	I-3
Power System Distribution Assemblies	I-4
MotorQuick® Disconnect Switches	I-8
CableTrak® Hose and Cable Carrier System	I-9
CableTrak® Kit with and without Brackets	I-10
Accessories	I-11
Mounting Options and Specifications	I-12

Product	Page
DIN Rail Utility Box	
Power and Data	I-13
PANEL-SAFE®	
Features and Benefits	I-14
Power and Data Access Ports	I-15
HI-Impact	
Industrial Ethernet Connector and Harsh Environment Connectors	I-16

LINKOSITY® Power Components - Cables and Receptacles

Device Type	Ratings	Wires	Conductor Colors**	Length (FT)
 PH = Double Ended Cable with Male/Female Straight PM = Male Single Ended Straight PN = Male Single Ended 90° PF = Female Single Ended Straight PG = Female Single Ended 90° PQ = Double Ended Cable with Female 90° PR = Double Ended Cable with Male 90° PS = Double Ended Cable with (2) 90° Connectors  RF = Female Receptacle*  RM = Male Receptacle (Inlet)*	20 = 20A up to 600V	02 03 04 05	PA = Green/Yellow Black (all others)	001 = 1' 005 = 5' 010 = 10' 015 = 15' 020 = 20' 025 = 25' 030 = 30' 035 = 35' 040 = 40' 045 = 45' 050 = 50'
	23 = 20A up to 600V Specialty construction (Includes isolated ground on 6 wire and #10 AWG super neutral conductor on 5 and 6 wire devices, PB color code only)	03 04 05 06		
	30 = 30A up to 600V	04	PE = All Blue***	
Example: PH	23	06	PB	005

Note: *1/2" NPT rear thread.

**Other color codes available upon request.

***Two wire only.

Configurations (Male face view shown, female view is opposite)

20 AMP				
20A SNIG (with super neutral and IG)				
30 AMP				

Tees



TX2304002304T00

Description	Catalog Number
LINKOSITY® M/F/F Tee, 20A, 2P	TX2002002002T00
LINKOSITY® M/F/F Tee, 20A, 3P	TX2003002003T00
LINKOSITY® M/F/F Tee, 20A, 4P	TX2004002004T00
LINKOSITY® M/F/F Tee, 20A, 5P	TX2005002005T00
LINKOSITY® M/F/F Tee, 20A SNIG, 4P	TX2304002304T00
LINKOSITY® M/F/F Tee, 20A SNIG, 6P	TX2306002306T00
LINKOSITY® M/F/F Tee, 20A SNIG, A Phase Tap	TX2306002304A00
LINKOSITY® M/F/F Tee, 20A SNIG, B Phase Tap	TX2306002304B00
LINKOSITY® M/F/F Tee, 20A SNIG, C Phase Tap	TX2306002304C00
LINKOSITY® M/F/F Tee, 30A, 4P	TX3004003004T00



Closure Caps



CCMBC

Description	For use with Female Receptacle	Male Inlet
20A and 30A Receptacle Closure Cap	CCMBC	CCFBC

LINKOSITY® Control Integration Components - Cables and Receptacles

Device Type	Ratings	Wires	Conductor Colors**	Length (FT)
 PH = Double Ended Cable with Male/Female Straight PM = Male Single Ended Straight PN = Male Single Ended 90° PF = Female Single Ended Straight PG = Female Single Ended 90° PQ = Double Ended Cable with Female 90° PR = Double Ended Cable with Male 90° PS = Double Ended Cable with (2) 90° Connectors  RF = Female Receptacle*  RM = Male Receptacle (Inlet)*	03 = 3A - 2W, 4W up to 300V	02 04	PA = Green/Yellow Black (all others)	001 = 1' 005 = 5' 010 = 10' 015 = 15' 020 = 20' 025 = 25' 030 = 30' 035 = 35' 040 = 40' 045 = 45' 050 = 50'
	R3 = 3A - 2W, 3W, 4W up to 300V	02 03 04		
		10A - 2W, 3W, 4W, 5W 10 = 10A - 6W, 7W, 8W, 9W 7A - 10W, 12W up to 600V	02 03 04 05 06 07 08 09 10 12	PE = All Blue***

Example: PH

10

06

PB



005

Note: *1/2" NPT rear thread.

**Other color codes available upon request.

***Two wire only.

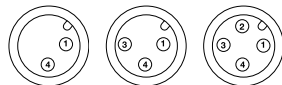
Configurations (Male face view shown, female view is opposite)

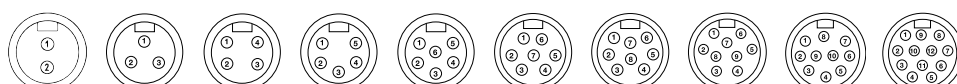
03		Typically used for inputs in DC control circuits
R3*		Typically used for outputs in DC control circuits
10		

Note: *Reverse key.

Splitters/Tees

Description	Catalog Number
LINKOSITY® M/F/F Splitter, 3A/4W	TX0304000304T00
LINKOSITY® M/F/F Tee, 10A, 2 Pole	TX1002001002T00
LINKOSITY® M/F/F Tee, 10A, 3 Pole	TX1003001003T00
LINKOSITY® M/F/F Tee, 10A, 4 Pole	TX1004001004T00
LINKOSITY® M/F/F Tee, 10A, 5 Pole	TX1005001005T00
LINKOSITY® M/F/F Tee, 10A, 6 Pole	TX1006001006T00



TX1004001004T00

Closure Caps

Description	For use with	
	Female Receptacle	Male Inlet
3A Closure Cap	CCM1C	CCF1C
10A Closure Cap, 2, 3, 4, 4, 5 and 6 Pole	CCMAC	CCFAC
10A Closure Cap, 7 and 8 Pole	CCMBC	CCFBC
10A Closure Cap, 9, 10, 12 Pole	CCMCC	CCFCC



CCFAC

Power System Distribution Assemblies

- Available with up to 5 receptacles, wide variety of NEMA receptacle types
- LINKOSITY® power pass through option
- Fed with LINKOSITY® power cable and receptacle
- 16 gauge sheet metal enclosure ANSI 61 gray powder coat NEMA 1
- Device identification marking
- Versatile mounting provision
- Local or master switch



MSL3L1IGP

Note: Accepts PH2304 series cables.

Straight Blade - UL Type 1

Device Type	Switch Types	# Recepts	Receptacle Type	Receptacle Feature	Pass-thru	Custom Configurations*
M	SL = Switch Local	1	SG = Spec Grade HG = Hospital Grade CR = Corrosion Resistant	IG = Isolated Ground GF = Ground Fault SS = Surge Suppression 00 = Standard	P = Pass-thru** 0 = No Pass-thru	D = 2 Circuit A = A Phase B = B Phase C = C Phase
	SM = Switch Master	2				
	00 = No Switch	3				
		4				
		5				

Example: **M SL 1 SG 00 P**

Twist-Lock® - UL Type 1

Device Type	Switch Types	# Recepts	Receptacle Type	Receptacle Feature	Pass-thru	Custom Configurations*
M	SL = Switch Local	1	L1 = 15A L2 = 20A	IG = Isolated Ground 00 = Standard	P = Pass-thru 0 = No Pass-thru	6 = 250V
	SM = Switch Master	2				
	00 = No Switch	3				
		4				
		5				

Example: **M 00 3 L1 IG 0**

Note: Local switches control all receptacles in a box. Master switches control local and downstream receptacles. Consult factory for alternate wiring schemes.

*Consult factory for wiring specifications and connecting cables.

**Pass-thru on phase tap boxes are 3Ø.

Switch Only (ON/OFF) - UL Type 1

Device Type	Switch Types	Switch Style	Poles
S	1 = 1 Gang	2W = ON/OFF	1P = Single Pole DP = Two Pole
	2 = 2 Gang		
	3 = 3 Gang		

Example: **S 1 2W 1P**

Switch Only (4-Way) - UL Type 1

Device Type	Switch Types	Switch Style
S	1 = 1 Gang	4W = 4 Way

Example: **S 1 4W**

Switch Only (3-Way) - UL Type 1

Device Type	Switch Types	Switch Style	Position
S	1 = 1 Gang	3W = 3 Way	M = Main R = Remote LM = Line to Main LR = Load to Remote

Example: **S 1 3W M**

Note: For use with Px2304PBxxx series cables.

Features

Receptacle Types	CR	HG	SG	L1
00 Standard	HBL53CM62	HBL8300GY	5362G	HBL4700
IG Isolated Ground	—	—	CR5352IGGY	IG4700A
GF Ground Fault	—	GFRST83GY	GFRST20GY	—
SS Surge Suppression	—	HBL8362GYSA	HBL5362GYSA	—
Switch Types	CR	HG	SG	L1
SL Local ON/OFF	—	—	HBL1221PL	—
SM Master ON/OFF	—	—	HBL1221PL	—

LINKOSITY® UL Type 3R and 4X Rated Assemblies

- Available with switch, ground fault, corrosion resistant or isolated ground receptacle types
- LINKOSITY® power pass through option
- Fed with LINKOSITY® power cable and receptacle
- UL Type 3R and 4X Rated
- Device identification marking
- Versatile mounting provision



LINKOSITY® Feed - UL Type 3R Rated*

3R Rated Standard Items

Description	Catalog Number
20A 125V Ground Fault	M3R002SGGF0
20A 125V Switched, Spec Grade	M3RSL1SG000
20A 125V Switched, Ground Fault	M3RSL1SGGF0
20A 125V Spec Grade	M3R002SG000
20A 125V Ground Fault, Pass-Thru	M3R002SGGFP
20A 125V Switched, Spec Grade, Pass-Thru	M3RSL1SG00P
20A 125V Switched, Ground Fault, Pass-Thru	M3RSL1SGGFP
20A 125V (2) Switches	M3R2SG000
20A 125V 1-Gang Ground Fault	M3R001SGGF0
20A 125V Corrosion Resistant	M3R002CR000
20A 125V Isolated Ground	M3R002SGIGP
20A 125V Spec Grade, Pass-Thru	M3R002SG00P

Note: *When cover closed.

Device Type	Style	Type	No. of Devices	Device Type	Device Feature	Pass-Thru
M	3R - 3R Lids	SL - Switch Local	1	SG - Spec Grade	IG - Isolated Ground	P - Pass-Thru
	3D - 3R Deep Cover	SM - Switch Master	2	HG - Hospital Grade	GF - Ground Fault	0 - No Pass-Thru
		00 - None		CR - Corrosion Resistant	SI - Surge/IG	
				L1 - 15A Locking	SS - Surge	
					00 - Standard	



Replacement Mounting Feet

Description	Catalog Number
For Power Distribution Assemblies.	HBLRFT1^Δ

Note: ^Δ Package of 10 mounting feet and 10 screws.



LINKOSITY® Feed - UL Type 4X Rated**

4X Rated NEMA Standard Items

Description	Catalog Number
20A 125V Straight Blade†	MLWF2010
20A 125V WTSSTL	MLWF2020
20A 125V Straight Blade, Pass-Thru	MLWF201P
20A 125V WTSSTL, Pass-Thru	MLWF202P
20A 125/250V WTSSTL, No Pass-Thru	MLWF2070
30A 125V WTSSTL, No Pass-Thru	MLWF1050
30A 250V WTSSTL, No Pass-Thru	MLWF1060
30A 125V WTSSTL, No Pass-Thru	MLWF2050
30A 250V WTSSTL, No Pass-Thru	MLWF2060



Device Type	Style	Type	No. of Devices	Device Type	Pass-Thru
M	L - LINKOSITY	WF - Watertight Safety-Shroud Receptacle	1	01 - 20A 125V Straight Blade†	P - Pass-Thru 0 - No Pass-Thru
			2	02 - 20A 125V Twist-Lock 03 - 20A 250V Twist-Lock 04 - 20A 277V Twist-Lock 05 - 30A 125V Twist-Lock 06 - 30A 250V Twist-Lock 07 - 20A 125/250V Twist-Lock 08 - 20A 3Ø 250V Twist-Lock 09 - 20A 3Ø 480V Twist-Lock 10 - 30A 125/250V Twist-Lock 11 - 30A 3Ø 250V Twist-Lock 12 - 30A 3Ø 480V Twist-Lock 13 - 30A 3Ø 600V Twist-Lock	
		WM - Watertight Safety-Shroud Inlet			

All LINKOSITY® - UL Type 4X Rated*

4X Rated LINKOSITY Standard Items

Description	Catalog Number
20A 3W up to 600V, 4 Port	M4L2003PB0
20A 3W up to 600V, 4 Port Pass-Thru	M4L2003PBP

Conduit Feed - UL Type 4X Rated**

Conduit Feed Standard Items

Description	Catalog Number
20A 125V Straight Blade	MCWF2010
20A 125V WTSSTL	MCWF2020
20A 250V WTSSTL	MCWF2030
20A 277V WTSSTL	MCWF2040
30A 125V WTSSTL	MCWF2050
30A 250V WTSSTL	MCWF2060
20A 125/250V WTSSTL	MCWF2070
20A 3Ø, 250V WTSSTL	MCWF2080
20A 3Ø, 480V WTSSTL	MCWF2090
30A 125/250V WTSSTL	MCWF2100
30A 3Ø 250V WTSSTL	MCWF2110
30A 3Ø 480V WTSSTL	MCWF2120
30A 3Ø 600V WTSSTL	MCWF2130



Device Type	Style	Type	No. of Poles	Conductor Colors	Pass - Thru
M	4L - LINKOSITY	20 - 20A	02	PA - Green/Yellow Black (all others)	P - Pass-Thru 0 - No Pass-Thru
			03		
		23 - 20A Super Neutral Isolated Ground	04	PB - Green/Yellow White Black (all others)	
			05		
06					
		30 - 30A			

Note: **Watertight Safety-Shroud® Twist-Lock® Plug required when in use.

†Straight Blade are UL Type 4X when not in use only.

•Closure cap required when not in use.

Accepts PH2304 series cables.

WTSSTL is an abbreviation for Watertight Safety-Shroud® Twist-Lock®.



Device Type	Style	Type	No. of Devices	NEMA Device Type	Pass-Thru
M	C - Conduit Feed	WF - Watertight Safety-Shroud Receptacles	2	01 - 20A 125V Straight Blade	0 - No Pass-Thru
				02 - 20A 125V Twist-Lock 03 - 20A 250V Twist-Lock 04 - 20A 277V Twist-Lock 05 - 30A 125V Twist-Lock 06 - 30A 250V Twist-Lock 07 - 20A 125/250V Twist-Lock 08 - 20A 3Ø 250V Twist-Lock 09 - 20A 3Ø 480V Twist-Lock 10 - 30A 125/250V Twist-Lock 11 - 30A 3Ø 250V Twist-Lock 12 - 30A 3Ø 480V Twist-Lock 13 - 30A 3Ø 600V Twist-Lock	
		WM - Watertight Safety-Shroud Inlet			



Replacement Mounting Feet

Description Catalog Number

For Power Distribution Assemblies. **HBLRFT1^Δ**

Note: ^Δ Package of 10 mounting feet and 10 screws.

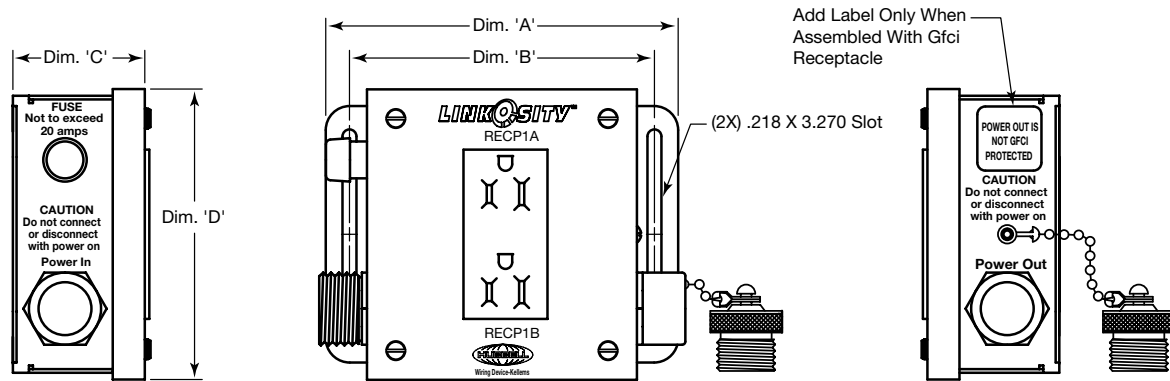

Catalog Number M001****P Shown

Catalog Number	Gangs	Dimension 'A'	Dimension 'B'	Dimension 'C'	Dimension 'D'
M001****P	1	5.50 (139.7)	4.75 (120.7)	2.25 (57.2)	4.53 (115.1)
M002****P	2	7.50 (190.5)	6.75 (171.5)	2.25 (57.2)	4.53 (115.1)
M003****P	3	9.50 (241.3)	8.75 (222.3)	2.25 (57.2)	4.53 (115.1)
M004****P	4	11.50 (292.1)	10.75 (273.1)	2.25 (57.2)	4.53 (115.1)
M005****P	5	13.50 (342.9)	12.75 (323.9)	2.25 (57.2)	4.53 (115.1)

LINKOSITY® Specifications

Certifications

System Level	ETL Classified to NEC
Component Assemblies (PSDA)	UL Listed
Connecting Components	Listed to UL2238 and UL 50
Cable (Up to #22 AWG)	UL 300V Type ITC/PLTC 105°C
Cable (#16 AWG and Up)	UL 600V Type TC-ER, MTW 90°C or ST00W 600V 105°C

Cable Diameter

Amps	Wires	O.D.
20	3	.595 (15.1)
20	4	.645 (16.4)
20	5	.710 (18.0)
20	6	.760 (19.3)
30	4	.710 (18.0)

Performance

Electrical

Voltage	Up to 600V
Amperage	Up to 30A

Environmental

Connectivity System Components

Moisture Resistance	UL Type 4, 4X, 12 and 13
Ingress Protection	IP66 Suitability
Flammability	UL94HB Cables/UL94V-0 receptacles

Power System Distribution Assemblies

Moisture Resistance	NEMA Type 1, Type 3R, Type 4X
---------------------	-------------------------------

Dimensions in Inches (mm)

MotorQuick® Disconnect Switches

Housing Design

- Thermoplastic Cover on Plated Steel Base
- NEMA 1 Enclosure
- Pre-wired with LINKOSITY® Components
- Crush and Impact Resistance of MC Cable



HBL1389MQ5

Housing Design

- High Impact Valox® Enclosure
- Type 4X Enclosure
- Permanent Labelless Marking
- Lockable Handle to Meet OSHA Lockout/Tagout Regulations
- Cable Ratings: TC-ER, MTW, STOOW

IP67
SUITABILITY



HBLDS3MQ5

MotorQuick® Disconnect Switches

Type 1 Non-Metallic Enclosure 30A 3 Pole 600V AC

HBL1389D with one pre-wired LINKOSITY® female receptacle (load side).

HBL1389D with 5 foot pre-wired LINKOSITY® female cable (load side).

HBL1389D with one pre-wired LINKOSITY® male receptacle (line side) and one pre-wired LINKOSITY® female receptacle (load side).

Catalog Number

HBL1389MQR

HBL1389MQ5

HBL1389MQR2

Type 4X Non-Metallic Labelless Enclosure 30A 3 Pole 600V AC

HBLDS3 with one pre-wired LINKOSITY® female receptacle (load side).

HBLDS3 with 5 foot pre-wired LINKOSITY® female cable (load side).

HBLDS3 with one pre-wired LINKOSITY® male receptacle (line side) and one pre-wired LINKOSITY® female receptacle (load side).

HBLDS3MQR

HBLDS3MQ5

HBLDS3MQR2

Type 4X Stainless Steel Enclosure 30A 3 Pole 600V AC

HBLDS3SS with one pre-wired LINKOSITY® female receptacle (load side).

HBLDS3SS with 5 foot pre-wired LINKOSITY® female cable (load side).

HBLDS3SS with one pre-wired LINKOSITY® male receptacle (line side) and one pre-wired LINKOSITY® female receptacle (load side).

Sloped Top

Square Top

HBLDS3SSRMQR **HBLDS3SSMQR**

HBLDS3SSRMQ5 **HBLDS3SSMQ5**

HBLDS3SSRMQR2 **HBLDS3SSMQR2**

Accessories

Description

3P 4W LINKOSITY® male receptacle for installation on motor.

3P 4W LINKOSITY® female receptacle for installation in switch.

3P 4W LINKOSITY® double ended (male/female) 5-50 foot cable.

3P 4W LINKOSITY® single ended (female) 5-50 foot cable.

Cord connector, 3/4 in. NPT .63-.75 in. (16.0-19.1) diameter.

Lock-on cover for LINKOSITY® connections.

Catalog Number

RM3004PA001

RF3004PA001

PH3004PAxxx*

PF3004PAxxx*

SHC1037CR

PH2030C

Note: *Cables available from 5-50 feet in 5 foot increments. To purchase larger cable, replace the **xxx** with the required length in feet. (Examples: **PH3004PA005** = 5 foot cable, **PH3004PA050** = 50 foot cable.)

Sample Set Up

(1) HBLDS3MQR + (1) PH3004PAxxx + (1) RM3004PA001 =

Total Set Up**



Note: ** Retrofit parts available for pre-existing disconnect switch installations. Please consult factory for availability.

Valox® is a trademark of SABIC Innovative Plastics, acquired from General Electric Company.



HBL1389MQR2



HBLDS3MQR



HBLDS3SSRMQR



HBLDS3SSMQR



PH2030C

CableTrak® Hose and Cable Carrier System

The design of CableTrak carriers provides easy access to components during installation and repair. The track's flip top design allows the installer to lay cable and hose components directly into the track instead of pulling them through the length of the track. Hubbell CableTrak carriers can be ordered as assembled kits with brackets or by the foot without brackets. The final length of the track is easily customized by adding or removing sections of track or individual links with a flat head screwdriver.

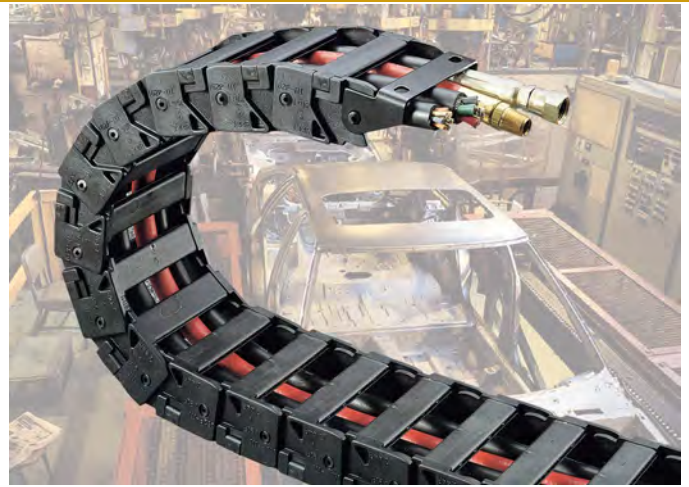

CableTrak® Installation

1. Unlock Tab.
2. Locking tabs secure the retaining bar into place.
To unlock tabs, slide a flat head screwdriver under the tab and release it with a twisting motion.

Access/Install Cables and Hoses

3. Easy access is important, especially for pre-assembled cable/hose sets involving large O.D. plugs, receptacles, and couplings.
4. Lock Tab.
5. To re-secure retaining bars, engage the hinge and snap the locking tab into place.

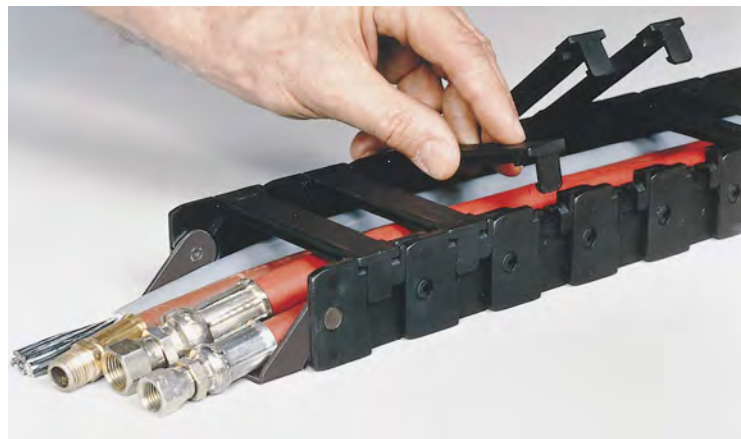
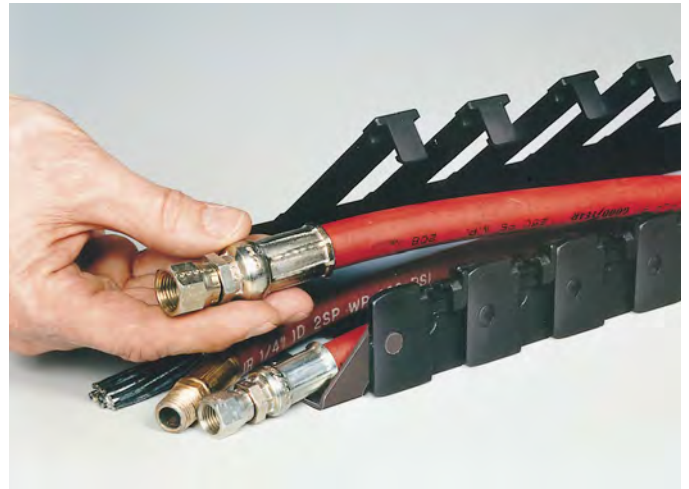
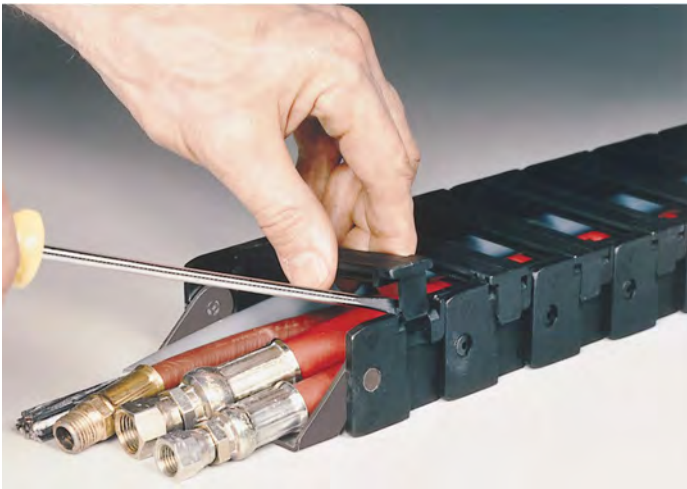

CableTrak® Kits

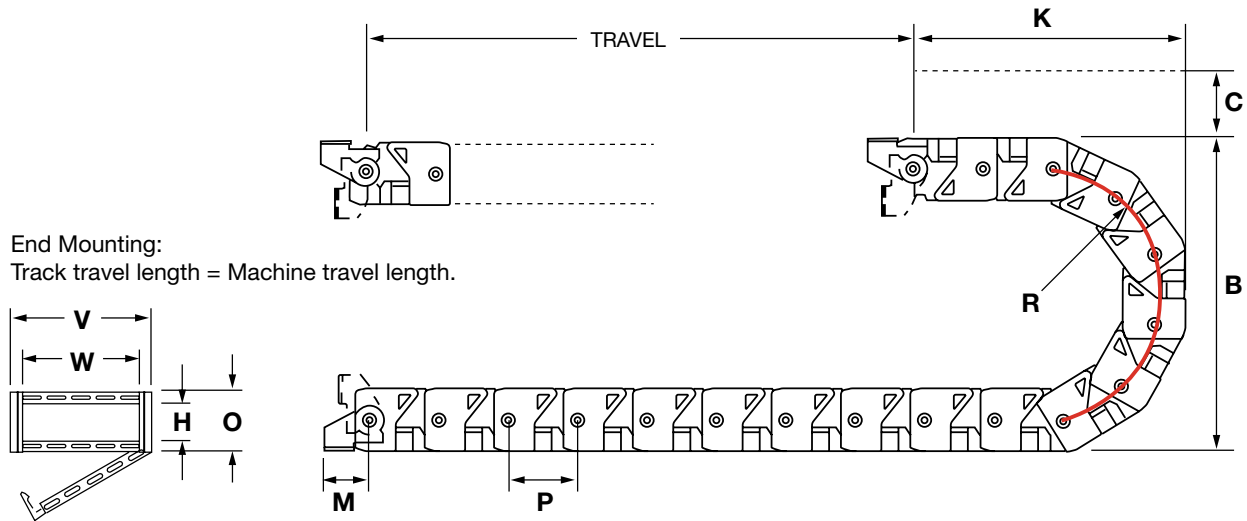

CableTrak® Kit with Brackets

Catalog Number	Track Length (ft)	W Inner Width	H Inner Height	A Max Hose/Cab O.D.	B Max Component Width	V Outer Width	O Outer Height	R Bend Radius	B Bend Height	C Clearance	K Min Brkt to Bend	M Brkt to Pivot	P Pitch	L* Curve Length (ft)
HCT10114K**	4.0'	0.59"	0.75"	0.286"	0.531"	1.03"	1.00"	1.44"	3.86"	2.00"	5.68"	1.33"	1.250"	1.000'
HCT10219K**	4.0'	1.00"	0.75"	0.382"	0.900"	1.44"	1.00"	1.91"	4.82"	2.00"	5.41"	1.33"	1.250"	1.000'
HCT16119K	4.0'	1.50"	1.00"	0.382"	1.350"	2.12"	1.62"	1.91"	5.44"	3.00"	5.72"	1.19"	1.812"	1.000'
HCT16134K	4.5'	1.50"	1.00"	0.688"	1.350"	2.12"	1.62"	3.44"	8.50"	3.00"	7.85"	1.19"	1.812"	1.500'
HCT16219K	4.0'	2.28"	1.00"	0.328"	2.052"	2.91"	1.62"	1.91"	5.44"	3.00"	5.72"	1.19"	1.812"	1.000'
HCT16234K	4.5'	2.28"	1.00"	0.688"	2.052"	2.91"	1.62"	3.44"	8.50"	3.00"	7.85"	1.19"	1.812"	1.500'
HCT16334K	4.5'	3.08"	1.00"	0.688"	2.772"	3.70"	1.62"	3.44"	8.50"	3.00"	7.85"	1.19"	1.812"	1.500'
HCT16434K	4.5'	4.06"	1.00"	0.688"	3.654"	4.69"	1.62"	3.44"	8.50"	3.00"	7.85"	1.19"	1.812"	1.500'
HCT25134K	4.5'	2.60"	1.75"	0.680"	2.340"	3.70"	2.50"	3.40"	9.30"	3.00"	8.31"	1.75"	2.500"	1.500'
HCT25234K	4.5'	4.25"	1.75"	0.680"	3.825"	5.36"	2.50"	3.40"	9.30"	3.00"	8.31"	1.75"	2.500"	1.500'
HCT25247K	5.0'	4.25"	1.75"	0.956"	3.825"	5.36"	2.50"	4.78"	12.06"	3.00"	10.52"	1.75"	2.500"	2.000'
HCT25347K	5.0'	6.60"	1.75"	0.956"	5.940"	7.70"	2.50"	4.78"	12.06"	3.00"	10.52"	1.75"	2.500"	2.000'

CableTrak® Kit without Brackets

Catalog Number	Track Length (ft)	W Inner Width	H Inner Height	A Max Hose/Cab O.D.	B Max Component Width	V Outer Width	O Outer Height	R Bend Radius	B Bend Height	C Clearance	P Pitch	L* Curve Length (ft)
HCT101141**	1.0'	0.59"	0.75"	0.286"	0.531"	1.03"	1.00"	1.44"	3.86"	2.00"	1.250"	1.000'
HCT102191**	1.0'	1.00"	0.75"	0.382"	0.900"	1.44"	1.00"	1.91"	4.82"	2.00"	1.250"	1.000'
HCT161191	1.0'	1.50"	1.00"	0.382"	1.350"	2.12"	1.62"	1.91"	5.44"	3.00"	1.812"	1.000'
HCT161341	1.0'	1.50"	1.00"	0.688"	1.350"	2.12"	1.62"	3.44"	8.50"	3.00"	1.812"	1.500'
HCT162191	1.0'	2.28"	1.00"	0.328"	2.052"	2.91"	1.62"	1.91"	5.44"	3.00"	1.812"	1.000'
HCT162341	1.0'	2.28"	1.00"	0.688"	2.052"	2.91"	1.62"	3.44"	8.50"	3.00"	1.812"	1.500'
HCT163341	1.0'	3.08"	1.00"	0.688"	2.772"	3.70"	1.62"	3.44"	8.50"	3.00"	1.812"	1.500'
HCT164341	1.0'	4.06"	1.00"	0.688"	3.654"	4.69"	1.62"	3.44"	8.50"	3.00"	1.812"	1.500'
HCT251341	1.0'	2.60"	1.75"	0.680"	2.340"	3.70"	2.50"	3.40"	9.30"	3.00"	2.500"	1.500'
HCT252341	1.0'	4.25"	1.75"	0.680"	3.825"	5.36"	2.50"	3.40"	9.30"	3.00"	2.500"	1.500'
HCT252471	1.0'	4.25"	1.75"	0.956"	3.825"	5.36"	2.50"	4.78"	12.06"	3.00"	2.500"	2.000'
HCT253471	1.0'	6.60"	1.75"	0.956"	5.940"	7.70"	2.50"	4.78"	12.06"	3.00"	2.500"	2.000'

Note: *L = Minimum length in feet to form CableTrak curve.

**These models do not have a flip top design and do not accept separators due to their small size.

Dimensions in Inches (mm)

Industrial Connectivity and Control Products

CableTrak® Accessories

Center Mounting: Mounting the fixed track end in the center of the machine travel allows the track to travel beyond the fixed end. Center mounting effectively doubles the travel distance of the track requiring half the track length of an end mounted application.

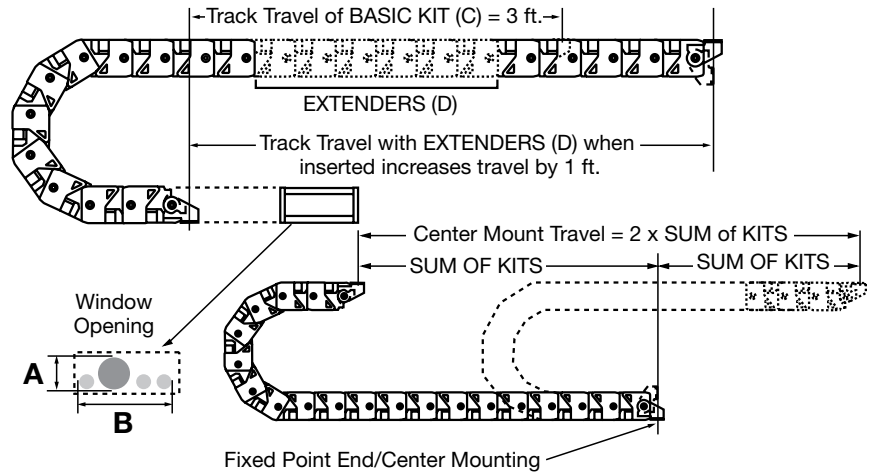

Calculating

Center Mount (Stationary bracket mounted in center of travel range): $\text{Track Length} = (\text{MT}/2) + L$

End Mount (Stationary bracket mounted off center of travel range): $\text{Track Length} = (\text{MT}/2) + L + \text{offset from center in feet}$

MT = Total machine travel distance in feet

L = Length of track taken up by the bend radius

Customizing Track Length

Hubbell CableTrak is easily customized by adding or subtracting links to the track. CableTrak kits provide 4 to 5 feet of track with brackets pre-installed. Track length can be increased by installing the required number of extenders to reach the required length. To further tune the length of track, individual links can be added or removed. To determine the number of links to add or remove, divide the length in inches to be added or subtracted by the pitch of the track and round up.

CableTrak® Accessories

Bracket Kits	For Use With	A	B	C	D	E	F	G	H
HCTBK101	HCT101 Series	.40" (10.2)	.81" (20.6)	.47" (12.0)	.94" (23.9)	–	–	–	–
HCTBK102	HCT102 Series	.44" (11.2)	1.22" (31.0)	.44" (11.2)	1.35" (34.3)	–	–	–	–
HCTBK161	HCT161 Series	.99" (25.2)	1.97" (50.1)	.87" (22.1)	1.84" (46.7)	1.19" (30.2)	.281" (7.1)	.75" (19.1)	.81" (20.6)
HCTBK162	HCT162 Series	1.78" (45.2)	2.75" (69.9)	1.65" (41.9)	2.63" (66.8)	1.19" (30.2)	.281" (7.1)	.75" (19.1)	.81" (20.6)
HCTBK163	HCT163 Series	2.57" (65.3)	3.55" (90.2)	2.44" (62.0)	3.42" (86.9)	1.19" (30.2)	.281" (7.1)	.75" (19.1)	.81" (20.6)
HCTBK164	HCT164 Series	3.56" (90.4)	4.53" (115.1)	3.47" (88.1)	4.41" (112.0)	1.19" (30.2)	.281" (7.1)	.75" (19.1)	.81" (20.6)
HCTBK251	HCT251 Series	2.08" (52.8)	3.21" (81.5)	1.80" (45.7)	3.03" (77.0)	1.75" (44.5)	.344" (8.7)	1.00" (25.4)	1.25" (31.8)
HCTBK252	HCT252 Series	3.74" (95.0)	4.87" (123.7)	3.46" (87.9)	4.69" (119.1)	1.75" (44.5)	.344" (8.7)	1.00" (25.4)	1.25" (31.8)
HCTBK253	HCT253 Series	6.08" (154.4)	7.21" (183.1)	5.80" (147.3)	7.03" (178.6)	1.75" (44.5)	.344" (8.7)	1.00" (25.4)	1.25" (31.8)
Separators	For Use With	A	B	C	D	E	F		
HCTSP16PK12	HCT16 Series	1.24" (31.5)	.82" (20.8)	.94" (23.9)	.27" (6.9)	.14" (3.6)	.50" (12.7)		
HCTSP25PK12	HCT25 Series	2.03" (51.6)	1.00" (25.4)	1.19" (30.2)	.35" (8.9)	.15" (3.8)	.62" (15.8)		

HCTBK101 – Brackets

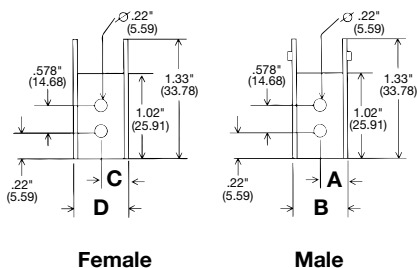

HCTBK102 – Brackets

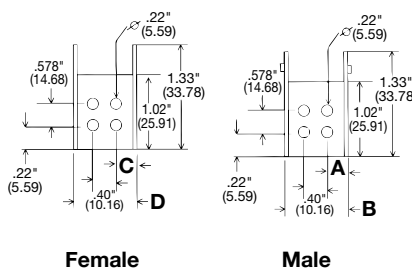

HCTBK161 – HCTGK253 Brackets

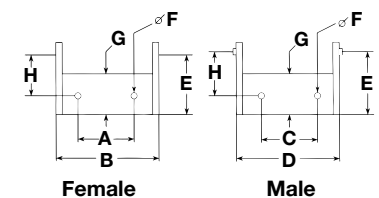

Separators

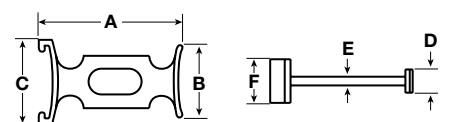

Dimensions in Inches (mm)

Industrial Connectivity and Control Products

CableTrak® System Mounting Options

Horizontal Travel

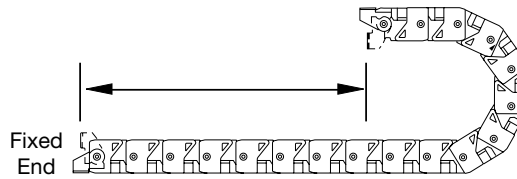
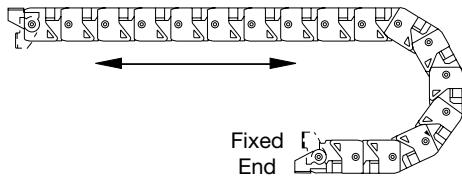

Combination Horizontal & Vertical Travel

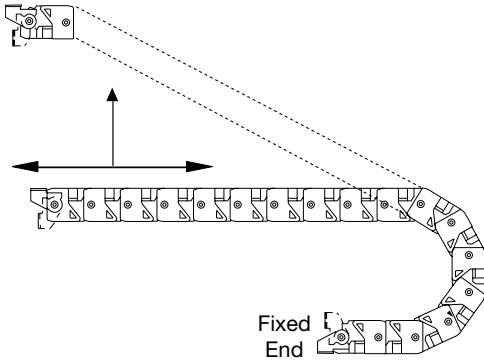

Opposed Travel

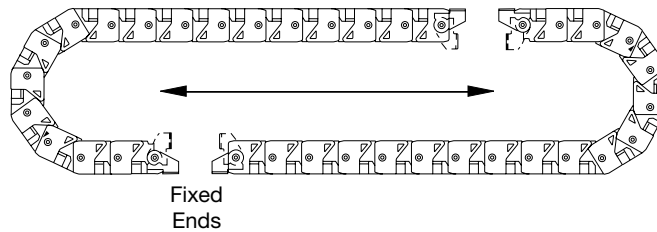

Vertical Travel

Curve Up

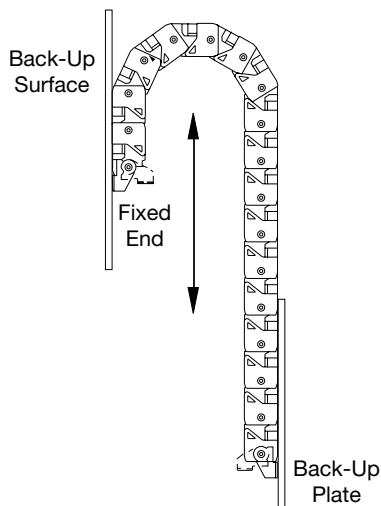

Curve Down

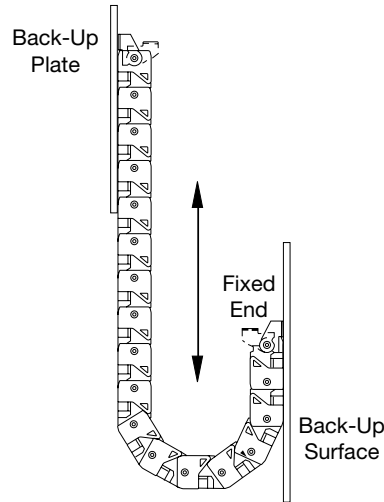

Specifications

Material	Fiberglass reinforced nylon.
Operating Temperature	Continuous +20°F to +100°F (-7°C to 38°C). Intermittent* -40°F to +220°F (-40°C to 104°C).
Maximum Operating Speed	600 FPM (feet per minute), 180 MPM (meters per minute). Operating speed is based on short lengths that are self supported (up to 9ft.).
Maximum Unsupported Travel Distance	HCT16 Series without sag 9 ft. (2.8 m) with sag 10.5 ft. (3.2 m). HCT25 Series without sag 13.5 ft. (4.1 m) with sag 17 ft. (5.2 m).
Applications	Machine tool, robotic automation, material handling.

Note: *Intermittent refers to the operating of the product outside the normal (continuous operating) temperature range momentarily before returning back to the normal range.

DIN Rail Utility Box

Hubbell's DIN Rail Utility Box offers a labor saving way to provide utility power to any control cabinet. Installing the DIN Rail Utility Box is as easy as snapping the box onto a 35mm DIN Rail and connecting the line, neutral and ground wires to the terminal block. Utility power for fans, lights, laptop computers, testers or any other power requirement. If load limiting is a concern, Hubbell's "CB" version comes with a 5 Amp circuit breaker that provides over-current protection to make sure that large loads are not drawn from the DIN Rail Utility Box. All Hubbell DIN Rail Utility Boxes may be mounted either vertically or horizontally on the DIN Rail; the "H" version comes with the terminal block mounted for easy wiring when the DIN Rail Utility Box is mounted horizontally.



15A 125V
NEMA 5-15R
UL CSA
0.5 HP



20A 125V
NEMA 5-20R
UL CSA
1 HP

Duplex Receptacles

Description	Color	Catalog Number	
Complete unit.	Gray	DRUB15	DRUB20
Complete unit, horizontal mount.	Gray	DRUB15H	-
Complete unit with 5A circuit breaker.	Gray	DRUB15CB5	-
Complete unit with 5A circuit breaker, horizontal.	Gray	DRUB15HCB5	-
Complete unit with aux.	Gray	-	DRUB20AC
Complete unit with aux and 5A circuit breaker.	Gray	-	DRUB20ACCB5
Complete unit with NEMA® 6-20R duplex (250V).	Gray	-	DRUB5462*

GFCI Duplex Receptacles

Description	Color	Catalog Number	
Complete unit.	Gray	DRUBGFI15	DRUBGFI20
Complete unit, horizontal.	Gray	DRUBGFI15H	-
Complete unit with 5A circuit breaker.	Gray	DRUBGFI15CB5	-
Complete unit with 5A circuit breaker, horizontal.	Gray	DRUBGFI15HCB5	-
Complete unit with aux GFCI contacts.	Gray	DRUBGFI15AC	DRUBGFI20AC
Complete unit, faceless with aux GFCI contacts.	Gray	-	DRUBGFI20BFAC

TVSS Duplex Receptacles

Description	Color	Catalog Number	
Complete unit.	Gray	DRUBTVSS15	-
Complete unit with aux contacts.	Gray	DRUBTVSS15AC	-

Isolated Ground^Δ Duplex Receptacles

Description	Color	Catalog Number	
Complete unit.	Gray	DRUBIG15	-

Toggle Switch Unit

Description	Color	Catalog Number
Complete unit with HBL1221.	Gray	DRUB1221AC
Complete unit with 15A 125V SW/REC.	Gray	DRUB6404

DIN Rail Utility Box Components

Description	Color	Catalog Number
Pre-wired kit without circuit breaker.	Gray	DRUBKIT
Pre-wired kit with circuit breaker.	Gray	DRUBKITCB5
Pre-wired kit with aux.	Gray	DRUBKITAC
Pre-wired kit with circuit breaker and aux.	Gray	DRUBKITACCB5
Communications kit (unloaded).	Gray	HIDRUBKIT
Switch plate only.	Gray	KP1GY**
Rectangular opening plate only.	Gray	KP26GY**
1.60 in. opening plate only.	Gray	KP720GY**
1.40 in. opening plate only.	Gray	KP7GY**
Duplex receptacle plate only.	Gray	KP8GY**

Note: ^ΔSee section M for additional information on isolated ground devices.

*DRUB5462 configuration not pictured.

**UL Listed, CSA Certified.

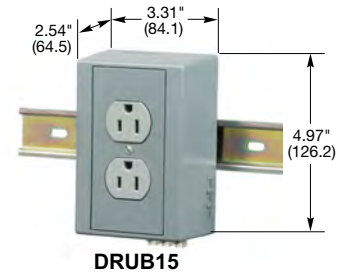

DRUB15

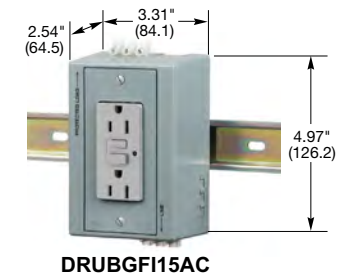

DRUBGFI15AC

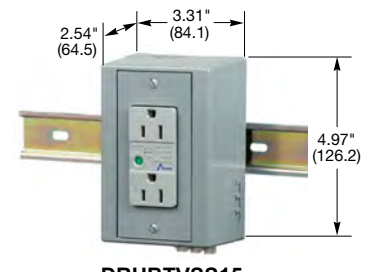

DRUBTVSS15

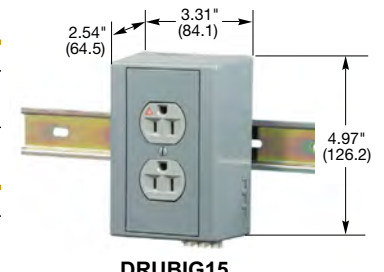

DRUBIG15

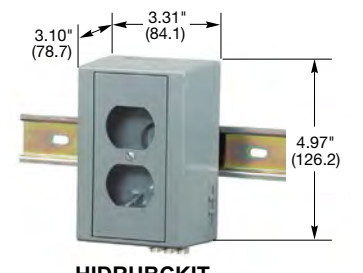

HIDRUBKIT

Dimensions in Inches (mm)

NEMA® is a registered trademark of the National Electrical Manufacturers Association.

Features and Benefits

IP66
SUITABILITY

NFPA 70E Compliant

PANEL-SAFE® Power and Data

An arc flash is a short circuit that travels through air from one live circuit to another. Problems including gaps in insulation, dust or corrosion on the surface of a conductor, or even use of substandard components can cause a serious safety hazards and equipment failures. Arc flash incidents can be extremely costly to a business and can result in serious or even fatal burns, as well as damage to eyesight. Hubbell PANEL-SAFE® provides through door access to live electrical components without having to open the enclosure.

- Available in Type 4, 12 and 4X versions with protective clear cover
- Provides overcurrent protection for both power and data access ports
- Ensures safety with finger-safe contacts and Hubbell GFCI functionality



Available in
**NEMA TYPE 4, 12 and
NEMA TYPE 4X Versions!**



Housing Design

- Rugged, nickel-plated hardware, excellent corrosion and abuse resistance
- Protective clear cover
- Operating temperature -20°C to 110°C



Internal Design

- Hubbell GFCI with functionality indicator
- Cat. 5e Ethernet access*
- Overcurrent protection



Housing Design

- Locking Hasp accepts 5/32" padlock
- Supplemental "Tool" entry screw closure



Internal Design

- Additional convenience outlet on GFCI versions
- Finger-safe contacts
- Stainless steel snap latch

*Note: *Additional computer interfaces and PLC connections available upon request.*

Specifications

Electrical	GFCI - conforms to UL 943 2006 requirement In-Cabinet Receptacle - GFCI protected Data Jack - Cat. 5e Circuit Breaker - 3A
Mechanical	Cover - Clear Polycarbonate (UV Rated) Housing - Cast Aluminum Finish - Powder Coat Latch - Stainless steel
Environmental	Enclosure - NEMA Type 4, 12 and NEMA Type 4X
Certification	UL Recognized CSA Certified

Application

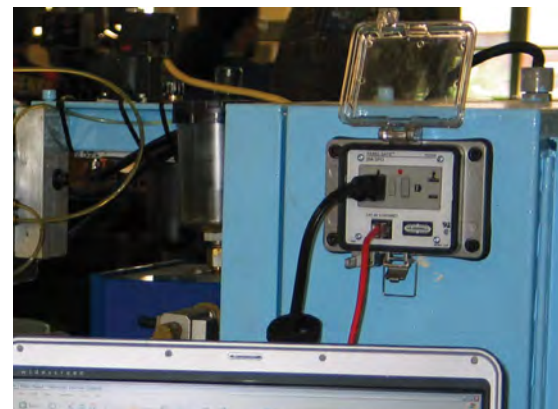

PANEL-SAFE® Power Only

Description	NEMA TYPE 4	NEMA TYPE 4X
15A 125V GFCI with In-Cabinet Receptacle.	PR20	—



PR20

PANEL-SAFE® Data Only

Description	NEMA TYPE 4	NEMA TYPE 4X
Cat. 5e Ethernet Access only.	P5E	P4X5E
DB9 Interface Connector only.	PDB9	—
PANEL-SAFE Data Port with DB9 Connector.	PDB9MF	—
DH + Combo (DB9/8M Din) and Cat. 5e Ethernet.	PDH5E	—
PANEL-SAFE Data Port, (2) USB, 3 ft. Cable.	—	P4XUSBA2C3



P5E



PDB9MF



P4XUSBA2C3

PANEL-SAFE® Power and Data

Description	NEMA TYPE 4	NEMA TYPE 4X
15A 125V GFCI with In-Cabinet Receptacle and Cat. 5e Ethernet Access.	PR205E	PR4X205E
15A 125V GFCI with In-Cabinet Receptacle, Cat. 5e Ethernet Access and 3A Circuit Breaker.	PR205EB	PR4X205EB
PANEL-SAFE with 15A GFCI and Cat.5e, DB9 and 3A Circuit Breaker.	PR205EDB9B	—
PANEL-SAFE with 15A GFCI and Cat.5e, 3A USB.	PR205EUSBA	—
PANEL-SAFE with 15A GFCI and Cat.5e, (2) 3A USB.	PR205EUSBA2	—
PANEL-SAFE Data Access Port.	PR205EUSBA2VGA	—
15A 125V GFCI Power and Cat. 5e, DB9 and 3A Circuit Breaker.	PR205EDB9MFB	—
15A 125V GFCI Power and Cat. 5e Ethernet, DH + Combo (DB9/8M Din).	P20DH5E	—
PANEL-SAFE with 15A GFCI and Cat.5/DB9.	P205EDB9	—
PANEL-SAFE, 4X, Cat. 5e, DB9, Circuit Breaker.	—	PR4X205EDB9B
PANEL-SAFE 4X, Cat. 5e, (2) DB9, Circuit Breaker.	—	PR4X205E2DB92B
15A 125V Power and Cat. 5e Ethernet Access.	P155E	P4X155E
15A 125V Power, Cat. 5e Ethernet Access and 3A Circuit Breaker.	P155EB	P4X155EB
15A 125V Power and (2) Cat. 5e Ethernet Access.	P155E2	—
15A 120V AC Power, NEMA 12/4, DB9 M/F, 10 ft. Cable.	P15DB9MFC10	—
15A 125V Power and DH485 Interface (RJ-45F to RJ-45M, 10 ft. Cable).	P15DH485C10	—
15A 125V Power and Micrologix 8M Din/F to 8M Din/M, 10 ft. Cable.	P15ML8F8MC10	—



PR205EUSBA2



PR205EB



P155E



P155EB

Additional computer interfaces, PLC connections and configurations available upon request. Consult factory for catalog number and availability.

Features and Benefits

HI-Impact Industrial Ethernet Connectors

Hubbell's Industrial Ethernet System provides leading edge Category 5e and 6 network transmission performance suitable for industrial and other harsh environments. This system incorporates the use of our standard data connectivity jacks which feature our keystone latching mechanism, in a rugged sealed housing providing IP67 rated protection.

Extend your LAN to include automation equipment and manufacturing or process control equipment. Utilize the Hubbell system to provide added protection in harsh environments such as convention centers, food processing plants, outdoor billboards and display screens, medical and other environments which require added protection from moisture, corrosion, dust-debris, vibration and chemicals.



Housing Design

- Housing made from high impact polymer
- O-rings for moisture protection
- Sealed connection is IP67 rated



Internal Design

- Category 6 and 5e component connectors
- Standard Hubbell Keystone latching system

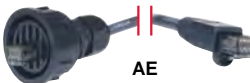

AE

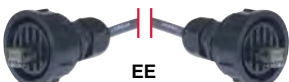

EE

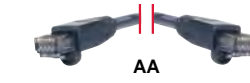

AA



HICH



HIC

HISF11

Industrial Ethernet Connectors

Description	Cat. 6	Cat. 6 Inline Coupler
Connector	HI6	HI6C

Industrial Ethernet Patch Cords and Plugs

Description	Catalog Number
HI-Impact RJ-45 to standard RJ-45.	HI603AE*
HI-Impact RJ-45 on both ends.	HI603EE*
Standard RJ-45 on both ends.	HI603AA*

Note: *Additional lengths in feet: 05, 07, 10, 15, 20, 25, 30, 35, 40, 45, 50.

Coupler Housing and Connector Cap

Description	Catalog Number
HI-Impact coupler housing is a perfect solution for temporary and flexible work areas where single port drops are needed. Add any HI-Impact connector to support your application.	HICH
Connector Cap	HIC

HI-Impact Wallplates

Description	1-Gang 1-Port Opening	1-Gang 2-Port Openings	2-Gang 2-Port Openings	2-Gang 4-Port Openings
Stainless steel wallplate.	HISF11	HISF12	HISF22	HISF24

Valox® is a trademark of SABIC Innovative Plastics, acquired from General Electric Company.

Environmental Specifications

Ingress Protection:	NEMA TYPE 4X (connectors), IP67 and IP66 (dust/water), IP55 (plates).
Corrosion:	Resistant to most common chemicals, oils and cleaning agents.
HI-Impact Housing:	UV resistant.
Temperature Range:	TIA/EIA-568-B.2 -25°C to 70°C.

Material

HI-Impact Housing:	Valox®, UL 94V-0.
Nose Contacts:	Beryllium copper with a minimum of 50 micro-inch gold plating over nickel under plating.

Mechanical

Vibration	
Frequency Range:	10-500Hz.
Acceleration:	5g (operational).
Mating Cycles:	750 minimum.
UL 1863 compliant.	

Electrical

ANSI/TIA/EIA-568-B.2-1 (Cat. 6 and 5e).
Supports TIA-1005 Industrial Telecommunications Infrastructure.

SECTION J

Table of Contents



inREACH™ Industrial and Industrial Weatherproof Cord Reels



Commercial and Lighted Cord Reels



Air/Water Hose Reels and Static Discharge Reels



Product	Page
inREACH™ Industrial & Industrial Weatherproof Cord Reels	
Features and Benefits	J-2
inREACH™ Industrial Cord Reels	J-2
Industrial Cord Reels Connector Ends	J-3
inREACH™ Industrial Weatherproof Cord Reels	J-4
Heavy Duty Industrial Weatherproof Reels	J-5
Medical Cord Reels	J-6
Industrial and Commercial Lighted Cord Reels	J-6
Commercial Cord Reels	J-7
Air/Water Hose Reels and Static Discharge Reels	J-8
Tool Balancers	J-9
Tool Balancer Accessories	J-10

inREACH™ Industrial and Industrial Weatherproof Cord Reels

Hubbell's newly redesigned inREACH™ Industrial and Industrial Weatherproof Cord Reels improve existing user safety and maximize efficiency by managing cord and power in a safe and organized manner, while also meeting the most demanding industrial environments needs for years with little to no maintenance.

inREACH™ Industrial and Industrial Weatherproof Cord Reels are listed to UL 355 and CSA, C22.2 No. 308 with a durable, lightweight low profile cast aluminum construction. inREACH™ Reels also feature a newly designed mounting plate that allows for a quick easy installation on any surface.



inREACH™

No matter what your need,
Hubbell will always be inREACH™!

inREACH™ Industrial Cord Reels

- » Durable, corrosion resistant cast aluminum construction
- » Multi-position guide arm can be mounted in two positions
- » Ratchet lock can be disengaged in field for constant tension applications



HBLI45123



HBLI45123BLK



HBLI45103Y

inREACH™ Industrial Cord Reels

Amps	Volts AC	Cable Length Feet (m)	Cable Type	Weight Lbs. (kg)	Black Reel	White Reel	Yellow Reel
10	250	45 (13.7)	16/3 SJO	22.9 (10.4)	—	HBLI45163	HBLI45163Y
			16/4 SJO	23.6 (10.7)	—	HBLI45164	HBLI45164Y
		35 (10.7)	16/3 SJO	22.0 (10.0)	—	HBLI35163	HBLI35163Y
			16/4 SJO	22.7 (10.3)	—	HBLI35164	HBLI35164Y
		25 (7.6)	16/3 SJO	21.2 (9.6)	—	HBLI25163	HBLI25163Y
			16/4 SJO	21.8 (9.9)	—	HBLI25164	HBLI25164Y
15	250	45 (13.7)	14/3 SJO	24.0 (10.9)	—	HBLI45143	HBLI45143Y
			14/4 SJO	25.4 (11.5)	—	HBLI45144	HBLI45144Y
		35 (10.7)	14/3 SJO	22.9 (10.4)	—	HBLI35143	HBLI35143Y
			14/4 SJO	24.0 (10.9)	—	HBLI35144	HBLI35144Y
		25 (7.6)	14/3 SJO	21.8 (9.9)	—	HBLI25143	HBLI25143Y
			14/4 SJO	22.7 (10.3)	—	HBLI25144	HBLI25144Y
20	250	45 (13.7)	12/3 SJO	26.5 (12.0)	HBLI45123BLK	HBLI45123	HBLI45123Y
			12/3 SJO	26.5 (12.0)	—	HBLIWC45123**	—
			12/4 SJO	29.8 (13.5)	—	HBLI45124	HBLI45124Y
		35 (10.7)	12/3 SJO	24.9 (11.3)	—	HBLI35123	HBLI35123Y
			12/4 SJO	26.5 (12.0)	—	HBLI35124	HBLI35124Y
		25 (7.6)	12/3 SJO	23.4 (10.6)	—	HBLI25123	HBLI25123Y
12/4 SJO	24.5 (11.1)		—	HBLI25124	HBLI25124Y		
18	250	70 (21.3)	12/3 SJO	79.6 (36.1)	—	HBLI70123*	—
18	250	90 (27.4)	12/3 SJO	86.5 (39.2)	—	HBLI90123*	—
16	250	80 (24.4)	12/3 SJO	85.1 (38.6)	—	HBLI80124*	—
30	250	45 (13.7)	10/3 SJO	32.4 (14.7)	—	HBLI45103	HBLI45103Y
			10/4 SJO	33.7 (15.3)	—	HBLI40104	HBLI40104Y
		35 (10.7)	10/3 SJO	30.0 (13.6)	—	HBLI35103	HBLI35103Y
			10/4 SJO	32.2 (14.6)	—	HBLI35104	HBLI35104Y
		25 (7.6)	10/3 SJO	26.0 (11.8)	—	HBLI25103	HBLI25103Y
			10/4 SJO	29.1 (13.2)	—	HBLI25104	HBLI25104Y
25	250	80 (24.4)	10/3 SJO	104.3 (47.3)	—	HBLI80103*	—
25	250	80 (24.4)	10/4 SJO	113.3 (51.4)	—	HBLI80104*	—

Note: * See page J-3 for compatible mounting brackets **Supplied with White cable.

Cable, Cord and Hose Reels



Features and Benefits

inREACH™ Industrial Cord Reels

- Durable, corrosion resistant cast aluminum construction
- Multi-position guide arm can be mounted in two positions
- Ratchet lock can be disengaged in field for constant tension applications

Labor Savings are inREACH™!



inREACH™ Industrial Cord Reels Connector Ends

Description	Amps	Volts AC	Cable Length Feet (m)	Cable Type	Weight Lbs. (kg)	Catalog Number
White Industrial Reel	with HBL5269C	15	125	45 (13.7)	14/3 SJO	24.0 (10.9) HBLI45143C15
	with HBL5369C	20	125	45 (13.7)	12/3 SJO	26.5 (12.0) HBLI45123C20
	with HBL2313					26.5 (12.0) HBLI45123TL20
White Industrial Reel with Yellow Portable Outlet Box	(1) 15A Duplex Receptacle	15	125	45 (13.7)	14/3 SJO	26.5 (12.0) HBLI45143R15
	(2) 15A Duplex Receptacles					26.5 (12.0) HBLI45143R215
	GFCI Module and (1) 15A Duplex Receptacle	15	125	45 (13.7)	14/3 SJO	26.5 (12.0) HBLI45143GF15
White Industrial Reel with Black Portable Outlet Box	GFCI Module and (2) 15A Duplex Receptacles					26.5 (12.0) HBLI45143GF215
	(1) 15A Duplex Receptacle	15	125	45 (13.7)	14/3 SJO	26.5 (12.0) HBLI45143R15M1
	(2) 15A Duplex Receptacles					26.5 (12.0) HBLI45143R215M1
White Industrial Reel with Yellow Portable Outlet Box	GFCI Module and (2) 15A Duplex Receptacles	15	125	45 (13.7)	14/3 SJO	26.5 (12.0) HBLI45143GF215M1
	(1) 20A Duplex Receptacle	20	125	45 (13.7)	12/3 SJO	26.5 (12.0) HBLI45123R20
	(2) 20A Duplex Receptacles					26.5 (12.0) HBLI45123R220
White Industrial Reel with Black Portable Outlet Box	GFCI Module and (1) 20A Duplex Receptacle	20	125	45 (13.7)	12/3 SJO	26.5 (12.0) HBLI45123GF20
	GFCI Module and (2) 20A Duplex Receptacles					26.5 (12.0) HBLI45123GF220
	(1) 20A Duplex Receptacle	20	125	45 (13.7)	12/3 SJO	26.5 (12.0) HBLI45123R20M1
White Industrial Reel with Black Portable Outlet Box	(2) 20A Duplex Receptacles					26.5 (12.0) HBLI45123R220M1
	GFCI Module and (2) 20A Duplex Receptacles	20	125	45 (13.7)	12/3 SJO	26.5 (12.0) HBLI45123GF220M1
	GFCI Module and Triple Tap Outlet	15	125	45 (13.7)	12/3 SJO	26.5 (12.0) HBLI45123GFTT



Note: 15A reels are supplied with HBL5266C on the power supply cord. 20A reels are supplied with HBL5366C on the power supply cord. For shorter cable lengths, modify length indication in catalog number (i.e. HBLIXX); 35ft & 25ft lengths are available. For yellow reel, add 'Y' suffix to catalog number.

inREACH™ Accessories

Description	Weight Lbs. (kg)	Catalog Number
Mounting bracket	2.5 (1.1)	HBLIMB
Mounting bracket with junction box mount	3.0 (1.4)	HBLIMBJ
Mounting bracket	3.5 (1.6)	HBLIACCMB*
Mounting bracket with junction box mount	4.0 (1.8)	HBLIACCMBJ*
340° pivot base	3.5 (1.1)	HBLI340PB
Replacement stop.	.2 (.09)	HBLI16BS HBLI14BS HBLI12BS HBLI10BS

Note: *Compatible with cord reel models from page J-2 marked with a single asterisk (*)

Plenum Rated Enclosure for inREACH™ Cord Reels

Description	Weight lbs. (kg)	Catalog Number
Plenum Rated Enclosure	30 lbs. (13.6)	HBLIPRBOX

Note: Check with manufacturer for compatible cord reel models.



Features and Benefits

inREACH™ Industrial Weatherproof Cord Reels

- UL Type 4 environmental listing
- 600V AC, SOW Type Cable
- Durable, corrosion resistant cast aluminum construction
- Multi-position guide arm can be mounted in two positions
- Ratchet lock can be disengaged in field for constant tension applications



HBLW45103

inREACH™ Industrial Weatherproof Cord Reels

Amps	Volts AC	Cable Length Feet (m)	Cable Type	Weight Lbs. (kg)	Yellow Reel	White Reel
10	600	45 (13.7)	16/3 SOW	23.6 (10.7)	HBLW45163	HBLW45163W
			16/4 SOW	25.6 (11.6)	HBLW45164	HBLW45164W
		35 (10.7)	16/3 SOW	22.5 (10.2)	HBLW35163	HBLW35163W
			16/4 SOW	23.1 (10.5)	HBLW35164	HBLW35164W
		25 (7.6)	16/3 SOW	21.4 (9.7)	HBLW25163	HBLW25163W
			16/4 SOW	21.8 (9.9)	HBLW25164	HBLW25164W
15	600	45 (13.7)	14/3 SOW	28.2 (12.8)	HBLW45143	HBLW45143W
			14/4 SOW	30.0 (13.6)	HBLW45144	HBLW45144W
		35 (10.7)	14/3 SOW	25.1 (11.4)	HBLW35143	HBLW35143W
			14/4 SOW	26.5 (12.0)	HBLW35144	HBLW35144W
		25 (7.6)	14/3 SOW	22.5 (10.2)	HBLW25143	HBLW25143W
			14/4 SOW	24.3 (11.0)	HBLW25144	HBLW25144W
18 16	600	80 (24.4)	12/3 SOW	97.5 (44.2)	—	HBLW80123W*
		75 (22.9)	12/4 SOW	107.4 (48.7)	—	HBLW75124W*
20	600	45 (13.7)	12/3 SOW	31.3 (14.2)	HBLW45123	HBLW45123W
			12/4 SOW	32.2 (14.6)	HBLW40124	HBLW40124W
		35 (10.7)	12/3 SOW	28.9 (13.1)	HBLW35123	HBLW35123W
			12/4 SOW	30.6 (13.9)	HBLW35124	HBLW35124W
		25 (7.6)	12/3 SOW	24.9 (11.3)	HBLW25123	HBLW25123W
			12/4 SOW	27.6 (12.5)	HBLW25124	HBLW25124W
25 20	600	75 (22.9)	10/3 SOW	103.8 (47.1)	—	HBLW75103W*
		75 (22.9)	10/4 SOW	116.2 (52.7)	—	HBLW75104W*
30	600	40 (12.2)	10/3 SOW	33.3 (15.1)	HBLW40103	HBLW40103W
			10/4 SOW	34.2 (15.5)	HBLW35104	HBLW35104W
		35 (10.7)	10/3 SOW	31.7 (14.4)	HBLW35103	HBLW35103W
			10/4 SOW	34.2 (15.5)	HBLW35104	HBLW35104W
		25 (7.6)	10/3 SOW	28.4 (12.9)	HBLW25103	HBLW25103W
			10/4 SOW	30.2 (13.7)	HBLW25104	HBLW25104W
40 30 35	600	45 (13.7)	8/3 SOW	106.5 (48.3)	—	HBLW4583W*
		60 (18.3)	8/3 SOW	123.2 (55.9)	—	HBLW6083W*
		45 (13.7)	8/4 SOW	122.8 (55.7)	—	HBLW4584W*
55 55	600	45 (13.7)	6/3 SOW	123.0 (55.8)	—	HBLW4563W*
		45 (13.7)	6/4 SOW	126.7 (57.5)	—	HBLW4564W*
14 6	600	45 (13.7)	12/8 SOW	107.4 (48.7)	—	HBLW45128W*
		45 (13.7)	14/12 SOW	113.5 (51.5)	—	HBLW451412W*

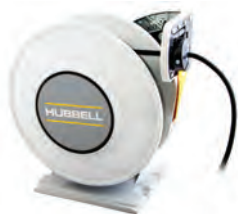

HBLW45123W



HBLW35143



HBLW45103



HBLIMB



HBLI340PB



HBLIMBJ



HBLI10BS

inREACH™ Accessories

Description	Weight Lbs. (kg)	Catalog Number
Mounting bracket	2.5 (1.1)	HBLIMB
Mounting bracket with junction box mount	3.0 (1.4)	HBLIMBJ
Mounting bracket	3.5 (1.6)	HBLIACMB*
Mounting bracket with junction box mount	4.0 (1.8)	HBLIACMBJ*
340° pivot base	3.5 (1.6)	HBLI340PB
Replacement stop	.2 (.09)	HBLI16BS HBLI14BS HBLI12BS HBLI10BS

Note: *Compatible with cord reel models marked with a single asterisk (*)

Features and Benefits

Heavy Duty Industrial Weatherproof Reels

- Powder coated, solid U.S. steel construction
- Multi-position roller guide can be mounted in four different positions
- Ratchet lock can be disengaged in field for constant tension application
- UL Type 4X enclosure protects spring motor, junction box, slip ring assembly and cable entrance from hosedown or corrosion
- Optional pivot base allows 340° rotation of reel and increases range of cable to nearly any direction



HBL501242W
with HBL16PB

Heavy Duty Industrial Weatherproof Reels*

Description	Amps	Volts AC	Cable Length Feet (m)	Cable Type	Weight Lbs. (kg)	Catalog Number
14" yellow weatherproof reel	15	600	50 (15.2)	14/3 SOW-A	55 (24.9)	HBL501431W
16" weatherproof reel yellow housing white housing	20	600	50 (15.2)	12/3 SOW-A	80 (36.3)	HBL501232W HBL501232WM1
16" yellow weatherproof reel	16	600	50 (15.2)	12/4 SOW-A	86 (39.0)	HBL501242W
16" weatherproof reel yellow housing white housing	25	600	50 (15.2)	10/3 SOW-A	86 (39.0)	HBL501032W HBL501032WM1
16" yellow weatherproof reel	20	600	50 (15.2)	10/4 SOW-A	92 (41.7)	HBL501042W

Note: *All heavy duty industrial cord reels are supplied with wire leads and 3/4" NPT hub feed. Power supply cable not supplied.



HBL501232WM1



HBL501242W
with HBL16PB

Accessories

Description	Weight Lbs. (kg)	Catalog Number
16" pivot base.	13 (5.9)	HBL16PB
Replacement stop.	.2 (.09)	HBLWPBS

Specifications

Listing/Certification	UL 355 and CSA, C22.2 No. 308.
Environment	Type 4X enclosure, CAN/CSA - C22.2 No. 308. Dry, indoor and wet and damp outdoor non-hazardous location.



HBL16PB

Dimensions

Inch (mm)	A	B	C	D	E	F	G	H	I	J
14" Reel	6.50" (165)	8.12" (206)	16.25" (413)	13.75" (349)	3.00" (76)	12.19" (310)	3.00" (76)	3.00" (76)	3.00" (76)	6.50" (165)
16" Reel	6.50" (165)	9.12" (232)	18.25" (464)	15.75" (400)	3.00" (76)	14.19" (360)	6.00" (152)	6.00" (152)	4.94" (125)	6.50" (165)



HBLWPBS

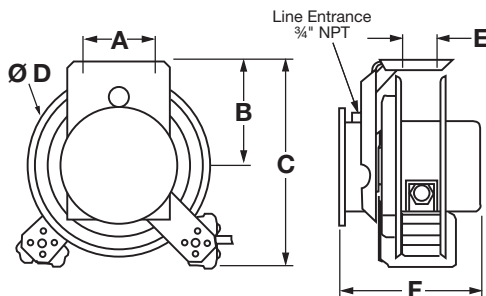

Pivot Base

340° Pivot Base (Optional)

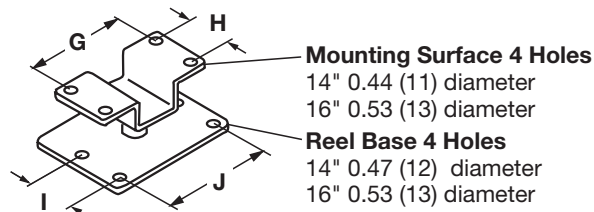

Note: Pivot base for use only with Weatherproof Cable Reel.

Dimensions in Inches (mm)

Cable, Cord and Hose Reels



inREACH™ Medical Cord Reels



HBLIWC45123GF220HG

Description	Amps	Volts	Cable Length Feet (m)	Cable Type	Weight Lbs. (kg)	Catalog Number
White reel, white portable outlet box, GFCI module, and (2) 20A Hospital Grade receptacles	20A	125V AC	45 (13.7)	12/3 SJO	34.9 (15.8)	HBLIWC45123GF220HG
White reel, white portable outlet box, and (2) 20A Hospital Grade receptacles	20A	125V AC	45 (13.7)	12/3 SJO	34.4 (15.6)	HBLIWC45123R220HG
White reel and Hospital Grade connector HBL8319C	20A	125V AC	45 (13.7)	12/3 SJO	33.6 (15.2)	HBLIWC45123C20HG



Industrial Lighted Cord Reels, 45 Ft. (13.7m) - 16/3 AWG SJEO Cable



HBLI45163LED

Cord End	Amps	Volts AC	Watts (Max)	Weight Lbs. (kg)	Catalog Number
LED hand lamp, with end light, white reel.	0.07	125	8 + 1	22.9 (10.4)	HBLI45163LED
Incandescent hand lamp, white reel.	0.8	125	100	22.9 (10.4)	HBLI45163IN

Note: Supplied with 5 ft. power supply cord with HBL5266C, 15A straight blade plug. For shorter cable lengths, modify length indication in catalog number (i.e. HBLIXX); 35ft & 25ft lengths are available. For yellow reel, add 'Y' suffix to catalog number.

InREACH™ Category 6 Data Reels



HBLI50CAT6

Description	Cable Length ft (m)	Cable Type	Weight lbs. (kg)	Catalog Number
Black Data Reels with RJ45 Plugs	50 (15.2)	Cat 6	22.9 (10.4)	HBLI50CAT6
White Data Reels with RJ45 Plugs	50 (15.2)	Cat 6	22.9 (10.4)	HBLI50CAT6W

Accessories



HBL16LEDR

Description	Amps	Volts AC	Watts (Max)	Weight Lbs. (kg)	Catalog Number
Replacement stop.	—	—	—	.2 (.09)	HBLI16BS
Replacement LED hand lamp.	0.07	120	8 + 1	1 (.5)	HBL16LEDR*
Replacement incandescent hand lamp.	0.8	125	100	1 (.5)	HBL16INR

Note: *cETLus Listed by INTERTEK.

Commercial Lighted Cord Reels



HBLC40182LED

Description	Amps	Volts AC	Cable Length Feet (m)	Cable Type	Watts (Max)	Weight Lbs. (kg)	Catalog Number
White Reel with LED hand lamp, with flashlight end.	0.65	125	40 (12.2)	#18/2 SJTOW	8 + 1	8.2 (3.7)	HBLC40182LED
White Reel with non-metallic incandescent hand lamp and automatic shut off switch.	0.6	125	25 (7.6)	#16/3 SJT	75	9.0 (4.1)	HBLC25163AIN**
Yellow Reel with metallic incandescent hand lamp with receptacle.	13	125	25 (7.6)	#14/3 SJT	1,625	9.5 (4.3)	HBLC25143IN

Note: **Allows the electrical cord reel installation to conform to Article 511 of the National Electric Code concerning installation of electrical devices in commercial garages, repair facilities and storage locations by positioning the switch above the defined area where hazardous fumes may collect.



HBLC25143IN

Dimensions in Inches (mm)



INTERTEK and the Intertek logo are registered trademarks of Intertek Group plc.

Features and Benefits

Commercial Cord Reels

- Durable steel construction for commercial and general purpose applications
- Compact size, flexible mounting options for ceiling, wall or bench
- Automatic ratchet lock holds cord at desired length and provides easy, smooth retraction of cord
- Attached plug for power cord requires no wiring



Commercial Cord Reels

- Durable light weight non-metallic housing
- Removable bracket allows reel to be disengaged from mount providing portability
- 40 Ft. of #12/3 cord for greater current carrying capacity
- Triple tap outlet with supplemental over current protection

Commercial Cord Reels

Description	Amps	Volts AC	Cable Length Feet (m)	Cable Type	Watts (Max)	Weight Lbs. (kg)	Catalog Number
Black Reel with triple tap outlet.	15	125	40 (12.2)	#12/3 SJTW	1,875	13.8 (6.3)	HBLC40123TT
Black Reel with wire leads.	15	125	40 (12.2)	#12/3 SJTW	1,875	13.8 (6.3)	HBLC40123
White Reel with triple tap outlet and white cord.	10	125	30 (9.1)	#16/3 SJT	1,250	8.5 (3.9)	HBLC30163TT
White Reel with single connector and white cord.	15	125	20 (6.1)	#14/3 SJT	1,875	8.5 (3.9)	HBLC20143C
Yellow Reel with Hubbell HBL5969VBLK connector.	10	125	25 (7.6)	#16/3 SJT	1,250	8.5 (3.9)	HBLC25163C
Yellow Reel with wire leads.	10	125	25 (7.6)	#16/3 SJT	1,250	8.5 (3.9)	HBLC25163**

Note: Reels supplied with 2 ft. power supply cord and molded on straight blade 15A plug.
**UL Listed only.



HBLC40123TT



HBLC30163TT



HBLC20143C



HBLC25163C

Specifications

Listing/Certification	UL 355.
Environment	Dry, indoor, non-hazardous locations.
Incandescent Lamp	75 watt max., auto switch, no receptacle; 100 watt max. bulb, with receptacle.
Fluorescent Lamp	10A/1200W max. with in-line receptacle; 13 watt without receptacle.

Dimensions

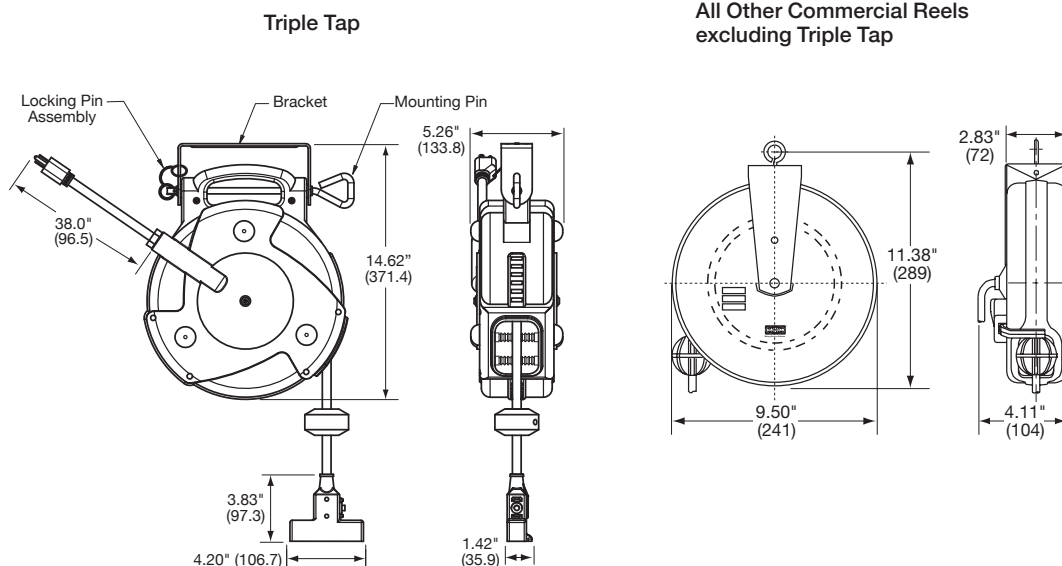

Dimensions in Inches (mm)

Cable, Cord and Hose Reels

Features and Benefits

Air/Water Hose Reels

- Constructed of rugged steel, baked polyester finish components
- Multi-position four roller guide and adjustable hose stop
- Spring rewind and ratchet lock
- Full flow shafts and swivels assure maximum product delivery



HBLHR2535



HBL50SD

Static Discharge Reels

- Steel construction
- Compact design minimizes required installation space
- Available with steel or nylon coated steel cable
- Large grounding jaw clamp provides low resistant ground termination



HBLHR2535



HBL50SD

Air/Water Hose Reels

Description	Cable Length Feet (m)	Max Pressure Psi	Frame Size	Input Hose Fitting (NPTF)	O.D. Inch (mm)	Weight Lbs. (kg)	Catalog Number
Low pressure 1/4" ID.	35 (10.7)	300	A	1/4	0.51 (13.0)	24 (10.9)	HBLHR2535
	50 (15.2)	300	B	1/4	0.51 (13.0)	26 (11.8)	HBLHR2550
Low pressure 3/8" ID.	25 (7.6)	300	A	3/8	0.65 (16.5)	23 (10.4)	HBLHR3825
	50 (15.2)	300	C	3/8	0.65 (16.5)	36 (16.3)	HBLHR3850
	70 (21.3)	300	E	3/8	0.65 (16.5)	50 (22.7)	HBLHR3870
Low pressure 1/2" ID.	35 (10.7)	300	C	3/8	0.77 (19.6)	38 (17.2)	HBLHR5035
	50 (15.2)	300	E	3/8	0.77 (19.6)	44 (20.0)	HBLHR5050

Static Discharge Reels

Description	Cable Length Feet (m)	Cable Type	Weight Lbs. (kg)	Catalog Number
Static discharge reel.	50 (15.2)	Single 3/32" Steel	12 (5.4)	HBL50SD
Static discharge reel.	50 (15.2)	Single 3/32" Steel Nylon Coated	13 (5.9)	HBL50SDN
Static discharge reel.	50 (15.2)*	Dual (Y) 3/32" Steel	13 (5.9)	HBL50YSD

Note: *35 ft. (10.6m) + Dual 15 ft. (4.5m) for "Y".

Dimensions

Frame size	A	B	C	D	E	F	G	H	J	K	L	M
A	12.88 (327)	11.25 (286)	8.00 (203)	9.88 (250)	12.13 (308)	5.50 (140)	2.50 (64)	2.50 (64)	4.00 (102)	5.09 (132)	8.38 (213)	—
B	14.50 (368)	12.81 (325)	9.75 (248)	11.25 (285)	13.75 (349)	6.19 (157)	3.16 (80)	2.50 (64)	4.00 (102)	5.88 (149)	8.38 (213)	—
C	17.50 (445)	15.63 (286)	9.75 (248)	11.25 (285)	16.50 (419)	6.19 (157)	3.16 (80)	2.50 (64)	4.00 (102)	5.88 (149)	10.25 (260)	—
E	20.38 (518)	18.12 (460)	7.88 (200)	9.45 (240)	19.00 (483)	6.63 (168)	3.35 (85)	3.86 (98)	5.43 (138)	6.10 (155)	11.00 (280)	9.5 (241)

Air/Water Hose Reels

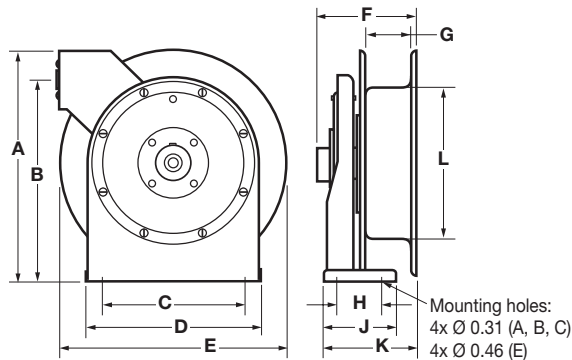

Dimensions in Inches (mm)

Static Discharge Reel

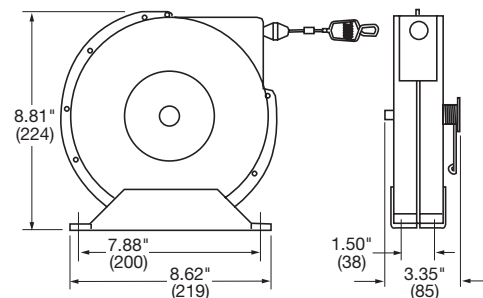

Cable, Cord and Hose Reels

Features and Benefits

Tool Balancers



ERGO™ -1
UP TO
5lbs



- Hand-windable spring tension adjustment knob is flush with the housing
- Push-button to easily release spring tension
- Rugged steel upper swivel hook with secondary safety cable provision

ERGO™ -2
UP TO
27lbs



- Rugged steel construction with black polyester baked finish
- Reinforced hanging bracket with forged clevis for ceiling mounting
- Spring is permanently lubricated and adjustable

ERGO™ -3
UP TO
308lbs



- Rugged die cast aluminum housing
- Both top and bottom hooks have spring-loaded safety latches
- Heavy duty steel wire rope

ERGO-1 Light Duty Tool Balancers

Description	Load lbs (kg)		Cable Length* Feet (m)	Reel Weight Lbs. (kg)	Catalog Number
	Min	Max			
Balancer for loads up to 5 lbs	0.5 (0.2)	1.5 (0.7)	6 (1.8)	1.3 (0.6)	HBLBD01
	1.5 (0.5)	3.0 (1.4)	6 (1.8)	1.3 (0.6)	HBLBD03
	3.0 (1.4)	5.0 (2.3)	6 (1.8)	1.5 (0.7)	HBLBD05

*Cable lengths listed are for 'active' or 'working' cable. Includes cable stop and safety hook.

ERGO-2 Medium Duty Tool Balancers

Description	Ratchet Lock	Load lbs (kg)		Cable Length* Feet (m)	Reel Weight Lbs. (kg)	Catalog Number
		Min	Max			
Balancers (constant pull reels) May be adjusted to balance through 6-18 in. (152-457mm) range.	No	3 (1.4)	7 (3.2)	8 (2.4)	6 (2.7)	HBLBG03
		5 (2.3)	10 (4.5)	8 (2.4)	6 (2.7)	HBLBG07
		8 (3.6)	12 (5.4)	8 (2.4)	7 (3.2)	HBLBG10
		10 (4.5)	15 (6.8)	8 (2.4)	8 (3.6)	HBLBG15
		16 (7.2)	23 (10.4)	8 (2.4)	8 (3.6)	HBLBG20
		16 (7.2)	23 (10.4)	8 (2.4)	8 (3.6)	HBLBG20SH**
		22 (9.9)	27 (12.2)	8 (2.4)	8 (3.6)	HBLBG25
Retractors (ratchet lock) Retract tool upward when manually released	Yes	3 (1.4)	7 (3.2)	8 (2.4)	6 (2.7)	HBLBG03L
		5 (2.3)	10 (4.5)	8 (2.4)	6 (2.7)	HBLBG07L
		8 (3.6)	12 (5.4)	8 (2.4)	7 (3.2)	HBLBG10L
		10 (4.5)	15 (6.8)	8 (2.4)	8 (3.6)	HBLBG15L
		16 (7.2)	23 (10.4)	8 (2.4)	8 (3.6)	HBLBG20L
		16 (7.2)	23 (10.4)	8 (2.4)	8 (3.6)	HBLBG20LSH**
		22 (9.9)	27 (12.2)	8 (2.4)	8 (3.6)	HBLBG25L
Torque reels*** (ratchet lock and longer cable)	Yes	3 (1.4)	7 (3.2)	15 (4.5)	8 (3.6)	HBLTQ1507
		5 (2.3)	10 (4.5)	15 (4.5)	10 (4.5)	HBLTQ1510
		10 (4.5)	15 (6.8)	15 (4.5)	12 (5.4)	HBLTQ1515

Cable lengths listed are for 'active' or 'working' cable. Includes cable stop and safety hook. | **Includes HBLBGSH "Shock Stop." | *Clevis mount. For rigid mount, add "R" suffix.

ERGO-3 Heavy Duty Tool Balancers

Description	Load lbs (kg)		Cable Length* Feet (m)	Reel Weight Lbs. (kg)	Catalog Number
	Min	Max			
Heavy-duty balancer for loads up to 308 lbs	1.1 (.05)	4.4 (2.0)	3.3 (1.0)	2.2 (1.0)	HBLBH02
	2.2 (1.0)	6.6 (3.0)	4.3 (1.3)	2.8 (1.3)	HBLBH03
	5.5 (2.5)	11 (5.0)	4.3 (1.3)	3.3 (1.5)	HBLBH05
	9.0 (4.1)	20 (9.1)	3.9 (1.2)	13.4 (6.1)	HBLBH09
	20 (9.1)	33 (15.0)	3.9 (1.2)	13.4 (6.1)	HBLBH15
	33 (15.0)	48 (21.8)	4.5 (1.4)	22.6 (10.3)	HBLBH22
	48 (21.8)	66 (30.0)	4.5 (1.4)	22.6 (10.3)	HBLBH30
	66 (30.0)	88 (40.0)	4.5 (1.4)	27.0 (12.2)	HBLBH40
	88 (40.0)	110 (50.0)	4.5 (1.4)	27.0 (12.2)	HBLBH50
	110 (50.0)	132 (60.0)	4.5 (1.4)	31.4 (14.2)	HBLBH60
	132 (60.0)	154 (70.0)	4.5 (1.4)	31.4 (14.2)	HBLBH70
	154 (70.0)	187 (85.0)	4.5 (1.4)	58.4 (26.5)	HBLBH85
	187 (85.0)	220 (100.0)	4.5 (1.4)	56.0 (25.4)	HBLBH100
	220 (100.0)	264 (120.0)	4.5 (1.4)	60.0 (27.2)	HBLBH120
	264 (120.0)	308 (140.0)	4.5 (1.4)	61.0 (27.7)	HBLBH140

**Load includes hose or cord and other attachments which must be supported by balancer. | *Cable lengths listed are for 'active' or 'working' cable. Includes cable stop and safety hook.



Dimensions in Inches (mm)

Cable, Cord and Hose Reels

Features and Benefits

Workstation Kits

- Adjustable and customizable to fit virtually any bench and task
- Superior rigidity and durability
- Kits include one WS30 and one WS50 rail

Accessories

- Most components which make up kits are available separately
- Can be installed easily on fixed or portable workstation kits



Straight Tool Rail Kits

Description	Length ft (m)	Catalog Number
Straight rail bench top kit. Best mounted to butcher block tops. Straight rail	6.0 (1.8) 5.0 (1.5)	HBLWGB030560
table top kit. Table brackets predrilled to fit Equipto and Lyon steel tops.	6.0 (1.8) 5.0 (1.5)	HBLWKB030560

Power Bars

Description	Catalog Number
60 in. power bar with 60 in. mounting bar	HBLWBP505A

Manifold with Brackets

Description	Width ft (m)	# of Taps	Catalog Number
Mounts to vertical columns or top rails on workstations	5 (1.5)	5	HBLWMAN05C

Balancer Trolleys

Description	Catalog Number
Balancer trolley	HBLWS50BTL
Single roller balancer trolley	HBLWS50BTS

Adjustable Cable Saddle

Description	Load lbs (kg)		Catalog Number
	Min	Max	
Hangs from balancer cable above tool to provide strain relief for electrical cable or air hose. Available in three sizes. Includes safety clip.	0.3 (7)	0.59 (14)	HBLCSF1
	0.6 (15)	0.94 (23)	HBLCSF2
	0.95 (24)	1.25 (31)	HBLCSF3

“Shock Stop” Shock Absorber

Description	Catalog Number
Minimize cable damage often caused by overtensioning tool balancers. “Shock Stop” kit is easily installed. Can be used on ERGO-2 balancer. Kit includes spring, cable stops, all hardware.	HBLBGSH

Extension Cable

Description	Length ft (m)	Catalog Number
Nylon covered steel cable with safety clip. Extends the cable length of ERGO-1 and ERGO-2 Tool Balancers.	3 (0.9)	HBLOC03
	5 (1.5)	HBLOC05
	10 (3.0)	HBLOC10
	15 (4.6)	HBLOC15

Safety Cable/Chain

Description	For use with	Length ft (m)	Catalog Number
Strongly recommended, secondary steel cable or steel link chain. Prevents balancer from accidental fall. Balancers have extra holes for cable or chain.	HBLBD01-05	1 (0.3)	HBLSCBD1*
	HBLBG03-25	1 (0.3)	HBLSCBG1**
	HBLBG03L-25L	2 (0.6)	HBLSCBG2**
	HBLTQ1057-15	3 (0.9)	HBLSCBG3**
	HBLBH03-30	3 (0.9)	HBLSCBG3**
	HBLBH40-140	3 (0.9)	HBLSCBH3**

Dimensions in Inches (mm)

SECTION K

Table of Contents



Extras Heavy Duty Hospital and Industrial Grade GFCIs



Extra Heavy Duty Commercial GFCIs



Extra Heavy Duty Industrial and Hospital Grade GFCIs



Product	Page
Hubbell Self Test GFCI Patented Technology	K-2
Extra Heavy Duty Industrial and Hospital Grade Tamper and Weather Resistant GFCI Receptacles	K-3
Heavy Duty Commercial Grade GFCI Receptacles	
Tamper-Resistant:	
• Nightlight, Alarm, Hospital Grade, Combination Switch/GFR and 3-Pack	K-4
Standard:	
• Nightlight, Alarm, Assembled in U.S.A., Blank Face and SNAPConnect®	K-5
Hospital Grade:	
• Non-TR, Nightlight, Alarm, Assembled in U.S.A. and SNAPConnect®	K-6
Tamper-Resistant and Weather Resistant:	
• TR/WR, Assembled in U.S.A., Isolated Ground, Hospital Grade and SNAPConnect®	K-7
Weather Resistant Only	K-8
UL 508 1.5HP Rated Ground Fault Receptacle	K-8
SNAPConnect® Features and Labor Savings	K-9

Product	Page
Arc Fault AFCI Receptacles	K-10
Dual Function AFCI/GFCI Receptacles	K-11
GFCI Sensing Module, 50A Maximum Rating	K-12
Straight Blade Portable GFCI Plugs	K-13
Portable GFCI Line Cords	
Industrial Grade, Automatic and Manual Set	K-15
Commercial Grade, Automatic and Manual Set	K-16
Multiple Outlet, Portable GFCI and Module	K-17
Circuit Guard® Plug-In Portable GFCI and Tester	K-17
Hard Wired 30 Amp GFCI - NEMA Type 4X	K-18
120V AC, 240V AC with and without Alarm	
120/240V AC, 3Ø 250V AC, 3Ø 120/208V AC	
Portable 30 Amp GFCI - NEMA Type 4X	K-19
120V AC, 240V AC with and without Alarm	
120/240V AC, 3Ø 250V AC, 3Ø 120/208V AC	
Watertight GFCI Protected FD Box	K-20
Portable GFCI Cord Drops	K-21

Ground Fault Products

Features and Benefits

AUTOGUARD® Self Test Technology 1st introduced by Hubbell Over 10 Years Ago!
Self Test Monitoring Now Required in 2015 UL943 GFCI Safety Standard.

Hubbell Self Test GFCI Patented Technology

Hubbell AUTOGUARD® GFCI receptacles continually test and monitor for “people protection capability” automatically. This patented safety feature includes disconnecting power to the receptacle if critical components are damaged and GFCI protection is lost. GFCI auto-monitoring is conducted continuously within every 30 seconds.

Also, clear visual indicators are provided on the device face representing power status, trip condition, ground fault condition and end of life status. In addition, for added safety, power will be denied to the receptacle face if reverse wiring of line and load was to occur.

UL (Underwriters Laboratory) now requires all manufacturers to provide self test monitoring capability effective June 29, 2015. When was the last time you tested a GFCI receptacle? Industry studies indicate only a very small number of installations are actually being tested as is recommended by the manufacturer and UL. This is the fundamental reason this revision has been incorporated into UL943 standard for 2015.



Each GFR must automatically monitor GFCI functionality periodically	If the unit can no longer provide GFCI protection, it must comply with the following	Reverse line and load miswire function – (repeated)
Automatically test within (5) seconds of power to line and load terminals; periodically means every (3) hours or less.	Deny Power (trip with the inability to reset); if unit does reset it is subject to the next auto-monitoring test cycle. Visual and/or audible indication that it no longer can provide protection.	If the line conductor is wired to the load terminal, power to the receptacle face will be denied. This includes both the initial installation and any subsequent reinstallations.



Isolated Ground



Hospital Grade



Night Light



SNAPConnect®



Audible Alarm



Tamper-Resistant



Combo Switch/GFCI



Weather Resistant

Features and Benefits

- **Patented AUTOGUARD® Technology** — Continuous Self Test functionality and disconnects power to receptacle if critical components are damaged and GFCI protection is lost
- **Federal Communications Commission Part 15** — Compliant for radiated and conducted emissions
- **Thermoplastic Nylon Housing** — High Impact and Ultraviolet Resistant construction provides resilience in harsh environments
- **Clear Visual Indication of GFR Status** — LED Indicating Lights:
 - Green LED (power to the device)
 - Red LED (trip condition/ground fault condition)
 - Flashing Red LED (end of life)
- **Internal Back Wiring Clamp and Guide Pocket** — Quick and dependable termination
- **Protection Against Line and Load Reversal** — No power to the face or downstream receptacles if device is miswired
- **Installation Ease, Lower Labor Cost** — With auto-grounding clip, captive mounting screws and single tab “breakoff” ears and full “breakoff” for OEM raised covers
- **Night Light Option** — Light sensor controls for automatic “ON/OFF” and custom dual lens for optimum light output

Ground Fault Products



Fed. Spec.

Meets UL Standard 943
Class A GFCI

Features and Benefits

Extra Heavy Duty Industrial and Hospital Grade GFCI Receptacles Tamper-Resistant and Weather Resistant

- Corrosion resistant construction includes nickel plated brass mounting strap, line/load terminals, face contacts, internal contacts and wiring terminal clamps; stainless steel terminal and mounting screws
- Selective double layer conformal coating of printed circuit board, critical components and connections
- Superior materials including polyester "V0" thermoplastic housing (UV Resistant); 7025 high thermal conductivity copper alloy contacts
- Dust Test (UL 943) compliant; resistance to contaminants, moisture and dust

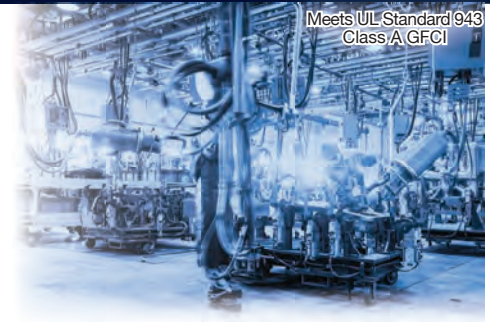

AUTOGUARD® Self Test GFCI Receptacles Tamper-Resistant and Weather Resistant



Description	Rating	Color	Industrial	Industrial Hospital Grade
Extra Heavy Duty Industrial Ground Fault Receptacle 15A 125V Feed Through Tamper and Weather Resistant		Black	GFSG5262BLK	GFSG8200BLK
		Brown	GFSG5262	GFSG8200
		Gray	GFSG5262GRY	GFSG8200GRY
		Ivory	GFSG5262I	GFSG8200I
		Red	GFSG5262R	GFSG8200R
White	GFSG5262W	GFSG8200W		
Extra Heavy Duty Industrial Ground Fault Receptacle 20A 125V Feed Through Tamper and Weather Resistant		Black	GFSG5362BLK	GFSG8300BLK
		Brown	GFSG5362	GFSG8300
		Gray	GFSG5362GRY	GFSG8300GRY
		Ivory	GFSG5362I	GFSG8300I
		Red	GFSG5362R	GFSG8300R
White	GFSG5362W	GFSG8300W		

Note: GFCI type receptacles should not be used in critical care patient areas or for electrical life support equipment applications because of the possibility of power interruption. All GFCI receptacles listed above are furnished with both a matching color thermoplastic wallplate, and a SS26 302/304 super stainless steel wallplate. 20 amp feed-through capability. Note – yellow version comes with SS plate only See page Tech-10 for Tamper-Resistant and Weather Resistant descriptions.

GFCI Receptacle Specifications per GFCI Products Listed (Pages K-3 to K-8)

Trip Level	4 to 6 mA.
Trip Time	.025 second nominal.
Frequency	60 Hz.
Voltage	120V AC +10% - 15% (102V to 132V).
Amperage	15A/20A, 20A Feed-Thru.
Maximum Interrupting Capacity	10,000A.
Operating Temperature	-35°C to 66°C or -30°F to 150°F.
Maximum Humidity	95%.
Dust Resistant	Meets UL 943, section 6.20 for resistance to dust contaminants
Corrosion Resistant	Meets UL 943, section 6.21 for resistance to corrosion
FCC Part 15 Class B	Certified conformance to radiated and conducted emission testing per FCC
Immunity to noise	Exceed UL 943 of .5V over a frequency range of 150kHz to 230MHz disturbances
Listings and Standards	Meets UL498 for receptacles, UL943 Class A for GFCIs UL File E41978 CSA Certified.
Codes	Meets all NEC® and CEC requirements. NEMA WD-6 ANSI 73.

NEC® is a registered trademark of the National Fire Protection Association (NFPA).

Ground Fault Products



Meets UL Standard 943
Class A GFCI

Features and Benefits

Heavy Duty Commercial Tamper-Resistant GFCI Receptacles

- Patented shutter design for tamper-resistant protection
- Compliant with NEC® 406.12 and NEC® 517.18(C)
- Patented AUTOGUARD® self test technology includes disconnecting power to the receptacle if critical components are damaged and GFCI protection is lost
- Alarm version provides audible notification of a trip condition
- Thermoplastic wall plate included

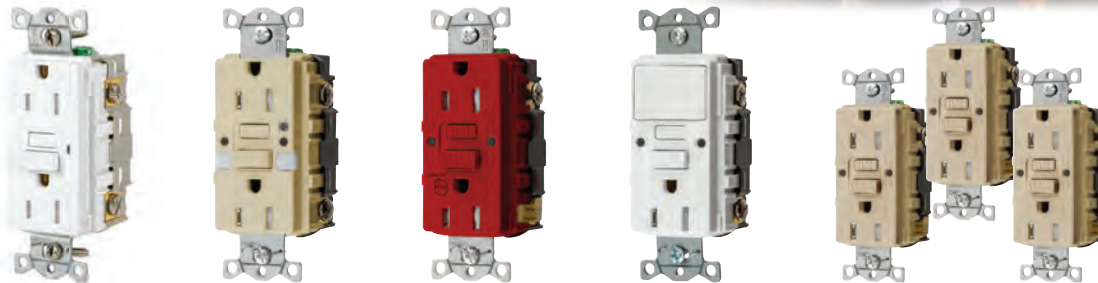

Tamper-Resistant

Rating	Color	Standard	Night Light Two LED Night Lights	Alarm	Combination Switch 15A 120V Switch	Standard 3-Pack Three Devices per Pack
	Black	GFTR15BLK	GFTRST15BKNL	GFTRST15BKB	—	—
	Brown	GFTR15	GFTRST15NL	GFTRST15B	—	—
	Gray	GFTR15GRY	GFTRST15GYNL	GFTRST15GYB	—	—
	Ivory	GFTR15I	GFTRST15INL	GFTRST15IB	GFSPST15I	GFTRST15I3
	Light Almond	GFTR15LA	GFTRST15LANL	GFTRST15LAB	GFSPST15LA	GFTRST15LA3
	Red	GFTR15R	GFTRST15RNL	GFTRST15RB	—	—
	White	GFTR15W	GFTRST15WNL	GFTRST15WB	GFSPST15W	GFTRST15W3
	Black	GFTR20BLK	GFTRST20BKNL	GFTRST20BKB	—	—
	Brown	GFTR20	GFTRST20NL	GFTRST20B	—	—
	Gray	GFTR20GRY	GFTRST20GYNL	GFTRST20GYB	—	—
	Ivory	GFTR20I	GFTRST20INL	GFTRST20IB	—	GFTRST20I3
	Light Almond	GFTR20LA	GFTRST20LANL	GFTRST20LAB	—	GFTRST20LA3
	Red	GFTR20R	GFTRST20RNL	GFTRST20RB	—	—
	White	GFTR20W	GFTRST20WNL	GFTRST20WB	—	GFTRST20W3



Hospital Grade ● Tamper-Resistant



Rating	Color	Night Light Two LED Night Lights	Alarm
	Black	GFTRST82BKNL	GFTRST82BKB
	Brown	GFTRST82NL	GFTRST82B
	Gray	GFTRST82GYNL	GFTRST82GYB
	Ivory	GFTRST82INL	GFTRST82IB
	Light Almond	GFTRST82LANL	GFTRST82LAB
	Red	GFTRST82RNL	GFTRST82RB
	White	GFTRST82WNL	GFTRST82WB
	Black	GFTRST83BKNL	GFTRST83BKB
	Brown	GFTRST83NL	GFTRST83B
	Gray	GFTRST83GYNL	GFTRST83GYB
	Ivory	GFTRST83INL	GFTRST83IB
	Light Almond	GFTRST83LANL	GFTRST83LAB
	Red	GFTRST83RNL	GFTRST83RB
	White	GFTRST83WNL	GFTRST83WB

Product Dimensions

GFCI Receptacle	
A	3.27 (83.1)
B	2.75 (69.8)
C	1.75 (44.5)
D	1.47 (37.4)
E	1.10 (27.9)

Note: GFCI type receptacles should not be used in critical care patient areas or for electrical life support equipment applications because of the possibility of power interruption. All GFCI receptacles are furnished with a matching color thermoplastic wallplate, 20 amp feed-through capability.

Dimensions in Inches (mm)

NEC® is a registered trademark of the National Fire Protection Association (NFPA).

Features and Benefits

Heavy Duty Commercial Standard GFCI Receptacles

- Patented AUTOGUARD® self test technology includes disconnecting power to the receptacle if critical components are damaged and GFCI protection is lost
- Internal back wiring clamp and guide for quick and secure termination
- Night light option includes light sensor controls for automatic ON and OFF, custom dual lens for optimum light output

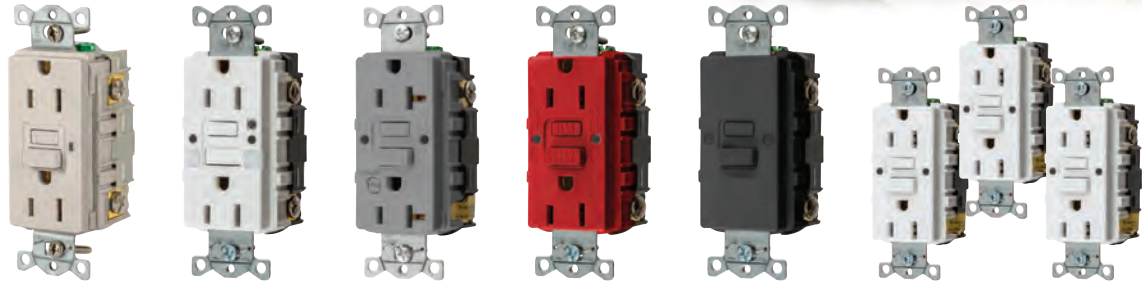

Standard

Rating	Color	Standard	Night Light	Two LED Night Lights	Alarm	Assembled in USA	Blank Face Available in 20A Only	Standard 3-Pack Three Devices per Pack
	Black	GFR15BLK	GFRST15BKNL	GFRST15BKB	GFRST15BKU	—	—	—
	Brown	GFR15	GFRST15NL	GFRST15B	GFRST15U	—	—	—
	Gray	GFR15GRY	GFRST15GYNL	GFRST15GYB	GFRST15GYU	—	—	—
	Ivory	GFR15I	GFRST15INL	GFRST15IB	GFRST15IU	—	—	GFRST15I3
	Light Almond	GFR15LA	GFRST15LANL	GFRST15LAB	GFRST15LAU	—	—	GFRST15LA3
	Red	GFR15R	GFRST15RNL	GFRST15RB	GFRST15RU	—	—	—
	White	GFR15W	GFRST15WNL	GFRST15WB	GFRST15WU	—	—	GFRST15W3
	Black	GFR20BLK	GFRST20BKNL	GFRST20BKB	GFRST20BKU	GFBFST20BK	—	—
	Brown	GFR20	GFRST20NL	GFRST20B	GFRST20U	GFBFST20U	—	—
	Gray	GFR20GRY	GFRST20GYNL	GFRST20GYB	GFRST20GYU	GFBFST20GY	—	—
	Ivory	GFR20I	GFRST20INL	GFRST20IB	GFRST20IU	GFBFST20I	GFRST20I3	—
	Light Almond	GFR20LA	GFRST20LANL	GFRST20LAB	GFRST20LAU	GFBFST20LA	GFRST20LA3	—
	Red	GFR20R	GFRST20RNL	GFRST20RB	GFRST20RU	GFBFST20R	—	—
	White	GFR20W	GFRST20WNL	GFRST20WB	GFRST20WU	GFBFST20W	GFRST20W3	—



Standard SNAPConnect®

Rating	Color	Standard	Assembled in USA
	Black	SNAPGF15BLK	GFRST15SNAPBKNA
	Brown	SNAPGF15	GFRST15SNAPNA
	Gray	SNAPGF15GRY	GFRST15SNAPGYNA
	Ivory	SNAPGF15I	GFRST15SNAPINA
	Light Almond	SNAPGF15LA	GFRST15SNAPLANA
	Red	SNAPGF15R	GFRST15SNAPRNA
	White	SNAPGF15W	GFRST15SNAPWNA
	Black	SNAPGF20BLK	GFRST20SNAPBKNA
	Brown	SNAPGF20	GFRST20SNAPNA
	Gray	SNAPGF20GRY	GFRST20SNAPGYNA
	Ivory	SNAPGF20I	GFRST20SNAPINA
	Light Almond	SNAPGF20LA	GFRST20SNAPLANA
Red	SNAPGF20R	GFRST20SNAPRNA	
White	SNAPGF20W	GFRST20SNAPWNA	

SNAPConnect® Right Angle Pigtailed Terminal

Description	Type	Catalog Number
Clear right angle terminal with 6 inch leads, 600V, #12 AWG THHN/THWN-2, Polycarbonate housing material.	Solid	SNAP1RA
	Stranded	SNAP2RA
Same as above. Assembled in USA.	Solid	SNAP1RNA
	Stranded	SNAP2RNA
Clear right angle terminal with 6 inch leads #12 AWG THHN/THWN-2; Polycarbonate housing material with WAGO terminals.	Solid	SNAP1RAM2
	Stranded	SNAP2RAM2
Same as above. Assembled in USA.	Solid	SNAP1RNAM2
	Stranded	SNAP2RNAM2

Note: GFCI type receptacles should not be used in critical care patient areas or for electrical life support equipment applications because of the possibility of power interruption. All GFCI receptacles are furnished with a matching color thermoplastic wallplate, 20 amp feed-through capability.

Features and Benefits

Heavy Duty Commercial Standard Hospital Grade GFCI Receptacles

- Fed. Spec UL Listed, Hospital Grade
- Green power indicator and red trip indicator
- Patented AUTOGUARD® self test technology
- Flush, nylon face, back and side wired, multiple drive screws, self-grounding staple

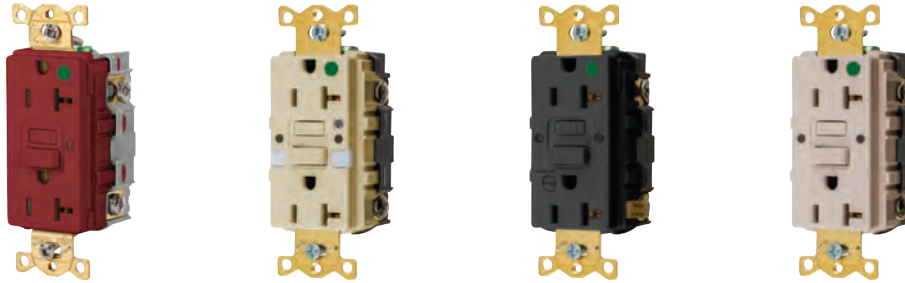

Hospital Grade ●

Rating	Color	Standard	Night Light Two LED Night Lights	Alarm	Assembled in USA
	Black	GFR82BLK	GFRST82BKNL	GFRST82BKB	GFRST82BKU
	Brown	GFR82	GFRST82NL	GFRST82B	GFRST82U
	Gray	GFR82GRY	GFRST82GYNL	GFRST82GYB	GFRST82GYU
	Ivory	GFR82I	GFRST82INL	GFRST82IB	GFRST82IU
	Light Almond	GFR82LA	GFRST82LANL	GFRST82LAB	GFRST82LAU
	Red	GFR82R	GFRST82RNL	GFRST82RB	GFRST82RU
	White	GFR82W	GFRST82WNL	GFRST82WB	GFRST82WU
	Black	GFR83BLK	GFRST83BKNL	GFRST83BKB	GFRST83BKU
	Brown	GFR83	GFRST83NL	GFRST83B	GFRST83U
	Gray	GFR83GRY	GFRST83GYNL	GFRST83GYB	GFRST83GYU
	Ivory	GFR83I	GFRST83INL	GFRST83IB	GFRST83IU
	Light Almond	GFR83LA	GFRST83LANL	GFRST83LAB	GFRST83LAU
	Red	GFR83R	GFRST83RNL	GFRST83RB	GFRST83RU
	White	GFR83W	GFRST83WNL	GFRST83WB	GFRST83WU

Hospital Grade ● SNAPConnect®



Rating	Color	Standard
	Black	—
	Brown	—
	Gray	—
	Ivory	SNAPGF82I
	Light Almond	SNAPGF82LA
	Red	SNAPGF82R
	White	SNAPGF82W
	Black	SNAPGF83BLK
	Brown	SNAPGF83
	Gray	SNAPGF83GRY
	Ivory	SNAPGF83I
	Light Almond	SNAPGF83LA
	Red	SNAPGF83R
	White	SNAPGF83W

SNAPConnect® Right Angle Pigtailed Terminal



Description	Type	Catalog Number
Clear right angle terminal with 6 inch leads, 600V, #12 AWG THHN/THWN-2, Polycarbonate housing material.	Solid	SNAP1RA
	Stranded	SNAP2RA
Same as above. Assembled in USA.	Solid	SNAP1RNA
	Stranded	SNAP2RNA
Clear right angle terminal with 6 inch leads #12 AWG THHN/THWN-2; Polycarbonate housing material with WAGO terminals.	Solid	SNAP1RAM2
	Stranded	SNAP2RAM2
Same as above. Assembled in USA.	Solid	SNAP1RNAM2
	Stranded	SNAP2RNAM2

Note: GFCI type receptacles should not be used in critical care patient areas or for electrical life support equipment applications because of the possibility of power interruption. All GFCI receptacles are furnished with a matching color thermoplastic wallplate, 20 amp feed-through capability.

Ground Fault Products



Meets UL Standard 943
Class A GFCI

Features and Benefits

Heavy Duty Commercial Tamper and Weather Resistant GFCI Receptacles

- Patented shutter design for tamper-resistant protection
- Meets NEC® requirements for TR (406.12) and WR (406.9), UV and corrosion resistance for harsh and damp applications
- Patented AUTOGUARD® self test technology
- Protects against line and load reversal, no power to the face or downstream if device is miswired



Tamper-Resistant Weather Resistant



Rating	Color	Standard	Assembled in USA	Isolated Ground	SNAPConnect®	Right Angle Pigtailed Terminal		
	Black	GFRTW15BLK	GFTWRST15BKU	GFTWRST15BKIG	SNAPGFTW15BLK	Clear right angle terminal with 6 inch leads, 600V, #12 AWG THHN/THWN-2, Polycarbonate housing material.		
	Brown	GFRTW15	GFTWRST15U	GFTWRST15IG	SNAPGFTW15			
	Gray	GFRTW15GRY	GFTWRST15GYU	GFTWRST15GYIG	SNAPGFTW15GRY			
	Ivory	GFRTW15I	GFTWRST15IU	GFTWRST15IIG	SNAPGFTW15I			
	Light Almond	GFRTW15LA	GFTWRST15LAU	GFTWRST15LAIG	SNAPGFTW15LA			
	Orange	—	—	GFTWRST15ORIG	—			
	Red	GFRTW15R	GFTWRST15RU	GFTWRST15RIG	SNAPGFTW15R		Solid SNAP1RA	
	White	GFRTW15W	GFTWRST15WU	GFTWRST15WIG	SNAPGFTW15W		Stranded SNAP2RA	
		Black	GFRTW20BLK	GFTWRST20BKU	GFTWRST20BKIG		SNAPGFTW20BLK	Same as above. Assembled in USA.
		Brown	GFRTW20	GFTWRST20U	GFTWRST20IG		SNAPGFTW20	
Gray		GFRTW20GR	GFTWRST20GYU	GFTWRST20GYIG	SNAPGFTW20GRY			
Ivory		GFRTW20I	GFTWRST20IU	GFTWRST20IIG	SNAPGFTW20I			
Light Almond		GFRTW20LA	GFTWRST20LAU	GFTWRST20LAIG	SNAPGFTW20LA			
Orange		—	—	GFTWRST20ORIG	—			
Red		GFRTW20R	GFTWRST20RU	GFTWRST20RIG	SNAPGFTW20R	Solid SNAP1RNA		
White		GFRTW20W	GFTWRST20WU	GFTWRST20WIG	SNAPGFTW20W	Stranded SNAP2RNA		



Hospital Grade ● Tamper-Resistant Weather Resistant



Rating	Color	Standard	Assembled in USA	Isolated Ground	SNAPConnect®	Right Angle Pigtailed Terminal		
	Black	GFRTW82BLK	GFTWRST82BKU	GFTWRST82BKIG	—	Clear right angle terminal with 6 inch leads, 600V, #12 AWG THHN/THWN-2, Polycarbonate housing material.		
	Brown	GFRTW82	GFTWRST82U	GFTWRST82IG	—			
	Gray	GFRTW82GRY	GFTWRST82GYU	GFTWRST82GYIG	SNAPGFTW82GRY			
	Ivory	GFRTW82I	GFTWRST82IU	GFTWRST82IIG	SNAPGFTW82I			
	Light Almond	GFRTW82LA	GFTWRST82LAU	GFTWRST82LAIG	SNAPGFTW82LA			
	Orange	—	—	GFTWRST82ORIG	—			
	Red	GFRTW82R	GFTWRST82RU	GFTWRST82RIG	SNAPGFTW82R		Solid SNAP1RA	
	White	GFRTW82W	GFTWRST82WU	GFTWRST82WIG	SNAPGFTW82W		Stranded SNAP2RA	
		Black	GFRTW83BLK	GFTWRST83BKU	GFTWRST83BKIG		SNAPGFTW83BLK	Same as above. Assembled in USA.
		Brown	GFRTW83	GFTWRST83U	GFTWRST83IG		SNAPGFTW83	
Gray		GFRTW83GRY	GFTWRST83GYU	GFTWRST83GYIG	SNAPGFTW83GRY			
Ivory		GFRTW83I	GFTWRST83IU	GFTWRST83IIG	SNAPGFTW83I			
Light Almond		GFRTW83LA	GFTWRST83LAU	GFTWRST83LAIG	SNAPGFTW83LA			
Orange		—	—	GFTWRST83ORIG	—			
Red		GFRTW83R	GFTWRST83RU	GFTWRST83RIG	SNAPGFTW83R	Solid SNAP1RNA		
White		GFRTW83W	GFTWRST83WU	GFTWRST83WIG	SNAPGFTW83W	Stranded SNAP2RNA		

Note: GFCI type receptacles should not be used in critical care patient areas or for electrical life support equipment applications because of the possibility of power interruption. All GFCI receptacles are furnished with a matching color thermoplastic wallplate, 20 amp feed-through capability.



Meets UL Standard 943
Class A GFCI

Features and Benefits

Heavy Duty Commercial Weather Resistant GFCI Receptacles

- Patented AUTOGUARD® self test technology
- Meets NEC® requirements for weather resistance (406.9), UV and corrosion resistance for harsh and damp applications
- Protects against line and load reversal, no power to the face or downstream if device is miswired



Weather Resistant

Rating	Color	Standard	Rating	Color	Standard
 15A 125V NEMA 5-15R UL CSA 0.5 HP	Black	GFRWR15BLK	 20A 125V NEMA 5-20R UL CSA 1 HP	Black	GFRWR20BLK
	Brown	GFRWR15		Brown	GFRWR20
	Gray	GFRWR15GRY		Gray	GFRWR20GRY
	Ivory	GFRWR15I		Ivory	GFRWR20I
	Light Almond	GFRWR15LA		Light Almond	GFRWR20LA
	Red	GFRWR15R		Red	GFRWR20R
White	GFRWR15W	White	GFRWR20W		

Note: GFCI type receptacles should not be used in critical care patient areas or for electrical life support equipment applications because of the possibility of power interruption. All GFCI receptacles are furnished with a matching color thermoplastic wallplate, 20 amp feed-through capability.

Features and Benefits

UL 508 1.5HP GFCI Receptacles

Hubbell AUTOGUARD® GFR products continually test and monitor for “people protection capability” automatically. This patented safety feature includes disconnecting power to the receptacle if critical components are damaged and GFCI protection is lost. Also, visual indicators are clearly provided on the device face representing “power status”, “trip condition”, “ground fault condition” and “end of life status”.

- Blank face 1.5 horsepower motor control rated switch UL508 listed. Also listed to Underwriters Laboratories standard 943 for Class A GFCI
- If wired incorrectly there will be no power to the face or to downstream receptacles for added safety. (2) LED indicators provide immediate status of power, trip condition and ability to provide GFCI protection
- In addition to providing Class A GFCI protection, the HP series includes a 1.5 HP rating for motor control switching per UL508



GFBFHP20GY



UL 508 1.5HP GFCI

Rating	Color	Standard
20A 125V 1.5 HP	Black	GFBFHP20BK
	Brown	GFBFHP20
	Gray	GFBFHP20GY
	Ivory	GFBFHP20I
	Light Almond	GFBFHP20LA
	Red	GFBFHP20R
	White	GFBFHP20W

Note: GFCI type receptacles should not be used in critical care patient areas or for electrical life support equipment applications because of the possibility of power interruption. All GFCI receptacles are furnished with a matching color thermoplastic wallplate, 20 amp feed-through capability.

NEC® is a registered trademark of the National Fire Protection Association (NFPA).

Features and Benefits

Heavy Duty SNAPConnect® Commercial Grade GFCI Receptacles

Requires minimal box space

- Compact size
- Clean finished look

Installation ease

- Self-grounding staple

Audible SNAP, indicates solid connection

- Secure, easy grip latch

Inspection of power contacts

- Clear terminal housing
- No exposed metal

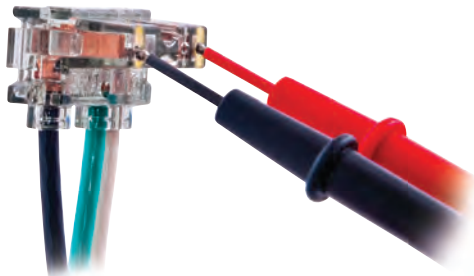

No Special Tester Required
.085 inch keyhole accepts the probe points found on the most common voltage testers and digital multi-meters



Labor Savings Feature!



Save one Minute!

Rough-in the SNAPConnect® terminal instead of pigtails.



Save Over Three Minutes!

Remove protective packaging and SNAPConnect® device to the circuit.



Complete Trim-Out in Less Than One Minute!

Secure mounting screws, attach wallplate, job complete.



Features and Benefits

Arc Fault AFCI Receptacles

- Meets new 2017 National Electric Code for AFCI Protection
- Qualified to Federal Specification Listing WC596
- Meets or exceeds UL requirements for tripping time on series and parallel arcs
- Tamper-Resistant and self grounding construction are standard features
- Green power ON LED indicator
- Automatically tests the AFCI each time the reset button is pressed in place
- No reset when tested if AFCI functionality is compromised



Arc Fault AFCI Receptacles



Rating	Color	Standard	Rating	Color	Standard	Blank Face
	Black	AFR15TRBK		Black	AFR20TRBK	—
	Brown	AFR15TR		Brown	AFR20TR	—
	Gray	AFR15TRGY		Gray	AFR20TRGY	—
	Ivory	AFR15TRI		Ivory	AFR20TRI	AFR20BFI
	Light Almond	AFR15TRLA		Light Almond	AFR20TRLA	AFR20BFW
White	AFR15TRW	White	White	AFR20TRW	—	

Specifications

Ratings		Certifications		Construction	
Amperage	15 Amp/20 Amp	UL1699A	E366570	Termination	Back and Side
Feed-thru	20 Amp Protection	UL498	Receptacle	Terminal	#14-10 AWG
Voltage	120V AC (+10% to 15%) (102V to 132V)	UL Fed Spec	WC-596	Grounding	Self-Grounding Clip
Horsepower	(1) @ Rated Voltage	CSA Standard	C22.2 No. 42	Indicators	Power & Rev Wire
Flammability	Rated V2 per UL 94	CSA Tech	Letter No. M-02A	Configuration	2 Pole, 3 Wire
Operating Temperature	(-35°C to 66°C) or (-30°F to 150°F)	NEMA	WD-6	NEMA	5-15R, 5-20R
		Tamper-Resistant NEC® 406.12; 210.52 – All 15 and 20A 125V, receptacles shall be listed Tamper-Resistant for dwelling installations.			

Note: The Hubbell "AFR" series meets all requirements for an outlet branch-circuit type AFCI; protects branch circuit wiring and extensions to branches such including appliances and cord sets. All GFCI receptacles are furnished with a matching color thermoplastic wallplate.

Product Dimensions

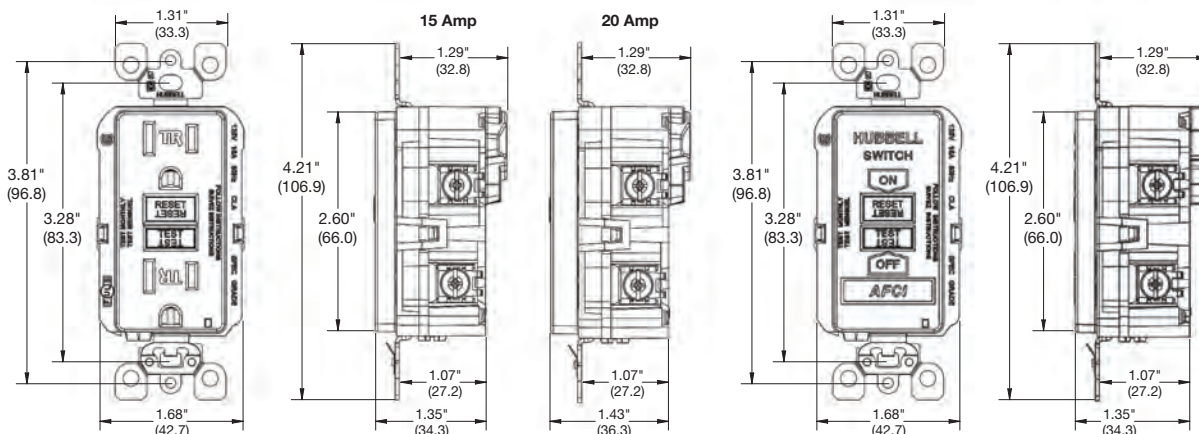

NEC® is a registered trademark of the National Fire Protection Association (NFPA).

Features and Benefits

Dual Function AFCI/GFCI Receptacles

- Cost effective solution conveniently located within living space; clearly visible, easily resettable if necessary
- Dual functionality, interrupts power if a ground fault or arc fault is detected
- Safety feature prevents device from resetting if it can no longer provide protection or is reverse wired
- Intuitive visual indication is provided for power (LED green ON); trip condition (LED green OFF)
- Clear indication if unit can no longer provide protection (LED red flashes) and will not reset



Dual Function AFCI/GFCI Receptacles

Rating	Color	Standard	Rating	Color	Standard
 15A 125V NEMA 5-15R UL CSA 0.5 HP	Black	AFGF15TRBK	 20A 125V NEMA 5-20R UL CSA 1 HP	Black	AFGF20TRBK
	Brown	AFGF15TR		Brown	AFGF20TR
	Gray	AFGF15TRGY		Gray	AFGF20TRGY
	Ivory	AFGF15TRI		Ivory	AFGF20TRI
	Light Almond	AFGF15TRLA		Light Almond	AFGF20TRLA
White	AFGF15TRW	White	AFGF20TRW		

Specifications

Ratings

Amperage	15 Amp/20 Amp
Feed-thru	20 Amp Protection
Voltage	120V AC (+10% to -15%) (102V to 132V)
Horsepower	(1) @ 120V AC
Flammability	Rated V2 per UL 94
Operating Temperature	(-35°C to 66°C) or (-30°F to 150°F)

Certifications

UL1699A	E485931
UL498	Receptacle
UL943	GFCI
UL Fed Spec	WC-596
CSA Standard	C22.2 No. 42
CSA Tech	Letter No. M-02A
NEMA	WD-6

Construction

Termination	Back and Side
Terminal	#14-10 AWG
Grounding	Autoground Clip
Indicators	Power, Trip, End of Life
Configuration	2 Pole, 3 Wire
NEMA	5-15R, 5-20R

Note: All Hubbell "AFGF" series GFCI receptacles are furnished with a matching color thermoplastic wallplate.

Product Dimensions

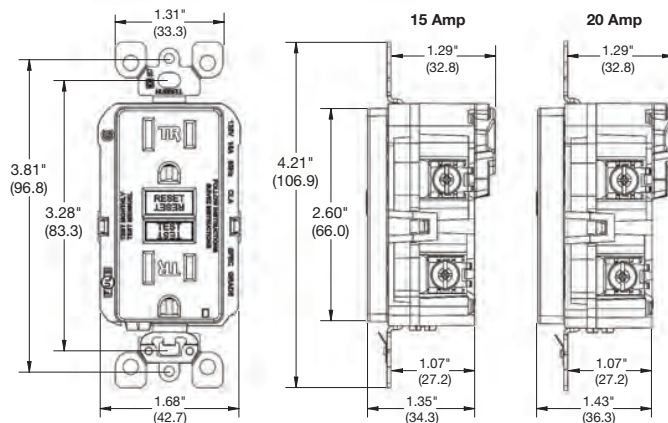

Dimensions in Inches (mm)

Typical Applications Include:

Power Generators, Spas, High Pressure Washers, Power Centers, Refineries and Mobile Power.



The sensing module functions interdependently with a magnetic branch circuit breaker. The module monitors the electrical circuit by use of an external differential current transformer. No direct load is present at the module. In the event of a ground fault, the load is interrupted by way of the hydraulic magnetic circuit breaker utilizing a shunt trip coil.

This line of Sensing Modules is rated from 1 to 50 Amps and circuit current-carrying conductors from 1 to 3 poles.

Product is available with an automatic or manual "safe start" reset feature. The enclosure, when mounted with the supplied gasket, achieves a UL NEMA Type 4X Rating. This module and breaker system is ideal for portable generator integration protecting all outlets on a generator. This system meets the proposed requirements for generators Underwriters Laboratory Standard 2201. UL/cUL 943 Listed, Class A 4-6mA trip level and UL1053 Compliant.



GFSMST120A

GFCI Sensing Module, 50A Maximum

Description	Catalog Number
120V AC Sensing Module Auto	GFSMST120A

GFCI Sensing Module Circuit Breakers

Catalog Number Configurator

Ground Fault Sensing Module Circuit Breaker	A/C Voltage	Amperage	Number of Poles	Sensing Module Required
GFSMCB	120	1 to 50	1	GFSMST120A
	120		2	
	120/240		2	
	120/240		3	



GFSMCB120401P

Example Catalog Numbers: **GFSMCB120401P:** 120V, 40A, 1 Pole
GFSMCB120240203P: 120/240V, 20A, 3 Pole

*Note: Voltage tolerance +10% / -15%.
 Consult factory for other available configurations.*

Wiring Schematics

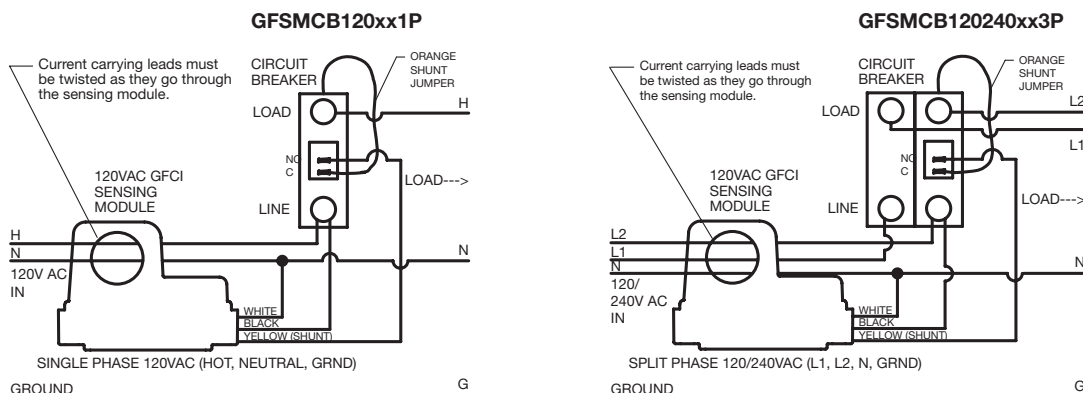

Dimensions in Inches (mm)

Circuit Guard® Wired On Industrial Portable GFCI Plug

Description	Rating	Catalog Number
GFCI plug, manual set, black.	2 pole, 3 wire grounding, 15A, 125V, NEMA 5-15P.	GFPST5266C
GFCI plug, manual set, yellow.	2 pole, 3 wire grounding, 15A, 125V, NEMA 5-15P.	GFPST5266CY
GFCI plug with 1 foot line cord, manual set, yellow, with connector body.	2 pole, 3 wire grounding, 15A, 125V, NEMA 5-15P, NEMA 5-15R.	GFPST1C



GFPST5266C

Circuit Guard® Wired On Commercial Portable GFCI Plug

Description	Rating	Catalog Number
GFCI plug, automatic set field wireable, black.	2 pole, 3 wire grounding, 15A, 125V, NEMA 5-15P.	GFPST515A
GFCI plug, manual set field wireable, black.	2 pole, 3 wire grounding, 15A, 125V, NEMA 5-15P.	GFPST515M



GFPST1C

Specifications

Trip Level	4 to 6 mA.
Trip Time	.025 sec. nominal.
Frequency	60 Hz.
Voltage	120V AC +10% – 15%. Incorporates no voltage release feature.
Amperage	15A.
Maximum Interrupting Capacity	2,000A.
Operating Temperature	-35°C to 66°C or -30°F to 150°F.
Maximum Humidity	95%.
Housing	High-impact, UV stabilized material. UL94V-0 flammability classification.
Input	NEMA 5-15P.
Cord Range	16/3 – 12/3 Type SJ, 18/3 – 12/3 Type S.
Cord Type: Length (GFP1C)	14/3 Type SJTW-A (UL), SJTW (CSA); 1 foot; NEMA 5-15R.
Power “ON” Indication	Indicator light.
Listings	Meets UL943 Class A Listed, CSA Certified.
Codes	Meets all NEC® and CEC requirements.



GFPST515A

Product Dimensions

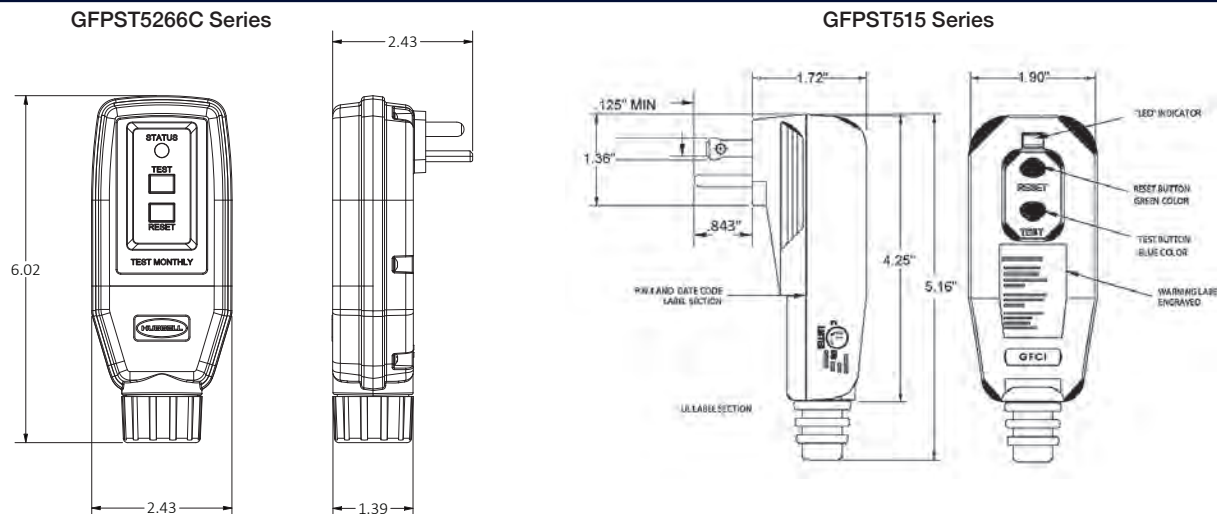

NEC® is a registered trademark of the National Fire Protection Association (NFPA).

Dimensions in Inches (mm)

Ground Fault Products

Features and Benefits

Circuit Guard® Portable GFCI Line Cords

Portable GFCI Line Cords provide ground fault protection both indoors and out. They interrupt electrical power for equipment loads when leakage to ground is 4-6 milliamperes. Available in lengths of 18" (45.7 cm), 6' (182.9 cm), and 25' (762 cm). A 15' (457.2 cm) OEM version with stripped leads is also available. They are offered with an Automatic Set or Manual Set feature to meet your application.

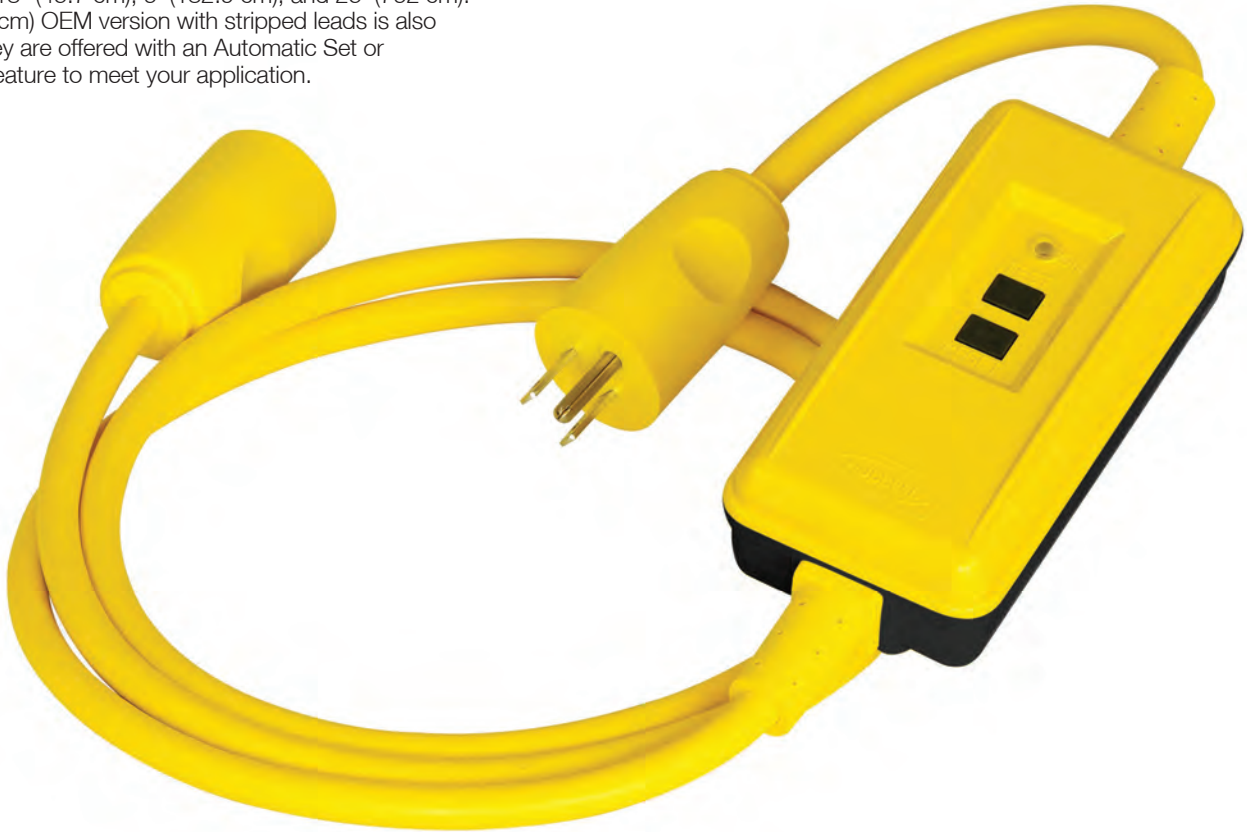

Housing Design

- High impact UV stabilized housing resists dust, sunlight and chemicals for long life
- Watertight GFCI housing for use in harsh environments
- Available in Automatic Set with yellow base or Manual Set with black base



Molded Strain Relief

- Heavy-duty molded strain relief prevents conductor strain and resulting failure



Safety

- One-piece flush sealed keypads for greater reliability and resistance to damage due to impact
- Bright fault indicator light provides fault confirmation from a distance



Plug and Connector

- Heavy-duty molded plug and connector for reliable connection
- Solid (not formed) plug blades are crimped and soldered for a better connection and longer life



GFPST4C15A



GFPST25C15A



GFPST6C15M



GFPSTOEMM



GFPST3C20MTL

Circuit Guard® Portable GFCI Line Cords, 15A 120V AC

Description	Automatic Set	Manual Set
18" (45.7 cm) GFCI line cord.	GFPST4C15A	GFPST4C15M
6' (182.9 cm) GFCI line cord.	GFPST6C15A	GFPST6C15M
25' (762.0 cm) GFCI line cord.	GFPST25C15A	GFPST25C15M
15' (457.2 cm) GFCI power supply cord with stripped leads.	GFPSTOEMA*	GFPSTOEMM*
50' (1524.0 cm) GFCI power supply with Elastogrip® watertight straight blade.	–	GFPST50C15WM
100' (3048.0 cm) GFCI power supply with Elastogrip® watertight straight blade.	–	GFPST100C15WM

Note: *Total length is 15' 4.5" (468.6 cm) including leads: green 4.5" (114.3), black and white 3.5" (88.9). Each pre-stripped .375" (9.5).

Circuit Guard® Portable GFCI Line Cords, 20A 120V AC

Description	Automatic Set	Manual Set
3' (91.4 cm) GFCI line cord.	–	GFPST3C20M

Circuit Guard® Manual Set Twist-Lock Portable GFCI Line Cords

Description	15A 120V AC	20A 120V AC
3' (91.4 cm) GFCI line cord.	GFPST3C15MTL	GFPST3C20MTL

Automatic Set GFCI

Automatically energizes or sets the GFCI for use upon plug in and after the loss of primary power (power failure or unplugging the device). After a ground fault condition, unit must be reset by pushing the reset button. This feature eliminates the need for unit to be reset each time it is plugged in or powered up. Ideal for equipment intended for continuous use where a temporary power failure is likely and undesirable. Examples are pumps, pressure washers, portable signs or lighting and engine heaters.

Manual Set GFCI

Requires the GFCI to be manually set for use by pressing the reset button upon plug in and after loss of primary power (power failure or unplugging the device). Must be manually reset after a ground fault condition. Ideal for applications where operator injury might occur if equipment were to restart after a power failure. Typical equipment includes power drills, saws, lathes and grinders.

	Straight Blade	Twist-Lock®
Input	15A NEMA 5-15P, 20A NEMA 5-20P.	15A NEMA L5-15P HBL47CM20C, 20A NEMA L5-20P HBL23CM11.
Output	15A NEMA 5-15R (except GFPOEMM), 20A NEMA 5-20R.	15A NEMA L5-15R HBL47CM29C, 20A NEMA L5-20R HBL23CM13.

Specifications

Portable GFCI Line Cords

Trip Level	4 to 6 mA.
Trip Time	.025 sec. nominal.
Frequency	60 Hz.
Voltage	120V AC +10% – 15%. Incorporates no voltage release feature.
Amperage	15A/20A.
Maximum Interrupting Capacity	2000A.
Operating Temperature	-35°C to 66°C or -30°F to 150°F.
Maximum Humidity	95%.
Housing	High-impact, UV stabilized PVC. UL 94V-0 flammability classification. Meets UL and CSA watertight requirements. Adhesive bonded.
Cord Type	14/3 SJTW-A (UL), SJTW (CSA). Except GFP3C20M, GFP3C15MTL and GFP3C20MTL are 12/3 SJTW.
Visual Fault Indication Light On	Indicates fault.
Listing and Standards	Meets UL943 Class A, UL File E41978, CSA Certified.
Codes	Meets all NEC® and CEC requirements.

NEC® is a registered trademark of the National Fire Protection Association (NFPA).

Commercial Grade, Portable GFCI Line Cords

Circuit Guard® Portable GFCI Single Outlet, 15A 120V AC - 12/3 SJEOW

Description	Automatic Set	Manual Set
2' (60.9 cm) GFCI line cord.	GFPST2CA	GFPST2CM
25' (762.0 cm) GFCI line cord.	GFPST25CA	GFPST25CM



GFPST2CA

Circuit Guard® Portable GFCI Triple Tap Outlet, 15A 120V AC - 12/3 SJEOW

Description	Automatic Set	Manual Set
2' (60.9 cm) GFCI line cord.	GFPST2TTA	GFPST2TTM
25' (762.0 cm) GFCI line cord.	GFPST25TTA	GFPST25TTM



GFPST2TTA

Circuit Guard® OEM Equipment Integrated Cord Sets, 15A 120V AC - 14/3 SJEOW

Description	Automatic Set	Manual Set
15' (457.2 cm) GFCI with flying leads.	GFPST15LA	GFPST15LM
35' (1066.8 cm) GFCI with flying leads.	GFPST35LA	GFPST35LM



GFPST15LA

15A GFCI In Line GFCI, Single and Triple Tap, 15A 120V AC - 12/3 SJTW

Description	Automatic Set	Manual Set
2' (60.9 cm), 5-15 single tap.	GFPIST15125A	GFPIST15125M
2' (60.9 cm), 5-15 triple tap.	GFPIST15125TRIA	GFPIST15125TRIM



GFPIST15125TRIM

20A GFCI In Line GFCI, Locking, 20A 120V AC - 12/3 SJTW - Type 4X, IP69, and IP69K

Description	Automatic Set	Manual Set
2' (60.9 cm), L5-20 locking.	GFPIST20125LKA	GFPIST20125LKM

20A GFCI In Line GFCI, Locking, 20A 250V AC - 12/3 SJTW - Type 4X, IP69, and IP69K

Description	Automatic Set	Manual Set
2' (60.9 cm), L6-20 locking.	GFPIST20250LKA	GFPIST20250LKM



GFPIST20125LKA

20A GFCI Field-Wired In Line 120V AC

Description	Automatic Set	Manual Set
20A Field Wired In Line	-	GFP20FWM



GFP20FWM

Specifications

Portable GFCI Line Cords

Trip Level	4 to 6 mA.
Trip Time	.025 sec. nominal.
Frequency	60 Hz.
Voltage	120/250V AC +10% - 15%. Incorporates no voltage release feature.
Amperage	15A/20A.
Maximum Interrupting Capacity	2000A.
Operating Temperature	-35°C to 66°C or -30°F to 150°F.
Maximum Humidity	95%.
Housing	High-impact, UV stabilized PVC. UL 94V-0 flammability classification. Meets UL and CSA watertight requirements. Adhesive bonded. Indicates fault.
Visual Fault Indication Light On Listing and Standards	Meets UL943 Class A, UL File E41978, CSA Certified.
Codes	Meets all NEC® and CEC requirements.

NEC® is a registered trademark of the National Fire Protection Association (NFPA).

IP21
SUITABILITY



GFP15M

Multiple Outlet Portable GFCI

Description	Rating	Receptacles	Plug	Catalog Number
4 outlet, manual set, yellow.	15A, 120V AC	(2) Duplex 5-15R	NEMA 5-15P	GFP15M
4 outlet, manual set, yellow.	20A, 120V AC	(2) Duplex 5-20R	NEMA 5-20P	GFP20M



GFMST20

GFCI Module - UL Type 3R Rated

Description	Rating	Catalog Number
GFCI module, manual set, yellow.	20A, 120V AC, 60 Hz	GFMST20
GFCI module, auto set, yellow.	20A, 120V AC, 60 Hz	GFMST20A



GFT2G

GFCI Tester

Description	Rating	Catalog Number
Ground fault tester.	120V AC	GFT2G

- Designed to measure the trip level of portable or “wired-in” GFCI’s in a range of 2-7mA. Leakage level can be adjusted from 2-7mA.
- Ideal for measuring leakage level of GFCI breakers, GFCI portables and GFCI receptacles.

Specifications

	GFP15M / GFP20M	GFMST20 / GFMST20A
Trip Level	4 to 6 mA.	4 to 6 mA.
Trip Time	.025 sec. nominal.	.025 sec. nominal.
Frequency	60 Hz.	60 Hz.
Voltage	120V AC +10% - 15%.	120V AC +10% - 15%.
Maximum Interrupting Capacity	No voltage release feature.	No voltage release feature.
Current	5000A.	5000A.
Operating Temperature	15A / 20A.	20A / 20A Feed-through.
Housing Rating	-35°C to 66°C or -30°F to 150°F.	-35°C to 66°C or -30°F to 150°F.
Input	High-impact, yellow Valox® with protective lift covers.	High-impact, UV stabilized, rigid PVC.
Output	UL 94V-0 flammability classification.	UL 94V-0 flammability classification.
Power Supply Cord	UL Type 3R Rated.	UL Type 3R Rated.
Mounting Screws	#12 AWG stranded conductors (black/white/green).	#12 AWG stranded conductors (black/white/green).
Power “ON” Indication	#12 AWG stranded conductors (red/gray).	#12 AWG stranded conductors (red/gray).
Agency Approvals	N/A.	N/A.
Codes	Self-tapping, combination, #6-32.	Self-tapping, combination, #6-32.
	LED indicator light.	LED indicator light.
	UL Listed, UL498 for receptacles.	UL Listed, CSA Certified.
	Meets UL943 Class A for GFCI’s.	Meets UL943 Class A for GFCI’s.
	Meets all NEC® and CEC requirements.	Meets all NEC® and CEC requirements.

Valox® is a trademark of SABIC Innovative Plastics, acquired from General Electric Company.
NEC® is a registered trademark of the National Fire Protection Association (NFPA).

Applications

Power Generators
Submersible Pumps
Textile

Agricultural Equipment
Cement Cutting Equipment
Food Processing

Production Assembly Equipment
Spa and Hot Tubs
Vending Equipment



Extra Heavy Duty Industrial Circuit Guard® Hard Wired 30A GFCI - UL Type 4X Rated

Description	Voltage	Alarm	Automatic Set	Manual Set
Hard wired, manual set and automatic set GFCIs.	120V AC	None	GFHW13105	GFHW13005
	120V AC	Audible	GFHW13115	GFHW13015
	240V AC	None	GFHW23105	GFHW23005
	240V AC	Audible	GFHW23115	GFHW23015
	120/240V AC	Audible	GFHW33115	GFHW33015
	3Ø 250V AC	None	GFHW531	GFHW530
	3Ø 120/208V AC	None	GFHW431	GFHW430
	3Ø 208V AC	None	GFHW83105	-

Specifications

Electrical Ratings	
Rated Voltage	120V AC, 240V AC, 120/240V AC, 3Ø 250V AC, 3Ø 120/208V AC.
Operating Voltage Range	85% to 110%.
Current	Up to 30A or device rating.
Frequency	60 Hz.
Trip Level	4-6 mA.
Phase	Single.
Response Time	.025 sec. Max.
Dielectric Withstand	1500 VRMS across contact, 4000 VRMS between conductors and enclosure.
Surge Withstand	6000V impulse, 0.5 microseconds rise time 100kHz ringing frequency with 40% decay per cycle.
Let Go Line Voltage	60% of rated.
Grounded Neutral Detection	6 Ohms or less.
Power Up	Manual or automatic reset.
Environmental Ratings	
Housing Rating	UL Type 4X.
Construction	Industrial grade design.
Type	Class A GFCI.
Operating Temperature	-35°C to 66°C, -30°F to 150°F.
Leakage Current @ 93% Humidity	Zero.

Features	
Life (Endurance)	10,000 cycles (6000 with load and 4000 without load). Open neutral protection Trips upon loss of neutral.
Grounded Neutral Protection	Trips if ground and neutral touch at load side.
Power On Indicator	Green light on.
Power Off Indicator	Red blinking light plus optional audible alarm.
Wiring Application	3 Wire Single Phase (Hot, Neutral and Ground), 4 Wire Single Phase (Line 1, Line 2, Neutral and Ground).
Switch Interface	Double Insulated.
Latching Mechanism	Electromagnetic.

Physical Specifications	
Wire Leads	#10 AWG, 24" long.
Unit Color	Gray with black cover.
Label Color on Portable and Hard Wired Units	Automatic reset: yellow background with black lettering. Manual reset: black background with yellow lettering.
Weight	1.40 lbs.

Related Code

Confined Space	OSHA 29 CFR 1926.404 (b) (1) (ii) OSHA 29 CFR 1926.405 (a) (2) (ii) (G)
Construction Sites	NEC 590.6
Commercial Garages	NEC 511.12
Fountains	NEC 680.5B
Spas and Hot Tubs	NEC 680.40
Marinas	NEC 555.3



Automatic Reset GFCI



Manual Reset GFCI

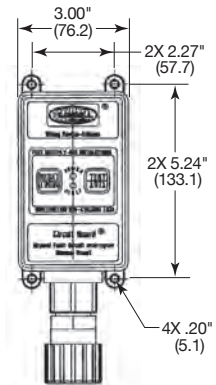

Product Dimensions

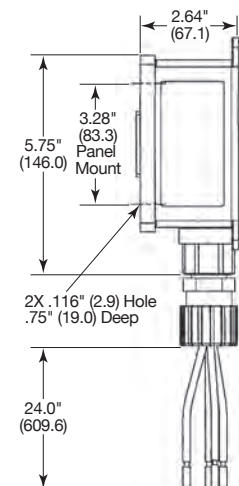

Side View

Dimensions in Inches (mm)

Applications

Pressure Washers
De-icing Equipment
Pipeline Heaters

Portable Electric Heaters
Material Dryers
Automotive Garages

Portable Power Tools
Submersible Pumps
Outdoor Signage



GFPST1311

Extra Heavy Duty Industrial Circuit Guard® Portable 30A GFCI - UL Type 4X Rated

Description	Cord Length	Voltage	Manual Set	Automatic Set
Portable, manual set and automatic set GFCIs.	2' (60.9 cm)	120V AC	GFPST1301	GFPST1311
	6' (182.9 cm)	120V AC	GFPST1305	GFPST1315
	25' (762.0 cm)	120V AC	GFPST1302	GFPST1312
	50' (1524.0 cm)	120V AC	GFPST1303	GFPST1313
	2' (60.9 cm)	240V AC	GFPST2301	GFPST2311
	25' (762.0 cm)	240V AC	GFPST2302	GFPST2312
	6' (182.9 cm)	120/240V AC	GFP3305	GFP3315
	6' (182.9 cm)	3Ø 250V AC	GFP5305	GFP5315
	6' (182.9 cm)	3Ø 120/208V AC	GFPST4305	GFPST4315
	6' (182.9 cm)	3Ø 208V AC	GFP8305	GFP8315



GFPILST30250LKM

Extra Heavy Duty Industrial Circuit Guard® 30A GFCI In Line GFCI - Locking

Description	Cord Length	Voltage	Manual Set	Automatic Set
L5-30 locking.	2' (60.9 cm)	120V AC	GFPILST30125LKM	GFPILST30125LKA
L6-30 locking.	2' (60.9 cm)	250V AC	GFPILST30250LKM	GFPILST30250LKA

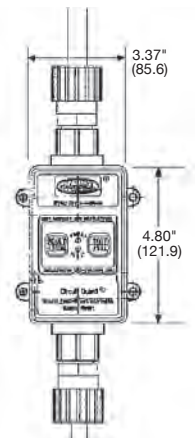

Product Dimensions

Plug and Connector Selector Chart (partial listing)

The chart below is a list of possible Hubbell plug and connector body products that can be used with the Hubbell Portable GFCIs.

Family	Style	Amps	Voltage	Hubbell Catalog Number
Insulgrip®	Straight Blade	15	120V AC	HBL5266C & HBL5269C
Insulgrip®	Twist-Lock®	30	240V AC	HBL2621 & HBL2623
Watertight Safety-Shroud®	Twist-Lock®	30	240V AC	HBL2621SW & HBL2623SW
IEC Pin & Sleeve	Watertight Pin & Sleeve	30	240V AC	HBL330P6W & HBL330C6W
Insulgrip® Pin & Sleeve	Insulgrip® Pin & Sleeve	30	240V AC	HBL330PS2W & HBL330CS2W
Hubbellock®	Hubbellock®	20	120V AC	HBL23035B & HBL23032B

Specifications

Electrical Ratings

Rated Voltage	120V AC, 240V AC, 120/240V AC, 3Ø 250V AC, 3Ø 120/208V AC.
Operating Voltage Range	85% to 110%.
Current	Up to 30A or device rating.
Frequency	60 Hz.
Trip Level	4-6 mA.
Response Time	25 mS Max.
Dielectric Withstand	1500 VRMS across contact, 4000 VRMS between conductors and enclosure.
Surge Withstand	6000V impulse, 0.5 microseconds rise time 100kHz ringing frequency with 40% decay per cycle.
Let Go Line Voltage	60% of rated.
Power Up	Manual or Automatic reset.

Environmental Ratings

Housing Rating	UL Type 4X.
Construction	Industrial grade design.
Type	Meets UL943 Class A GFCI.
Operating Temperature	-35°C to 66°C, -30°F to 150°F.
Leakage Current @ 93% Humidity	Zero.

Features

Life (Endurance)	10,000 cycles (6000 with load and 4000 without load).
Open Neutral Protection	Trips upon loss of neutral.
Grounded Neutral Protection	Trips if ground and neutral touch at load side.
Power On Indicator	Green light on.
Power Off Indicator	Red blinking light plus optional audible alarm.
Wiring Application	3 Wire Single Phase (Hot, Neutral and Ground). 4 Wire Single Phase (Line 1, Line 2, Neutral and Ground).
Switch interface	Double Insulated.
Latching Mechanism	Electromagnetic.

Physical Specifications

Cord Type	2-50', 10/3 SJGOOW. 100', 8/3 SEOW.
Unit Color	Gray with black cover.
Label Color on Portable and Hard Wired Units	Automatic reset: Yellow background with black lettering. Manual reset: Black background with yellow lettering.
Weight	2 ft. 1.8 lbs., 6 ft. 2.7 lbs., 25 ft. 6.8 lbs., 50 ft. 12.4 lbs., 100 ft. 23.3 lbs.

Related Code

Confined Space	OSHA 29 CFR 1926.404 (b) (1) (ii) OSHA 29 CFR 1926.405 (a) (2) (ii) (G)
Construction Sites	NEC 590.6
Commercial Garages	NEC 511.12
Outdoor Signs	NEC 600.10
Spas and Hot Tubs	NEC 680.40
Boat Yards	NEC 555.3

Dimensions in Inches (mm)

Features and Benefits

UL Type 4X

GFCI Protected FD Box

The GFCI protected FD box provides a UL Type 4X GFCI enclosure made for wet and damp locations for 30A 120V and 240V Watertight receptacles. The GFCI response time does not exceed .025 seconds ensuring a safe circuit shut down if the current were to deviate from its path. Auto resetting GFCI box, when connected to an FD box by utilizing a PolyTuff® liquid tight conduit provides advanced safety features for Watertight devices.



GFCI Housing Design

- UL enclosure Type 4X, for wet and damp locations. Components are UL and CSA listed
- 30A, 120V and 240V with auto reset
- GFCI response time is .025 sec. Max.
- Grounded neutral protection trips if ground and neutral touch at load side



FD Box

- Utilizes PolyTuff® liquidtight conduit and fittings
- UL enclosure Type 4X, for wet and damp locations. Components are UL and CSA listed
- For use with single and duplex watertight receptacles (single phase only)

Note: Watertight receptacles purchased separately.

GFCI Protected FD Box

	Description	Catalog Number
FD Box	Watertight FD Box, GFCI Module, 30A 120V, Yellow	HBLWTGF120
	Watertight FD Box, GFCI Module, 30A 240V, Yellow	HBLWTGF240



HBLWTGF120
HBLWTGF240

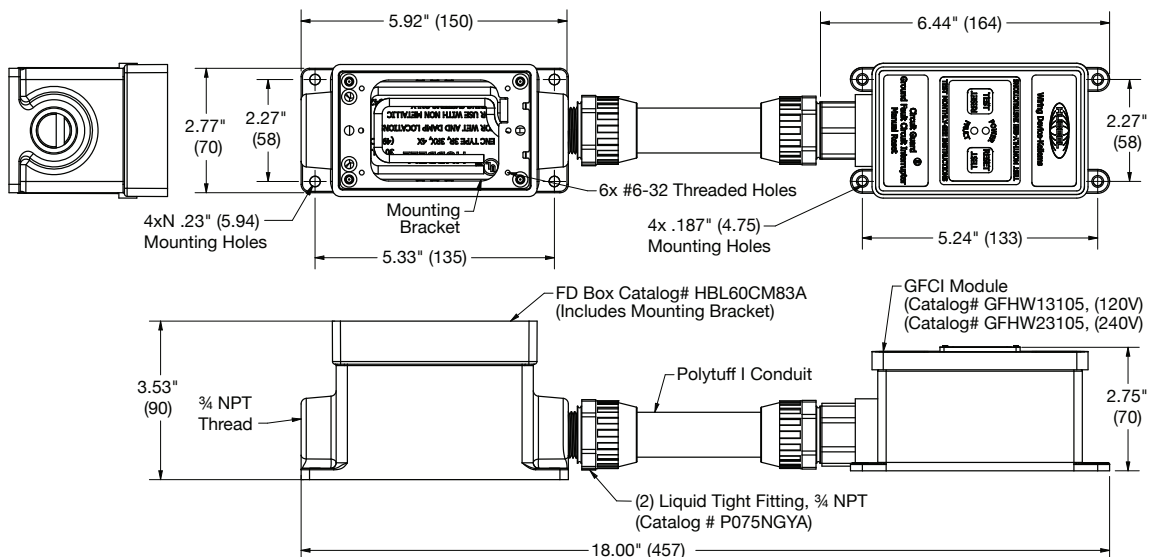

Dimensions in Inches (mm)

Ground Fault Products

Portable GFCI Cord Drops



GFP201251P



Extra Heavy Duty Industrial Circuit Guard® Portable GFCI - Type 4X

Description	Cord length	Amperage	Voltage	Catalog Number
Portabe GFCI Cord Drop with Black	10' (304.8 cm)	20A	125V AC	GFP201251P
SEOOW Cable and Kellems Mesh	10' (304.8 cm)	20A	250V AC	GFP202501P
Strain Relief. Automatic Set	10' (304.8 cm)	20A	208V AC	GFP202081P
	10' (304.8 cm)	30A	125V AC	GFP301251P
	10' (304.8 cm)	30A	250V AC	GFP302501P
	10' (304.8 cm)	30A	208V AC	GFP302081P
	10' (304.8 cm)	30A	3Ø 208V AC	GFP302083P
	10' (304.8 cm)	30A	3Ø 240V AC	GFP302403P
	25' (762.0 cm)	20A	125V AC	GFP201251P25
	25' (762.0 cm)	20A	250V AC	GFP202501P25
	25' (762.0 cm)	20A	208V AC	GFP202081P25
	25' (762.0 cm)	30A	125V AC	GFP301251P25
	25' (762.0 cm)	30A	250V AC	GFP302501P25
	25' (762.0 cm)	30A	208V AC	GFP302081P25
	25' (762.0 cm)	30A	3Ø 208V AC	GFP302083P25
	25' (762.0 cm)	30A	3Ø 240V AC	GFP302403P25

See Page K-19 for product specifications and dimensions



GFHW86108

Extra Heavy Duty Industrial Circuit Guard® Hard Wired 60A GFCI - Type 4X

Description	Amperage	Voltage	Catalog Number
60 Amp Single or 3 -Phase GFCI Class A Automatic Set	60A	1Ø or 3Ø 208V AC	GFHW86108

Specifications

Rated Voltage:	208VAC (150V to ground max) "Class-A"
Operating Voltage Range:	85% to 110% of rated
Current:	Up to 60 Amps or Device Rating
Horsepower:	Up to 20 HP 3Ø/ 7.5HP 1Ø
Frequency:	60 Hz.
Trip Level:	5mA +/- 1mA
Response Time	25ms max at 500Ω fault
Power up:	Auto: Output is on immediately upon power up
Display:	Illuminated TEST/RESET pushbutton, triple indication of Protecting & Power-out versus Fault
Enclosure:	High impact polycarbonate 8x10x4 inch, NEMA 4X
Operational Temperature:	-35° C to 50° C (-31° F to 122° F)
Connections:	60" splicing lead wires and 1" NPT conduit fittings for integration to flexible, EMT, PVC, or burial conduit
Short Circuit:	10KA (panel tested), higher with appropriate fusing
Dielectric With stand:	1500 VRMS across contact, 4000V to enclosure
Voltage Surge With stand:	4000V/2000A 20-times per ICE 6100D-4-5
Agency:	Listed to UL943

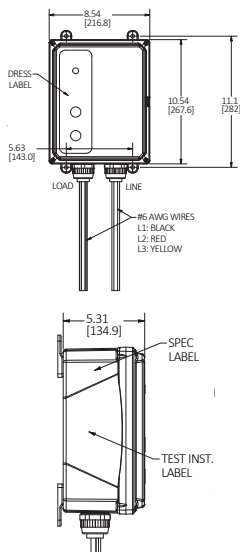

SECTION L

Table of Contents

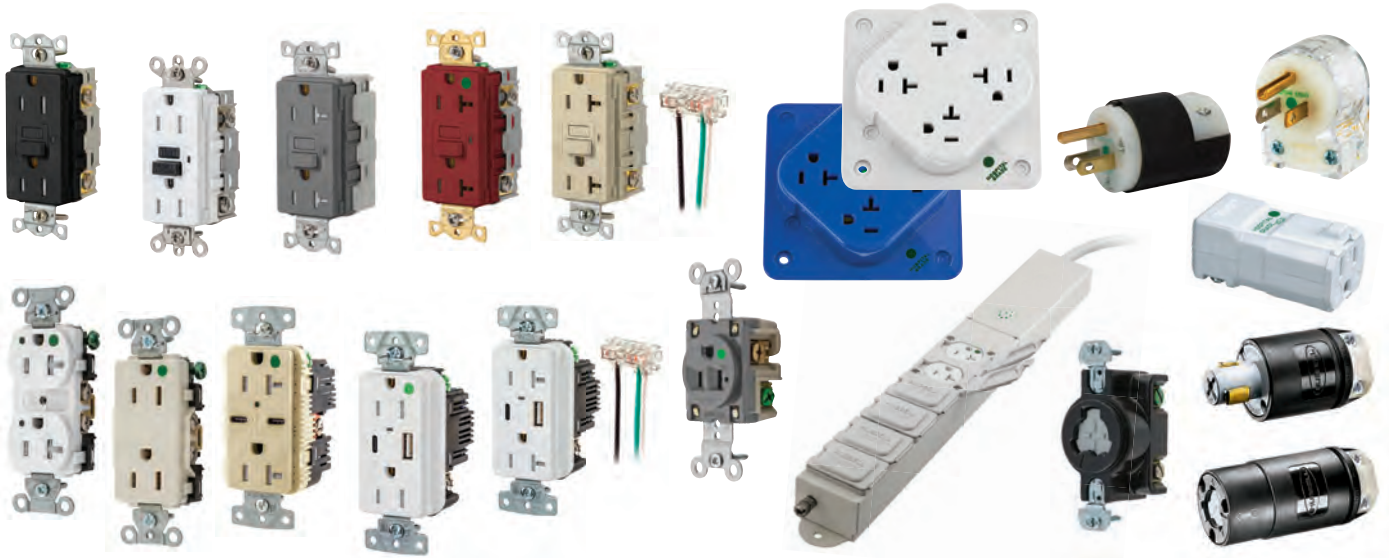

HBL® Extra Heavy Duty Max Hospital Grade Devices

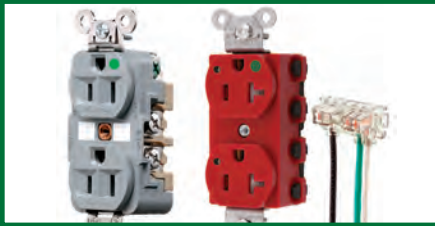

Industrial and Commercial Series GFCIs

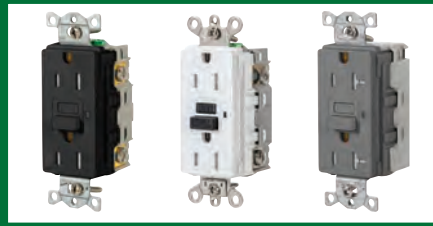

Surge Protection Devices



Product	Page
Products at a Glance	L-2
HBL® Extra Heavy Duty Max Hospital Grade Devices	
Features and Benefits	L-3
Duplex and Style Line® Decorator	L-4
SNAPConnect® Extra Heavy Duty Devices	
GFCI, USB and Surge Receptacles	L-5
Duplex and Style Line® Decorator	L-6
Hubbell-PRO Extra Heavy Duty Devices	L-8
USB Charger Receptacles	L-10
4-PLEX® Receptacles	L-10
Hospital Grade Plugs, Connector Bodies and Receptacles	
15 and 20A, 125V	L-11
15 and 20A, 250V	L-11

Product	Page
Extra Heavy Duty Industrial GFCI Receptacles	L-12
Commercial GFCI Receptacles	
Tamper-Resistant	L-13
Tamper-Resistant and Weather Resistant	L-14
Standard	L-15
Hospital Grade Surge Protection Devices	L-16
Hubbellock® Plugs, Connectors and Receptacles	L-17
Hubbellock® Mobile X-Ray Devices	L-18

Products at a Glance



HBL® Extra Heavy Duty Max Hospital Grade

- Deep nylon body design increases impact and chemical resistance
- One-piece nickel-plated brass ground strap
- ID marking surface for quick circuit identification
- Square head, 10-thread bronze center rivet
- External back wire clamp



Extra Heavy Duty SNAPConnect®

- Hospital and Specification Grade
- SNAPConnect® modular wiring device system saves installation time
- Eliminates screw terminations
- Steel mounting strap, self-grounding
- Compact size requires minimal space



Hubbell-PRO Extra Heavy Duty

- Specification Grade and Hospital Grade
- Tamper-Resistant, NOT Plug Resistant™
- Power indicating LED feature optional
- Circuit ID marking area on Hospital Grade
- Steel mounting strap, self-grounding
- Assembled in USA



USB Charger Receptacles

- Two Type-V and Type A&C port configurations, high power 20 volt, 55 watt USB output
- Heavy duty stainless steel USB ports; rated for 10,000 cord insertions and removals
- Patented Hubbell Tamper-Resistant technology uses cam action shutters
- SNAPConnect® devices, reduce labor costs and installation time



4-PLEX Receptacles

- Hospital Grade and Surge styles
- Mounts directly to 4-inch square box
- "A" and "B" circuit ID molded into face
- Removable knockouts for mounting to octagon concrete ring or box
- Heavy duty, triple wipe, brass power and ground contacts



SpikeShield® Surge Suppression Plug Strips

- UL2930 HCOA's
- UL1449 SPD's available
- 15A and 20A versions
- 6 foot or 15 foot cords available
- USB versions in several models



Hubbellock® Devices

- Mobile X-Ray devices
- Nylon cover, thermoset interior
- Armored, epoxy filled, rubber cord grip

Hospital Products

Features and Benefits

HBL® Extra Heavy Duty Max Hospital Grade Devices

UL requirements for Hospital Grade devices is more stringent than those for standard devices. Hubbell receptacles are designed to meet and exceed the standards.

- Exclusive nickel-plated bypass contact design increases contact pressure, lowering the operating temperature
- Four point grounding system provides redundant grounding for low resistance ground continuity in high abuse areas
- Impact resistant deep face design prevents breakage

Because of these features and others, the benefit is performance, reliability and value for any health care facility.



Housing Design

- Reinforced thermoplastic base provides superior thermal, electrical and mechanical properties
- Providing contact stability, this high performance material will reduce heat buildup giving you long lasting performance
- Deep body design increases impact and chemical resistance



Terminals

- External wiring clamps allow for visual inspection of the terminals
- Unique strand containment feature on the terminal "bundles" the wire, ensuring 100% clamping of wire strands and reducing heat from the termination

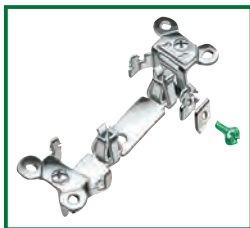

One-Piece Mounting Strap

- Back wired ground terminal allows faster, easier installation
- One-piece nickel-plated brass integral ground strap for greater corrosion resistance
- Patented ground contact provides redundant grounding

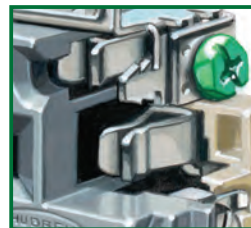

Contacts

- Exclusive bypass contacts are made of nickel-plated brass alloy, increasing blade retention, insuring reliable uninterrupted flow of power
- Barbed assembly arms reduce possibility of face/base separation



Identification

- I.D. marking surface provides quick, sure circuit identification
- All Hospital Grade devices are marked with the green dot symbol, required by UL



Center Rivet

- Square head, 10-thread bronze center rivet won't rotate, reduces stripping and resists corrosion

15 and 20 Ampere, 125 Volts

IP20
SUITABILITY



15A 125V
NEMA 5-15R
UL CSA
0.5 HP



20A 125V
NEMA 5-20R
UL CSA
1 HP

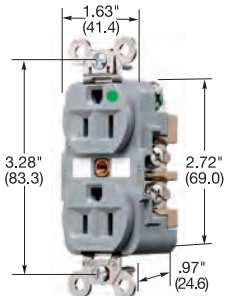

HBL8200GY

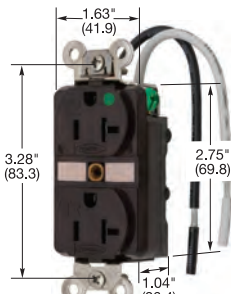

HBL8300SGA

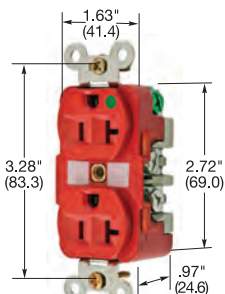

HBL8300RMRI

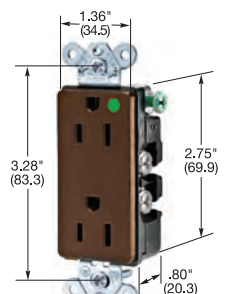

HBL2172

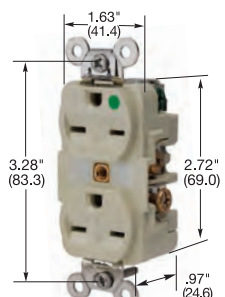

HBL8600I

Dimensions in Inches (mm)

HBL® Extra Heavy Duty Max Hospital Grade Receptacles

Duplex

Flush, thermoplastic polyester face, back and side wired.

Color	Catalog Number
Black	HBL8200BK
Blue	—
Brown	HBL8200
Gray	HBL8200GY
Ivory	HBL8200I
Light Almond	HBL8200LA
Red	HBL8200RED
White	HBL8200W

Catalog Number
—
HBL8300BL
HBL8300
HBL8300GY
HBL8300I
HBL8300LA
HBL8300RED
HBL8300W

Flush, LED illuminated face, back and side wired.

Color	Catalog Number
Gray	HBL8200ILGY
Ivory	HBL8200ILI
Red	HBL8200ILR
White	HBL8200ILW

Catalog Number
HBL8300ILGY
HBL8300ILI
HBL8300ILR
HBL8300ILW

Tamper-Resistant receptacle with wire leads. Complies with requirements of NEC® article 517-18(c).



Color	Catalog Number
Brown	HBL8200SGA
Gray	HBL8200SGGYA
Ivory	HBL8200SGIA
Light Almond	—
Red	HBL8200SGRA
White	HBL8200SGWA

Catalog Number
HBL8300SGA
HBL8300SGGYA
HBL8300SGIA
HBL8300SGLA
HBL8300SGRA
HBL8300SGWA

Isolated ground^A

Color	Catalog Number
Orange	IG8200
Red	IG8200R

Catalog Number
IG8300
IG8300R

MRI Receptacle, Duplex

MRI receptacle, flush, thermoplastic polyester face, back and side wired. 100% non-ferrous.

Color	Catalog Number
Ivory	HBL8200IMRI
Light Almond	HBL8200LAMRI
Red	HBL8200RMRI
White	HBL8200WMRI

Catalog Number
HBL8300IMRI
HBL8300LAMRI
HBL8300RMRI
HBL8300WMRI

Slender/Compact, Duplex

Flush, thermoplastic polyester face, back, and side wired, Fed. Spec. verified.

Color	Catalog Number
Brown	HBL8200H
Gray	HBL8200HG
Green	—
Ivory	HBL8200HI
Light Almond	HBL8200HLA
Red	HBL8200HRED
White	HBL8200HW

Catalog Number
HBL8300H
HBL8300HG
HBL8300HGN
HBL8300HI
HBL8300HLA
HBL8300HRED
HBL8300HW

Style Line® Decorator*

Flush, nylon face, back and side wired.

Color	Catalog Number
Brown	HBL2172
Gray	HBL2172GY
Ivory	HBL2172I
Red	HBL2172R
White	HBL2172WA

Catalog Number
HBL2182
HBL2182GY
HBL2182I
HBL2182R
HBL2182WA

Isolated ground^A

Color	Catalog Number
Ivory	—
Orange	—
White	—

Catalog Number
IG2182I
IG2182
IG2182WA

Single

Flush, nylon face, back and side wired, Fed. Spec. verified.

Color	Catalog Number
Brown	HBL8210
Gray	HBL8210GY
Ivory	HBL8210I
Red	HBL8210R
White	HBL8210W

Catalog Number
HBL8310
HBL8310GY
HBL8310I
HBL8310R
HBL8310W

Panel mount on 1.94 in. (49.2) centers.

Color	Catalog Number
Brown	HBL8284
Ivory	HBL8284I

Catalog Number
—
HBL8384I

Isolated ground^A

Color	Catalog Number
Orange	IG8210

Catalog Number
IG8310

HBL® Extra Heavy Duty Max Hospital Grade Receptacles

250 Volts Duplex

Flush, thermoplastic polyester face, back and side wired.

Color	Catalog Number
Brown	HBL8600
Ivory	HBL8600I

Catalog Number
HBL8400
HBL8400I

Note: ^ASee section N for additional information on isolated ground devices.

*Not Fed. Spec. Listed.

See pages A-47 and A-48 for accessories. See section O for wallplates.

See page Tech-10 for Tamper-Resistant description.

NEC® is a registered trademark of the National Fire Protection Association (NFPA).

Hospital Products

15 and 20 Ampere, 125 Volts

SNAPConnect® GFCI LED Hospital Grade ● Receptacles

Description	Color	Catalog Number	
Hospital Grade SNAPConnect GFCI LED, self-grounding staple, requires connector below, sold separately. Add "NA" suffix for devices Assembled in USA.	Black	SNAPGF82BLK	SNAPGF83BLK
	Brown	SNAPGF82	SNAPGF83
	Gray	SNAPGF82GRY	SNAPGF83GRY
	Ivory	SNAPGF82I	SNAPGF83I
	Light Almond	SNAPGF82LA	SNAPGF83LA
	Red	SNAPGF82R	SNAPGF83R
	White	SNAPGF82W	SNAPGF83W

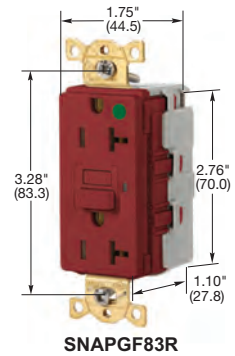
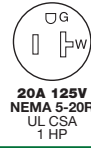
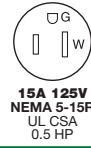

SNAPGF83R

SNAPConnect® GFCI LED Hospital Grade ● Tamper and Weather Resistant

Description	Color	Catalog Number	
Hospital Grade SNAPConnect GFCI TR/WR, self-grounding staple, requires connector below, sold separately. Add "NA" suffix for devices Assembled in USA.	Black	SNAPGFTW82BLK	SNAPGFTW83BLK
	Brown	SNAPGFTW82	SNAPGFTW83
	Gray	SNAPGFTW82GRY	SNAPGFTW83GRY
	Ivory	SNAPGFTW82I	SNAPGFTW83I
	Light Almond	SNAPGFTW82LA	SNAPGFTW83LA
	Red	SNAPGFTW82R	SNAPGFTW83R
	White	SNAPGFTW82W	SNAPGFTW83W

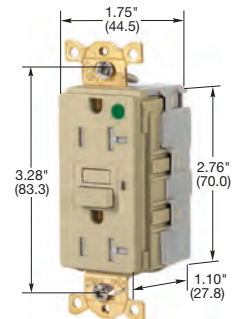

SNAPGFTW83I

Note: GFCI type receptacles should not be used in critical care patient areas or for electrical life support equipment applications because of the possibility of power interruption. All GFCI receptacles are furnished with a matching color thermoplastic wallplate, 20 amp feed-through capability. See page Tech-10 for Tamper-Resistant description.

SNAPConnect® USB Charger Hospital Grade ● TR Receptacles

Description	Color	Catalog Number	
Hospital Grade SNAPConnect USB Charger, Tamper-Resistant Style Line® decorator duplex receptacle, 15 or 20 Amp, 125 Volt AC with one type A & one type-C USB port, 3 Amp up to 9 Volt USB output.	Black	SNAP8200UACBK	SNAP8300UACBK
	Brown	SNAP8200UAC	SNAP8300UAC
	Gray	SNAP8200UACGY	SNAP8300UACGY
	Ivory	SNAP8200UACI	SNAP8300UACI
	Light Almond	SNAP8200UACLA	SNAP8300UACLA
	Red	SNAP8200UACR	SNAP8300UACR
	White	SNAP8200UACW	SNAP8300UACW

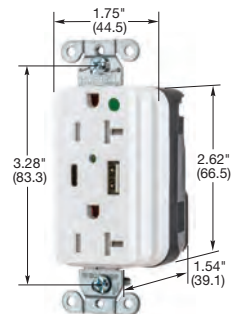
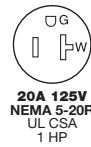
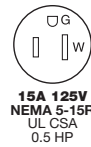

SNAP8300UACW

SNAPConnect® Surge Protection Hospital Grade ● Tamper-Resistant Receptacle with Power Indicating LED

Description	Color	Catalog Number	
Hospital Grade SNAPConnect Surge suppression, Tamper-Resistant, smooth face, duplex receptacle.	Blue	SNAP8262S	SNAP8362S
	Gray	SNAP8262GYS	SNAP8362GYS
	Ivory	SNAP8262IS	SNAP8362IS
	Light Almond	SNAP8262LAS	SNAP8362LAS
	Red	SNAP8262RS	SNAP8362RS
	White	SNAP8262WS	SNAP8362WS

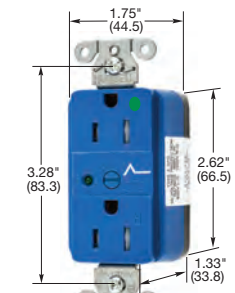
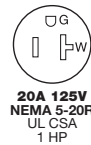
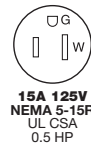

SNAP8262S

SNAPConnect® Right Angle Pigtailed Connector

Description	Wire Type	General Use	Assembled in USA
Clear right angle terminal with 6 inch leads #12 AWG THHN/THWN-2; Polycarbonate housing material.	Solid	SNAP1RA	SNAP1RNA
	Stranded	SNAP2RA	SNAP2RNA
Clear right angle terminal with 6 inch leads #12 AWG THHN/THWN-2; Polycarbonate housing material with WAGO terminals.	Solid	SNAP1RAM2	SNAP1RNAM2
	Stranded	SNAP2RAM2	SNAP2RNAM2

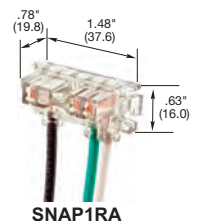

SNAP1RA

Note: See page Tech-10 for Tamper-Resistant, Weather Resistant and LED Power Indicators descriptions.

Dimensions in Inches (mm)

15 and 20 Ampere, 125 Volts

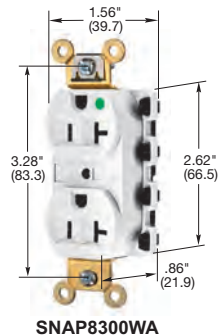

SNAP8300WA

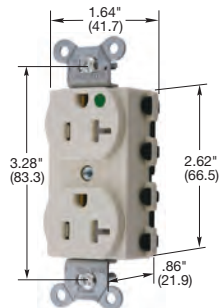

SNAP8300LATR

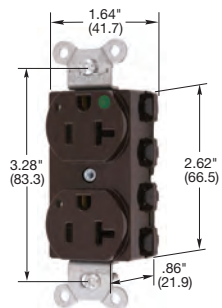

SNAP8300L

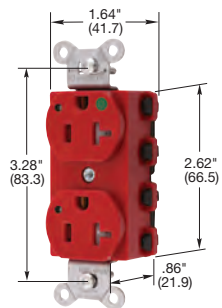

SNAP8300RLTR

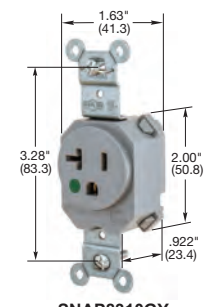

SNAP8310GY

Dimensions in Inches (mm)

IP20
SUITABILITY



15A 125V
NEMA 5-15R
UL CSA
0.5 HP



20A 125V
NEMA 5-20R
UL CSA
1 HP

SNAPConnect® Extra Heavy Duty Hospital Grade ● Receptacles

Duplex

Hospital grade, finder groove, nylon face, modular receptacle which requires pigtailed connector on page L-5.

Color	Catalog Number	Catalog Number
Black	SNAP8200BKA	SNAP8300BKA
Brown	SNAP8200A	SNAP8300A
Gray	SNAP8200GYA	SNAP8300GYA
Ivory	SNAP8200IA	SNAP8300IA
Light Almond	SNAP8200LAA	SNAP8300LAA
Red	SNAP8200RA	SNAP8300RA
White	SNAP8200WA	SNAP8300WA

Hospital grade, smooth nylon face, modular receptacle which requires pigtailed connector on page L-5. Assembled in USA.

Black	SNAP8200BKNA	SNAP8300BKNA
Brown	SNAP8200NA	SNAP8300NA
Gray	SNAP8200GYNA	SNAP8300GYNA
Ivory	SNAP8200INA	SNAP8300INA
Light Almond	SNAP8200LANA	SNAP8300LANA
Red	SNAP8200RNA	SNAP8300RNA
White	SNAP8200WNA	SNAP8300WNA



Hospital grade, Tamper-Resistant, smooth nylon face, modular receptacle which requires pigtailed connector on page L-5. Assembled in USA.

Black	SNAP8200BKTRA	SNAP8300BKTRA
Brown	SNAP8200TRA	SNAP8300TRA
Gray	SNAP8200GYTRA	SNAP8300GYTRA
Ivory	SNAP8200ITRA	SNAP8300ITRA
Light Almond	SNAP8200LATRA	SNAP8300LATRA
Red	SNAP8200RTRA	SNAP8300RTRA
White	SNAP8200WTRA	SNAP8300WTRA



Hospital grade, Tamper-Resistant, Split Circuit, smooth nylon face, modular receptacle which requires pigtailed connector on page L-5. Assembled in USA.

Black	SNAP8200BKSCTRA	SNAP8300BKSCTRA
Brown	SNAP8200SCTRA	SNAP8300SCTRA
Gray	SNAP8200GYSCTRA	SNAP8300GYSCTRA
Ivory	SNAP8200ISCTRA	SNAP8300ISCTRA
Light Almond	SNAP8200LASCTRA	SNAP8300LASCTRA
Red	SNAP8200RSCTRA	SNAP8300RSCTRA
White	SNAP8200WSCTRA	SNAP8300WSCTRA



Isolated ground^A, Hospital grade, Tamper-Resistant.

Hospital grade, with Power Indicating LED, smooth nylon face, modular receptacle which requires pigtailed connector on page L-5. Assembled in USA.

Orange	SNAP8200IGTRA	SNAP8300IGTRA
Red	SNAP8200RIGTRA	SNAP8300RIGTRA



Isolated ground^A, Hospital grade, with Power Indicating LED.

Hospital grade, Tamper-Resistant, with Power Indicating LED, smooth nylon face, modular receptacle which requires pigtailed connector on page L-5. Assembled in USA.

Orange	SNAP8200IGL	SNAP8300IGL
Red	SNAP8200RIGL	SNAP8300RIGL



Isolated ground^A, Hospital grade, TR with Power Indicating LED.

Black	SNAP8200BKLTRA	SNAP8300BKLTRA
Brown	SNAP8200LTRA	SNAP8300LTRA
Gray	SNAP8200GYLTRA	SNAP8300GYLTRA
Ivory	SNAP8200ILTRA	SNAP8300ILTRA
Light Almond	SNAP8200LALTRA	SNAP8300LALTRA
Red	SNAP8200RLTRA	SNAP8300RLTRA
White	SNAP8200WLTRA	SNAP8300WLTRA

Orange	SNAP8200IGLTRA	SNAP8300IGLTRA
Red	SNAP8200RIGLTRA	SNAP8300RIGLTRA

SNAPConnect® Extra Heavy Duty Hospital Grade ● Single Receptacles

Color	Hospital Grade ●		Hospital Grade ● Tamper-Resistant	
	15A 125V	20A 125V	15A 125V	20A 125V
Black	SNAP8210BK	SNAP8310BK	SNAP8210BKTR	SNAP8310BKTR
Blue	SNAP8210BL	SNAP8310BL	SNAP8210BLTR	SNAP8310BLTR
Brown	SNAP8210	SNAP8310	SNAP8210TR	SNAP8310TR
Gray	SNAP8210GY	SNAP8310GY	SNAP8210GYTR	SNAP8310GYTR
Ivory	SNAP8210I	SNAP8310I	SNAP8210ITR	SNAP8310ITR
Light Almond	SNAP8210LA	SNAP8310LA	SNAP8210LATR	SNAP8310LATR
Red	SNAP8210R	SNAP8310R	SNAP8210RTR	SNAP8310RTR
White	SNAP8210W	SNAP8310W	SNAP8210WTR	SNAP8310WTR

15 and 20 Ampere, 125 Volts

IP20
SUITABILITY

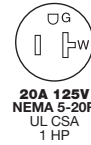
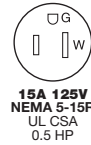

SNAPConnect® Extra Heavy Duty Hospital Grade Receptacles

Style Line® Decorator	Color	Catalog Number	
Hospital grade, Style Line® decorator, flush, nylon face, modular receptacle which requires pigtailed connector on page L-5.	Black	SNAP2172BKA	SNAP2182BKA
	Brown	SNAP2172A	SNAP2182A
	Gray	SNAP2172GYA	SNAP2182GYA
	Ivory	SNAP2172IA	SNAP2182IA
	Light Almond	SNAP2172LAA	SNAP2182LAA
	Red	SNAP2172RA	SNAP2182RA
	White	SNAP2172WA	SNAP2182WA
Hospital grade, Style Line® decorator, flush, nylon face, modular receptacle which requires pigtailed connector on page L-5. Assembled in USA.	Black	SNAP2172BKNA	SNAP2182BKNA
	Brown	SNAP2172NA	SNAP2182NA
	Gray	SNAP2172GYNA	SNAP2182GYNA
	Ivory	SNAP2172INA	SNAP2182INA
	Light Almond	SNAP2172LANA	SNAP2182LANA
	Red	SNAP2172RNA	SNAP2182RNA
	White	SNAP2172WNA	SNAP2182WNA
Hospital grade, Tamper-Resistant, Style Line® decorator, flush, nylon face, modular receptacle which requires pigtailed connector on page L-5. Assembled in USA.	Black	SNAP2172BKTRA	SNAP2182BKTRA
	Brown	SNAP2172TRA	SNAP2182TRA
	Gray	SNAP2172GYTRA	SNAP2182GYTRA
	Ivory	SNAP2172ITRA	SNAP2182ITRA
	Light Almond	SNAP2172LATRA	SNAP2182LATRA
	Red	SNAP2172RTRA	SNAP2182RTRA
	White	SNAP2172WTRA	SNAP2182WTRA
Hospital grade, Tamper-Resistant, Split Circuit, Style Line® decorator, flush, nylon face, modular receptacle which requires pigtailed connector on page L-5. Assembled in USA.	Black	SNAP2172BKSCTRA	SNAP2182BKSCTRA
	Brown	SNAP2172SCTRA	SNAP2182SCTRA
	Gray	SNAP2172GYSCTRA	SNAP2182GYSCTRA
	Ivory	SNAP2172ISCTRA	SNAP2182ISCTRA
	Light Almond	SNAP2172LASCTRA	SNAP2182LASCTRA
	Red	SNAP2172RSCTRA	SNAP2182RSCTRA
	White	SNAP2172WSCTRA	SNAP2182WSCTRA
Isolated ground ^A , Hospital grade, Tamper-Resistant.	Orange	SNAP2172IGTRA	SNAP2182IGTRA
	Red	SNAP2172RIGTRA	SNAP2182RIGTRA
Hospital grade, with Power Indicating LED, Style Line® decorator, flush, nylon face, modular receptacle which requires pigtailed connector on page L-5. Assembled in USA.	Black	SNAP2172BKL	SNAP2182BKL
	Brown	SNAP2172L	SNAP2182L
	Gray	SNAP2172GYL	SNAP2182GYL
	Ivory	SNAP2172IL	SNAP2182IL
	Light Almond	SNAP2172LAL	SNAP2182LAL
	Red	SNAP2172RL	SNAP2182RL
	White	SNAP2172WL	SNAP2182WL
Isolated ground ^A , Hospital grade, with Power Indicating LED.	Orange	SNAP2172IGL	SNAP2182IGL
	Red	SNAP2172RIGL	SNAP2182RIGL
Hospital grade, Tamper-Resistant, with Power Indicating LED, Style Line® decorator, flush, nylon face, modular receptacle which requires pigtailed connector on page L-5. Assembled in USA.	Black	SNAP2172BKLTRA	SNAP2182BKLTRA
	Brown	SNAP2172LTRA	SNAP2182LTRA
	Gray	SNAP2172GYLTRA	SNAP2182GYLTRA
	Ivory	SNAP2172ILTRA	SNAP2182ILTRA
	Light Almond	SNAP2172LALTRA	SNAP2182LALTRA
	Red	SNAP2172RLTRA	SNAP2182RLTRA
	White	SNAP2172WLTRA	SNAP2182WLTRA
Isolated ground ^A , Hospital grade, TR with Power Indicating LED.	Orange	SNAP2172IGLTRA	SNAP2182IGLTRA
	Red	SNAP2172RIGLTRA	SNAP2182RIGLTRA

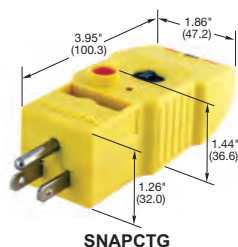
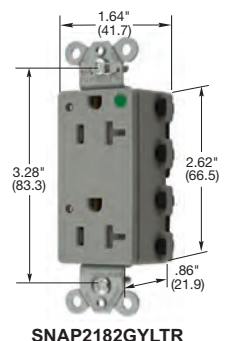
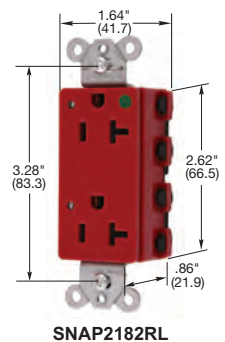
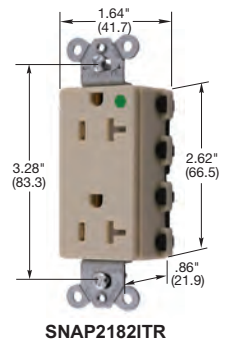
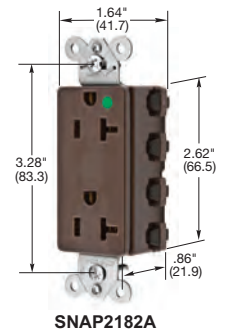

Dimensions in Inches (mm)

Note: ^ASee section N additional information on isolated ground devices and section O for wallplates.
 See page A-5 for additional information on SNAPConnect features.
 See Page L-5 for SNAPConnect pigtailed terminals.
 See page Tech-10 for Tamper-Resistant and LED Power Indicators descriptions.
 See pages A-47 and A-48 for accessories.

SNAPConnect® Tester

Description	Catalog Number
Circuit Tester for SNAPConnect receptacle terminals, GFCI and standard receptacles	SNAPCTG

Features and Benefits

Hubbell-PRO Extra Heavy Duty Receptacles

- Nylon face and base construction
- Triple-wipe power contacts
- Circuit ID marking area
- Combination Tamper-Resistant and LED for pediatric emergency circuits
- Galvanized steel mounting strap
- Automatic self-grounding staple
- Back and side wiring



8200REDLTRA



15A 125V
NEMA 5-15R
UL CSA
0.5 HP



20A 125V
NEMA 5-20R
UL CSA
1 HP

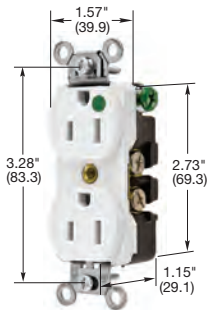

8200WHI

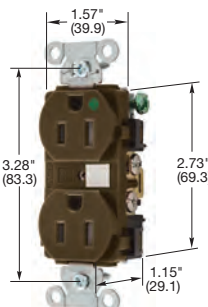

8200TRA

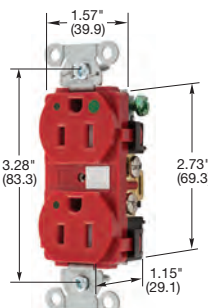

8200REDLTRA

Dimensions in Inches (mm)

Hubbell-PRO Extra Heavy Duty Hospital Grade Receptacles

Duplex

Hospital grade, smooth nylon face, back and side wired. Assembled in USA.



Hospital grade, Tamper-Resistant, smooth nylon face, back and side wired. Assembled in USA.



Hospital grade, with Power Indicating LED, smooth nylon face, back and side wired. Assembled in USA.



Hospital grade, Tamper-Resistant, with Power Indicating LED, smooth nylon face, back and side wired. Assembled in USA.



Hospital grade, Tamper-Resistant, with Power Indicating LED, smooth nylon face, back and side wired. Assembled in USA.

Color	Catalog Number	Catalog Number
Black	8200BK	8300BK
Brown	8200	8300
Gray	8200GY	8300GY
Ivory	8200IV	8300IV
Light Almond	8200LA	8300LA
Red	8200RED	8300RED
White	8200WHI	8300WHI
Black	8200BKTRA	8300BKTRA
Brown	8200TRA	8300TRA
Gray	8200GYTRA	8300GYTRA
Ivory	8200IVTRA	8300IVTRA
Light Almond	8200LATRA	8300LATRA
Red	8200REDTRA	8300REDTRA
White	8200WTRA	8300WTRA
Black	8200BKL	8300BKL
Brown	8200L	8300L
Gray	8200GYL	8300GYL
Ivory	8200IVL	8300IVL
Light Almond	8200LAL	8300LALM
Red	8200REDL	8300REDL
White	8200WL	8300WL
Black	8200BKLTRA	8300BKLTRA
Brown	8200LTRA	8300LTRA
Gray	8200GYLTRA	8300GYLTRA
Ivory	8200IVLTRA	8300IVLTRA
Light Almond	8200LALTRA	8300LALTRA
Red	8200REDLTRA	8300REDLTRA
White	8200WLTRA	8300WLTRA

Note: See pages A-47 and A-48 for accessories.
See page Tech-10 for Tamper-Resistant and LED Power Indicators description.
See section O for wallplates.

The products listed on this page are Assembled in USA, and many are Buy American Compliant. Please contact Hubbell with any certification requirements.

Features and Benefits

Hubbell-PRO Extra Heavy Duty Receptacles

- Nylon face and base construction
- Triple-wipe power contacts
- Circuit ID marking area
- Combination Tamper-Resistant and LED for pediatric emergency circuits
- Galvanized steel mounting strap
- Automatic self-grounding staple
- Back and side wiring



2182IVLTRA

Hubbell-PRO Extra Heavy Duty Hospital Grade Receptacles



15A 125V
NEMA 5-15R
UL CSA
0.5 HP



20A 125V
NEMA 5-20R
UL CSA
1 HP

Style Line® Decorator

Hospital grade, Style Line® decorator, flush, nylon face, back and side wired. Assembled in USA.

Color
Black
Brown
Gray
Ivory
Light Almond
Red
White

Catalog Number
2172BK
2172
2172GY
2172IV
2172LA
2172RED
2172W

2182BK
2182
2182GY
2182IV
2182LA
2182RED
2182W

Hospital grade, Tamper-Resistant, Style Line® decorator, flush, nylon face, back and side wired. Assembled in USA.

Color
Black
Brown
Gray
Ivory
Light Almond
Red
White

Catalog Number
2172BKTRA
2172TRA
2172GYTRA
2172IVTRA
2172LATRA
2172REDTRA
2172WTRA

2182BKTRA
2182TRA
2182GYTRA
2182IVTRA
2182LATRA
2182REDTRA
2182WTRA



Hospital grade, with Power Indicating LED, Style Line® decorator, flush, nylon face, back and side wired. Assembled in USA.

Color
Black
Brown
Gray
Ivory
Light Almond
Red
White

Catalog Number
2172BKL
2172L
2172GYL
2172IVL
2172LAL
2172REDL
2172WL

2182BKL
2182L
2182GYL
2182IVL
2182LAL
2182REDL
2182WL



Hospital grade, Tamper-Resistant, with Power Indicating LED, Style Line® decorator, flush, nylon face, back and side wired. Assembled in USA.

Color
Black
Brown
Gray
Ivory
Light Almond
Red
White

Catalog Number
2172BKLTRA
2172LTRA
2172GYLTRA
2172IVLTRA
2172LALTRA
2172REDLTRA
2172WLTRA

2182BKLTRA
2182LTRA
2182GYLTRA
2182IVLTRA
2182LALTRA
2182REDLTRA
2182WLTRA

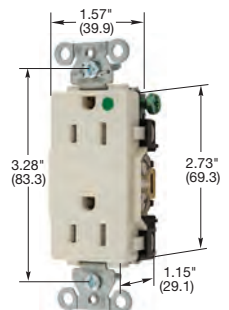

2172LATRA

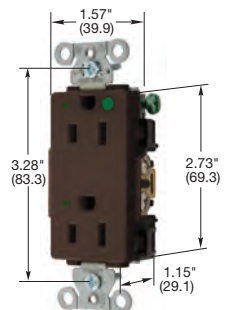

2172L

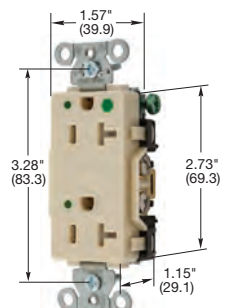

2182IVLTRA

Note: See pages A-47 and A-48 for accessories.
See page Tech-10 for Tamper-Resistant and LED Power Indicators description.
See section O for wallplates.

The products listed on this page are Assembled in USA, and many are Buy American Compliant. Please contact Hubbell with any certification requirements.

Dimensions in Inches (mm)

Hospital Products

15 and 20 Ampere, 125 Volts



Hospital Grade USB-C Power Delivery Charger Type C and Type A&C

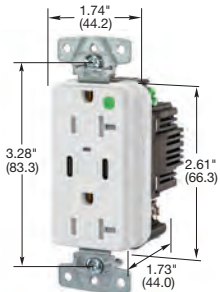

USB8300CPDW

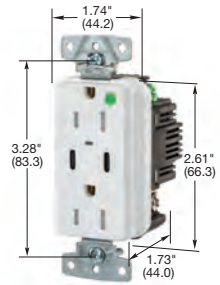

USB8200CPDW

Description	Color	Catalog Number	
Hospital Grade USB-C Power Delivery Charger Receptacle, two Type-C port configurations, one USB-C Power Delivery port with up to 55 Watt output and one USB Type-C convenience port with up to 1.5 Amp, 5 Volt output, USB ports rated 10,000 cycles.	Black	USB8200CPDBK	USB8300CPDBK
	Brown	USB8200CPD	USB8300CPD
	Gray	USB8200CPDGY	USB8300CPDGY
	Ivory	USB8200CPDI	USB8300CPDI
	Light Almond	USB8200CPDLA	USB8300CPDLA
	Red	USB8200CPDR	USB8300CPDR
White	USB8200CPDW	USB8300CPDW	
Hospital Grade USB-C Power Delivery Charger Receptacle, one Type A and one Type C port configurations, one USB-C Power Delivery port with up to 55 Watt output and one USB Type-A convenience port with up to 1.5 Amp, 5 Volt output, USB ports rated 10,000 cycles.	Black	USB8200ACPDBK	USB8300ACPDBK
	Brown	USB8200ACPD	USB8300ACPD
	Gray	USB8200ACPDGY	USB8300ACPDGY
	Ivory	USB8200ACPDI	USB8300ACPDI
	Light Almond	USB8200ACPDLA	USB8300ACPDLA
	Red	USB8200ACPDR	USB8300ACPDR
White	USB8200ACPDW	USB8300ACPDW	

Note: See page A-7 for additional information on USB charger devices.

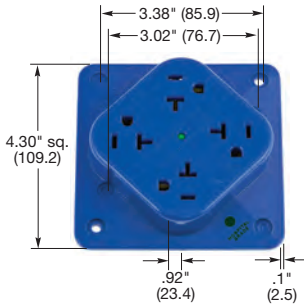

HBL420HS

4-PLEX® Hospital Grade Receptacles



Description	Color	Catalog Number	
4 outlet high impact resistant Polycarbonate construction. Mount to 4 in. square box.	Brown	HBL415H	HBL420H
	Gray	—	HBL420HGY
	Ivory	HBL415HI	HBL420HI
	Red	HBL415HR	HBL420HR
	White	HBL415HW	HBL420HW
4-PLEX surge protection receptacles with lights, 80 joules, 6.5kA peak current.	Blue	—	HBL420HS
	Ivory	—	HBL420HIS
	Red	—	HBL420HRS

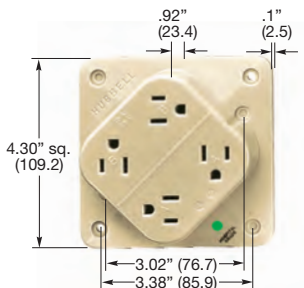

HBL415HI

4-PLEX® Accessories

Description	Color	Catalog Number
4-PLEX adapter plates for 1- and 2-gang, device boxes.	Blue	HBL4APBL
	Brown	HBL4AP
	Gray	HBL4APGY
	Ivory	HBL4API
	Orange	HBL4APO
	Red	HBL4APR
White	HBL4APW	
4-PLEX Portable Box, 4 in. (101.6) square box with cord grip. Accepts up to .66 in. (16.8) diameter cord.	Black	HBL4PBBK
	Brown	HBL4PB
	Ivory	HBL4PBI

Note: 4-PLEX Box is not UL listed or CSA Certified. UL listing does not apply when 4-PLEX Receptacle is used with 4-PLEX Box in extension cord application. Supplied with one cord clamp.

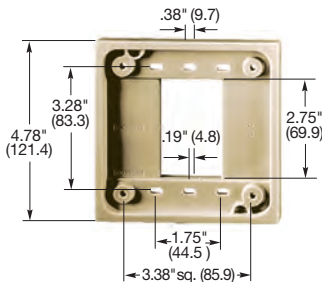

HBL4API

Dimensions in Inches (mm)

15 and 20 Ampere, 125 Volts

Hospital Grade Plugs

Insulgrip®

Description	Cord Diameter	Catalog Number	
Black and white nylon.	.230"-.720" (5.8-18.3)	HBL8215C	HBL8315C
Transparent housing.	.230"-.720" (5.8-18.3)	HBL8215CT	HBL8315CT
8 position angle plug, transparent housing.	.250"-.655" (6.4-16.6)	HBL8215CAT*	HBL8315CAT*

Valise®

Description	Cord Diameter	Catalog Number	
White nylon.	.300"-.660" (7.6-16.8)	HBL8115V	HBL8364V
Insulation displacement, white nylon.	.300"-.360" (7.6-9.1)	HBL8013V*	-

Note: *Not Fed. Spec. Listed.
See page A-48 for accessories

IP20
SUITABILITY



15A 125V
NEMA 5-15P
UL CSA



20A 125V
NEMA 5-20P
UL CSA

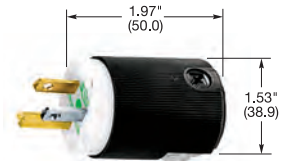

HBL8215C

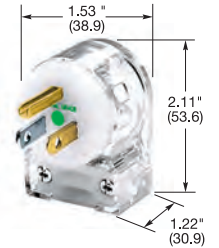

HBL8215CAT

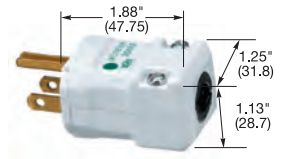

HBL8115V

Hospital Grade Connector Bodies

Insulgrip®

Description	Cord Diameter	Catalog Number	
Black and white nylon.	.230"-.720" (5.8-18.3)	HBL8219C	HBL8319C
Transparent housing.	.230"-.720" (5.8-18.3)	HBL8219CT	HBL8319CT

Valise®

Description	Cord Diameter	Catalog Number	
White nylon.	.300"-.660" (7.6-16.8)	HBL8119V	-

Note: See page A-49 for accessories.

IP20
SUITABILITY



15A 125V
NEMA 5-15R
UL CSA
0.5 HP



20A 125V
NEMA 5-20R
UL CSA
1 HP



HBL8219C

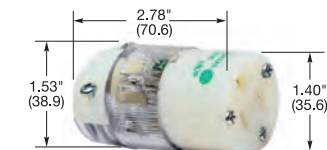

HBL8219CT

Hospital Grade Plugs

Valise®

Description	Cord Diameter	Catalog Number	
Valise plug, white nylon.	.300"-.660" (7.6-16.8)	HBL8666V	HBL8464V

Note: HP ratings listed above are based on 208 to 240V AC only.

IP20
SUITABILITY



15A 250V
NEMA 6-15P
UL CSA
1.5 HP



20A 250V
NEMA 6-20P
UL CSA
2 HP

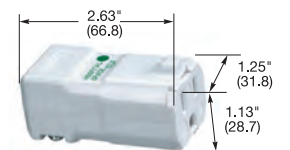

HBL8119V

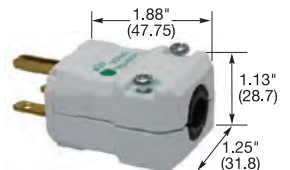

HBL8666V

Hospital Grade Connector Bodies

Valise®

Description	Cord Diameter	Catalog Number	
White nylon.	.300"-.660" (7.6-16.8)	-	HBL8469V



15A 250V
NEMA 6-15R
UL CSA
1.5 HP



20A 250V
NEMA 6-20R
UL CSA
2 HP

Dimensions in Inches (mm)

Features and Benefits

Extra Heavy Duty Hospital Grade ● GFCI Receptacles Tamper-Resistant and Weather Resistant

- Corrosion resistant construction includes nickel plated brass mounting strap, line/load terminals, face contacts, internal contacts and wiring terminal clamps; stainless steel terminal and mounting screws
- Selective double layer conformal coating of printed circuit board, critical components and connections
- Superior materials including polyester "V0" thermoplastic housing (UV Resistant); 7025 high thermal conductivity copper alloy contacts
- Dust Test (UL 943) compliant; resistance to contaminants, moisture and dust
- Single LED: power solid green, GF/trip solid red, end of life flashing red



GFSG8200GRY



AUTOGUARD® Self Test Hospital Grade ● Tamper and Weather Resistant GFCI Receptacles



15A 125V
NEMA 5-15R
UL CSA
0.5 HP



20A 125V
NEMA 5-20R
UL CSA
1 HP



GFSG8300W

Description	Rating	Color	Catalog Number	
Hospital Grade Extra Heavy Duty Industrial Ground Fault Receptacle Feed Through, Tamper and Weather Resistant	15 and 20A 125V AC	Black Brown Gray Ivory Red White	GFSG8200BLK GFSG8200 GFSG8200GRY GFSG8200I GFSG8200R GFSG8200W	GFSG8300BLK GFSG8300 GFSG8300GRY GFSG8300I GFSG8300R GFSG8300W

Note: GFCI type receptacles should not be used in critical care patient areas or for electrical life support equipment applications because of the possibility of power interruption. All GFCI receptacles listed above are furnished with both a matching color thermoplastic wallplate, and a SS26 302/304 super stainless steel wallplate. 20 amp feed-through capability. See page Tech-10 for Tamper-Resistant and Weather Resistant descriptions.

GFCI Receptacle Specifications per GFCI Products Listed (Pages L-12 to L-15)

Trip Level	4 to 6 mA.
Trip Time	.025 second nominal.
Frequency	60 Hz.
Voltage	120V AC +10% - 15% (102V to 132V).
Amperage	15A/20A, 20A Feed-Thru.
Maximum Interrupting Capacity	10,000A.
Operating Temperature	-35°C to 66°C or -30°F to 150°F.
Maximum Humidity	95%.
Dust Resistant	Meets UL 943, section 6.20 for resistance to dust contaminants
Corrosion Resistant	Meets UL 943, section 6.21 for resistance to corrosion
FCC Part 15 Class B	Certified conformance to radiated and conducted emission testing per FCC
Immunity to noise	Exceed UL 943 of .5V over a frequency range of 150kHz to 230MHz disturbances
Listings and Standards	Meets UL498 for receptacles, UL943 Class A for GFCIs UL File E41978 CSA Certified.
Codes	Meets all NEC® and CEC requirements. NEMA WD-6 ANSI 73.

NEC® is a registered trademark of the National Fire Protection Association (NFPA).

Features and Benefits

Commercial Tamper-Resistant GFCI Receptacles

- Patented shutter design for tamper-resistant protection
- Compliant with NEC® 406.12 and NEC® 517-18(c)
- Patented AUTOGUARD® self test technology includes disconnecting power to the receptacle if critical components are damaged and GFCI protection is lost
- Alarm version provides audible notification of a trip condition



GFTRST83B



Hospital Grade Tamper-Resistant GFCI Receptacles



15A 125V
NEMA 5-15R
UL CSA
0.5 HP



20A 125V
NEMA 5-20R
UL CSA
1 HP

Description	Rating	Color	Catalog Number	
Night Light Two LED Night Lights, Flush, nylon face, back and side wired, multiple drive screws, self-grounding staple.	15 and 20A 125V AC	Black	GFTRST82BKNL	GFTRST83BKNL
		Brown	GFTRST82NL	GFTRST83NL
		Gray	GFTRST82GYNL	GFTRST83GYNL
		Ivory	GFTRST82INL	GFTRST83INL
		Light Almond	GFTRST82LANL	GFTRST83LANL
		Red	GFTRST82RNL	GFTRST83RNL
		White	GFTRST82WNL	GFTRST83WNL
Alarm, Flush, nylon face, back and side wired, multiple drive screws, self-grounding staple.	15 and 20A 125V AC	Black	GFTRST82BKKB	GFTRST83BKKB
		Brown	GFTRST82B	GFTRST83B
		Gray	GFTRST82GYB	GFTRST83GYB
		Ivory	GFTRST82IB	GFTRST83IB
		Light Almond	GFTRST82LAB	GFTRST83LAB
		Red	GFTRST82RB	GFTRST83RB
		White	GFTRST82WB	GFTRST83WB



GFTRST83WNL



GFTRST83GYB

Note: GFCI type receptacles should not be used in critical care patient areas or for electrical life support equipment applications because of the possibility of power interruption. All GFCI receptacles are furnished with a matching color thermoplastic wallplate, 20 amp feed-through capability. See page Tech-10 for Tamper-Resistant description.

Product Dimensions

GFCI Receptacle	
A	3.27 (83.1)
B	2.75 (69.8)
C	1.75 (44.5)
D	1.47 (37.4)
E	1.10 (27.9)

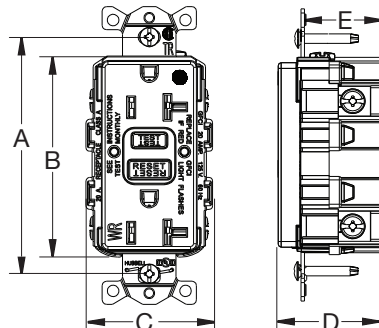

Features and Benefits

Commercial Tamper and Weather Resistant GFCI Receptacles

- Patented shutter design for tamper-resistant protection
- Meets NEC® requirements for TR (517-18c) and WR (406.9), UV and corrosion resistance for harsh and damp applications
- Patented AUTOGUARD® self test technology
- Protects against line and load reversal, no power to the face or downstream if device is miswired



GFTWRST83WIG



15A 125V
NEMA 5-15R
UL CSA
0.5 HP



20A 125V
NEMA 5-20R
UL CSA
1 HP



GFRTW83BLK



GFTWRST83GYU



GFTWRST82BKIG



SNAPGFTW83I



SNAP1RA



Hospital Grade • Tamper-Resistant and Weather Resistant GFCI Receptacles

Description	Rating	Color	Catalog Number	
Standard, Flush, nylon face, back and side wired, multiple drive screws, self-grounding staple.	15 and 20A 125V AC	Black	GFRTW82BLK	GFRTW83BLK
		Brown	GFRTW82	GFRTW83
		Gray	GFRTW82GRY	GFRTW83GRY
		Ivory	GFRTW82I	GFRTW83I
		Light Almond	GFRTW82LA	GFRTW83LA
		Red	GFRTW82R	GFRTW83R
Assembled in USA, Flush, nylon face, back and side wired, multiple drive screws, self-grounding staple.	15 and 20A 125V AC	Black	GFTWRST82BKU	GFTWRST83BKU
		Brown	GFTWRST82U	GFTWRST83U
		Gray	GFTWRST82GYU	GFTWRST83GYU
		Ivory	GFTWRST82IU	GFTWRST83IU
		Light Almond	GFTWRST82LAU	GFTWRST83LAU
		Red	GFTWRST82RU	GFTWRST83RU
Isolated Ground, Flush, nylon face, back and side wired, multiple drive screws, self-grounding staple.	15 and 20A 125V AC	Black	GFTWRST82BKIG	GFTWRST83BKIG
		Brown	GFTWRST82IG	GFTWRST83IG
		Gray	GFTWRST82GYIG	GFTWRST83GYIG
		Ivory	GFTWRST82IIG	GFTWRST83IIG
		Light Almond	GFTWRST82LAIG	GFTWRST83LAIG
		Orange	GFTWRST82ORIG	GFTWRST83ORIG
SNAPConnect®, Flush, nylon face, back and side wired, multiple drive screws, self-grounding staple.	15 and 20A 125V AC	Black	-	SNAPGFTW83BLK
		Brown	-	SNAPGFTW83
		Gray	SNAPGFTW82GRY	SNAPGFTW83GRY
		Ivory	SNAPGFTW82I	SNAPGFTW83I
		Light Almond	SNAPGFTW82LA	SNAPGFTW83LA
		Red	SNAPGFTW82R	SNAPGFTW83R
White	SNAPGFTW82W	SNAPGFTW83W		

Note: GFCI type receptacles should not be used in critical care patient areas or for electrical life support equipment applications because of the possibility of power interruption. All GFCI receptacles are furnished with a matching color thermoplastic wallplate, 20 amp feed-through capability.

See page Tech-10 for Tamper-Resistant and Weather Resistant descriptions.

SNAPConnect® Right Angle Pigtailed Connector

Description	Wire Type	General Use	Assembled in USA
Clear right angle terminal with 6 inch leads #12 AWG THHN/THWN-2; Polycarbonate housing material.	Solid	SNAP1RA	SNAP1RNA
	Stranded	SNAP2RA	SNAP2RNA
Clear right angle terminal with 6 inch leads #12 AWG THHN/THWN-2; Polycarbonate housing material with WAGO terminals.	Solid	SNAP1RAM2	SNAP1RNAM2
	Stranded	SNAP2RAM2	SNAP2RNAM2

Note: For Assembled in USA products, must order connector with NA suffix.

NEC® is a registered trademark of the National Fire Protection Association (NFPA).

Features and Benefits

Commercial Standard Hospital Grade ● GFCI Receptacles

- Fed. Spec UL Listed, Hospital Grade
- Green power indicator and red trip indicator
- Patented AUTOGUARD® self test technology
- Flush, nylon face, back and side wired, multiple drive screws, self-grounding staple



GFRST82WNL



15A 125V
NEMA 5-15V
UL CSA
0.5 HP



20A 125V
NEMA 5-20R
UL CSA
1 HP

Hospital Grade ● GFCI Receptacles

Description	Rating	Color	Catalog Number	
Standard, Flush, nylon face, back and side wired, multiple drive screws, self-grounding staple.	15 and 20A 125V AC	Black	GFR82BLK	GFR83BLK
		Brown	GFR82	GFR83
		Gray	GFR82GRY	GFR83GRY
		Ivory	GFR82I	GFR83I
		Light Almond	GFR82LA	GFR83LA
		Red	GFR82R	GFR83R
		White	GFR82W	GFR83W
Assembled in USA, Flush, nylon face, back and side wired, multiple drive screws, self-grounding staple.	15 and 20A 125V AC	Black	GFRST82BKU	GFRST83BKU
		Brown	GFRST82U	GFRST83U
		Gray	GFRST82GYU	GFRST83GYU
		Ivory	GFRST82IU	GFRST83IU
		Light Almond	GFRST82LAU	GFRST83LAU
		Red	GFRST82RU	GFRST83RU
		White	GFRST82WU	GFRST83WU
Night Light Two LED Night Lights, Flush, nylon face, back and side wired, multiple drive screws, self-grounding staple.	15 and 20A 125V AC	Black	GFRST82BKNL	GFRST83BKNL
		Brown	GFRST82NL	GFRST83NL
		Gray	GFRST82GYNL	GFRST83GYNL
		Ivory	GFRST82INL	GFRST83INL
		Light Almond	GFRST82LANL	GFRST83LANL
		Red	GFRST82RNL	GFRST83RNL
		White	GFRST82WNL	GFRST83WNL
Alarm, Flush, nylon face, back and side wired, multiple drive screws, self-grounding staple.	15 and 20A 125V AC	Black	GFRST82BKB	GFRST83BKB
		Brown	GFRST82B	GFRST83B
		Gray	GFRST82GYB	GFRST83GYB
		Ivory	GFRST82IB	GFRST83IB
		Light Almond	GFRST82LAB	GFRST83LAB
		Red	GFRST82RB	GFRST83RB
		White	GFRST82WB	GFRST83WB
SNAPConnect®, Flush, nylon face, back and side wired, multiple drive screws, self-grounding staple.	15 and 20A 125V AC	Black	-	SNAPGF83BLK
		Brown	-	SNAPGF83
		Gray	-	SNAPGF83GRY
		Ivory	SNAPGF82I	SNAPGF83I
		Light Almond	SNAPGF82LA	SNAPGF83LA
		Red	SNAPGF82R	SNAPGF83R
		White	SNAPGF82W	SNAPGF83W



GFR83R



GFRST83INL



GFRST83BKB



SNAPGF83GRY

Note: GFCI type receptacles should not be used in critical care patient areas or for electrical life support equipment applications because of the possibility of power interruption. All GFCI receptacles are furnished with a matching color thermoplastic wallplate, 20 amp feed-through capability.
Requires pigtailed connector see page L-14.

Surge Protection Devices



15A 125V
NEMA 5-15R
UL CSA
0.5 HP



20A 125V
NEMA 5-20R
UL CSA
1 HP

Hospital Grade • Circuit Guard® Receptacles

Description	Color	Catalog Number	
SNAPConnect® Tamper-Resistant, surge suppression duplex receptacle, smooth face, 240 joules, 15000A peak current. Requires Snap connector on page L-14, sold separately.	Blue	SNAP8262S	SNAP8362S
	Gray	SNAP8262GYS	SNAP8362GYS
	Ivory	SNAP8262IS	SNAP8362IS
	Light Almond	SNAP8262LAS	SNAP8362LAS
	Red	SNAP8262RS	SNAP8362RS
White	SNAP8262WS	SNAP8362WS	
Surge suppression receptacles with light and alarm, 240 joules, 15000A peak current.	Blue	HBL8262SA	HBL8362SA
	Gray	HBL8262GYSA	HBL8362GYSA
	Ivory	HBL8262ISA	HBL8362ISA
	Red	HBL8262RSA	HBL8362RSA
	White	HBL8262WSA	HBL8362WSA
Isolated ground, surge suppression receptacles with light and alarm, 240 joules, 15000A peak current.	Blue	IG8262SA	IG8362SA
	Gray	IG8262GYSA	IG8362GYSA
	Ivory	IG8262ISA	IG8362ISA
	Orange	IG8262OSA	IG8362OSA
	Red	IG8262RSA	IG8362RSA
White	IG8262WSA	IG8362WSA	
4-PLEX® surge suppression receptacles with lights, 80 joules, 6500A peak current.	Blue	—	HBL420HS
	Ivory	—	HBL420HIS
	Red	—	HBL420HRS

Note: See page Tech-10 for Tamper-Resistant and LED Power Indicators descriptions.

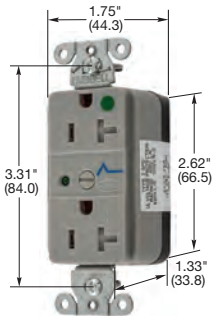

SNAP8362GYS

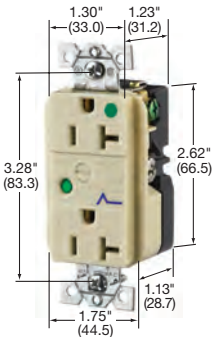

HBL8362ISA

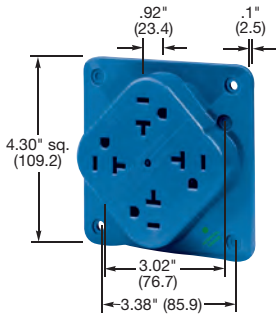

HBL420HS

4-PLEX® Accessories

Description	Color	Catalog Number
4-PLEX Adapter Plates for 1- and 2-gang, and 4 in. (101.6) square device boxes.	Blue	HBL4APBL
	Ivory	HBL4API
	Red	HBL4APR
4-PLEX Portable Box, 4 in. (101.6) square box with cord grip. Accepts up to .66 in. (16.8) diameter cord.	Ivory	HBL4PBI

Note: 4-PLEX Box is not UL Listed.

UL2930 Listed



UL2930 Health Care Outlet Assembly (HCOA)

Description	# of Outlets	Cord Length	Color	15 Amp	20 Amp
UL 2930 HCOA with L-N surge protection.	6	6'	White	HBL6MG6	HBL6MG620
	6	15'	White	HBL6MG15	HBL6MG1520
UL 2930 HCOA, Relocatable Power Tap (RPT).	6	6'	White	HBL6MGRPT6	HBL6MGRPT620
	6	15'	White	HBL6MGRPT15	HBL6MGRPT1520



HBL6MGRPT620

Listed to UL1449



SpikeShield® Surge Protective Devices (SPD) with Tamper-Resistant Receptacles and Heavy Duty Plug

Description	# of Outlets	Cord Length	Color	15 Amp	20 Amp
Type 3 SPD, Heavy Duty metal housing.	6	6'	White	HBL6HG6	HBL6HG620
	6	15'	White	HBL6HG15	HBL6HG1520
UL Type 3 SPD, Heavy Duty metal housing with 2-port USB.	4	6'	White	HBL6HGUSB6	—



HBL6HGUSB6

Dimensions in Inches (mm)

Hospital Products

Hubbellock® Plugs, Connector Bodies and Receptacles

For Hospital Use Only



Hubbellock® Plugs and Connector Bodies

Description	Plugs	Connector Bodies
Nylon cover, thermoset interior.	HBL23014HGB	HBL23001HGB
Armored, epoxy filled, rubber cord grip.	HBL23004HG	—

Note: Cord clamp range for plug and connector .300" to .660" (7.6 to 16.8).



20A 125V AC



20A 125V AC

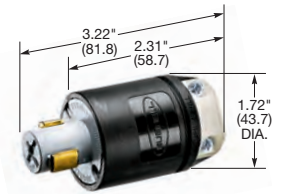

HBL23014HGB



HBL23001HGB

Receptacles

Description	Catalog Number
Black, back wired.	— HBL23000HG

Wallplates

Description	Catalog Number
Stainless steel 302/304, single-gang.	HBL23901HG
Stainless steel 302/304, three-gang for two receptacles.	HBL23909HG

Note: Suffix HG or HGB type for hospital use only.



IP30
SUITABILITY

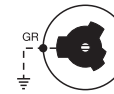

20A 125V AC

Explosion Proof Plug

Description	Catalog Number
Plug, with, epoxy kit, accepts #12 or #14 type SO cable.	HBL24312

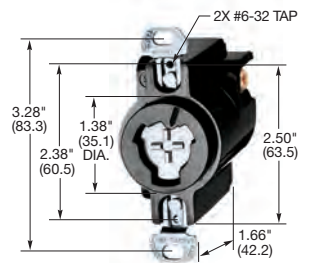

HBL23000HG

Hazardous to Non-hazardous Location Receptacle Conversion Kits

Conversion kits for replacement of explosion proof receptacles listed above, with non-explosion proof receptacles, in the hospital areas formerly classified as hazardous locations and now classified non-hazardous locations due to the change from flammable anesthetizing gases to nonflammable anesthetizing gases.

For Conversion To:	Catalog Number
20A, 125V, duplex receptacle (Hubbell HBL830 Series). Includes adapter ring and stainless steel wall plate for duplex receptacle (receptacle not included).	HBL24300RKD
20A, 125V, Hospital Hubbellock receptacle (Hubbell HBL23000HG) or 20A, 125V, straight blade single receptacle (Hubbell HBL8310 series). Includes adapter ring and stainless wall plate for single receptacle (receptacle not included).	HBL24300RKS

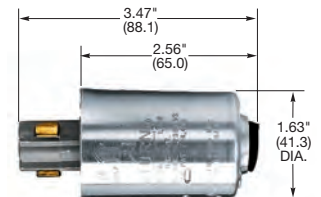

HBL24312

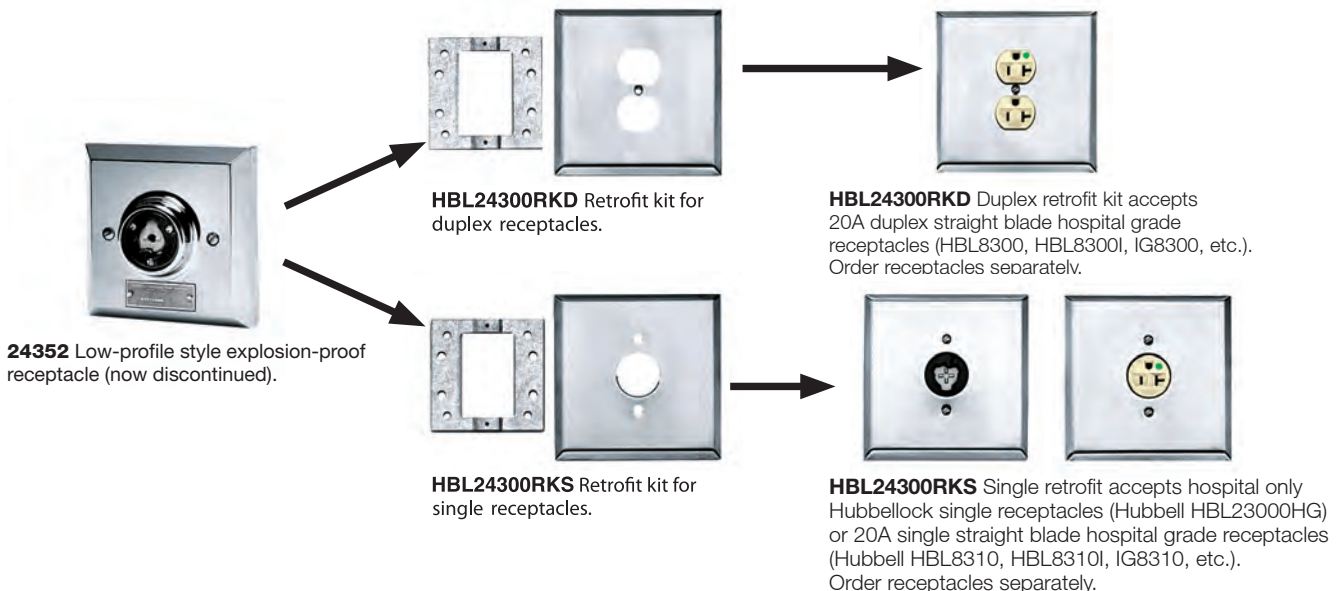

Dimensions in Inches (mm)

Hubbellock® Mobile X-Ray Devices

IP30
SUITABILITY



50A 250V AC



60A 250V AC



HBL25515

Mobile X-Ray Plugs

Description	Catalog Number	
Plug, with epoxy kit, less cord clamp.	HBL25515	HBL25615
Plug, with cord clamp, less epoxy kit.	HBL25525	HBL25625

Note: Cord clamp range of plugs with cord clamps .830" to 1.3" (21.1 to 33.0).
50A plugs fit 50A or 60A receptacles.



HBL25615

Mobile X-Ray Receptacles

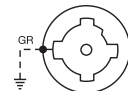

50A 250V AC

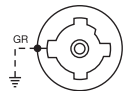

60A 250V AC

Description	Catalog Number	
Receptacle with stainless steel plate assembly.	HBL25505	HBL25605
Receptacle with cast aluminum plate assembly.	HBL25503	HBL25603
Replacement receptacle interior.	—	IN16494

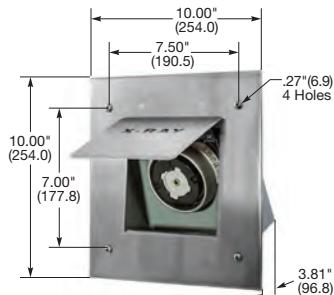

HBL25605

Accessory

Description	Catalog Number
Box stamped steel 8" x 8" x 4" (203.2 x 203.2 x 101.6), accommodates 50A and 60A mobile X-ray receptacles. Knockout sizes 1/4", 1/2" and 2".	HBL25509

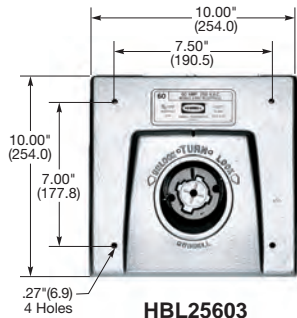

HBL25603

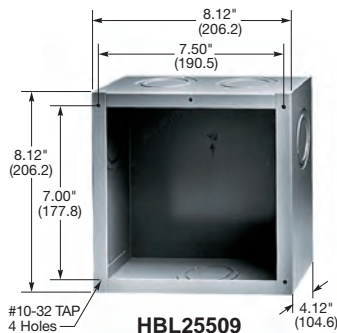

HBL25509

Dimensions in Inches (mm)

SECTION M

Table of Contents



Surge Protection Panels & Wired-In Branch Panels



SpikeShield® Surge Protection Plug Strips



Surge Protection & Isolated Ground Receptacles

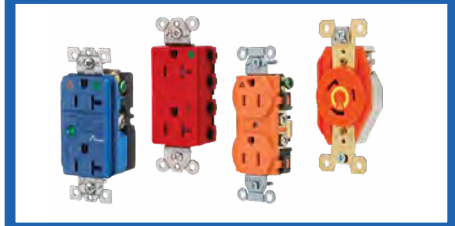

Product	Page
Products at a Glance	M-2
Service/Branch Panel Protection	
320kA and 160kA Service/Branch Panel Protection	M-4
120kA Service/Branch Panel Protection	M-5
Wired-In Branch Panel Protection	M-6
Wired-In Surge Arrestors and Protective Devices	M-7
Surge Protection Plug Strips	
UL2930 Healthcare Outlet Assembly (HCOA)	M-8
UL1449 Metallic and Non-Metallic Strips	M-9
UL1363 Heavy Duty Metal Housing	M-10

Product	Page
Surge Protection Receptacles	M-13
SNAPConnect® TR and Power Indicating LED Receptacles	
Surge Protection	M-15
Isolated Ground	M-15
Straight Blade Isolated Ground Receptacles	M-17
Twist-Lock® Isolated Ground Receptacles	M-20
Specifications	
Surge Protection Plug Strips	M-11
Surge Protection Receptacles	M-21
Service/Branch Panel Protection	M-22

Products at a Glance



Surge Protection Panels and Wired-In Branch Panels

- 320,000, 160,000 and 120,000 peak amp capacity
- Wired-in branch panel protection 100,000 peak amp capacity
- Wired-in surge arrestors, single phase 36,000 and three phase 40,000
- Wired-in surge protective devices 50,000 peak amp capacity



SpikeShield® Surge Protection Plug Strips

- UL2930 Healthcare Outlet Assemblies
- UL1449 Surge Protective Devices
- 15A and 20A versions
- Available in metallic and non-metallic
- 6 foot or 15 foot cords available
- USB ports included in several models



Surge Protection Receptacles

- Available in Specification and Hospital Grade versions
- SNAPConnect® version with tamper-resistant shutters
- Isolated Ground Specification and Hospital Grade SPD's available



Isolated Ground Receptacles

- Available in Specification and Hospital Grade versions
- Twist-Lock® Isolated Ground available
- Isolated Ground SPD's also available

Features and Benefits

Hubbell Surge Protective Devices (SPD)

A cascading approach is recommended for optimal surge protection of any facility or home. A cascading approach includes surge protection at the service entrance, branch panel and the point-of-use. Hubbell offers a comprehensive offering of panel surge products, innovative surge strips and the broadest surge receptacle offering in the industry.

The SpikeShield® line of panel surge protective devices offers a broad selection of products to meet the many requirements of industrial, commercial, institutional and residential applications. Hubbell offers a complete offering of high quality, cost effective panel surge products.

- All panel surge products are UL1449 4th edition listed
- Protection levels from 50 kA to 320 kA to handle all real world surge events
- 120, 160 and 320 kA versions feature bus bar construction, bolt down modules, surge counter and a metallic NEMA 1 enclosure
- Hubbell's wired-in surge units are ideal for service entrance, branch panel, or point of use applications such as protecting variable speed drives or other sensitive equipment on the plant floor



Housing Design

- Surface mounting
- Compact design with bus-bar pathways, allows installation in areas with space restrictions
- NEMA 1 enclosure
- All panel products are UL Listed to Standard 1449 4th edition



Interior Design

- Bolt-down modules, assures positive connection and allows for easy replacement
- Thermal fuse prevents the MOVs from overheating when exposed to high current levels
- Peak amp capacity for 120kA, 160kA and 320kA, protects equipment under the worst electrical conditions



Optional Disconnect Models

- 160 kA and 320 kA surge panels are available with an optional integral disconnect
- Integral switch allows power to SPD to be disconnected before opening the enclosure door



Protection

- Diagnostics panel
- LED and audible alarm for module failure with silencing
- UL 1449 Type 1 to be used in both Type 1 and Type 2 applications
- Type 1 SPD's can be located at any point in the electrical system, on the line or load side of the equipment over-current device

320kA and 160kA Service/Branch Panel Protection

The SpikeShield® service entrance product line includes a line of panels with replaceable modules. This series features improved performance through the use of a low impedance bus-bar design and easily replaceable bolt-down modules.

They incorporate a modular (replaceable surge protection modules) design and feature the latest industry approvals and safety ratings. Including UL1449 4th edition.

- Improved performance through the use of a low impedance bus-bar design
- Replaceable surge protection modules
- Surge counter included in all units
- NEMA 1 enclosure
- LED and audible alarm status indicator



HBL4P320DB



HBL10P160DB

Service/Branch Panel Protection 320,000 Peak Amp Capacity (Type 1 SPD)

Voltage	Configuration	Catalog Number	With Disconnect	Replacement Module
120/240V AC Single Phase	1Ph. 3-wire +G	-	HBL3P320DB	HBL160M120B
120/208V AC Wye*	3Ph. Wye 4-wire +G	HBL4P320B	HBL4P320DB	HBL160M120B
277/480V AC Wye**	3Ph. Delta 3-wire +G	HBL8P320B	-	HBL160M480B
347/600V AC Wye	3Ph. Wye 4-wire +G	HBL10P320B	HBL10P320DB	-

Service/Branch Panel Protection 160,000 Peak Amp Capacity (Type 1 SPD)

Voltage	Configuration	Catalog Number	With Disconnect	Replacement Module
120/240V AC Single Phase	1Ph. 3-wire +G	-	HBL3P160DB	HBL160M120B
120/208V AC Wye*	3Ph. Wye 4-wire +G	HBL4P160B	HBL4P160DB	HBL160M120B
347/600V AC Wye	3Ph. Wye 4-wire +G	HBL10P160B	HBL10P160DB	HBL160M347B
600V AC Delta	3Ph. Delta 3-wire +G	HBL11P160B	-	-

Note: Units come standard with Surge Counter.

*120/208 Wye also applies to 127/220 Wye.

**277/480 Wye also applies to 220/380 Wye, 230/400 Wye and 240/415 Wye.

(1) Not available in stainless steel for 320 and 480 kA

(2) Do not use on undergrounded systems. Systems must be solidly grounded

(3) 208Y/120 series also applies to the following voltage 220Y/127

(4) Can be used on 4-wire or 3-wire grounded wye systems with or without neutral

(5) 480Y/277 series applies to the following voltages 380Y/220, 400Y/230, and 415Y/240

(6) 480 V Delta series also applies to the following voltage 480Y/277V HRG

(7) 600 V Delta series also applies to the following voltage 600Y/347V HRG

Electrical Specifications

320kA Panel	160kA Panel	SCCR ◊	I _n	MCOV †	Voltage Protection Rating (VPR)							
					L-N		L-G		N-G		L-L	
					320kA	160kA	320kA	160kA	320kA	160kA	320kA	160kA
-	HBL3P160B	200kA	20kA	150V	900	700	900	700	800	600	1500	1000
HBL4P320B	HBL4P160B	200kA	20kA	150V	900	700	900	700	800	600	1500	1000
HBL8P320B	-	200kA	20kA	320V	1500	1200	1500	1200	1200	1200	2000	2500
HBL10P320B	HBL10P160B	200kA	20kA	420V	1500	1500	1500	1500	1500	1500	2500	2500
-	HBL11P160B	200kA	20kA	840V	N/A	N/A	3000	2500	N/A	N/A	2500	2500

Note: Specification applies to both (B) and (DB) series.

◊ SCCR - Short Circuit Current Rating. † MCOV - Maximum Continuous Operating Voltage. I_n - Nominal discharge current.

Product Specifications

Max. Surge Current per Phase:	320kA and 160kA
Max. Operating Temperature:	-20°F to 149°F (-4°C to 65°C)
Diagnostics Indicators:	Push to Test Diagnostics, Red and Green Status LED's, Dry Contacts, Audible Alarm and Surge Counter
Dimensions:	11.04"W x 22.44"H x 7.87"D (320kA) and 11.04"W x 20.32"H x 5.32"D (160kA)
Weight:	37 lbs. Max. (320kA) and 27 lbs. Max. (160kA)
Terminal Accommodation:	#10 AWG to #2 AWG
Operating Frequency:	50/60 Hz
EMI/RFI:	Up to -30dB
Housing Rating:	NEMA 1
Listing:	cULus UL1449 4th edition type 1 SPD, UL1283 5th edition, CSA C22.2 No. 269.2-13 1st edition, CSA 22.2, No. 8-13, 5th edition.
Warranty:	10 year

120kA Service/Branch Panel Protection

The SpikeShield® 120kA branch panel product offering features an economical, compact, modular design.

- Economical, compact, modular design
- Protect branch panels, safety switches and load centers
- Surge counter included in all units
- NEMA 1 enclosure
- LED and audible alarm status indicator
- UL1449 4th edition



HBL8P120C

Service/Branch Panel Protection 120,000 Peak Amp Capacity (Type 1 SPD)

Voltage V AC	Configuration	Catalog Number	Replacement Module
120/240V AC Single Phase	1Ph. 3-wire +G	HBL3P120C	-
120/208V AC Wye*	3Ph. Wye 4-wire +G	HBL4P120C	-
277/480V AC Wye**	3Ph. Wye 4-wire +G	HBL8P120C	-
347/600V AC Wye	3Ph. Wye 4-wire +G	HBL10P120C	HBL10P120CM

Note: Units come standard with Surge Counter.

*120/208 Wye also applies to 127/220 Wye.

**277/480 Wye also applies to 220/380 Wye, 230/400 Wye and 240/415 Wye.

(1) Not available in stainless steel for 320 and 480 kA

(2) Do not use on undergrounded systems. Systems must be solidly grounded

(3) 208Y/120 series also applies to the following voltage 220Y/127

(4) Can be used on 4-wire or 3-wire grounded wye systems with or without neutral

(5) 480Y/277 series applies to the following voltages 380Y/220, 400Y/230, and 415Y/240

(6) 480 V Delta series also applies to the following voltage 480Y/277V HRG

(7) 600 V Delta series also applies to the following voltage 600Y/347V HRG

Electrical Specifications

120kA Panel	SCCR \diamond	I_n	MCOV \dagger	Voltage Protection Rating (VPR)			
				L-N	L-G	N-G	L-L
HBL3P120C	200kA	20kA	150V	700	700	600	1000
HBL4P120C	200kA	20kA	150V	700	700	600	1000
HBL8P120C	200kA	20kA	320V	1200	1200	1000	2000
HBL10P120C	200kA	20kA	420V	1500	1500	1200	2500

Note: \diamond SCCR - Short Circuit Current Rating. \dagger MCOV - Maximum Continuous Operating Voltage. I_n - Nominal discharge current.

Product Specifications

Max. Surge Current per Phase:	120kA
Max. Operating Temperature:	-40°F to 149°F (-40°C to 65°C)
Diagnostics Indicators:	Push to Test Diagnostics, Red and Green Status LED's, Dry Contacts, Audible Alarm and Surge Counter
Dimensions:	11.04"W x 11.44"H x 5.32"D
Weight:	23.0 lbs. Max.
Terminal Accommodation:	#10 AWG to #2 AWG
Operating Frequency:	50/60/400 Hz
EMI/RFI:	Up to -30dB
Housing Rating:	NEMA 1
Listing:	cULus UL1449 4th edition type 1 SPD, UL1283 5th edition, CSA C22.2 No. 269.2-13 1st edition, CSA 22.2, No. 8-13, 5th edition.
Warranty:	10 year

Wired-In Branch Panel Protection

The wired-in surge protection device brick design is ideal for areas where space is a major consideration. The surge unit can be mounted directly to the panel through a chase nipple connection which will reduce lead length and impedance while increasing protection levels.

The 100kA product features a NEMA 4X housing and a 200kA SCCR rating.

The SpikeShield wired-in surge protective devices are UL1449 4th edition listed.

- 100,000 Peak Amperage Capacity
- Ideal for areas where space is a major consideration
- Can be mounted directly to the panel through a chase nipple connection to reduce lead length and impedance



Wired-In Branch Panel Protection 100,000 Peak Amp Capacity (Type 2 SPD)

Service Voltage	Configuration	Catalog Number
120/240V AC Single Phase	1Ph. 3-wire +G	HBL3W100C
120/208V AC Wye*	3Ph. Wye 4-wire +G	HBL4W100C
277/480V AC Wye**	3Ph. Wye 4-wire +G	HBL8W100C
480V AC Delta	3Ph. Delta 3-wire +G	HBL9W100C
347/600V AC Wye	3Ph. Wye 4-wire +G	HBL10W100C
600V AC Delta	3Ph. Delta 3-wire +G	HBL11W100C

Note: *120/208 Wye also applies to 127/220 Wye.

**277/480 Wye also applies to 220/380 Wye, 230/400 Wye and 240/415 Wye.

^ΔAlso can be used on ungrounded systems.

(1) Not available in stainless steel for 320 and 480 kA

(2) Do not use on undergrounded systems. Systems must be solidly grounded

(3) 208Y/120 series also applies to the following voltage 220Y/127

(4) Can be used on 4-wire or 3-wire grounded wye systems with or without neutral

(5) 480Y/277 series applies to the following voltages 380Y/220, 400Y/230, and 415Y/240

(6) 480 V Delta series also applies to the following voltage 480Y/277V HRG

(7) 600 V Delta series also applies to the following voltage 600Y/347V HRG

Electrical Specifications

Catalog Number	SCCR [◇]	I _n	MCOV [†]	Voltage Protection Rating (VPR)			
				L-N	L-G	N-G	L-L
HBL3W100C	200kA	20kA	150/270	900	1200	700	1500
HBL4W100C	200kA	20kA	150/270	900	1200	700	1500
HBL8W100C	200kA	20kA	320/640	1200	2000	1000	2500
HBL9W100C	200kA	20kA	640	N/A	N/A	N/A	3000
HBL10W100C	200kA	20kA	390/780	1500	2500	1500	3000
HBL11W100C	200kA	20kA	780	N/A	N/A	N/A	3000

Note: [◇]SCCR - Short Circuit Current Rating.

[†]MCOV - Maximum Continuous Operating Voltage.

I_n - Nominal discharge current.

Product Specifications

Max. Surge Current per Phase:	100kA
Max. Operating Temperature:	-40°F to 140°F (-40°C to 60°C)
Diagnostics Indicators:	Green Status LED's, Audible Alarm, Dry Contacts
Dimensions:	9.9"W x 4.8"H x 3.1"D
Weight:	4.78 lbs.
Terminal Accommodation:	#10 AWG 18.0" Wire Leads
Frequency:	50/60 Hz
EMI/RFI:	Up to -30dB
Housing Rating:	Type 4X
Listing:	cULus UL 1449 4th edition type 2 SPD, UL1283 (Wye prod. only), CSA C22.2 NO. 8-M1986
Warranty:	10 year

Wired-In Surge Arrestors and Protective Devices

Surge Arrestors are a low cost solution that may be installed on the line side or load side of the service entrance. These are also excellent for OEM applications where size is an important variable.

Hubbell's 50kA single phase wired-in high-quality surge protective device features a compact design, NEMA 4X rating and are UL1449 4th edition listed.

- 36,000, 40,000 and 50,000 Peak Amperage Capacity
- Surge arrestors are a low cost solution that may be installed on the line side or load side of the service entrance
- Excellent for OEM applications where size is an important variable
- Single phase wired-in surge protective devices feature a compact design



Wired-In High-Quality Surge Protective Device (Type 1 SPD)

Service Voltage	Configuration	Peak Amp Capacity	Mounting Means	Catalog Number
120/240V AC Single Phase	1Ph. 3-wire + G	50kA	Side Nipple Mount	HBL3W50

Wired-In Surge Arrestors, Single Phase and Three Phase (Type 1 SPD)

Service Voltage	Configuration	Peak Amp Capacity	Mounting Means	Catalog Number
120/240V AC Single Phase	1Ph. 3-wire	36kA	Back Nipple Mount	HBLSDSA36
120/208V AC Wye*	3Ph. 4-wire	40kA	Back Nipple Mount	HBL4SA40
240V AC Delta	3Ph. 3-wire	40kA	Back Nipple Mount	HBL5SA40
480V AC Delta	3Ph. 3-wire	40kA	Back Nipple Mount	HBL9SA40
347/600V AC Wye	3Ph. 4-wire	40kA	Back Nipple Mount	HBL10SA40
600V AC Delta	3Ph. 3-wire	40kA	Back Nipple Mount	HBL11SA40

Electrical Specifications

Catalog Number	SCCR \diamond	I_n	MCOV \dagger	Voltage Protection Rating (VPR)			
				L-N	L-G	N-G	L-L
HBL3W50	25kA	10kA	150 (L-N, L-G), 300 (L-L)	700	800	N/A	1200
HBLSDSA36	22kA	10kA	150	700	N/A	N/A	1200
HBL4SA40	200kA	10kA	180 (L-N), 360 (L-L)	700	N/A	N/A	1200
HBL5SA40	200kA	10kA	360 (L-L)	N/A	N/A	N/A	1200
HBL9SA40	200kA	10kA	840 (L-L)	N/A	N/A	N/A	2500
HBL10SA40	200kA	10kA	510 (L-N), 1020 (L-L)	1800	N/A	N/A	3000
HBL11SA40	200kA	10kA	1020 (L-L)	N/A	N/A	N/A	3000

Note: \diamond SCCR - Short Circuit Current Rating. \dagger MCOV - Maximum Continuous Operating Voltage. I_n - Nominal discharge current.

Product Specifications

Service Voltage	Single Phase	Single Phase	Three Phase
Max. Surge Current per Phase:	50kA	36kA	40kA
Max. Operating Temperature:	-40°F to 149°F (-40°C to 65°C)	-40°F to 149°F (-40°C to 65°C)	-40°F to 149°F (-40°C to 65°C)
Diagnostics Indicators:	Green Status LED per line	Green Status LED per line	Green Status LED per line
Dimensions:	3.0"W x 3.6"H x 2.67"D	2.25"W x 2.25"H x 1.94"D	3.60"W x 3.0"H x 2.64"D
Weight:	1.8 lbs.	.72 lbs.	1.8 lbs.
Terminal Accommodation:	#12 AWG Wire Leads	#14 AWG Wire Leads	#12 AWG Wire Leads
Frequency:	50/60 Hz	50/60 Hz	50/60 Hz
EMI/RFI:	Up to -30dB	Up to -30dB	Up to -30dB
Housing Rating:	Type 4X	Type 4X	Type 4X
Listing:	UL1449 4th edition	UL1449 4th edition	UL1449 4th edition
Warranty:	10 year	2 year	2 year

SpikeShield® Power Quality Products

Features and Benefits

UL2930 Healthcare Outlet Assembly (HCOA)

- Hubbell's UL2930 HCOAs are the industry first
- UL listed product for patient care areas
- Product is available with or without L-N surge protection
- 4 Outlet models feature straight plugs



UL2930 Listed



45° Angle Plug
(6 outlet 15A models only)

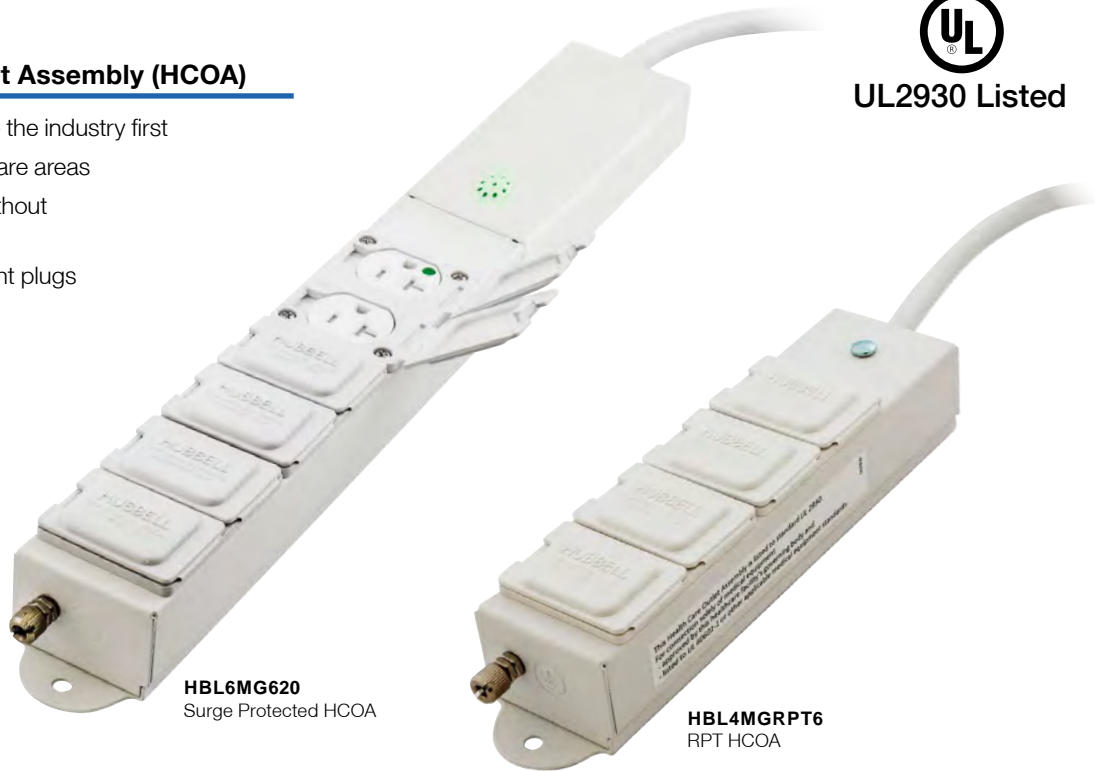

Housing Design and Safety

- First UL2930 product ever sold
- 15A and 20A 125V versions
- Surge or Non-surge protected models in all configurations
- Tamper-resistant flip covers
- Green LED indicates surge protection working



Contacts and Cord

- Equipment grounding terminal
- 6 ft. or 15 ft. cord length
- 12/3 AWG cord on 15A and 20A models
- 45° angle plug (6 outlet 15A models only)
- 90° angle plug (All 4 outlet and all 20A models)

UL2930 Healthcare (6) Outlet Assembly (HCOA)

Description	# of Outlets	Joule Rating	Cord Length	Color	15 Amp	20 Amp
UL2930 HCOA with L-N Surge Protection	6	550	6 Ft.	White	HBL6MG6	HBL6MG620
	6	550	15 Ft.	White	HBL6MG15	HBL6MG1520
UL2930 HCOA Relocatable Power Tap (RPT)	6	N/A	6 Ft.	White	HBL6MGRPT6	HBL6MGRPT620
	6	N/A	15 Ft.	White	HBL6MGRPT15	HBL6MGRPT1520

UL2930 Healthcare (4) Outlet Assembly (HCOA)

Description	# of Outlets	Joule Rating	Cord Length	Color	15 Amp	20 Amp
UL2930 HCOA with L-N Surge Protection	4	550	6 Ft.	White	HBL4MG6	HBL4MG620
	4	550	15 Ft.	White	HBL4MG15	HBL4MG1520
UL2930 HCOA Relocatable Power Tap (RPT)	4	N/A	6 Ft.	White	HBL4MGRPT6	HBL4MGRPT620
	4	N/A	15 Ft.	White	HBL4MGRPT15	HBL4MGRPT1520

Hubbell HCOA Accessories

Description	Color	Catalog Number
HCOA mounting bracket allows strips to be easily mounted to IV poles or other like medical devices.	Black	HBLHCOAMB
HCOA replacement outlet cover	White	ROCMGS



HBL6MG6



HBL4MGRPT6



HBLHCOAMB



ROCMGS

SpikeShield® Power Quality Products

Healthcare Industry

- Hospital grade ● tamper-resistant receptacles with a hospital grade ● plug
- cULus 1449 4th edition
- Heavy duty metal housing
- Available with a 2-port USB charging outlet

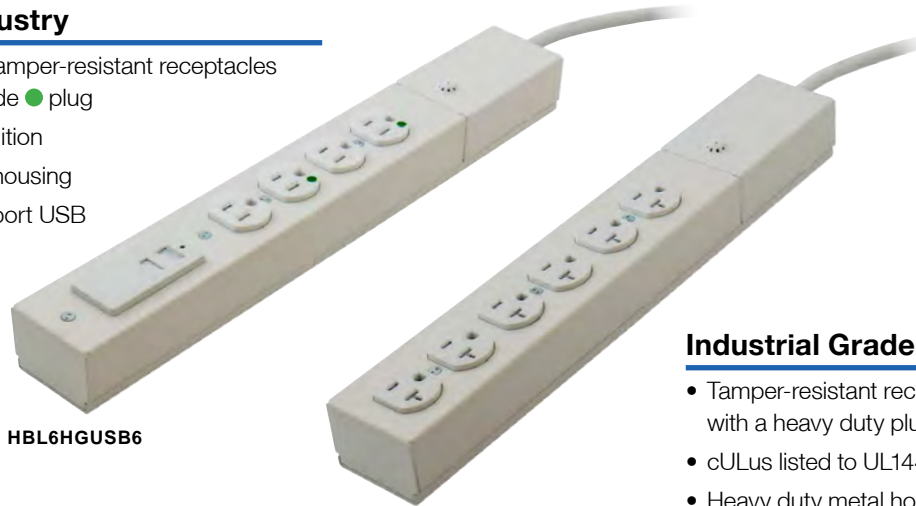

HBL6HGUSB6

HBL6SS620



Listed to UL1449 and UL1363

Industrial Grade

- Tamper-resistant receptacles with a heavy duty plug
- cULus listed to UL1449 4th edition, UL1363
- Heavy duty metal housing

SpikeShield® Surge Protective Devices (SPD) with Tamper-Resistant Receptacles and Heavy Duty Plug

Description	# of Outlets	Joule Rating	Cord Length	Color	Healthcare Industry		Industrial Grade	
					15 Amp	20 Amp	15 Amp	20 Amp
UL Type 3 SPD, Heavy Duty Metal Housing	6	1100	6'	White	HBL6HG6	HBL6HG620	HBL6SS6	HBL6SS620
	6	1100	15'	White	HBL6HG15	HBL6HG1520	HBL6SS15	HBL6SS1520
UL Type 3 SPD, Heavy Duty Metal Housing with 2-port USB	4	1100	6'	White	HBL6HGUSB6	—	—	—

Metallic Surge Protection Strips

Description	# of Outlets	Joule Rating	Peak AMP Rating	Cord Length	Color	Down Line Warranty	Catalog Number
Metal Power Strip (No surge protection)	6	N/A	N/A	6'	Office White	N/A	HBL6MPS
Metal Power Strip (No surge protection)	6	N/A	N/A	15'	Office White	N/A	HBL6MPS15
Metal SPD	6	1050	19.5kA	6'	Office White	\$2,500	HBL6MPS1050
Metal SPD	6	1050	19.5kA	15'	Office White	\$2,500	HBL6MPS105015
SPD with Wire Management	6	350	6.5kA	6'	Yellow	\$2,500	HBL6PS350YL
SPD with Wire Management	8	350	6.5kA	6'	Yellow	\$2,500	HBL8PS350YL



HBL6MPS



HBL6PS350YL

Non-Metallic Surge Protection Strips

Description	# of Outlets	Joule Rating	Peak AMP Rating	Cord Length	Color	Down Line Warranty	Catalog Number
Power Strip (No surge protection)	6	N/A	N/A	6'	Office White	N/A	HBL6PPS
SPD	6	350	6.5kA	6'	Office White	\$2,500	HBL6PS350A
SPD	6	350	6.5kA	15'	Office White	\$2,500	HBL6PS35015A
SPD with Fax/Modem	6	1050	19.5kA	6'	Office White	\$2,500	HBL6PS1050MA
SPD	7	1050	19.5kA	6'	Office White	\$10,000	HBL7PS1050A
SPD with Fax/Modem	7	1050	19.5kA	6'	Office White	\$10,000	HBL7PS1050MA
SPD	7	1050	19.5kA	15'	Office White	\$10,000	HBL7PS105015A
SPD with Fax/Modem/CATV	8	2100	39kA	6'	Office White	\$25,000	HBL8PS2100MA
SPD with Two USB Ports and 90° Angle Plug.	4	1050	19.5kA	6'	Black	\$10,000	HBL4PS1050USBA



HBL6PS350A



HBL8PS2100MA



HBL4PS1050USBA

SpikeShield® Power Quality Products

Features and Benefits

Heavy Duty Relocatable Power Taps for Industrial, Commercial and Retail Applications

- Heavy-duty 18 gauge galvanized steel housing with durable powder coat finish
- Available in 15A and 20A configurations
- 6 Ft. and 15 Ft. cord length options for all models
- 15A models feature a 45° angle plug
- 20A models feature a 90° angle plug
- All models come with built in circuit breaker for over current protection
- Church-key openings on the back of the RPT for temporary mounting ease
- White powder coat RPTs feature UL Listed Hospital Grade, Tamper-Resistant Receptacles
- Black powder coat RPTs feature Specification Grade, Tamper-Resistant Receptacles



Listed to UL1363



HBL6RPT620

HBL6RPT6BK



Housing Design and Safety

- Heavy-duty 18 gauge galvanized steel housing with durable powder coat finish
- White or Black powder coat RPTs feature Tamper-Resistant Receptacles
- Church-key openings on the back of the RPT for temporary mounting ease



Contacts and Cord

- All models come with built in circuit breaker for over current protection
- 6 ft. or 15 ft. cord length
- 45° angle plug (15A series)
- 90° angle plug (20A series)

Relocatable Power Tap with Hospital Grade Tamper-Resistant Receptacles

Description	# of Outlets	Cord Length	Color	15A 125V	20A 125V
RPT, Heavy Duty Metal Housing	6	6 Ft.	White	HBL6RPT6	HBL6RPT620
	6	15 Ft.	White	HBL6RPT15	HBL6RPT1520

Relocatable Power Tap with Specification Grade Tamper-Resistant Receptacles

Description	# of Outlets	Cord Length	Color	Catalog Number	20A 125V
RPT, Heavy Duty Metal Housing	6	6 Ft.	Black	HBL6RPT6BK	HBL6RPT620BK
	6	15 Ft.	Black	HBL6RPT15BK	HBL6RPT1520BK

Relocatable Power Tap Specifications

Electrical Specifications

Current	15A	20A
Voltage	125V	125V
Frequency	60Hz	60Hz
Over Current Protection	15A CB	20A CB

Physical Specifications

Length	11.12" (282.4)
Width	2.22" (56.4)
Height	1.6" (40.5)

Environmental Specifications

Operating Temperature	-40°F to 160°F
	(-40°C to 70°C)

Certifications

cULus Listed UL1363 RPT



HBL6RPT6



HBL6RPT620BK

SpikeShield® Power Quality Products

Specifications

UL2930 Healthcare Outlet Assembly

Electrical Specifications	HBL6MG6/15		HBL6MG20/1520		HBL6MGRPT6/15		HBL6MGRPT20/1520	
	Current	15A	20A	15A	20A	15A	20A	15A
Voltage	125V	125V	125V	125V	125V	125V	125V	125V
Frequency	60Hz	60Hz	60Hz	60Hz	60Hz	60Hz	60Hz	60Hz
Surge Component	MOV	MOV	N/A	N/A	N/A	N/A	N/A	N/A
Performance					Environmental Specifications			
UL VPR L-N		600V					Operating	-40°F to 160°F
L-G, N-G		N/A					Temperature	(-40°C to 70°C)
EMI Noise Filtration:	-11 dB to -68 dB (10kHz to 100MHz)						Certifications	
In (Nominal Discharge Current)		3kA			N/A	N/A	UL 2930; UL File # E488399;	
MCOV		150V					RoHS Compliant; NFPA 99 2012 ed;	
Peak Current Rating L-N		30KA					ANSI/IEEE Category A (HBL6MG Series Only)	
Leakage Current:		<.1mA						
Total Joules (L-N)		550j						

SpikeShield® Surge Protective Devices (SPD) with Industrial Grade Tamper-Resistant Receptacles and Heavy Duty Plug

Electrical Specifications	15 Amp HBL6SS/HBL6HG Series		20Amp HBL6SS/HBL6HG Series		Certifications	
	Current	15A		20A		
Voltage	125V		125V			
Frequency	60Hz		60Hz			
Surge Component	MOV		MOV			
Over Current Protection	15A CB		20A CB			
2-Port USB (HBL6HGUSB6)	5V DC Type A		N/A			
UL VPR	L-N	L-G	N-G			
	500V	600V	600V			
MCOV		150V				
Peak Current Rating L-N		30KA				
Leakage Current:		<.5mA				
EMI / RFI Noise Rejection	-11 dB to -68 dB (10kHz to 100MHz)				Environmental Specifications	
Total Joules (all modes)		1100j			Operating Temperature	-40°F to 160°F (-40°C to 70°C)

SpikeShield® Surge Protection Plug Strips

Operating Specifications	PS350 Series	MPS350 Series	PS350YL Series	PS1050 Series	Dimensions
	Max. Cont. Operating Voltage	130	130	130	
Operating Frequency	50/60 Hz	50/60 Hz	50/60 Hz	50/60 Hz	Length
Max Surge Current	6.5 kA	6.5 kA	6.5 kA	19.5 kA	Width
Operating Temperature	----- -40°F to 160°F (-40°C to 70°C) -----				Height
Performance					HBL6PS350/1050 Series & HBL6PPS
UL Voltage Protection Rating	400V	400V	400V	400V	HBL7PS1050 Series
MI / RFI Noise Rejection	—	—	—	-20dB	HBL6MPS Series
Downline Warranty*	\$2,500	\$2,500	\$2,500	\$2,500 (6PS1050) \$10,000 (all others)	HBL6PS350YL
					HBL8PS350YL
					HBL4PS1050USB

*See warranty information inside product box for details.

Lexan® is a trademark of SABIC Innovative Plastics, acquired from General Electric Company.

SpikeShield® Power Quality Products

Features and Benefits

Surge Protection Receptacles

Hubbell offers a broad range SPD receptacles with technology that is unsurpassed. Inside Hubbell SPD receptacles are two 22mm square MOVs providing 240 joules of surge protection for each mode. The nylon component shield protects the printed circuit board from contaminants. An all-glass, conformably coated PC board provides superior moisture immunity for longer life in humid environments.

- Alarmed and non-alarmed versions
- Available in 15A and 20A versions
- Commercial Specification Grade and Hospital Grade
- IG available in all versions



Note: The effectiveness of SPD devices diminishes with the increase in distance between the device and the equipment to be protected.



Housing Design

- Meets UL Standards 1449 4th Edition and 498; CSA Certified
- Impact-resistant nylon face
- Available in Hospital Grade, 4-PLEX®, SNAPConnect® and Tamper-Resistant
- Fits standard wall box



Terminals

- Back and side wiring capability provides easy installation with stranded or solid wire



One-Piece Mounting Strap

- Wrap-around, locked on steel mounting strap provides additional support strength for receptacle assembly
- Automatic self-grounding staple attached to bridge meets NEC® requirements



Contacts

- Green grounding screw connected directly to the grounding contacts



Identification

- Distinctive surge symbol provides quick visual identification
- Surge protection indicator light
- Muting screw allows damage-alert alarm to be silenced until device is replaced



4-PLEX Surge Receptacles

- Distinctive surge symbol
- Surge protection indicator light

NEC® is a registered trademark of the National Fire Protection Association (NFPA).

Circuit Guard®, Specification Grade Duplex Receptacles



15A 125V
NEMA 5-15R
UL CSA



20A 125V
NEMA 5-20R
UL CSA

Description	Color	Catalog Number	
Surge protection receptacles with light, 240 joules, 15kA peak current.	Blue	HBL5260SA	HBL5360SA
	Ivory	HBL5260ISA	HBL5360ISA
	Office White	HBL5260OWSA	HBL5360OWSA
	White	HBL5260WSA	HBL5360WSA
Surge protection receptacles with light and alarm, 240 joules, 15kA peak current.	Blue	HBL5262SA	HBL5362SA
	Gray	HBL5262GYSA	HBL5362GYSA
	Ivory	HBL5262ISA	HBL5362ISA
	Office White	HBL5262OWSA	HBL5362OWSA
	White	HBL5262WSA	HBL5362WSA
Isolated ground, surge protection receptacles with light and alarm, 240 joules, 15kA peak current.	Blue	IG5262SA	IG5362SA
	Gray	IG5262GYSA	IG5362GYSA
	Ivory	IG5262ISA	IG5362ISA
	Office White	IG5262OWSA	IG5362OWSA
	Orange	IG5262OSA	IG5362OSA
4-PLEX® surge protection receptacles with lights, 80 joules, 6.5kA peak current.	Blue	HBL415S	HBL420S
	Ivory	HBL415IS	HBL420IS

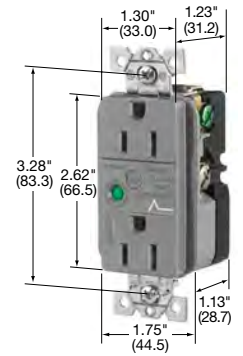

HBL5262GYSA

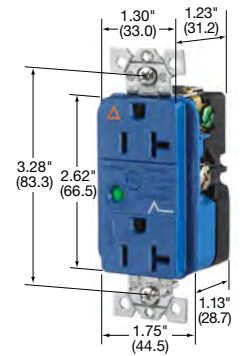

IG5362SA

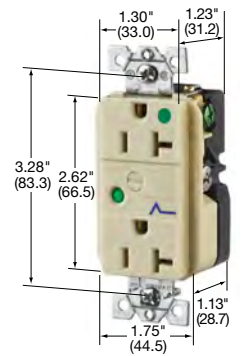

HBL8362ISA

Circuit Guard®, Hospital Grade Duplex Receptacles

Description	Color	Catalog Number	
Surge protection receptacles with light and alarm, 240 joules, 15kA peak current.	Blue	HBL8262SA	HBL8362SA
	Gray	HBL8262GYSA	HBL8362GYSA
	Ivory	HBL8262ISA	HBL8362ISA
	Red	HBL8262RSA	HBL8362RSA
	White	HBL8262WSA	HBL8362WSA
Isolated ground, surge protection receptacles with light and alarm, 240 joules, 15kA peak current.	Blue	IG8262SA	IG8362SA
	Gray	IG8262GYSA	IG8362GYSA
	Ivory	IG8262ISA	IG8362ISA
	Orange	IG8262OSA	IG8362OSA
	Red	IG8262RSA	IG8362RSA
4-PLEX surge protection receptacles with lights, 80 joules, 6.5kA peak current.	Blue	—	HBL420HS
	Ivory	—	HBL420HIS
	Red	—	HBL420HRS

4-PLEX® Accessories

Description	Color	Catalog Number
4-PLEX adapter plates for 1- and 2-gang (4-PLEX mount directly to 4" (101.6) square device boxes).	Blue	HBL4APBL
	Ivory	HBL4API
	Red	HBL4APR
4-PLEX portable box. Portable 4" (101.6) square box with one cord grip. Accepts up to .66" (16.8) dia. cord.	Ivory	HBL4PBI

Note: 4-PLEX box is not UL Listed.

Wallplates (Sold Separately)

Configuration	High-Impact Thermoplastic			Plated Steel		Stainless Steel (S/S) Brass	
	Color	Standard	Mid-Size				
 1-Gang	Blue	—	PJ26BL	Chrome Brass Plated	SCH26 SBP26	Smooth S/S Smooth S/S Smooth Brass	SS26
	Gray	P26GY	PJ26GY				SSJ26 ▲
	Ivory	P26I	PJ26I				SB26
	Ivory	—	PJ26C*				
	Orange	P26OIG**	—				
	Red	P26R	PJ26R				
	White	P26W	PJ26W				

Note: *Premarked "COMPUTER ONLY." Lettering is block 1/4" high.
 **Premarked "ISOLATED GROUND." Lettering is block 1/4" high.
 ▲ Jumbo size plate.
 See section O for additional wallplates.

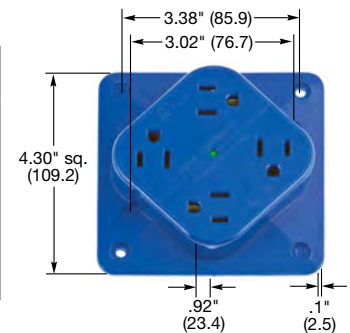

HBL415S

Dimensions in Inches (mm)

SpikeShield® Power Quality Products

Features and Benefits

SNAPConnect® Surge Protection and Isolated Ground Receptacles Heavy Duty Specification Grade

Hubbell's SNAPConnect® Isolated Ground devices are available in a variety of styles.

- All SNAPConnect® IG receptacles include Hubbell's industry best tamper resistant shutter
- 15A and 20A models are available in Hospital Grade, HG Decorator, Commercial Specification Grade, and Commercial Decorator versions
- SNAPConnect® IG devices are also available with a power indicating LED version in all the aforementioned grades. The power indicating product is also available in a non TR shutter design
- SNAPConnect® connectors come standard with solid or stranded 12 AWG THHN



Note: The effectiveness of SPD devices diminishes with the increase in distance between the device and the equipment to be protected.



Protection

- Hubbell surge receptacles offer 240 joules of protection and 15 kA peak current rating
- Surge protection LED indicator flashes when surge protection is lost
- Audible alarm also provides user notification that surge protection has been lost. Muting screw allows user to turn alarm OFF once replacement has been scheduled



Isolated Ground

- IG triangle on the face of the receptacle clearly indicates isolated ground device
- LED Power-ON indicator available on all models
- Hubbell's patented TR shutter design is utilized on all IG receptacles that feature the Tamper-Resistant option



Installation

- SNAPConnect® devices reduce labor time during installation and when being serviced in the future
- Connectors available with solid or stranded leads
- Custom length leads available
- Push on wire option also available on SNAPConnect® connectors



Installation

- SNAPConnect® Isolated ground devices are available in standard duplex design or decorator shape
- 15A and 20A version in Commercial Specification Grade and Hospital Grade
- SNAPConnect® Isolated Ground devices provide a clean ground path for sensitive equipment

SNAPConnect® Tamper-Resistant Surge Protection Receptacle with Power Indicating LED



Description	Color	Catalog Number	
Hospital Grade ● SNAPConnect® Tamper-Resistant, surge suppression duplex receptacle, smooth face, 240 joules, 15kA peak current.	Blue	SNAP8262S	SNAP8362S
	Gray	SNAP8262GYS	SNAP8362GYS
	Ivory	SNAP8262IS	SNAP8362IS
	Light Almond	SNAP8262LAS	SNAP8362LAS
	Red	SNAP8262RS	SNAP8362RS
	White	SNAP8262WS	SNAP8362WS
Commercial Grade SNAPConnect® Tamper-Resistant, surge suppression duplex receptacle, smooth face, 240 joules, 15kA peak current.	Blue	SNAP5262S	SNAP5362S
	Gray	SNAP5262GYS	SNAP5362GYS
	Ivory	SNAP5262IS	SNAP5362IS
	Light Almond	SNAP5262LAS	SNAP5362LAS
	White	SNAP5262WS	SNAP5362WS

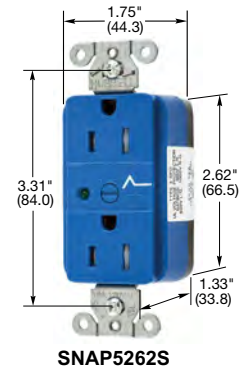

SNAP5262S

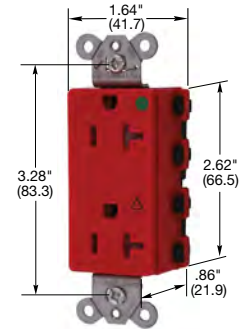

SNAP2182RIGTRA

SNAPConnect® Tamper-Resistant Isolated Ground Receptacle

Description	Color	Catalog Number	
Hospital Grade ● SNAPConnect® Tamper-Resistant, isolated ground, smooth face, duplex.	Orange	SNAP8200IGTRA	SNAP8300IGTRA
	Red	SNAP8200RIGTRA	SNAP8300RIGTRA
Hospital Grade ● Style Line® decorator SNAPConnect® Tamper-Resistant, isolated ground, smooth face, duplex.	Orange	SNAP2172IGTRA	SNAP2182IGTRA
	Red	SNAP2172RIGTRA	SNAP2182RIGTRA
Commercial Grade, isolated ground.	Orange	SNAP5262IGTRA	SNAP5362IGTRA
Style Line® decorator.	Orange	SNAP2152IGTRA	SNAP2162IGTRA

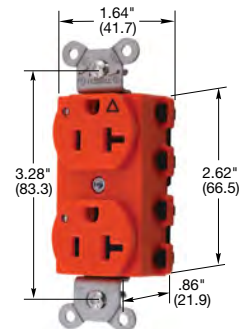

SNAP5362IGL

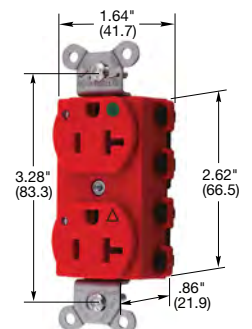

SNAP8300RIGLTRA

SNAPConnect® Isolated Ground Receptacle with Power Indicating LED

Description	Color	Catalog Number	
Hospital Grade ● SNAPConnect® Tamper-Resistant, isolated ground, smooth face, duplex.	Orange	SNAP8200IGL	SNAP8300IGL
	Red	SNAP8200RIGL	SNAP8300RIGL
Hospital Grade ● Style Line® decorator SNAPConnect® Tamper-Resistant, isolated ground, smooth face, duplex.	Orange	SNAP2172IGL	SNAP2182IGL
	Red	SNAP2172RIGL	SNAP2182RIGL
Commercial Grade, isolated ground.	Orange	SNAP5262IGL	SNAP5362IGL
Style Line® decorator.	Orange	SNAP2152IGL	SNAP2162IGL

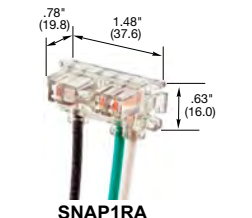

SNAP1RA

SNAPConnect® Tamper-Resistant Isolated Ground Receptacle with Power Indicating LED

Description	Color	Catalog Number	
Hospital Grade ● SNAPConnect® Tamper-Resistant, isolated ground, smooth face, duplex.	Orange	SNAP8200IGLTRA	SNAP8300IGLTRA
	Red	SNAP8200RIGLTRA	SNAP8300RIGLTRA
Hospital Grade ● Style Line® decorator SNAPConnect® Tamper-Resistant, isolated ground, smooth face, duplex.	Orange	SNAP2172IGLTRA	SNAP2182IGLTRA
	Red	SNAP2172RIGLTRA	SNAP2182RIGLTRA
Commercial Grade, isolated ground.	Orange	SNAP5262IGLTRA	SNAP5362IGLTRA
Style Line® decorator.	Orange	SNAP2152IGLTRA	SNAP2162IGLTRA



SNAPConnect® Right Angle Pigtailed Connector for General Use

Description	Solid Wire	Stranded Wire
Clear right angle terminal with 6 inch leads #12 AWG THHN/THWN-2, 600V, Polycarbonate housing material.	SNAP1RA	SNAP2RA

Note: See page Tech-10 for Tamper-Resistant and LED Power Indicators descriptions.

Dimensions in Inches (mm)

SpikeShield® Power Quality Products

Features and Benefits

Straight Blade Isolated Ground Receptacles

In February 1968, Hubbell patented the first isolated ground receptacle. Today —when a clean, noise-free ground is more important than ever—Hubbell is still setting the standard.

Hubbell uses insulation barrier construction on many models to isolate the ground contacts from the mounting strap. The green grounding screw is connected directly to the grounding contacts. In this way, ground contacts are separated from the mounting strap and also from the conventional grounding system. The isolated ground circuit is completed by running a dedicated insulated ground wire from the system ground buss to the green grounding screw.

And there's more to the Hubbell line:

- Available in 19 NEMA configurations and a total of 60 different type receptacles.
- Versatility and mobility: With Hubbell's grounding method, Hubbell's IG devices can be mounted in boxes, on metal panels almost anywhere.
- Hubbell quality: Every Hubbell IG device meets and exceeds all applicable codes and standards, specially the toughest standard of all, the Hubbell standard of excellence.



Housing Design

- Dimensionally stable, reinforced thermoplastic polyester provides impact strength in addition to heat and flame resistance
- Impact-resistant nylon face
- Straight blade 15A and 20A, 125V duplex receptacles are available in a variety of colors



Terminals

- Back and side wiring capability provides easy installation with stranded or solid wire

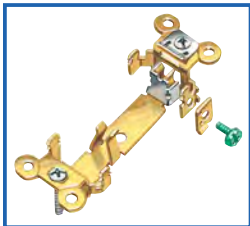

One-Piece Mounting Strap

- Wrap-around, locked on brass mounting strap provides additional support strength for receptacle assembly
- Automatic self-grounding clip assures ground continuity between mounting strap and metal wall box

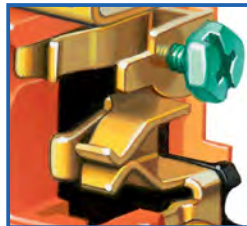

Contacts

- Green grounding screw connected directly to the grounding contacts
- Insulation barrier construction — first patented by Hubbell — isolates ground contacts from the mounting strap



Identification

- IG triangle on the face of the receptacle clearly indicates isolated ground device
- Amperage and voltage clearly indicated



Center Rivet

- Square head, 10-thread bronze center rivet won't rotate, reduces stripping and resists corrosion

Hospital Grade ●, HBL® Extra Heavy Duty, Isolated Ground Receptacles



15A 125V
NEMA 5-15R
UL CSA
0.5 HP



20A 125V
NEMA 5-20R
UL CSA
1 HP

Description	Color	Catalog Number	
Flush, thermoplastic polyester face, duplex, back and side wired, multiple drive screws.	Orange	IG8200	IG8300
	Red	IG8200R	IG8300R
Style Line® decorator.	Orange	—	IG2182
	Ivory	—	IG2182I
	White	—	IG2182WA
Flush, thermoplastic polyester face, single.	Orange	IG8210	IG8310

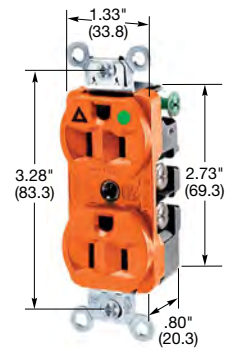

IG8200

15A and 20A, 125V HBL® Extra Heavy Duty, Specification Grade, Isolated Ground Receptacles



15A 125V
NEMA 5-15R
UL CSA
0.5 HP



20A 125V
NEMA 5-20R
UL CSA
1 HP

Description	Color	Catalog Number	
Flush, nylon face, duplex, back and side wired, multiple drive screws.	Orange	IG5262	IG5362
	Gray	IG5262GY	IG5362GY
	Ivory	IG5262I	IG5362I
	Red	IG5262R	IG5362R
	White	—	IG5362W
Weather Resistant, duplex, isolated ground.	Orange	IG5262WR	IG5362WR
	Gray	IG5262GYWR	IG5362GYWR
	Ivory	IG5262IWR	IG5362IWR
	Red	IG5262RWR	IG5362RWR
	White	—	IG5362WWR
Finder groove, nylon face, duplex, back and side wired.	Orange	CR5252IG	CR5352IG
	Black	CR5252IGBK	CR5352IGBK
	Blue	—	CR5352IGBL
	Gray	CR5252IGGY	CR5352IGGY
	Ivory	CR5252IGI	CR5352IGI
	Office White	CR5252IGOW	CR5352IGOW
	White	CR5252IGW	CR5352IGW
Style Line® decorator, flush, nylon face, back and side wired.	Orange	IG2152	IG2162
	Gray	—	IG2162GY
4-PLEX® receptacle.	Orange	IG415	IG420*
Flush, nylon face, single, back and side wired.	Orange	IG5261	IG5361
Weather Resistant, single, Isolated ground.	Orange	IG5261WR	IG5361WR

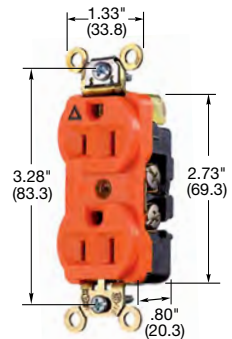

IG5262

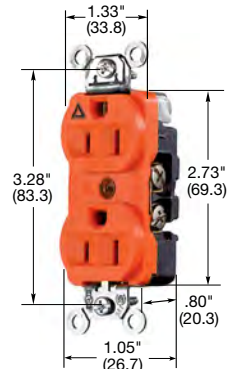

CR5252IG

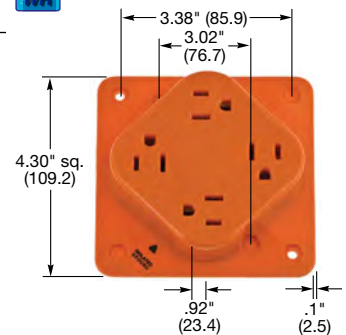

IG415

Note: *Not Fed. Spec. Listed.
See page Tech-10 for Weather Resistant description.
See page A-47 and A-48 for accessories.
See page A-28 for 4-PLEX accessories.

Dimensions in Inches (mm)

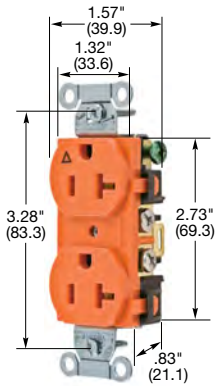

IG5352

Hubbell-PRO Heavy Duty Specification Grade



15A 125V
NEMA 5-15R
UL CSA
0.5 HP



20A 125V
NEMA 5-20R
UL CSA
1 HP

Description	Color	Catalog Number	
Smooth face, duplex, back and side wired.	Orange	IG5252	IG5352
	Gray	IG5252GY	IG5352GY
	Ivory	IG5252I	IG5352I
	Light Almond	IG5252LA	IG5352LA
	White	IG5252W	IG5352W
Tamper-Resistant, smooth face, duplex, back and side wired.	Orange	IG5252TR	IG5352TR
	Ivory	IG5252ITR	IG5352ITR
	White	IG5252WTR	IG5352WTR



Note: See page Tech-10 for Tamper-Resistant description.

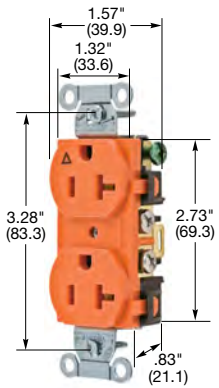

IG20CR

Commercial Specification Grade

Description	Color	Catalog Number	
Smooth face, duplex, side wired.	Orange	IG15CR	IG20CR
	Gray	IG15CRGRY	IG20CRGRY
	Ivory	IG15CRI	IG20CRI
	Light Almond	IG15CRLA	IG20CRLA
	White	IG15CRWHI	IG20CRWHI
Style Line® decorator; smooth face; back and side wired.	Orange	IG15DR	IG20DR
	Gray	IG15DRGRY	IG20DRGRY
	Ivory	IG15DRI	IG20DRI
	Light Almond	IG15DRLA	IG20DRLA
	White	IG15DRWHI	IG20DRWHI

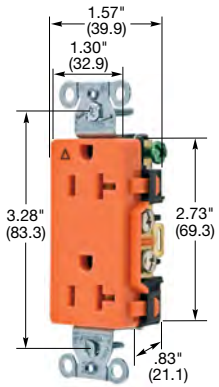

IG20DR

15A and 20A, 250V HBL® Extra Heavy Duty, Specification Grade, Isolated Ground Receptacles



15A 250V
NEMA 6-15R
UL CSA
1.5 HP



20A 250V
NEMA 6-20R
UL CSA
2 HP

Description	Color	Catalog Number	
Flush, nylon face, duplex, back and side wired, multiple drive screws.	Orange	IG5662	IG5462
Flush, nylon face, single.	Orange	IG5661	IG5461

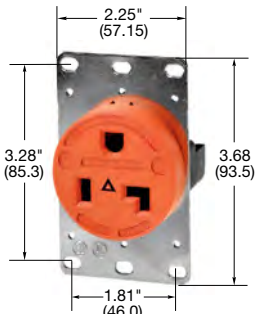

IG9308

IP20
SUITABILITY



30A 125V
NEMA 5-30R
UL CSA
2 HP



30A 250V
NEMA 6-30R
UL CSA
2 HP

30A, 125V and 250V Isolated Ground Receptacles

Description	Color	Catalog Number	
Single receptacle, 2 pole, 3 wire grounding.	Orange	IG9308	IG9330

Dimensions in Inches (mm)

SpikeShield® Power Quality Products

Features and Benefits

Isolated Ground Twist-Lock® Receptacles

Hubbell uses insulation barrier construction to isolate the ground contacts from the mounting strip, providing a clean, noise-free ground for sensitive equipment.

Face color-coding by voltage facilitates locating and mating of proper devices.



125V AC



250V AC



480V AC



125/250V AC



Housing Design

- Impact-resistant nylon face
- Boss diameter is 1.56 in. (39.6) on 20 and 30A devices, simplifying installation
- Glass-filled thermoplastic polyester base is heat and impact resistant, providing dimensional stability and strength



Terminals

- Back and side wiring capability provides easy installation with stranded or solid wire



Mounting Strap

- All-brass mounting and grounding system provides a low resistance ground path
- Automatic self-grounding clip assures ground continuity between mounting strap and metal wall box



Contacts

- Insulation barrier construction first patented by Hubbell isolates ground contact from the mounting strap
- Wire restraint recess for both back and side wiring reduces terminal loosening
- One-piece contact with long spring arm (low stress) and oxide cutting nibs; prevents stress and overheating

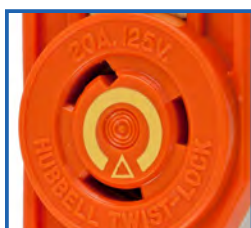

Identification

- Color-coding by voltage rating helps ensure mating of proper devices
- Amperage and voltage clearly indicated

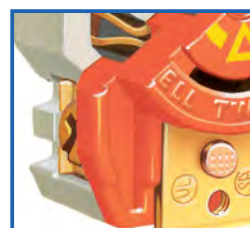

Wiring

- #10 silicon bronze terminal screw provides excellent strength and resistance to corrosion and stripping
- External back wiring allows visual inspection of terminations

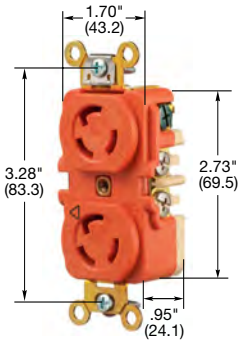

IG4700A

15A, 125V and 250V Back and Side Wired



15A 125V
NEMA L5-15R
UL/CSA



15A 250V
NEMA L6-15R
UL/CSA

Description	Poles/Wires	Color	Catalog Number	Catalog Number
Flush, RTP face, duplex.	2 pole, 3 wire	Orange	IG4700A*	IG4550A*
Flush, RTP face, single.	2 pole, 3 wire	Orange	IG4710	IG4560

*Note: RTP is an abbreviation for reinforced thermoplastic polyester.
Supplied with break-off tabs for split circuit wiring.



20A 125V
NEMA L5-20R
UL/CSA
1 HP



20A 250V
NEMA L6-20R
UL/CSA
2 HP



20A 480V AC
NEMA L8-20R
UL/CSA
3 HP

20A, 125V, 250V and 480V AC Back and Side Wired

Description	Poles/Wires	Color	Catalog Number	Catalog Number	Catalog Number
Flush, nylon face, single.	2 pole, 3 wire	Orange	IG2310	IG2320	IG2340

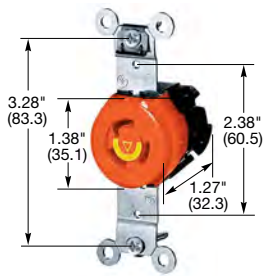

IG4710

30A, 125V and 250V Back and Side Wired



30A 125V
NEMA L5-30R
UL/CSA
2 HP



30A 250V
NEMA L6-30R
UL/CSA
2 HP

Description	Poles/Wires	Color	Catalog Number	Catalog Number
Flush, nylon face, single.	2 pole, 3 wire	Orange	IG2610	IG2620



20A 125/250V AC
NEMA L14-20R
UL/CSA
2 (1) HP



20A 3Ø 250V AC
NEMA L15-20R
UL/CSA
3 HP

20A, 125V/250V and 3Ø 250V AC Back and Side Wired

Description	Poles/Wires	Color	Catalog Number	Catalog Number
Flush, nylon face, single.	3 pole, 4 wire	Orange	IG2410	IG2420



30A 125/250V AC
NEMA L14-30R
UL/CSA
2 (2) HP



30A 3Ø 250V AC
NEMA L15-30R
UL/CSA
3 HP

30A, 125V/250V and 3Ø 250V AC Back and Side Wired

Description	Poles/Wires	Color	Catalog Number	Catalog Number
Flush, nylon face, single.	3 pole, 4 wire	Orange	IG2710	IG2720



20A 3ØY
120/208V AC
NEMA L21-20R
UL/CSA
2 HP



30A 3ØY
120/208V AC
NEMA L21-30R
UL/CSA
3 HP

20A and 30A, 3ØY 120/208V AC Back and Side Wired

Description	Poles/Wires	Color	Catalog Number	Catalog Number
Flush, nylon face, single.	4 pole, 5 wire	Orange	IG2510	IG2810

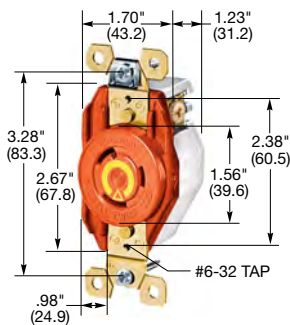

IG2310

Dimensions in Inches (mm)

SpikeShield® Power Quality Products

Specifications

Surge Protection Receptacles

	Part	Duplex	4-PLEX®
Typical Specification		HBL5262SA/HBL5362SA SNAP5262S/SNAP5362S	HBL4AP
Type-2 Pole, 3 Wire, Grounding	Receptacle	15A/20A	15A/20A
	Top & Base	Nylon	Lexan®
	Power Contact	.031" (.8) Brass	.032" (.8) Brass
	Contact Design	Tandem Modified Bypass	Triple Wipe
Rating-15A, 125V AC/20A, 125V AC	Mounting Strap	.050" (1.3) Steel-Zinc Coated	-
Certification-UL Listed File E2186	Clamping Plate	.031" (.8) Brass	.031" (.8) Brass-Line Terminal Plate
Listed to UL Standards 498 Receptacles			.031" (.8) Brass-Neutral Terminal Plate
Meets UL1449 4th edition	Terminal Screws	Brass #8-32 (HBL only)	Brass #8-32
	Grounding Screw	Steel (Green) (HBL only)	Brass (Green)
CSA Certified to Specification C22.2 No. 42	Auto Grd. Clip	Stainless Steel	.050" (1.3) Ground Plate
ANSI/IEEE C62.41 (IEEE 587)	Mounting Screws	Steel-Zinc Plated	Brass
Installation Categories "A" (Ring Wave)	LED	Green	Green
"B" (Unidirectional Impulse)	Alarm Muting Screw	Nylon	-
Performance			
Electrical		Duplex/SNAPConnect®	4-PLEX®
Frequency		60Hz	60Hz
Voltage		120V AC + 10%–15%	20V AC + 10%–15%
Response Time		Approximately 5 ns	Approximately 5 ns
Protection Modes		Normal & Common Modes	Normal & Common Modes
Transient Suppression		Peak Energy (10 X 100 µs) Peak Current (8 X 20 µs)	Peak Energy (10 X 100 µs) Peak Current (8 X 20 µs)
Normal Mode (L-N)		240 joules 15000A	80 joules 6500A
Common Mode (L-G), (N-G)		240 joules 15000A	80 joules 6500A
UL Voltage Protection Rating		600 L-N, 600 L-G, 1000 N-G	600 L-N, 600 L-G, 900 N-G
EMI/RFI Attenuation at 50 Ohms Normal Mode		-40 dB	
Operating Temperature		32°F to 140°F (0°C to 60°C)	-40°F to 140°F (-40°C to 60°C)
Flammability		UL 94V-2	UL 94V-2

SpikeShield® Power Quality Products

Specifications

320kA, 160kA and 120kA Service/Branch Panel Protection (Type 1 SPD)

Electrical Specifications

320kA Panel	160kA Panel	SCCR [◇]	I _n	MCOV †	Voltage Protection Rating (VPR)							
					L-N		L-G		N-G		L-L	
					320kA	160kA	320kA	160kA	320kA	160kA	320kA	160kA
HBL3P320B	HBL3P160B	200kA	20kA	320/160	900	700	900	700	800	600	1500	1000
HBL4P320B	HBL4P160B	200kA	20kA	320/160	900	700	900	700	800	600	1500	1000
HBL5P320B	HBL5P160B	200kA	20kA	320/160	N/A	N/A	1500	1200	N/A	N/A	2000	1500
HBL6P320B	HBL6P160B	200kA	20kA	320/160	1000/1200	900/1500	900/1200	900/1200	800	700	1500	1500
HBL8P320B	HBL8P160B	200kA	20kA	320/160	1500	1200	1500	1200	1200	1200	2000	2500
HBL9P320B	HBL9P160B	200kA	20kA	320/160	N/A	N/A	1800	1800	N/A	N/A	2500	2500
HBL10P320B	HBL10P160B	200kA	20kA	320/160	1500	1500	1500	1500	1500	1500	2500	2500
HBL11P320B	HBL11P160B	200kA	20kA	320/160	N/A	N/A	3000	2500	N/A	N/A	2500	2500

Note: Specification applies to both (B) and (DB) series.

Product Specifications

Max. Surge Current per Phase:	320kA and 160kA	Terminal Accommodation:	#10 AWG to #2 AWG
Max. Operating Temperature:	-20°F to 149°F (-4°C to 65°C)	Operating Frequency:	50/60 Hz
Diagnostics Indicators:	Push to Test Diagnostics, Red and Green Status LEDs, Dry Contacts, Audible Alarm and Surge Counter	EMI/RFI:	Up to -30dB
		Housing Rating:	NEMA 1
		Listing:	cULus UL1449 4th edition type 1 SPD, UL1283 5th edition, CSA C22.2 No. 269.2-13 1st edition, CSA 22.2, No. 8-13, 5th edition.
Dimensions:	11.04"W x 22.44"H x 7.87"D (320kA); 11.04"W x 20.32"H x 5.32"D (160kA)		
Weight:	37 lbs. Max. (320kA); 27 lbs. Max. (160kA)		

Wired-In Branch Panel Protection 100,000 Peak Amp Capacity (Type 2 SPD)

Electrical Specifications

Catalog Number	SCCR [◇]	I _n	MCOV †	Voltage Protection Rating (VPR)			
				L-N	L-G	N-G	L-L
HBL3W100C	200kA	20kA	150/270	900	1200	700	1500
HBL4W100C	200kA	20kA	150/270	900	1200	700	1500
HBL5W100C	200kA	20kA	300	N/A	N/A	N/A	1500
HBL6W100C	200kA	20kA	275/150	1000	1200	700	1500
HBL8W100C	200kA	20kA	320/640	1200	2000	1000	2500
HBL9W100C	200kA	20kA	640	N/A	N/A	N/A	3000
HBL10W100C	200kA	20kA	390/780	1500	2500	1500	3000
HBL11W100C	200kA	20kA	780	N/A	N/A	N/A	3000

Product Specifications

Max. Surge Current per Phase:	100kA	Terminal Accommodation:	#10 AWG 18.0" Wire Leads
Max. Operating Temperature:	-40°F to 140°F (-4°C to 60°C)	Operating Frequency:	50/60 Hz
Diagnostics Indicators:	Green Status LEDs, Dry Contacts, Audible Alarm	EMI/RFI:	Up to -30dB
		Housing Rating:	Type 4X
Dimensions:	9.9"W x 4.8"H x 3.1"D	Listing:	cULus UL 1449 4th edition type 2 SPD, UL1283 (Wye prod. only), CSA C22.2 NO. 8-M1986
Weight:	4.78 lbs	Warranty:	10 year

Wired-In High-Quality Surge Protective Device, Surge Arrestors, Single Phase and Three Phase (Type 2 SPD)

Electrical Specifications

Catalog Number	SCCR [◇]	I _n	MCOV †	Voltage Protection Rating (VPR)			
				L-N	L-G	N-G	L-L
HBL3W50	25kA	10kA	150 (L-N, L-G), 300 (L-L)	700	800	N/A	1200
HBLSDSA36	22kA	10kA	150	700	N/A	N/A	1200
HBL4SA40	200kA	10kA	180 (L-N), 360 (L-L)	700	N/A	N/A	1200
HBL5SA40	200kA	10kA	360 (L-L)	N/A	N/A	N/A	1200
HBL8SA40	200kA	10kA	420 (L-N), 840 (L-L)	1500	N/A	N/A	2500
HBL9SA40	200kA	10kA	840 (L-L)	N/A	N/A	N/A	2500
HBL10SA40	200kA	10kA	510 (L-N), 1020 (L-L)	1800	N/A	N/A	3000
HBL11SA40	200kA	10kA	1020 (L-L)	N/A	N/A	N/A	3000

Product Specifications

Service Voltage	Single Phase	Single Phase	Three Phase
Max. Surge Current per Phase:	50kA	36kA	40kA
Max. Operating Temperature:	-40°F to 149°F (-40°C to 65°C)	-40°F to 149°F (-40°C to 65°C)	-40°F to 149°F (-40°C to 65°C)
Diagnostics Indicators:	Green Status LED per line	Green Status LED per line	Green Status LED per line
Dimensions:	3.0"W x 3.6"H x 2.67"D	2.25"W x 2.25"H x 1.94"D	3.60"W x 3.0"H x 2.64"D
Weight:	1.8 lbs.	.72 lbs.	1.8 lbs.
Terminal Accommodation:	#12 AWG Wire Leads	#14 AWG Wire Leads	#12 AWG Wire Leads
Frequency:	50/60 Hz	50/60 Hz	50/60 Hz
EMI/RFI:	Up to -30dB	Up to -30dB	Up to -30dB
Housing Rating:	Type 4X	Type 4X	Type 4X
Listing:	UL1449 4th edition	UL1449 4th edition	UL1449 4th edition
Warranty:	10 year	2 year	2 year

◇SCCR: Short Circuit Current Rating | † MCOV: Maximum Continuous Operating Voltage | ‡ I_n: Nominal discharge current

SECTION N

Table of Contents



Thermoplastic Wallplates

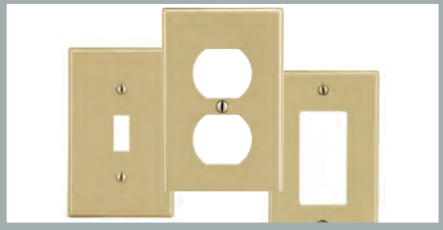

Snap-On Wallplates



While-In-Use Weatherproof Covers



Product	Page
Features and Benefits	N-2
Snap-On Wallplates	N-4
Toggle Switch Wallplates	N-5
Duplex and Single Receptacle Wallplates	N-6
Single Receptacle Wallplates	N-7
Blank Wallplates	N-8
Decorator Wallplates	N-9
Combination Wallplates, 2-Gang	N-10
Combination Wallplates, 3-Gang	N-11
Combination Wallplates, 4-Gang	N-12
Wallplate Specifications	N-12
Telephone and Coaxial Wallplates	N-13
Jumbo, Metal Wallplates	N-14
Pre-Marked "EMERGENCY" and "ISOLATED GROUND" Wallplates	N-15
Barrel Key Switch Wallplates	N-16
Security Wallplates	N-17

Product	Page
Accessories and Selection Charts	N-18
Weatherproof Covers for Flanged Devices	N-19
Weatherproof Covers for Receptacles	N-20
Weatherproof Covers for Receptacles and Switches	N-21
Weatherproof Switch Plates, Covers and Locking Covers	N-22
Heavy Duty Weatherproof Covers	N-23
Metallic EXTRA DUTY® While-In-Use Covers	N-24
Non-Metallic While-In-Use Covers	N-25
Weatherproof Non-Metallic Recessed While-In-Use Extra Duty Covers & Cast Aluminum Lockable Cover	N-26
Stainless Steel Weatherproof Flip Covers	N-27
Weatherproof Covers	N-28
Screws and Accessories	N-29
Wallplate Dimensions	N-30
Custom Metal Wallplates	N-31
Configuration Chart	N-32

Wallplates and Covers

Features and Benefits

Non-metallic Wallplates

Hubbell's line of polycarbonate wallplates features larger standard sized wallplates to provide extra coverage to hide rough box opening, improved aesthetics, greater strength, impact resistance, along with easy to clean finish in all different types of environments.

- Standard size is $\frac{1}{8}$ inch larger to give you extra coverage to hide rough box openings. Also available in mid-size, jumbo and pre-marked
- Smooth satin finish, blends into the wall
- More rigid, sharper lines
- Captive screw feature holds mounting screw in place for quick and easy installation, single gang
- High-impact polycarbonate thermoplastic is virtually unbreakable
- Smooth, easy to clean finish is highly resistant to solvents and cleaning solutions, providing long life in the harshest environments
- cULus listed

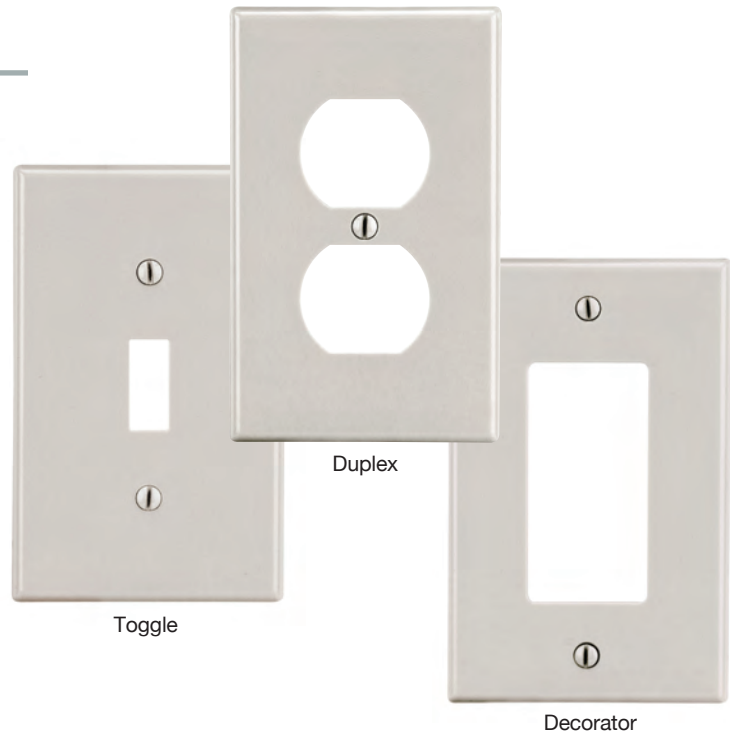

Hubbell's standard sized wallplates are $\frac{1}{8}$ inch larger to provide you that extra coverage to hide rough box openings. The depth is $\frac{1}{4}$ inch so that it will comfortably fit over the device even on imperfect installations or on retrofit work. See page N-32 for details and dimensions.

Non-metallic Wallplates



Non-metallic Pre-Marked Wallplates

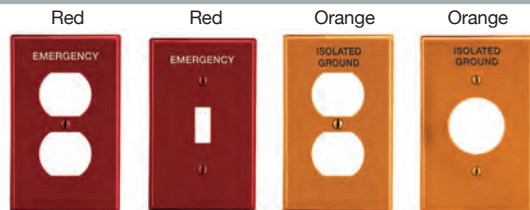

Metal Wallplates

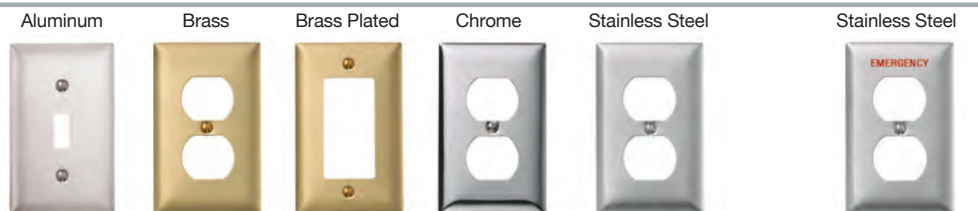

Wallplates and Covers

Features and Benefits

Stainless Steel Wallplates

Provide solutions for a variety of industrial and commercial applications.

302/304 Type Stainless Steel

Non-magnetic: 18.0% Chromium
8.0% Nickel

- Ideal for highly corrosive environments such as hospitals, food processing, static free requirements and more
- Environments subjected to heavy abuse

430 Type Stainless Steel

Magnetic: 17.0% Chromium
Less than 0.5% Nickel

- Aesthetically identical to the 302/304 type stainless steel wallplates and are best suited for environments where corrosion resistance is less critical
- Standard commercial use

Smooth Solid Brass

- Provides a plush appearance with the durability of metal
- Finish is lacquer coated to inhibit oxidation

Anodized Aluminum

- Non-magnetic and corrosion resistance for a wide range of applications
- Finish is lacquer coated to inhibit oxidation

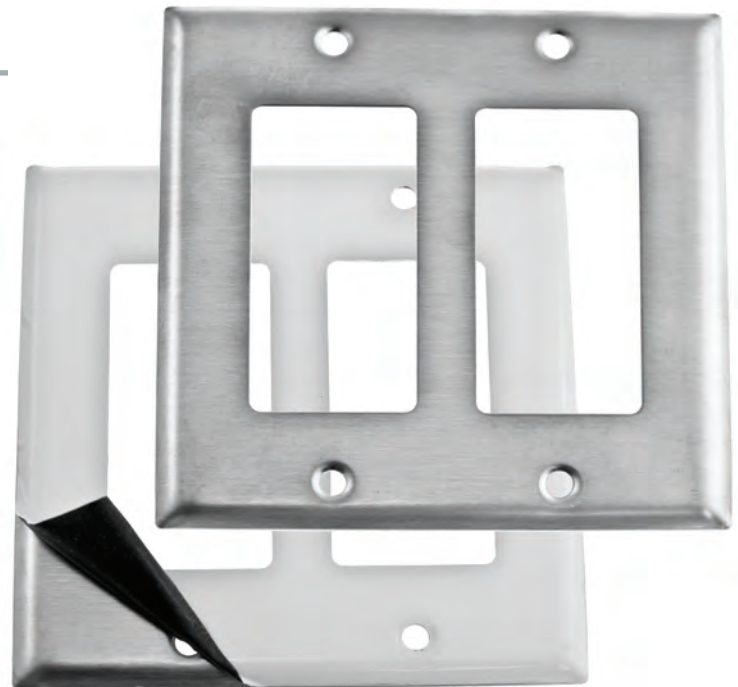

Decorator
(Protective plastic film helps to prevent scratches and damage)



Extra-Duty Metallic While-in-Use Covers

These covers are designed for use whenever protection is required while an outlet is in use. Covers meet or exceed the extra-duty rating per UL 514D, and are NEMA 3R rated.

- Die-cast aluminum construction
- Powder coated “chip resistant” paint corrosion protection
- Unique plug management provision for securing device and cord

2023 National Electrical Code (NEC®) Requirement

406.9 Receptacles in Damp or Wet Locations.

406.9 Receptacles in Damp or Wet Locations.

(B) Wet Locations

(1) Receptacles of 15 and 20 Amperes in a Wet Location.

Receptacles of 15 and 20 amperes, 125 and 250 volts installed in a wet location shall have an enclosure that is weatherproof whether or not the attachment plug cap is inserted. An outlet box hood installed for this purpose shall be identified as “extra-duty.” Other listed products, enclosures, or assemblies providing weatherproof protection that do not utilize an outlet box hood need not be marked “extra-duty.”

All 15- and 20-ampere, 125- and 250-volt nonlocking-type receptacles shall be listed and so identified as weather-resistant type.

(2) Other Receptacles. All other receptacles installed in a wet location shall comply with 406.9(B)(2)(a) or (B)(2)(b).

(a) A receptacle installed in a wet location, where the product intended to be plugged into it is not attended while in use, shall have an enclosure that is weatherproof with the attachment plug cap inserted or removed.

(b) A receptacle installed in a wet location where the product intended to be plugged into it will be attended while in use (e.g., portable tools) shall have an enclosure that is weatherproof when the attachment plug is removed.





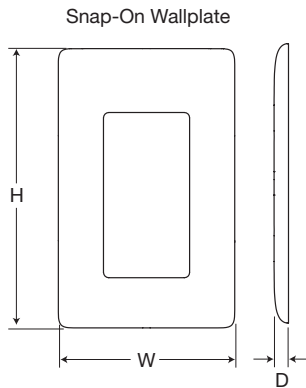



Snap-On Screwless Wallplates

- Clean, elegant look
- No visible screws
- Snap-on wallplate completely covers sub-plate eliminating dirt build-up around the edges
- Snap-on wallplate hides any paint or scratches on sub-plate caused during installation
- Appearance is consistent with other Hubbell wallplates
- Meets UL and CSA standards





Gang	Height (H)	Width (W)	Depth (D)
1	4.75" (120.6)	3.00" (76.2)	.25" (6.35)
2	4.75" (120.6)	4.81" (122.2)	.25" (6.35)
3	4.75" (120.6)	6.62" (168.2)	.25" (6.35)
4	4.75" (120.6)	8.44" (214.3)	.25" (6.35)

Snap-On Screwless Wallplates

Description		Color	Decorator Catalog Number	Toggle Catalog Number
1-Gang, 1-Decorator 	1-Gang, 1-Toggle 	Ivory Light Almond White	NPS261 NPS26LA NPS26W	NPS11 NPS1LA NPS1W
2-Gang, 2-Decorator 	2-Gang, 2-Toggle 	Ivory Light Almond White	NPS2621 NPS262LA NPS262W	NPS21 NPS2LA NPS2W
3-Gang, 3-Decorator 	3-Gang, 3-Toggle 	Ivory Light Almond White	NPS2631 NPS263LA NPS263W	NPS31 NPS3LA NPS3W
4-Gang, 4-Decorator 		Ivory Light Almond White	NPS2641 NPS264LA NPS264W	— — —
1-Gang, 1-Duplex 		Ivory Light Almond White	NPS81 NPS8LA NPS8W	— — —

Dimensions in Inches (mm)









GFCI, USB, Surge Receptacles and Style Line® Device Wallplates

Description	Color	Thermoplastic			Material	Metal Catalog Number
		Standard	Mid-Size	Jumbo		
1-Gang, 1-Decorator 	Black Blue Brown Gray Ivory Light Almond Red White	P26BK – P26 P26GY P26I P26LA P26R P26W	PJ26BK PJ26BL PJ26 PJ26GY PJ26I PJ26LA PJ26R PJ26W	– – – – NPJJ26I NPJJ26LA – NPJJ26W	Aluminum Brass Brass Plated Chrome S/S 302/304 S/S 430	① SB26 SBP26 SCH26 SS26 SS26L
2-Gang, 2-Decorator 	Black Brown Gray Ivory Light Almond Red White	P262BK P262 P262GY P262I P262LA P262R P262W	PJ262BK PJ262 PJ262GY PJ262I PJ262LA PJ262R PJ262W	– – – – – – –	Aluminum Brass Brass Plated Chrome S/S 302/304 S/S 430	① SB262 SBP262 SCH262 SS262 SS262L
3-Gang, 3-Decorator 	Black Brown Gray Ivory Light Almond Red White	P263BK P263 P263GY P263I P263LA P263R P263W	PJ263BK PJ263 PJ263GY PJ263I PJ263LA – PJ263W	– – – – – – –	Aluminum Brass Brass Plated Chrome S/S 302/304	① ① SBP263 ① SS263
4-Gang, 4-Decorator 	Black Brown Gray Ivory Light Almond White	P264BK P264 P264GY P264I P264LA P264W	– – – PJ264I PJ264LA PJ264W	– – – – – –	Aluminum Brass Brass Plated Chrome S/S 302/304	① ① ① ① SS264
5-Gang, 5-Decorator 	Gray Ivory Light Almond White	P265GY P265I P265LA P265W	– – – –	– – – –	Aluminum Brass Brass Plated Chrome S/S 302/304	① ① ① ① SS265
6-Gang, 6-Decorator 	Black Brown Gray Ivory Light Almond White	P266BK P266 P266GY P266I P266LA P266W	– – – – – –	– – – – – –	Aluminum Brass Brass Plated Chrome S/S 302/304	① ① ① ① SS266

Note: Thermoplastic wallplates feature pre-inserted captive screws for faster assembly in single gang configurations.
 ① Available as a custom wallplate, see pages N-32 to N-34. Consult custom wallplates section for additional openings and combinations.

Dimensions in Inches (mm)

Toggle Switch Wallplates





Description	Color	Thermoplastic			Material	Metal Catalog Number
		Standard	Mid-Size	Jumbo		
1-Gang, 1-Toggle 	Black Brown Gray Ivory Light Almond Red White	P1BK P1 P1GY P1I P1LA P1R P1W	PJ1BK PJ1 PJ1GY PJ1I PJ1LA PJ1R PJ1W	– – – NPJJ1I NPJJ1LA – NPJJ1W	Aluminum Brass Brass Plated Chrome S/S 302/304 S/S 430	SA1 SB1 SBP1 SCH1 SS1 SS1L
2-Gang, 2-Toggle 	Black Brown Gray Ivory Light Almond Red White	P2BK P2 P2GY P2I P2LA P2R P2W	– PJ2 PJ2GY PJ2I PJ2LA – PJ2W	– – – NPJJ2I NPJJ2LA – NPJJ2W	Aluminum Brass Brass Plated Chrome S/S 302/304 S/S 430	SA2 SB2 SBP2 SCH2 SS2 SS2L
3-Gang, 3-Toggle 	Black Brown Gray Ivory Light Almond Red White	P3BK P3 P3GY P3I P3LA – P3W	– – PJ3GY PJ3I PJ3LA – PJ3W	– – – – – – –	Aluminum Brass Brass Plated Chrome S/S 302/304 S/S 430	① SB3 – SCH3 SS3 SS3L
4-Gang, 4-Toggle 	Black Brown Gray Ivory Light Almond White	P4BK P4 P4GY P4I P4LA P4W	– – – PJ4I PJ4LA PJ4W	– – – – – –	Aluminum Brass Brass Plated Chrome S/S 302/304 S/S 430	① SB4 – ① SS4 –
5-Gang, 5-Toggle 	Gray Ivory Light Almond White	P5GY P5I P5LA P5W	– – – –	– – – –	Aluminum Brass Brass Plated Chrome S/S 302/304 S/S 430	① SB5 ① ① SS5 –
6-Gang, 6-Toggle 	Gray Ivory Light Almond White	P6GY P6I P6LA P6W	– – – –	– – – –	Aluminum Brass Brass Plated Chrome S/S 302/304 S/S 430	① SB6 ① ① SS6 –
7-Gang, 7-Toggle 					Aluminum Brass Brass Plated Chrome S/S 302/304	① ① ① ① SS607
8-Gang, 8-Toggle 					Aluminum Brass Brass Plated Chrome S/S 302/304	① ① ① ① SS608
2-Gang, 1-Toggle 					Aluminum Brass Brass Plated Chrome S/S 302/304	– – – – SS740

Note: Thermoplastic wallplates feature pre-inserted captive screws for faster assembly in single gang configurations.

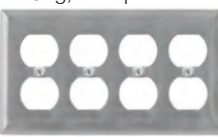

① Available as a custom wallplate, see pages N-32 to N-34. Consult custom wallplates section for additional openings and combinations.

Dimensions in Inches (mm)

Duplex Receptacle Wallplates

Description	Color	Thermoplastic			Material	Metal Catalog Number
		Standard	Mid-Size	Jumbo		
1-Gang, 1-Duplex 	Black	P8BK	PJ8BK	–	Aluminum Brass Brass Plated Chrome S/S 302/304 S/S 430	SA8
	Blue	–	PJ8BL	–		SB8
	Brown	P8	PJ8	–		SBP8
	Gray	P8GY	PJ8GY	–		SCH8
	Ivory	P8I	PJ8I	NPJJ8I		SS8
	Light Almond	P8LA	PJ8LA	NPJJ8LA		SS8L
	Orange	P8OR	–	–		
	Red	P8R	PJ8R	–		
	White	P8W	PJ8W	NPJJ8W		
2-Gang, 2-Duplex 	Black	P82BK	PJ82BK	–	Aluminum Brass Brass Plated Chrome S/S 302/304 S/S 430	SA82
	Brown	P82	–	–		SB82
	Gray	P82GY	PJ82GY	–		SBP82
	Ivory	P82I	PJ82I	–		SCH82
	Light Almond	P82LA	PJ82LA	–		SS82
	Orange	P82OR	–	–		SS82L
	Red	P82R	PJ82R	–		
	White	P82W	PJ82W	–		
	3-Gang, 3-Duplex 	Ivory	P83I	–		–
White		P83W	–	–	SS83 –	
4-Gang, 4-Duplex 					Aluminum Brass Brass Plated Chrome S/S 302/304 S/S 430	⓪ ⓪ ⓪ ⓪ SS84 –
2-Gang, 1-Duplex 					Brass Brass Plated Chrome S/S 302/304 S/S 430	– – – SS748 –





Single 15/20A Straight Blade or 15A Twist-Lock® Receptacle Wallplates

Description	Color	Thermoplastic			Material	Metal Catalog Number
		Standard	Mid-Size	Jumbo		
1-Gang, 1-Single 1.40 in. (35.6) Dia. Hole 	Black	P7BK	–	–	Aluminum Brass Brass Plated Chrome S/S 302/304 S/S 430	SA7
	Brown	P7	–	–		SB7
	Gray	P7GY	–	–		SBP7
	Ivory	P7I	PJ7I	–		SCH7
	Light Almond	P7LA	PJ7LA	–		SS7
	Red	P7R	–	–		SS7L
	White	P7W	PJ7W	–		
2-Gang, 1-Single 1.40 in. (35.6) Dia. Hole 					Aluminum Brass Brass Plated Chrome S/S 302/304 S/S 430	– – – – SS747 –
2-Gang, 2-Single 1.40 in. (35.6) Dia. Hole 					Aluminum Brass Brass Plated Chrome S/S 302/304 S/S 430	⓪ ⓪ ⓪ ⓪ SS72 –







Note: Thermoplastic wallplates feature pre-inserted captive screws for faster assembly in single gang configurations.
 ⓪ Available as a custom wallplate, see pages N-32 to N-34. Consult custom wallplates section for additional openings and combinations.

Dimensions in Inches (mm)

Single 20/30A Twist-Lock® Receptacle Wallplates

Description	Color	Thermoplastic		Material	Metal Catalog Number
		Standard	Mid-Size		
 1-Gang, 1-Single, 1.60 in. (40.6) Dia. Hole	Black	P720BK	-	Aluminum	SA720
	Brown	P720	-	Brass	SB720
	Gray	P720GY	-	Brass Plated	①
	Ivory	P720I	-	Chrome	①
	Red	P720R	-	S/S 302/304	SS720
	White	P720W	-		
 1-Gang, 1-Single, 1.74 in. (44.2) Dia. Hole				Aluminum	-
				Brass	-
				Brass Plated	-
				Chrome	-
				S/S 302/304	SS725
 2-Gang, 1-Single, 1.60 in. (40.6) Dia. Hole				Aluminum	-
				Brass	-
				Brass Plated	-
				Chrome	-
				S/S 302/304	SS749
 3-Gang, 2-Single, 1.60 in. (40.6) Dia. Hole				Aluminum	①
				Brass	①
				Brass Plated	①
				Chrome	①
				S/S 302/304	SS320

Single Receptacle Wallplates





Description	Color	Thermoplastic		Material	Metal Catalog Number
		Standard	Mid-Size		
 1-Gang, 1-Single, 1.97 in. (50.0) Dia. Hole				Aluminum	-
				Brass	-
				Chrome	-
				S/S 302/304	SS737
 1-Gang, 1-Single, 2.16 in. (54.9) Dia. Hole	Black	P724BK	PJ724BK	Aluminum	-
	Ivory	P724I	PJ724I	Brass	①
	White	P724W	PJ724W	Brass Plated	①
				Chrome	SCH723
				S/S 302/304	SS723
 2-Gang, 1-Single, 2.16 in. (54.9) Dia. Hole				Aluminum	-
				Brass	-
				Chrome	-
				S/S 302/304	SS702
 2-Gang, 1-Single, 2.16 in. (54.9) Dia. Hole	Black	P703BK	PJ703BK	Aluminum	-
	Ivory	P703I	PJ703I	Brass	-
	White	P703W	PJ703W	Brass Plated	-
				Chrome	-
				S/S 302/304 S/S 430	SS703 SS703L
 2-Gang, 1-Single, 2.48 in. (63.0) Dia. Hole				Aluminum	-
				Brass	-
				Chrome	-
				S/S 302/304	SS701
 2-Gang, 1-Single, 2.66 in. (67.6) Dia. Hole				Aluminum	-
				Brass	-
				Chrome	-
				S/S 302/304	SS716

Note: Thermoplastic wallplates feature pre-inserted captive screws for faster assembly in single gang configurations.



① Available as a custom wallplate, see pages N-32 to N-34. Consult custom wallplates section for additional openings and combinations.

Dimensions in Inches (mm)

Blank Wallplates, Box Mount

Description	Color	Thermoplastic			Material	Metal Catalog Number
		Standard	Mid-Size	Jumbo		
1-Gang, 1-Blank, Box Mount 	Black	P13BK	PJ13BK	–	Aluminum	SA13A
	Brown	P13	PJ13	–	Brass	SB13
	Gray	P13GY	PJ13GY	–	Brass Plated	–
	Ivory	P13I	PJ13I	NPJJ13I	Chrome	SCH13
	Light Almond	P13LA	PJ13LA	NPJJ13LA	S/S 302/304	SS13
	White	P13W	PJ13W	NPJJ13W	S/S 430	SS13L
2-Gang, 2-Blank, Box Mount 	Black	P23BK	–	–	Aluminum	SA23
	Brown	P23	PJ23	–	Brass	SB23
	Gray	P23GY	–	–	Brass Plated	①
	Ivory	P23I	PJ23I	–	Chrome	SCH23
	Light Almond	P23LA	PJ23LA	–	S/S 302/304	SS23
	White	P23W	PJ23W	–	S/S 430	SS23L
3-Gang, 3-Blank, Box Mount 	Ivory	P33I	–	–	Aluminum	①
	White	P33W	–	–	Brass	①
4-Gang, 4-Blank, Box Mount 	Ivory	P43I	–	–	Brass Plated	①
	White	P43W	–	–	Chrome	①
					S/S 302/304	SS33
					Aluminum	①
					Brass	①
					Brass Plated	①
				Chrome	①	
				S/S 302/304	SS43	

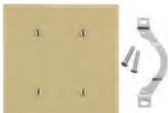
Blank Wallplates, Strap Mount









Description	Color	Thermoplastic			Material	Metal Catalog Number
		Standard	Mid-Size	Jumbo		
1-Gang, 1-Blank, Strap Mount 	Black	P14BK	–	–	Aluminum	①
	Brown	P14	–	–	Brass	SB14
	Gray	P14GY	–	–	Brass Plated	①
	Ivory	P14I	–	–	Chrome	①
	Light Almond	P14LA	–	–	S/S 302/304	SS14
	Red	P14R	–	–		
	White	P14W	–	–		
2-Gang, 2-Blank, Strap Mount 	Black	P24BK	–	–	Aluminum	①
	Brown	P24	–	–	Brass	①
	Gray	P24GY	–	–	Brass Plated	①
	Ivory	P24I	–	–	Chrome	①
	Light Almond	P24LA	–	–	S/S 302/304	SS24
	Red	P24R	–	–		
	White	P24W	–	–		
3-Gang, 3-Blank, Strap Mount 					Aluminum	①
					Brass	①
					Brass Plated	①
					Chrome	①
					S/S 302/304	SS34

Note: Thermoplastic wallplates feature pre-inserted captive screws for faster assembly in single gang configurations.

① Available as a custom wallplate, see pages N-32 to N-34. Consult custom wallplates section for additional openings and combinations.

Dimensions in Inches (mm)

Combination Wallplates, 2-Gang

Description	Color	Thermoplastic		Material	Metal Catalog Number
		Standard	Mid-Size		
2-Gang, 1-Toggle, 1-Duplex 	Brown Gray Ivory Light Almond White	P18 P18GY P18I P18LA P18W	– PJ18GY PJ18I PJ18LA PJ18W	Aluminum Brass Brass Plated Chrome S/S 302/304	① SB18 – SCH18 SS18
2-Gang, 1-Duplex, 1-Decorator 	Black Brown Gray Ivory Light Almond White	P826BK P826 P826GY P826I P826LA P826W	PJ826BK PJ826 PJ826GY PJ826I PJ826LA PJ826W	Aluminum Brass Brass Plated Chrome S/S 302/304	① SB826 ① ① ① SS826
2-Gang, 1-Toggle, 1-Decorator 	Black Brown Gray Ivory Light Almond White	P126BK P126 P126GY P126I P126LA P126W	– PJ126 PJ126GY PJ126I PJ126LA PJ126W	Aluminum Brass Brass Plated Chrome S/S 302/304	① SB126 – ① SS126
2-Gang, 1-Single Receptacle 1.40 in. (35.6) Hole, 1-Duplex 	Ivory White	P78I P78W	– –	Aluminum Brass Brass Plated Chrome S/S 302/304	① ① ① ① SS78
2-Gang, 1-Single Receptacle 1.60 in. (40.6) Hole, 1-Duplex 				Aluminum Brass Brass Plated Chrome S/S 302/304	① ① ① ① SS8720
2-Gang, 1-Toggle, 1-Blank Box Mount 	Brown Gray Ivory Light Almond White	– P113GY P113I P113LA P113W	PJ113 – PJ113I – PJ113W	Aluminum Brass Brass Plated Chrome S/S 302/304	① ① ① ① SS113
2-Gang, 1-Toggle, 1-Blank Strap Mount 				Aluminum Brass Brass Plated Chrome S/S 302/304	① ① ① ① SS114
2-Gang, 1-Blank, 1-Decorator Box Mount 	Black Gray Ivory Light Almond White	P1326BK P1326GY P1326I P1326LA P1326W	– – PJ1326I PJ1326LA PJ1326W	Aluminum Brass Brass Plated Chrome S/S 302/304	① ① ① ① SS1426*



Note: Thermoplastic wallplates feature pre-inserted captive screws for faster assembly in single gang configurations.

① Available as a custom wallplate, see pages N-32 to N-34. Consult custom wallplates section for additional openings and combinations.



*Strap Mount.

Dimensions in Inches (mm)

Combination Wallplates, 2-Gang

Description	Color	Thermoplastic		Material	Metal Catalog Number
		Standard	Mid-Size		
2-Gang, 1-Blank, 1-Duplex Box Mount 	Gray	P138GY	—	Aluminum	①
	Ivory	P138I	—	Brass	①
	Light Almond	P138LA	—	Brass Plated	①
	White	P138W	—	Chrome	①
				S/S 302/304	SS138
2-Gang, 1-Blank, 1-Duplex Strap Mount 				Aluminum	①
				Brass	①
				Brass Plated	①
				Chrome	①
				S/S 302/304	SS148



Combination Wallplates, 3-Gang

Description	Color	Thermoplastic		Material	Metal Catalog Number
		Standard	Mid-Size		
3-Gang, 2-Toggle, 1-Duplex 	Brown	P28	—	Aluminum	①
	Gray	P28GY	—	Brass	①
	Ivory	P28I	PJ28I	Brass Plated	①
	Light Almond	P28LA	PJ28LA	Chrome	①
	White	P28W	PJ28W	S/S 302/304	①
3-Gang, 2-Toggle, 1-Decorator 	Black	P226BK	—	Aluminum	①
	Brown	P226	—	Brass	①
	Gray	P226GY	—	Brass Plated	①
	Ivory	P226I	PJ226I	Chrome	①
	Light Almond	P226LA	PJ226LA	S/S 302/304	SS226
	White	P226W	PJ226W		
3-Gang, 1-Toggle, 2-Decorator 	Ivory	P1262I	—	Aluminum	①
	Light Almond	P1262LA	—	Brass	①
	White	P1262W	—	Brass Plated	①
				Chrome	①
				S/S 302/304	①

Note: Thermoplastic wallplates feature pre-inserted captive screws for faster assembly in single gang configurations.
 ①Available as a custom wallplate, see pages N-32 to N-34. Consult custom wallplates section for additional openings and combinations.

Dimensions in Inches (mm)

Combination Wallplates, 4-Gang

Description	Color	Thermoplastic		Material	Metal Catalog Number
		Standard	Mid-Size		
4-Gang, 3-Toggle, 1-Decorator 	Black	P326BK	—	Aluminum	①
	Brown	P326	—	Brass	①
	Gray	P326GY	—	Brass Plated	①
	Ivory	P326I	—	Chrome	①
	Light Almond	P326LA	—	S/S 302/304	SS326
	White	P326W	—		
4-Gang, 2-Toggle, 2-Decorator 	Ivory	P2262I	—	Aluminum	①
	Light Almond	P2262LA	—	Brass	①
	White	P2262W	—	Brass Plated	①
				Chrome	①
			S/S 302/304	①	

Note: Thermoplastic wallplates feature pre-inserted captive screws for faster assembly in single gang configurations.

① Available as a custom wallplate, see pages N-32 to N-34. Consult custom wallplates section for additional openings and combinations.

Specifications

Listings	
Non-Metallic Wallplates	UL Standard 514D
Metallic Wallplates	UL Standard 514D
Certification	UL Files #E31999,E92074 CSA Standard C22.2 No. 42.1 CSA File 1733174

Product	Thickness	Mounting Screw(s)	Appearance
Thermoplastic Wallplate	.07 in. (1.8)	Steel (painted slotted screw head).	Smooth satin finish.
302/304 Stainless Steel Wallplate (18% Chromium, 8% Nickel)	.035 in. (0.9) nominal	302/304 stainless steel (18% chromium, 8% nickel). Slotted screw head.	Horizontal brushed finish.
430 Stainless Steel Wallplate (17% Chromium, less than 0.5% Nickel)	.035 in. (0.9) nominal	302/304 stainless steel (17% chromium, less than 0.5% nickel). Slotted screw head.	Horizontal brushed finish.
Brass Wallplate (70% Copper, 30% Zinc)	.04 in. (1.0)	Brass (70% Copper, 30% Zinc). Slotted screw head.	Horizontal brushed finish.
Aluminum Wallplate	.05 in. (1.3)	302/304 stainless steel (17% chromium, less than 0.5% nickel). Slotted screw head.	Horizontal brushed finish.
Brass Plated Steel Wallplate	.03 in. (0.8) nominal	Brass slotted head.	Polished, coated to inhibit oxidation.
Chrome Plated Steel Wallplate	.03 in. (0.8) nominal	302/304 stainless steel (17% chromium, less than 0.5% nickel). Slotted screw head.	Polished, coated to inhibit oxidation.
Steel Painted Wallplate	.03 in. (0.8) nominal	Steel (painted slotted screw head).	Powder coat paint.

Dimensions in Inches (mm)

Telephone and Coaxial Wallplates

Description	Color	Thermoplastic		Material	Metal Catalog Number
		Standard	Mid-Size		
1-Gang, 1-Tel Thermoplastic .406 in. (10.3) Hole, Metal .640 in. (16.3) Hole, Box Mount 	Ivory Light Almond White	P111 P11LA P11W	PJ111 PJ11LA PJ11W	Aluminum Brass Brass Plated Chrome S/S 302/304	① ① ① ① SS11*
1-Gang, 1-Tel Thermoplastic .406 in. (10.3) Hole, Metal .640 in. (16.3) Hole, Strap Mount 				Aluminum Brass Brass Plated Chrome S/S 302/304	① - - - SS12*
1-Gang, 1-Tel .625 in. (15.9) Hole, Box Mount 	Ivory White	P737I P737W	- -	Aluminum Brass Brass Plated Chrome S/S 302/304	- - - - -
1-Gang, 1-Tel .380 in. (9.7) Hole, Box Mount 				Aluminum Brass Brass Plated Chrome S/S 302/304	① ① ① ① SS739
1-Gang, 1-Tel .380 in. (9.7) Hole, Strap Mount 				Aluminum Brass Brass Plated Chrome S/S 302/304,	① ① ① ① SS738

Note: Thermoplastic wallplates feature pre-inserted captive screws for faster assembly in single gang configurations.
 ①Available as a custom wallplate, see pages N-32 to N-34. Consult custom wallplates section for additional openings and combinations.
 * .50" (12.7) I.D. nylon bushing provided.













Louver Wallplate, 1-Gang, Box Mount

Description	Color	Thermoplastic		Material	Metal Catalog Number
		Standard	Mid-Size		
1-Gang, Vertical Mounted Louver 				Aluminum Brass Brass Plated Chrome S/S 302/304 S/S 430	① - - ① SS771 -

Note: ①Available as a custom wallplate, see pages N-32 to N-34. Consult custom wallplates section for additional openings and combinations.

Dimensions in Inches (mm)

Jumbo, Smooth, Stainless Steel Type 302/304 Wallplates

Configuration	Catalog Number	Configuration	Catalog Number
1-Gang, 1-Toggle 	SSJ1	2-Gang, 2-Toggle 	SSJ2
1-Gang, 1-Duplex 	SSJ8	2-Gang, 2-Duplex 	SSJ82
1-Gang, 1-Decorator 	SSJ26	2-Gang, 2-Decorator 	SSJ262
1-Gang, 1-Single Receptacle for 1.36–1.39 in. (34.5–35.3) dia. face 	SSJ7	2-Gang, 1-Toggle, 1-Duplex 	SSJ18
1-Gang, 1-Single Receptacle for 2.09–2.13 in. (53.1–54.1) dia. face 	SSJ723	2-Gang, 1-Toggle, 1-Decorator 	SSJ126
1-Gang, 1-Blank, box mount 	SSJ13	2-Gang, 2-Blank, box mount 	SSJ23
1-Gang, 1-Telephone opening, 0.640 in. (16.3) box mount 	SSJ11*		

Note: *.50 in. (12.7) I.D. nylon bushing provided.
Specifications are subject to change without notice.

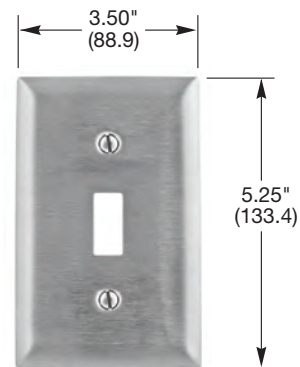

Oversize dimensions (see page N-32 for more details).
1-Gang, 5.25 in. x 3.50 in. (133.4 x 88.9).
2-Gang, 5.25 in. x 5.31 in. (133.4 x 134.9).



Jumbo Wallplate



Dimensions in Inches (mm)

Pre-Marked "EMERGENCY" Wallplates

Description	Color	Thermoplastic		Material	Metal Catalog Number
		Standard	Mid-Size		
1-Gang, 1-Duplex, paint filled white lettering 	Red	–	PJ8RMEV	Aluminum Brass Brass Plated Chrome S/S 302/304	– – – – SS8MEV
1-Gang, 1-Toggle, paint filled white lettering 	Red	–	PJ1RME	Aluminum Brass Brass Plated Chrome S/S 302/304	– – – – SS1ME
2-Gang, 2 Duplex, paint filled red lettering 				Aluminum Brass Brass Plated Chrome S/S 302/304	– – – – SS82MEV

Note: See page N-30 for Mid-Size wallplate dimensions.
All lettering .25 in. (6.3) high.

Pre-Marked "ISOLATED GROUND" Wallplates

Description	Color	Thermoplastic		Material	Metal Catalog Number
		Standard	Mid-Size		
1-Gang, 1-Duplex, paint filled black 	Orange	P8OIG	–	Aluminum Brass Brass Plated Chrome S/S 302/304 S/S 430	– – – – – –
1-Gang, 1-Single Receptacle 1.40 in. (35.6) Hole for 1.36–1.39 in. (34.5–35.3) Dia. face, paint filled black 	Orange	P7OIG	–	Aluminum Brass Brass Plated Chrome S/S 302/304 S/S 430	– – – – – –
1-Gang, 1-Single Receptacle 1.60 in. (40.6) Hole for 20 and 30A Twist-Lock® with 1.55–1.58 in. (39.4–40.1) Dia. face, paint filled black 	Orange	P720OIG	–	Aluminum Brass Brass Plated Chrome S/S 302/304 S/S 430	– – – – – –

Dimensions in Inches (mm)



Stainless Steel Barrel Key Switch Wallplates

Description	1-Gang, with on/off markings	1-Gang, with position markings	2-Gang, with on/off markings	2-Gang, with position markings
Stainless steel, 302/304, smooth.	SS12RKL	SS12RKLM	SS22RKL	SS22RKLM
				

Note: See page D-3 for barrel key switch selection.

Single Count Screws and Accessories

Description	Catalog Number
Stainless steel screw, standard slot, .38 in. (9.7) long.	HBL7341SS
Security spanner head screws, 6-32 thread, 100 count.	HBL7342RKL
Screwdriver with spanner head security bit.	HBL7372RKL



Dimensions in Inches (mm)

1-Gang Security Wallplates, White

Description	Catalog Number
1-Toggle switch	SWP1
1-Duplex receptacle	SWP8
1-GFCI/Style Line® opening	SWP26
1-Telephone or TV opening .640 in. (16.3)	SWP12
1-Blank	SWP13



SWP1



SWP8

2-Gang Security Wallplates, White

Description	Catalog Number
2-Toggle switches	SWP2
2-Duplex receptacles	SWP82
1-Toggle switch, 1-Duplex receptacle	SWP18
2-GFCI/Style Line® openings	SWP262
1-Toggle switch, 1-GFCI/Style Line® opening	SWP126
1-Duplex receptacle, 1-Telephone or TV	SWP812
1-Duplex receptacle, 1-Blank	SWP813
2-Blank	SWP23



SWP82



SWP18



SWP28

3-Gang Security Wallplates, White

Description	Catalog Number
3-Toggle switches	SWP3
2-Toggle switches, 1-Duplex receptacle	SWP28
3-GFCI/Style Line® openings	SWP263



SWP4

4-Gang Security Wallplates, White

Description	Catalog Number
4-Toggle switches	SWP4

Dimensions Inches (mm)

Description	A	B	C	D	E	F	G	H
1-Gang	3.77" (95.8)	5.52" (140.2)	.55" (14.0)	3.37" (85.6)	5.13" (130.3)	1.00" (25.4)	4.63" (117.6)	2.88" (73.2)
2-Gang	5.52" (140.2)	5.52" (140.2)	.55" (14.0)	5.13" (130.3)	5.13" (130.3)	1.00" (25.4)	4.63" (117.6)	4.63" (117.6)
3-Gang	7.39" (187.7)	5.52" (140.2)	.55" (14.0)	7.00" (177.8)	5.13" (130.3)	1.00" (25.4)	4.63" (117.6)	6.50" (165.1)
4-Gang	9.20" (233.7)	5.56" (141.2)	.55" (14.0)	8.75" (222.3)	5.13" (130.3)	1.00" (25.4)	4.63" (117.6)	8.30" (210.8)

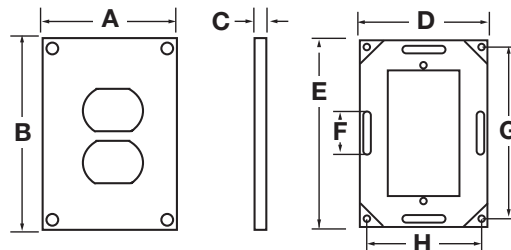

Specifications

Tamper-resistant wallplate 1-gang duplex receptacle shall be of the following construction:

Wallplate: One piece #14 cold rolled zinc plated steel. Wallplate shall have a five stage baked white polyester powder enamel finish. Gloss: 85%; reflectance: 93%; hardness minimum: 2H and pass 600 hour salt spray test.

Back sub-plate: #10 cold rolled galvanized steel. Sub-plate assembly shall use four (4) #8-32 X 1/2 inch stainless steel T-15 TORX® head screws with center pin reject. Sub-plate must be UL listed to UL 514D and comply with the NEC®.

TORX® is a registered trademark of Textron Inc.
NEC® is a registered trademark of the The National Electrical Code.

Dimensions in Inches (mm)

Brass Locking Cover Plate

Description	Catalog Number
Locking cover plate for single 15 and 20A straight blade receptacles and 15A Twist-Lock® receptacles. Straight cylinder type lock. All cylinder locks keyed alike.	HBL96067



HBL96067
Shown with receptacle
(sold separately)



HBL6187
Shown with receptacle
and back box
(sold separately)

Weather Shield Wallplate

Description	Catalog Number
20° angle wallplate for duplex receptacles.	HBL6187

Catalog Number of Receptacles in Groups A through E below

Group A		Group B			Group C		Group D		Group E
Boss diameter 1.36" to 1.39" (34.5 to 35.3)		Boss diameter 1.55" to 1.58" (39.4 to 40.1)			Boss diameter 1.68" to 1.72" (42.7 to 43.7)		Boss diameter 2.09" to 2.13" (53.1 to 54.1)		Boss diameter 2.28" to 2.44" (57.9 to 62.0)
HBL2300HG	HBL5661	HBL23CM10	HBL2530	HBL2770	HBL45105	HBL7962	HBL7301A		
HBL23030	HBL6810	HBL2310	HBL26CM10	HBL2810	HBL45205	HBL9350	HBL8330A		
HBL4560	HBL7210B	HBL2320	HBL2610	HBL2820	HBL45305	HBL9308	HBL8350A		
HBL4710	HBL7250	HBL2330	HBL2620	HBL2830	HBL45905	HBL9315	HBL8430A		
HBL4760	HBL7310B	HBL2340	HBL2630	HBL3330		HBL9330	HBL8450A		
HBL5251	HBL7310BG	HBL2410	HBL2640	HBL3330G		HBL9360•	HBL8460A		
HBL52CM61	HBL7535	HBL2420	HBL2650	HBL3430		HBL9365•	HBL9430A		
HBL5261	HBL7582	HBL2430	HBL2710	HBL3430G		HBL9367•	HBL9450A		
HBL53CM61	HBL8210	HBL2440	HBL2720	HBL3520			HBL9460A		
HBL5361	HBL8310	HBL2450	HBL2730	HBL7410B					
HBL5461	HBL8410	HBL2460	HBL2740	HBL7410BG					
HBL5552B	HBL8420	HBL2510	HBL2750						
		HBL2520	HBL2760						

Note: *50A 2P 3W.

Wallplates for Single Receptacles

Description	Group A		Group B		Group C		Group D		Group E
	Boss diameter 1.36" to 1.39" (34.5 to 35.3)		Boss diameter 1.55" to 1.58" (39.4 to 40.1)		Boss diameter 1.68" to 1.72" (42.7 to 43.7)		Boss diameter 2.09" to 2.13" (53.1 to 54.1)		Boss diameter 2.28" to 2.44" (57.9 to 62.0)
	1-Gang	2-Gang	1-Gang	2-Gang	1-Gang	2-Gang	1-Gang	2-Gang	2-Gang
Smooth thermoplastic.	P7*	–	P720*	–	–	–	P724*	P703*	–
Cast aluminum.	HBL7320	–	HBL7320	–	HBL3394	–	HBL9419	–	–
Stainless steel, 302/304, smooth.	SS7**	SS72	SS720	–	SS725	–	SS723	SS703	SS701

Note: *See pages N-7 and M-8 for complete wallplate descriptions.

**Catalog number indicated is Stainless Steel, replace "SS" with the following prefix to designate material: "SA" for Anodized Aluminum, "SB" for Solid Brass.

Weatherproof Lift Covers for WDL "Closed" and WDL "Open", Wet Locations, 1-Gang

Description	Group A	Group B	Group C	Group D	50A Twist-Lock® Receptacles	30A 4W Hubbellok® Receptacles
	Boss diameter 1.36" to 1.39" (34.5 to 35.3)	Boss diameter 1.55" to 1.58" (39.4 to 40.1)	Boss diameter 1.68" to 1.72" (42.7 to 43.7)	Boss diameter 2.09" to 2.13" (53.1 to 54.1)		
Thermoplastic, with cover "open", gray.	HBL7423WO	HBL7425WOA	HBL7424WO	–	HBL7774WO^	–
Thermoplastic, with cover "open", yellow.	HBL74CM23WO	HBL74CM25WOA	HBL74CM24WO	–	HBL77CM74WO^	–
Cast aluminum, with cover "closed".	HBL7420	HBL7420	HBL3393	HBL9420 HBL9425•	HBL7770	HBL20405† HBL20446†

Note: *50A 2P 3W.

^The "CS" versions of 50A Twist-Lock® receptacles will only fit these thermoplastic wallplates.

†HBL20446 wallplate painted red for use with HBL20443 only. HBL20405 wallplate is for use with HBL20403 only. See page B-65 for devices.

Weatherproof Thermoplastic Cover For Flanged Inlets and Flanged Receptacles

IP44
SUITABILITY

Description	Catalog Number
For use with 15 and 20A, 2 pole, 2 wire and 2 pole, 3 wire Insulgrip® flanged inlets and flanged receptacles below.	WP1

Straight Blade, 2 pole, 3 wire Flanged Inlets



HBL5278C
HBL5378C
HBL5478C
HBL5678C

Flanged Receptacles



HBL5279C
HBL5379C
HBL5479C
HBL5679C

Twist-Lock®, 2 pole, 2 wire and 2 pole, 3 wire Flanged Inlets



HBL8815C
HBL7524C
HBL4716C
HBL4586C
HBL4786C

Flanged Receptacles



HBL8809C
HBL7526C
HBL4715C
HBL4585C
HBL4785C



Weatherproof Thermoplastic Cover For Flanged Inlets and Flanged Receptacles

Description	Catalog Number
For use with 20 and 30A, 3, 4, and 5 wire Insulgrip flanged inlets and flanged receptacles below.	WP2

Twist-Lock®, 2 pole, 3 wire; 3 pole, 4 wire; 4 pole, 4 wire; 4 pole, 5 wire Flanged Inlets



HBL2315	HBL2445	HBL2635	HBL2765
HBL2325	HBL2455	HBL2645	HBL2775
HBL2335	HBL2465	HBL2655	HBL2815
HBL2345	HBL2515	HBL2715	HBL2825
HBL2355	HBL2525	HBL2725	HBL2835
HBL2415	HBL2535	HBL2735	HBL3325C
HBL2425	HBL2615	HBL2745	HBL3334C
HBL2435	HBL2625	HBL2755	HBL7408C

Flanged Receptacles



HBL2316	HBL2446	HBL2636	HBL2766
HBL2326	HBL2456	HBL2646	HBL2776
HBL2336	HBL2466	HBL2656	HBL2816
HBL2346	HBL2516	HBL2716	HBL2826
HBL2356	HBL2526	HBL2726	HBL2836
HBL2416	HBL2536	HBL2736	HBL3326C
HBL2426	HBL2616	HBL2746	HBL3335C
HBL2436	HBL2626	HBL2756	HBL7409C



WP1



WP2

Weatherproof Thermoplastic Cover For Flanged Inlets 50 Amp CS Series

Description	Catalog Number
For use with 50A locking inlets with trimmed sides only.	HBL7780



HBL7780



HBL7777A

Weatherproof Covers for Receptacles with Face Dia. of 2.28–2.44 in. (57.9–62.0)

Description	Catalog Number
Thermoplastic, 2-gang, wet and damp locations with cover “closed”, gray.	HBL7777A[▲]
Thermoplastic, 2-gang, wet and damp locations with cover “closed”, yellow.	HBL77CM77A[▲]

Weatherproof Covers for Receptacles with Face Dia. of 2.09–2.13 in. (53.1–54.1)

Description	Catalog Number
Cast aluminum, wet locations only when cover “closed” and damp locations.	HBL9420
Cast aluminum, no lift cover. NOT weatherproof.	HBL9419



HBL9420

Weatherproof Covers for 50A Twist-Lock[®] Single Receptacles

Description	Catalog Number
Thermoplastic, wet and damp locations with cover “open”, gray.	HBL7774WO*
Thermoplastic, wet and damp locations with cover “open”, yellow.	HBL77CM74WO*
Cast aluminum, wet locations only when cover “closed” and damp locations.	HBL7770
Galvanized Steel, fits 4" square or 2-gang box.	HBL50SC**
Stainless steel, single gang, wallplate. NOT weatherproof.	SS750[▲]



HBL7774WO

Weatherproof Covers for 30A, 4 Wire Hubbellock[®] Receptacles

Description	Catalog Number
Thermoplastic, wet and damp locations with cover “open”, gray.	HBL7428WOG*
Thermoplastic, wet and damp locations with cover “open”, yellow.	HBL7428WOY*
Thermoplastic, wet and damp locations with cover “open”, red.	HBL7428WOR*
Cast aluminum, wet locations only when cover “closed” and damp locations, lift cover plate.	HBL20405
Cast aluminum, wet locations only when cover “closed” and damp locations, red finish.	HBL20446
Cast aluminum, no lift cover. NOT weatherproof.	HBL20406



HBL7770

Note: [▲]Will fit FS/FD boxes having wallplate mounting holes on 3.25 in. x 3.75 in. (82.6 x 95.3) centers.
[▽]Will only fit old style porcelain face devices.
 *The “CS” versions of 50A Twist-Lock[®] will only fit these wallplates.
 **IP20 Suitability.

Weatherproof Covers for Single Receptacles on FS/FD Boxes

All weatherproof covers are UL Listed for WET LOCATIONS WITH COVER CLOSED for intermittent use in wet locations or use in damp locations. Those with suffix “WO” are listed for WET LOCATIONS with cover open in continuous use. All plates are gasketed and self-closing.

Accessories

Description	Catalog Number
Sub-plate for mounting and weatherproofing flanged devices with mounting centers of 1.76", 1.94" or 2.13" such as HBL7556, HBL4716, etc. when used with a HBL7420 or HBL7425WOA type weatherproof covers.	7452[•]
Adapter plate for mounting HBL7423WO, HBL7424WO, HBL7425WOA or HBL7420 covers to standard boxes.	HBL7349[•]

Note: [•]Not UL Listed.



HBL20405



HBL7349

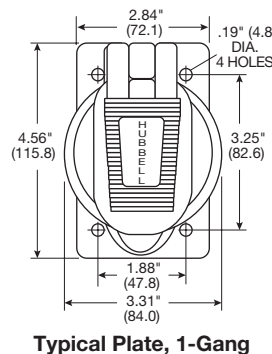
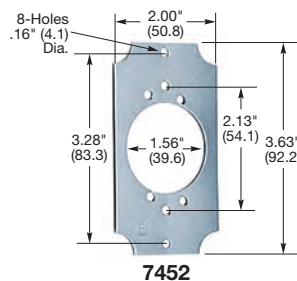

Dimensions in Inches (mm)

IP44
SUITABILITY

Weatherproof Covers for Receptacles with Face Dia. of 1.36–1.39 in. (34.5–35.3)

Description	Catalog Number
Thermoplastic, wet and damp locations with cover “open”, gray.	HBL7423WO
Thermoplastic, wet and damp locations with cover “open”, yellow.	HBL74CM23WO
Cast aluminum, wet location only when cover “closed” and damp locations.	HBL7420
Cast aluminum, no lift cover, NOT weatherproof.	HBL7320[▲]



HBL7423WO

Weatherproof Covers for Switches & Receptacles with Face Dia. of 1.55–1.58 in. (39.4–40.1)

Description	Catalog Number
Thermoplastic, wet and damp locations with cover “open”, gray.	HBL7425WOA
Thermoplastic, wet and damp locations with cover “open”, yellow.	HBL74CM25WOA
Thermoplastic, wet and damp locations with cover “open”, white.	HBL74CM25WOAW
Cast aluminum, wet and damp locations with cover “closed.”	HBL7420[*]
Cast aluminum, no lift cover, NOT weatherproof.	HBL7320[▲]
Thermoplastic, wet and damp locations with cover “open”, gray.	HBL7428WOG^{**}
Thermoplastic, wet and damp locations with cover “open”, yellow.	HBL7428WOY^{**}
Thermoplastic, wet and damp locations with cover “open”, red.	HBL7428WOR^{**}



HBL7425WOA

Weatherproof Covers for Receptacles with Face Dia. of 1.68–1.72 in. (42.7–43.7)

Description	Catalog Number
Thermoplastic, wet and damp locations with cover “open”, gray.	HBL7424WO
Thermoplastic, wet and damp locations with cover “open”, yellow.	HBL74CM24WO
Cast aluminum, wet location only when cover “closed” and damp locations.	HBL3393
Cast aluminum, no lift cover, NOT weatherproof.	HBL3394[▲]



HBL7420

Note: ^{*}Cast aluminum lift cover with fibershield for standard toggle and PresSwitch[®] Switches.

^{**}Features two #6-32 threaded inserts to back mount device to cover.

[▲]IP20 SUITABILITY.

All weatherproof lift cover plates on this page are UL Listed as “WDL Closed” for use in wet locations with cover closed and in damp locations.

Weatherproof Covers for Single Receptacles on FS/FD Boxes

All weatherproof covers are UL Listed for WET LOCATIONS WITH COVER CLOSED for intermittent use in wet locations or use in damp locations. Those with suffix “WO” are listed for WET LOCATIONS with cover open in continuous use. All plates are gasketed and self-closing.



HBL7320

2023 National Electrical Code (NEC[®]) Requirement

406.9 Receptacles in Damp or Wet Locations.

406.9 Receptacles in Damp or Wet Locations.

(B) Wet Locations

(1) Receptacles of 15 and 20 Amperes in a Wet Location.

Receptacles of 15 and 20 amperes, 125 and 250 volts installed in a wet location shall have an enclosure that is weatherproof whether or not the attachment plug cap is inserted. An outlet box hood installed for this purpose shall be identified as “extra-duty.” Other listed products, enclosures, or assemblies providing weatherproof protection that do not utilize an outlet box hood need not be marked “extra-duty.”

All 15- and 20-ampere, 125- and 250-volt nonlocking-type receptacles shall be listed and so identified as weather-resistant type.

(2) Other Receptacles. All other receptacles installed in a wet location shall comply with 406.9(B)(2)(a) or (B)(2)(b).

(a) A receptacle installed in a wet location, where the product intended to be plugged into it is not attended while in use, shall have an enclosure that is weatherproof with the attachment plug cap inserted or removed.

(b) A receptacle installed in a wet location where the product intended to be plugged into it will be attended while in use (e.g., portable tools) shall have an enclosure that is weatherproof when the attachment plug is removed.

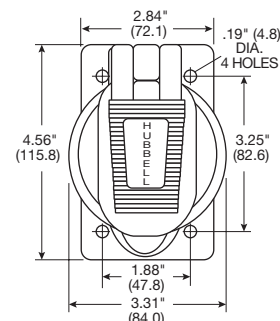

Typical Plate, 1-Gang



HBL7424WO



HBL3393

Dimensions in Inches (mm)

NEC[®] is a registered trademark of the The National Electrical Code.



HBL1795

Weatherproof Wallplates

Description	Catalog Number
Clear bubble wallplate, silicone rubber for use with all general purpose AC toggle and PresSwitch® switches. Fits both FS/FD and standard boxes.	HBL1795



HBL1750

Weatherproof Wallplates

Description	Catalog Number
Gray neoprene PresSwitch® wallplate. Fits FS/FD and standard boxes.	HBL1750*
Same as above except yellow.	HBL17CM50*

Note: *Not UL Listed.



HBL1785

Weatherproof Wallplates

Description	Catalog Number
Gray neoprene PresSwitch® wallplate with 125V red pilot light. Fits only FS/FD boxes.	HBL1785*
Same as above except yellow.	HBL17CM85*

Note: *Not UL Listed.

Weatherproof Covers

Description	Catalog Number
Cast aluminum lift cover with fiber shield. For standard toggle and PresSwitch® switches. Fits only FS/FD boxes.	HBL7420



HBL7420

Brass Locking Covers Attachment for Switches

Description	Catalog Number
Straight keying (all locks alike) appropriate for most applications. Straight cylinder type lock, each HBL96061 ordered operates on the same key. All locks are keyed alike.	HBL96061*
Same as above except in dull chrome finish to match stainless steel wallplates.	HBL96061DCH*

Straight keying (individual). Straight cylinder type lock, each HBL96062 ordered operates on a different key. All locks are keyed differently and individually. This type cannot be master keyed.

HBL96062*

Note: *Not UL Listed or CSA Certified.



HBL96061

Shown with cover and switch (sold separately)

Locking Device

Description	Catalog Number
Locking device for weatherproof covers.	HBLWLC



HBLWLC

IP44
SUITABILITY

Duplex Covers For Vertical Mounting

Description	Dimensions		Catalog Number
	Height x Width x Depth		
Thermoplastic, gray, for FS/FD box mounting.	4.56" x 2.89" x 1.08" (115.8 x 73.4 x 27.4)		HBL5221
Thermoplastic, yellow, for FS/FD box mounting.	4.56" x 2.89" x 1.08" (115.8 x 73.4 x 27.4)		HBL52CM21
Thermoplastic, white, for FS/FD box mounting.	4.56" x 2.89" x 1.08" (115.8 x 73.4 x 27.4)		HBL52CM21W
Thermoplastic, gray, for device mounting.	4.56" x 2.89" x 1.08" (115.8 x 73.4 x 27.4)		HBL5222
Thermoplastic, yellow, for device mounting.	4.56" x 2.89" x 1.08" (115.8 x 73.4 x 27.4)		HBL52CM22
Die cast aluminum, gray, commercial grade, vertical position, device mount.	4.56" x 2.81" x 0.75" (115.8 x 71.4 x 19.1)		WP8V



HBL5221



WP8V



HBL5206WO



WP8H

Duplex Covers For Horizontal Mounting

Description	Dimensions		Catalog Number
	Height x Width x Depth		
Cast aluminum, for device mounting.	2.88" x 4.56" x 0.79" (73.2 x 115.8 x 20.1)		HBL5205WO
Cast aluminum, for FS/FD box mounting.	2.88" x 4.56" x 0.79" (73.2 x 115.8 x 20.1)		HBL5206WO
Die cast aluminum, gray, commercial grade, horizontal position, device mount.	2.90" x 4.60" x 0.75" (73.7 x 116.8 x 19.1)		WP8H

GFCI, Surge and Style Line® Covers

Description	Dimensions		Catalog Number
	Height x Width x Depth		
Thermoplastic, gray, for FS/FD box mounting.	4.56" x 2.84" x 1.27" (115.8 x 72.2 x 32.3)		HBL5226
Die cast aluminum, gray, commercial grade, vertical position, device mount.	4.56" x 2.81" x 0.75" (115.8 x 71.4 x 19.1)		WP26V
Die cast aluminum, gray, commercial grade, horizontal position, device mount.	2.30" x 4.75" x 0.73" (58.4 x 120.7 x 18.5)		WP26H



HBL5226



WP26V



HBL5201

Toggle Cover

Description	Dimensions		Catalog Number
	Height x Width x Depth		
Thermoplastic, gray, for FS/FD box mounting.	4.56" x 2.89" x 1.08" (115.8 x 73.4 x 27.4)		HBL5201

Note: All weatherproof covers are UL Listed for WET LOCATIONS WITH COVER CLOSED, for intermittent use in wet locations or use in damp locations. Those with suffix "WO" are listed for WET LOCATIONS with cover open in continuous use. All cover plates are gasketed and self-closing.

Dimensions in Inches (mm)

Features and Benefits

Weatherproof Metallic While-In-Use Covers

The NEMA 3R Rated EXTRA DUTY® Metallic and Non-metallic While-in-Use Covers offer weather protection for outlets when they are in use.

- Patented keyhole mounting system allows installation in under a minute
- Pre-configured for GFCI with patented technology for alternate devices
- Lockable tab for OSHA compliance
- Sealed-in-place gasket
- Premium powder coat
- External cord retention chamber
- Each box contains three or six adapters to make a variety of configurations (8 or 55)



Metallic EXTRA DUTY® While-In-Use Covers

Description	Dimensions	
	Height x Width x Depth	Catalog Number
Heavy duty die-cast aluminum 1-gang box with gray lid for vertical mounting offers superior commercial quality 8-in-1 configurations.	6.12" X 3.37" X 3.5" (155.4 X 85.6 X 89.0)	WP26E
Heavy duty die-cast metal 1-gang box with gray lid for horizontal mounting; 8-in-1 configurations.	4.37" X 5.12" X 3.5" 111.0 X 130.0 X 89.0	WP26EH
Heavy duty die-cast metal 2-gang box with gray lid for vertical mounting; 55-in-1 configurations.	6.12" X 5.12" X 3.5" (155.4 X 130.0 X 89.0)	WP262E

1.8
Product Variations

1 Box {3 Adapters}

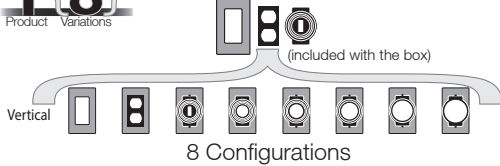

1.8
Product Variations

1 Box {3 Adapters}

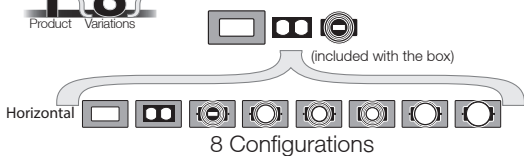

1.55
Product Variations

1 Box {6 Adapters}

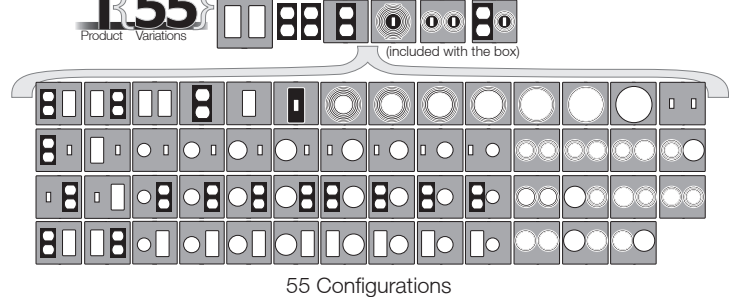

Metallic Cover Dimensions

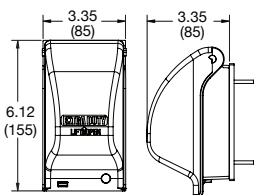

WP26E

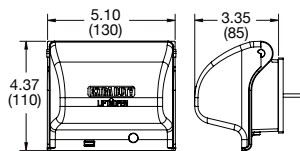

WP26EH

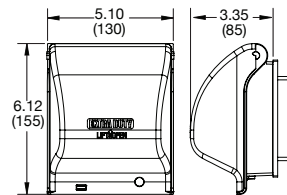

WP262E

Dimensions in Inches (mm)

Features and Benefits

Weatherproof Non-Metallic While-In-Use Covers

The NEMA 3R Rated EXTRA DUTY® Metallic and Non-metallic While-in-Use Covers offer weather protection for outlets when they are in use.

- Patented keyhole mounting system allows installation in under a minute
- Pre-configured for GFCI with patented technology for alternate devices
- Lockable tab for OSHA compliance
- Sealed-in-place gasket
- High-impact polycarbonate construction provides maximum durability
- Each box contains three or six adapters to make a variety of configurations (16 or 55)



Weather Resistant Recessed Receptacle with While-In Use Cover

Description	Housing Color	Horizontal Mount	Vertical Mount
Weather and tamper-resistant duplex receptacle with clear while-in-use cover, 15A 125V	GRAY	RW15300GY	RW15400GY
	WHITE	RW15300W	RW15400W
	BROWN	RW15300BR	RW15400BR

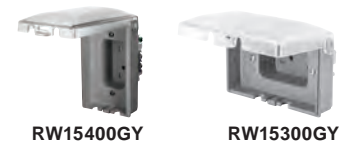

Non-Metallic While-In-Use Covers

Description	Dimensions Height x Width x Depth	Product Variations	
		Standard	EXTRA DUTY®
Standard 1-gang box with clear tinted cover, for horizontal or vertical mounting; 16-in-1 configurations.	5.90" X 4.18" X 2.75" (149.8 X 106.1 X 69.9)	RW57300	RW58300
Extra deep 1-gang box with clear tinted cover, for horizontal or vertical mounting; 16-in-1 configurations.	5.92" X 4.20" X 4.75" (150.4 X 106.7 X 120.7)	RW57350	RW58350
Standard 2-gang box, clear tinted cover, for vertical mounting only; 55-in-1 configurations.	5.54" X 5.43" X 2.75" (140.7 X 138.0 X 69.9)	RW57750	RW58750

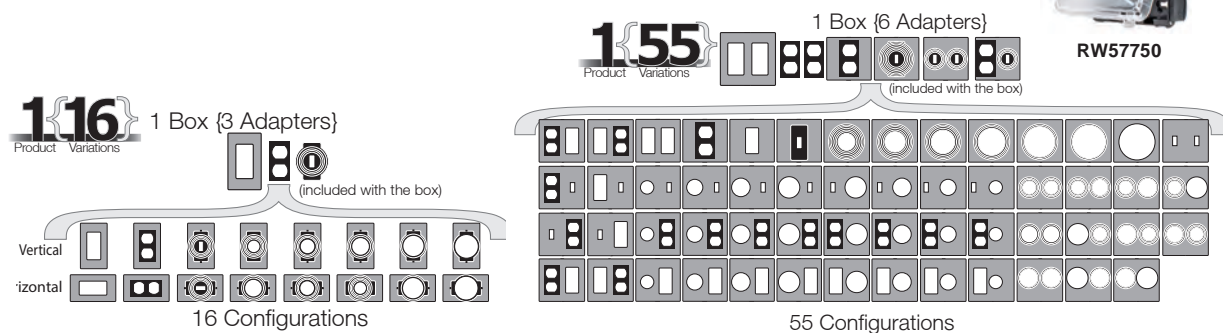

Non-Metallic Cover Dimensions

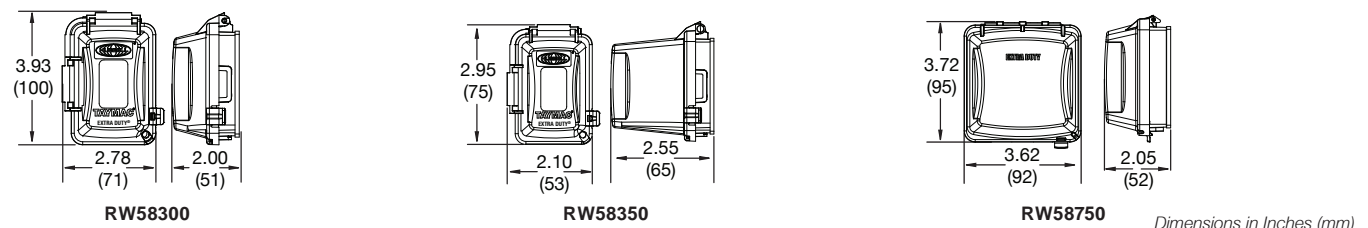

Features and Benefits

Weatherproof Non-Metallic Recessed While-In-Use Extra Duty Covers

Hubbell has added a unique solution to our weatherproof, non-metallic device cover line up with the Recessed In-Use Extra Duty rated Cover. This is a great alternative for locations to meet the NEC code when space and aesthetics are important.

- Aesthetically pleasing flat profile
- Meets the Extra Duty rating
- Versatility, it can be installed for new or old work
- Compatibility with all common siding types and materials: vinyl, wood, stucco and brick/block
- Mounted horizontally or vertically
- Includes an electrical box and optional siding flange
- Compatibility with duplex, GFCI and single receptacles (receptacle not included)
- cULus listed product and NEC and NEMA 3R compliant
- Colors available clear cover with gray, white or bronze back housing



RW5420CW

Non-Metallic EXTRA DUTY® While-In-Use Covers

Description	Color	Catalog Number
1-Gang Weatherproof Extra Duty Recessed While-In-Use Cover	Clear/Gray	RW5420CG
	Clear/White	RW5420CW
	Clear/Bronze	RW5420CZ

Weatherproof Heavy Cast Aluminum Lockable Cover

Made of heavy cast aluminum that provides high strength. Suitable for industrial and commercial applications.

- Flush enclosure, cover has mounting plate, fits standard 4 inch or 4¹/₆ inch electrical box
- Adapter plates for GFCI, duplex, single receptacles or switch
- Rated NEMA 3R
- cULus listed



WP4600

Weatherproof Heavy Cast Aluminum Lockable Cover

Description	Color	Catalog Number
1-Gang weatherproof 4 in 1 flush enclosure heavy cast aluminum lockable cover.	Aluminum	WP4600

Features and Benefits

Stainless Steel Weatherproof Flip Covers

Stainless steel weatherproof flip covers are suitable for use in applications where corrosion and sanitation are vital concerns. Heavy duty 316 stainless steel provides an excellent finish and superior corrosion resistance in all applications. Models listed are typically used in indoor/outdoor applications such as, food/chemical processing, pharmaceutical and water treatment facilities.

- Manufactured in heavy duty 316 stainless steel for increased corrosion resistance
- Polished finish for a clean aesthetic appearance
- Smooth surfaces to allow ease of cleaning
- Duplex and GFCI versions
- UL Type 3R:
 - Rain-tight and sleet (Ice) resistant
 - Self-closing lid
- UL Type 4X:
 - Watertight, dust-tight and corrosion resistant for wash-down application
 - Latching cover



Industries Commonly Served

- Food and Beverage Production and Distribution
- Chemical Plants
- Water and Wastewater Treatment
- Pharmaceuticals and Cosmetics
- Refining and Extraction Sites
- Petrochemical Operations
- Marine and Coastal Facilities
- Pulp and Paper Mills
- Along with other corrosive environments

1-Gang Stainless Steel Weatherproof Flip Covers

Description	Catalog Number
1 Gang, Stainless Steel Duplex Cover, 3R	HBLSS83R
1 Gang, Stainless Steel GFCI Cover, 3R	HBLSS263R
1 Gang, Stainless Steel Duplex Cover, 4X	HBLSS84X
1 Gang, Stainless Steel GFCI Cover, 4X	HBLSS264X



HBLSS83R



HBLSS263R



HBLSS84X

1-Gang Stainless Steel While-In-Use Weatherproof Cover

Description	Catalog Number
1 Gang, Stainless Steel GFCI Cover, 3R	HBLSS26WIS



HBLSS26WIS

Specifications

Cover	Stainless Steel
Base	Stainless Steel
Hinge Pin	Stainless Steel
Spring	Stainless Steel
Base Gasket	Elastomer
Cover Gasket	Elastomer
Back Gasket	Eva Form
Ground Screw	Steel, Zinc Plated
Mounting Screw	Stainless Steel

Product Dimensions

Catalog Number	Height	Width	Depth	Opening
HBLSS83R	3.04" (77.2)	4.85" (123.2)	.88" (22.4)	2.62" (66.5)
HBLSS263R	3.04" (77.2)	4.85" (123.2)	.88" (22.4)	2.76" (70.0)
HBLSS84X	3.04" (77.2)	4.85" (123.2)	.88" (22.4)	2.62" (66.5)
HBLSS264X	3.04" (77.2)	4.85" (123.2)	.88" (22.4)	2.76" (70.0)
HBLSS26WIS	6.54" (166.1)	3.70" (93.9)	2.31" (58.7)	7.57" (192.3)

Dimensions in Inches (mm)



RW51470

RW51550



RW51040



RW51810



RW51520



RW51020



RW51320



RW51330



RW51380



RW51450

1-Gang Weatherproof Covers for Vertical Mounting

Description	Dimensions		Catalog Number
	Height x Width x Depth		
Zinc die cast, gray, duplex cover for box mounting.	4.58" x 2.82" x 0.57"	(116.3 x 71.6 x 14.5)	RW51470
Zinc die cast, gray, 1.40 in. (35.6) cover for single receptacle or toggle switch for device mounting.	4.56" x 2.81" x 0.88"	(115.8 x 71.4 x 22.4)	RW51550*
Zinc die cast, gray, GFCI, Surge and Style Line® cover for device mounting.	4.58" x 2.81" x 0.57"	(116.3 x 71.4 x 14.5)	RW51040

1-Gang Weatherproof Covers for Horizontal Mounting

Description	Dimensions		Catalog Number
	Height x Width x Depth		
Zinc die cast, gray, duplex cover for device mounting.	2.82" x 4.57" x 0.79"	(71.6 x 116.1 x 20.1)	RW51810
Zinc die cast, gray, 1.40 in. (35.6) cover for single receptacle or toggle switch for device mounting.	2.81" x 4.56" x 0.99"	(71.4 x 115.8 x 25.1)	RW51520*
Zinc die cast, gray, GFCI, Surge and Style Line® cover for device mounting.	2.82" x 4.56" x 0.52"	(71.6 x 115.8 x 13.2)	RW51020

2-Gang Weatherproof Covers for Vertical Mounting

Description	Dimensions		Catalog Number
	Height x Width x Depth		
Zinc die cast, gray, duplex cover for device mounting.	4.54" x 4.54" x 0.75"	(115.3 x 115.3 x 19.1)	RW51320
Zinc die cast, gray, one duplex/one GFCI, Surge and Style Line® cover for box mounting.	4.54" x 4.54" x 0.77"	(115.3 x 115.3 x 19.6)	RW51330
Zinc die cast, gray, 1.40 in. (35.6) cover for single receptacle or toggle switch for device mounting.	4.54" x 4.54" x 0.77"	(115.3 x 115.3 x 19.6)	RW51380
Zinc die cast, gray, two GFCI, Surge and Style Line® cover for box mounting.	4.54" x 4.56" x 0.73"	(115.3 x 115.8 x 18.5)	RW51450

*Note: All weatherproof cover plates are UL Listed for WET LOCATIONS WITH COVER CLOSED, for intermittent use in wet locations or use in damp locations. All cover plates are gasketed and self-closing.
cULus Listed.

Dimensions in Inches (mm)

Wallplates and Covers

Screws, 6-32 Thread, 100 Count

Description	Color/Material	Catalog Number
Decorator Wallplate Screws, Oval Head Milled Slot, 3/8 in. Long – 6-32 Thread, 100 per Box (Order 1 to receive a box of 100).	Black	RA38BKPK100
	Brown	RA38PK100
	Gray	RA38GYPK100
	Ivory	RA38IPK100
	Light Almond	RA38LAPK100
	White	RA38WPK100
Brass plated screw, standard slot, .38 in. (.97) long.	Stainless Steel	RA38SSPK100
	Brass	HBL7341
Standard Wallplate Screws, Oval Head Milled Slot, 1/2 in. Long – 6-32 Thread, 100 per Box (Order 1 to receive a box of 100).	Black	RA12BKPK100
	Brown	RA12PK100
	Gray	RA12GYPK100
	Ivory	RA12IPK100
	White	RA12WPK100
Standard Wallplate Screws, Oval Head Milled Slot, 5/8 in. Long – 6-32 Thread, 100 per Box (Order 1 to receive a box of 100).	Stainless Steel	RA58SSPK100
	Stainless Steel	RA58SSPK100
Standard Wallplate Screws, Oval Head Milled Slot, 1.0 in. Long – 6-32 Thread, 100 per Box (Order 1 to receive a box of 100).	Ivory	RA88IPK100
	White	RA88WPK100
	Stainless Steel	RA88SSPK100



RA38IPK100



HBL7341



RA12IPK100



RA58SSPK100



RA88IPK100

Single Count Screws and Accessories

Description	Color	Catalog Number
Blank adapter, to fill a toggle opening.	Brown	RA756
	Ivory	RA756I
	White	RA756W
Blank adapter, to fill a decorator opening.	Black	NS620BK
	Gray	NS620GY
	Ivory	NS620I
	Light Almond	NS620LA
	White	NS620W
Blank adapter, .406" (10.30) dia. hole, to fill a decorator opening.	Ivory	NS621I
	Light Almond	NS621LA
	White	NS621W
Mounting strap, with screws.	Steel	RA40



RA756W

RA40



NS620I

NS621I

Wallplates and Covers

Wallplate Dimensions

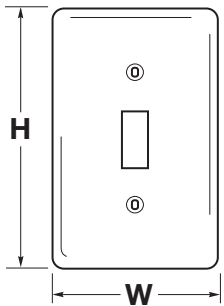

Size	Thermoplastic					
	Standard		Mid-Size		Jumbo-Size	
	Height	Width	Height	Width	Height	Width
1-Gang	4.63" (117.6)	2.88" (73.2)	4.94" (125.3)	3.15" (80.0)	5.25" (133.4)	3.50" (88.9)
2-Gang	4.63" (117.6)	4.69" (119.1)	4.94" (125.3)	5.00" (126.9)	5.25" (133.4)	5.31" (134.9)
3-Gang	4.63" (117.6)	6.50" (165.1)	4.88" (123.8)	6.75" (171.5)		
4-Gang	4.63" (117.6)	8.31" (211.1)	4.88" (123.8)	8.56" (217.4)		
5-Gang	4.63" (117.6)	10.12" (257.1)				
6-Gang	4.63" (117.6)	11.94" (303.1)				

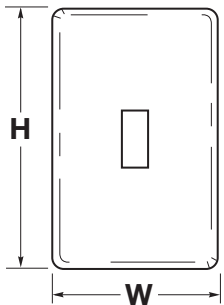

Size	Snap-On Thermoplastic		
	Height	Width	Depth
1-Gang	4.75" (120.6)	3.00" (76.2)	.25" (6.35)
2-Gang	4.75" (120.6)	4.81" (122.2)	.25" (6.35)
3-Gang	4.75" (120.6)	6.62" (168.2)	.25" (6.35)
4-Gang	4.75" (120.6)	8.44" (214.3)	.25" (6.35)

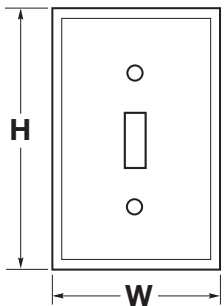

Size	Standard Metal		Painted Metal		Jumbo Metal	
	Height	Width	Height	Width	Height	Width
1-Gang	4.50" (114.3)	2.87" (72.9)	4.50" (114.3)	2.75" (69.8)	5.25" (133.4)	3.50" (88.9)
2-Gang	4.50" (114.3)	4.60" (116.8)	4.50" (114.3)	4.56" (115.8)	5.25" (133.4)	5.31" (134.9)
3-Gang	4.50" (114.3)	6.41" (162.8)	4.50" (114.3)	6.38" (162.1)		
4-Gang	4.50" (114.3)	8.22" (208.8)	4.50" (114.3)	8.18" (207.8)		
5-Gang	4.50" (114.3)	10.03" (254.8)	4.50" (114.3)	10.00" (254.0)		
6-Gang	4.50" (114.3)	11.81" (300.0)	4.50" (114.3)	11.81" (300.0)		
7-Gang	4.50" (114.3)	13.68" (347.5)				
8-Gang	4.50" (114.3)	15.44" (392.1)				

Wallplate Openings and Mounting Dimensions

#6-32 Oval Head Screws Typical

- Standard Metal - 1.39" (35.3)
- Painted Metal - 1.37" (34.8)
- Jumbo Metal - 1.76" (44.7)
- Standard Nylon - 1.44" (36.6)
- Mid-Size Nylon - 1.56" (39.6)

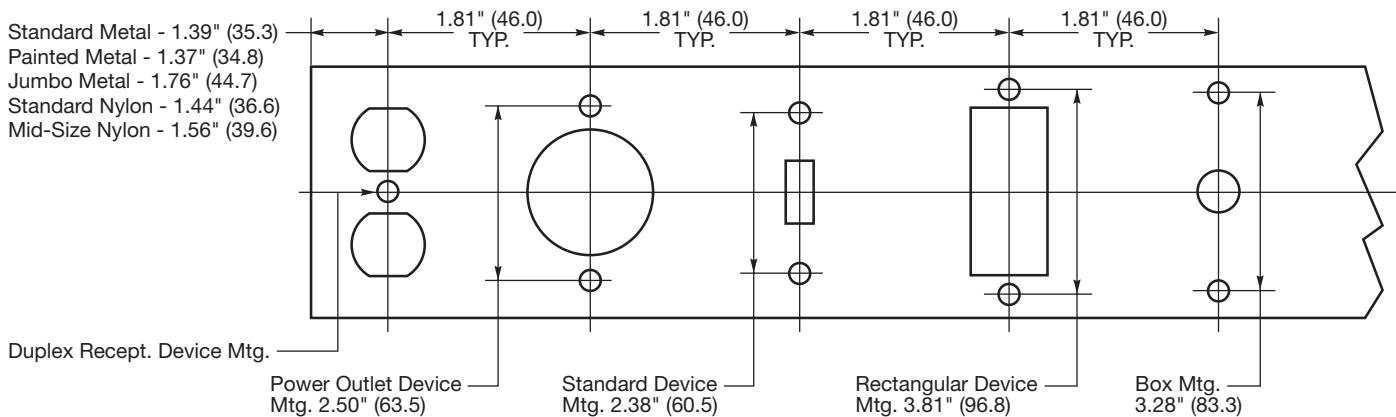

Note: Specifications are subject to change without notice.

Dimensions in Inches (mm)

Wallplates and Covers

Custom Metal Wallplates

How To Select A Custom Metal Wallplate

Step 1:

Determine wallplate material and enter in box marked "Catalog Number"

Smooth Metal Material	Code
Anodized Aluminum	AL
Brass plated steel	BP
Solid brass	BR
Chrome plated steel	CH
Stainless steel 302/304	SS

Determine number of gangs required and enter in box marked "Catalog Number" next to material.

Number of Gangs	Code
1-gang	1
2-gang	2
3-gang	3
4-gang	4
5-gang	5
6-gang	6
7-gang	7
8-gang	8

Enter Catalog Number

◆ WC* SS 4

Step 2:

Enter quantity.

Step 3:

Select the custom metal wallplate configuration.

Refer to the custom wallplate configuration chart to select a configuration for each gang in the wallplate. Each configuration has a specific 3-digit code located in the right hand side of the chart on pages N-32 to N-34. Enter this 3-digit configuration code in the corresponding box on the order form grid to match the position required on the finished custom wallplate.

Item No.	Catalog Number	Quantity	Code	Position 1	Position 2	Position 3	Position 4
1	WCSS4		H*	001	149	008	026
2							

Note: *WC and H are preprinted on the distributor order form.





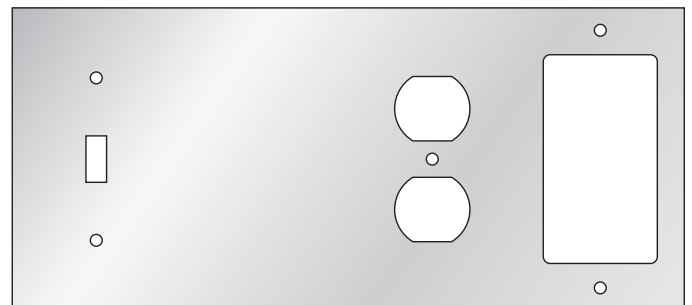





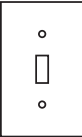
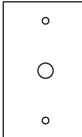

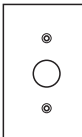
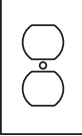
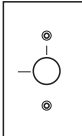
◆ Number to use for pricing.

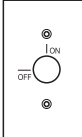
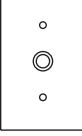
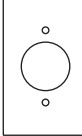
The 3-digit numbers listed at the upper right of the Sample Order Form (001, 149, etc.) represent the custom metal wallplate selected on the right. See Configuration Chart and Hubbell Configuration Selector Guide on pages N-32 to N-34 or additional configuration choices.

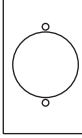

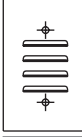
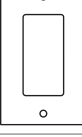
Wallplates and Covers

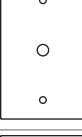
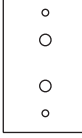
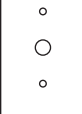
Configuration Chart

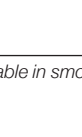
	001 Switch.		058 1-Gang .50" ID (12.7) Hole Box Mounted.
	007 Single Receptacle. 1.40" ID (35.6) Hole.		078 Barrel Key Switch.
	008 Duplex Receptacle.		079 Barrel Key Switch with Hash Marks.
	011 1-Gang .635" ID (16.1) Hole Box Mounted with .50" ID (12.7) Nylon Bushing.		080 Barrel Key Switch with ON/OFF and Hash Marks.
	012 1-Gang .635" ID (16.1) Hole Strap Mounted incl. Strap with .50" ID (12.7) Nylon Bushing.		091 Single Receptacle. 1.60" ID (40.5) Hole.
	013 Blank Box Mounted.		098 Single Receptacle. 2.16" ID (54.7) Hole.
	014 Blank Strap Mounted incl. Strap.		135 Vertical Mounted Louver.
	026 Rectangular Opening.		149 Totally Blank (No Mounting Holes).
	055 1-gang .375" ID (9.5) Hole Strap Mounted incl. Strap.	Coax/Twinax and Modular Jack Openings	
	056 1-Gang .375" ID (9.5) Hole Box Mounted.		456 .375" (9.5) Dia. Round Box Mounted.
	057 1-Gang .50" ID (12.7) Hole Strap Mounted incl. Strap.		458 .500" (12.7) Dia. Round Box Mounted.
			411 .635" (16.1) Dia. Round Box Mounted.

Note: For detailed dimensions of the above configurations, see pages N-35 and N-36. Available in smooth metal, standard size only up to and including 8-gang type.

Dimensions in Inches (mm)

Wallplates and Covers

Configuration Chart (Continued)

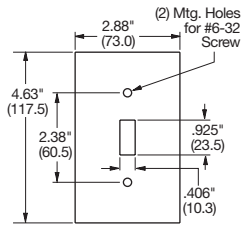

Configuration 001
Toggle Switch Wallplate

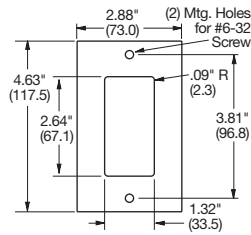

Configuration 026
GFI/Rectangular Opening

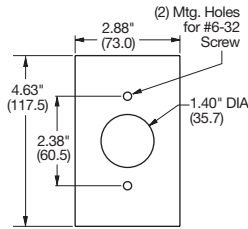

Configuration 007
Single 15 or 20A Straight Blade Receptacle;
15A Twist-Lock® Receptacle

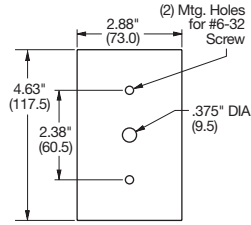

Configuration 055
Single, .375" (9.5) Telephone (Strap Mount)

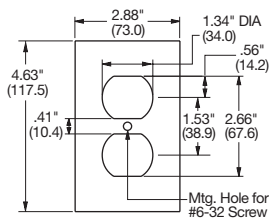

Configuration 008
Duplex Receptacle

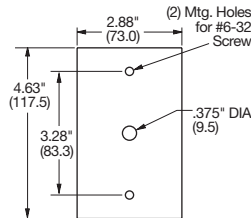

Configuration 056
Single, .375" (9.5) Telephone (Box Mount)

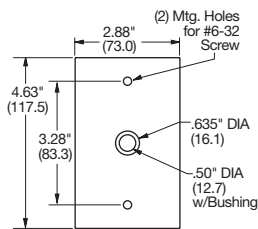

Configuration 011
Single, .635" (16.1) Telephone (Box Mount)

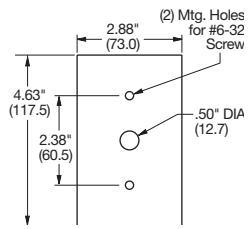

Configuration 057
Single, .50" (12.7) Telephone (Strap Mount)

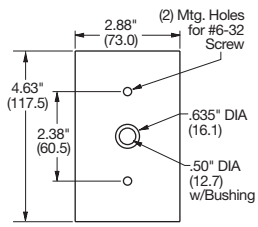

Configuration 012
Single, .635" (16.1) Telephone (Strap Mount)

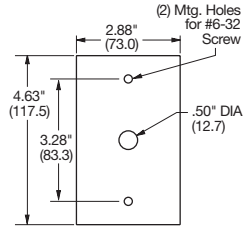

Configuration 058
Single, .50" (12.7) Telephone (Box Mount)

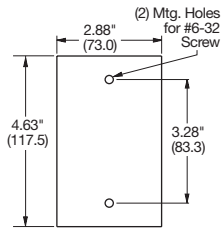

Configuration 013
Blank Wallplate (Box Mount)

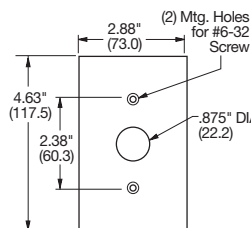

Configuration 078
Barrel Key Switch

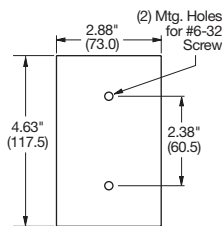

Configuration 014
Blank Wallplate (Strap Mount)

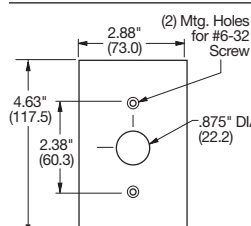

Configuration 079
Barrel Key Switch with Hash Marks

Note: Specifications are subject to change without notice.

Dimensions in Inches (mm)

Wallplates and Covers

Configuration Chart (Continued)

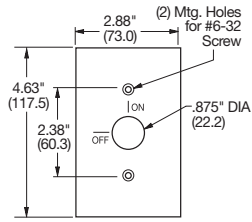

Configuration 080
Barrel Key Switch with ON/OFF and Hash Marks

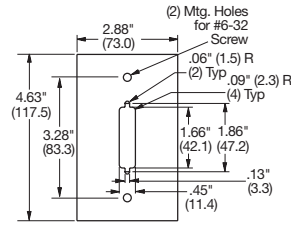

Configuration 295
RS232 Port Single 25-Pin (Box Mount)

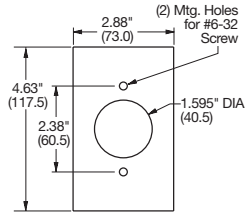

Configuration 091
Single 20 or 30A Twist-Lock® Receptacle

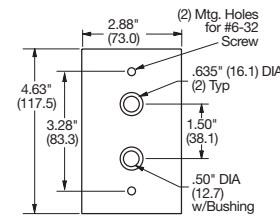

Configuration 411
Dual .635" (16.1) Holes (Box Mount)

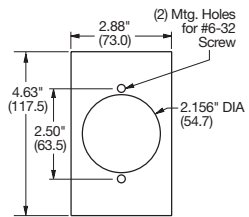

Configuration 098
Single Receptacle, 30 or 50A Straight Blade, 3 Wire Power Outlet

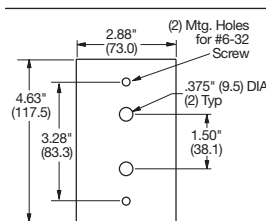

Configuration 456
Dual .375" (9.5) Round (Box Mount)

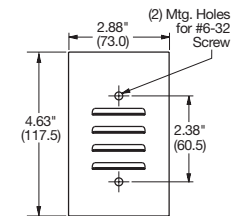

Configuration 135
Louvered Wallplate (Strap Mount)

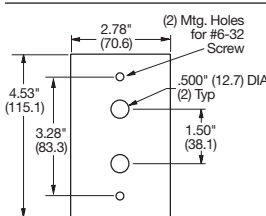

Configuration 458
Dual .50" (12.7) Round (Box Mount)

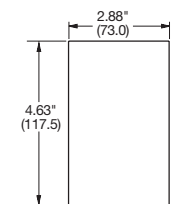

Configuration 149
Totally Blank Wallplate

Note: Specifications are subject to change without notice.

Dimensions in Inches (mm)

SECTION O

Table of Contents



SystemOne Recessed Floor Boxes for Concrete Floors



Flush Floor Boxes for Concrete Floors

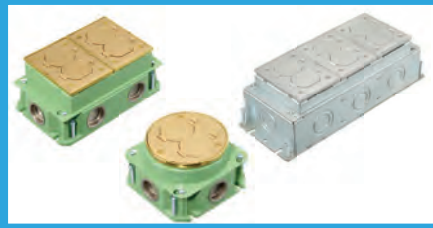

CONNEXION 2.0 Zone Distribution System



Product	Page	Product	Page
SystemOne Recessed Floor Boxes for Concrete Floors	O-3	Theater Seating Box and Accessories	O-34
Selecting a Concrete Floor Box	O-4	Recessed Concrete Floor Boxes and Covers	
2-Gang and 4-Gang Floor Boxes and Covers	O-6	Fire-Classified Solutions for 7 and 11-Gang Boxes	O-36
6, 4/5 and 8/10-Gang Floor Boxes and Covers	O-9	7 and 11-Gang Series	O-37
2, 4, 6, 4/5 and 8/10-Gang Plates and Accessories	O-11	8-Gang Ballroom Series	O-38
Fully Adjustable 4 inch Floor Boxes and Covers	O-16	Above-Floor Service Fittings (Single Service)	O-39
Floor Box Applications	O-18	Convention Center Utility Boxes	O-40
SystemOne Flush Floor Boxes		CONNEXION 2.0 Zone Distribution System	O-42
Floor Box Family	O-19	Zone Boxes, Splitters and Cables	O-43
Covers and Sub-Plates	O-20	Custom Pre-Wired Access Floor Boxes	O-45
Metal and Non-Metallic Floor Boxes	O-21	SystemOne Recessed Raised Access and Wood Floor Boxes	
Sub-Plates	O-22	Selecting a Raised Access and Wood Floor Box	O-46
Configuration Chart	O-23	2 and 4-Gang Rectangular Floor Boxes	O-48
Flush Floor Boxes and Covers		4-Gang Round Floor Boxes, Covers and Plates	O-50
Round Non-Metallic, Single or Multi-Service	O-24	8/10-Gang Rectangular Floor Boxes and Covers	O-51
Round Metal, Single Service	O-25	4 inch Round Floor Boxes, Covers, and Plates	O-52
Rectangular Non-Metallic, 1, 2, and 3-Gang	O-26	6 inch Furniture Feed Floor Boxes and Covers	O-54
Rectangular Cast Iron, 1, 2, and 3-Gang	O-28		
Rectangular Stamped Steel, 1, 2, and 3-Gang	O-30		
Flush Floor Boxes for Wooden Floors	O-32		
Floor Box Cover to Receptacle Compatibility Chart	O-33		

ETERNAL™ Series Products at a Glance



2-Gang Recessed

The Hubbell SystemOne 2-Gang Recessed Concrete Floor Box offers eight styles, satisfying the requirements of almost any commercial building application. Rectangular or round covers, as well as furniture feed covers, are available in a variety of finishes to blend with any existing or new décor. A parallel-device layout reduces plug interference, maximizing functionality and performance.

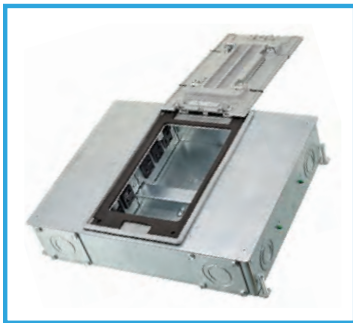

4-Gang Recessed

Similar to the 2-Gang Recessed Concrete Floor Box, Hubbell's SystemOne 4-Gang Recessed Concrete Floor Box is available with rectangular or round covers. Ten different styles make it possible to meet the electrical requirements of most commercial projects - new construction or renovation. The parallel device layout maximizes functionality which can be limited when devices are mounted 90° from one another.



4/5-Gang Recessed

The 4/5-Gang box provides a uniform look with rectangular or round covers that are available in several finishes to complement existing décor. Electrical devices are mounted vertically and are mounted to the plate prior to securing it to the box. Four removable knockout plates allows for 2" conduit feed-thru allowing for dual service capacity.

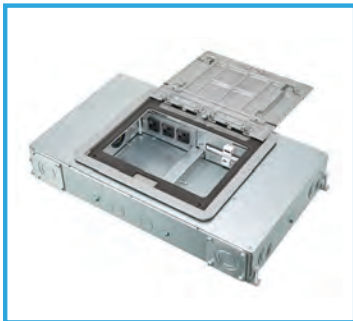

6-Gang Recessed

Increased power, data, and AV capacity is what the Hubbell SystemOne 6-Gang Recessed Concrete Floor Box was designed to handle. Four styles allow the floor box to work within almost any commercial application to enhance connectivity. Four removable knockout plates allows for 2" conduit feed-thru. Rectangular and round covers are available in a variety of finishes that work with any aesthetic or finish.



8/10-Gang Recessed

With maximum capacity in a small footprint, the 8/10-Gang box provides a uniform look with rectangular or round covers that are available in several finishes to complement existing décor. Electrical devices are mounted vertically and are mounted to the plate prior to securing it to the box. Four removable knockout plates allows for 2" conduit feed-thru allowing for simple installation of AV cables with pre-connectorized heads and specific bend radius requirements.

Box

- 3.75" deep wiring device chambers
- 14 gauge galvanized sheet metal and PVC and Cast Iron
- Optional fusion-bonded, green epoxy paint for on-grade use
- 3 in. and deeper versions accept field installed metallic 2" threaded hubs
- Patented PVC conduit adapters, CFBHUB200PVC for 2 in. feed-thru and CFBHUB125PVC for 1¼" feed-thru can be used on metal and PVC floorboxes
- Pre-pour and post-pour adjustment
- Patented, labor saving, easy mount device plates
- Exclusive 4-Gang PVC concrete floor boxes can be used for slab on grade and second floor and above concrete floors

Cover

- Available in round and rectangular, recessed and furniture feed styles
- Recessed covers open a full 180°
- Large hide-a-way cable egress doors
- Listed to UL 514A and UL Scrubwater compliant
- Die cast aluminum cover construction
- All covers are ADA compliant 



4-Gang PVC Recessed

The exclusive 4-Gang Recessed Concrete PVC Floor Box is available with rectangular or round covers. The unique floor box design can be installed slab on-grade and second floors and above. Box includes external leveling screws. For use with PVC conduits only; with standard PVC terminal adapters or Hubbell's innovative PVC hubs up to 2" conduit.

Features and Benefits

SystemOne ETERNAL™ Recessed Floor Boxes for Concrete Floors

Featuring the unique capabilities of Hubbell's SystemOne family design. Hubbell has enhanced and expanded its floor box offering to provide industry leading installation flexibility while accommodating an extensive range of applications. Hubbell SystemOne ETERNAL™ Series products are constructed to address customers personal solutions for today's demanding, power, data and audio/video and for tomorrow's.

Hubbell SystemOne ETERNAL™ Series concrete floorboxes with box depths of 3 inches and larger can be field installed with PVC and metallic hubs for feed-thru wiring. The enhanced box design also provides expanded device capacity and improved installation efficiency. These floorboxes will prove to be as indispensable asset to the building's delivery system infrastructure.



Recessed 4-Gang Floor Boxes

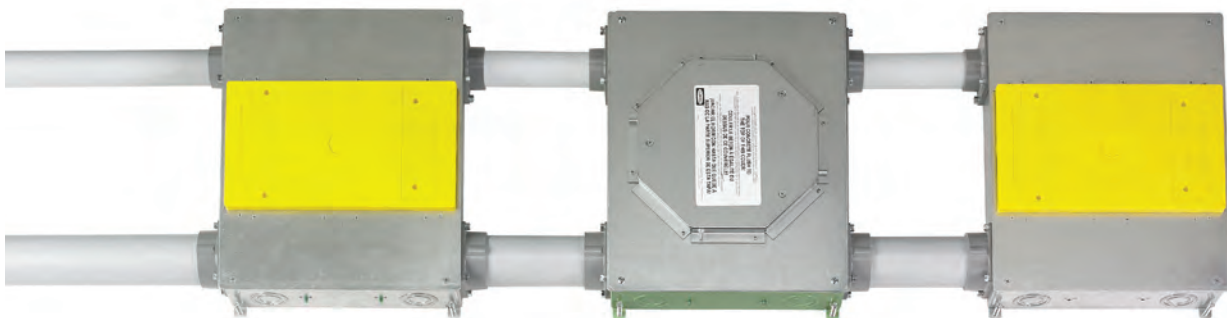

Concrete Pour Pocket Cap

- In concrete applications, all SystemOne Recessed floor boxes include (1) yellow factory installed, field-removable pour pocket cap provides a pocket in the final floor to accept the covers intended for terrazzo, tile, or finished concrete floor. The cap may not be used for carpet, wood or engineered floors

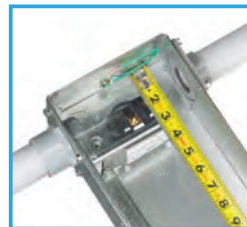

Deep Wiring Chambers

- The ETERNAL™ Series SystemOne Recessed concrete floor boxes have 3.75 inch deep wiring chambers to accommodate larger USB receptacles, AV modules and feed-thru wiring



Rectangular Cover Extension Caps

- Pre-pour extension caps allows the floor box to be installed with 1 inch of concrete above the box. Maximum of two yellow caps can be installed on each box. Additional pre-pour caps purchased in packs of twos

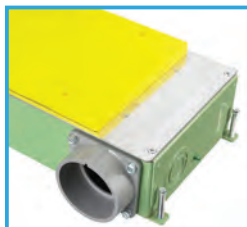

2 Inch Conduit Ready

- To meet expanding AV and data needs, the Hubbell SystemOne Recessed Floor Box line readily accepts 2 inch conduits with the use of a 2 inch PVC or threaded conduit hub. The offset design allows for less conduit lifting while threading and the hub mounting holes are asymmetrical for installation efficiencies

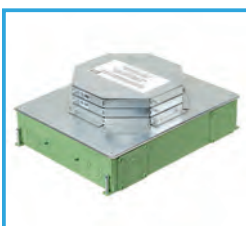

Round Cover Stackable Rings

- Pre-pour round stackable rings increases box height and concrete pour depth by 3/4 in. increments



CR Version

- Corrosion resistant epoxy paint intended for on-grade use, the CR version is coated with fusion-bonded epoxy paint to help prevent corrosion

Selecting a SystemOne ETERNAL™ Recessed Floor Box for Concrete Floors

To assist with the floor box selection process, please have the following information available:

Electrical requirements:	Application:	Cover style:
Power (each electrical device requires one gang) Data/AV (consult manufacturers' specification for size/volume requirements), number required. Add up total number to determine needed capacity. If necessary capacity is not shown round up to next size. Example: 9-Gang rounds up to a 10-Gang floor box	On-grade (OG) Above-grade (AG) Minimum concrete pour depth	Round Rectangular

Once this information is gathered start on the capacity column:

- ① Capacity: Select necessary box.
- ② Application: Select the concrete pour depth and on-grade or above-grade application.
- ③ Cover style: Select round or rectangular cover.
- ④ Locate interconnecting point of all three categories and move to right to select correct catalog number.

		Application - Minimum Pour Depth ②										Steel	Corrosion Resistant	PVC	Cast Iron			
		2 ½ in.		3 in.		3 ¼ in.		3 ¾ in.		5 ½ in.							6 ¼ in.	
		AG	OG	AG	OG	AG	OG	AG	OG	AG	OG						AG	OG
Electrical Requirements - Capacity ①	2-Gang	•												•			CFB2G25E	
			•													•		CFB2G25CRE
				•											•			CFB2G30E
					•											•		CFB2G30CRE
						•									•			CFB2G25RE
							•									•		CFB2G25RCRE
								•						•			CFB2G30RE	
										•					•		CFB2G30RCRE	
																•		CFB4G30PFBE
																•	•	CFB4G30PFBRE
			•												•			CFB4G25E
				•												•		CFB4G25CRE
					•										•			CFB4G30E
						•										•		CFB4G30CRE
							•									•		CFB4G25RE
								•								•		CFB4G25RCRE
									•								•	CFB4G30RE
										•							•	CFB4G30RCRE
											•						•	CFB4G30CI
												•					•	CFB4G30CI
												•					CFB45G55E	
													•				CFB45G55CRE	
														•			CFB45G55RE	
															•		CFB45G55RCRE	
															•		CFB6G30E	
																•	CFB6G30CRE	
																•	CFB6G30RE	
																	•	CFB6G30RCR
																	•	CFB10G55E
																	•	CFB10G55CRE
																	•	CFB10G55RE
																	•	CFB10G55RCRE
		Rectangular	Rectangular	Round	Round	Rectangular	Round											
		Cover Style ③																

Select Correct Catalog Number ④

Features and Benefits

SystemOne ETERNAL™ Recessed Benefits and Enhancements

Functionality

- Cables and connections are protected by recessed functionality
- Open architecture sub-plate design
- Common door layout regardless of flange for harmonized look
- Meets UL 514A scrubwater requirements with ScrubShield® technology
- All SystemOne covers are ADA compliant
- Cables and plugs are protected by recessed connections

Value

- Easy selection with common look for all floor types
- Enhance building décor with numerous finishes
- Increase durability and longevity with cast aluminum covers

Online Resources

- BIM models, customer drawings and technical specifications are available on www.hubbell-wiring.com



Recessed 4-Gang Floor Boxes with Recessed and Furniture Feed Covers



Safety

- Flush flange available for tile, finished concrete or Terrazzo
- Surface flange available for carpeted floors with 0.15 in. rise meets ADA requirements
- Hideaway egress doors fold under cover while in use



Family Look



- Hubbell SystemOne Recessed Floor Box line offers a common look regardless of capacity or installation. This simple concept ensures a consistent look throughout a building with rectangular or round covers. Round covers lend themselves to multi-story buildings also using Fire-Rated Poke-Through devices

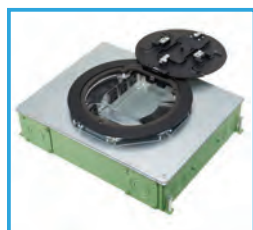

Service Access

- All covers have 180° opening of main door
- Larger cover openings allows for easier device installation and end user access
- Larger access area makes for effortless device engagement



Recessed and Furniture Feed Covers

- Hubbell SystemOne 2, 4, 6 and 10-Gang Recessed Floor Box line offers dynamic installation flexibility. Each box series has rectangular and round cover options with recessed and furniture feed cover capabilities

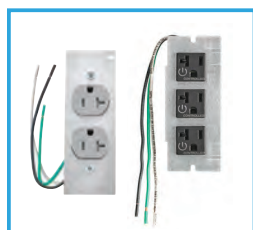

Pre-Wired Mounting Plates

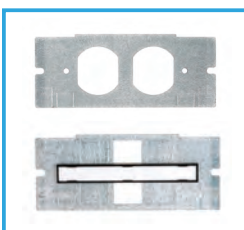

- Pre-wired duplex, StyleLine® and 3-Cube receptacles with 8 in. stranded leads are installed into plates to allow for even more labor savings
- Pre-Wired plates include Tamper Resistant, CONTROLLED and Isolated Ground



Single Screw Device Mounting Plates

- 2, 4 and 6-gang boxes offers line voltage and low voltage device plates with a patented single screw installation which maximizes installation efficiency by reducing install time

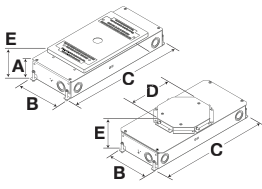
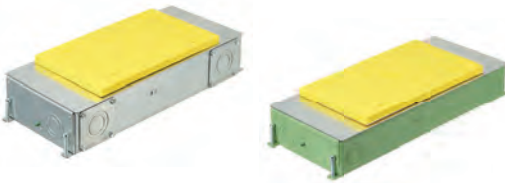
SystemOne Recessed 2-Gang Floor Boxes and Covers, for Use In Concrete Floors

Style	Rectangular Cover		Round Cover	
				
Box Type				
Standard Box	CFB2G30E	CFB2G25E	CFB2G30RE	CFB2G25RE
Corrosion-Resistant (On-grade)	CFB2G30CRE	CFB2G25CRE	CFB2G30RCRE	CFB2G25RCRE
Recommended Pour Depth	3.50" (88.9)	3.00" (76.2)	3.75" (95.3)	3.25" (82.6)
Min. Depth of Pour	3.00" (76.2)	2.50" (63.5)	3.75" (95.3)	3.25" (82.6)
Adjustability	Fully	Fully	Fully	Fully
Cubic Inch (cm ³) Capacity per Gang	56.5 cu. in. (926 cm ³)	47.5 cu. in. (778 cm ³)	56.5 cu. in. (926 cm ³)	47.5 cu. in. (778 cm ³)
Dimensions – A	3.00" (76.2)	2.50" (63.5)	–	–
Dimensions – B	6.62" (168.1)	6.62" (168.1)	7.32" (185.9)	7.32" (185.9)
Dimensions – C	16.27" (413.3)	16.27" (413.3)	16.27" (413.3)	16.27" (413.3)
Dimensions – D	–	–	6.37" (161.7) TYP.	6.37" (161.7) TYP.
Dimensions – E	3.50" (88.9)	3.00" (76.2)	3.75" (95.3)	3.25" (82.6)
KO Trade Size: Ends	(2) ½", ¾", 1", 1¼"	(2) ½", ¾", 1"	(2) ½", ¾", 1", 1¼"	(2) ½", ¾", 1"
Sides	(4) ¾", 1", 1¼", 2"*	(4) ½", ¾", 1"	(4) ¾", 1", 1¼", 2"*	(4) ½", ¾", 1"
Bottom	(4) ½", ¾", 1", 1¼"	(4) ½", ¾", (4) 1", 1¼"	(4) ½", ¾", 1", 1¼"	(4) ½", ¾", 1", 1¼"
Cover Style	Rectangular	Rectangular	Round	Round
2 Inch Hub Compatible	Yes	No	Yes	No

Note: UL File Number E31999. Boxes include concrete covers.

*Requires CFBHUB2 for 2" conduits. CFBHUB200PVC for 2" PVC conduits or CFBHUB125PVC for 1¼" PVC conduits.

Rectangular Covers

- Compatible with **CFB2G25**, **CFB2G25CR**, **CFB2G30** and **CFB2G30CR** Series Floor Boxes
- Two large cable egress doors and access 180° opening
- Maximum static load of 800 lbs. with 2x safety factor*
- Surface style typical applications: Carpet, VCT
- Flush style typical applications: Tile, finished concrete and Terrazzo floors
- Furniture Feed covers ship with low voltage dividers

Finish	Surface Cover Dimensions 11 ¹ / ₁₆ in. x 7 ⁷ / ₁₆ in.			Flush Cover Dimensions 10 ¹ / ₁₆ in. x 6 ³ / ₁₆ in.		
	Without Insert	With Insert	Furniture Feed (1 in. and 2 in. Plugs)	Without Insert	With Insert	Furniture Feed (1 in. and 2 in. Plugs)
Aluminum Powder Coat	24GCCVVALU	24GCCVVALUC	24GCFFCVVALU	24GTCVVALU	24GTCVVALUC	24GTFFCVVALU
Black Powder Coat	24GCCVRBK	24GCCVRBKC	24GCFFCVRBK	24GTCVRBK	24GTCVRBKC	24GTFFCVRBK
Brass Powder Coat	24GCCVRBRS	24GCCVRBRSC	24GCFFCVRBRS	24GTCVRBRS	24GTCVRBRSC	24GTFFCVRBRS
Bronze Powder Coat	24GCCVRBRZ	24GCCVRBRZC	24GCFFCVRBRZ	24GTCVRBRZ	24GTCVRBRZC	24GTFFCVRBRZ
Satin Nickel Powder Coat	24GCCVRNK	24GCCVRNKC	24GCFFCVRNK	24GTCVRNK	24GTCVRNKC	24GTFFCVRNK



Aluminum Powder Coat



Black Powder Coat

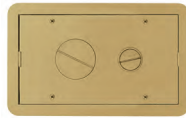

Brass Powder Coat



Bronze Powder Coat



Satin Nickel Powder Coat



Aluminum Powder Coat

6 Inch Round Covers

- Compatible with **CFB2G25R**, **CFB2G25RCR**, **CFB2G30R** and **CFB2G30RCR** Series Floor Boxes
- Cover flanges have a 7½ in. diameter and 0.15 in. height
- Maximum static load of 1,000 lbs. with 2x safety factor*
- Recessed covers- 180° access with 2 cable egress doors
- Furniture Feed covers ship with low voltage dividers



Finish	Flush Surface	Furniture Feed (¾ in. and 2 in. Plugs)
Brushed Aluminum	CFBS1R6CVVALU	CFBS1R6FFCVVALU
Black Powder Coat	CFBS1R6CVRBLK	CFBS1R6FFCVRBLK
Brass Plated	CFBS1R6CVRBRS	CFBS1R6FFCVRBRS
Antique Bronze Plated	CFBS1R6CVRBRZ	CFBS1R6FFCVRBRZ
Gray Powder Coat	CFBS1R6CVRGRY	CFBS1R6FFCVRGRY
Satin Nickel Plated	CFBS1R6CVRNKL	CFBS1R6FFCVRNKL



Note: *Load applied through a 3 in. (76mm) mandrel in center of the cover. See page P5 for round cover finishes.

Dimensions in Inches (mm)

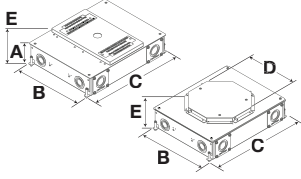
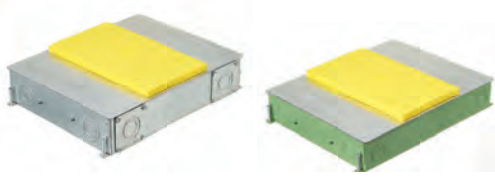
SystemOne Recessed 4-Gang Floor Boxes and Covers, for Use In Concrete Floors

Style	Rectangular Cover		Round Cover	
				
Box Type				
Standard Box	CFB4G30E	CFB4G25E	CFB4G30RE	CFB4G25RE
Corrosion-Resistant (On-grade)	CFB4G30CRE	CFB4G25CRE	CFB4G30RCRE	CFB4G25RCRE
Recommended Pour Depth	3.50" (88.9)	3.00" (76.2)	3.75" (95.3)	3.25" (82.6)
Min. Depth of Pour	3.00" (76.2)	2.50" (63.5)	3.75" (95.3)	3.25" (82.6)
Adjustability	Fully	Fully	Fully	Fully
Cubic Inch (cm ³) Capacity per Gang	51.0 cu. in. (835.0 cm ³)	41.5 cu. in. (680.0 cm ³)	51.0 cu. in. (835.0 cm ³)	41.5 cu. in. (680.0 cm ³)
Dimensions – A	3.00" (76.2)	2.50" (63.5)	–	–
Dimensions – B	11.33" (276.5)	11.20" (284.5)	11.20" (284.5)	11.20" (284.5)
Dimensions – C	14.57" (370.1)	14.57" (370.1)	14.57" (370.1)	14.57" (370.1)
Dimensions – D	–	–	8.37" (212.5) TYP.	8.37" (212.5) TYP.
Dimensions – E	3.50" (88.9)	3.00" (76.2)	3.75" (95.3)	3.25" (82.6)
KO Trade Size: Ends	(4) ½", ¾", 1", 1¼"	(4) ½", ¾", 1"	(4) ½", ¾", 1", 1¼"	(4) ½", ¾", 1"
Sides	(4) ¾", 1", 1¼", 2"	(4) ½", ¾", 1"	(4) ¾", 1", 1¼", 2"	(4) ½", ¾", 1"
Bottom	(4) ½", ¾", 1", 1¼"	(4) ½", ¾", (4) 1", 1¼"	(4) ½", ¾", 1", 1¼"	(4) ½", ¾", (4) 1", 1¼"
Cover Style	Rectangular	Rectangular	Round	Round
2 Inch Hub Compatible	Yes	No	Yes	No

Note: UL File Number E31999. Boxes include concrete covers.

*Requires CFBHUB2 for 2" conduits. CFBHUB200PVC for 2" PVC conduits or CFBHUB125PVC for 1¼" PVC conduits.

Rectangular Covers

- Compatible with **CFB4G25**, **CFB4G25CR**, **CFB4G30** and **CFB4G30CR** Series Floor Boxes
- Two large cable egress doors and access 180° opening
- Maximum static load of 800 lbs. with 2x safety factor*
- Surface style typical applications: Carpet, VCT
- Flush style typical applications: Tile, finished concrete and Terrazzo floors
- Furniture Feed covers ship with low voltage dividers

Finish	Surface Cover dimensions 11 ¹ / ₁₆ in. x 7 ⁷ / ₁₆ in.			Flush Cover dimensions 10 ¹ / ₁₆ in. x 6 ³ / ₁₆ in.		
	Without Insert	With Insert	Furniture Feed (1 in. and 2 in. Plugs)	Without Insert	With Insert	Furniture Feed (1 in. and 2 in. Plugs)
Aluminum Powder Coat	24GCCVRALU	24GCCVRALUC	24GCCFFCVRALU	24GTCVRALU	24GTCVRALUC	24GTCFFCVRALU
Black Powder Coat	24GCCVRBK	24GCCVRBKC	24GCCFFCVRBK	24GTCVRBK	24GTCVRBKC	24GTCFFCVRBK
Brass Powder Coat	24GCCVRBRS	24GCCVRBRSC	24GCCFFCVRBRS	24GTCVRBRS	24GTCVRBRSC	24GTCFFCVRBRS
Bronze Powder Coat	24GCCVRBRZ	24GCCVRBRZC	24GCCFFCVRBRZ	24GTCVRBRZ	24GTCVRBRZC	24GTCFFCVRBRZ
Satin Nickel Powder Coat	24GCCVRNK	24GCCVRNKC	24GCCFFCVRNK	24GTCVRNK	24GTCVRNKC	24GTCFFCVRNK

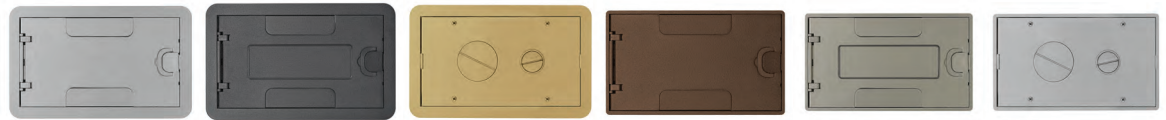

Aluminum Powder Coat Black Powder Coat Brass Powder Coat Bronze Powder Coat Satin Nickel Powder Coat Aluminum Powder Coat

8 Inch Round Covers

- Compatible with **CFB4G25R**, **CFB4G25RCR**, **CFB4G30R**, and **CFB4G30RCR** Series Floor Boxes
- Cover flanges have a 9½ in. diameter and 0.15 in. height
- Maximum static load of 1,000 lbs. with 2x safety factor*
- Recessed covers- 180° access with 2 cable egress doors
- Furniture Feed covers dividers purchased separately

Finish	Flush Surface	Furniture Feed (1 in. and 2 in. Plugs)
Brushed Aluminum	CFBS1R8CVRALU	CFBS1R8FFCVRALU**
Black Powder Coat	CFBS1R8CVRBLK	CFBS1R8FFCVRBLK**
Brass Plated	CFBS1R8CVRBRS	CFBS1R8FFCVRBRS**
Antique Bronze Plated	CFBS1R8CVRBRZ	CFBS1R8FFCVRBRZ**
Gray Powder Coat	CFBS1R8CVRGRY	CFBS1R8FFCVRGRY**
Satin Nickel Plated	CFBS1R8CVRNKL	CFBS1R8FFCVRNKL**



Note: *Load applied through a 3 in. (76mm) mandrel in center of the cover.

** For 4-gang box dual service, **CFBS1R8FF4GDIVKIT** required with Furniture Feed covers. Purchased separately. See page P5 for round cover finishes.

Dimensions in Inches (mm)



SystemOne Recessed 4-Gang Floor Boxes and Covers, for Use In Concrete Floors

Style	PVC Boxes		Cast Iron Boxes	
Box Type				
PVC Base Box (On-grade)	CFB4G30PFBE	CFB4G30PFBRE	-	-
Cast Iron Box (On-grade)	-	-	CFB4G30CI	CFB4G30RCI
Recommended Pour Depth	3.75" (95.3)	4.00 (101.6)	3.75" (95.3)	4.00" (101.6)
Min. Depth of Pour	3.25" (82.6)	4.00 (101.6)	3.25" (82.6)	4.00" (101.6)
Adjustability	Fully	Fully	Fully	Fully
Cubic Inch (cm3) Capacity per Gang	51.0 cu. in. (835.0 cm ³)	51.0 cu. in. (835.0 cm ³)	30.0 cu. in. (491.7 cm ³)	30.0 cu. in. (491.7 cm ³)
Dimensions – A	3.25" (82.6)	-	3.25" (82.6)	-
Dimensions – B	11.20" (284.5)	11.20" (284.5)	11.44" (290.5)	11.44" (290.5)
Dimensions – C	15.70" (398.8)	15.70" (398.8)	13.19" (335.1)	13.19" (335.1)
Dimensions – D	-	8.37" (212.5) TYP.	-	8.37" (212.5) TYP.
Dimensions – E	3.75" (95.3)	4.00 (101.6)	3.75" (95.3)	4.00" (101.6)
KO Trade Size: Ends	-	-	(4) 1½" NPT Thread	(4) 1½" NPT Thread
KO Trade Size: Sides	Requires Drilling Openings. PVC Conduit Only: 1¼" Maximum Size *	Requires Drilling Openings. PVC Conduit Only: 1¼" Maximum Size *	(4) ¾" NPT Thread	(4) ¾" NPT Thread
KO Trade Size: Bottom	Requires Drilling Openings. PVC Conduit Only: 1½" Maximum Size	Requires Drilling Openings. PVC Conduit Only: 1½" Maximum Size	-	-
Cover Style	Rectangular	Round	Rectangular	Round
2 Inch Hub Compatible	Yes	Yes	No	No

Note: UL File Number E31999. Boxes include concrete covers.
*Requires PVC Hubs, CFBHUB200PVC for 2" PVC conduits or CFBHUB125PVC for 1¼" PVC conduits.

Rectangular Covers

- Compatible with **CFB4G25, CFB4G25CR, CFB4G30** and **CFB4G30CR** Series Floor Boxes **CFB4G30PFBE**
- Two large cable egress doors and access 180° opening
- Maximum static load of 800 lbs. with 2x safety factor*
- Surface style typical applications: Carpet, VCT
- Flush style typical applications: Tile, finished concrete and Terrazzo floors
- Furniture Feed covers ship with low voltage dividers

Finish	Surface Cover dimensions 11 ¹¹ / ₁₆ in. x 7 ⁷ / ₁₆ in.			Flush Cover dimensions 10 ¹¹ / ₁₆ in. x 6 ³ / ₁₆ in.		
	Without Insert	With Insert	Furniture Feed (1 in. and 2 in. Plugs)	Without Insert	With Insert	Furniture Feed (1 in. and 2 in. Plugs)
Aluminum Powder Coat	24GCCVRALU	24GCCVRALUC	24GFFCVRALU	24GTCVRALU	24GTCVRALUC	24GFFCVRALU
Black Powder Coat	24GCCVRBK	24GCCVRBK C	24GFFCVRBK	24GTCVRBK	24GTCVRBK C	24GFFCVRBK
Brass Powder Coat	24GCCVRBRS	24GCCVRBRS C	24GFFCVRBRS	24GTCVRBRS	24GTCVRBRS C	24GFFCVRBRS
Bronze Powder Coat	24GCCVRBRZ	24GCCVRBRZ C	24GFFCVRBRZ	24GTCVRBRZ	24GTCVRBRZ C	24GFFCVRBRZ
Satin Nickel Powder Coat	24GCCVRNK	24GCCVRNK C	24GFFCVRNK	24GTCVRNK	24GTCVRNK C	24GFFCVRNK

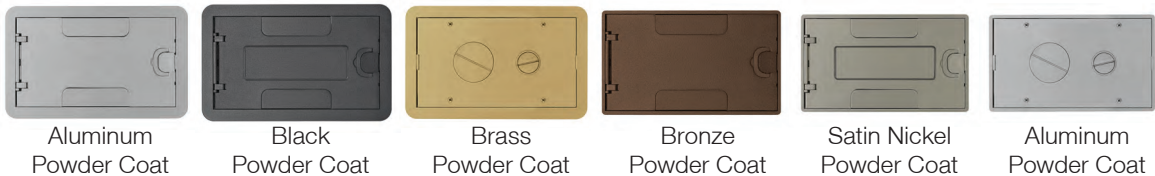

8 Inch Round Covers



- Compatible with **CFB4G25R, CFB4G25RCR, CFB4G30R**, and **CFB4G30RCR** Series Floor Boxes **CFB4G30PFBE**
- Cover flanges have a 9½ in. diameter and 0.15 in. height
- Maximum static load of 1,000 lbs. with 2x safety factor*
- Recessed covers- 180° access with 2 cable egress doors
- Furniture Feed covers dividers purchased separately

Finish	Flush Surface	Furniture Feed (1 in. and 2 in. Plugs)
Brushed Aluminum	CFBS1R8CVRALU	CFBS1R8FFCVRALU**
Black Powder Coat	CFBS1R8CVRBLK	CFBS1R8FFCVRBLK**
Brass Plated	CFBS1R8CVRBRS	CFBS1R8FFCVRBRS**
Antique Bronze Plated	CFBS1R8CVRBRZ	CFBS1R8FFCVRBRZ**
Gray Powder Coat	CFBS1R8CVRGRY	CFBS1R8FFCVRGRY**
Satin Nickel Plated	CFBS1R8CVRNKL	CFBS1R8FFCVRNKL**

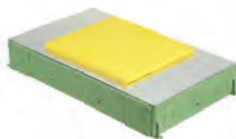

Note: *Load applied through a 3 in. (76mm) mandrel in center of the cover.
** For 4-gang box dual service, **CFBS1R8FF4GDIVKIT** required with Furniture Feed covers. Purchased separately. See page P5 for round cover finishes.
Dimensions in Inches (mm)

SystemOne Recessed 6-Gang Floor Boxes and Covers, for Use In Concrete Floors

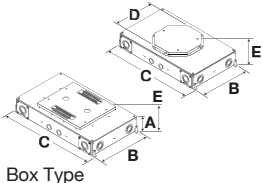
Style	Rectangular Cover		Round Cover	
				
 Box Type				
Standard	CFB6G30E	–	CFB6G30RE	–
Box Corrosion-Resistant Box (On-grade)	–	CFB6G30CRE	–	CFB6G30RCRE
Recommended Pour Depth	3.50" (88.9)	3.50" (88.9)	3.75" (95.3)	3.75" (95.3)
Min. Depth of Pour	3.00" (76.2)	3.00" (76.2)	3.75" (95.3)	3.75" (95.3)
Adjustability	Fully	Fully	Fully	Fully
Cubic Inch (cm3) Ends- Capacity/Gang	108.5 cu. in. (1778 cm ³)	108.5 cu. in. (1778 cm ³)	108.5 cu. in. (1778 cm ³)	108.5 cu. in. (1778 cm ³)
Cubic Inch (cm3) Sides- Capacity/Gang	33.0 cu. in. (510 cm ³)	33.0 cu. in. (510 cm ³)	33.0 cu. in. (510 cm ³)	33.0 cu. in. (510 cm ³)
Dimensions – A	3.00" (76.2)	3.00" (76.2)	3.00" (76.2)	3.00" (76.2)
Dimensions – B	11.54" (293.0)	11.54" (293.0)	11.54" (293.0)	11.54" (293.0)
Dimensions – C	19.68" (499.9)	19.68" (499.9)	19.68" (499.9)	19.68" (499.9)
Dimensions – D	–	–	8.37" (212.5) TYP.	8.37" (212.5) TYP.
Dimensions – E	3.50" (88.9)	3.50" (88.9)	3.75" (95.3)	3.75" (95.3)
KO Trade Size: Ends	(4) 1/2", 3/4", 1", 1 1/4"	(4) 1/2", 3/4", 1", 1 1/4"	(4) 1/2", 3/4", 1", 1 1/4"	(4) 1/2", 3/4", 1", 1 1/4"
Sides	(4) 3/4", 1", 1 1/4", 2", (4) 1/2", 3/4"	(4) 3/4", 1", 1 1/4", 2", (4) 1/2", 3/4"	(4) 3/4", 1", 1 1/4", 2", (4) 1/2", 3/4"	(4) 3/4", 1", 1 1/4", 2", (4) 1/2", 3/4"
Bottom	(4) 1/2", 3/4", 1", 1 1/4", (4) 1/2", 3/4"	(4) 1/2", 3/4", 1", 1 1/4", (4) 1/2", 3/4"	(4) 3/4", 1", 1 1/4", 1 1/2", (4) 1/2", 3/4"	(4) 3/4", 1", 1 1/4", 1 1/2", (4) 1/2", 3/4"
Cover Style	Rectangular	Rectangular	Round	Round
2 Inch Hub Compatible	Yes	Yes	Yes	Yes

Note: UL File Number E31999. Boxes include concrete covers.

*Requires CFBHUB2 for 2" conduits. CFBHUB200PVC for 2" PVC conduits or CFBHUB125PVC for 1 1/4" PVC conduits.

Rectangular Covers

- Compatible with **CFB6G30** and **CFB6G30CR** Series Floor Boxes
- Two large cable egress doors and access 180° opening
- Maximum static load of 1,500 lbs. with 2x safety factor*
- Surface style typical applications: Carpet, VCT
- Flush style typical applications: Tile, finished concrete and Terrazzo floors
- Furniture Feed covers dividers purchased separately

Finish	Surface Cover Dimensions 11 1/2 in. x 10 in.			Flush Cover Dimensions 10 1/2 in. x 9 in.		
	Without Insert	With Insert	Furniture Feed ((2)1 in. and (2) 2 in. Plugs)	Without Insert	With Insert	Furniture Feed ((2)1 in. and (2) 2 in. Plugs)
Aluminum Powder Coat	610GCCVRALU	610GCCVRALUC	610GCFFCVRALU*	610GTCVRALU	610GTCVRALUC	610GTFFCVRALU*
Black Powder Coat	610GCCVRBK	610GCCVRBKC	610GCFFCVRBK*	610GTCVRBK	610GTCVRBKC	610GTFFCVRBK*
Brass Powder Coat	610GCCVRBRS	610GCCVRBRSC	610GCFFCVRBRS*	610GTCVRBRS	610GTCVRBRSC	610GTFFCVRBRS*
Bronze Powder Coat	610GCCVRBRZ	610GCCVRBRZC	610GCFFCVRBRZ*	610GTCVRBRZ	610GTCVRBRZC	610GTFFCVRBRZ*
Satin Nickel Powder Coat	610GCCVRNK	610GCCVRNKC	610GCFFCVRNK*	610GTCVRNK	610GTCVRNKC	610GTFFCVRNK*

Note: * For 6-gang box dual service, **CFB6FFDIVKIT** required with Furniture Feed covers. Purchased separately.



8 Inch Round Covers

- Compatible with **CFB6G30R** and **CFB6G30RCR** Series Floor Boxes
- Cover flanges have a 9 1/2 in. diameter and 0.15 in. height
- Maximum static load of 1,000 lbs. with 2x safety factor*
- Recessed covers- 180° access with 2 cable egress doors
- Furniture Feed covers dividers purchased separately

Finish	Flush Surface	Furniture Feed (1 in. and 2 in. Plugs)
Brushed Aluminum	CFBS1R8CVRALU	CFBS1R8FFCVRALU**
Black Powder Coat	CFBS1R8CVRBLK	CFBS1R8FFCVRBLK**
Brass Plated	CFBS1R8CVRBRS	CFBS1R8FFCVRBRS**
Antique Bronze Plated	CFBS1R8CVRBRZ	CFBS1R8FFCVRBRZ**
Gray Powder Coat	CFBS1R8CVRGRY	CFBS1R8FFCVRGRY**
Satin Nickel Plated	CFBS1R8CVRNKL	CFBS1R8FFCVRNKL**



Note: *Load applied through a 3 in. (76mm) mandrel in center of the cover.

** For 6-gang box dual service, **CFBS1R8FF6DIVKIT** required with Furniture Feed covers.

Purchased separately. See page P5 for round cover finishes.

Dimensions in Inches (mm)

Plates for Use in SystemOne 2, 4 and 6-Gang Floor Boxes

- UL 514A listed

Cat. No.	Plate Style	Cat. No.	Plate Style
FBMPREC ①	(1) Decorater Opening	FBMPDUP ②	(1) Duplex Opening
FBMP139	(1) Simplex Opening 1.40 in. Diameter	FBMP156	(1) Twist-Lock® Opening 1.60 in. Diameter
FBMP6DJ ④	(1) Hubbell Keystone Jack Openings and (4) Jack KOs with Label Field	FBMP6KS ⑤	(1) Opening with Hubbell 6-Port Frame for Keystone Jacks Frame for Keystone Jacks
FBMP15IM	(1) 1.5U Hubbell iStation Opening	FBMP2IM	(2) 1U Hubbell iStation Openings
FBMPBNK ③	1-Gang Blank Plate	FBMPFT	Cable Feed Through with Bushing
FBMPAAP	(2) Extron® AAP Openings	FBMPMAAP	(2) Extron® MAAP Openings
FBMPTRAC	(1) Opening for Tracjack® or Seies II®	FBMPSIEMONCT	Siemon CT Series



①



②



③



④



⑤



⑥

Pre-Wired Device Plates

- Reduces wiring and installation times
- 8 in. stranded leads mounted to the face plate

Description	Type	20A
Duplex, Gray.	Standard Tamper-Resistant	PWFBMP20GRY ⑥ PWFBMP20GRYTR
Decorater, Gray.	Standard Tamper-Resistant	PWFBMPDR20GRY PWFBMPDR20GRYTR
2-Cubes, Single Circuit	Standard Marked Controlled	PWFBMP2R* PWFBMP2RC*
3-Cubes, Single Circuit	Standard Marked Controlled	PWFBMP3R* PWFBMP3RC* ⑦

Note: *Includes Isolated Ground Sticker

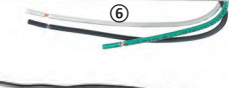

⑥



⑦

Accessories

Description	Catalog Number
(1) 2" threaded zinc hub for use with CFB2G30 , CFB4G30 and CFB6G30 series floor boxes; replaces CFBKOPATE .	CFBHUB2 ⑧
(2) 1-1/4" PVC hubs with reducers for use with CFB2G30 , CFB4G30 and CFB6G30 floor boxes; replaces CFBKOPATE . Reducers includes: (2) 1" Reducers, (2) 3/4" Reducers, and (2) 1/2" Reducers/Plugs.	CFBHUB125PVC
(2) 2" PVC hubs with reducers for use with CFB2G30 , CFB4G30 and CFB6G30 floor boxes; replaces CFBKOPATE . Reducers includes: (2) 1-1/2" Reducers, (2) 1-1/4" Reducers, and (2) 1" Reducers/Plugs.	CFBHUB200PVC ⑨
Replacement knock-out plate.	Standard Epoxy Coating CFBKOPATE CFBKOPATECR
ETERNAL™ Replacement Round Cover Adapter, 2-Gang Floor Box	CFB2GS1R6ADAPTE
ETERNAL™ Replacement Round Cover Adapter, 4-Gang Floor Box	CFB4GS1R8ADAPTE
ETERNAL™ Replacement Round Cover Adapter, 6-Gang Floor Box	CFB6GS1R8ADAPTE
CFB4G box series replacement dividers.	CFB4GDIVKIT
CFB6G box series replacement dividers.	CFB6GEDIVKIT
Stackable ring to increase box height and concrete pour depth by 3/4 in. increments above top plane of floor box. One ring per 3/4 in. depth increase. Must be installed before concrete pour.	2-Gang CFB6RCVRR075
Finished floor height adjustment ring - increase post pour adjustment ; use with round cover series.	4 and 6-Gang CFB8RCVRR075
	2 and 4-Gang CFB6RCVRR1* ⑩ CFB6RCVRR2 CFB6RCVRR3
	6-Gang CFB8RCVRR1** CFB8RCVRR2 CFB8RCVRR3
Rectangular pre-pour 1/2 in. extension caps (2 pack).	24GEXTENDCAP2PK ⑪
Replacement temporary rectangular steel and yellow concrete pre-pour covers	610GTEMPCVR 610GTEMPCVR

Note: *Included with standard **CFB2G30R** and **CFB2G25R** series floor boxes.

Included with standard **CFB4G30R, **CFB4G25R** and **CFB6G30R** series floor boxes.



⑧



⑨



⑩



⑪



⑫



⑬





⑭

Extron® is a registered trademark of Extron Electronics. Crestron® is a registered trademark of Crestron Electronics, Inc. FSR® is a registered trademark of FSR Inc. TracJack®, Series II® and Ortronics® are registered trademarks of Ortronics/Legrand.

Dimensions in Inches (mm)

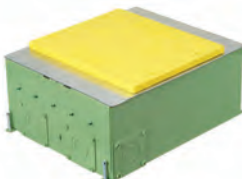
SystemOne Recessed 4/5-Gang Floor Boxes and Covers, for Use In Concrete Floors

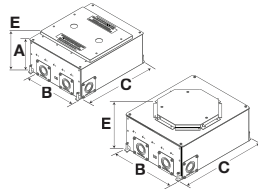
Style	Rectangular Cover		Round Cover	
				
Box Type				
Standard Box	CFB45G55E	–	CFB45G55RE	–
Corrosion-Resistant Box (On-grade)	–	CFB45G55CRE	–	CFB45G55RCRE
Recommended Pour Depth	6.00" (152.4)	6.00" (152.4)	6.25" (158.8)	6.25" (158.8)
Min. Depth of Pour	5.50" (139.7)	5.50" (139.7)	6.25" (158.8)	6.25" (158.8)
Adjustability	Fully	Fully	Fully	Fully
Cubic Inch (cm ³) Capacity per Gang	99/105 cu. in. (1621/1721 cm ³)	99/105 cu. in. (1621/1721 cm ³)	99/105 cu. in. (1621/1721 cm ³)	99/105 cu. in. (1621/1721 cm ³)
Dimensions – A	5.59" (142.0)	5.59" (142.0)	–	–
Dimensions – B	11.09" (281.6)	11.09" (281.6)	11.09" (281.6)	11.09" (281.6)
Dimensions – C	14.14" (359.2)	14.14" (359.2)	14.14" (359.2)	14.14" (359.2)
Dimensions – D	–	–	8.37" (212.5) TYP.	8.37" (212.5) TYP.
Dimensions – E	5.50" (139.7)	5.50" (139.7)	6.25" (158.8)	6.25" (158.8)
KO Trade Size: Ends	(2) ¾", 1", 1¼", 2"	(2) ¾", 1", 1¼", 2"	(2) ¾", 1", 1¼", 2"	(2) ¾", 1", 1¼", 2"
Sides	(2) ¾", 1", 1¼", 2"	(2) ¾", 1", 1¼", 2"	(2) ¾", 1", 1¼", 2"	(2) ¾", 1", 1¼", 2"
Bottom	(2) ½", ¾", 1", 1¼"	(2) ½", ¾", 1", 1¼"	(2) ½", ¾", 1", 1¼"	(2) ½", ¾", 1", 1¼"
Cover Style	Rectangular	Rectangular	Round	Round
2 Inch Hub Compatible	Yes	Yes	Yes	Yes

Note: UL File Number E31999. Boxes include concrete covers.

*Requires CFBHUB2 for 2" conduits. CFBHUB200PVC for 2" PVC conduits or CFBHUB125PVC for 1¼" PVC conduits.

Rectangular Covers

- Compatible with **CFB45G55E** and **CFB45G55CRE**
- Two large cable egress doors and access 180° opening
- Maximum static load of 1,500 lbs. with 2x safety factor*
- Surface style typical applications: Carpet, VCT
- Flush style typical applications: Tile, finished concrete and Terrazzo floors

Finish	Cover Dimensions 11½ in. x 10 in.		Cover Dimensions 10½ in. x 9 in.	
	Surface	Surface with Insert	Flush	Flush with Insert
Aluminum Powder Coat	610GCCVRALU	610GCCVRALUC	610GTCVRALU	610GTCVRALUC
Black Powder Coat	610GCCVRBK	610GCCVRBK C	610GTCVRBK	610GTCVRBK C
Brass Powder Coat	610GCCVRBRS	610GCCVRBRSC	610GTCVRBRS	610GTCVRBRSC
Bronze Powder Coat	610GCCVRBRZ	610GCCVRBRZC	610GTCVRBRZ	610GTCVRBRZC
Satin Nickel Powder Coat	610GCCVRNK	610GCCVRNK C	610GTCVRNK	610GTCVRNK C



Aluminum Powder Coat



Black Powder Coat

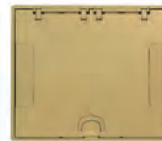

Brass Powder Coat



Bronze Powder Coat



Satin Nickel Powder Coat

8 Inch Round Covers

- Compatible with **CFB45G55RE** and **CFB45G55RCRE**
- Cover flanges have a 9½ in. diameter and 0.15 in. height
- Maximum static load of 1,000 lbs. with 2x safety factor*
- Recessed covers- 180° access with 2 cable egress doors



Finish	Surface
Brushed Aluminum	CFBS1R8CVRALU
Black Powder Coat	CFBS1R8CVRBLK
Brass Plated	CFBS1R8CVRBRS
Antique Bronze Plated	CFBS1R8CVRBRZ
Gray Powder Coat	CFBS1R8CVRGRY
Satin Nickel Plated	CFBS1R8CVRNKL



Note: *Load applied through a 3 in. (76mm) mandrel in center of the cover. See page Q5 for round cover finishes.

Dimensions in Inches (mm)

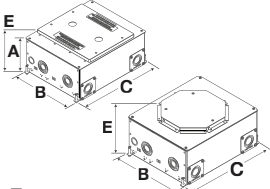
SystemOne Recessed 8⁺/10-Gang Floor Boxes and Covers, for Use In Concrete Floors

Style	Rectangular Cover		Round Cover	
				
Box Type	-		-	
Standard Box	CFB10G55E	-	CFB10G55RE	-
Corrosion-Resistant Box (On-grade)	-	CFB10G55CRE	-	CFB10G55RCRE
Recommended Pour Depth	6.00" (152.4)	6.00" (152.4)	6.25" (158.8)	6.25" (158.8)
Min. Depth of Pour	5.50" (139.7)	5.50" (139.7)	6.25" (158.8)	6.25" (158.8)
Adjustability	Fully	Fully	Fully	Fully
Cubic Inch (cm ³) Capacity per Gang	35.0/69.5/99.0 cu. in. (574/1139/1622 cm ³)	35.0/69.5/99.0 cu. in. (574/1139/1622 cm ³)	35.0/69.5/99.0 cu. in. (574/1139/1622 cm ³)	35.0/69.5/99.0 cu. in. (574/1139/1622 cm ³)
Dimensions - A	5.59" (142.0)	5.59" (142.0)	-	-
Dimensions - B	11.09" (281.6)	11.09" (281.6)	11.09" (281.6)	11.09" (281.6)
Dimensions - C	14.14" (359.2)	14.14" (359.2)	14.14" (359.2)	14.14" (359.2)
Dimensions - D	-	-	8.37" (212.5) TYP.	8.37" (212.5) TYP.
Dimensions - E	5.50" (139.7)	5.50" (139.7)	6.25" (158.8)	6.25" (158.8)
KO Trade Size: Ends	(2) 1/2", 3/4", (4) 1/2", 3/4", 1", 1 1/4", 1 1/2"	(2) 1/2", 3/4", (4) 1/2", 3/4", 1", 1 1/4", 1 1/2"	(2) 1/2", 3/4", (4) 1/2", 3/4", 1", 1 1/4", 1 1/2"	(2) 1/2", 3/4", (4) 1/2", 3/4", 1", 1 1/4", 1 1/2"
Sides	(2) 3/4", 1", 1 1/4", 2 ^{***}	(2) 3/4", 1", 1 1/4", 2 ^{***}	(2) 3/4", 1", 1 1/4", 2 ^{***}	(2) 3/4", 1", 1 1/4", 2 ^{***}
Bottom	(2) 1/2", 3/4", (4) 1/2", 3/4", 1", 1 1/4"	(2) 1/2", 3/4", (4) 1/2", 3/4", 1", 1 1/4"	(2) 1/2", 3/4", (4) 1/2", 3/4", 1", 1 1/4"	(2) 1/2", 3/4", (4) 1/2", 3/4", 1", 1 1/4"
Cover Style	Rectangular	Rectangular	Round	Round
2 Inch Hub Compatible	Yes	Yes	Yes	Yes

Note: ^{**}Requires CFBHUB2 for 2" conduits. CFBHUB200PVC for 2" PVC conduits or CFBHUB125PVC for 1 1/4" PVC conduits.

Rectangular Covers

- Compatible with **CFB10G55** and **CFB10G55CR** Series Floor Boxes
- Two large cable egress doors and access 180° opening
- Maximum static load of 1,500 lbs. with 2x safety factor*
- Surface style typical applications: Carpet, VCT
- Flush style typical applications: Tile, finished concrete and Terrazzo floors
- Furniture Feed covers dividers purchased separately

Finish	Surface Cover Dimensions 11 1/2 in. x 10 in.			Flush Cover Dimensions 10 1/2 in. x 9 in.		
	Without Insert	With Insert	Furniture Feed (2)1 in. and (2) 2 in. Plugs)	Without Insert	With Insert	Furniture Feed (2)1 in. and (2) 2 in. Plugs)
Aluminum Powder Coat	610GCCVVALU	610GCCVVALUC	610GCCFFCVRVALU*	610GTCVVALU	610GTCVVALUC	610GTCFFCVRVALU*
Black Powder Coat	610GCCVRBK	610GCCVRBKC	610GCCFFCVRBK*	610GTCVRBK	610GTCVRBKC	610GTCFFCVRBK*
Brass Powder Coat	610GCCVRBRS	610GCCVRBRSC	610GCCFFCVRBRS*	610GTCVRBRS	610GTCVRBRSC	610GTCFFCVRBRS*
Bronze Powder Coat	610GCCVRBRZ	610GCCVRBRZC	610GCCFFCVRBRZ*	610GTCVRBRZ	610GTCVRBRZC	610GTCFFCVRBRZ*
Satin Nickel Powder Coat	610GCCVRNK	610GCCVRNKC	610GCCFFCVRNK*	610GTCVRNK	610GTCVRNKC	610GTCFFCVRNK*

Note: * For 10-gang box dual service, **CFB10FFDIVKIT** required with Furniture Feed covers. Purchased separately.

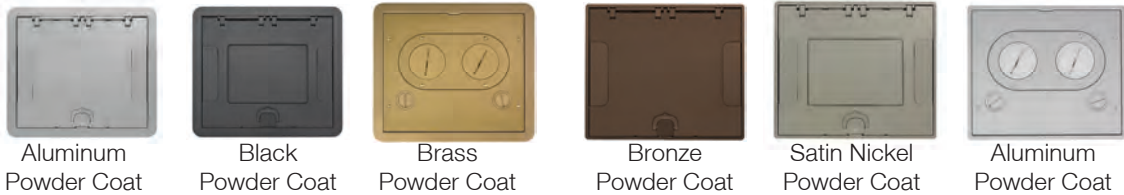

8 Inch Round Covers

- Compatible with **CFB10G55R** and **CFB10G55RCR** Series Floor Boxes
- Two large cable egress doors and access 180° opening
- Maximum static load of 1,000 lbs. with 2x safety factor*
- Recessed covers- 180° access with 2 cable egress doors
- Furniture Feed covers dividers purchased separately

Finish	Flush Surface	Furniture Feed (1 in. and 2 in. Plugs)
Brushed Aluminum	CFBS1R8CVRALU	CFBS1R8FFCVRALU[#]
Black Powder Coat	CFBS1R8CVRBLK	CFBS1R8FFCVRBLK[#]
Brass Plated	CFBS1R8CVRBRS	CFBS1R8FFCVRBRS[#]
Antique Bronze Plated	CFBS1R8CVRBRZ	CFBS1R8FFCVRBRZ[#]
Gray Powder Coat	CFBS1R8CVRGRY	CFBS1R8FFCVRGRY[#]
Satin Nickel Plated	CFBS1R8CVRNKL	CFBS1R8FFCVRNKL[#]



Note: *Load applied through a 3 in. (76mm) mandrel in center of the cover.

[#]For 10-gang box dual service, **CFBS1R8FF10GDIVKIT** required with Furniture Feed covers. Purchased separately. See page P5 for round cover finishes

[†]UL File Number E31999. Boxes include concrete covers. FB10MPNEMA2XG and/or FB10MPNEMA4G for 8-gang configuration.

Dimensions in Inches (mm)

Plates for Use in SystemOne 4/5 & 8*/10-Gang Floor Boxes

- UL 514A listed

Cat. No.	Plate Style	Cat. No.	Plate Style
FB10MPREC ①	(1) Decorator Opening	FB10MPDUP ②	(1) Duplex Opening
FB10MPBNK	1-Gang Blank Plate	FB10MPKEY	(1) Opening with Hubbell 6-Port Frame for Keystone Jacks Frame for Keystone Jacks
FB10MPTRAC	(2) Openings for (6) Ortronics TracJack®	FB10MPFT	Cable Feed Through with Bushing
Cat. No	Two Gang Plate Style	Cat. No	Two Gang Plate Style
FB10MP2A ③	Decorator Openings	FB10MP2E ④	Duplex Openings
FB10TLX	(1) Simplex Opening 1.40 in. Diameter	FB10TLA	(1) Twist-Lock® Opening 1.60 in. Diameter
FB10MP2B	(6) 1U Hubbell iStation Modules	FB10MPMAAP	Siemon CT Series
FB10MPAAP	(4) Extron® AAP Openings		
Cat. No	Three Gang Plate Style	Cat. No	Three Gang Plate Style
FB10TLY	(2) Simplex Opening 1.40 in. Diameter	FB10TLB	(3) Twist-Lock® Opening 1.60 in. Diameter
FB10MP3GAPP ⑤	(1) Opening for Appliance Receptacle, requires 2-Gang industry plate for trim out		
Cat. No	Five Gang Plate Style	Cat. No	Five Gang Plate Style
FB10TLC	(3) Simplex Opening 1.40 in. Diameter	FB10TLZ	Twist-Lock® Opening 1.60 in. Diameter
FB10MPNEMA2XG ⑥	(2) 2-Gang. Meets NEMA Spacing. Ideal for Crestron® DM –TX Product and Power. Ships with Low Voltage Divider.	FB10MPNEMA4G ⑦	(4) Single Service Openings Utilizing NEMA Wallplate. (No Low Voltage Divider Option)

Note: *Use with FB10MPNEMA2XG and/or FB10MPNEMA4G for 8-gang configuration.

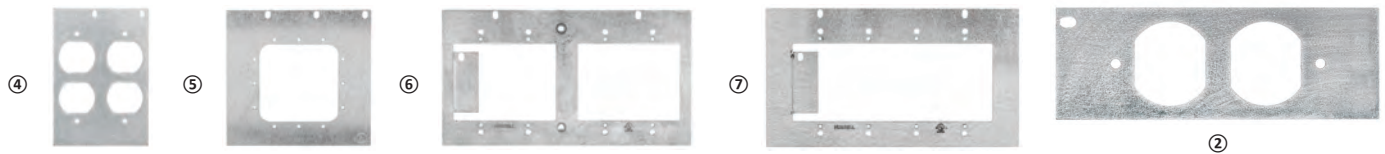

Pre-Wired Device Plates

- Reduces wiring and installation times
- 8 inch stranded leads mounted to the face plate

Description	Type	20A
Duplex, Gray.	Standard Tamper-Resistant	PWFB10MPCR20GRY ⑧ PWFB10MPCR20GRYTR
Decorator, Gray.	Standard Tamper-Resistant	PWFB10MPDR20GRY ⑨ PWFB10MPDR20GRYTR

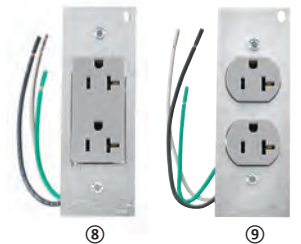

Accessories

Description	Catalog Number
(1) 2" threaded zinc hub for use with CFB45G55 and CFB10G55 series floor boxes; replaces CFBKOPLATE .	CFBHUB2
(2) 1-1/4" PVC hubs with reducers for use with CFB45G55 and CFB10G55 series floor boxes; replaces CFBKOPLATE . Reducers include: (2) 1" reducer, (2) 3/4" reducers, and (2) 1/2" Reducer/Plugs.	CFBHUB125PVC
(2) 2" PVC hubs with reducers for use with CFB45G55 and CFB10G55 series floor boxes; replaces CFBKOPLATE . Reducers include: (2) 1-1/2" reducers, (2) 1-1/4" reducers, and (2) 1" Reducer/Plugs.	CFBHUB200PVC ⑩
Replacement knock-out plates.	Standard Epoxy Coating CFBKOLATE CFBKOPATECR
ETERNAL™ Replacement Round Cover Adapter, 10-gang Floor Box	CFB4510GS1R8ADAPTE
Stackable ring to increase box height and concrete pour depth by 3/4 in. increments above top plane of floor box. One ring per 3/4 in. depth increase. Must be installed before concrete pour.	CFB8RCVRR075
Finished floor height adjustment ring - increase post pour adjustment ; use with round cover series.	0 - 1/4 in. 1/4 in. - 1/2 in. 1/2 in. - 3/4 in. CFB8RCVRR1* CFB8RCVRR2 ⑪ CFB8RCVRR3
Rectangular pre-pour 1/2 in. extension caps (2 pack).	610GEXTENDCAP2PK ⑫
Replacement temporary rectangular steel and yellow concrete pre-pour covers	610GTEMPCVR
Replacement spacer around wire-way.	FB10MPX
Replacement divider.	FB4510GDIV



Note: *Included with standard **CFB45G55R** and **CFB10G55R** series floor boxes.

Extron® is a registered trademark of Extron Electronics. Crestron® is a registered trademark of Crestron Electronics, Inc. FSR® is a registered trademark of FSR Inc. TracJack®, Series II® and Ortronics® are registered trademarks of Ortronics/Legrand.

Dimensions in Inches (mm)

The Next Big Step In Innovation

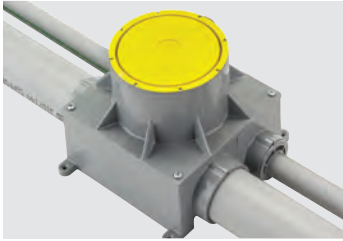

Locate installation area and connect conduits

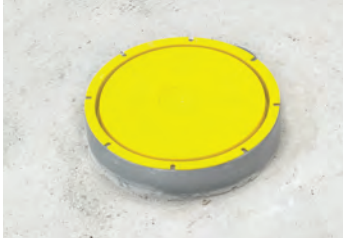

Pour concrete



Cut box top level with concrete



Install flooring



Install Adjustable Mounting Cup and level with finished flooring
CFBS1R4CUP



Wire devices into box



Finish with cover
CFBS1R4CVR

Installing the Fully Adjustable Mounting Cup and Level with Finished Flooring

During a concrete pour installation a floor box can become buried, other times the thickness of the floor covering can change. We have solved these issues with the integral, patented, adjustable mounting cup which adjusts the device mounting depth to 3 inches to accommodate any plug, no matter the floor thickness. Additionally, this is helpful for engineered flooring on the concrete; the adjustable mounting cup allows for post pour upwards adjustment of up to 1½ inches.

Recessed and Furniture Feed Activation is available with all 4 Inch Recessed Floorboxes by selecting the correct adjustable mounting cup for the application.



Recessed Activation



Non-Metallic Adjustable 4 inch Floor Box



Finish with cover **S1R4FFCVR**



Furniture Feed Activation

Features and Benefits

SystemOne Fully Adjustable 4 inch Recessed Floor Boxes and Covers, for Use In Concrete Floors

The Hubbell SystemOne Fully Adjustable Recessed floor box is the next step in a long line of quality products delivering power, data and AV for any application. The challenge of a recessed adjustable floor box is the device depth would vary for different floor thicknesses, other times the floor box can become buried in the concrete pour. We have solved these issues with the integral, patented, mounting cup which adjusts the device mounting depth to 3 inches to accommodate any plug, no matter the floor thickness. Additionally, this is helpful for engineered flooring on the concrete; the adjustable mounting cup allows for post pour upwards adjustment of up to 1½ inches. This feature is particularly accommodating when the final flooring is unknown at the time concrete is being poured.

Utilizing the same cover design as our 4 Inch Recessed Fire-Rated Poke-Throughs, a common look is now possible anywhere in a building, on grade or above grade.

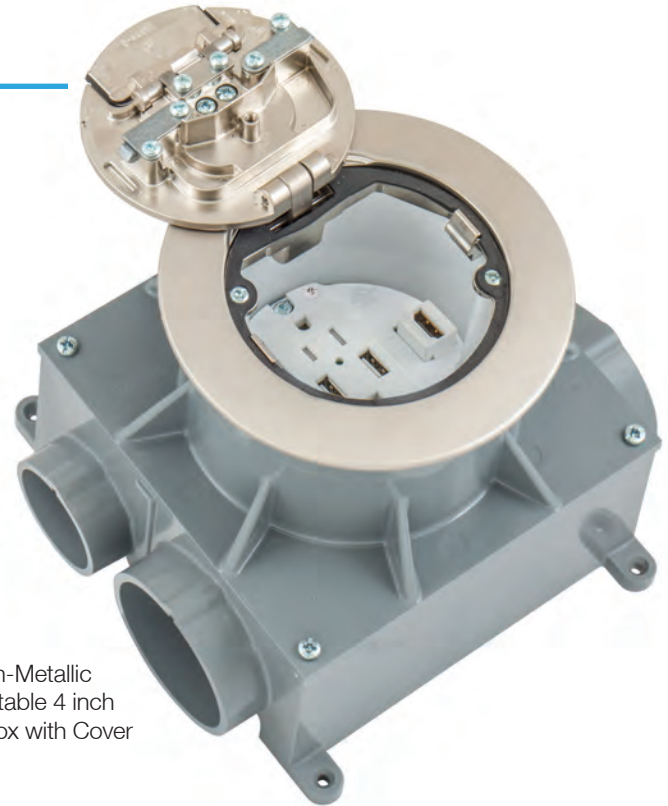

Non-Metallic
Adjustable 4 inch
Floor Box with Cover



Box Design

- Up to 2 inch conduit ready (Cast iron maximum conduit - 1½ inches)
- Available in PVC, stamped steel, epoxy coated stamped steel or cast iron construction available
- cULus Listed - Scrubwater compliant



Covers

- Durable die-cast aluminum
- 1,000 lbs, static load rated cover
- Available in six architectural finishes
- Low profile flange, 0.15 inch exceeds ADA requirements
- 5.50" diameter flange



Adjustable Mounting Cups

- 3 inch deep access chamber
- Patented post pour adjustable mounting cup with teeth spaced in 5/32 inch increments allows for up to 1½ inches of upward adjustability from the lowest position, ideal for engineered flooring
- High visibility white cup for making easy connections



Easy Mount Device Plates

- Recessed connections
- Single service or dual service
- Multiple, open architecture mounting plates for power, data and AV



2 Inch Conduit Ready





- To meet expanding AV and data needs, the Hubbell SystemOne Recessed Floor Box line readily accepts 2 inch conduits with the use of a 2 inch threaded conduit hub - CFBHUB2 Sold Separately

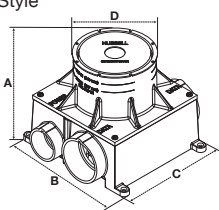
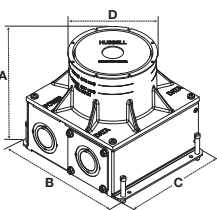

Furniture Feed Cover Design

- Compatible with recessed covers
- Seamless one piece cast aluminum design
- (1) ¾ inch threaded hub for power
- (1) 1½ inch threaded hub for low voltage
- 0.15" flange height, 5.50" diameter flange

SystemOne Fully Adjustable 4 inch Recessed Floor Boxes and Covers, for Use In Concrete Floors

Style	Cast Iron / Non-Metallic	Stamped Steel	Cast Iron	Corrosion-Resistant	Stamped Steel	Non-Metallic
						
	Cast Iron / Non-Metallic	Stamped Steel	CFBS1R4CFB	CFBS1R4SFBCR	CFBS1R4SFB	CFBS1R4PFB
Min. Depth of Pour			5.00" (127.0)	5.00" (127.0)	5.00" (127.0)	5.00" (127.0)
Max. Pour Depth			6.00" (152.4)	6.00" (152.4)	6.00" (152.4)	6.00" (152.4)
Cubic Inch (cm ³) Capacity			72.0 cu. in. (1180 cm ³)	80.0 cu. in. (1311 cm ³)	80.0 cu. in. (1311 cm ³)	67.0 cu. in. (1098 cm ³)
Dimensions – A			6.00" (152.4)	6.00" (152.4)	6.00" (152.4)	6.00" (152.4)
Dimensions – B			7.60" (193.0)	7.40" (188.0)	7.40" (188.0)	7.85" (199.4)
Dimensions – C			6.58" (167.1)	6.32" (160.6)	6.32" (160.6)	6.45" (163.8)
Dimensions – D			4.60" (116.8)	4.60" (116.8)	4.60" (116.8)	4.60" (116.8)
Power Entries			(2) 1" NPT Thread	(2) ¾", 1", 1¼"	(2) ¾", 1", 1¼"	(2) ½", ¾", 1", 1¼"
Data Entries			(2) 1½" NPT Thread	(2) ¾", 1", 1¼", 2"	(2) ¾", 1", 1¼", 2"	(2) 1", 1¼", 1½", 2"
Concrete Cover Included			✓	✓	✓	✓
Closure Plugs Included			✓	–	–	✓
Reducers			–	–	–	✓
CFBS1R4xx Cover Family			✓	✓	✓	✓
Compatible with CFBHUB2 - 2" Conduit Fitting			–	✓	✓	–

Note: UL File Number E92074.
CSA File Number LR18416.
*Requires CFBHUB2 for 2" conduits.

Adjustable Mounting Cup - Required, Purchased Separately

The Adjustable Mounting Cup (AMC) is the heart of the **CFBS1R4** Floor Box product line, and must be **purchased separately** from the floor boxes. With teeth spaced in $\frac{5}{32}$ inch increments, the adjustable cup allows for installation ease and flexibility. The AMC is dropped into the floor box collar then rotated clockwise to set the height and is adjustable until the ground plate is installed. Once the ground plate is installed, the cup is locked into place preventing unwanted adjustment of height. Lastly, the device mounting plate and electrical devices are installed.



Description	Recessed Activation Catalog Number	Furniture Feed Activation Catalog Number
Adjustable Mounting Cup Includes white mounting cup, low voltage dividers and ground plate.	CFBS1R4CUP Floor boxes purchased independently from cup	CFBS1R4FFCUP Floor boxes purchased independently from cup



Dimensions in Inches (mm)

SystemOne Fully Adjustable 4 inch Recessed Floor Boxes and Covers, for Use In Concrete Floors

Floor Box Covers









The 4 inch recessed cover is available in a number of durable, yet beautiful finishes to match any décor. The flange height of 0.15 inch is ADA compliant and suitable for use on any floor finish. All covers are UL 514A listed and meet UL Scrubwater requirements.

Features

- Flange diameter is 5.5 inches
- Flange thickness is 0.15 inches thick and complies with ADA requirements
- Cover load rating is 1,000 lbs. with 2x safety factor* for a static load applied through a 3 inch mandrel
- Available in six finishes
 - Satin nickel, antique bronze and brushed brass are plated finishes
 - Brushed aluminum is the base material brushed and lacquered
 - Black and gray finishes are powder coat



Device Mounting Plates

Description / Catalog Number	Sub-plate	Description / Catalog Number	Sub-plate	Description / Catalog Number	Sub-plate
2X2 Sub-plate with (1) decorator device opening and (2) keystone jack openings S1R4SP2X2STYLE		(1) Style Line® decorator device opening for power or datacom applications S1R4SPSTYLE		2X2 Sub-plate with (1) decorator device opening and (2) Ortronics® TracJack® openings S1R4SP2X2STYLETJ	
2X2 Sub-plate with (1) duplex device opening and (2) keystone jack openings S1R4SP2X2DUPLEX		(1) Duplex device opening for power or datacom applications S1R4SPDUPLEX		2X2 Sub-plate with (1) duplex device opening and (2) Ortronics® TracJack® openings S1R4SP2X2DUPLEXTJ	
(4) Single 20A receptacles. Can be wired as single or two circuit with isolated ground capability, 12 inch wire leads Includes ⚡ stickers. S1R4SPQUAD		(1) 1.60 inch opening for 20 or 30A Twist-Lock® receptacle S1R4SPTWIST		(1) 1.40 inch opening for simplex receptacle S1R4SPSIMPLEX	

Architectural Cover Finishes

Finish	Recessed Activation	Furniture Feed Activation
Brushed Aluminum	CFBS1R4CVRALU	S1R4FFCVRALU
Black Powder Coat	CFBS1R4CVRBLK	S1R4FFCVRBLK
Brushed Brass Plated	CFBS1R4CVRBRS	S1R4FFCVRBRS
Antique Bronze Plated	CFBS1R4CVRBRZ	S1R4FFCVRBRZ
Gray Powder Coat	CFBS1R4CVRGRY	S1R4FFCVRGRY
Plated Satin Nickel	CFBS1R4CVRNKL	S1R4FFCVRNKL

Note: *Load applied through a 3 in. (76mm) mandrel in center of the cover.



Accessories and Replacement Parts

Description	Catalog Number
Allows the conduit connections for the low voltage portion of the CFBS1R4SFB and CFBS1R4SFCR to be increased to 2 inch capacity. The offset design helps to minimize conduit float during the concrete pour.	CFBHUB2
Set of conduit reducing adapters for use with the CFBS1R4PFB . Includes two each 1, 3/4 and 1/2 inch of the following adapters to reducing to the corresponding conduit diameter. 1 1/2, 1 1/4 and 1 inch	CFBADAPT125 CFBADAPT200
Replacement low voltage partition for use in all four CFBS1R4 series floor boxes.	CFBS1R4DIV
Replacement ground bracket for use in all four CFBS1R4 series floor boxes.	CFBS1R4GND
Replacement pre-pour concrete yellow cover for use with all four of the CFBS1R4 series floor boxes.	CFBS1R4COVER
Abandonment plate, black finish, for all CFBS1R4 series floor boxes.	S1R4CFBADMTBK
Pre-pour PVC stand increases CFBS1R4PFB box height 2.5 in. to 4.0 in. within the concrete pour.	PFBSTANDGY



TracJack®, Series II® and Ortronics® are registered trademarks of Ortronics/Legrand.

Floor Boxes

Products at a Glance

Flush Floor Box Applications feature unique capabilities of Hubbell's SystemOne universal cover and sub-plate design, Hubbell has expanded its floor box offering to provide industry leading flexibility while accommodating an extensive range of applications. Hubbell SystemOne is constructed to give customers the ability to create personal solutions for their most demanding, power, data and audio/video requirements.

SystemOne Flush Floor Box Applications...



Multi-Service Applications

This Hubbell SystemOne sub-plate incorporates a standard Style Line® decorator opening, which can be used for an active multimedia device. In addition, a 20A outlet is supplied for power and two keystone openings for voice/data services.



Multimedia Applications

Other Hubbell SystemOne sub-plates are designed to meet the growing needs of the audio/video market. Some sub-plates provide power outlets with Hubbell's AV products including 15-pin SVGA, RCA, S-Video, 3.5mm stereo, HDMI and XLR microphone jacks. Other sub-plates can accommodate Extron® Electronics MAAP and AAP series AV modules, as well as FSR IPS plates.



4X4 Applications

Provides maximum power capacity for flush, multi-service applications. This sub-plate features a pre-wired four outlet 20A, 125V receptacle and four openings for flush mount Hubbell modular jacks and audio/video Snap Fit connectors. Receptacle wiring permits dual-circuit, as well as isolated ground applications.

Traditional Floor Boxes...

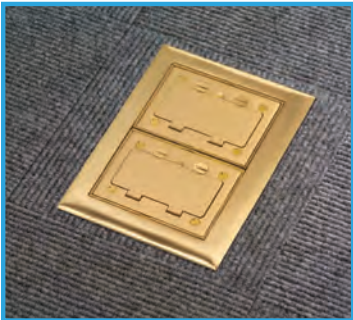

Flush Applications

Hubbell offers a wide variety of traditional solutions including single and multi-gang cast iron, stamped steel and non-metallic floor boxes in both round and rectangular designs. These boxes can be finished with either brass or aluminum covers and flanges to match any office décor. All Hubbell floor box assemblies exceed UL scrubwater exclusion requirements.

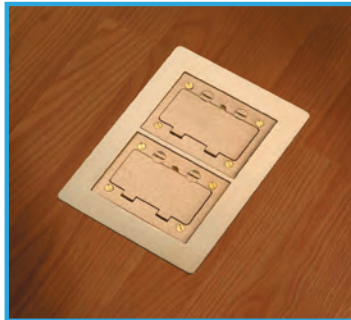

Wooden Floor Applications

Hubbell offers round, single service and rectangular, multi-service floor boxes for wooden floor applications. The rectangular boxes are available in one, two and three-gang options and feature removable barriers for maximum capacity while maintaining separation of power and low voltage. A variety of covers and flanges are available in brushed aluminum or brass to meet aesthetic requirements.

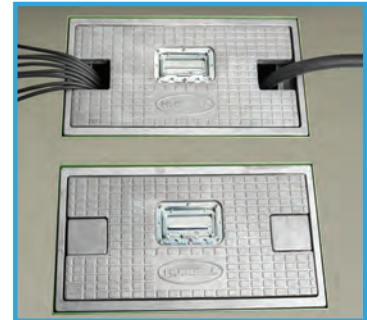

Heavy Load Rating

For environments where floor boxes will be subjected to extreme loads, Hubbell offers two different solutions. The Ballroom Box series has a static cover load rating of 20,000 lbs. and can accommodate up to 8 devices. The Convention Center family offers a static cover load rating of 32,000 lbs. and can accommodate up to 100A Pin and Sleeve devices.

Extron® is a registered trademark of Extron Electronics.

SystemOne Flush Floor Box Family

Cast Iron

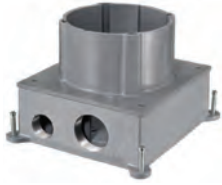

- Corrosion resistant for on-grade applications
- Oversized 1½" NPT threaded conduit access holes for low voltage
- 1" NPT threaded conduit access holes for power

Steel

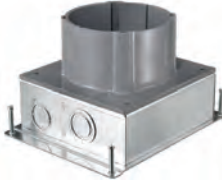

- Stamped steel construction
- Economical and light weight for above-grade applications
- Concentric knockouts permit various conduit sizes for both power and data services



Steel AV



- Accommodates high-capacity multimedia applications in a 3½" minimum depth of pour
- Oversized 1½" NPT threaded data hub
- ¾", 1" concentric knockouts for power services



Features

- Easily installed, aesthetic and configurable floor box solution, for open floor plans that require both power and data services
- The Hubbell SystemOne Universal Cover mounts directly to the floor box riser, eliminating the need for an additional adapter collar
- The Hubbell SystemOne Universal Cover features ScrubShield® technology that exceeds UL514 scrubwater exclusion requirements
- Convenient cubic inch capacity (cm3) markings on interior of box
- Leveling feet provide before pour adjustability
- Non-metallic riser allows a simple saw cut for adjustment after pour
- Supplied with concrete cover and closure plugs (where applicable)
- Designed to accommodate multi-service applications with the wide offering of Hubbell SystemOne sub-plates
- Hubbell SystemOne Metal Floor Boxes are approved for use in the City of Chicago
- CR versions incorporate fusion bonded epoxy paint for on grade use

Non-Metallic



- Non-corrosive plastic construction
- Oversized 1½" data conduit hub for increased cable capacity and bend radius
- Parallel conduit hubs reduce labor and material cost, facilitating easier wire pull

Features

- Economical, easy to install, in-floor delivery system for open plan spaces
- The Hubbell SystemOne Universal Cover mounts directly to the floor box riser, eliminating the need for an additional adapter collar
- Concrete cover, conduit reducers and conduit hub plugs included

SystemOne Flush Covers

Universal Flange and Cover Assembly

Carpet



Tile



- Hinged doors open 180° flush to the carpet flange or tile
- Locking studs allow each door to be secured independently
- The universal carpet or tile flange can be used for Hubbell SystemOne Floor Boxes and Fire-Rated Poke-Throughs
- Finishes and colors available:



Aluminum Finish



Brass Finish



Black



Gray



Ivory

Features

- Durable cast aluminum construction available in black, gray, brass, aluminum and ivory powder coat finishes
- Features ScrubShield® technology that exceeds UL514 scrubwater exclusion requirements
- Provides consistent look and maximum functionality throughout the installed life
- Meets ADA standards for accessible design

SystemOne Flush Sub-Plates

Hubbell's modular sub-plate design allows users to economically upgrade Hubbell SystemOne FRPT and Floor Boxes to accommodate future moves, adds and changes. See page O-20 for additional information.

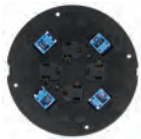

4x4 Sub-Plate



Datacom and Power Sub-Plate



Extron® AAP/MAAP and Power Sub-Plate



Dual Style Line® Decorator Sub-Plate



Twist-Lock® Sub-Plate



Furniture Feed Cover, Carpet

Features

- Durable cast aluminum construction, powder coat finish
- Hubbell 4X4: four 20A, 125V receptacles, four keystone openings for voice/data jacks and flush multimedia connectors
- Hubbell X-END and Hubbell iSTATION modular connectivity
- Accommodates Extron® Electronics Architectural Series audio/video system integration products
- Accommodates GFCI, USB, surge and standard Style Line® Decorator receptacles
- Twist-Lock® receptacle with two flush keystone openings
- Large capacity and multi-service furniture feed applications
- Open system sub-plates permit maximum data flexibility

Power Devices and Connectivity



Hubbell-PRO Receptacles



20A USB Receptacles



Hubbell iSTATION

Features

- Choose from Hubbell's industry leading selection of wiring devices for power services
- Hubbell iSTATION connectivity modules integrate with SystemOne to provide comprehensive multimedia solutions

Extron® is a registered trademark of Extron Electronics.

SystemOne Flush Metal and Non-Metallic Floor Boxes, for Use In Concrete Floors

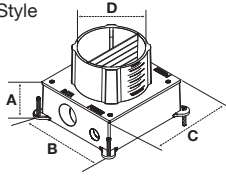
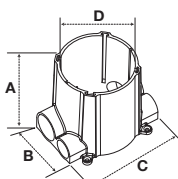

Style			Cast Iron	Steel	Steel AV	Non-Metallic
Standard Corrosion-Resistant (On-grade)			– S1CFB*	S1SFB* S1SFBGR	S1SFBVAV* S1SFBVAVGR	S1PFB –
Min. Depth of Pour			3.50" (88.9)	3.50" (88.9)	3.50" (88.9)	3.00" (76.2)
Adjustability			Fully	Fully	Fully	Fully
Cubic Inch (cm ³) Capacity			156.0 cu. in. (2556 cm ³)	175.7 cu. in. (2879 cm ³)	177.5 cu. in. (2909 cm ³)	100 cu. in. (1638 cm ³)
Dimensions – A			3.00" (76.2)	3.00" (76.2)	3.00" (76.2)	6.00" (152.4)
Dimensions – B			7.00" (177.8)	6.75" (171.4)	6.75" (171.4)	5.58" (141.7)
Dimensions – C			7.38" (187.3)	7.38" (187.3)	7.38" (187.3)	7.08" (179.8)
Dimensions – D (Inside Diameter)			5.00" (127.0)	5.00" (127.0)	5.00" (127.0)	5.00" (127.0)
Power Entries			(2) 1" NPT Thread	(2) ¾", 1"	(2) ¾", 1"	(2) ¾", 1"
Data Entries			(2) 1½" NPT Thread	(2) ¾", 1", 1¼"	(2) 1½" NPT Thread	(2) ¾", 1", 1¼", 1½"
Concrete Cover Included			✓	✓	✓	✓
Closure Plugs Included			✓	–	✓	✓
Accepts Hubbell SystemOne Universal Cover			✓	✓	✓	✓
Cover Mounting Clips Included			✓	✓	✓	✓
Non-Metallic Low Voltage Divider Included (S1DIV1)			✓	✓	✓	✓

Note: UL File Number E92074.

*S1CFB, S1SFB, S1SFBVAV are approved for use in the City of Chicago.





SystemOne Universal Covers

- Cast aluminum construction
- Durable powder coat finish

Color	 Carpet	 Tile
Aluminum Finish	S1CFCAL	S1TFCAL
Brass Finish	S1FCBRS	S1TFCBRS
Black	S1FCBBL	S1TFCBBL
Gray	S1FCGGY	S1TFCGGY
Ivory	S1FCFI	S1TFCFI



Floor Box Accessories

Description	Color	Catalog Number
Abandonment Plates Used to cover abandoned SystemOne Fire-Rated Poke-Throughs or Floor Boxes.	Black Gray	 S1AP4BL S1AP4GY
Replacement Side by Side Divider Used to isolate compartments in S1SP, S1SPFFx, S1SPFFTx, S1SPDU, S1SPDUSL, S1SPDU2IM and S1SPSL2IM sub-plates. Included with all SystemOne Floor Boxes.		 S1DIV1
1½" Threaded Hub For use with S1SFBVAV ONLY. Permits feed-through applications. S1SFBVAV floor box includes one (1) threaded hub.		 S1AVHUB15
Replacement Universal Cover Mounting Clips Used to mount SystemOne Universal Cover to SystemOne metal and non-metallic floor boxes (S1CFB, S1SFB, S1SFBVAV, S1PFB).		 S1FBCLIP5PK
Pre-pour PVC stand increases S1PFB box height 2.5 in. to 4.0 in. within the concrete pour.		 PFBSTANDGY

Dimensions in Inches (mm)

SystemOne Flush Sub-Plates

Description	Catalog Number	Description	Catalog Number	Description	Catalog Number
Style Line® Decorator/GFCI (2) Style Line® decorator openings for power and/or datacom applications. Non-Metallic Metal	S1SP	Duplex/Duplex (2) Duplex openings for power and/or datacom applications. Non-Metallic Metal	S1SPDU	Duplex/Style Line® Decorator (1) Duplex and (1) Style Line® decorator opening for power and/or datacom applications. Non-Metallic Metal	S1SPDUSL
Hubbell 4 X 4 (4) 20A, 125V receptacles. (4) Keystone openings for Hubbell jacks or flush AV connectors. Power can be wired as single or two circuit with isolated ground capability. Includes stickers.	S1SP4X4	Carpet Furniture Feed Cover/Flange* (1) 3/4" and (1) 1 1/2" NPT access holes for power and/or datacom applications. Universal Cover not required. Includes carpet flange. Non-Metallic Aluminum Fin. Metal Brass Finish Black Gray	S1SPFFAL S1SPFFBRS S1SPFFBL S1SPFFGY	Tile Furniture Feed Cover/Flange* (1) 3/4" and (1) 1 1/2" NPT access holes for power and/or datacom applications. Universal Cover not required. Includes tile flange. Non-Metallic Aluminum Fin. Metal Brass Finish Black Gray	S1SPFFTAL S1SPFFTBR S1SPFFTBL S1SPFFTGY
Single Receptacle + Data Opening for 20 or 30A Twist-Lock® receptacle (1.56" OD) and (2) Keystone openings for Hubbell jacks or flush AV connectors. 	S1SPTL	Hubbell DataCom + Power (1) 20A, 125V receptacle and 3-unit recessed Hubbell iSTATION opening for data, voice, and AV applications. Marked with "Controlled"	S1SP3IM S1SP3IMC	Hubbell DataCom + Duplex (1) Duplex opening, (2) flush Keystone openings and 1.5 unit recessed Hubbell iSTATION opening for data, voice and AV applications. 	S1SPDU2IM
Hubbell DataCom + Style Line® Decorator (1) Style Line® decorator opening, (2) flush Keystone openings and 1.5 unit recessed Hubbell iSTATION opening for data, voice and AV applications. 	S1SPSL2IM	Hubbell DataCom 1 unit flush Hubbell iSTATION opening and 3-unit recessed Hubbell iSTATION opening for data, voice, and AV applications. 	S1SP4IM	Active Multimedia + Power Single 20A, 125V receptacle; (2) flush Keystone openings; (1) rectangular Style Line® decorator opening to accommodate active multimedia modules or low voltage outlet frames. Marked with "Controlled"	S1SPAMM20 S1SPAMM20C
Extron® or FSR + Power (1) 20A, 125V receptacle. Recessed opening for (3) single Extron® MAAP series adapter plates or FSR IPS plates. Marked with "Controlled"	S1SPEXT1	Extron® or FSR + Power (1) 20A, 125V receptacle. Recessed opening for (1) single Extron® MAAP and (2) single AAP series adapter plates or FSR IPS plates. Marked with "Controlled"	S1SPEXT2	Extron® or FSR Single-Service Recessed opening for (2) single Extron® MAAP and (2) single AAP series adapter plates or FSR IPS plates. 	S1SPEXT3
Extron® AAP + Power (1) 20A, 125V receptacle. (2) flush Keystone & recessed opening for (2) single Extron® AAP Series adapter plates. Marked with "Controlled"	S1SPEXT4	Ortronics Series II® + Power (1) 20A, 125V receptacle. Recessed opening for (3) 1 unit Ortronics Series II® modules. Marked with "Controlled"	S1SPORT	Ortronics TracJack® + Power (1) 20A, 125V receptacle. Recessed bezel for (6) Ortronics TracJack® modules. Marked with "Controlled"	S1SPTRAC S1SPTRACC
Panduit Mini Com® 4 X 4 (4) 20A, 125V receptacles. (4) Openings for Panduit Mini-Com Connectivity. Includes stickers.	S1SP4X4PA S1SP4X4PAC	SYSTIMAX® 4 X 4 (4) 20A, 125V receptacles. (4) Openings for SYSTIMAX® Connectivity. Includes stickers.	S1SP4X4SYS S1SP4X4SYS	Siemon MAX® + Power (1) 20A, 125V receptacle. Recessed bezel for (6) Siemon MAX® modules. Marked with "Controlled"	S1SPMAX S1SPMAXC

Note: *Furnished with two screws in flexible metal conduit connectors.

Signifies minimum depth of concrete pour in inches for Metal Floor Boxes (**S1CFB**, **S1SFB** and **S1SFBV**) and Non-Metallic Floor Box (**S1PFB**).

Sub-Plate Accessories

Description	Color	
Replacement Threaded Conduit Plugs Used with S1SPFFx and S1SPFFT only. Sub-plate is supplied with plugs.		
	1 1/2" Plug	3/4" Plug
Aluminum Finish	S1FP15AL	S1FP34AL
Brass Finish	S1FP15BRS	S1FP34BRS
Black	S1FP15BL	S1FP34BL
Gray	S1FP15GY	S1FP34GY

Description	Catalog Number
Replacement for S1SPMAX . Sub-plate is supplied with data frame. Works with Siemon MAX®.	S1DFMAX
Replacement for S1SPTRAC sub-plate. Sub-plate is supplied with data frame. Works with Ortronics TracJack®.	S1DFTRAC
Blank Style Line® decorator frame, Black.	NS620BK
2-Port Style Line® decorator frame, Black.	ISF2BK
4-Port Style Line® decorator frame, Black.	ISF4BK
6-Port Style Line® decorator frame, Black.	ISF6BK



Extron® is a registered trademark of Extron Electronics. MAX® is a registered trademark of The Siemon Company. Mini-Com® and Panduit® are registered trademarks of Panduit Corp. SYSTIMAX® is a registered trademark of CommScope, Inc. TracJack®, Series II® and Ortronics® are registered trademarks of Ortronics/Legrand.

SystemOne Flush Configuration Chart			Floor Boxes						4" Core Hole Fire-Rated Poke-Throughs		
			Non-Metallic	Metal							
Approved for use in the City of Chicago. (except S1PFB)											
Sub-Plates			S1PFB	S1CFB	S1SFB	S1SFBCR	S1SFBAV	S1SFBAVCR	S1PTFIT	S1PT4X4FIT	S1PTAVFIT
S1SP	Style Line® Decorator/GFCI		3	3.5	3.5	3.5	3.5	3.5	✓+	✗	✓
S1SPDU	Duplex/Duplex		3	3.5	3.5	3.5	3.5	3.5	✓+	✗	✓
S1SPDUSL	Duplex/Style Line® Decorator		3	3.5	3.5	3.5	3.5	3.5	✓+	✗	✓
S1SP4X4 S1SP4X4PA S1SP4X4SYS	Hubbell 4 X 4 Panduit Mini-Com® 4 X 4 SYSTIMAX® 4 X 4		4	4	4	4	4	4	✗	✓+	✗
S1SP4X4C S1SP4X4PAC S1SP4X4SYSC	Marked with "Ⓢ Controlled"										
S1SPTL	Twist-Lock® Receptacle + Data		4	4	4	4	4	4	✗	✓+	✗
S1SP3IM	Hubbell DataCom + Power		5	5	5	5	5	5	✓	✗	✓+
S1SP4IM	Hubbell DataCom		3.5	3.5	3.5	3.5	3.5	3.5	✓	✗	✓+
S1SPDU2IM	Hubbell DataCom + Duplex		5	5	5	5	5	5	✓	✗	✓+
S1SPSL2IM	Hubbell DataCom + Style Line® Decorator		5	5	5	5	5	5	✓	✗	✓+
S1SPFFxx (Carpet)	Furniture Feed Cover/Flange (Replace "xx" with BRS (Brass finish), AL (Aluminum finish), BL (Black) or GY (Gray).		3	3.5	3.5	3.5	3.5	3.5	✓	✗	✓+
S1SPFFTxx (Tile)											
S1SPEXT1	Extron® or FSR + Power		4	4	4	4	4	4	✓	✗	✓+
S1SPEXT1C	Marked with "Ⓢ Controlled"										
S1SPEXT2	Extron® or FSR + Power		4	4	4	4	4	4	✓	✗	✓+
S1SPEXT2C	Marked with "Ⓢ Controlled"										
S1SPEXT3	Extron® or FSR Single-Service		4.5	4.5	4.5	4.5	4.5	4.5	✓	✗	✓+
S1SPEXT4	Extron® or FSR + Power		4	4	4	4	4	4	✓	✗	✓+
S1SPEXT4C	Marked with "Ⓢ Controlled"										
S1SPORT	Ortronics Series II® + Power		5	5	5	5	5	5	✓	✗	✓+
S1SPORTC	Marked with "Ⓢ Controlled"										
S1SPTRAC	Ortronics TracJack® + Power		5	5	5	5	5	5	✓	✗	✓+
S1SPTRACC	Marked with "Ⓢ Controlled"										
S1SPMAX	Siemon MAX® + Power		5	5	5	5	5	5	✓	✗	✓+
S1SPMAXC	Marked with "Ⓢ Controlled"										
S1SPAMM20	Active Multimedia + Flush Keystone + Power		5	5	5	5	5	5	✓	✗	✓+
S1SPAMM20C	Marked with "Ⓢ Controlled"										
S1CFCxx (Carpet)	SystemOne Floor Boxes and FRPTs use SystemOne Universal Covers (Replace "xx" with BRS (Brass finish), AL (Aluminum finish), BL (Black) or GY (Gray).		Signifies minimum depth of concrete pour in inches for Hubbell SystemOne Floor Boxes.						✓+	✓	✗
S1TFCxx (Tile)									Recommended Floor Fitting	Alternative Floor Fitting	Not Compatible

Extron® is a registered trademark of Extron Electronics. MAX® is a registered trademark of The Siemon Company. Mini-Com® and Panduit® are registered trademarks of Panduit Corp. SYSTIMAX® is a registered trademark of CommScope, Inc. TracJack®, Series II® and Ortronics® are registered trademarks of Ortronics/Legrand.

Flush Round Single or Multi-Service Non-Metallic Floor Boxes, for Use In Concrete Floors

Min. Depth of Pour	3.00" (76.2)
Cubic Inch (cm ³) Capacity	100 cu. in. (1638.7 cm ³) prior to cutting level to floor (19.5 cu. in. (313.2 cm ³) per inch of depth).
Dimensions – A	6.00" (152.4)
Dimensions – B	7.08" (179.8)
Dimensions – C	6.69" (169.9)
Dimensions – D	5.38" (136.5)
Hubs	(2) 1" and (2) 3/4" Conduit Hubs
Concrete Cover Included	✓
Closure/Reducer Plugs	(2) 1" plugs close off 1" hubs or reduce 1" to 3/4" (2) 3/4" plugs close off 3/4" hubs or reduce 3/4" to 1/2"

Description	Catalog Number
Adapter Required for all applications.	PFBA1A
Low Voltage Divider Required for use with catalog number PFB1 when used in multi-service applications. Accepts Hubbell standard duplex receptacles or 15A Twist-Lock® duplex receptacles (HBL4700 series).	PFBT1A
"Y" Adapter 3/4 in. "Y" adapter to feed parallel runs of 3/4 in. conduit.	PFBYA1
Pre-pour PVC stand increases PFB1 box height 2.5 in. to 4.0 in. within the concrete pour.	PFBSTANDGY

Note: UL File Number E92074. CSA File Number LR18416.

Flush Round Covers and Flanges†

Multi-Service Cover and Flange Assemblies
Includes floor box cover with duplex flaps, (2) 1/2 in. dia. low voltage feed through holes and matching carpet flange. 6.25 in. Diameter

SF39253A	PFBCBRA	PFBCBLA	PFBCGYA	PFBCIA
Brass	Brown Non-Metallic	Black Non-Metallic	Gray Non-Metallic	Ivory Non-Metallic

Metal Carpet Flange

Use with single service covers for carpet applications. 6.25 in. Diameter

S3082	SA3082
Brass	Brushed Aluminum

Adapter Ring

Use with single service covers for tile applications.

S5016	SA5016
Brass	Aluminum

Multi-Service Replacement Covers

Material	Metallic	Color	Non-metallic
Solid Brass	BRS2RCA	Black Brown Gray Ivory	PFBRCBLA PFBRCBRA PFBRCGYA PFBRCIA

Single Service Covers†

Brass	S3925	S3725	S2525	S2725	S2925	S3525	S3325	S3913
Aluminum	SA3925	SA3725	SA2525	SA2725	SA2925	—	—	SA3913
3.88 in. Dia.								
	Duplex Flap	Duplex Screw	2 1/8" x 3/4" Combination	2 1/8" x 1" Combination	2 1/8" Single Receptacle	2 3/8" Single Receptacle	2 1/8" Single Receptacle (Terrazzo Floor)	Blank

One Piece Brass Cover and Carpet Flange†

Brass	SF3925*	SFB3926**	SF2525*	SF2725*	SF2925*
Aluminum	SFA3925*	SFA3926	—	—	—
6.25 in. Dia.					
	Duplex Flap	Style Line® Decorator Opening	2 1/8" x 3/4" Combination	2 1/8" x 1" Combination	2 1/8" Single Receptacle

*Note: Adapter ring S5016 is required for mounting SF series covers onto PFBA1A.





**Note: brass plated aluminum

Furniture Feed Plate

Unpainted plate with 1 in. threaded opening.	PFBP1
	Steel

†COVER LOAD RATING; Metallic covers and flanges 2,000 lbs. with 2x safety factor, Non-metallic covers and flanges 300 lbs. Load applied through a 3 in. (76) mandrel at the center of the cover.

Flush Round Single Service Metal Floor Boxes, for Use In Concrete Floors

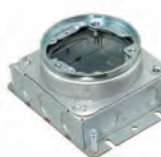
Style	Cast Iron			Stamped Steel	
					
Catalog Numbers	FB2536	FB2537	FB2546	FB2527	FB2529
Cover Frame Material	Steel	Steel	Steel	Steel	Steel
Min. Depth of Pour	3.25" (82.6)	3.00" (76.2)	3.75" (95.3)	4.00" (101.6)	3.00" (76.2)
Adjustability	Fully	Fully	Fully	Fully	Fully
Before Pour External Height Adjustment	1.25" (31.8)	1.25" (31.8)	–	1.25" (31.8)	1.25" (31.8)
After Pour Internal Height Adjustment	.50" (12.7)	.50" (12.7)	.625" (15.9)	.50" (12.7)	.50" (12.7)
Cubic Inch (cm ³) Capacity	33.0 (540.8)	30.0 (491.7)	36.0 (590.0)	54.0 (884.9)	37.3 (611.2)
Dimensions – A	3.12" (79.1)	2.87" (72.8)	3.61" (91.6)	3.80" (96.4)	2.82" (71.5)
Dimensions – B	4.85" (123.2)	4.85" (123.2)	5.00" (126.9)	4.81" (122.2)	4.81" (122.2)
Dimensions – C	4.85" (123.2)	4.85" (123.2)	–	6.00" (152.4)	6.00" (152.4)
Dimensions – D	4.21" (106.8)	4.21" (106.8)	4.21" (106.8)	4.21" (106.8)	4.21" (106.8)
Threaded Hubs	(4) 1"	(4) ¾"	(4) 1"	–	–
Knockouts – Sides	–	–	–	(2) 3/4", 1", 1-1/4"	(2) ½" & (1) ¾"
Knockouts – Ends	–	–	–	(2) 3/4", 1", 1-1/4"	(1) ½" & (1) ¾"
Knockouts – Bottom	–	–	–	(2) 3/4", 1", 1-1/4"	(2) 3/4", 1", 1-1/4"
Concrete Cover Included	✓	✓	✓	✓	✓
Closure Plugs Included	✓	✓	✓	–	–
1" to 3/4" Threaded Reducer	2 Each	–	2 Each	–	–

Note: Suitable for single service applications only. UL File Number E31999. CSA File Number LR18416.

Cover Adapter Ring, Flush Application

Required for tile or finished concrete applications.



Brass



Aluminum

Carpet Flanges, Surface Applications

Required for carpet and surface applications.

6.25 in. Dia.

5.25 in. Dia.



Brushed Brass



Brushed Aluminum

Single Service Covers†

Brass
Aluminum
3.88 in. Dia.



Duplex Flap



Duplex Screw



2 1/8" x 3/4" Combination



2 1/8" x 1" Combination



2 1/8" Single Receptacle



2 3/8" Single Receptacle



2 1/8" Single Receptacle (Terrazzo Floor)



Blank

One Piece Brass Cover and Carpet Flange†

Brass
Aluminum
6.25 in. Dia.



Duplex Flap



Style Line® Decorator Opening



2 1/8" x 3/4" Combination



2 1/8" x 1" Combination

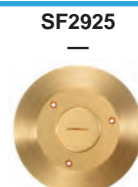

2 1/8" Single Receptacle

*Note: brass plated aluminum

†COVER LOAD RATING; Metallic covers and flanges 2,000 lbs. with 2x safety factor, Non-metallic covers and flanges 300 lbs. Load applied through a 3 in. (76) mandrel at the center of the cover.

Dimensions in Inches (mm)

Flush Rectangular Non-Metallic Floor Boxes with Non-Metallic Covers, for Use In Concrete Floor

Style	1-Gang	2-Gang	3-Gang
	<p>PFBRG1*</p>	<p>PFBRG2</p>	<p>PFBRG3</p>
Min. Depth of Pour	3.00" (76.2)	3.00" (76.2)	3.00" (76.2)
Adjustability	Fully	Fully	Fully
Cubic Inch (cm ³) Capacity per Gang	14.3 cu. in. (234.3 cm ³) per 1" depth	14.3 cu. in. (234.3 cm ³) per 1" depth	14.3 cu. in. (234.3 cm ³) per 1" depth
Dimensions – A	6.00" (152.4)	6.00" (152.4)	6.00" (152.4)
Dimensions – B	3.60" (91.4)	6.80" (172.7)	10.04" (255.0)
Dimensions – C	5.47" (138.9)	5.47" (138.9)	5.47" (138.9)
Dimensions – D	6.90" (175.3)	6.90" (175.3)	6.90" (175.3)
Dimensions – E	5.41" (137.4)	8.56" (221.4)	11.75" (298.4)
Hubs	(4) 1¼"	(6) 1¼"	(8) 1¼"
Reducers	(4) 1" to ¾" and (4) 1¼" to 1"	(6) 1" to ¾" and (6) 1¼" to 1"	(8) 1" to ¾" and (8) 1¼" to 1"
Concrete Cover Included	✓	✓	✓
Closure Plugs Included	✓	✓	✓
Low Voltage Barrier**	–	(1) Removable	(2) Removable

Note: UL File Number E92074.

*Suitable for single service applications only.

**Replacement low voltage barriers, 5 pack, catalog number PFBRGLVDPK5

Flush Rectangular Non-Metallic Covers and Flanges*

Required Components for Carpet Applications

Carpet Flanges				Cover with Duplex and Style Line® decorator inserts included
Number of Gangs	1-Gang	2-Gang	3-Gang	One Required per Gang
Dimensions	6.00" x 4.88"	6.00" x 8.13"	6.00" x 11.35"	4.15" x 2.97"
Black	PFBRFBL1	PFBRFBL2	PFBRFBL3	PFBR826BLA
Brown	PFBRFBR1	PFBRFBR2	PFBRFBR3	PFBR826BRA
Gray	PFBRFGY1	PFBRFGY2	PFBRFGY3	PFBR826GYA
Ivory	PFBRFI1	PFBRFI2	PFBRFI3	PFBR826IA
				<p>Cover Duplex Insert Style Line® Decorator Insert</p>

Required Components for Tile Applications

Mounting Collar		Cover Frame	Cover with Duplex and Style Line® decorator inserts included
One Required per Gang		One Required per Gang	One Required per Gang
		Dim. 4.47" x 3.25"	4.15" x 2.97"
PFBRMC	PFBRFRA	PFBR826GYA	
		<p>Cover Duplex Insert Style Line® Decorator Insert</p>	

Note: *Flush rectangular non-metallic covers and flanges are UL listed only. Not CSA certified. COVER LOAD RATING; Non-metallic covers and flanges 300 lbs. Load applied through a 3 in. (.76) mandrel at the center of the cover.

Dimensions in Inches (mm)

Flush Rectangular Non-Metallic Floor Boxes with Metal Covers, for Use In Concrete Floor

Style	1-Gang	2-Gang	3-Gang
	<p>PFBRG1*</p>	<p>PFBRG2</p>	<p>PFBRG3</p>
Min. Depth of Pour	3.00" (76.2)	3.00" (76.2)	3.00" (76.2)
Adjustability	Fully	Fully	Fully
Cubic Inch (cm ³) Capacity per Gang	14.3 cu. in. (234.3 cm ³) per 1" depth	14.3 cu. in. (234.3 cm ³) per 1" depth	14.3 cu. in. (234.3 cm ³) per 1" depth
Dimensions – A	6.00" (152.4)	6.00" (152.4)	6.00" (152.4)
Dimensions – B	3.60" (91.4)	6.80" (172.7)	10.04" (255.0)
Dimensions – C	5.47" (138.9)	5.47" (138.9)	5.47" (138.9)
Dimensions – D	6.90" (175.3)	6.90" (175.3)	6.90" (175.3)
Dimensions – E	5.41" (137.4)	8.56" (221.4)	11.75" (298.4)
Hubs	(4) 1¼"	(6) 1¼"	(8) 1¼"
Reducers	(4) 1" to ¾" and (4) 1¼" to 1"	(6) 1" to ¾" and (6) 1¼" to 1"	(8) 1" to ¾" and (8) 1¼" to 1"
Concrete Cover Included	✓	✓	✓
Closure Plugs Included	✓	✓	✓
Low Voltage Barrier**	–	(1) Removable	(2) Removable

Note: UL File Number E92074.

*Suitable for single service applications only.

**Replacement low voltage barriers, 5 pack, catalog number PFBRGLVDPK5

Flush Rectangular Metal Covers and Flanges

Required Components for Flush Tile Applications

Adapter Collar (One required per gang)	Adapter Frame with Grounding Wire (One required per gang) Dim. 4.36" x 3.20" x 0.30"
Gray PFBRAC	Brass S5017GR Aluminum SA5017GR

Flush Rectangular Metal Covers and Flanges

Required Components for Flat Flange Applications

Adapter Collar (One required per gang)	
Gray PFBRAC	

Flat Flanges*

Flat Flange Height 0.125"

	1-Gang Dimensions 6.00" x 4.85"	2-Gang Dimensions 6.00" x 8.13"	3-Gang Dimensions 6.00" x 11.34"
Brass, square edge	SB3083W	SB3084W	SB3085W
Aluminum, square edge	SA3083W	SA3084W	SA3085W
Brass, beveled edge	SB3083WB	SB3084WB	SB3085WB
Aluminum, beveled edge	SA3083WB	SA3084WB	SA3085WB

*Flange applications; square edge for carpet and recessed, beveled edge for use on hard finished surfaces







Covers – One Required per Gang[†]

	S3825 SA3825	S3625 SA3625	S3625TR SA3625TR	S3826 SA3826	S2425 SA2425	S2625 SA2625	S2825 —	S3425 —	S3813 SA3813
Brass									
Aluminum									
Dimensions 4.15" x 2.99"									
	Duplex Flap	Duplex Screw	Tamper Resistant Duplex Screw	Style Line® Decorator Opening	2½" x ¾" Combination	2½" x 1" Combination	2½" Single Receptacle	2½" Single Receptacle	Blank

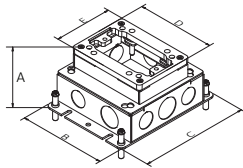
[†]COVER LOAD RATING; Metallic covers and flanges 2,000 lbs. with 2x safety factor Load applied through a 3 in. (76) mandrel at the center of the cover.

Dimensions in Inches (mm)

Flush Rectangular Cast Iron Floor Boxes with Metal Covers, for Use In Concrete Floors

Style	Cast Iron					
	1-Gang Deep	2-Gang Deep	3-Gang Deep	1-Gang Shallow	2-Gang Shallow	3-Gang Shallow
						
Catalog Numbers	FB4133*	FB4233	FB4333	FB4114*	FB4214	FB4314
Cover Frame Material	Thermoplastic	Thermoplastic	Thermoplastic	Thermoplastic	Thermoplastic	Thermoplastic
Min. Depth of Pour	3.50" (95.3)	3.50" (95.3)	3.50" (95.3)	2.00" (50.8)	2.00" (50.8)	2.00" (50.8)
Adjustability	Fully	Fully	Fully	Semi	Semi	Semi
Before Pour External Height Adjustment	1.25" (31.8)	1.25" (31.8)	1.25" (31.8)	1.25" (31.8)	1.25" (31.8)	1.25" (31.8)
After Pour Internal Height Adjustment	.875" (22.2)	.875" (22.2)	.875" (22.2)	–	–	–
Cubic Inch (cm3) Capacity per Gang	33.0 (540.8)	36.5 (598.2)	36.5 (598.2); 34.8 (570.3) center gang	16.0 (262.2)	16.0 (262.2)	16.0 (262.2)
Dimensions – A	3.42" (87.0)	3.40" (86.4)	3.40" (86.4)	2.03" (51.4)	2.05" (51.9)	2.06" (52.2)
Dimensions – B	4.85" (123.2)	4.91" (124.7)	4.91" (124.7)	5.66" (143.7)	5.46" (138.7)	5.46" (138.7)
Dimensions – C	4.85" (123.2)	8.13" (206.5)	11.41" (289.8)	4.38" (111.3)	7.50" (190.4)	10.71" (272.0)
Dimensions – D	4.32" (109.7)	4.32" (109.7)	4.32" (109.7)	4.32" (109.7)	4.32" (109.7)	4.32" (109.7)
Dimensions – E	3.20" (81.3)	6.42" (163.0)	9.64" (244.8)	3.20" (81.3)	6.42" (163.0)	9.64" (244.8)
Threaded Hubs	(4) 1"	(6) 1"	(8) 1"	(4) ¾"	(4) ¾"	(6) ¾"
Concrete Cover Included	✓	✓	✓	✓	✓	✓
Closure Plugs Included	✓	✓	✓	✓	✓	✓
1" to 3/4" Threaded Reducer	2 Each	4 Each	4 Each	–	–	–
Low Voltage Barrier	–	(1) Removable	(2) Removable	–	Non-Removable	Non-Removable

Note: UL File Number E92074. CSA File Number LR18416. *Suitable for single service applications only.

Flush Rectangular Covers Flanges

Required Components for Flush Tile or Finished Concrete Applications

Brass **S5017GR** Adapter Frame with Grounding Wire (One required per gang) Dim. 4.36" x 3.20" x 0.30"
Aluminum **SA5017GR**



Flat Flanges*





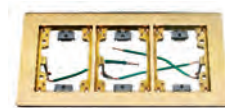



Flat Flange Height 0.125"

	1-Gang Dimensions 6.00" x 4.85"	2-Gang Dimensions 6.00" x 8.13"	3-Gang Dimensions 6.00" x 11.34"
Brass, square edge	SB3083W	SB3084W	SB3085W
Aluminum, square edge	SA3083W	SA3084W	SA3085W
Brass, beveled edge	SB3083WB	SB3084WB	SB3085WB
Aluminum, beveled edge	SA3083WB	SA3084WB	SA3085WB



*Flange applications; square edge for carpet and recessed, beveled edge for use on hard finished surfaces







Covers – One Required per Gang[†]

	S3825	S3625	S3625TR	S3826	S2425	S2625	S2825	S3425	S3813
Brass	SA3825	SA3625	SA3625TR	SA3826	SA2425	SA2625	—	—	SA3813
Aluminum									
Dimensions 4.15" x 2.99"									
	Duplex Flap	Duplex Screw	Tampor Resistant Duplex Screw	Style Line [®] Decorator Opening	2 1/8" x 3/4" Combination	2 1/8" x 1" Combination	2 1/8" Single Receptacle	2 3/8" Single Receptacle	Blank

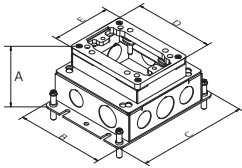
[†]COVER LOAD RATING; Metallic covers and flanges 2,000 lbs. with 2x safety factor. Load applied through a 3 in. (.76) mandrel at the center of the cover.

Dimensions in Inches (mm)

Flush Rectangular Cast Iron Floor Boxes with Non-Metallic Covers, for Use In Concrete Floors

Style	Cast Iron					
	1-Gang Deep	2-Gang Deep	3-Gang Deep	1-Gang Shallow	2-Gang Shallow	3-Gang Shallow
						
Catalog Numbers	FB4133*	FB4233	FB4333	FB4114*	FB4214	FB4314
Cover Frame Material	Thermoplastic	Thermoplastic	Thermoplastic	Thermoplastic	Thermoplastic	Thermoplastic
Min. Depth of Pour	3.50" (95.3)	3.50" (95.3)	3.50" (95.3)	2.00" (50.8)	2.00" (50.8)	2.00" (50.8)
Adjustability	Fully	Fully	Fully	Semi	Semi	Semi
Before Pour External Height Adjustment	1.25" (31.8)	1.25" (31.8)	1.25" (31.8)	1.25" (31.8)	1.25" (31.8)	1.25" (31.8)
After Pour Internal Height Adjustment	.875" (22.2)	.875" (22.2)	.875" (22.2)	–	–	–
Cubic Inch (cm ³) Capacity per Gang	33.0 (540.8)	36.5 (598.2)	36.5 (598.2); 34.8 (570.3) center gang	16.0 (262.2)	16.0 (262.2)	16.0 (262.2)
Dimensions – A	3.42" (87.0)	3.40" (86.4)	3.40" (86.4)	2.03" (51.4)	2.05" (51.9)	2.06" (52.2)
Dimensions – B	4.85" (123.2)	4.91" (124.7)	4.91" (124.7)	5.66" (143.7)	5.46" (138.7)	5.46" (138.7)
Dimensions – C	4.85" (123.2)	8.13" (206.5)	11.41" (289.8)	4.38" (111.3)	7.50" (190.4)	10.71" (272.0)
Dimensions – D	4.32" (109.7)	4.32" (109.7)	4.32" (109.7)	4.32" (109.7)	4.32" (109.7)	4.32" (109.7)
Dimensions – E	3.20" (81.3)	6.42" (163.0)	9.64" (244.8)	3.20" (81.3)	6.42" (163.0)	9.64" (244.8)
Threaded Hubs	(4) 1"	(6) 1"	(8) 1"	(4) ¾"	(4) ¾"	(6) ¾"
Concrete Cover Included	✓	✓	✓	✓	✓	✓
Closure Plugs Included	✓	✓	✓	✓	✓	✓
1" to 3/4" Threaded Reducer	2 Each	4 Each	4 Each	–	–	–
Low Voltage Barrier	–	(1) Removable	(2) Removable	–	Non-Removable	Non-Removable

Note: UL File Number E92074. CSA File Number LR18416. *Suitable for single service applications only.

Flush Rectangular Non-Metallic Covers and Flanges*

Required Components for Carpet Applications				Cover with Duplex and Style Line [®] decorator inserts included
Carpet Flanges				One Required per Gang 4.15" x 2.97"
Number of Gangs	1-Gang 6.00" x 4.88"	2-Gang 6.00" x 8.13"	3-Gang 6.00" x 11.35"	
Black	MFBRFBL1	MFBRFBL2	MFBRFBL3	PFBR826BLA
Brown	MFBRFBR1	MFBRFBR2	MFBRFBR3	PFBR826BRA
Gray	MFBRFGY1	MFBRFGY2	MFBRFGY3	PFBR826GYA
Ivory	MFBRFI1	MFBRFI2	MFBRFI3	PFBR826IA

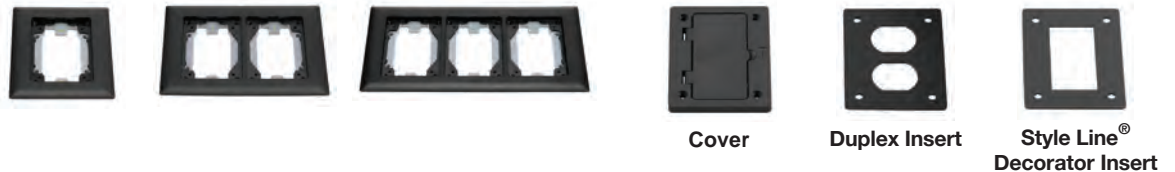

Note: *Flush rectangular non-metallic covers and flanges are UL listed only. Not CSA certified. COVER LOAD RATING; Non-metallic covers and flanges 300 lbs. Load applied through a 3 in. (76) mandrel at the center of the cover.

Dimensions in Inches (mm)

Flush Rectangular Stamped Steel Floor Boxes with Metal Covers, for Use In Concrete Floors

Style	Stamped Steel					
	1-Gang Deep	2-Gang Deep	3-Gang Deep	1-Gang Shallow	2-Gang Shallow	3-Gang Shallow
Catalog Numbers	FB2431*	FB2432	FB2433	FB2421*	FB2422	FB2423
Cover Frame Material	Thermoplastic	Thermoplastic	Thermoplastic	Thermoplastic	Thermoplastic	Thermoplastic
Min. Depth of Pour	3.75" (95.3)	3.75" (95.3)	3.75" (95.3)	2.75" (69.9)	2.75" (69.9)	2.75" (69.9)
Adjustability	Fully	Fully	Fully	Fully	Fully	Fully
Before Pour External Height Adjustment	1.25" (31.8)	1.25" (31.8)	1.25" (31.8)	1.25" (31.8)	1.25" (31.8)	1.25" (31.8)
After Pour Internal Height Adjustment	.50" (12.7)	.50" (12.7)	.50" (12.7)	.50" (12.7)	.50" (12.7)	.50" (12.7)
Cubic Inch (cm ³) Capacity per Gang	54.0 (884.9)	52.8 (865.2)	50.8 (832.5)	37.3 (611.2)	35.0 (573.5)	34.0 (557.2); 35.0 (573.5) center gang
Dimensions – A	3.73" (94.7)	3.73" (94.7)	3.73" (94.7)	2.75" (69.8)	2.75" (69.8)	2.75" (69.8)
Dimensions – B	4.81" (122.2)	4.81" (122.2)	4.81" (122.2)	4.81" (122.2)	4.81" (122.2)	4.81" (122.2)
Dimensions – C	6.00" (152.4)	9.25" (235.0)	12.50" (317.5)	6.00" (152.4)	9.25" (235.0)	12.50" (317.5)
Dimensions – D	4.32" (109.7)	4.32" (109.7)	4.32" (109.7)	4.32" (109.7)	4.32" (109.7)	4.32" (109.7)
Dimensions – E	3.20" (81.3)	6.42" (163.0)	9.64" (244.8)	3.20" (81.3)	6.42" (163.0)	9.64" (244.8)
Knockouts – Sides	(2) 3/4", 1", 1-1/4"	(4) 3/4", 1", 1-1/4"	(6) 3/4", 1", 1-1/4"	(1) 1/2" & (1) 3/4"	(8) 1/2", 3/4"	(12) 1/2", 3/4"
Knockouts – Ends	(2) 3/4", 1", 1-1/4"	(2) 3/4", 1", 1-1/4"	(2) 3/4", 1", 1-1/4"	(2) 1/2" & (1) 3/4"	(4) 1/2", 3/4"	(4) 1/2", 3/4"
Knockouts – Bottom	(2) 3/4", 1", 1-1/4"	(4) 3/4", 1", 1-1/4"	(6) 3/4", 1", 1-1/4"	(2) 3/4", 1", 1-1/4"	(4) 3/4", 1", 1-1/4"	(6) 3/4", 1", 1-1/4"
Concrete Cover Included	✓	✓	✓	✓	✓	✓
Low Voltage Barrier	–	(1) Removable	(2) Removable	–	(1) Removable	(2) Removable

Note: UL File Number E92074. CSA File Number LR18416.

*Suitable for single service applications only.

Flush Rectangular Covers Flanges

Required Components for Flush Tile or Finished Concrete Applications

Brass **S5017GR** Adapter Frame with Grounding Wire (One required per gang) Dim. 4.36" x 3.20" x 0.30"
 Aluminum **SA5017GR**



Flat Flanges*

Flat Flange Height 0.125"

Number of Gangs	1-Gang	2-Gang	3-Gang
Dimensions	6.00" x 4.85"	6.00" x 8.13"	6.00" x 11.34"
Brass, square edge	SB3083W	SB3084W	SB3085W
Aluminum, square edge	SA3083W	SA3084W	SA3085W
Brass, beveled edge	SB3083WB	SB3084WB	SB3085WB
Aluminum, beveled edge	SA3083WB	SA3084WB	SA3085WB

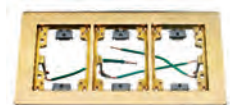
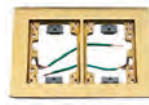







*Flange applications; square edge for carpet and recessed, beveled edge for use on hard finished surfaces

Covers – One Required per Gang[†]

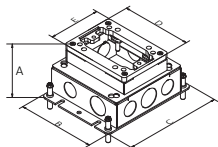
Brass	S3825	S3625	S3625TR	S3826	S2425	S2625	S2825	S3425	S3813
Aluminum	SA3825	SA3625	SA3625TR	SA3826	SA2425	SA2625	—	—	SA3813
Dimensions	4.15" x 2.99"								
	Duplex Flap	Duplex Screw	Tamper Resistant Duplex Screw	Style Line® Decorator Opening	2 1/8" x 3/4" Combination	2 1/8" x 1" Combination	2 1/8" Single Receptacle	2 3/8" Single Receptacle	Blank

[†]COVER LOAD RATING; Metallic covers and flanges 2,000 lbs. with 2x safety factor, Non-metallic covers and flanges 300 lbs. Load applied through a 3 in. (76) mandrel at the center of the cover.

Flush Rectangular Stamped Steel Floor Boxes with Non-Metallic Covers, for Use In Concrete Floors

Style	Stamped Steel					
	1-Gang Deep	2-Gang Deep	3-Gang Deep	1-Gang Shallow	2-Gang Shallow	3-Gang Shallow
						
Catalog Numbers	FB2431*	FB2432	FB2433	FB2421*	FB2422	FB2423
Cover Frame Material	Thermoplastic	Thermoplastic	Thermoplastic	Thermoplastic	Thermoplastic	Thermoplastic
Min. Depth of Pour	3.75" (95.3)	3.75" (95.3)	3.75" (95.3)	2.75" (69.9)	2.75" (69.9)	2.75" (69.9)
Adjustability	Fully	Fully	Fully	Fully	Fully	Fully
Before Pour External Height Adjustment	1.25" (31.8)	1.25" (31.8)	1.25" (31.8)	1.25" (31.8)	1.25" (31.8)	1.25" (31.8)
After Pour Internal Height Adjustment	.50" (12.7)	.50" (12.7)	.50" (12.7)	.50" (12.7)	.50" (12.7)	.50" (12.7)
Cubic Inch (cm3) Capacity per Gang	54.0 (884.9)	52.8 (865.2)	50.8 (832.5)	37.3 (611.2)	35.0 (573.5)	34.0 (557.2); 35.0 (573.5) center gang
Dimensions – A	3.73" (94.7)	3.73" (94.7)	3.73" (94.7)	2.75" (69.8)	2.75" (69.8)	2.75" (69.8)
Dimensions – B	4.81" (122.2)	4.81" (122.2)	4.81" (122.2)	4.81" (122.2)	4.81" (122.2)	4.81" (122.2)
Dimensions – C	6.00" (152.4)	9.25" (235.0)	12.50" (317.5)	6.00" (152.4)	9.25" (235.0)	12.50" (317.5)
Dimensions – D	4.32" (109.7)	4.32" (109.7)	4.32" (109.7)	4.32" (109.7)	4.32" (109.7)	4.32" (109.7)
Dimensions – E	3.20" (81.3)	6.42" (163.0)	9.64" (244.8)	3.20" (81.3)	6.42" (163.0)	9.64" (244.8)
Knockouts – Sides	(2) 3/4", 1", 1-1/4"	(4) 3/4", 1", 1-1/4"	(6) 3/4", 1", 1-1/4"	(1) 1/2" & (1) 3/4"	(8) 1/2", 3/4"	(12) 1/2", 3/4"
Knockouts – Ends	(2) 3/4", 1", 1-1/4"	(2) 3/4", 1", 1-1/4"	(2) 3/4", 1", 1-1/4"	(2) 1/2" & (1) 3/4"	(4) 1/2", 3/4"	(4) 1/2", 3/4"
Knockouts – Bottom	(2) 3/4", 1", 1-1/4"	(4) 3/4", 1", 1-1/4"	(6) 3/4", 1", 1-1/4"	(2) 3/4", 1", 1-1/4"	(4) 3/4", 1", 1-1/4"	(6) 3/4", 1", 1-1/4"
Concrete Cover Included	✓	✓	✓	✓	✓	✓
Low Voltage Barrier	–	(1) Removable	(2) Removable	–	(1) Removable	(2) Removable

Note: UL File Number E92074. CSA File Number LR18416.

*Suitable for single service applications only.

Flush Rectangular Non-Metallic Covers and Flanges*

Required Components for Carpet Applications				Cover with Duplex and Style Line® decorator inserts included
Carpet Flanges				
Number of Gangs	1-Gang	2-Gang	3-Gang	One Required per Gang 4.15" x 2.97"
Dimensions	6.00" x 4.88"	6.00" x 8.13"	6.00" x 11.35"	
Black	MFBRFBL1	MFBRFBL2	MFBRFBL3	PFBR826BLA
Brown	MFBRFBR1	MFBRFBR2	MFBRFBR3	PFBR826BRA
Gray	MFBRFGY1	MFBRFGY2	MFBRFGY3	PFBR826GYA
Ivory	MFBRFI1	MFBRFI2	MFBRFI3	PFBR826IA

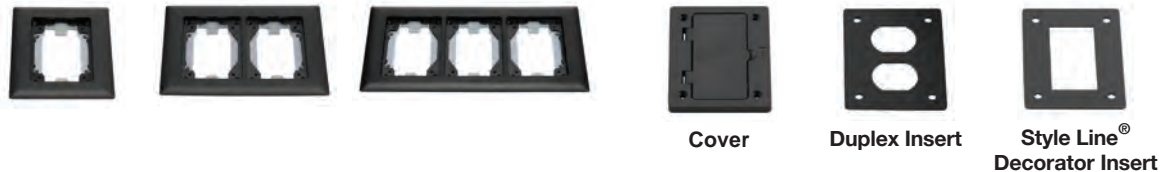

Note: *Flush rectangular non-metallic covers and flanges are UL listed only. Not CSA certified. COVER LOAD RATING; Non-metallic covers and flanges 300 lbs. Load applied through a 3 in. (76) mandrel at the center of the cover.

Dimensions in Inches (mm)

Flush Floor Boxes for Wooden Floors

Style		Rectangular Stamped Steel			Round Cast Iron	
		1-Gang	2-Gang	3-Gang	1-Gang	1-Gang
		B2481*	B2482	B2483	B2588*	B2588275*
Adjustability		Semi	Semi	Semi	Non	Non
Cubic Inch (cm ³) Capacity per Gang		42.0 cu. in. (688.3 cm ³)	42.5 cu. in. (696.5 cm ³)	42.5 cu. in. (696.5 cm ³)	18.5 cu. in. (303.2 cm ³)	18.5 cu. in. (303.2 cm ³)
Dimensions – A		3.13" (79.5)	3.13" (79.5)	3.13" (79.5)	3.65" (92.7)	3.65" (92.7)
Dimensions – B		4.50" (114.3)	4.50" (114.3)	4.50" (114.3)	3.22" (81.8)	3.22" (81.8)
Dimensions – C		3.20" (81.3)	6.42" (163.1)	9.64" (244.9)	4.09" (103.9)	4.09" (103.9)
Threaded Hubs		–	–	–	Bottom (2) ½"	Sides (2) ¾" Bottom (2) ½"
Knockouts – Ends		(1) ½", ¾", 1"	(2) ½", ¾", 1"	(3) ½", ¾", 1"	–	–
Knockouts – Sides		–	–	–	–	–
Knockouts – Bottom		(1) ½", ¾", 1", 1¼"	(2) ½", ¾", 1", 1¼"	(3) ½", ¾", 1", 1¼"	–	–
Debris Cover Included		✓	✓	✓	–	–
Closure Plugs Included		–	–	–	✓	✓
Low Voltage Barrier		–	(1) Removable	(2) Removable	–	–

Note: UL File Number E31999. CSA File Number LR18416.
*Suitable for single service applications only.

Rectangular Flat Flanges (Required)

	Brass SB3083W	Aluminum SA3083W	Brass SB3084W	Aluminum SA3084W	Brass SB3085W	Aluminum SA3085W
No. of Gangs	1-Gang	1-Gang	2-Gang	2-Gang	3-Gang	3-Gang
Dimensions	6.00" x 4.85"	6.00" x 4.85"	6.00" x 8.13"	6.00" x 8.13"	6.00" x 11.34"	6.00" x 11.34"

Round Flanges

Brass	Aluminum
S3182	SA3182
S3082	SA3082
5.25" Dia.	6.25" Dia.

Round Covers (3.88" Dia.)[†]

Brass	Aluminum	Brass	Aluminum	Brass	Aluminum
S3925	SA3925	S3725	SA3725	S2525	SA2525
Duplex Flap	Duplex Flap	Duplex Screw	Duplex Screw	2 1/8" x 3/4" Comb.	2 1/8" x 3/4" Comb.

Covers – One Required per Gang[†]

Brass	Aluminum	Brass	Aluminum	Brass	Aluminum	Brass	Aluminum
S3825	SA3825	S3625	SA3625	S3625TR	SA3625TR	S3826	SA3826
Duplex Flap	Duplex Flap	Duplex Screw	Duplex Screw	Tamper Resistant Duplex Screw	Tamper Resistant Duplex Screw	Style Line® Decorator Opening	Style Line® Decorator Opening

Round Covers[†]

Brass	Aluminum	Brass	Aluminum	Brass	Aluminum	Brass	Aluminum
S2725	SA2725	S2925	SA2925	S3525	–	S3325	–
2 1/8" x 1" Comb.	2 1/8" x 1" Comb.	2 1/8" Single Receptacle	2 1/8" Single Receptacle	2 3/8" Single Receptacle	2 3/8" Single Receptacle	2 1/8" Single Rec. (Terrazzo Floor)	2 1/8" Single Rec. (Terrazzo Floor)

One Piece Brass Cover and Carpet Flange[†]

Brass	Aluminum	Brass	Aluminum	Brass	Aluminum	Brass	Aluminum
S2425	SA2425	S2625	SA2625	S2825	–	S3813	SA3813
2 1/8" x 3/4" Combination	2 1/8" x 3/4" Combination	2 1/8" x 1" Combination	2 1/8" x 1" Combination	2 1/8" Single Receptacle	2 1/8" Single Receptacle	Blank	Blank

One Piece Brass Cover and Carpet Flange[†]

Brass	Aluminum	Brass	Aluminum	Brass	Aluminum	Brass	Aluminum
SF3925	SFA3925	SFB3926*	SFA3926	SF2525	–	SF2725	–
Duplex Flap	Duplex Flap	Style Line® Decorator Opening	Style Line® Decorator Opening	2 1/8" x 3/4" Combination	2 1/8" x 3/4" Combination	2 1/8" x 1" Combination	2 1/8" x 1" Combination

[†]COVER LOAD RATING; Metallic covers and flanges 2,000 lbs. with 2x safety factor. Load applied through a 3 in. (.76) mandrel at the center of the cover.

*Note: brass plated aluminum

Dimensions in Inches (mm)

Floor Box Cover to Receptacle Compatibility Chart

Cover Style		Terrazzo (2 1/8")	2 3/8"	2 1/8"	Duplex Flap	Duplex Plug	Style Line®
Round		S3325	S3525	S(A)2925 S(A)2725 S(A)2525	S(A)3925	S(A)3725	
Rectangular			S3425	S2825 S(A)2625 S(A)2425	S(A)3825	S(A)3625(TR)	S(A)3826
Rating	NEMA Config.						
2P, 3W 15A, 125V	5-15R	HBL5251 HBL5261 IG5261	HBL5251 HBL5261 IG5261	HBL5251 HBL5261 IG5261	5252AB 5262B CR5252IG HBL5252 HBL5262 IG5262	5252AB 5262B CR5252IG HBL5252 HBL5262 IG5262	HBL2152 IG2152 GFRST15 HBL5260SA HBL5262SA USB15
2P, 3W 15A, 125V	L5-15R	HBL4710 IG4710	HBL4710 IG4710	HBL4710 IG4710	HBL4700 IG4700A HBL4792 HBL4794 HBL4795	HBL4700 IG4700A HBL4792 HBL4794 HBL4795	
2P, 3W 15A, 250V	6-15R	HBL5661 IG5661	HBL5661 IG5661	HBL5661 IG5661	HBL5652 HBL5662 IG5662	HBL5652 HBL5662 IG5662	
2P, 3W 15A, 250V	L6-15R	HBL4560 IG4560	HBL4560 IG4560	HBL4560 IG4560	HBL4550 IG4550A	HBL4550 IG4550A	
2P, 3W 15A, 277V	7-15R				HBL5302	HBL5302	
2P, 3W 15A, 277V	L7-15R	HBL4760	HBL4760	HBL4760	HBL4750	HBL4750	
2P, 3W 20A, 125V	5-20R	HBL5361 IG5361	HBL5361 IG5361	HBL5361 IG5361	5352AB 5362B CR5352IG HBL5352 HBL5362 IG5362	5352AB 5362B CR5352IG HBL5352 HBL5362 IG5362	HBL2162 IG2162 GFRST20 HBL5360SA HBL5362SA USB20
2P, 3W 20A, 125V	5-20R				HBL5392	HBL5392	
2P, 3W 20A, 125V	L5-20R	HBL2310 IG2310	HBL2310 IG2310	HBL2310 IG2310			
2P, 3W 20A, 250V	6-20R	HBL5461 IG5461	HBL5461 IG5461	HBL5461 IG5461	HBL5462 IG5462	HBL5462 IG5462	
2P, 3W 20A, 250V	L6-20R	HBL2320 IG2320	HBL2320 IG2320	HBL2320 IG2320			
2P, 3W 30A, 125V	L5-30R	HBL2610 IG2610	HBL2610 IG2610	HBL2610 IG2610			
2P, 3W 30A, 250V	L6-30R	HBL2620 IG2620	HBL2620 IG2620	HBL2620 IG2620			
3P, 4W, 20A 125/250V	14-20R	HBL8410	HBL8410	HBL8410			
	L14-20R	HBL2410 IG2410	HBL2410 IG2410	HBL2410 IG2410			
3P, 4W, 20A 3Ø 250V	15-20R	HBL8420	HBL8420	HBL8420			
	L15-20R	HBL2420 IG2420	HBL2420 IG2420	HBL2420 IG2420			
3P, 4W, 30A 125/250V	L14-30R	HBL2710 IG2710	HBL2710 IG2710	HBL2710 IG2710			
3P, 4W, 30A 3Ø 250V	L15-30R	HBL2720 IG2720	HBL2720 IG2720	HBL2720 IG2720			
3P, 4W, 30A 3Ø 600V	L17-30R	HBL2740	HBL2740	HBL2740			
4P, 5W, 20A 3ØY 120/208V	L21-20R	HBL2510 IG2510	HBL2510 IG2510	HBL2510 IG2510			
4P, 5W, 20A 3ØY 347/600V	L23-20R	HBL2530	HBL2530	HBL2530			
4P, 5W, 30A 3ØY 120/208V	L21-30R	HBL2810 IG2810	HBL2810 IG2810	HBL2810 IG2810			
4P, 5W, 30A 3ØY 347/600V	L23-30R	HBL2830	HBL2830	HBL2830			

Floor Boxes

Accessories

Theater Seating Floor Box



F3185

Theater Seating Floor Box

Description	Catalog Number
Hubbell's nonadjustable theater seating concrete floor box provides a 1/4 in. threaded hub for conduit connection to theater aisle lights. This floor box can also be used to power furniture receptacles in lecture halls, libraries and transportation terminals. It permits opening of the enclosure for wiring without disturbing above floor connections. Other features include a cast iron box with a corrosion-resistant finish and a blank steel cover. Threaded NPSM hubs: (1) 1/4 in. surface, (3) 3/4 in. sides, 1/4 in. bottom) 18.80 cu. in. (380 cubic cm).	F3185

Protective Ring for 2 1/8" Threaded Covers



S3061

Problem Solvers and Replacement Components Protective Ring for 2 1/8 Inch Threaded Covers

Description	Catalog Number
Provides mechanical and wet mop protection for plugs and receptacles (brass).	S3061

Note: Adjustment: 1/4 in. and 1 in. fittings permit 1/2 in. vertical adjustment.

Coupling (Brass)



F1340

Coupling (Brass)

Couplings are utilized for straight conduit connections when a floor box is not required. The conduit stub is brought to within approximately 1 1/4 in. of the planned surface, and the coupling is mounted and adjusted prior to the concrete pour. Standard service heads may be mounted to the couplings as required.

Description	A	B	Catalog Number
1/4 in. threaded conduit size (female).	1.44" (36.6)	1.25" (31.8)	F1340

Dimensions in Inches (mm)

Floor Boxes

Accessories

Experiencing a problem? Let Hubbell accessories help solve it. Hubbell stacking (adjustable) collars are the answer if the box is set too low. Need a replacement? Choose from a full line of replacement covers and fittings. Hubbell accessories also help you with the protection you need for plugs and receptacles.

Problem Solvers and Replacement Components Stacking (Adjustable) Collars and Frames

Designed to be used if floor box is set too low beneath the floor surface or the adjustable collar and/or adapter on the box is damaged.

If the box number is...	Extension Value	Use Collar Number
FB2431, FB2421	0.78" (19.81)	FBC2100*
FB2432, FB2422	0.78" (19.81)	FBC2200*
FB2433, FB2423	0.78" (19.81)	FBC2300*
FB2536, FB2537, FB2527, FB2529	0.80" (20.32)	FBC2500*
FB4133	1.16" (29.64)	FBC4100*
FB4233	1.16" (29.64)	FBC4200*
FB4333	1.16" (29.64)	FBC4300*

Note: *Only available as sets (collars and adapters). In cases where the adapter on the floor box is not damaged, and only stacking is required, discard the adapter and use only the collar. The adjustable collars listed above can be stacked as required to reach the floor surface. Longer screws will be required if more than one collar is stacked (screws not provided). These screws are commercially available. Flat head #12-24 UNC machine screw x (approx. length). Minor Upward Adjustments: Round or Rectangular cover frames (trim rings) may be stacked if the floor box is only slightly recessed below the floor surface.

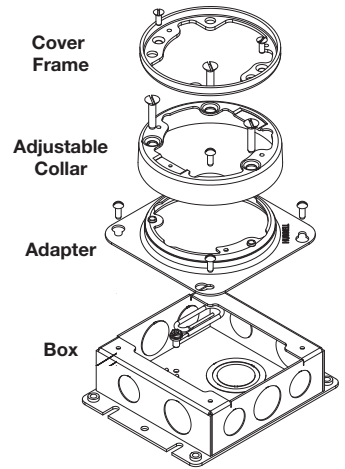

Round Replacement Flange

Round Steel Cover Flange	S5016PG
--------------------------	----------------

Replacement Carpet Flanges

Number of Gangs Dimensions	Rectangular	Rectangular	Rectangular	Round
	1-Gang 6.00" x 4.85"	2-Gang 6.00" x 8.13"	3-Gang 6.00" x 11.34"	1-Gang 5.25" Dia.
Brass [‡]	SB3083	SB3084	SB3085	—
Aluminum [‡]	SA3083	SA3084	SA3085	—
Clear Polycarbonate	S3083	S3084	S3085	S3079

[‡]Flange height; 0.47"

Crown Plugs

Description	Used in the following covers	Catalog Number	
		Brass	Aluminum
3/4" thread size.	S2525, SA2525, S881, S2555, S2530, S2425, SA2425, SF2525	S5012	SA5012
1" thread size.	S2725, SA2725, S2755, S2730, S2625, SA2625, SF2725	S5013	SA5013

Flush Cap Rings

Description	Used in the following covers	Catalog Number	
		Brass	Aluminum
2 1/8" threaded plug with 3/4" thread size opening.	S2525, SA2525, S881, S2555, S2530, S2425, SA2425, SF2525	S5010	SA5010
2 1/8" threaded plug with 1" thread size opening.	S2725, SA2725, S2755, S2730, S2625, SA2625, SF2725	S5025	SA5025

Flush Plugs

Description	Used in the following covers	Catalog Number	
		Brass	Aluminum
3/4" I.P.S. thread size.	F1339, F1340	S5002	—
1" I.P.S. thread size.	F1539	S5003	—
1 1/2" fine thread size.	S3725, SA3725, S3625, SA3625	S5007	SA5007
2 1/8" fine thread size.	S2925, SA2925, S88, S2930, S2955, SF2925, S2825	S5020	SA5020
2 3/8" fine thread size.	S3525, S3425	S5030	—

Replacement Adjustable Collar



FBC2500

FBC4200



S5016PG



SB3083



S3085



S3079



SA3084

Crown Plugs



S5012

S5013

Flush Cap Rings



S5010

Flush Plugs



S5007

Dimensions in Inches (mm)

Fire-Classified Floor Box Solutions



Hubbell's fire-classified floor boxes are an excellent solution when there is not enough capacity in a poke through and the decking must be penetrated for electrical installations. Available in seven or eleven gang versions, our fire rated kits are compatible with our standard CFB7G6 and CFB11G6 series floor boxes.

Fire-Classified Floor Box Kits

- Preserves 2 or 3 hour fire classified floor rating
- Approved for installations using either light or normal weight concrete
- UL 514 and UL 263 Compliant
- Variety of ADA compliant cover choices for most floor types
- Four 1½ inch box bottom entry conduits

Fire-Resistant Floor Box Kit Includes

- Floor pan, conduit assemblies, hardware, leveling feet and manual
Floor box ordered separately

Installation

- For Concrete pours from 3¼ in. up to 5½ in. above upper most portion of decking
- Units can be mounted 2 ft. on center
- Fastens to deck with TEK screws or welding



CFB7G6 Floor Box above **CFB7G6FRK**
Installed in decking

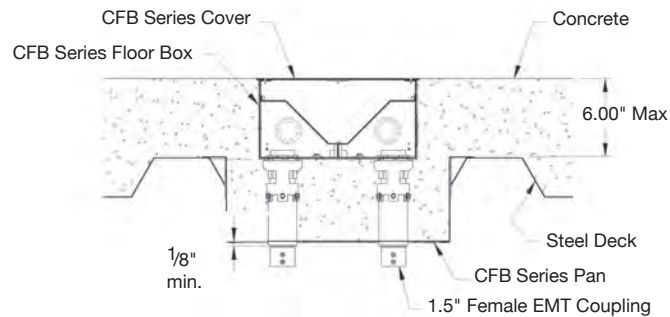

CFB7G6/CFB11G6 Series

Fire-Classified Kit for 7-Gang Floor Box

Floor box, cover and mounting plates NOT included.



CFB7G6FRK
Kit with **CFB7G6**

Description		Catalog Number
Bottom feed conduits.	4	CFB7G6FRK
Bottom feed conduit size.	1½ in.	
Pan dimensions.	17 ³ / ₁₆ L x 17 ³ / ₁₆ W x 6 ¹ / ₂ H in.	
Minimum depth of pour above deck roof.	3¼ in.	
Maximum depth of pour above deck roof.	5½ in.	
Adjustment screw length, four per kit.	6 in.	
Required floor box (not included).	CFB7G6	

Fire-Classified Kit for 11-Gang Floor Box

Floor box, cover and mounting plates NOT included.



CFB11G6FRK
Kit with **CFB11G6**

Description		Catalog Number
Bottom feed conduits.	4	CFB11G6FRK
Bottom feed conduit size.	1½ in.	
Pan dimensions.	20 ¹ / ₁₆ L x 17 ³ / ₁₆ W x 6 ¹ / ₂ H in.	
Minimum depth of pour above deck roof.	3¼ in.	
Maximum depth of pour above deck roof.	5½ in.	
Adjustment screw length, four per kit.	6 in.	
Required floor box (not included).	CFB11G6	

Dimensions in Inches (mm)

Recessed 7- and 11-Gang Concrete Floor Boxes

Style	CFB7G Series		CFB11G Series	
	7-Gang		11-Gang	
	CFB7G4	CFB7G6	CFB11G4	CFB11G6
Min. Depth of Pour	4.08" (103.5)	6.08" (154.3)	4.08" (103.5)	6.08" (154.3)
Adjustability	Before Pour	Before Pour	Before Pour	Before Pour
Dimensions:				
A	4.08" (103.5)	6.08" (154.3)	4.08" (103.5)	6.08" (154.3)
B	10.0" (254.0)	10.0" (254.0)	13.5" (342.9)	13.5" (342.9)
C	12.2" (309.9)	12.2" (309.9)	12.2" (309.9)	12.2" (309.9)
KO Trade Size:				
Sides	(4) 1", 1/4"	(4) 1", 1/4", 1 1/2"	(4) 1", 1/4"	(4) 1", 1/4", 1 1/2"
Back	(1) 1", 1/4", 1 1/2", (1) 2"	(1) 1", 1/4", 1 1/2", (1) 2"	(2) 1", 1/4", 1 1/2", (1) 2"	(2) 1", 1/4", 1 1/2", (1) 2"
Front	(2) 1", 1/4", 1 1/2"	(2) 1", 1/4", 1 1/2"	(2) 1", 1/4", 1 1/2", (2) 3/4", 1"	(2) 1", 1/4", 1 1/2", (2) 3/4", 1"
Bottom	(4) 1", 1/4", 1 1/2"	(4) 1", 1/4", 1 1/2"	(5) 1", 1/4", 1 1/2", (2) 3/4", 1"	(5) 1", 1/4", 1 1/2", (2) 3/4", 1"
Side View Depth behind mounting plate		X - 2.37" Y - 3.77" Z - 3.65"	X - 1.02" Y - 2.42" Z - 3.50"	X - 2.37" Y - 3.81" Z - 3.72"
Accepts industry standard size wallplates (sold separately)	(1) 1-Gang (1) 2-Gang (1) 4-Gang	(1) 1-Gang (1) 2-Gang (1) 4-Gang	(2) 1-Gang (1) 3-Gang (1) 6-Gang	(1) 2-Gang (1) 3-Gang (1) 6-Gang
Interior Configuration				

Note: UL File Number E31999. CSA File Number LR18416.

Accessories

On-grade Barrier

The on-grade barrier is intended for use on installations at grade level. This accessory is installed prior to the concrete pour and provides a barrier between the soil. The on-grade barrier comes with leveling feet and anchor points.

CFBOGPAN4

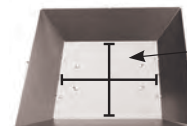
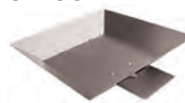

Pour Pan Dimensions:
15.75 in. sq.
4 in. depth

Floor Box Covers

CFB7G Series				CFB11G Series			
Brass	Aluminum	Black	Stainless Steel	Brass	Aluminum	Black	Stainless Steel
Flange and cover; Beveled edge for carpet, 1/4" Edging				Flange and cover; Beveled edge for carpet, 1/4" Edging			
CFB7CVRBRS	CFB7CVRALU	CFB7CVRBLK	–	CFB11CVRBRS	CFB11CVRALU	CFB11CVRBLK	–
Flange and cover; Square edge for tile, 1/2" Edging				Flange and cover; Square edge for tile, 1/2" Edging			
CFB7TBRS	CFB7TALU	–	–	CFB11TBRS	CFB11TALU	–	–
Flange and cover; No Edging*				Flange and cover; No Edging*			
–	–	CFB7CVRCLBK	CFB7CVRCSS	–	–	CFB11CVRCLBK	CFB11CVRCSS

Note: Covers provide a recessed area, allowing floor covering to be inserted.
*Not UL Listed or CSA Certified.

Dimensions in Inches (mm)

Recessed 8-Gang Ballroom Series Floor Boxes

Style	CFB8FC Series	
	8-Gang	8-Gang
	<p>CFB8FC1</p>	<p>CFB8FC2</p>
Application	Carpet	Tile, Finished Concrete
Min. Depth of Pour	6.95" (176.5)	7.15" (181.6)
Adjustability	Before Pour	Before Pour
Dimensions:		
A	6.95" (176.5)	7.15" (181.6)
B	15.00" (381.0)	14.75" (374.7)
C	13.00" (330.2)	12.75" (323.9)
KO Trade Size:		
Sides	(4) 1", 1¼", 1½"	(4) 1", 1¼", 1½"
Front & Back	(4) 1", 1¼", 1½"	(4) 1", 1¼", 1½"
Bottom	(4) 1", 1¼", 1½"	(4) 1", 1¼", 1½"
Side View Depth behind mounting plate	<p>X = 2.27" (57.7) Y = 4.01" (101.9) Z = 3.13" (79.5)</p>	<p>X = 2.27" (57.7) Y = 4.01" (101.9) Z = 3.13" (79.5)</p>
Accepts industry standard size wallplates (sold separately) 4.63" Maximum Cover Height	One, two, three and four gang plates. Customer configuration dependant.	One, two, three and four gang plates. Customer configuration dependant.

Note: UL File Number E31999.

Accessories

On-grade Barrier

The on-grade barrier is intended for use on installations at grade level. This accessory is installed prior to the concrete pour and provides a barrier between the soil. The on-grade barrier comes with leveling feet and anchor points.

CFBOGPAN4

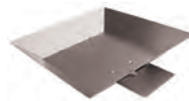

Pour Pan Dimensions:
15.75 in. sq.
4 in. depth

Covers

All ballroom floor box covers are machined from Aluminum and have no additional finish options

	CFB8FC1 Covers		CFB8FC2 Covers	
Carpet Cover, with 2 egress doors (0.20" depth)	CFB8CVRALU1	—	—	—
Flush cover, with 2 egress doors	—	—	CFB8CVRALU2	—
Blank box cover	—	CFB8JBC1	—	CFB8JBC2
Cover Load Ratings*:				
Recommended Loading	20,000 lb	20,000 lb	20,000 lb	20,000 lb
Maximum Load	40,000 lb	40,000 lb	40,000 lb	40,000 lb

Note: *Load applied through 3" (76mm) mandrel in center of cover. Loads are static and don't apply to rolling loads.

Dimensions in Inches (mm)

Floor Boxes

Above-Floor Service Fittings (Single Service)

Hubbell offers a variety of above-floor service pedestals to satisfy just about any requirement. Large capacity enables a choice of services—you can even create your own unique pedestal to satisfy specific requirements. Above floor service fittings are ideal for furniture feed applications.

Pedestals – Metallic – LO-CON (single service only)

Traditional metallic pedestals with die-cast aluminum frame, brushed aluminum housing and stainless steel faceplates. These pedestals are offered as component parts. They mount on floor box covers or floor deck/duct systems with $\frac{3}{4}$ inch or 1 inch threaded openings.

Create Pedestal – Create your own pedestal to meet specific service requirements. Order housing, face plates and devices separately.



Description	Catalog Number
Frame, housing, $\frac{3}{4}$ in. chase nipple, without plates.	SC3098A
Frame, housing, 1 in. chase nipple, without plates.	SC3099A
Blank plate.	SS309B
Telephone bushing with 1 in. I.D. and (2) $\frac{5}{8}$ in. KO for coax.	SS309T
Single receptacle plate with 1.39 in. (35.3) opening.	SS309S
Duplex receptacle plate.	SS309D
Style Line® decorator plate.	SS309DS

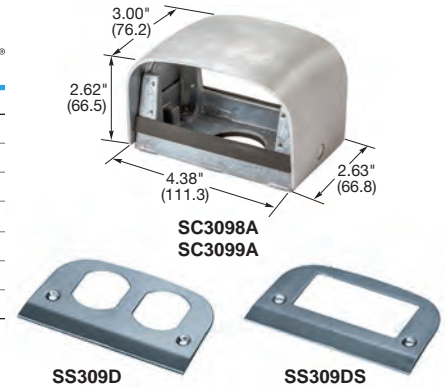

Furniture Feed Plates – Use with SC3098A or SC3099A housings to feed furniture systems in office settings or display cases in retail applications.

Description	Catalog Number
Aluminum plate with $\frac{3}{4}$ in. trade size knockout.	SS309SF
Aluminum plate, blank.	SS309BF

Note: When using SS309SF on Hubbell's LO-CON pedestals, SS309BF must be used on the opposite side.

Pedestals – Specialized Service – Large Capacity Pedestals (single service only)



Designed to accommodate receptacles up to 50A (4-gang only). These brushed aluminum pedestals are furnished with either a $\frac{3}{4}$ inch or 1 inch hub and are designed for mounting to floor box covers with $\frac{3}{4}$ inch or 1 inch threaded openings. Create your own unique pedestal with a wide choice of stainless steel plates and devices.

Description (2-Gang Housing)	Catalog Number
2-gang aluminum pedestal, grounded (front and back) with $\frac{3}{4}$ in. hub.	SA6685G
2-gang aluminum pedestal, grounded (front and back) with 1 in. hub.	SA6686G

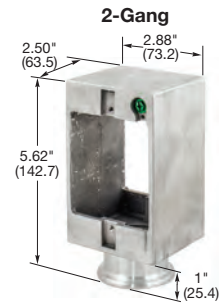

SA6685G
SA6686G



Plate Option – 1-Gang

Description	Catalog Number
Duplex opening.	SS8
Style Line® decorator opening.	SS26
Single receptacle opening – boss diameter 1.36 to 1.39 in. (34.5 to 35.3).	SS7
Single receptacle opening – boss diameter 1.55 to 1.58 in. (39.4 to 40.1).	SS720
Blank plate.	SS13

Description (4-Gang Housing)	Catalog Number
4-gang aluminum pedestal (2 front and 2 back), with $\frac{3}{4}$ in. hub.	SA6687G
4-gang aluminum pedestal (2 front and 2 back), with 1 in. hub.	SA6688G

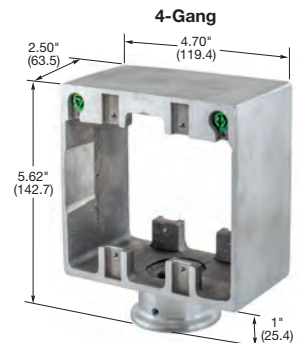

SA6687G
SA6688G

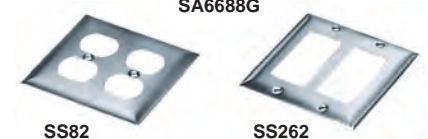

Plate Option – 2-Gang

Description	Catalog Number
Two duplex openings.	SS82
Two Style Line® decorator openings.	SS262
Two single receptacle openings – boss diameter 1.36 to 1.39 in. (34.5 to 35.3).	SS72
Single receptacle opening – boss diameter 2.41 to 2.44 in. (61.2 to 62.0).	SS701
Single receptacle opening – boss diameter 2.09 to 2.13 in. (53.1 to 54.1).	SS703
Blank plate.	SS23

Dimensions in Inches (mm)

Features and Benefits

Convention Center Utility Boxes

Painted Galvanized Steel Box (14 Gauge G90)

- Cost effective, corrosion resistant paint. Suitable for both on and above-grade applications

Stainless Steel Box (14 Gauge 304)

- Corrosion resistant enclosure suitable for both on and above-grade applications

Listings/Requirements

- UL Listed and CSA Certified
- Meets UL514 requirements for scrubwater and prevents water, dirt and debris from entering the electrical devices

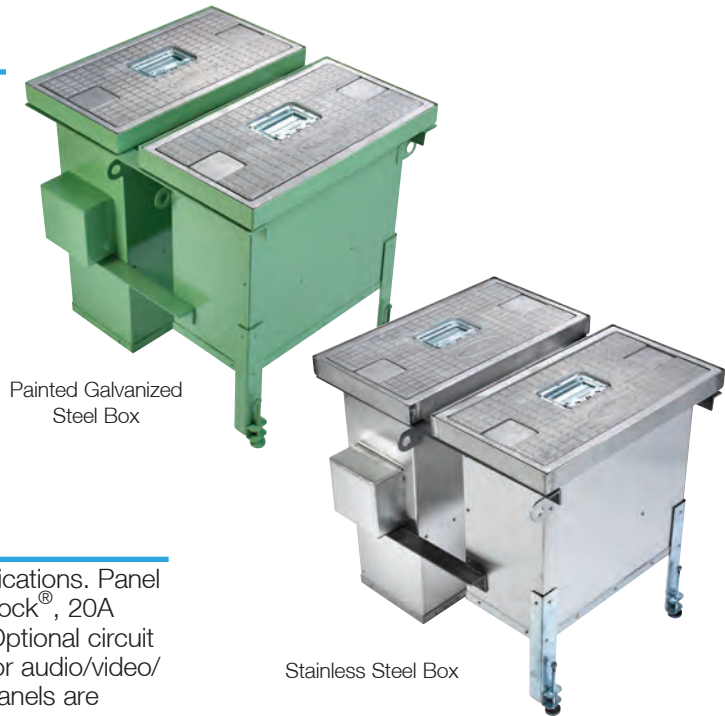

Painted Galvanized Steel Box

Stainless Steel Box

Power and Data Panels*

Custom manufactured and pre-wired to your project specifications. Panel options include 100A pin and sleeve, 20A and 30A Twist-Lock®, 20A GFCI, isolated ground or industrial straight blade devices. Optional circuit breaker protection is available. Up to two gangs available for audio/video/data communication requirements. Both power and data panels are shipped separately after the boxes have been set in concrete.

*Note: *Contact Hubbell for available configurations of power and data panels.*



Box Design

- Separate enclosure to keep water away from electrical components
- Hooks for tying onto rebar
- 2-gang low voltage compartment
- Custom built panels that accept a wide variety of electrical configurations



Cover Design

- Heavy duty covers, 32,000 lb. load capacity with 2x safety factor



Adjustability

- 4 inch pre-pour adjustability



Air/Water Only Inside View

- Separate enclosure for compressed air/water utilities, prevents air and water from coming in contact with electrical services
- 2 inch drain



Stand Alone Power/Data Box

- Custom manufactured and pre-wired to your project specifications
- Optional circuit breaker protection is available
- Up to 2-gangs available for audio/video/data communication requirements



Power/Data Box Inside View

- Up to 2-gangs of data
- 20A and 30A devices
- Circuit breakers
- Up to 100A pin and sleeve
- 150A maximum capacity
- Boxes do not ship with power/data panels

*Note: *Contact Hubbell for available configurations of power and data panels.*

Convention Center Utility Boxes

Metallic Convention Center Utility Boxes*

Steel Convention Center Utility Box	Painted Galvanized Steel Box	Stainless Steel Box
with Cover for Power and Data/Communications.	HBLSCCUBPD	HBLSCCUBPDSS
with Cover for Power, Data/Communications and Air/Water Box.	HBLSCCUBPDW	HBLSCCUBPDWSS
with Cover for Air/Water Only.	HBLSCCUBW	HBLSCCUBWSS

Note: UL File Number E302222.

*All boxes provided with temporary galvanized steel concrete covers.

Painted Galvanized Steel Low Voltage Panel

Description	Catalog Number
Data Panel, 2-Gang, 12 Ports	HBLSDPCC



Painted Galvanized or Stainless Steel Metallic Box

Stand Alone Power/Data

HBLSCCUBPD (Painted Galvanized)

HBLSCCUBPDSS (Stainless Steel)

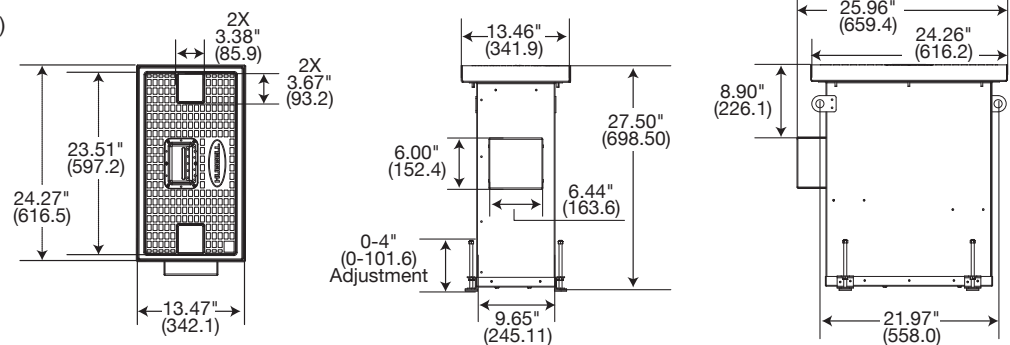

Combination Power/Data/Water

HBLSCCUBPDW (Painted Galvanized)

HBLSCCUBPDWSS (Stainless Steel)

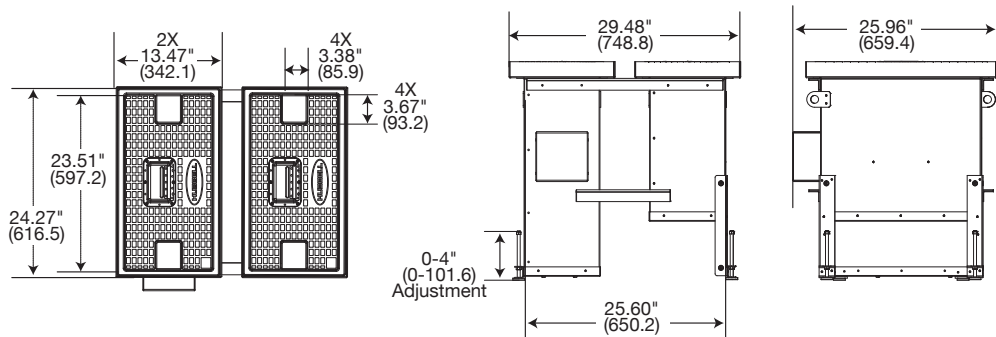

Stand Alone Water/Air Box

HBLSCCUBW (Painted Galvanized)

HBLSCCUBWSS (Stainless Steel)

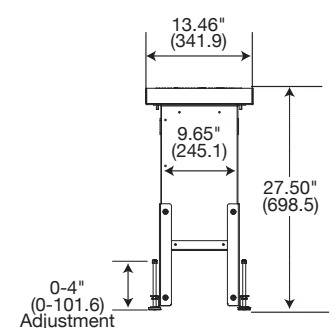

Pre-Wired Power Panels

Convention Center Power Panels are custom built to order and pre-wired in the factory to make installation quick and easy. Please contact the factory to configure a power panel for your specific needs.

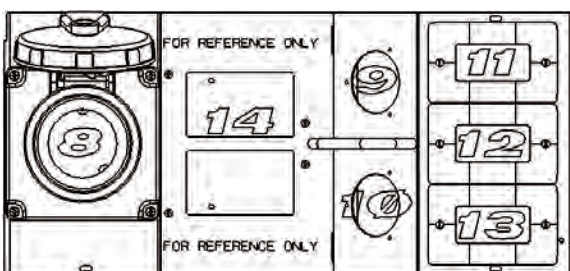

Position	Device Options**
8	Qty. (1) Pin and Sleeve Receptacle, 60A or 100A.
9 & 10	Qty. (2) Twist-Lock® Receptacles (20A or 30A).
11,12,13	Qty. (3) Duplex Receptacles (20A Standard, GFCI or Isolated Ground).
14	Load Center for Circuit Breakers, 8-Pole Positions Max.

Note: **Contact Hubbell for available configurations of power and data panels.

Dimensions in Inches (mm)

Floor Boxes

CONNEXION Zone Distribution System

The Hubbell CONNEXION 2.0 Zone Distribution System is a factory assembled, flexible, modular plug-n-play system with Hubbell AFB Series Boxes that delivers power in raised floor installations. This unique system increases the value of the infrastructure and meets the challenges posed by new construction and renovation in commercial offices, retail outlets and educational facilities. By improving cable management, enhancing flexibility, and reducing administration expense, the CONNEXION 2.0 Zone Distribution System allows power needs to be addressed in a timely and effective manner. The basic CONNEXION 2.0 building blocks are shown below.

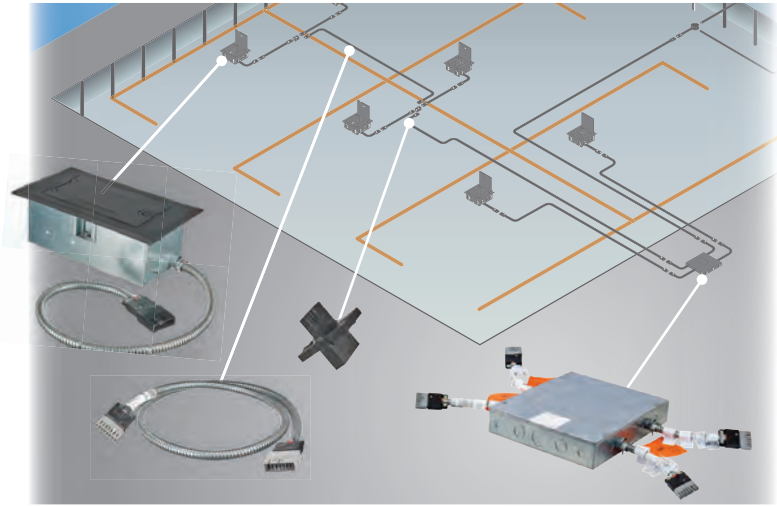

3/3/2 System Configuration (3-Hots, 3-Neutrals, 2-Grounds)

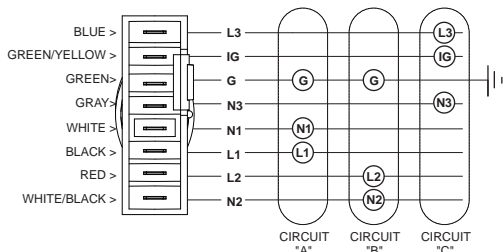

Appropriate for a 120/208 volt 3ØY power distribution and dedicated neutrals are desired.

- Three circuit capacity.
- Isolated ground capability for sensitive equipment.
- Each circuit has its own #12 AWG neutral.
- Component Rating: 20 amperes at 120/208 volt.
- 8-Wires (3 hots, 3 neutrals, 1 equipment ground, 1 isolated ground).

4/2/2 System Configuration (4 Hots, 2 Neutrals, 2 Grounds) 2 + 2 Wiring Configuration

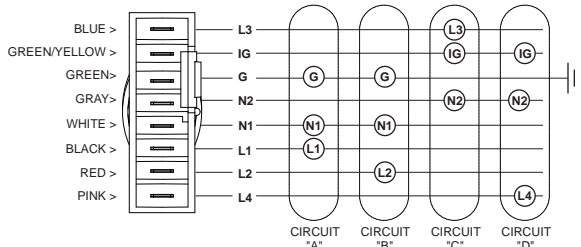

Appropriate in areas where shared neutral conductors are utilized.

- Two circuits share one #10 AWG neutral to manage harmonics for general purpose.
- Two additional circuits share one #10 AWG neutral to manage harmonics for general purpose.
- Isolated ground capability for sensitive equipment.
- Component Rating: 20 amperes at 120/208 volt.
- 8-Wires (4 hots, 2 neutrals, 1 equipment ground, 1 isolated ground).

4/2/2 System Configuration (4 Hots, 2 Neutrals, 2 Grounds) 3+ 1 Wiring Configuration

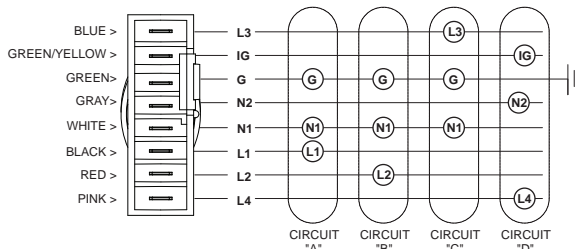

Appropriate in areas where shared neutral conductors are utilized.

- Three circuits share #10 AWG neutral to manage harmonics for general purpose.
- One circuit on dedicated #10 AWG neutral for sensitive equipment.
- Isolated ground capability for sensitive equipment.
- Component Rating: 20 amperes at 120/208 volt.
- 8-Wires (4 hots, 2 neutrals, 1 equipment ground, 1 isolated ground).

1/1/1 System Configuration (1 Hot, 1 Neutral, 1 Ground)

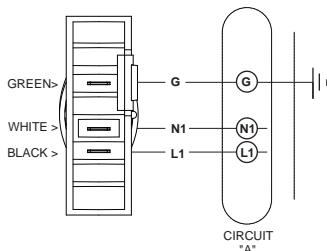

- One circuit capacity.
- Component Rating: 20 amperes at 120/208 volt.
- 3-Wires (1 hot, 1 neutral, 1 equipment ground).

Note: Contact factory for custom wiring configurations.

Floor Boxes

CONNEXION Zone Distribution System

2.0 Zone Boxes

Zone Box Part Number	Wiring Configuration	Output Whips	Total Number of Circuits per Box	Circuits per Whip	Home Run Connection Type
ZB332C3W1POUT*	332	1	3	3	Wire nuts to open leads
ZB332C6W2P	332	2	6	3	Wire nuts to open leads
ZB332C12W4P	332	4	12	3	Wire nuts to open leads
ZB332C3W2TC	332	2	3	3	Single Screw down terminal block
ZB332C3W4TC	332	4	3	3	Single Screw down terminal block
ZB332C6W2TM	332	2	6	3	Multi Screw down terminal block
ZB332C12W4TM	332	4	12	3	Multi Screw down terminal block
ZB422S2C4W1POUT*	422, 2+2	1	4	4	Wire nuts to open leads
ZB422S2C8W2P	422, 2+2	2	8	4	Wire nuts to open leads
ZB422S2C16W4P	422, 2+2	4	16	4	Wire nuts to open leads
ZB422S2C4W2TC	422, 2+2	2	4	4	Single Screw down terminal block
ZB422S2C4W4TC	422, 2+2	4	4	4	Single Screw down terminal block
ZB422S2C8W2TM	422, 2+2	2	8	4	Multi Screw down terminal block
ZB422S2C16W4TM	422, 2+2	4	16	4	Multi Screw down terminal block
ZB422S3C4W1POUT*	422, 3+1	1	4	4	Wire nuts to open leads
ZB422S3C8W2P	422, 3+1	2	8	4	Wire nuts to open leads
ZB422S3C16W4P	422, 3+1	4	16	4	Wire nuts to open leads
ZB422S3C4W2TC	422, 3+1	2	4	4	Single Screw down terminal block
ZB422S3C4W4TC	422, 3+1	4	4	4	Single Screw down terminal block
ZB422S3C8W2TM	422, 3+1	2	4	4	Multi Screw down terminal block
ZB422S3C16W4TM	422, 3+1	4	16	4	Multi Screw down terminal block
ZB111C1W1POUT*	111	1	1	1	Wire nuts to open leads
ZB111C2W2P	111	2	2	1	Wire nuts to open leads
ZB111C4W4P	111	4	4	1	Wire nuts to open leads
ZB111C6W6P	111	6	6	1	Wire nuts to open leads
ZB111C8W8P	111	8	8	1	Wire nuts to open leads
ZB111C1W2TC	111	2	1	1	Single Screw down terminal block
ZB111C1W4TC	111	4	1	1	Single Screw down terminal block
ZB111C1W6TC	111	6	1	1	Single Screw down terminal block
ZB111C1W8TC	111	8	1	1	Single Screw down terminal block
ZB111C2W2TM	111	2	2	1	Multi Screw down terminal block
ZB111C4W4TM	111	4	4	1	Multi Screw down terminal block
ZB111C6W6TM	111	6	6	1	Multi Screw down terminal block
ZB111C8W8TM	111	8	8	1	Multi Screw down terminal block

Note: *OUT suffix denotes single whip output zone box, which will not be further expanded.

2.0 Furniture Feeds

Furniture feeds are junction boxes which come with a pre attached power "IN" connector allowing transition to building hard-wiring underneath the raised floor.

Zone Box Part Number	Wiring Configuration	Output Whips	Total Number of Circuits per Box	Circuits per Whip	Home Run Connection Type
ZB332C3W1PIN	332	1	3	3	Wire nuts to open leads
ZB422S2C4W1PIN	422, 2+2	1	4	4	Wire nuts to open leads
ZB422S3C4W1PIN	422, 3+1	1	4	4	Wire nuts to open leads
ZB111C1W1PIN	111	1	1	1	Wire nuts to open leads

2.0 Extender Cables

Hubbell Connexion 2.0 extender cables have male (power "IN") / female (power "OUT") ends allowing them to be connected in the field as needed. Available in three different versions, 422, 332, and 111, in 5 ft. increments up to 30 ft.

422 Family	332 Family	111 Family	Length	Connectors
CEXT422MFL01	CEXT332MFL01	CEXT111MFL01	1 ft.	Male / Female
CEXT422MFL05	CEXT332MFL05	CEXT111MFL05	5 ft.	Male / Female
CEXT422MFL10	CEXT332MFL10	CEXT111MFL10	10 ft.	Male / Female
CEXT422MFL15	CEXT332MFL15	CEXT111MFL15	15 ft.	Male / Female
CEXT422MFL20	CEXT332MFL20	CEXT111MFL20	20 ft.	Male / Female
CEXT422MFL25	CEXT332MFL25	CEXT111MFL25	25 ft.	Male / Female
CEXT422MFL30	CEXT332MFL30	CEXT111MFL30	30 ft.	Male / Female
CEXT422FWL01	CEXT332FWL01	CEXT111FWL01	1 ft.	Female / Open
CEXT422FWL01XP*	CEXT332FWL01XP*	CEXT111FWL01XP*	1 ft.	Female / Open
CEXT422MWL01	CEXT332MWL01	CEXT111MWL01	1 ft.	Male / Open
CEXT422MWL01XP*	CEXT332MWL01XP*	CEXT111MWL01XP*	1 ft.	Male / Open
CEXT422MWL05	CEXT332MWL05	CEXT111MWL05	5 ft.	Male / Open
CEXT422MWL15	CEXT332MWL15	CEXT111MWL15	15 ft.	Male / Open

Note: *Standard lead length is 12 in. long. XP Suffix denotes 18 in. long leads for installations requiring extra-long wires. 5 piece minimum order quantities.

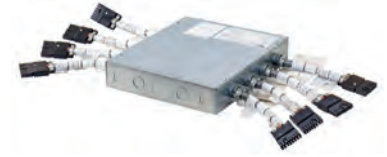

Zone distribution Boxes are the core of the Connexion 2.0 system. They serve as the main interface between the conventionally connected electrical system and the labor saving Connexion 2.0 system. With a large array of knock outs, they can accept most conduit sizes when run from the circuit breaker panel. They also accept labor saving Homerun cables as part of the Connexion 2.0 system. With depth of 3 inches, the zone boxes will fit in almost any raised flooring system. Custom configurations are also available. Contact Hubbell Wiring Systems for ordering information.



2.0 Splitters

Distributes all cable conductors to up to three locations (one "IN", three "OUTS") to increase the amount of floor boxes fed from a single Zone Distribution Box output whip.

Catalog Number	Wires	Hot Circuits
SP31	3	1
SP83	8	3
SP84	8	4



Custom Pre-Wired Access Floor Boxes

Cover

- 180° cover opening
- Two large cable egress doors
- Die cast aluminum construction
- Five powder coat finishes
- ADA compliant

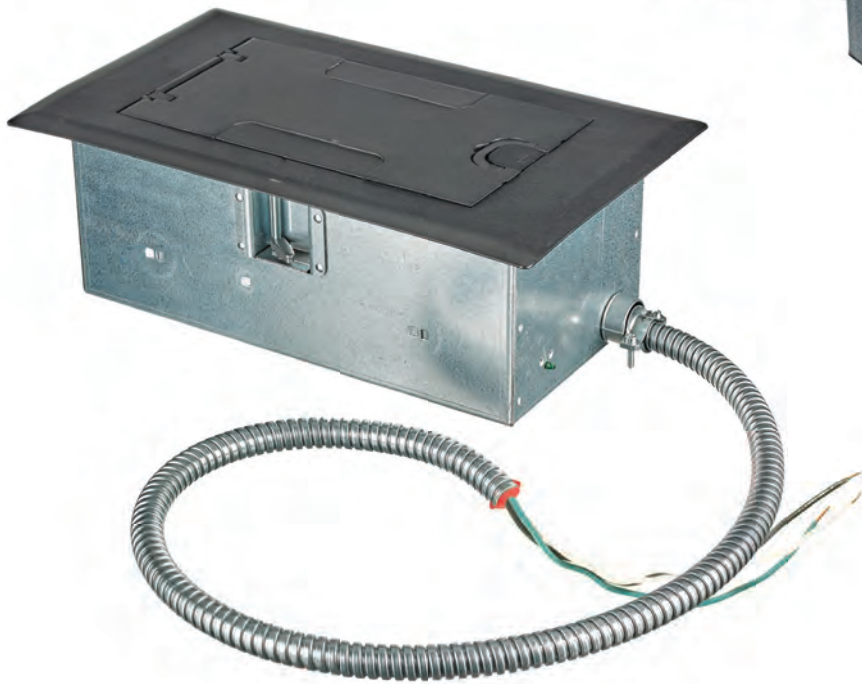
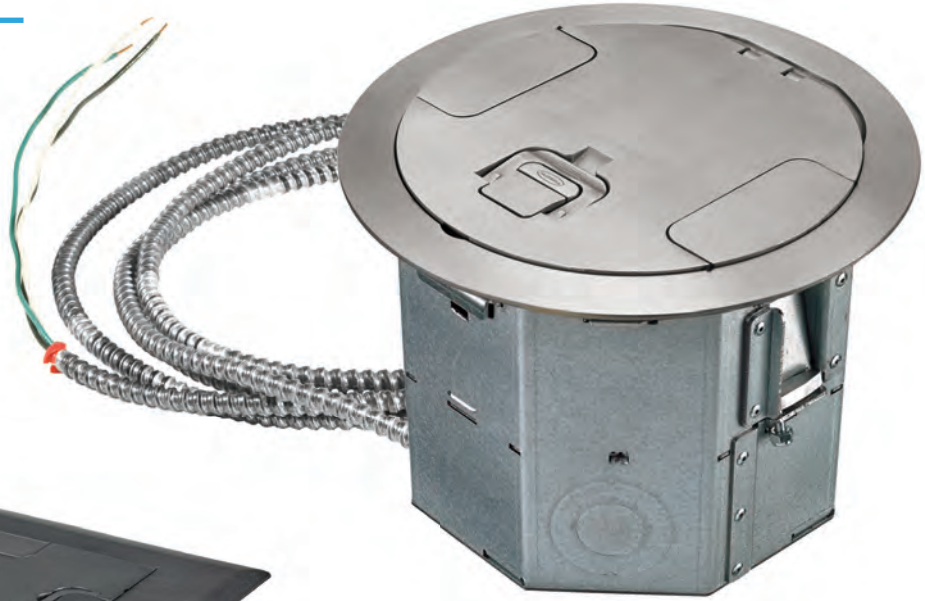

Box

- 16 gauge galvanized sheet metal construction

Cable Whip

- Wire leads for field termination
- Pre-wired cable whip

Features and Benefits

- Reduce job site fabrication time and installation labor
- Access Floor Box pre-wired to your specifications
 - Choose from Hubbell quality devices
 - Single or multiple circuit wiring configurations
 - Various cable lengths
- Reduce job site waste
- Pigtail terminates beneath raised floor
- Box covers available in five finishes
- UL Listed Wiring Assembly, file number E305156

Pre-Wired Raised Access Floor Box Options - Contact Hubbell Wiring Systems for Ordering Information

Box Series	Description	Cover Style	Cut Out Dimensions	Conduit Knockouts
AFB2G25PW	2-Gang, 2½" Depth	Rectangular	6¾" x 13⅛"	½" – ¾"
AFB2G50PW	2-Gang, 5.0" Depth	Rectangular	6¾" x 13⅛"	½" – 2"
AFB4G25PW	4-Gang, 2½" Depth	Rectangular	11¼" x 11⅞"	½" – ¾"
AFB4G50PW	4-Gang, 5.0" Depth	Rectangular	11¼" x 11⅞"	½" – 2"
AFB10G55PW	10-Gang, 5½" Depth	Rectangular	11" x 11¼"	½" – 2"
RAFB4PW	4-Gang, 8.0" Depth	Round	8" Diameter	½" – 2"

Products at a Glance

Featuring the unique capabilities of Hubbell's SystemOne universal cover and sub-plate design, Hubbell has expanded its floor box offering to provide industry leading flexibility while accommodating an extensive range of applications. Hubbell SystemOne is constructed to give customers the ability to create personal solutions for their most demanding, power, data and audio/video requirements.

SystemOne Recessed Raised Access and Wood Floor Applications...



2-Gang Rectangular

Ideal for applications that call for basic power and data/AV requirements. The 2-gang boxes can be used as an access point to electrical or data connections, or as a furniture feed to power interior furniture partitions. Available in two box depths, the 2 ½ in. depth works well in floors using short pedestals; the 5 in. depth is ideal for furniture feed applications. The rectangular covers are available in assorted finishes to enhance any design scheme.



4-Gang Rectangular

The Hubbell SystemOne 4-Gang Recessed Raised Access or Wood Floor Box delivers AV plus power. Similar to the 2-gang recessed raised access floor box, the 4-gang 2 ½ inch box depth provides a solution for floors using short pedestals. The 5 inch depth is ideal for applications with a lot of requirements. Rectangular covers in a variety of finishes will match any existing or new style.

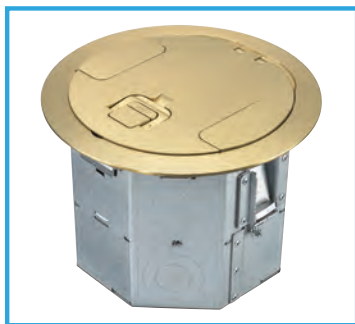

4-Gang Round

With an 8 in. diameter, the Hubbell SystemOne 4-Gang Round Recessed Floor Box is ideal for use in raised access floors with pre-cut tile or wood floor coverings. With a variety of finish selections, the round covers blend in with the flooring and overall design of the building. Deep, 2 ¾ in. wiring compartments are ready to accommodate today's most advanced, high-performance power, data and AV needs to supply reliable connectivity.



10-Gang Rectangular

Designed to serve high-capacity, multi-service applications, the 10-gang floor box supports installation with an array of Hubbell power, data and AV devices. Third-party mounting plates are available for other manufacturers' devices, including Extron®, Crestron® and FSR®. A 5 ½ in. box depth offers great capacity for connectivity, with the ability accept 2 in. conduit to meet growing AV and data needs. The rectangular covers come in a variety of colors and finishes to enhance any building's design.

Cover

- 180° cover opening
- Two large cable egress doors
- Listed to UL 514A and UL scrubwater compliant
- Die cast aluminum cover construction
- Available in round, rectangular and furniture feed styles
- All covers are ADA compliant 

Rectangular Boxes

- 16 gauge galvanized sheet metal
- 6 in. solid conductor ground pigtail in each gang
- Many boxes allow for 2 in. conduits
- Mounts in tiles ¾ in. to 2 in. thick
- Patent pending, labor saving, easy mount device plates
- Plenum rated box assemblies

Round Box

- Fits in 8 in. diameter air diffuser holes
- 16 gauge galvanized sheet metal construction
- Individual grounding screws for each gang
- 2 in. knock-out on the bottom allows for large amounts of data and/or AV devices
- Mounts in tiles ¾ in. to 2 in. thick
- Plenum rated box assemblies

Pre-Wired Assemblies

- AFB series boxes are available from our factory as pre-wired assemblies with CONNEXION modular plug-n-play system as shown on page O-38 and O-39
- Plenum rated box assemblies
- Contact Hubbell Territory Manager for details

Extron® is a registered trademark of Extron Electronics.
Crestron® is a registered trademark of Crestron Electronics, Inc.
FSR® is a registered trademark of FSR Inc.

Floor Boxes

Selecting a SystemOne Recessed Raised Access or Wood Floor Box

To assist with the floor box selection process please have the following information available:

Electrical requirements:	Box depth	Cover style:
<p>Power (each electrical device requires one gang) Data/AV (consult manufacturers' specification for size/volume requirements), number required.</p> <p>Add up total number to determine needed capacity. If necessary capacity is not shown round up to next size. Example: 9-Gang rounds up to a 10-Gang floor box.</p>	<p>Determine maximum tile thickness and stantion height and add together. Box depth can not exceed total.</p>	<p>Round</p> <p>Rectangular</p>

Once this information is gathered start on the right column "capacity" select necessary box, then select the concrete pour depth and on-grade or above-grade application, and finally cover style. Locate inter connecting point of all three categories and move to right to select correct catalog number.

- ① Capacity: Select necessary box.
- ② Box Depth: Determine maximum possible depth (tile and stantion height total) and select a depth less than the calculated height.
- ③ Cover Style: Select Round or Rectangular, not all box sizes are available in round.
- ④ Locate interconnecting point of all three categories and move to right to select correct catalog number.

		Box Depth ②					
		2 ½ in.	5 in.	5 ½ in.	6 ¼ in.		
Capacity ①	2-Gang	•	•				AFB2G25
		•	•				AFB2G25CHI
				•	•		AFB2G50
				•	•		AFB2G50CHI
	4-Gang	•					AFB4G25
		•					AFB4G25CHI
				•			AFB4G50
				•			AFB4G50CHI
						•	RAFB4BASE
	10-Gang				•		AFB10G55
					•		AFB10G55CHI
			Rectangular	Furniture Feed	Rectangular	Furniture Feed	Rectangular
		Cover Style ③					

Select Correct Catalog Number ④



Floor Boxes

Features and Benefits

SystemOne Recessed Benefits and Enhancements

Functionality

- Cables and connections are protected by recessed functionality
- Open architecture sub-plate design
- Dirt ingress reduced by egress door brushes
- Meets UL 514A scrubwater requirements with ScrubShield® technology
- Easy selection with common flange for all floor types
- Round and rectangular box versions available
- Plenum rated box assemblies

Value

- Enhance building décor with numerous finishes
- Increase durability and longevity with cast aluminum covers
- AFB series boxes are available from our factory as pre-wired assemblies with CONNEXION modular plug-n-play system

Online Resources

- BIM models, customer drawings and technical specifications are available on www.hubbell-wiring.com



Safety

- Low profile flanges meet ADA requirements
- Hide-away egress doors fold under cover while in use
- 180° opening of main doors



Covers

- Die cast construction available in five finishes
- Furniture feed includes one 2 in. conduit hub and one 1 in. conduit hub with reducer to 3/4 in.
- Maximum static load of 800 lbs. with 2x safety factor*

*Note: *Load applied through a 3 in. (76mm) mandrel in center of the cover.*

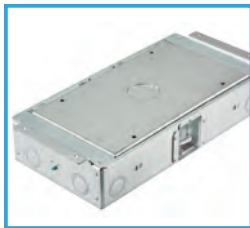

Rectangular Floor Boxes

- Standard or Chicago version available
- Temporary cover included

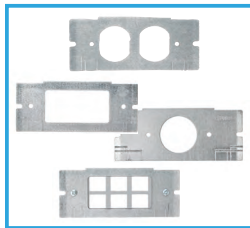

Plates

- For use with 2, 4 and 6-gang floor boxes
- Easy single screw mounting



Round Floor Boxes

- Corrosion resistant
- Temporary cover included

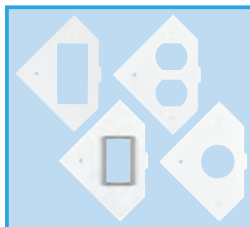

RAFB4 Plates

- All RAFB4SP series plates are powder coat white

Visit web site for information on Hubbell's Pre-wired, Plug and Play, Connexion System.

SystemOne Recessed 2-Gang Rectangular Floor Boxes, Covers and Plates For Use In Raised Access or Wood Floors

AFB series boxes are available from our factory as pre-wired assemblies with CONNEXION modular plug-n-play system



Aluminum Powder Coat



Black Powder Coat



Bronze Powder Coat



Brass Powder Coat

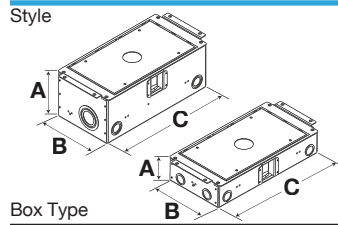

Box Type

Standard Chicago (No Knockouts)	AFB2G50 AFB2G50CHI	AFB2G25 AFB2G25CHI
Minimum Depth from Top of Floor Tile	5.32" (135.1)	2.88" (73.2)
Cubic Inch (cm ³) Capacity per Gang	60 cu. in. (980 cm ³)	30 cu. in. (491.7 cm ³)
Furniture Feed; Cubic Inch (cm ³) Capacity per Chamber	135 cu. in. (2212.2 cm ³)	78 cu. in. (1288.3 cm ³)
Dimensions – A	5.12" (130.1)	2.68" (68.2)
Dimensions – B	6.32" (160.5)	6.32" (160.5)
Dimensions – C	12.82" (325.6)	12.82" (325.6)
KO Trade Size: Ends	(2) ½", (2) 1", 1¼", 1½", 2"	(4) ½", ¾"
Sides	(4) ½", ¾", 1", 1¼"	(4) ½", ¾"
Bottom	(4) ½", ¾", 1", 1¼"	(2) ½", ¾", (2) 1", 1¼"
Floor Thickness	.62- 2.12" (15.7- 53.8)	.62- 2.12" (15.7- 53.8)
Cover Family	Rectangular	Rectangular
Temporary Cover Included	✓	✓

Note: UL File Number E31999.

Rectangular Covers (for use with raised access tiles and wood floors)

- Die cast construction available in five finishes
- Furniture feed includes one 2 in. conduit hub and one 1 in. conduit hub with reducer to ¾ in.
- Maximum static load of 800 lbs. with 2x safety factor*
- Furniture Feed Covers ship with low voltage dividers

Surface Cover Dimensions 15 in. x 8¾ in.

Finish	Without Insert	With Insert	Furniture Feed
Aluminum Powder Coat	2GAFBCVRLAU	2GAFBCVRLUC	2GAFBFFCVRLAU
Black Powder Coat	2GAFBCVRBK	2GAFBCVRBKC	2GAFBFFCVRBK
Brass Powder Coat	2GAFBCVRBRS	2GAFBCVRBRSC	2GAFBFFCVBRRS
Bronze Powder Coat	2GAFBCVRBRZ	2GAFBCVRBRZC	2GAFBFFCVBRZ
Satin Nickel Powder Coat	2GAFBCVRNK	2GAFBCVRNKC	2GAFBFFCVRNK

Note: *Load applied through a 3 in. (76mm) mandrel in center of the cover.

Plates - for use in 2 and 4-Gang Floor Boxes

- UL 514A listed

Plate Style	(1) Decorator Opening	(1) Duplex Opening	(2) Extron® MAA P Openings	(2) Extron® Openings	(2) 1U Hubbell iStation Openings
Cat. No.	FBMPREC	FBMPDUP	FBMPMAAP	FBMPAAP	FBMP2IM



Plate Style	(1) 1.5U Hubbell iStation Opening	(1) Simplex Opening 1.40 in. Diameter	(1) Twist-Lock® Opening 1.60 in. Diameter	1-Gang Blank	Cable Feed Through with Bushing
Cat. No.	FBMP15IM	FBMP139	FBMP156	FBMPBNK	FBMPFT



Plate Style	(1) Opening for TracJack® or Series II®	(2) Hubbell Jack Openings and (4) Jack KOs w/Label Field	(1) Opening with Hubbell ISF6 Frame for Keystone Jacks
Cat. No.	FBMPTRAC	FBMP6DJ	FBMP6KS



Extron® is a registered trademark of Extron Electronics. Crestron® is a registered trademark of Crestron Electronics, Inc. FSR® is a registered trademark of FSR Inc. TracJack®, Series II® and Ortronics® are registered trademarks of Ortronics/Legrand.

Dimensions in Inches (mm)

SystemOne Recessed 4-Gang Rectangular Floor Boxes, Covers and Plates For Use In Raised Access or Wood Floors

AFB series boxes are available from our factory as pre-wired assemblies with CONNEXION modular plug-n-play system

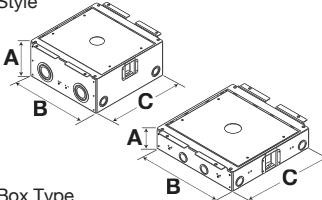
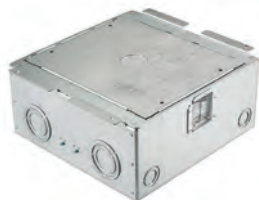
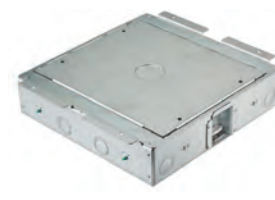
Style			
Box Type			
Standard Chicago (No Knockouts)	AFB4G50 AFB4G50CHI		AFB4G25 AFB4G25CHI
Minimum Depth from Top of Floor Tile	5.37" (136.4)		2.88" (73.2)
Cubic Inch (cm ³) Capacity per Gang	57.5 cu. in. (940 cm ³)		26.5 cu. in. (434.3 cm ³)
Dimensions – A	5.18" (131.4)		2.69" (68.3)
Dimensions – B	11.11" (282.2)		11.11" (282.2)
Dimensions – C	10.90" (276.9)		10.90" (276.9)
KO Trade Size: Ends	(2) ½", (4) 1", 1¼", 1½", 2"		(4) ½", ¾"
Sides	(4) ½", ¾", 1", 1¼"		(4) ½", ¾"
Bottom	(4) ½", ¾", 1", 1¼"		(4) ½", ¾", (4) 1", 1¼"
Floor Thickness	.62- 2.12" (15.7- 53.8)		.62- 2.12" (15.7- 53.8)
Cover Family	Rectangular		Rectangular
Temporary Cover Included	✓		✓

Note: UL File Number E31999.

Rectangular Covers (for use with raised access tiles and wood floors)

- Die cast construction available in five finishes
- UL 514A listed
- Maximum static load of 1500 lbs. with 2x safety factor*

Surface Cover Dimensions 13 in. x 13¼ in.

Finish	Without Insert	With Insert
Aluminum Powder Coat	4GAFBCVRALU	4GAFBCVRALUC
Black Powder Coat	4GAFBCVRBK	4GAFBCVRBKUC
Brass Powder Coat	4GAFBCVRBRS	4GAFBCVRBRSC
Bronze Powder Coat	4GAFBCVRBRZ	4GAFBCVRBRZC
Satin Nickel Powder Coat	4GAFBCVRNK	4GAFBCVRNKUC













Note: *Load applied through a 3 in. (76mm) mandrel in center of the cover.

Accessories

Description	Catalog Number
AFB4G series replacement dividers.	AFB4GDIVKIT

Plates - for use in 2 and 4-Gang Floor Boxes

- UL 514A listed

Plate Style	(1) Decorator Opening	(1) Duplex Opening	(2) Extron [®] MAAAP Openings	(2) Extron [®] Openings	(2) 1U Hubbell iStation Openings
Cat. No.	FBMPREC	FBMPDUP	FBMPMAAP	FBMPAAP	FBMP2IM
					
Plate Style	(1) 1.5U Hubbell iStation Opening	(1) Simplex Opening 1.40 in. Diameter	(1) Twist-Lock [®] Opening 1.60 in. Diameter	1-Gang Blank	Cable Feed Through with Bushing
Cat. No.	FBMP15IM	FBMP139	FBMP156	FBMPBNK	FBMPFT
					
Plate Style	(1) Opening for TracJack [®] or Series II [®]	(2) Hubbell Jack Openings and (4) Jack KOs w/Label Field	(1) Opening with Hubbell ISF6 Frame for Keystone Jacks		
Cat. No.	FBMPTRAC	FBMP6DJ	FBMP6KS		
					

Extron[®] is a registered trademark of Extron Electronics. Crestron[®] is a registered trademark of Crestron Electronics, Inc. FSR[®] is a registered trademark of FSR Inc. TracJack[®], Series II[®] and Ortronics[®] are registered trademarks of Ortronics/Legrand.

Dimensions in Inches (mm)

SystemOne Recessed 4-Gang Round Floor Boxes, Covers and Plates For Use In Raised Access or Wood Floors

AFB series boxes are available from our factory as pre-wired assemblies with CONNEXION modular plug-n-play system



RAFB4NKL
with Devices

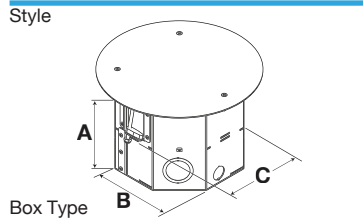

Box Type	Round	RAFB4BASE
Minimum Depth from Top of Floor Tile	6.47" (164.3)	
Cubic Inch (cm ³) Capacity per Gang	28.5 cu. in. (460 cm ³)	
Dimensions – A	6.41" (162.9)	
Dimensions – B	7.33" (186.2)	
Dimensions – C	8.05" (204.6)	
KO Trade Size: Sides	(2) 1/2" (2) 3/4", 1 1/2" - Concentric, (2) 1", 1 1/4" - Concentric	
Bottom	(1) 1 1/2", 2" (1) 3/4", 1" - Concentric, (1) 3/4", 1", 1 1/4" - Concentric	
Floor Thickness	.71" (19.1) - 2.50" (63.5)	
Temporary Cover Included		✓
ADA	Flange thickness is 1/8 inches thick and complies with ADA requirements	

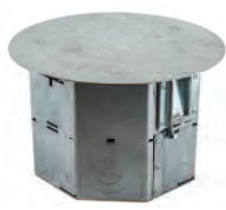

RAFB4BRS

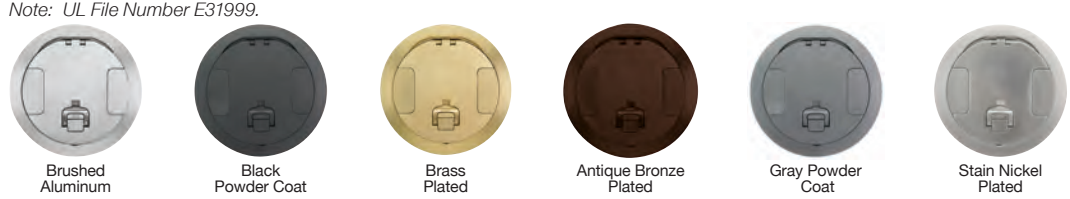

Brushed Aluminum

Black Powder Coat

Brass Plated

Antique Bronze Plated

Gray Powder Coat

Stain Nickel Plated

RAFB4 Series – Round Floor Box with Cover

Includes: **RAFB4BASE** and 8 in. cover

Cover Finish	Catalog Number
Brushed Aluminum	RAFB4ALU
Black Powder Coat	RAFB4BLK
Brass Plated	RAFB4BRS
Antique Bronze Plated	RAFB4BRZ
Gray Powder Coat	RAFB4GRY
Satin Nickel Plated	RAFB4NKL

8 Inch Round Covers- * 1,000 lbs. static cover load

Round covers are suitable for use with all floor types

Plate Style	Catalog Number
Brushed Aluminum	CFBS1R8CVRALU
Black Powder Coat	CFBS1R8CVRBLK
Brass Plated	CFBS1R8CVRBRS
Antique Bronze Plated	CFBS1R8CVRBRZ
Gray Powder Coat	CFBS1R8CVRGRY
Satin Nickel Plated	CFBS1R8CVRNKL

Note: *Load applied through a 3 in. (76mm) mandrel in center of the cover.

RAFB4 Series – Plates

- All **RAFB4SP** series plates are powder coat white

Plate Style	(1) Decorator	(1) Duplex	(1) Simplex Opening 1.40 in. Diameter	(1) Twist-Lock® Opening 1.60 in. Diameter	Blank
Cat. No.	RAFB4SPDECO	RAFB4SPDUPLEX	RAFB4SPPTL14	RAFB4SPPTL16	RAFB4SPBLANK

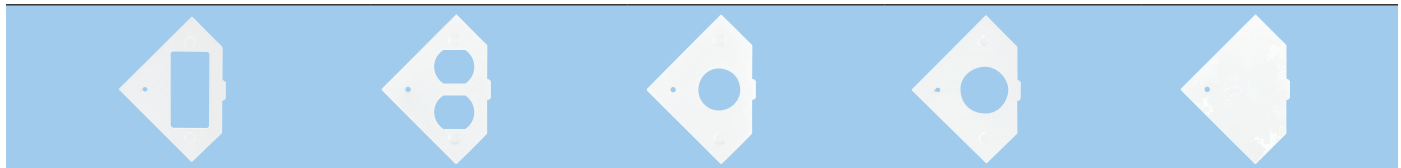
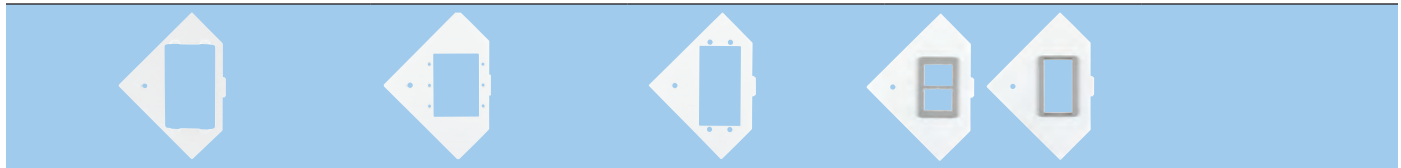

Plate Style	(1) Hubbell iStation Opening for 3 Units	(3) Extron® MAAP Modules	(2) Extron® AAP Modules	Opening to Accept Bezels for Ortronics TracJack®
Cat. No.	RAFB4SP3UIS	RAFB4SP3MAAP	RAFB4SP2AAP	RAFB4SPORT



Extron® is a registered trademark of Extron Electronics. Crestron® is a registered trademark of Crestron Electronics, Inc. FSR® is a registered trademark of FSR Inc. TracJack®, Series II® and Ortronics® are registered trademarks of Ortronics/Legrand.
Dimensions in Inches (mm)

SystemOne Recessed 8*/10-Gang Rectangular Floor Boxes, Covers and Plates For Use In Raised Access or Wood Floors

AFB series boxes are available from our factory as pre-wired assemblies with CONNEXION modular plug-n-play system

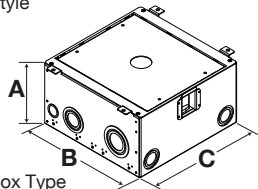
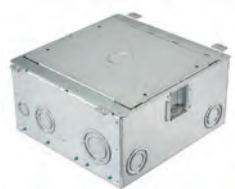
Style		
Box Type		
Standard	AFB10G55	
Chicago (No Knockouts)	AFB10G55CHI	
Min. Depth from Top of Floor Tile	5.95" (151.1)	
Cubic Inch (cm ³) Capacity per Gang	(2) 25 cu. in. (407.9 cm ³), (2) 50 cu. in. (819.4 cm ³), (2) 71 cu. in. (1163.5 cm ³)	
Dimensions – A	5.74" (145.9)	
Dimensions – B	11.11" (282.2)	
Dimensions – C	10.66" (270.7)	
KO Trade Size: Ends	(2) ½", ¾", (2) ¾", 1", 1¼", 1½", (2) 1", 1¼", 1½", 2"	
Sides	(4) ¾", 1", 1¼", 1½"	
Bottom	(2) ½", ¾", (4) ½", ¾", 1", 1¼"	
Floor Thickness	.56" (1.2) - 2.12" (53.8)	
Cover Family	Rectangular	
Temporary Cover Included	✓	

Note: UL File Number E31999.

















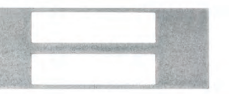





Rectangular Covers (for use with raised access tiles and wood floors)

- Die cast construction available in five finishes
- UL 514A listed
- Maximum static load of 1500 lbs with 2x safety factor**

Finish	Surface Style Covers	
	Without Insert	With Insert
Aluminum Powder Coat	10GAFBCVRALU	10GAFBCVRALUC
Black Powder Coat	10GAFBCVRBK	10GAFBCVRBKC
Brass Powder Coat	10GAFBCVRBRS	10GAFBCVRBRSC
Bronze Powder Coat	10GAFBCVRBRZ	10GAFBCVRBRZC
Satin Nickel Powder Coat	10GAFBCVRNK	10GAFBCVRNKC

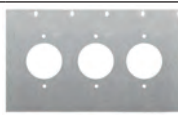
Note: **Load applied through a 3 in. (76mm) mandrel in center of the cover.

Plates for Use in SystemOne 8*/10-Gang Floor Boxes

Plate Style	(1) Decorator Opening	(1) Duplex Opening	Blank	Decorator Opening Plate Including Hubbell ISF6GY	(2) Openings to Accommodate (6) Ortronics TracJack®
Cat. No.	FB10MPREC	FB10MPDUP	FB10MPBNK	FB10MPKEY	FB10MPTRAC
					
Plate Style	(2) Decorator	(2) Duplex Openings	(4) Extron® MAAP Modules	(4) Extron® AAP Modules	For (6) 1U Hubbell iStation Modules
Cat. No.	FB10MP2A	FB10MP2E	FB10MPMAAP	FB10MPAAP	FB10MP2B
					
Plate Style	(1) Twist-Lock® Opening 1.60 in. Dia. (Uses 2-Gangs)	(1) Simplex Opening 1.40 in. Dia. (Uses 3-Gangs)	(2) Twist-Lock® Opening 1.60 in. Dia. (Uses 3-Gangs)	(2) Simplex Opening 1.40 in. Dia. (Uses 3-Gangs)	(1) Opening for Appliance Receptacle (Uses 3-Gangs)
Cat. No.	FB10TLA	FB10TLX	FB10TLB	FB10TLY	FB10MP3GAPP
					
Plate Style	(3) Twist-Lock® Opening 1.60 in. Dia. (Uses 5-Gangs)	(3) Simplex Opening 1.40 in. Dia. (Uses 5-Gangs)	(2) 2-Gang. Meets NEMA Spacing. Ideal for Crestron® DM-TX Product and Power (Uses 5-Gangs)	(4) Single Service Openings Utilizing NEMA Wallplate (Uses 5-Gangs)	
Cat. No.	FB10TLC	FB10TLZ	FB10MPNEMA2XG*	FB10MPNEMA4G*	
					

Note: *Use with FB10MPNEMA2XG and/or FB10MPNEMA4G for 8-gang configuration.

Extron® is a registered trademark of Extron Electronics. Crestron® is a registered trademark of Crestron Electronics, Inc. FSR® is a registered trademark of FSR Inc. TracJack®, Series II® and Ortronics® are registered trademarks of Ortronics/Legrand.

Dimensions in Inches (mm)

Features and Benefits

SystemOne 4 inch Recessed Floor Box, for Raised Access and Wood Floors

The AFBS1R4 floor box was designed for use in raised access or wood floors. It installs easily into a 4 inch diameter hole and is retained by two sets of retaining bars on the side. Electrical connections are made below the walking surface to protect the electrical devices and increase safety by reducing tripping hazards. Intended for areas that require basic power requirements - one duplex, a duplex with two data jacks or a quadplex - the unobtrusive design will blend into any setting. Available in six architectural finishes and utilizing a flange that is ADA compliant at 1/8 inch thick, Hubbell SystemOne Floor Boxes harmonize aesthetics with function and safety.

- UL listed, scrubwater compliant
- Plenum rated box assembly
- Factory configurable with CONNEXION modular plug-n-play system



Box Design

- Durable die-cast aluminum box construction
- Flexible single or dual service
- Easily installs in 4 inch diameter hole, 5⁵/₈ inch device depth
- Four 1/2 inch side knockouts
- One 1, 3/4 and 1/2 inch concentric bottom knockout



Covers

- Durable die-cast aluminum cover
- 1,000 lbs, static load rated cover
- Available in six architectural finishes



Safety

- Increased safety with recessed connections
- Low profile flanges meet ADA requirements 
- Hide-away egress door fold under cover while in use
- 180° opening of main doors



Easy Mount Device Plates

- All S1R4SP series plates are powder coat white



Applications

- Raised access and wood floor applications in commercial and residential buildings



Pre-Wired Assemblies

- AFBS1R4 series boxes are available from our factory as pre-wired assemblies with CONNEXION modular plug-n-play system
- Contact Hubbell Territory Manager for details

SystemOne 4 inch Recessed Floor Box, for Raised Access and Wood Floors

AFB series boxes are available from our factory as pre-wired assemblies with CONNEXION modular plug-n-play system

Description	Catalog Number
Floor Box with temporary installation Cover	AFBS1R4BASE
Floor Box (AFBS1R4BASE) with Brushed Aluminum Finish Cover (AFBS1R4CVRALU)	AFBS1R4ALU
Floor Box (AFBS1R4BASE) with Black Powder Coat Finish Cover (AFBS1R4CVRBLK)	AFBS1R4BLK
Floor Box (AFBS1R4BASE) with Plated Brushed Brass Finish Cover (AFBS1R4CVRBRS)	AFBS1R4BRS
Floor Box (AFBS1R4BASE) with Plated Antique Bronze Finish Cover (AFBS1R4CVRBRZ)	AFBS1R4BRZ
Floor Box (AFBS1R4BASE) with Gray Powder Coat Finish Cover (AFBS1R4CVRGRY)	AFBS1R4GRY
Floor Box (AFBS1R4BASE) with Plated Satin Nickel Finish Cover (AFBS1R4CVRNKL)	AFBS1R4NKL

Note: UL File Number E31999.

Replacement Parts

Description	Catalog Number
Low Voltage Divider	AFBS1R4DIV
Replacement Bottom Knockouts	AFBS1R4BOTTOM

Installation



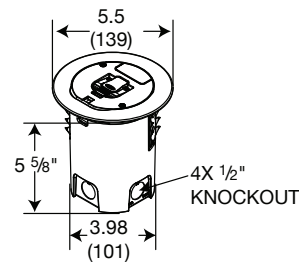

Hole Diameter	4 inch
Bottom Knock out	1 inch, ¼ inch, ½ inch concentric
Side knock out	(4) ½ inch

Covers

- Flange diameter is 5.5 inches
- Flange thickness is ⅛ inches thick and complies with ADA requirements
- Cover load rating is 1,000 lbs, for a static load applied through a 3 inch dia. mandrel with 2x safety factor*





Architectural Covers









Description / Catalog Number	Cover	Description / Catalog Number	Cover
Brushed Aluminum Finish, Single fold under cable egress door. AFBS1R4CVRALU		Plated Antique Bronze Finish, Single fold under cable egress door. AFBS1R4CVRBRZ	
Plated Brushed Brass Finish, Single fold under cable egress door. AFBS1R4CVRBRS		Plated Satin Nickel Finish, Single fold under cable egress door. AFBS1R4CVRNKL	

Note: *Load applied through a 3 in. (76mm) mandrel in center of the cover.

Powder Coat Covers

Description / Catalog Number	Cover
Black Powder Coat Finish, Single fold under cable egress door. AFBS1R4CVRBLK	
Gray Powder Coat Finish, Single fold under cable egress door. AFBS1R4CVRGRY	

Device Mounting Plates

Description / Catalog Number	Sub-plate	Description / Catalog Number	Sub-plate	Description / Catalog Number	Sub-plate
2X2 Sub-plate with (1) Style Line® decorator device opening and (2) keystone jack openings S1R4SP2X2STYLE		(1) Style Line® decorator device opening for power or datacom applications S1R4SPSTYLE		2X2 Sub-plate with (1) decorator device opening and (2) Ortronics® TracJack® openings S1R4SP2X2STYLETJ	
2X2 Sub-plate with (1) duplex device opening and (2) keystone jack openings S1R4SP2X2DUPLEX		(1) Duplex device opening for power or datacom applications S1R4SPDUPLEX		2X2 Sub-plate with (1) duplex device opening and (2) Ortronics® TracJack® openings S1R4SP2X2DUPLEXTJ	
(4) Single 20A receptacles. Can be wired as single or two circuit with isolated ground capability, 12 inch wire leads Includes Ⓢ stickers. S1R4SPQUAD		(1) 1.60 inch opening for 20 or 30A Twist-Lock® receptacle S1R4SPTWIST		(1) 1.40 inch opening for simplex receptacle S1R4SPSIMPLEX	

TracJack®, Series II® and Ortronics® are registered trademarks of Ortronics/Legrand.

Dimensions in Inches (mm)

Features and Benefits

SystemOne 6 inch Furniture Feed Floor Box, for Raised Access and Wood Floors

The AFBS1R6FF floor box is designed for use in raised access or wood floors. It installs easily into a 6 inch diameter hole and is retained by two pawl arms which swing outwards when tightened by a screw driver. Providing the lowest profile in the industry, the 1/8 inch flange thickness is ADA compliant. The box can also serve as a wiring chamber for power if needed.

Available in six architectural finishes, Hubbell SystemOne Floor Boxes harmonize aesthetics with function and safety.

- UL listed, scrubwater compliant
- Plenum rated box assembly
- Factory configurable with CONNEXION modular plug-n-play system



Pre-Wired Assemblies

- AFBS1R6 series boxes are available from our factory as pre-wired assemblies with CONNEXION modular plug-n-play system
- Contact Hubbell Territory Manager for details

6 inch Recessed Floor Boxes

Description	Catalog Number
Floor Box with Temporary Installation Cover	AFBS1R6BASE
Floor Box (AFBS1R6BASE) with Brushed Aluminum Finish Cover (AFBS1R6FFCVRALU)	AFBS1R6FFALU
Floor Box (AFBS1R6BASE) with Black Powder Coat Finish (AFBS1R6FFCVRBLK)	AFBS1R6FFBLK
Floor Box (AFBS1R6BASE) with Brushed Brass Plated Finish Cover (AFBS1R6FFCVRBRS)	AFBS1R6FFBRS
Floor Box (AFBS1R6BASE) with Antique Bronze Plated Finish Cover (AFBS1R6FFCVRBRZ)	AFBS1R6FFBRZ
Floor Box (AFBS1R6BASE) with Gray Powder Coat Finish Cover (AFBS1R6FFCVRGRY)	AFBS1R6FFGRY
Floor Box (AFBS1R6BASE) with Plated Satin Nickel Finish Cover (AFBS1R6FFCVRNKL)	AFBS1R6FFNKL

Note: UL File Number E31999.

6 Inch Round Covers

- Flange Diameter 7.5 inches
- Flange thickness is 1/8 inches thick and complies with ADA requirements
- Cover load rating is 1,000 lbs, for a static load applied through a 3 inch dia. mandrel with 2x safety factor*

Finish	Catalog Number
Brushed Aluminum	AFBS1R6FFCVRALU
Black Powder Coat	AFBS1R6FFCVRBLK
Brass Plated	AFBS1R6FFCVRBRS
Antique Bronze Plated	AFBS1R6FFCVRBRZ
Gray Powder Coat	AFBS1R6FFCVRGRY
Satin Nickel Plated	AFBS1R6FFCVRNKL

Note: *Load applied through a 3 in. (76mm) mandrel in center of the cover.

Replacement Parts

Description	Catalog Number
Low Voltage Divider	AFBS1R6DIV
Low Voltage Grommet	AFBS1R6GROM
Low Voltage Gate	AFBS1R6GATE

Installation

Hole Diameter	6 inch
Bottom low Voltage Knock out	2 inch
Side low voltage entry	Removable gate, area equal to 2 inch conduit
Bottom Power Knock out	3/4" 1/2" concentric
Side Power knock out	3/4" 1/2" concentric
Fastening	2 pawl arms

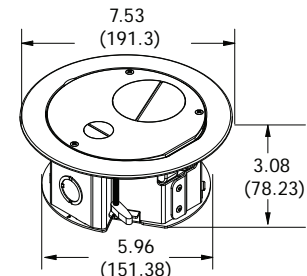

AFBS1R6BASE



AFBS1R6FFBLK



AFBS1R6FFCVRBRS



AFBS1R6DIV



AFBS1R6GROM



AFBS1R6GATE

Dimensions in Inches (mm)

SystemOne Fire-Rated Poke-Through and Floor Box Recessed Covers



Two Concrete Floor Applications

Fire-Rated Poke-Throughs are used when the conduits can't be installed in the concrete floor and for tenant improvements.



Floor boxes in concrete applications are used when the connecting conduits can be installed into the concrete floor.



Same Results!

Dynamic Round low profile durable covers

Recessed Cover Activation

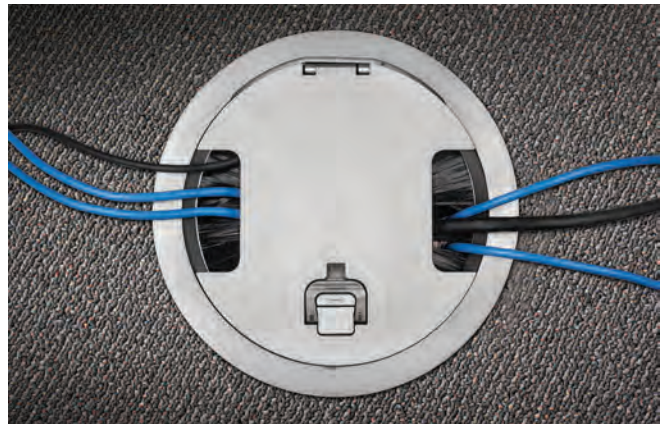

or Furniture Feed Cover Activation

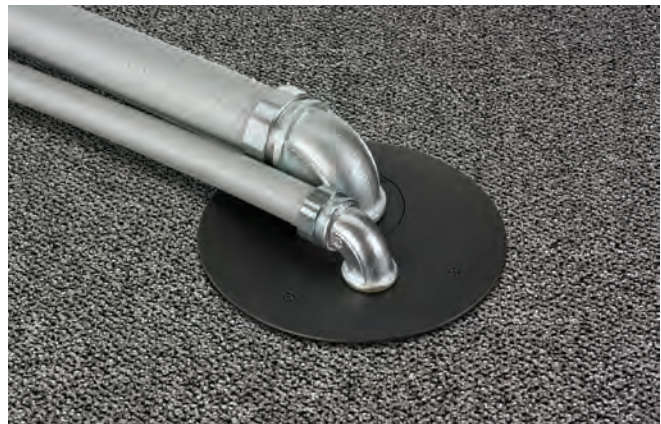

SECTION P

Table of Contents



Hubbell SystemOne Recessed Systems 10, 8, 6 & 4 Inch



Hubbell SystemOne Multi-Service Applications



Hubbell Pedestal Multi-Service Applications



Product	Page
Hubbell SystemOne Recessed Systems	P-2
How to Order	P-4
10 Inch FRPT, Kits and Covers	P-7
10 Inch Sub-Plates and Bottom Feed Plates	P-8
10 Inch Accessories and Replacement Parts	P-10
8 Inch Kits	P-13
8 Inch FRPT, Covers and Accessories	P-14
8 Inch Sub-Plates	P-15
6 Inch Kits	P-17
6 Inch FRPT, Covers and Accessories	P-18
6 Inch Sub-Plates	P-19
4 Inch Kits, FRPT and Covers	P-21
4 Inch Sub-Plates and Accessories	P-22
4 Inch Furniture Feed Kits, Covers & Accessories	P-24
Hubbell SystemOne Flush Systems	P-25
4 Inch One-Piece Units	P-27
4 Inch Three-Piece Units	P-28
Sub-Plates and Accessories	P-29
Configuration Chart	P-30

Product	Page
2X2 Flush FRPT 3 Inch Core Hole Units	
One and Two-Piece Units	P-31
Service Fittings and Accessories	P-31
Flush Duplex FRPT 3 Inch Core Hole Units	
One and Two-Piece Units	P-32
Service Fittings and Accessories	P-32
Flush Furniture Feed FRPT 3 Inch Core Hole Units	
Large Capacity, One and Two-Piece Units	P-33
Service Fittings	P-33
Painted Pedestal FRPT 2 and 3 Inch Core Hole Units	
Large Capacity, Two-Piece Units	P-34
Pedestal Service Fittings and Face Plates	P-34
Brushed Aluminum Pedestal FRPT	
3 Inch Core Hole Two-Piece Units	P-35
Pedestal Plates and Accessories	P-35
Technical Information	P-36

Fire-Rated Poke-Throughs

Hubbell SystemOne Recessed FRPTs

Hubbell's SystemOne Recessed Fire-Rated Poke-Throughs (FRPT) enhance functionality providing increased power, data and AV capacity. Safety is improved with recessed connectivity, a low profile flange, and egress doors that hinge inwards. Building value is enhanced with plated finishes to match and blend with modern building décor.

10 Inch Concrete Core Hole Applications...



High Capacity Multimedia Applications

Sub-plate layout for the center four gangs of the ten inch FRPT allows for maximum AV capacity. The NEMA spacing plate allows the product flexibility to easily accept 3rd party products.



Sub-Plates Offer Application Flexibility

Perimeter sub-plates for the ten inch FRPT help compliment the AV or data in the center four gangs. Additionally these plates can be exchanged for other low voltage compatible plates.

10 Inch Recessed Access

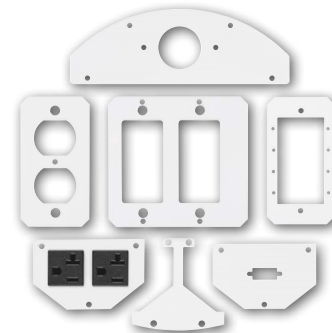

Center Sub-Plates
with Perimeter Sub-plates

8 Inch Concrete Core Hole Applications...



High Capacity Multimedia Applications

Sub-plate layout for the center three gangs of the eight inch FRPT allows for maximum AV capacity. The NEMA spacing allows the product flexibility to easily accept 3rd party products.



Sub-Plates Offer Application Flexibility

Perimeter sub-plates for the eight inch FRPT help compliment the AV or data in the center three gangs. Additionally these plates can be exchange for other low voltage compatible plates.

8 Inch Recessed Access

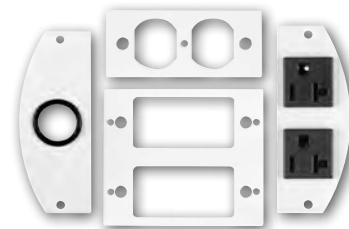

Center Sub-Plates
with Perimeter Sub-plates

Fire-Rated Poke-Throughs

Hubbell SystemOne Recessed FRPTs

Hubbell's SystemOne Recessed Fire-Rated Poke-Throughs (FRPT) enhance functionality by providing increased power, data and AV capacity. Safety is improved with recessed connectivity, a low profile flange, and egress doors that hinge inwards. Building value is enhanced with plated finishes to match and blend with modern building décor.

6 Inch Concrete Core Hole Applications...



60/40 6 Inch Sub-Plate Split

An Industry first, the 60/40 sub-plate layout allows for unmatched capacity with up to 12 keystone jacks and one 20A duplex.



50/50 6 Inch Sub-Plate Split

Two duplexes with ample AV and data are achieved by using the 50/50 sub-plate layout. Additionally this layout will accommodate two Style Line® devices for GFCI, surge, etc. applications.

6 Inch Recessed Access

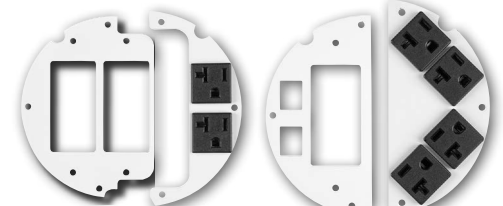

60/40 split
Sub-Plates

50/50 split
Sub-Plates

4 Inch Concrete Core Hole Applications...



4 Inch Quad Sub-Plate

The pre-wired quad sub-plate can be wired as one circuit or two and includes 12 inch of stranded wire.



4 Inch 2X2 Sub-Plate

The 2x2 sub-plates are available with Style Line® or traditional duplex openings and can accommodate up to two keystone jacks.

4 Inch Recessed Access

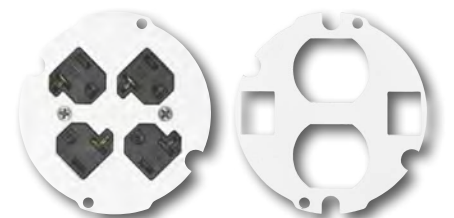

Quad Sub-Plate

Multi & Single Service
Sub-Plates

How to Order 10, 8, 6 and 4 Inch SystemOne Products

STEP 1: Select Recessed Access Poke-Through

10 Inch



8 Inch



6 Inch



4 Inch



Or Select Furniture Feed Poke-Through

10 Inch



8 Inch



6 Inch



4 Inch



STEP 2: Select Recessed Access Sub-Plate

10 Inch

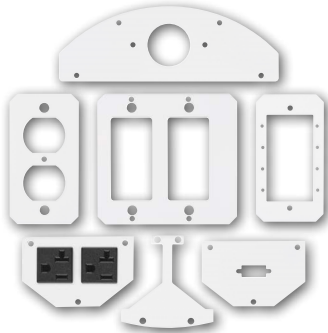

Center Sub-Plates
with Perimeter Sub-plates

8 Inch

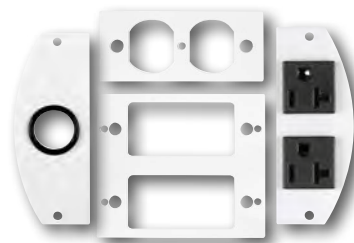

Center Sub-Plates
with Perimeter Sub-plates

6 Inch

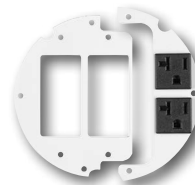

60/40 Split
Sub-Plates

4 Inch



Quad
Sub-Plates

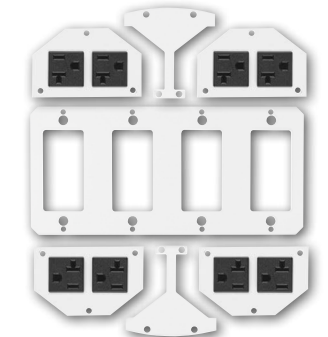

Open Data/AV Center Sub-Plate with
Perimeter Power Sub-Plates



3-Gang Data/AV Center Extension with
Perimeter Power Sub-Plates

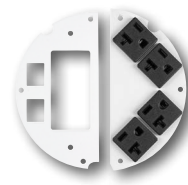

50/50 Split
Sub-Plates



2X2
Sub-Plates

Note: Furniture feed version does not require sub-plates.

How to Order 10, 8, 6 and 4 Inch SystemOne Products

STEP 3: Select Recessed Cover (Aluminum cover shown, see below for all available finishes)



Note: Tamper-Resistant 10 inch covers are also available.

Or Select Furniture Feed Cover (Aluminum cover shown, see below for all available finishes)



Available Cover Finishes

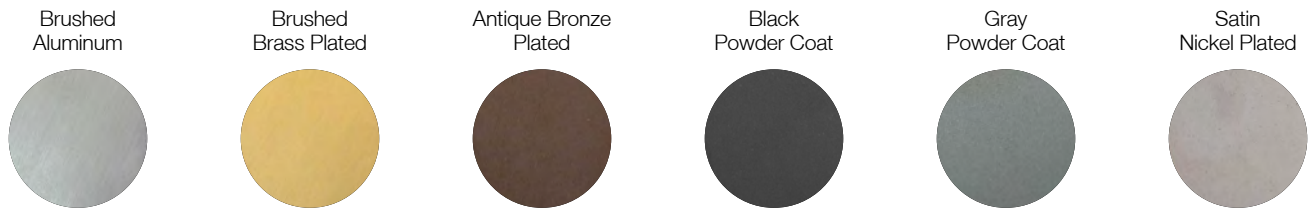

Recommended Fire-Rated Poke-Through Size Chart

To avoid over or under utilizing the capacity of the fire-rated poke-through, first determine how many gangs of power, data and AV are required for the application. The matrix below will guide you to the correct poke-through size.

		Recommended Fire-Rated Poke-Through Size					
POWER GANGS	5	8"	10"	10"	10"	Exceeds capacity of Hubbell recessed poke-throughs	
	4	8"	8"	10"	10"		
	3	6"	8"	8"	10"	10"	
	2	6"	6"	8"	8"	10"	10"
	1	4"	6"	6"	8"	8"	10"
	0	—	4"	6"	8"	8"	8"
		0	1	2	3	4	5
		DATA AND AV GANGS					

Example: 2-gangs of power, 1-gang of AV and 1-gang of data is required. Find the intersection for 2 power gangs with 2 data/AV gangs. The highlighted intersection defines the recommended FRPT.

Features and Benefits

SystemOne Recessed 10 Inch Fire-Rated Poke-Through Fittings

- The most dynamic FRPT system with the largest capacity available to meet all multimedia applications where power and voice/data are required
- Maintains concrete floor fire rating up to two hours
- Tamper-resistant recessed covers available
- Furniture feed cover available with (2) generous 2 inch NPT low voltage hubs and (2) 1 inch NPT power hubs
- Features ScrubShield® technology that exceeds UL514A scrubwater exclusion requirements
- Works with time and labor saving 10" concrete pre-pour tube



10 Inch FRPT with Accessories



FRPT Design

- Step down installation
- Flexible single or multi-service
- Recessed connections



Covers

- Durable die-cast aluminum cover
- 1,000 lbs, static load rated cover
- Available as recessed or furniture feed
- Tamper-resistant recessed covers available
- Available in six architectural finishes



FRPT Chambers

- 4 inch deep access chamber
- 4.43 inch deep center device chamber
- Dividers to make up to 8 individual services
- Perimeter to perimeter wiring tunnel



Easy Mount Device Plates

- Multiple, open architecture mounting plates for power, data and AV
- 4 center gangs
- 2 full or 4 half independent perimeter gangs



Safety

- Low profile flange, 0.16 inch exceeds ADA requirements
- Two hide-away egress doors fold under cover while in use
- 180° opening of main door

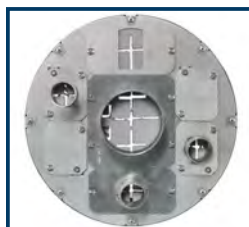

Bottom Feed Plates

- 9 center chamber and 6 perimeter adaptable feed plates
- Center chamber ranges from 1/2" to 2-1/2"
- Perimeter ranges from 1/2" to 1-1/4"

SystemOne Recessed 10 Inch Core Hole Kits, for Use In Concrete Floors

10 Inch Fire-Rated Poke-Through

Hubbell SystemOne 10 Inch Recessed Floor Fitting with Installation Cover

Catalog Number

S1R10PTFIT

Approved for use in the City of Chicago with EMT and full blank bottom feed plates.

Note: See page P-36 for technical information.



S1R10PTFIT

10 Inch Fire-Rated Poke-Through Kits

Kits include:

- (1) Hubbell SystemOne 10 inch recessed floor fitting (S1R10PTFIT)
- (2) Hubbell SystemOne 10 inch perimeter device mounting brackets (S1R10PSPREPBRKT)
- (4) Hubbell SystemOne 10 inch bottom center pass through plate (S1R10CBFPT)
- (3) Hubbell SystemOne 10 inch bottom perimeter blank plate (S1R10PBFBLANK)
- (1) Hubbell SystemOne 10 inch bottom perimeter 3/4 inch plate (S1R10PBF075)
- (1) Hubbell SystemOne 10 inch perimeter divider (S1R10PERIMDIV)
- (1) Hubbell SystemOne 10 inch center divider (S1R10CENTERDIV)
- (1) Hubbell SystemOne 10 inch flange and universal cover assembly (S1R10CVRxx)

Cover Finish

- Brushed Aluminum
- Black Powder Coat
- Brushed Brass Plated
- Antique Bronze Plated
- Gray Powder Coat
- Satin Nickel Plated

Catalog Number

- S1R10PTALU**
- S1R10PTBLK**
- S1R10PTBRS**
- S1R10PTBRZ**
- S1R10PTGRY**
- S1R10PTNKL**



S1R10PTBRS

Pre-Wired 10 Inch Fire-Rated Poke-Through Kits

Kits include:

- (1) Hubbell SystemOne 10 inch recessed floor fitting (S1R10PTFIT)
- (2) 20A pre-wired receptacle sub-plates with 24 inch wire leads (S1R10PSPZ)
- (2) Hubbell SystemOne 10 inch perimeter device mounting brackets (S1R10PSPREPBRKT)
- (4) Hubbell SystemOne 10 inch bottom center pass through plate (S1R10CBFPT)
- (3) Hubbell SystemOne 10 inch bottom perimeter blank plate (S1R10PBFBLANK)
- (1) Hubbell SystemOne 10 inch bottom perimeter 3/4 inch plate (S1R10PBF075)
- (1) Hubbell SystemOne 10 inch perimeter divider (S1R10PERIMDIV)
- (1) Hubbell SystemOne 10 inch center divider (S1R10CENTERDIV)
- (1) Hubbell SystemOne 10 inch flange and universal cover assembly (S1R10CVRxx)

Cover Finish

- Brushed Aluminum
- Black Powder Coat
- Brushed Brass Plated
- Antique Bronze Plated
- Gray Powder Coat
- Satin Nickel Plated

Catalog Number

- S1R10PTZALU**
- S1R10PTZBLK**
- S1R10PTZBRS**
- S1R10PTZBRZ**
- S1R10PTZGRY**
- S1R10PTZNKL**



S1R10PTZBLK

Receptacles feature single circuit wiring

Note: xx indicates finish options.

Recessed 10 Inch Covers

The 10 inch FRPT cover assembly unit includes solid cast aluminum construction and mounting hardware. Covers are recessed and available in a number of durable, yet beautiful finishes to match any décor. The flange height of 0.16 inch exceeds ADA requirement and suitable for use on any floor finish. All covers are UL514A, scrubwater compliant. Furniture Feed covers includes (2) 2" Threaded Hubs & (2) 1" Threaded Hubs with 3/4" Reducers.



10 Inch Fire-Rated Poke-Through Covers

Finish	Recessed Cover Catalog Number	TR Recessed Cover* Catalog Number	Furniture Feed Cover** Catalog Number
Brushed Aluminum	S1R10CVRALU	S1R10CVRTRALU	S1R10FFCVRALU
Black Powder Coat	S1R10CVRBLK	S1R10CVRTRBLK	S1R10FFCVRBLK
Brushed Brass Plated	S1R10CVRBRS	S1R10CVRTRBRS	S1R10FFCVRBRS
Antique Bronze Plated	S1R10CVRBRZ	S1R10CVRTRBRZ	S1R10FFCVRBRZ
Gray Powder Coat	S1R10CVRGRY	S1R10CVRTRGRY	S1R10FFCVRGRY
Satin Nickel Plated	S1R10CVRNKL	S1R10CVRTRNKL	S1R10FFCVRNKL

Note: COVER LOAD RATING: 1,000 lbs with 2x safety factor. Load applied through a 3" (76mm) dia. mandrel at the center of the cover. Rated for static loads only.

*Tamper-resistant covers ship with (1) S1RTR10BIT Torx-T10 bit.

** (2) 1" NPT plugs for power with (2) 1" to 3/4" reducers and (2) 2" NPT plugs for Low Voltage.

SystemOne Recessed 10 Inch Sub-Plates and Bottom Feed Plates

Perimeter Plate Configurations

- Available in pre-wired duplexes or openings to accommodate third party AV devices
- Available in full or 1/2 gang plates



Perimeter Sub-Plates - Full Gang

Description/Cat. No.	Sub-plate	Description/Cat. No.	Sub-plate	Description/Cat. No.	Sub-plate
(1) Style Line® decorator opening S1R10PSPD		(1) Duplex opening S1R10PSPDI		(1) 1.40" opening for simplex or 15A Twist-Lock® S1R10PSPJ	
(4) Extron® MAPP openings S1R10PSPC		(2) Extron® AAP openings S1R10PSPA		(1) 1.60" opening for 20A & 30A Twist-Lock® S1R10PSPG	

Perimeter Sub-Plates - 1/2 Gang*

Description/Cat. No.	Sub-plate	Description/Cat. No.	Sub-plate	Description/Cat. No.	Sub-plate	Description/Cat. No.	Sub-plate
(2) 20A pre-wired receptacles; 24" lead; one circuit (Supplied with isolated ground sticker) S1R10PSPZ		(2) 20A pre-wired receptacles; 25 foot lead; one circuit (Supplied with isolated ground sticker) S1R10PSPZ25		(2) 20A pre-wired receptacles; 24" lead; one circuit (Supplied with isolated ground sticker). Marked with "Controlled" S1R10PSPZC		(2) 20A pre-wired receptacles; 25 foot lead; one circuit (Supplied with isolated ground sticker). Marked with "Controlled" S1R10PSPZ25C	
(2) 20A pre-wired tamper resistant receptacles; 24 Inch lead; one circuit (Supplied with controlled and isolated ground stickers) S1R10PSPZTR		(1) Unit Hubbell I-STATION opening S1R10PSPF		(1) VGA/HDMI/DP opening S1R10PSPH		(1) XLR opening S1R10PSPQ	
Perimeter device bracket. S1R10PSPREPBRKT		Blank cover plate S1R10PSPB		(2) Extron® MAPP openings S1R10PSPV			

Note: *Requires S1R10PSPREPBRKT. See page P-7 for covers and P-10 for accessories.

10 Inch Bottom Feed Plates

1-Gang Center Bottom Feed Plates	Catalog Number
1/2 inch EMT Feed	S1R10CBF050
3/4 inch EMT Feed	S1R10CBF075
1 inch EMT Feed	S1R10CBF100
1 1/4 inch EMT Feed	S1R10CBF125
Blank	S1R10CBFBLANK
Pass through	S1R10CBFPT**
2-Gang Center Bottom Feed Plates	
1 1/2 inch EMT Feed	S1R10CBF150
2 inch EMT Feed	S1R10CBF200
2 1/2 inch EMT Feed	S1R10CBF250*
Perimeter Bottom Feed Plates	
1/2 inch EMT Feed	S1R10PBF050
3/4 inch EMT Feed	S1R10PBF075
1 inch EMT Feed	S1R10PBF100
1 1/4 inch EMT Feed	S1R10PBF125
Blank	S1R10PBFBLANK
Pass through	S1R10PBFPT**

Note: *Data/AV wiring only.

**Not approved for use in the City of Chicago.

See page P-36 for technical information.

Extron® is a registered trademark of Extron Electronics. Crestron® is a registered trademark of Crestron Electronics, Inc. FSR® is a registered trademark of FSR Inc.

10 Inch FRPT Bottom View

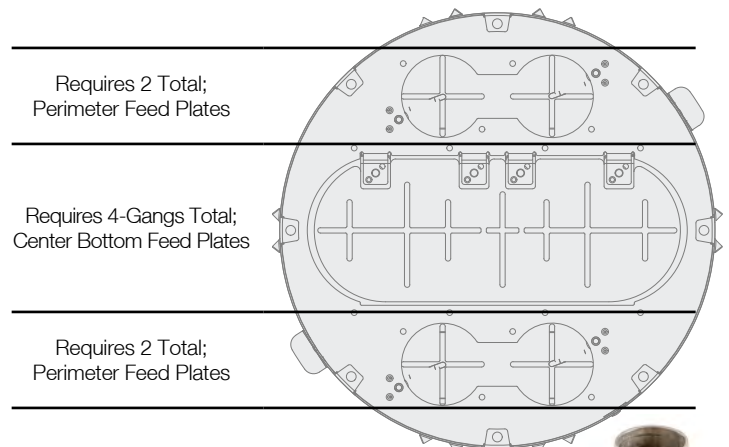

1-Gang Center Bottom Feed Plate



2-Gang Center Bottom Feed Plate*



Perimeter Bottom Feed Plate









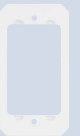

SystemOne Recessed 10 Inch Sub-Plates

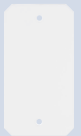
Center Plate Configurations





- 1, 2, 3 and 4 Gang Device Plates
- Accept third party AV devices (i.e. Extron[®], Crestron[®], FSR[®])
- Multi-gang NEMA spaced plates available







Center Sub-Plates - Single Gang

Description/Cat. No.	Sub-plate	Description/Cat. No.	Sub-plate	Description/Cat. No.	Sub-plate	Description/Cat. No.	Sub-plate
(1) Style Line [®] decorator opening		3 Unit Hubbell iSTATION opening		(1) Duplex opening		Blank cover plate	
S1R10CSPD		S1R10CSPL		S1R10CSPI		S1R10CSPB	
(1) XLR opening		(2) XLR openings		(1) 1.40" opening for simplex or 15A Twist-Lock [®]		(1) 1.60" opening for 20A & 30A Twist-Lock [®]	
S1R10CSPX		S1R10CSP2X		S1R10CSPJ		S1R10CSPG	
(1) VGA/HDMI/DP opening		(2) VGA/HDMI/DP openings		(4) Extron [®] MAPP openings		Ortronics [®] TracJack [®] / Series II [®] opening	
S1R10CSPH		S1R10CSP2H		S1R10CSPC		S1R10CSPK	

Center Sub-Plates - Two Gang

Description/Cat. No.	Sub-plate	Description/Cat. No.	Sub-plate	Description/Cat. No.	Sub-plate	Description/Cat. No.	Sub-plate
(2) Style Line [®] decorator openings NEMA spacing		Blank cover plate		(1) 2.16" opening for 30A & 50A, 3-wire, straight blade receptacle		(4) Extron [®] APP openings	
S1R10CSPM		S1R10CSP2B		S1R10CSPE		S1R10CSPU	

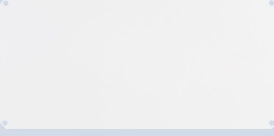
Center Sub-Plates - Three and Four Gang

Description/Cat. No.	Sub-plate	Description/Cat. No.	Sub-plate
(3) Style Line [®] decorator openings NEMA spacing		(4) Style Line [®] decorator openings	
S1R10CSPT		S1R10CSPP	
(4) Blank cover plate		(4) Duplex openings	
S1R10CSPQ		S1R10CSPR	

Note: Rectangular sub-plates are for center compartments, crescent sub-plates are for perimeter compartments and are not inter-changeable. See page P-7 for covers, P-8 for bottom feed plates and P-10 for accessories.

Extron[®] is a registered trademark of Extron Electronics.
TracJack[®], Series II[®] and Ortronics[®] are registered trademarks of Ortronics/Legrand.
Crestron[®] is a registered trademark of Crestron Electronics, Inc.
FSR[®] is a registered trademark of FSR Inc.

SystemOne Recessed 10 Inch Accessories and Replacement Parts



S1R10PPT



S1R10ADMTBK



S1R10CVRBRUSH



S1R10TUNNEL

10 Inch Accessories

Description	Catalog Number
Pre-pour tube, includes hardware.	S1R10PPT*
Abandonment plate, black finish.	S1R10ADMTBK
Center divider.	S1R10CENTERDIV
Perimeter divider.	S1R10PERIMDIV
Egress door brushes (1 Pair).	S1R10CVRBRUSH
Perimeter to perimeter wiring tunnel.	S1R10TUNNEL
Power junction box, 27.0 cubic inches; (1) 3/4 inch and (1) 1 inch EMT connector.	S1FRPTJB
Perimeter device bracket.	S1R10PSPREPBRKT

Note: *Not UL Listed.



S1R10CENTERDIV



S1R10FFDIV

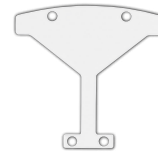

S1R10PSPREPBRKT



S1FRPTJB



S1R10INTUMDIV

10 Inch Replacement Parts

Description	Catalog Number
Intumescent replacement divider.	S1R10INTUMDIV
Replacement furniture feed cover dividers (1 pair).	S1R10FFDIV
Replacement tamper-resistant Torx-T10 bit.	S1RTR10BIT*

Note: *Not UL Listed.

Capacity, Capability and Versatility



Fire-Rated Poke-Throughs

Features and Benefits

Pre-Pour Tubes For Increased Installation Efficiency

- Hubbell SystemOne Pre-pour Tubes save installers time and money when it counts. Designed for second floor applications and above, pre-pour tubes are installed before the concrete slab is poured to provide correctly sized circular holes for Fire-Rated Poke-Through (FRPT) installation. Pre-pour tubes also ensure that the FRPT is placed exactly as specified on the print, while avoiding systems within the concrete floor's construction.
- Pre-pour tube installation is quicker and more cost effective as compared to the time-consuming process of concrete core drilling. Additional time and scheduling must be considered for core drilling, along with the possible safety hazards of drilling on job sites. Prior to drilling, professionals take the precaution to use x-ray or ground-penetrating radar (GPR) technology to ensure the core drill does not damage embedded conduits, rebar or tensioned cables. Cutting a tensioned cable can endanger the installer and compromise the structural integrity of the slab. If there is an obstacle, the core drill location must be adjusted, which may impact furniture and powered cubicle layouts.



Pre-Pour Tube Design

- Creates a circular hole for Fire-Rated Poke-Through installation
- For use in poured concrete floors
- The pre-pour tubes can be use in corrugated steel decking or plywood forms

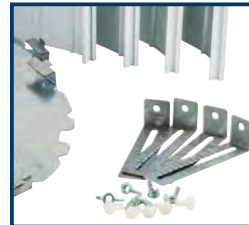

Hardware

- Includes adjustable mounting legs for easy leveling
- The mounting hardware provided allows for installation versatility
- The PVC walls are then easily removed with hand tools, leaving a clean circular hole for FRPT installation



Pre-Pour Tube Sizes

- Hubbell pre-pour tubes are available in 4-, 6-, 8- and 10-inch sizes
- Single use



Installation Design

- They consist of extruded PVC segmented dove-tailed walls which easily slide together and are locked with pre-galvanized steel disks to maintain the tube's circular shape under the stress of the concrete pour

Pre-Pour Tubes

Includes all hardware

Diameter	Catalog Number
4 inches	S1R4PPT
6 inches	S1R6PPT
8 inches	S1R8PPT
10 inches	S1R10PPT

Note: Not UL Listed



Features and Benefits

SystemOne Recessed 8 Inch Fire-Rated Poke-Through Fittings

- Perfect for high capacity multimedia applications where power and low voltage are required
- Maintains concrete floor fire rating up to two hours
- Fitting box standard
- For use in the City of Chicago applications, fitting box is NOT included
- Furniture feed cover available with (1) generous 2 inch NPT low voltage hub and (1) 1 inch NPT power hub
- Features ScrubShield® technology that exceeds UL514A scrubwater exclusion requirements
- Works with time and labor saving 8" concrete pre-pour tube



8 Inch Recessed FRPT with Accessories

8 Inch Furniture Feed FRPT with Accessories



FRPT Design

- Step down installation
- Flexible single or dual service
- Recessed connections



Covers

- Durable die-cast aluminum cover
- 1,000 lbs, static load rated cover
- Available in six architectural finishes



Chamber

- Recessed 3.5 inch deep connectivity chamber
- Large wiring compartments
- Fixed wiring chambers
- On-site exchangeable center compartment fitting
- Standard 3/4-inch EMT

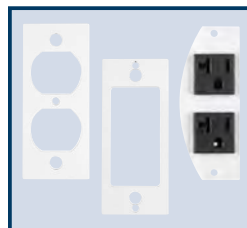

Easy Mount Device Plates

- Multiple, open architecture mounting plates for power, data and AV
- 3 center gangs
- 2 independent perimeter gangs



Safety

- Low profile flange, 0.15 inch exceeds ADA requirements
- Two hide-away egress doors fold under cover while in use
- 180° opening of main door



8 Inch Sub-Plate Features

- Center and perimeter plate configurations
- Available in pre-wired 20A duplex receptacles or data/AV plates
- Multiple 20A duplex receptacles can be wired to a common circuit or independently
- NEMA spacing between devices

SystemOne Recessed 8 Inch Core Hole Kits, for Use In Concrete Floors

Pre-Wired 8 Inch Fire-Rated Poke-Through Kits

Kits include:

- (1) Hubbell SystemOne 8 inch floor fitting (S1R8PTFIT1)
- (4) 20A, pre-wired receptacles, 18 inch wire lead, two pieces (S1R8PSPZ)
- (1) Fitting connection box with 1 inch and 1½ inch EMT stubs (S1R8JNC1)
- (1) 8 inch flange and universal cover assembly (S1R8CVRxx)

Receptacles feature single circuit wiring

Cover Finish

Brushed Aluminum
Black Powder Coat
Brushed Brass Plated
Antique Bronze Plated
Gray Powder Coat
Satin Nickel Plated

Catalog Number

S1R8PTZZ1ALU
S1R8PTZZ1BLK
S1R8PTZZ1BRS
S1R8PTZZ1BRZ
S1R8PTZZ1GRY
S1R8PTZZ1NKL



S1R8PTZZ1NKL

8 Inch Fire-Rated Poke-Through Kits

Kits include:

- (1) Hubbell SystemOne 8 inch floor fitting (S1R8PTFIT1)
- (1) Fitting connection box with 1 inch and 1½ inch EMT stubs (S1R8JNC1)
- (1) 8 inch flange and universal cover assembly (S1R8CVRxx)

Cover Finish

Brushed Aluminum
Black Powder Coat
Brushed Brass Plated
Antique Bronze Plated
Gray Powder Coat
Satin Nickel Plated

Catalog Number

S1R8PT1ALU
S1R8PT1BLK
S1R8PT1BRS
S1R8PT1BRZ
S1R8PT1GRY
S1R8PT1NKL

Pre-Wired 8 Inch Fire-Rated Poke-Through Kits

Kits include:

- (1) Hubbell SystemOne 8 inch floor fitting (S1R8PTFIT2)
- (4) 20A, pre-wired receptacles, 18 inch wire lead, two pieces (S1R8PSPZ)
- (1) Fitting connection box with (2) 1 inch EMT stubs (S1R8JNC2)
- (1) 8 inch flange and universal cover assembly (S1R8CVRxx)

Receptacles feature single circuit wiring

Cover Finish

Brushed Aluminum
Black Powder Coat
Brushed Brass Plated
Antique Bronze Plated
Gray Powder Coat
Satin Nickel Plated

Catalog Number

S1R8PTZZ2ALU
S1R8PTZZ2BLK
S1R8PTZZ2BRS
S1R8PTZZ2BRZ
S1R8PTZZ2GRY
S1R8PTZZ2NKL



S1R8PT2BLK

8 Inch Fire-Rated Poke-Through Kits

Kits include:

- (1) Hubbell SystemOne 8 inch floor fitting (S1R8PTFIT2)
- (1) Fitting connection box with (2) 1 inch EMT stubs (S1R8JNC2)
- (1) 8 inch flange and universal cover assembly (S1R8CVRxx)

Cover Finish

Brushed Aluminum
Black Powder Coat
Brushed Brass Plated
Antique Bronze Plated
Gray Powder Coat
Satin Nickel Plated

Catalog Number

S1R8PT2ALU
S1R8PT2BLK
S1R8PT2BRS
S1R8PT2BRZ
S1R8PT2GRY
S1R8PT2NKL

Pre-Wired 8 Inch Fire-Rated Poke-Through for Data AV Kits

Kits include:

- (1) Hubbell SystemOne 8 inch floor fitting (S1R8PTFIT3)
- (4) 20A, pre-wired receptacles, 18 inch wire lead, two pieces (S1R8PSPZ)
- (1) Fitting connection box with one 2 inch EMT stubs (S1R8JNC3)
- (1) 8 inch flange and universal cover assembly (S1R8CVRxx)

Receptacles feature single circuit wiring

Cover Finish

Brushed Aluminum
Black Powder Coat
Brushed Brass Plated
Antique Bronze Plated
Gray Powder Coat
Satin Nickel Plated

Catalog Number

S1R8PTZZ3ALU
S1R8PTZZ3BLK
S1R8PTZZ3BRS
S1R8PTZZ3BRZ
S1R8PTZZ3GRY
S1R8PTZZ3NKL



S1R8PTZZ3BRS

8 Inch Fire-Rated Poke-Through Kits

Kits include:

- (1) Hubbell SystemOne 8 inch floor fitting (S1R8PTFIT3)
- (1) Fitting connection box with (1) 2 inch EMT stubs (S1R8JNC3)
- (1) 8 inch flange and universal cover assembly (S1R8CVRxx)

Cover Finish

Brushed Aluminum
Black Powder Coat
Brushed Brass Plated
Antique Bronze Plated
Gray Powder Coat
Satin Nickel Plated

Catalog Number

S1R8PT3ALU
S1R8PT3BLK
S1R8PT3BRS
S1R8PT3BRZ
S1R8PT3GRY
S1R8PT3NKL

8 Inch Fire-Rated Poke-Through Furniture Feed Kits

Kits include:

- (1) Hubbell SystemOne 8 inch floor fitting (S1R8PTFIT13)
- (1) Fitting connection box with 1 inch and 2 inch EMT stubs (S1R8JNC13)
- Low voltage dividers, internal and external intumescent materials (S1R8PTFFCOMPKIT)
- (1) 8 inch furniture feed cover assembly (S1R8FFCVRxx)

Cover Finish

Brushed Aluminum
Black Powder Coat
Brushed Brass Plated
Antique Bronze Plated
Gray Powder Coat
Satin Nickel Plated

Catalog Number

S1R8PTFFALU
S1R8PTFFBLK
S1R8PTFFBRS
S1R8PTFFBRZ
S1R8PTFFGRY
S1R8PTFFNKL



S1R8PTFFBRZ

Note: xx indicates finish options.

SystemOne Recessed 8 Inch FRPT and Covers, for Use In Concrete Floors



S1R8PTFIT1



S1R8PTFIT13



S1R8PTFIT2CHI



S1R8JNC1



S1R8JNC3



S1R8JNC6



S1R8JNC10



S1R8PPT



S1R8ADMTBK



S1R8DIV



S1FRPTJB

8 Inch Fire-Rated Poke-Throughs

Description	Catalog Number
8 Inch Fire-Rated Poke-Through includes: (1) ¼ inch power EMT plus (1) S1FRPTJB box and flexible metal conduit. S1R8JNCxx Series fitting box not included.	S1R8PTFIT
8 Inch Fire-Rated Poke-Through includes: (1) ¼ inch power EMT plus (1) S1R8JNC1 with (1) 1 inch EMT and (1) 1½ inch EMT. (1) S1FRPTJB box and flexible metal conduit.	S1R8PTFIT1
8 Inch Fire-Rated Poke-Through includes: (1) ¼ inch power EMT plus (1) S1R8JNC2 with (2) 1 inch EMT (1) S1FRPTJB box and flexible metal conduit.	S1R8PTFIT2
8 Inch Fire-Rated Poke-Through includes: (1) ¼ inch power EMT plus (1) S1R8JNC3 with (1) 2 inch EMT (1) S1FRPTJB box and flexible metal conduit.	S1R8PTFIT3
8 Inch Furniture Feed Fire-Rated Poke-Through includes: S1R8PTFFCOMPKIT (see below). S1FRPTJB box or flexible metal conduit not included. Approved for use in the City of Chicago.	S1R8PTFIT13
8 Inch Fire-Rated Poke-Through includes: (1) ¼ inch power EMT plus (1) S1R8JNC1 with (1) 1 inch EMT and (1) 1½ inch EMT. S1FRPTJB box or flexible metal conduit not included.	S1R8PTFIT1CHI
8 Inch Fire-Rated Poke-Through includes: (1) ¼ inch power EMT plus (1) S1R8JNC2 with (2) 1 inch EMT. S1FRPTJB box or flexible metal conduit not included.	S1R8PTFIT2CHI
8 Inch Fire-Rated Poke-Through includes: (1) ¼ inch power EMT plus (1) S1R8JNC3 with (1) 2 inch EMT. S1FRPTJB box or flexible metal conduit not included.	S1R8PTFIT3CHI

Note: See page P-37 for technical information.

Recessed 8 Inch Covers

8 Inch FRPT cover assembly unit includes solid cast aluminum construction, carpet gasket and mounting hardware. All covers are UL514A, scrubwater compliant. Furniture Feed covers includes (1) 2" Threaded Hub & (1) 1" Threaded Hub with 3/4" Reducer.



Finish	Catalog Number	Furniture Feed Option
Brushed Aluminum	S1R8CVRALU	S1R8FFCVRALU
Black Powder Coat	S1R8CVRBLK	S1R8FFCVRBLK
Brushed Brass Plated	S1R8CVRBRS	S1R8FFCVRBRS
Antique Bronze Plated	S1R8CVRBRZ	S1R8FFCVRBRZ
Gray Powder Coat	S1R8CVRGRY	S1R8FFCVRGRY
Satin Nickel Plated	S1R8CVRNKL	S1R8FFCVRNKL

Note: COVER LOAD RATING: 1,000 lbs with 2x safety factor. Load applied through a 3" (76mm) dia. mandrel at the center of the cover. Rated for static loads only.

Fitting Boxes

Description	Catalog Number	Description	Catalog Number
(1) 1½ inch & (1) 1 inch EMT.	S1R8JNC1	(1) ¼ inch & (1) 1¼ inch EMT.	S1R8JNC8
(2) 1 inch EMTs.	S1R8JNC2	(1) ¼ inch & (2) 1¼ inch EMTs.	S1R8JNC9
(1) 2 inch EMT.	S1R8JNC3	(1) 1¼ inch & (1) 2 inch EMT.	S1R8JNC10
(3) 1 inch EMTs.	S1R8JNC4	(1) 1½ inch & (1) 2 inch EMT.	S1R8JNC11
(1) 1½ inch & (1) 1¼ inch EMT.	S1R8JNC5	(3) 1¼ inch EMTs.	S1R8JNC12
(2) 1¼ inch EMTs.	S1R8JNC6	(1) 1 inch & (1) 2 inch EMTs.	S1R8JNC13
(1) ¼ inch & (2) 1 inch EMTs.	S1R8JNC7		

8 Inch Accessories

Description	Catalog Number	Description	Catalog Number
Includes components to convert installed 8" Recessed FRPT to Furniture Feed activation; S1R8JNC13, low voltage dividers, internal and external intumescent materials.	S1R8PTFFCOMPKIT	1 Inch replacement Plug, Brushed Aluminum	S1RPLUG100ALU
		1 Inch replacement Plug, Black Powder	S1RPLUG100BLK
		1 Inch replacement Plug, Brass Plated	S1RPLUG100BRS
		1 Inch replacement Plug, Bronze Plated	S1RPLUG100BRZ
		1 Inch replacement Plug, Gray Powder	S1RPLUG100GRY
Pre-pour tube, includes hardware.	S1R8PPT*	1 Inch replacement Plug, Nickel Plated	S1RPLUG100NKL
Abandonment plate, black finish.	S1R8ADMTBK	Power junction box	S1FRPTJB
Low voltage replacement divider.	S1R8DIV		

Note: *Not UL Listed.

SystemOne Recessed 8 Inch Sub-Plates

Center Plate Configurations

- Allows for 3 duplexes or up to 18 data/AV jacks. Other combinations possible
- Accepts third party AV devices (i.e. Extron®, Crestron®, FSR®)
- Standard NEMA spacing between devices











Perimeter Plate Configurations









- Available in pre-wired duplexes or openings to accommodate third party AV devices
- Multiple duplexes can be wired in the supplied junction box or independently



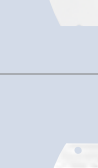

Center Sub-Plates - Single Gang

Description/Cat. No.	Sub-plate	Description/Cat. No.	Sub-plate
Blank cover plate		(2) Extron® MAAP openings	
S1R8CSPB		S1R8CSPC	
(1) 1 unit Hubbell iSTATION opening		(1) 1.5 unit Hubbell iSTATION opening (See section Y for modules)	
S1R8CSPD		S1R8CSPE	
(1) 1.60" opening for 20A & 30A Twist-Lock®		(1) Duplex opening	
S1R8CSPG		S1R8CSPI	
(1) 1.40" opening for simplex or 15A Twist-Lock®		(1) Style Line® decorator opening	
S1R8CSPJ		S1R8CSPK	
(1) Hubbell Jack opening and (3) Jack KOs with Label Field			
S1R8CSP4DJ			



Perimeter Sub-Plates

Description/Cat. No.	Sub-plate	Description/Cat. No.	Sub-plate
Blank cover plate		Single Extron® MAAP opening	
S1R8PSPU		S1R8PSPV	
Pull through with 1" bushing opening		Single Extron® AAP opening	
S1R8PSPW		S1R8PSPX	
(1) 1 unit Hubbell iSTATION opening (See section Y for modules)		Dual 20A pre-wired power cubes; one circuit (Supplied with isolated ground sticker)	
S1R8PSPY		S1R8PSPZ	
Dual 20A pre-wired power cubes; one circuit (Supplied with isolated ground sticker); Marked with "Controlled"; (18 inch leads)		Dual 20A pre-wired power tamper resistant cubes; one circuit (Supplied with controlled and isolated ground stickers); (18 inch leads)	
S1R8PSPZC		S1R8PSPZTR	

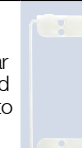
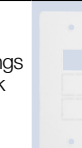
Center Sub-Plates - Two Gang

Desc/Cat. No.	Sub-plate	Desc/Cat. No.	Sub-plate	Desc/Cat. No.	Sub-plate	Desc/Cat. No.	Sub-plate	Desc/Cat. No.	Sub-plate
Two gang; (4) Extron® AAP openings		Two gang; 3 unit Hubbell iSTATION opening (See section Y for modules)		Two gang; (2) Style Line® Decorator openings		Two gang; device depth extension collar (for use with 3rd party data up to 2.5" depth)		Two gang; (2) Hubbell Jack openings and (4) Jack KOs with Label Field	
S1R8CSPA		S1R8CSPL		S1R8CSPM		S1R8CSPEXT		S1R8CSP6DJ	

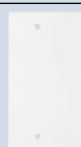
Center Sub-Plates - Three Gang

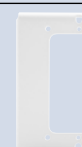
Description/Cat. No.	Sub-plate	Description/Cat. No.	Sub-plate	Description/Cat. No.	Sub-plate
Three gang; blank cover plate		Three gang; device depth extension collar (for use with 3rd party data up to 2.5" depth)		Three gang extender with two gang opening; device depth extension collar (for use with 3rd party data up to 2.5" depth)	
S1R8CSPN		S1R8CSPEXT3		S1R8CSPEXT32	

Note: Rectangular sub-plates are for center compartments, crescent sub-plates are for perimeter compartments and are not inter-changeable. See page P-14 for covers and accessories.

Extron® is a registered trademark of Extron Electronics.
Crestron® is a registered trademark of Crestron Electronics, Inc.
FSR® is a registered trademark of FSR Inc.

Features and Benefits

SystemOne Recessed 6 Inch Fire-Rated Poke-Through Fittings

- Maintains concrete floor fire rating up to two hours
- Junction box standard
- Includes (1) 2 inch data/AV EMT and (1) ¼ inch power EMT
- For use in the City of Chicago applications, junction box is NOT included
- Features ScrubShield® technology that exceeds UL514A scrubwater exclusion requirements
- Works with time and labor saving 6" concrete pre-pour tube



6 Inch FRPT with Accessories



FRPT Design

- Step down installation
- Flexible single or dual service
- Recessed connections



Covers

- Durable die-cast aluminum cover
- 1,000 lbs, static load rated cover
- Available as recessed or furniture feed
- Available in six architectural finishes



Chamber

- Recessed 3.5 inch deep connectivity chamber
- Large wiring compartments divides up to 2.9 inch (73mm) deep
- Adaptable low voltage divider
- 2-inch EMT bottom feed
- ¼-inch EMT bottom feed

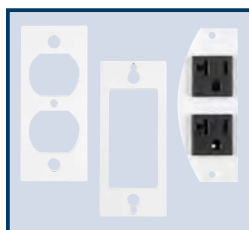

Easy Mount Device Plates

- Multiple, open architecture mounting plates for power, data and AV



Safety

- Low profile flange, 0.15 inch exceeds ADA requirements
- Two hide-away egress doors fold under cover while in use
- 180° opening of main door



6 Inch Sub-Plate Features 60/40 or 50/50 Device Plate Combinations

- Allows for a wide array of data and AV connectivity with a 20A duplex receptacle
- The two plates can be independently wired

SystemOne Recessed 6 Inch Core Hole Kits, for Use In Concrete Floors

Pre-Wired 60/40 Split 6 Inch Fire-Rated Poke-Through for Data AV Kits

Kits include:

- (1) Hubbell SystemOne 6 inch floor fitting (S1R6PTFIT)
- (2) Decorator opening sub-plate (S1R6SPW)
- (2) 20A, pre-wired receptacle with 18 inch wire leads (S1R6SPZ)
- (1) Set 1½ inch sub-plate extensions (S1R6SPEXT)
- (1) 6 inch flange and universal cover assembly (S1R6CVRxx)

Receptacles feature single circuit wiring.

Cover Finish	Catalog Number
Brushed Aluminum	S1R6PTWZALU
Black Powder Coat	S1R6PTWZBLK
Brushed Brass Plated	S1R6PTWZBRS
Antique Bronze Plated	S1R6PTWZBRZ
Gray Powder Coat	S1R6PTWZGRY
Satin Nickel Plated	S1R6PTWZNKL



S1R6PTWZALU

Pre-Wired 50/50 Split 6 Inch Fire-Rated Poke-Through for Hubbell Data AV Kits

Kits include:

- (1) Hubbell SystemOne 6 inch floor fitting (S1R6PTFIT)
- (4) 1 Unit Hubbell iSTATION openings (S1R6SPD)
- (1) Decorator opening and (2) keystone openings (S1R6SPE)
- (4) 20A, pre-wired receptacles (S1R6SPH)
- (1) Set 1½ inch sub-plate extensions (S1R6SPEXT)
- (1) 6 inch flange and universal cover assembly (S1R6CVRxx)

Opening architecture Keystone openings accept Hubbell modular jacks and many others.

Receptacles feature single or two circuit wiring and isolated ground capability.

Cover Finish	Catalog Number
Brushed Aluminum	S1R6PTDEHALU
Black Powder Coat	S1R6PTDEHBLK
Brushed Brass Plated	S1R6PTDEHBRS
Antique Bronze Plated	S1R6PTDEHBRZ
Gray Powder Coat	S1R6PTDEHGRY
Satin Nickel Plated	S1R6PTDEHNKL



S1R6PTDEHBLK

Pre-Wired 50/50 Split 6 Inch Fire-Rated Poke-Through for Hubbell or Third Party Devices Kits

Kits include:

- (1) Hubbell SystemOne 6 inch floor fitting (S1R6PTFIT)
- (3) Extron® AAP openings (S1R6SPA)
- (5) Extron® MAPP openings (S1R6SPC)
- (1) Decorator opening and (2) Hubbell keystone openings (S1R6SPE)
- (4) 20A, pre-wired receptacles (S1R6SPH)
- (1) Set 1½ inch sub-plate extensions (S1R6SPEXT)
- (1) 6 inch flange and universal cover assembly (S1R6CVRxx)

Opening architecture Keystone openings accept Hubbell modular jacks and many others.

Receptacles feature single or two circuit wiring and isolated ground capability.

Cover Finish	Catalog Number
Brushed Aluminum	S1R6PTACEHALU
Black Powder Coat	S1R6PTACEHBLK
Brushed Brass Plated	S1R6PTACEHBRS
Antique Bronze Plated	S1R6PTACEHBRZ
Gray Powder Coat	S1R6PTACEHGRY
Satin Nickel Plated	S1R6PTACEHNKL



S1R6PTBRS

6 Inch Fire-Rated Poke-Through with Finished Cover Kits

Kits include:

- (1) Hubbell SystemOne 6 inch floor fitting (S1R6PTFIT)
- (1) Set 1½ inch sub-plate extensions (S1R6SPEXT)
- (1) 6 inch flange and universal cover assembly (S1R6CVRxx)

Cover Finish	Catalog Number
Brushed Aluminum	S1R6PTALU
Black Powder Coat	S1R6PTBLK
Brushed Brass Plated	S1R6PTBRS
Antique Bronze Plated	S1R6PTBRZ
Gray Powder Coat	S1R6PTGRY
Satin Nickel Plated	S1R6PTNKL

6 Inch Fire-Rated Poke-Through for Furniture Feed Applications Kits

Kits include:

- (1) Hubbell SystemOne 6 inch floor fitting (S1R6PTFIT)
- (1) 6 inch furniture feed flange and cover assembly (S1R6FFCVRxx)
- (1) 2 inch conduit fitting
- (1) ¾ inch conduit fitting
- (1) Set 1½ inch sub-plate extensions (S1R6SPEXT)

Cover Finish	Catalog Number
Brushed Aluminum	S1R6PTFFALU
Black Powder Coat	S1R6PTFFBLK
Brushed Brass Plated	S1R6PTFFBRS
Antique Bronze Plated	S1R6PTFFBRZ
Gray Powder Coat	S1R6PTFFGRY
Satin Nickel Plated	S1R6PTFFNKL



S1R6PTFFNKL

Note: xx indicates finish options.

Extron® is a registered trademark of Extron Electronics.

SystemOne Recessed 6 Inch FRPT and Covers, for Use In Concrete Floors



S1R6PTFIT



S1R6PTFITCHI



S1R6PPT



S1R6ADMTBK



S1FRPTJB



S1R6DIV



S1R6SPEXT



S1RFFFIT2



S1RPLUG2ALU



S1RPLUG075ALU

6 Inch Fire-Rated Poke-Throughs

Description	Catalog Number
6 Inch Fire-Rated Poke-Through.	S1R6PTFIT
6 Inch Fire-Rated Poke-Through; for use in the City of Chicago.	S1R6PTFITCHI

Note: See page P-36 for technical information.

Recessed 6 Inch Covers

6 Inch FRPT cover assembly unit includes solid cast aluminum construction, carpet gasket and mounting hardware. All covers are UL514A, scrubwater compliant. Furniture Feed covers include (1) 2" Threaded Hub & (1) 3/4" Threaded Hub.



Cover Finish	Catalog Number	Furniture Feed Option
Brushed Aluminum	S1R6CVRALU	S1R6FFCVRALU
Black Powder Coat	S1R6CVRBLK	S1R6FFCVRBLK
Brushed Brass Plated	S1R6CVRBRS	S1R6FFCVRBRS
Antique Bronze Plated	S1R6CVRBRZ	S1R6FFCVRBRZ
Gray Powder Coat	S1R6CVRGRY	S1R6FFCVRGRY
Satin Nickel Plated	S1R6CVRNKL	S1R6FFCVRNKL

Note: COVER LOAD RATING: 1,000 lbs with 2x safety factor. Load applied through a 3 in. (76) mandrel at the center of the cover. Static loads only.

6 Inch Accessories

Description	Catalog Number
Pre-pour tube, includes hardware.	S1R6PPT*
Abandonment plate, black finish.	S1R6ADMTBK
Low voltage replacement divider.	S1R6DIV
Power junction box, 27.0 cubic inches; (1) 3/4 inch and (1) 1 inch EMT connector.	S1FRPTJB
Replacement 1 1/2 inch extension kit, ships with 6" FRPT kits and S1R6PTFIT(CHI)	S1R6SPEXT
Power junction box	S1FRPTJB2

Note: *Not UL Listed.

Replacement Furniture Feed Fitting

Description	Catalog Number
2 inch furniture feed fitting.	S1RFFFIT2

Replacement Plugs

Finish	2 Inch	3/4 Inch
Brushed Aluminum	S1RPLUG2ALU	S1RPLUG075ALU
Black Powder Coat	S1RPLUG2BLK	S1RPLUG075BLK
Brushed Brass Plated	S1RPLUG2BRS	S1RPLUG075BRS
Antique Bronze Plated	S1RPLUG2BRZ	S1RPLUG075BRZ
Satin Nickel Plated	S1RPLUG2NKL	S1RPLUG075NKL







SystemOne Recessed 6 Inch Sub-Plates, for Use In Concrete Floors

60/40 Device Plate Combination



- Allows for up to twelve data/AV jacks plus a 20A duplex receptacle
- Two plates which can be wired independently



Left 60% Sub-Plates

Description/Cat. No.	Sub-plate	Description/Cat. No.	Sub-plate
(1) Extron® MAAP opening, (4) Extron® MAAP openings, (1) Extron® MAAP opening, left side only		(2) MAAP and (2) AAP Extron® openings, left side only	
S1R6SPT*		S1R6SPU*	
(1) Style Line® decorator and (2) Extron® MAAP openings, left side only		(2) Style Line® decorator openings, left side only	
S1R6SPV*		S1R6SPW*	
(1) Style Line® decorator and (2) Extron® AAP openings, left side only		(1) Style Line® decorator and (2) 1.5 unit Hubbell iSTATION openings, left side only (See section Y for modules)	
S1R6SPX*		S1R6SPY*	

Right 40% Sub-Plates

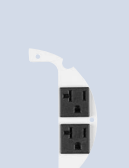
(2) 20A pre-wired receptacles; 16" lead; one circuit, right side only (Supplied with isolated ground sticker)		(2) 20A pre-wired receptacles; 25 foot lead; one circuit, right side only (Supplied with isolated ground sticker)	
S1R6SPZ		S1R6SPZ5	
(2) 20A pre-wired receptacles; 16" lead; one circuit, right side only (Supplied with isolated ground sticker); Marked with "Controlled"			
S1R6SPZC			









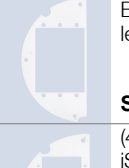

Note: Sub-plates can not be rotated to create additional layouts. When assembled, sub-plates can not overlap. Custom plates available upon request and may be subject to minimum order quantity.
*Sub-plates must only be used for Data/AV. Do not mix with power devices. See page P-18 for covers and accessories.

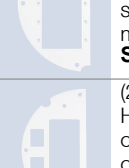
50/50 Device Plate Combination

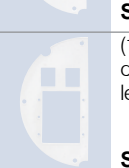



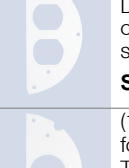

- Allows for up to eight Hubbell data jacks plus two 20A duplex receptacles
- Two plates which can be wired independently

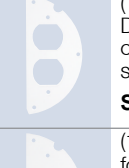

Left 50% Sub-Plates

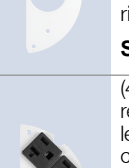
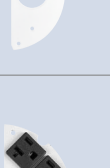
Description/Cat. No.	Sub-plate	Description/Cat. No.	Sub-plate
(3) Extron® AAP plate openings, left side only		Blank cover plate, left side only	
S1R6SPA		S1R6SPB	
(5) Extron® MAAP plate openings, left side only		(4) 1 unit Hubbell iSTATION openings, left side only (See section Y for modules)	
S1R6SPC		S1R6SPD	
(1) Style Line® decorator and (2) Hubbell keystone openings, left side only		(2) 1.5 unit Hubbell iSTATION openings, left side only (See section Y for modules)	
S1R6SPE*		S1R6SPF	
(3) Extron® MAAP openings and (2) Hubbell keystone jack openings, left side only		(1) Style Line® decorator opening, left side only	
S1R6SPL		S1R6SPM	
(1) Decorator opening and (2) Ortronics® TracJack® openings, left side only		(2) Hubbell Jack openings and (4) Jack KOs with Label Field	
S1R6SPN		S1R6SP6DJ	

Right 50% Sub-Plates

(1) Duplex device opening, right side only		(1) Style Line® Decorator device opening, right side only	
S1R6SPI		S1R6SPK	
(1) 1.60" opening for 20A and 30A Twist-Lock®, right side only		(1) 1.40" opening for simplex or 15A Twist-Lock®, right side only	
S1R6SPG		S1R6SPJ	
(4) 20A pre-wired receptacles; one or two circuits, right side only (Supplied with isolated ground sticker)		(4) 20A pre-wired receptacles; 16" leads; one or two circuits, right side only; Marked with "Controlled"	
S1R6SPH (16" leads)		S1R6SPHC4 (4 Controlled)	
S1R6SPH25 (25 foot leads)		S1R6SPHC2 (2 Controlled)	
(3) 20A pre-wired tamper resistant receptacles; one circuit, right side only (Supplied with controlled and isolated ground stickers)			
S1R6SP3RTR			

Extron® is a registered trademark of Extron Electronics.
TracJack®, Series II® and Ortronics® are registered trademarks of Ortronics/Legrand.

Features and Benefits

SystemOne Recessed 4 Inch Fire-Rated Poke-Through Fittings

- Maintains concrete floor fire rating up to two hours
- Junction box standard, 27 cubic inches
- (1) ¾ inch conduit for power and (2) ½ inch conduits for low voltage
- For use in the City of Chicago applications, junction box is NOT included
- Works with time and labor saving 4" concrete pre-pour tube



4 Inch FRPT with Accessories



FRPT Design

- Step down installation
- Flexible single or dual service
- Recessed connections



Covers

- Durable die-cast aluminum cover
- 1,000 lbs, static load rated cover
- Available in six architectural finishes



Chamber

- 3-inch deep user access chamber
- Deep wiring chamber for GFCI and USB devices
- Low voltage dividers
- Perimeter chamber: (2) ½ inch EMTs bottom feed
- Center chamber: (1) ¾ inch EMT bottom feed

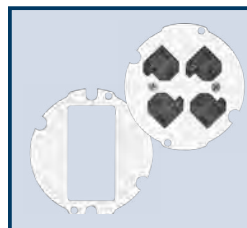

Easy Mount Device Plates

- Field configurable device plates
- Multiple, open architecture mounting plates for power, data and AV



Safety

- Low profile flange, 0.15 inch exceeds ADA requirements
- Hide-away egress door folds under cover while in use
- 180° opening of main door

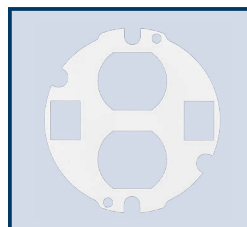

4 Inch Sub-Plate Features

- Sub-plates accept Hubbell keystone jacks
- Third party sub-plates accept Ortronics® TracJack®

TracJack®, Series II® and Ortronics® are registered trademarks of Ortronics/Legrand.

SystemOne Recessed 4 Inch Core Hole Kits, for Use In Concrete Floors

Pre-Wired, 4 Inch Quad Receptacle Kit, Recessed Connectivity, Fire-Rated Poke-Through for Power Only

Kits include:

- (1) Hubbell SystemOne 4 inch recessed floor fitting (S1R4PTFIT)
- (1) Hubbell pre-wired quad receptacle with mounting plate (S1R4SPQUAD)
- (1) Hubbell SystemOne 4 inch recessed activation cover (S1R4CVRxx)
- (1) Hubbell Junction box (S1FRPTJB)

Cover Finish	Catalog Number
Brushed Aluminum	S1R4PTQUADALU
Black Powder Coat	S1R4PTQUADBLK
Brushed Brass Plated	S1R4PTQUADBRS
Antique Bronze Plated	S1R4PTQUADBRZ
Gray Powder Coat	S1R4PTQUADGRY
Satin Nickel Plated	S1R4PTQUADNKL



S1R4PTQUADALU

4 Inch Fire-Rated Poke-Through Kit, Recessed Connectivity

Kits include:

- (1) Hubbell SystemOne 4 inch recessed floor fitting (S1R4PTFIT)
- (1) Hubbell SystemOne 4 inch recessed activation cover (S1R4CVRxx)
- (1) Hubbell Junction box (S1FRPTJB)

Cover Finish	Catalog Number
Brushed Aluminum	S1R4PTALU
Black Powder Coat	S1R4PTBLK
Brushed Brass Plated	S1R4PTBRS
Antique Bronze Plated	S1R4PTBRZ
Gray Powder Coat	S1R4PTGRY
Satin Nickel Plated	S1R4PTNKL



S1R4PTBRS

Note: xx indicates finish options.

SystemOne Recessed 4 Inch FRPT and Covers, for Use In Concrete Floors

4 Inch Fire-Rated Poke-Throughs

Description	Catalog Number
4 Inch FRPT includes: Junction box and low voltage dividers.	S1R4PTFIT
4 Inch FRPT includes: Low voltage dividers, junction box NOT included.	S1R4PTFITCHI
4 Inch FRPT includes: Quad sub-plate and junction box.	S1R4PTQUAD

Note: See page P-22 for sub-plates and accessories.
See page P-39 for technical information.



S1R4PTFIT
S1R4PTFITQUAD

Recessed 4 Inch Covers

Single fold under cable egress door. Unit includes solid cast aluminum construction, carpet gasket and mounting hardware. All covers are UL514A, scrubwater compliant.



S1R4PTFITCHI

Cover Finish	Catalog Number
Brushed Aluminum	S1R4CVRALU
Black Powder Coat	S1R4CVRBLK
Brushed Brass Plated	S1R4CVRBRS
Antique Bronze Plated	S1R4CVRBRZ
Gray Powder Coat	S1R4CVRGRY
Satin Nickel Plated	S1R4CVRNKL

Note: COVER LOAD RATING: 1,000 lbs with 2x safety factor. Load applied through a 3" (76mm) dia. mandrel at the center of the cover.
Rated for static loads only.

SystemOne Recessed 4 Inch Sub-Plates and Accessories

The 4 Inch recessed cover is available in a number of durable, yet beautiful finishes to match any décor. The flange height of 0.15 inch exceeds ADA requirements and suitable for use on any floor finish. All covers are UL514A, scrubwater compliant.



Device Mounting Plates

Description / Catalog Number	Sub-plate	Description / Catalog Number	Sub-plate	Description / Catalog Number	Sub-plate
2X2 Sub-plate with (1) Style Line® decorator device opening and (2) keystone jack openings S1R4SP2X2STYLE		(1) Style Line® decorator device opening for power or datacom applications S1R4SPSTYLE		2X2 Sub-plate with (1) Style Line® decorator device opening and (2) Ortronics® TracJack® openings S1R4SP2X2STYLETJ	
2X2 Sub-plate with (1) duplex device opening and (2) keystone jack openings S1R4SP2X2DUPLEX		(1) Duplex device opening for power or datacom applications S1R4SPDUPLEX		2X2 Sub-plate with (1) duplex device opening and (2) Ortronics® TracJack® openings S1R4SP2X2DUPLEXTJ	
(4) Single 20A receptacles. Can be wired as single or two circuit with isolated ground capability, 12" wire leads S1R4SPQUAD		(1) 1.60" opening for 20A or 30A Twist-Lock® receptacle S1R4SPTWIST		(1) 1.40" opening for simplex receptacle S1R4SPSIMPLEX	

Note: See section Y for data jacks and frames.



HBL8300ILW

For low light applications (i.e. under tables or podiums) consider using Hubbell's LED illuminated receptacles: HBL8200ILW 15A, LED or HBL8300ILW 20A, LED.



S1R4PPT



S1R4FRPTADMTBK



S1R4DIV

4 Inch Accessories

Description	Catalog Number
Pre-pour tube, includes hardware.	S1R4PPT*
Abandonment plate, black finish.	S1R4FRPTADMTBK
Low voltage replacement divider.	S1R4DIV

Note: *Not UL Listed.

Design Solutions for:

Retail, Cafeterias, Commercial Office Space, Mass Transit Hubs, Education.



Tile

Carpet

Terrazzo

For Technical files, including BIM models, CAD files and Customer drawings, please visit www.hubbell-wiring.com under the Technical tab.

TracJack®, Series II® and Ortronics® are registered trademarks of Ortronics/Legrand.

Features and Benefits

SystemOne Recessed 4 Inch Furniture Feed Fire-Rated Poke-Through Fittings

- Excellent solution for retrofit and new construction
- Maintains concrete floor fire rating up to four hours
- One ¾ inch conduit for power and one 1½ inch conduit for low voltage
- Junction box standard, 27 cubic inches
- For use in the City of Chicago, junction box is NOT included
- Works with time and labor saving 4" concrete pre-pour tube



4 Inch Furniture Feed FRPT with Accessories



FRPT Design

- Step down installation
- Flexible single or dual service
- Adjustable lower fire barrier accommodates concrete floor thicknesses from 2¼ to 7 inch



Cover Construction

- Durable die-cast aluminum cover
- 1,000 lbs, static load rated cover
- Available in six architectural finishes



Chambers

- Fittings include removable metallic low voltage divider
- Cover hubs in-line with fitting EMT conduits for easy wiring
- (1) 1½ inch EMT conduit for low voltage
- (1) ¾ inch EMT conduit for power



Furniture Feed Cover Design

- Seamless one piece design
- (1) 1½ inch EMT conduit for low voltage
- (1) ¾ inch EMT conduit for power
- 5½ inch diameter flange

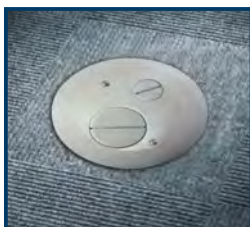

Safety

- Low profile flange, 0.15 inch exceeds ADA requirements
- UL514A scrubwater compliant

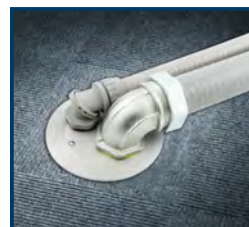

Application Compatibility

- Hubbell PolyTuff® I conduits
- Hubbell SwivelLok® fittings
- Metallic/Non-metallic liquidtight fittings

SystemOne Furniture Feed 4 Inch Core Kits, Covers and Accessories



S1R4PTFFALU



S1R4PTFFBLKJ



S1R4PTAVFIT



S1R4PTAVFITJ



S1R4PPT



S1R4FFADMTBK

SystemOne Furniture Feed 4 Inch Core Kits, Use In Concrete Floors

FRPT, Furniture Feed Flush Connectivity	Cover Finish	Without Junction Box	With Junction Box
Kits Include: (1) Hubbell SystemOne 4 Inch flush furniture feed fitting (S1R4PTAVFIT) (1) Hubbell SystemOne 4 Inch flush furniture feed activation cover (S1R4FFCVRxx)	Brushed Aluminum	S1R4PTFFALU	S1R4PTFFALUJ
	Black Powder Coat	S1R4PTFFBLK	S1R4PTFFBLKJ
	Brushed Brass Plated	S1R4PTFFBRS	S1R4PTFFBRSJ
	Antique Bronze Plated	S1R4PTFFBRZ	S1R4PTFFBRZJ
	Gray Powder Coat	S1R4PTFFGRY	S1R4PTFFGRYJ
	Satin Nickel Plated	S1R4PTFFNKL	S1R4PTFFNKLJ

SystemOne Furniture Feed 4 Inch FRPT and Covers, Use In Concrete Floors

4 Inch Furniture Feed Fire-Rated Poke-Throughs	
Description	Catalog Number
4 Inch FRPT Includes: low voltage divider, junction box NOT included	S1R4PTAVFIT
4 Inch FRPT Includes: low voltage divider and junction box	S1R4PTAVFITJ

Flush 4 Inch Furniture Feed Covers

One piece cover solid cast aluminum construction with (1) 1½" hub for low voltage and (1) ¾" hub for power. All covers are UL514A, scrubwater compliant. Liquid-tight fittings not included.



Cover Finish	Catalog Number
Brushed Aluminum	S1R4FFCVRALU
Black Powder Coat	S1R4FFCVRBLK
Brushed Brass Plated	S1R4FFCVRBRS
Antique Bronze Plated	S1R4FFCVRBRZ
Gray Powder Coat	S1R4FFCVRGRY
Satin Nickel Plated	S1R4FFCVRNKL

Note; COVER LOAD RATING: 1,000 lbs. with 2x safety factor. Load applied through a 3" (76mm) dia. Mandrel at the center of cover without fittings installed. Rated for static loads only.

4 Inch Furniture Feed Accessories

Description	Catalog Number
Pre-pour tube, includes mounting hardware.	S1R4PPT*
Abandonment plate, black finish.	S1R4FFADMTBK

Note: *Not UL Listed.

Fire-Rated Poke-Throughs

Products at a Glance

Featuring the innovative SystemOne product line, Hubbell's offering of Fire-Rated Poke-Throughs (FRPT) products provide installers with a broad range of options to support a wide array of connections. Hubbell SystemOne flush FRPTs install in a 4 inch core hole and provide users the flexibility to create personal solutions for their most demanding applications.

Hubbell SystemOne Flush FRPTs for 4 Inch Concrete Core Hole Applications...



Multi-Service Applications

This Hubbell SystemOne sub-plate incorporates two Style Line® rectangular openings. These can be used for a variety of power and/or data applications. It will accommodate 15 or 20 amp, standard, isolated ground, GFCI or surge protected receptacles. Using communication frames it can provide up to a 6-port multi-service or a 12-port all communication solution.



Multimedia Applications

Other Hubbell SystemOne sub-plates are designed to meet the growing needs of the audio and video markets. Some sub-plates provide power outlets with Hubbell's AV products including 15-pin SVGA, RCA, S-Video, 3.5mm stereo, and XLR microphone jacks. Other sub-plates can accommodate Extron® Electronics MAAP and AAP series AV modules.



4X4 Applications

Provides maximum power capacity for flush, multi-service applications. This sub-plate features a pre-wired four outlet 20A, 125V receptacle and four openings for Hubbell's Snap Fit, flush mount modular jacks and AV connectors.

Traditional Hubbell FRPTs for 3 Inch and 2 Inch Concrete Core Hole Applications...



Flush Applications

Hubbell offers a variety of single and multi-service flush fire-rated poke-through products. It incorporates a Hubbell Style Line®, 20 amp, duplex receptacle and two Hubbell Category 6 data jacks. The jacks mount flush to the cover for an unobtrusive appearance. Various colors and all brass versions are available.



Pedestal Applications

Hubbell offers single and multi-service pedestal style FRPTs for those applications requiring above-the-floor connections. Available in 2, 4 or 6-gang sizes, pedestal FRPTs provide more power and low voltage connections to the desktop than most flush configurations in a 3 Inch core hole.



Furniture Feed Applications

Hubbell offers single and multiple service flush and pedestal style FRPTs that deliver power and voice/data cabling to feed furniture systems. Various models can feed up to 2 inch conduit and can accommodate up to 36 Category 5e data cables.

Extron® is a registered trademark of Extron Electronics.

Features and Benefits

SystemOne Flush 4 Inch Core Through Floor Fittings



- Step down installation clips allow the fitting to be installed or removed from the floor above
- Fire barrier expands during fire conditions to maintain the floor's fire rating
- Adjustable lower fire barrier accommodates concrete floor thicknesses from 2¼ to 7 inch
- Oversized EMT conduit tubes for increased cable capacity

Universal Flange and Cover Assembly

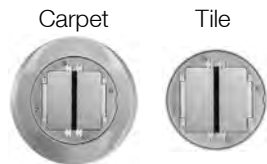

- Hinged doors open 180 degrees flush to the carpet flange or tile
- Locking studs allow each door to be secured independently
- The universal carpet or tile flange can be used for Hubbell SystemOne Fire-Rated Poke-Throughs and Floor Boxes
- Finishes and colors available:

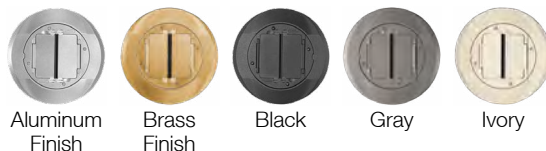

Hubbell SystemOne Flush Sub-Plates

Hubbell's modular sub-plate design allows users to economically upgrade Hubbell SystemOne FRPT and Floor Boxes to accommodate future moves, additions and changes. See page P-27 for additional information.

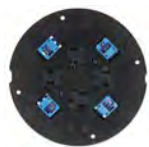

4x4 Sub-Plate



Datacom and Power Sub-Plate



Extron® APP/MAPP and Power Sub-Plate



Dual Style Line® Decorator Sub-Plate



Twist-Lock® Sub-Plate



Furniture Feed Cover, Carpet

Extron® is a registered trademark of Extron Electronics. Siemon™ is a trademark of The Siemon Company. Panduit® is a registered trademark of Panduit Corp. SYSTIMAX® is a registered trademark of CommScope, Inc. Ortronics® is a registered trademark of Ortronics/Legrand.

Features

- Accepts all Hubbell SystemOne universal covers and flush sub-plates
- Excellent solution for retrofit and new construction
- Delivers power, voice, data and multimedia
- UL listed for use in 1 – 4 hour fire rated floors at 100% rated fill
- Available with integral power junction box
- SystemOne Fire-Rated Poke-Throughs are approved for use in the City of Chicago
- UL installation spacing - minimum 2 feet on center, not more than one per 65 square feet of floor area in each span

Features

- Durable cast aluminum construction available in black, gray, brass, aluminum and ivory powder coat finishes
- Features ScrubShield® technology that exceeds UL514A scrubwater exclusion requirements
- Provides consistent look and maximum functionality throughout the installed life
- Meets ADA requirements for accessible design









Features

- Durable cast aluminum construction, powder coat finish
- Hubbell 4X4: four 20A, 125V receptacles, four keystone openings for voice/data jacks and flush multimedia connectors
- Hubbell X-END and Hubbell iSTATION modular connectivity
- Accommodates Extron® Electronics Architectural Series AV system integration products
- Accommodates GFCI, surge and standard Style Line® Decorator receptacles
- Twist-Lock® receptacle with two flush keystone openings
- Large capacity and multi-service furniture feed applications
- Open system sub-plates permit maximum data flexibility

SystemOne Flush Systems 4 Inch Core Hole One-Piece Units, for Use In Concrete Floors

Hubbell SystemOne 4 Inch Core Hole, One-Piece Units

All Hubbell SystemOne 4 Inch core, one-piece units include the sub-plate and cover to simplify your order and reduce installation time. Units are also available with a power junction box installed. The junction box is also available for purchase separately.

Description	Color	Catalog Number without Junction Box	Catalog Number with Junction Box*	
<p>One-Piece 4X4 Poke-Through</p> <p>Assembled-unit includes:</p> <ul style="list-style-type: none"> • Hubbell SystemOne 4X4 floor fitting (S1PT4X4FIT) • 4x4 sub-plate (S1SP4X4) • Finish flange and universal carpet cover assembly (S1CFCxx) • 4-hour fire classification <p>Keystone openings accept Hubbell modular jacks, X-END connectors and flush multimedia snap fit connectors. Receptacles feature single or two circuit wiring and isolated ground capability.</p>	<p>Aluminum Finish Brass Finish Black/Brass Finish Black Gray</p> 	<p>S1PT4X4AL S1PT4X4BRS S1PT4X4BRS3 S1PT4X4BL S1PT4X4GY</p>	<p>S1PT4X4ALJ S1PT4X4BRSJ S1PT4X4BRS3J S1PT4X4BLJ S1PT4X4GYJ</p>	 S1PT4X4BLJ
<p>One-Piece Dual Style Line® Decorator Poke-Through</p> <p>Assembled-unit includes:</p> <ul style="list-style-type: none"> • Hubbell SystemOne dual channel floor fitting (S1PTFIT) • Dual Style Line® decorator opening sub-plate (S1SP) • Finish flange and universal carpet cover assembly (S1CFCxx) • 4-hour fire classification <p>Style Line® decorator openings accept two Style Line® decorators or one surge or GFCI receptacle and one Style Line® decorator receptacle. Outlet frames can be used to convert the application to a 6-port multi-service or a 12-port all communication solution. Fitting is 4-hr rated at 100% fill to accommodate (12) Cat. 6A cables (0.330" diameter).</p>	<p>Aluminum Finish Brass Finish Black Gray</p> 	<p>S1PTAL S1PTBRS S1PTBL S1PTGY</p>	<p>S1PTALJ S1PTBRSJ S1PTBLJ S1PTGYJ</p>	 S1PTAL
<p>One-Piece Modular AV Poke-Through</p> <p>Assembled-unit includes:</p> <ul style="list-style-type: none"> • Hubbell SystemOne AV floor fitting (S1PTAVFIT) • 20A, 125V power and 3-unit Hubbell iSTATION sub-plate (S1SP3IM) • Finish flange and universal carpet cover assembly (S1CFCxx) • 4-hour fire classification <p>The Hubbell iSTATION's recessed opening can accommodate data/voice/audio and video solutions including 15-pin VGA, RCA, S-Video, 3.5mm stereo, X-END, HDMI and XLR microphone jacks.</p>	<p>Aluminum Finish Brass Finish Black Gray</p> 	<p>S1PT3IMAL S1PT3IMBRS S1PT3IMBL S1PT3IMGY</p>	<p>S1PT3IMALJ S1PT3IMBRSJ S1PT3IMBLJ S1PT3IMGYJ</p>	 S1PT3IMAL
<p>One-Piece Furniture Feed Poke-Through</p> <p>Assembled-unit includes:</p> <ul style="list-style-type: none"> • Hubbell SystemOne AV floor fitting (S1PTAVFIT) • Hubbell SystemOne furniture feed cover plate (S1SPFFxx) • 4-hour fire classification <p>This solution provides one 3/4 in. conduit for power and one 1 1/2 in. conduit for low-voltage. Furnished with two screw-in flexible metal conduit connectors.</p>	<p>Aluminum Finish Brass Finish Black Gray</p> 	<p>S1PTFFAL S1PTFFBRS S1PTFFBL S1PTFFGY</p>	<p>S1PTFFALJ S1PTFFBRSJ S1PTFFBLJ S1PTFFGYJ</p>	 S1PTFFGY

Note: *Junction box factory installed on through floor fitting. See pages P-40 and P-41 for technical information.

SystemOne Flush Systems 4 Inch Core Hole Three-Piece Units, for Use In Concrete Floors



S1PT4X4FITJ



S1PTFIT



S1PTAVFIT

Hubbell SystemOne 4 Inch Core, Three-Piece Units

Description

4X4 Through Floor Fitting

Through floor fitting with two ¾ in. EMT for communications and one ¾ in. EMT for power. For use with Hubbell SystemOne universal covers and S1SP4X4 and S1SPTL series sub-plates only. Universal cover and sub-plate ordered separately. 4-hour fire classification.

Catalog Number without Junction Box

S1PT4X4FIT

Catalog Number with Junction Box*

S1PT4X4FITJ

Dual Channel Through Floor Fitting

Through floor fitting with two 1 in. EMT conduit stems to feed power and/or communication services. For use with Hubbell SystemOne universal covers and all Hubbell sub-plates except S1SP4X4 and S1SPTL series. Universal cover and sub-plate ordered separately. 4-hour fire classification.

S1PTFIT

S1PTFITJ

AV Through Floor Fitting

Through floor fitting with one ¾ in. EMT conduit stem for power and one 1½ in. EMT conduit stem for communication services. Ideal for demanding, high capacity AV and data requirements. For use with Hubbell SystemOne universal covers and all Hubbell sub-plates except S1SP4X4 and S1SPTL series. Universal cover and sub-plate ordered separately. 4-hour fire classification.

S1PTAVFIT

S1PTAVFITJ

Note: *Junction box factory installed on through floor fitting. See pages P-40 and P-41 for technical information.

Hubbell SystemOne Universal Cover

- Cast aluminum construction
- Durable powder coat finish



Carpet



Tile

Finish/Color	Carpet	Tile
Aluminum Finish	S1FCAL	S1TFCAL
Brass Finish	S1FCBRS	S1TFCBRS
Black	S1FCBBL	S1TFCBBL
Gray	S1FCGY	S1TFCGY
Ivory	S1FCI	S1TFCI



Aluminum Finish



Brass Finish



Black



Gray



Ivory

Poke Through Accessories

Description

Color

Catalog Number

Abandonment Plates

Used to cover abandoned SystemOne Fire-Rated Poke-Throughs or Floor Boxes.

Black
Gray



S1AP4BL
S1AP4GY

Fire-Rated Closure Plug

Used to seal a 4 Inch core hole when the FRPT is no longer required and the through-floor fitting is removed. Maintains the floor's 1-4 hour fire rating.

Black
Gray



S1FRP4BL
S1FRP4GY

Power Junction Box

For use with SystemOne Fire-Rated Poke-Throughs. Provides 27.0 cubic inches. (1) ¾ and (1) 1" EMT connector supplied.

Trade size knockouts: Top (1) 1 inch
Bottom (1) ¾ inch
Sides (2) ½ inch
(1) ¼ inch

Black
Gray



S1FRPTJB

4 Inch Dia., Pre-Pour Tube































Includes hardware.



S1R4PPT*



Note: *Not UL Listed.

SystemOne Flush Sub-Plates

Description	Catalog Number	Description	Catalog Number	Description	Catalog Number
Style Line® Decorator/GFCI (2) Style Line® decorator openings for power and/or datacom applications.	 S1SP	Duplex/Duplex (2) Duplex openings for power and/or datacom applications.	 S1SPDU	Duplex/Style Line® Decorator (1) Duplex and (1) Style Line® decorator opening for power and/or datacom applications.	 S1SPDUSL
Hubbell 4 X 4 (4) 20A, 125V receptacles. (4) Keystone openings for Hubbell jacks or flush AV connectors. Power can be wired as single or two circuit with isolated ground capability. Includes  stickers.	 S1SP4X4 S1SP4X4C	Carpet Furniture Feed Cover/Flange* (1) ¾" and (1) 1½" NPT access holes for power and/or datacom applications. Universal Cover not required. Includes carpet flange.		Tile Furniture Feed Cover/Flange* (1) ¾" and (1) 1½" NPT access holes for power and/or datacom applications. Universal Cover not required. Includes tile flange.	
Provided with 15 ft. wire leads Provided with 30 ft. wire leads	S1SP4X415 S1SP4X430	Aluminum Fin. Brass Finish Black Gray	S1SPFFAL S1SPFFBRS S1SPFFBL S1SPFFGY	Aluminum Fin. Brass Finish Black Gray	S1SPFFTL S1SPFFTBRS S1SPFFTBL S1SPFFTGY
Single Receptacle + Data Opening for 20 or 30A Twist-Lock® receptacle (1.56" OD) and (2) Keystone openings for Hubbell jacks or flush AV connectors.	 S1SPTL	Hubbell DataCom + Power (1) 20A, 125V receptacle and 3-unit recessed Hubbell iSTATION opening for data, voice, and AV applications. Marked with  "Controlled"	 S1SP3IM S1SP3IMC	Hubbell DataCom + Duplex (1) Duplex opening, (2) flush Keystone openings and 1.5 unit recessed Hubbell iSTATION opening for data, voice and AV applications.	 S1SPDU2IM
Hubbell DataCom + Style Line® Decorator (1) Style Line® decorator opening, (2) flush Keystone openings and 1.5 unit recessed Hubbell iSTATION opening for data, voice and AV applications.	 S1SPSL2IM	Hubbell DataCom 1 unit flush Hubbell iSTATION opening and 3-unit recessed Hubbell iSTATION opening for data, voice, and AV applications.	 S1SP4IM	Active Multimedia + Power Single 20A, 125V receptacle; (2) flush Keystone openings; (1) rectangular Style Line® decorator opening to accommodate active multimedia modules or low voltage outlet frames.	 S1SPAMM20 S1SPAMM20C
Extron® or FSR + Power (1) 20A, 125V receptacle. Recessed opening for (3) single Extron® MAAP series adapter plates or FSR IPS plates. Marked with  "Controlled"	 S1SPEXT1 S1SPEXT1C	Extron® or FSR + Power (1) 20A, 125V receptacle. Recessed opening for (1) single Extron® MAAP and (2) single AAP series adapter plates or FSR IPS plates. Marked with  "Controlled"	 S1SPEXT2 S1SPEXT2C	Extron® or FSR Single-Service Recessed opening for (2) single Extron® MAAP and (2) single AAP series adapter plates or FSR IPS plates.	 S1SPEXT3
Extron® AAP + Power (1) 20A, 125V receptacle. (2) flush Keystone & recessed opening for (2) single Extron® AAP Series adapter plates. Marked with  "Controlled"	 S1SPEXT4 S1SPEXT4C	Ortronics Series II® + Power (1) 20A, 125V receptacle. Recessed opening for (3) 1 unit Ortronics Series II® modules. Marked with  "Controlled"	 S1SPORT S1SPORTC	Ortronics TracJack® + Power (1) 20A, 125V receptacle. Recessed bezel for (6) Ortronics TracJack® modules. Marked with  "Controlled"	 S1SPTRAC S1SPTRACC
Panduit Mini Com® 4 X 4 (4) 20A, 125V receptacles. (4) Openings for Panduit Mini-Com Connectivity. Includes  stickers.	 S1SP4X4PA S1SP4X4PAC	SYSTIMAX® 4 X 4 (4) 20A, 125V receptacles. (4) Openings for SYSTIMAX® Connectivity. Includes  stickers.	 S1SP4X4SYS S1SP4X4SYSYSC	Siemon MAX® + Power (1) 20A, 125V receptacle. Recessed bezel for (6) Siemon MAX® modules. Marked with  "Controlled"	 S1SPMAX S1SPMAXC

Note: *Furnished with two screw-in flexible metal conduit connectors. See Network Wiring section for complete offering of Hubbell jacks, frames and datacom accessories. See page P-30 for FRPT Configuration Chart.

Sub-Plate Accessories

Description	Catalog Number	Description	Catalog Number
Replacement Threaded Conduit Plugs Used with S1SPFFx and S1SPFFTx only. Sub-plate is supplied with plugs.		Replacement for S1SPMAX. Sub-plate is supplied with data frame. Works with Siemon MAX®.	S1DFMAX
 Color	1½" Plug	Replacement for S1SPTRAC sub-plate. Sub-plate is supplied with data frame. Works with Ortronics TracJack®.	S1DFTRAC
 Aluminum Finish	S1FP15AL	Blank Style Line® decorator frame, Black.	NS620BK
Brass Finish	S1FP15BRS	2-Port Style Line® decorator frame, Black.	ISF2BK
Black	S1FP15BL	4-Port Style Line® decorator frame, Black.	ISF4BK
Gray	S1FP15GY	6-Port Style Line® decorator frame, Black.	ISF6BK

Extron® is a registered trademark of Extron Electronics. MAX® is a registered trademark of The Siemon Company. Mini-Com® and Panduit® are registered trademarks of Panduit Corp. SYSTIMAX® is a registered trademark of CommScope, Inc. TracJack®, Series II® and Ortronics® are registered trademarks of Ortronics/Legrand.

SystemOne Flush Configuration Chart			Floor Boxes*						4" Core Hole Fire-Rated Poke-Throughs		
			Non-Metallic	Metal							
Approved for use in the City of Chicago. (except S1PFB)											
Sub-Plates											
S1SP	Style Line® Decorator/GFCI		3	3.5	3.5	3.5	3.5	3.5	✓+	✗	✓
S1SPDU	Duplex/Duplex		3	3.5	3.5	3.5	3.5	3.5	✓+	✗	✓
S1SPDUSL	Duplex/Style Line® Decorator		3	3.5	3.5	3.5	3.5	3.5	✓+	✗	✓
S1SP4X4 S1SP4X4PA S1SP4X4SYS	Hubbell 4 X 4 Panduit Mini-Com® 4 X 4 SYSTIMAX® 4 X 4		4	4	4	4	4	4	✗	✓+	✗
S1SP4X4C S1SP4X4PAC S1SP4X4SYSC	Marked with "Ⓞ Controlled"		4	4	4	4	4	4	✗	✓+	✗
S1SPTL	Twist-Lock® Receptacle + Data		4	4	4	4	4	4	✗	✓+	✗
S1SP3IM	Hubbell DataCom + Power		5	5	5	5	5	5	✓	✗	✓+
S1SP4IM	Hubbell DataCom		3.5	3.5	3.5	3.5	3.5	3.5	✓	✗	✓+
S1SPDU2IM	Hubbell DataCom + Duplex		5	5	5	5	5	5	✓	✗	✓+
S1SPSL2IM	Hubbell DataCom + Style Line® Decorator		5	5	5	5	5	5	✓	✗	✓+
S1SPFFxx (Carpet)	Furniture Feed Cover/Flange (Replace "xx" with BRS (Brass finish), AL (Aluminum finish), BL (Black) or GY (Gray).		3	3.5	3.5	3.5	3.5	3.5	✓	✗	✓+
S1SPFFTxx (Tile)			3	3.5	3.5	3.5	3.5	3.5	✓	✗	✓+
S1SPEXT1	Extron® or FSR + Power		4	4	4	4	4	4	✓	✗	✓+
S1SPEXT1C	Marked with "Ⓞ Controlled"		4	4	4	4	4	4	✓	✗	✓+
S1SPEXT2	Extron® or FSR + Power		4	4	4	4	4	4	✓	✗	✓+
S1SPEXT2C	Marked with "Ⓞ Controlled"		4	4	4	4	4	4	✓	✗	✓+
S1SPEXT3	Extron® or FSR Single-Service		4.5	4.5	4.5	4.5	4.5	4.5	✓	✗	✓+
S1SPEXT4	Extron® or FSR + Power		4	4	4	4	4	4	✓	✗	✓+
S1SPEXT4C	Marked with "Ⓞ Controlled"		4	4	4	4	4	4	✓	✗	✓+
S1SPORT	Ortronics Series II® + Power		5	5	5	5	5	5	✓	✗	✓+
S1SPORTC	Marked with "Ⓞ Controlled"		5	5	5	5	5	5	✓	✗	✓+
S1SPTRAC	Ortronics TracJack® + Power		5	5	5	5	5	5	✓	✗	✓+
S1SPTRACC	Marked with "Ⓞ Controlled"		5	5	5	5	5	5	✓	✗	✓+
S1SPMAX	Simon MAX® + Power		5	5	5	5	5	5	✓	✗	✓+
S1SPMAXC	Marked with "Ⓞ Controlled"		5	5	5	5	5	5	✓	✗	✓+
S1SPAMM20	Active Multimedia + Flush Keystone + Power		5	5	5	5	5	5	✓	✗	✓+
S1SPAMM20C	Marked with "Ⓞ Controlled"		5	5	5	5	5	5	✓	✗	✓+
S1CFCxx (Carpet)	SystemOne Floor Boxes and FRPTs use SystemOne Universal Covers (Replace "xx" with BRS (Brass finish), AL (Aluminum finish), BL (Black) or GY (Gray).		Signifies minimum depth of concrete pour in inches for Hubbell SystemOne Floor Boxes.						✓+	✓	✗
S1TFCxx (Tile)									Recommended Floor Fitting	Alternative Floor Fitting	Not Compatible

Extron® is a registered trademark of Extron Electronics. MAX® is a registered trademark of The Siemon Company. Mini-Com® and Panduit® are registered trademarks of Panduit Corp. SYSTIMAX® is a registered trademark of CommScope, Inc. TracJack®, Series II® & Ortronics® are registered trademarks of Ortronics/Legrand.

Traditional Flush 2X2 FRPT 3 Inch Core Hole Units, for Use In Concrete Floors

2X2 Flush FRPT, One-Piece Units (PT2X2FIT)



Description	Color	Catalog Number	Description	Color/Material	Catalog Number
2X2 Poke-Through Non-metallic Cover	Black/Aluminum Black/Aluminum Black Gray Black Gray	PT2X2ALU3 PT2X2IGALU3 PT2X2BL PT2X2GY PT2X2IGBL* PT2X2IGGY*	2X2 Poke-Through	Black/Brass Brass Finish/Brass Black/Brass Brass Finish/Brass	PT2X2BRS3 PT2X2BRS PT2X2IGBRS3* PT2X2IGBRS*
<ul style="list-style-type: none"> Pre-wired 20A Style Line® decorator duplex receptacle and (2) Category 6 data jacks Painted or brushed aluminum flange Approved for use in the City of Chicago 			<ul style="list-style-type: none"> Pre-wired 20A Style Line® decorator duplex receptacle and (2) Category 6 data jacks Solid brass flange Approved for use in the City of Chicago 		

Note: *Includes pre-wired 20A isolated ground Style Line® decorator duplex receptacle.



2X2 Flush FRPT, Two-Piece Units

Description	Catalog Number
Multi-Channel Through-Floor Fitting with (1) ¼ in. EMT stem with junction box for power and (2) ½ in. EMT stems for low voltage.	PT2X2FIT
	<p>Specifications:</p> <ul style="list-style-type: none"> 1 – 4 hour fire rating (1 – 3 hour for steel floor units and concrete topping, D900 Series Design) For 2¼ in. to 7 in. floor thickness UL installation spacing – minimum 2 ft. on center and not more than one per 65 sq. ft. of floor area Approved for use in the City of Chicago

Service Fittings

Description	Color	Catalog Number	Description	Color/Material	Catalog Number
2X2 Service Fitting Non-metallic Cover/ Aluminum Flange	Black/Aluminum Black Gray	PT2X2SFALU3 PT2X2SFBL PT2X2SFGY	2X2 Service Fitting Non-metallic Cover/ Brass Flange	Black/Brass Brass Finish/Brass	PT2X2SFBR3 PT2X2SFBR3
<ul style="list-style-type: none"> Pre-wired 20A Style Line® decorator duplex receptacle and (2) Category 6 data jacks Painted or brushed aluminum flange 			<ul style="list-style-type: none"> Pre-wired 20A Style Line® decorator duplex receptacle and (2) Category 6 data jacks Solid brass flange 		

Accessories

Description	Color/Material	Catalog Number	Description	Color/Material	Catalog Number
Non-metallic Replacement Covers	Brass Finish Black Gray	PT2X2CBRS PT2X2CBL PT2X2CGY	Closure Plug Textured aluminum plug seals 3 in. core hole when FRPT is no longer required and is removed. Maintains the floor's 1 – 4 hour fire rating. UL Listed and CSA Certified.	Gray	FRP250
					

Note: See page P-43 for technical information.

Traditional Flush Duplex FRPT 3 Inch Core Hole Units, for Use In Concrete Floors

Flush Duplex FRPT, One-Piece Units

Description	Color	Catalog Number	Description	Color/Material	Catalog Number
Flush Poke-Through	Black Brown Gray Ivory Gray Ivory	PT7FSDBLA PT7FSDBRA PT7FSDGYA PT7FSDIA PT7IGFSDGYA* PT7IGFSDIA*	Flush Brass Poke-Through	All Brass Black/Brass All Brass	PT7FSDBRS2A PT7FSDBRS3A PT7IGFSDBRSA*

Complete assembled unit includes:

- Pre-wired 20A duplex receptacle
- Non-metallic flip lid cover with (2) ½ in. diameter low voltage feed-through holes
- Painted aluminum flange



Complete assembled unit includes:

- Pre-wired 20A duplex receptacle
- All brass or black non-metallic cover option
- Flip lid cover with (2) ½ in. diameter low voltage feed-through holes
- Solid brass flange



Note: *Includes pre-wired 20A isolated ground duplex receptacle.

Flush FRPT, Two-Piece Units

Description	Catalog Number
Multi-Channel Through-Floor Fitting with (1) ¼ in. EMT stem for power and (2) ½ in. low voltage feed-through holes.	PT7FSD (with Junction Box) PT73SD (without Junction Box)



Specifications:

- 1 – 4 hour fire rating (1 – 3 hour for steel floor units and concrete topping, D900 Series Design)
- For 2¼ in. to 7 in. floor thickness
- UL installation spacing – minimum 2 ft. on center and not more than one per 65 sq. ft. of floor area

Service Fittings

Description	Color	Catalog Number	Description	Color/Material	Catalog Number
Flush Aluminum Service Fitting	Black Brown Gray Ivory	FRFBLA FRFBRA FRFGYA FRFIA	Flush Brass Service Fitting	Solid Brass	FRFBRS2A

Complete assembled unit includes:

- Pre-wired 20A duplex receptacle
- Non-metallic flip lid cover with (2) ½ in. diameter low voltage feed-through holes
- Painted aluminum flange



Complete assembled unit includes:

- Pre-wired 20A duplex receptacle
- Solid brass flip lid cover with (2) ½ in. diameter low voltage feed-through holes
- Solid brass flange



Accessories

Description	Color	Catalog Number	Description	Color/Material	Catalog Number
Non-metallic Replacement Covers	Black Brown Gray Ivory	PFBRCBLA PFBRCBRA PFBRCGYA PFBRCIA	All Brass Replacement Covers	Solid Brass	BRS2RCA







Note: See page P-35 for 3 Inch FRPT accessories.
See page P-43 for technical information.



Traditional Flush Furniture Feed FRPT 3 Inch Core Hole Units, for Use In Concrete Floors

Large Capacity, Single-Service Flush Furniture Feed FRPT, Two-Piece Units

Description	Catalog Number	Description	Color/Material	Catalog Number
Large Capacity, Single-Service Through Floor Fitting with (1) 2 in. EMT stem. Will accommodate up to 36 Category 6 cables.	PT2FIT	Large Capacity Cover/Flange	Brass Finish Black Gray	FF2BRS FF2BK FF2GY
<p>Specifications:</p> <ul style="list-style-type: none"> • 1- to 2-hour fire rating • Single-Service, Power or Data • For 2¼ to 7 in. floor thickness • UL installation spacing – minimum 2 ft. on center and not more than 1 per 65 sq. ft. of floor area • Approved for use in the City of Chicago 		<p>Specifications:</p> <ul style="list-style-type: none"> • Cover/flange with 1¼ in. and 2 in. trade size combination knockout • Painted aluminum cover and flange • Approved for use in the City of Chicago 		



Note: See page P-44 for technical information.

Flush Furniture Feed FRPT, One-Piece Units



Description	Color	Catalog Number	Description	Color	Catalog Number
3-Service Furniture Feed Poke-Through	Black Gray Ivory	PT73FFSDBK PT73FFSDGY PT73FFSDI	Single-Service Furniture Feed Poke-Through	Black Gray Ivory	— PT7FFSDGY PT7FFSDI
<p>Complete assembled unit includes:</p> <ul style="list-style-type: none"> • PT73SD floor fitting • Aluminum cover with (2) ½ in. threaded hubs for low voltage and (1) ¾ in. threaded hub for power • Painted aluminum flange 			<p>Complete assembled unit includes:</p> <ul style="list-style-type: none"> • PT71SD floor fitting • Aluminum cover with (1) KO to accept a ¾ in. connector • Painted aluminum flange 		

Note: See page P-44 for technical information.

Flush Furniture Feed FRPT, Two-Piece Units

Description	Catalog Number	Description	Catalog Number
3-Service Furniture Feed Through-Floor Fitting with (1) ¾ in. EMT stem for power and (2) ½ in. low voltage conduit holes.	PT73SD	Single-Service Furniture Feed Through-Floor Fitting with (1) ¾ in. EMT stem for power or low voltage applications.	PT71SD
<p>Specifications:</p> <ul style="list-style-type: none"> • 1 – 4 hour fire rating (1 – 3 hour for steel floor units and concrete topping, D900 Series Design) 		<p>Specifications:</p> <ul style="list-style-type: none"> • For 2¼ to 7 in. floor thickness • UL installation spacing – minimum 2 ft. on center and not more than 1 per 65 sq. ft. of floor area 	

Service Fittings

Description	Color	Catalog Number	Description	Color	Catalog Number
3-Service Furniture Feed Service Fitting	Black Gray Ivory	FRF3BK FRF3GY FRF3I	Single-Service Furniture Feed Service Fitting	Brass Finish Black Gray	FRF1BRS FRF1BK FRF1GY
<p>Complete assembled unit includes:</p> <ul style="list-style-type: none"> • Aluminum cover with (2) ½ in. threaded hubs for low voltage and (1) ¾ in. threaded hub for power • Painted aluminum flange 			<p>Complete assembled unit includes:</p> <ul style="list-style-type: none"> • Aluminum cover with (1) KO to accept a ¾ in. connector • Painted aluminum flange 		

Note: See page P-35 for 3 Inch FRPT accessories.
See page P-44 for technical information.

Painted Pedestal FRPT 2 and 3 Inch Core Hole Units, for Use In Concrete Floors

3 Inch Core Hole, Two-Piece Unit

Description	Catalog Number
Large Capacity Multi-Service Pedestal Through-Floor Fitting with (1) 1 1/4 in. EMT stem for low voltage and (1) 1/2 in. EMT stem for power applications.	PT7XC
Specifications:	
<ul style="list-style-type: none"> • 1 – 4 hour fire rating (1 – 3 hour for steel floor units and concrete topping, D900 Series Design) • For 2 1/4 in. to 7 in. floor thickness • Approved for use in the City of Chicago 	



2 Inch Core Hole, Two-Piece Unit

Description	Catalog Number
Multi-Service Pedestal Through-Floor Fitting with (1) 3/4 in. EMT stem for low voltage and (1) 1/2 in. EMT stem for power applications.	PT27A
Specifications:	
<ul style="list-style-type: none"> • 1 – 4 hour fire rating (1 – 3 hour for steel floor units and concrete topping, D900 Series Design) • For 2 1/4 in. to 7 in. floor thickness • Approved for use in the City of Chicago 	



Note: See page P-45 for technical information.

Pedestal Service Fittings (Order 1 plate per gang)

Description	Color/Material	Catalog Number	Description	Color	Catalog Number	Description	Color	Catalog Number
2-Gang	Alum. Finish Black Gray	FR280ALA FR280BKA FR280GYA	4-Gang	Black Gray	FR480BKA FR480GYA	6-Gang	Black Gray	FR680BKA FR680GYA
Use with PT27A only.			Use with PT27A or PT7XC.			Use with PT27A or PT7XC.		
		FR280BKA			FR480GYA			FR680BKA

- Painted aluminum housing with low voltage barrier(s); plates and devices sold separately
- For additional barriers, use **FRBR1**, see page P-33.
- UL Listed and CSA Certified

Note: See page P-45 for technical information.

Pedestal Face Plates (Order 1 plate per gang)

Description	Color/Material	Catalog Number	Description	Color/Material	Catalog Number
Duplex	Black Gray	SS2309DBKA SS2309DGYA	Furniture feed (3/4 in. KO)	Alum. Finish Black Gray	SS2309FALA SS2309FBKA SS2309FGYA
Style Line®/GFCI	Black Gray	SS2309SLBKA SS2309SLGYA	Furniture feed (1 in. KO)	Black Gray	SS2309F1BKA SS2309F1GYA
Single receptacle (1.39 in. OD)	Black Gray	SS2309SBKA SS2309SGYA	Bushed data opening (1 in. ID)	Black Gray	SS2309TBKA SS2309TGYA
Blank	Alum. Finish Black Gray	SS2309BALA SS2309BBKA SS2309BGYA			

- Painted aluminum plates
- UL Listed and CSA Certified

Brushed Aluminum Pedestal FRPT 3 Inch Core Hole Two-Piece Units, for Use In Concrete Floors

Through-Floor Fitting







Description	Catalog Number
Large Capacity Multi-Service Pedestal Through-Floor Fitting with (1) 1 ¼ in. EMT stem for low voltage and (1) ½ in. EMT stem for power applications. Specifications: <ul style="list-style-type: none"> • 1 – 4 hour fire rating (1 – 3 hour for steel floor units and concrete topping, D900 Series Design). • For 2¼ in. to 7 in. floor thickness. • Approved for use in the City of Chicago. 	PT7XC 

Pedestal Service Fitting

Description	Color/Material	Catalog Number
2-Gang Pedestal Service Fitting For use with PT7XC only. Specifications: <ul style="list-style-type: none"> • Brushed aluminum housing with low voltage barrier. Plates and devices sold separately. 	Brushed Aluminum	FR80AL 







Note: See pages P-45 and P-46 for technical information.

Plates

Description	Catalog Number	Description	Catalog Number
Duplex	SS309D 	Furniture feed (¾ in. KO)	SS309SF* 
Style Line®/GFCL	SS309DS 	Furniture feed, blank	SS309BF* 
Single receptacle (1.39 in. OD)	SS309S 	Bushed data opening (1 in. ID)	SS309T 
Blank	SS309B 	<ul style="list-style-type: none"> • 302/304 stainless steel plates (SS309SF and SS309BF are aluminum). • UL Listed and CSA Certified. 	

Note: *For furniture feed applications using **SS309SF**, a blank **SS309BF** must be used for second plate.

3 Inch Core Hole FRPT Accessories

Description	Color	Catalog Number	Description	Color/Gang	Catalog Number
Flush FRPT Abandonment Plate Use with PT7FSD, PT73SD or PT71SD only. Covers the opening when FRPT is abandoned. Service fitting is removed and through-floor fitting remains.	Gray Ivory	AP2GY AP2I 	PT7XC Extension Kit Extends PT7XC FRPT to accommodate between 7 in. and 13 in. floor thickness.	—	EXT13 
Multi-Service Furniture Feed Replacement Inserts Use as a replacement cover for PT73FFSD series, or to convert installed PT7FSD series into furniture feed FRPTs. Includes (2) ½ in. threaded hubs for low voltage and (1) ¾ in. threaded hub for power. (UL Listed only.)	Gray Ivory	FF3GY FF3I 	Pedestal FRPT Abandonment Plate Use with PT27A or PT7XC only. Covers the opening when FRPT is abandoned. Service fitting is removed and through-floor fitting remains.	Gray/ 2-gang Gray/ 4-gang	AP22  AP42 
Replacement Low Voltage Barrier Use with FR280, FR480, and FR680 pedestal service fittings only when additional power/low voltage separation is required.		FRBR1 			

Hubbell SystemOne Recessed 10 Inch Series

S1R10PTFIT Series

S1R10CVR Recessed Cover Series

S1R10CVRFF Cover Series

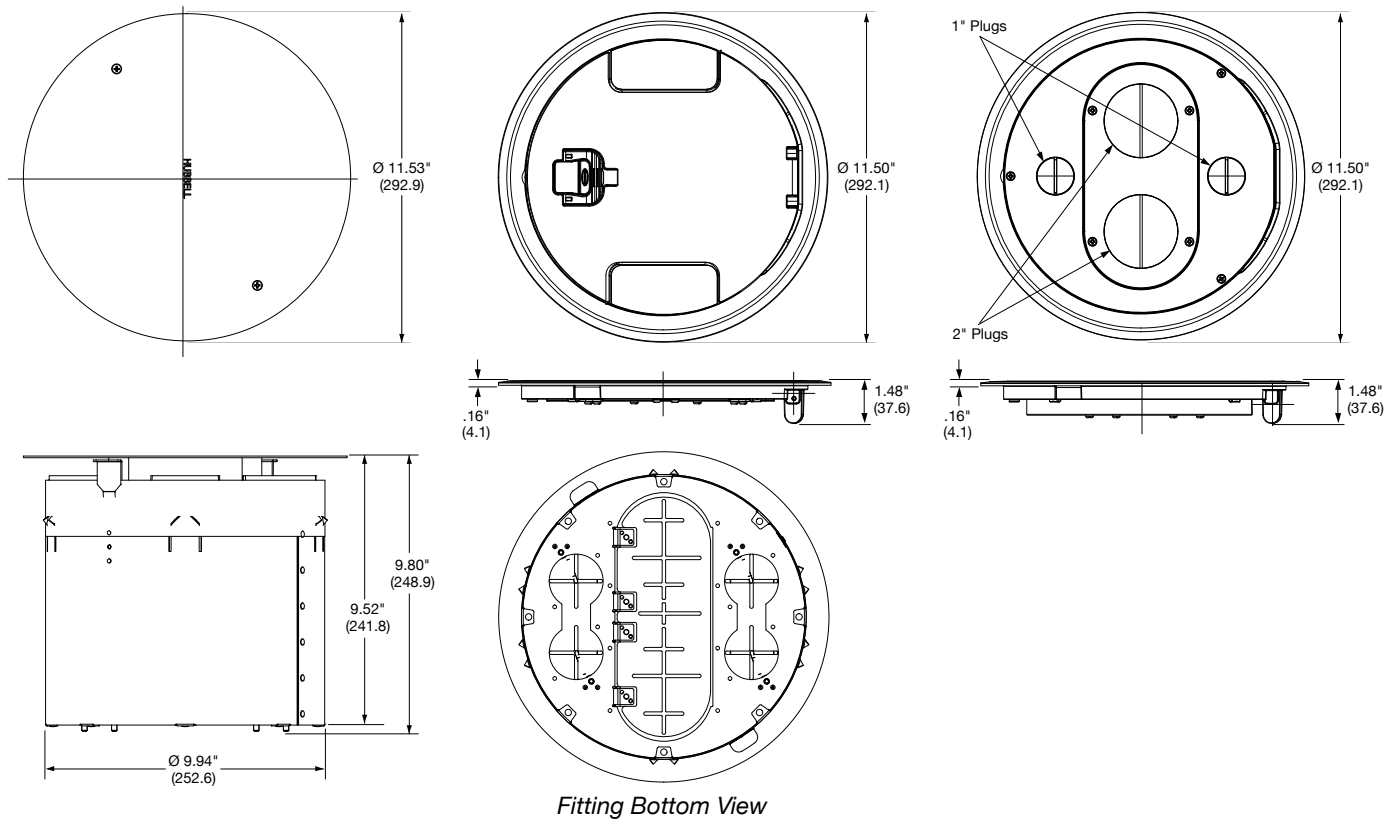

Product Information

- Plated cast aluminum covers available in brass, nickel or bronze finishes. Additionally available in brushed aluminum or black and gray powder coat.
- S1R10PSPZ series sub-plates supplied with pre-wired dual 20A receptacles. Wired with three #12 AWG solid conductors.
- Receptacles can be wired as dual circuit and isolated ground.
- S1R10FFCVR series furnished with one (2) 1 in. to 3/4 in. threaded reducer
- Meets ADA requirements for accessible design, "changes in level."
- Meets UL 514A scrubwater exclusion requirements.
- COVER LOAD RATING: 1,000 lbs with 2x safety factor. Load applied through a 3 in. (76) dia. mandrel at the center of the cover. **Rated for static loads only.**

Application Data

- Mounted in 10 in. (254.0) cored concrete diameter through hole.
- Minimum floor thickness: 2 1/4 in. (57.2).
- UL Listed for fire resistance in 1 – 2 hour rated D900 series floors.
- Approved for use in the City of Chicago.
- Not intended to be used in high traffic installations and not intended to support furniture.

Wire Size (AWG)	Copper Cross Sectional Area for Solid or Stranded Conductors
#24	.00032 sq. in. (.206mm ²)
#23	.00040 sq. in. (.258mm ²)
#22	.00050 sq. in. (.322mm ²)
#14	.00323 sq. in. (2.083mm ²)
#12	.00512 sq. in. (3.303mm ²)
#10	.00815 sq. in. (5.258mm ²)
#8	.01296 sq. in. (8.361mm ²)

UL Listed Wiring Capacity

	S1R10PT Recessed Series		S1R10PT FF Series	
Fire Resistance Rating	2-Hrs. (D900)		2-Hrs. (D900)	
Max. Copper Cross Section	Center Chamber .0978 sq. in.	Perimeter Chambers (each) .0408 sq. in.	Each 1 in. Power Hub .1304 sq. in.	Each 2 in. Low Voltage Hub .0962 sq. in.

UL Characteristics

Listing	UL File Number	ULC File Number
Outlet Box	E31999	CEYYC
Fire Resistance	R8429	R8429

For use in 1, 1 1/2 or 2 hour rated unprotected reinforced floors or in 1 or 2 hour rated floors employing steel floor units and concrete topping (D900 Series designs).
UL Spacing Restrictions - Minimum of 2 ft. on center and not more than one unit per each 65 square feet of floor area in each span.

Note: The above product data pertains to both kitted units and through-floor fittings.

When connecting conduit sweeps to through-floor fittings, ensure compliance with NEC fill tables.

Dimensions in Inches (mm)

Hubbell SystemOne Recessed 8 Inch Series

S1R8PT Series

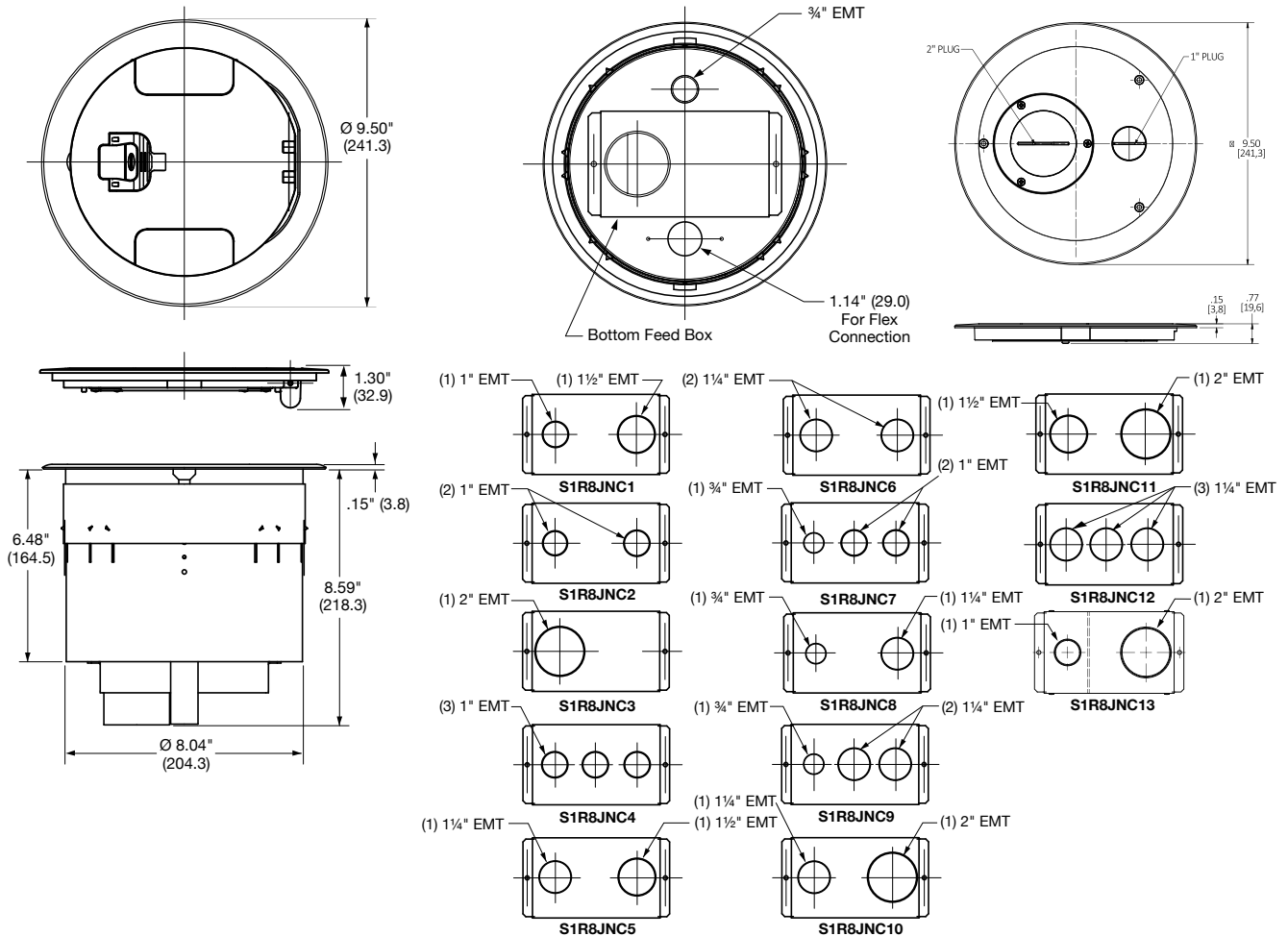

Product Information

- Plated cast aluminum covers available in brass, nickel or bronze finishes. Additionally available in brushed aluminum or black powder coat.
- S1R8PSPZ sub-plate supplied with pre-wired dual 20A receptacle. Wired with three #12 AWG solid conductors.
- Meets ADA requirements for accessible design, "changes in level."
- Meets UL 514A scrubwater exclusion requirements.
- COVER LOAD RATING: 1,000 lbs with 2x safety factor. Load applied through a 3 in. (76) dia. mandrel at the center of the cover. **Rated for static loads only.**

Application Data

- Mounted in 8 in. (203.2) cored concrete diameter through hole.
- Minimum floor thickness: 2 1/4 in. (57.2).
- UL Listed for fire resistance in 1 – 2 hour rated D900 series floors.
- Approved for use in the City of Chicago.
- Not intended to be used in high traffic installations and not intended to support furniture.

Wire Size (AWG)	Copper Cross Sectional Area for Solid or Stranded Conductors
#24	.00032 sq. in. (.206mm ²)
#23	.00040 sq. in. (.258mm ²)
#22	.00050 sq. in. (.322mm ²)
#14	.00323 sq. in. (2.083mm ²)
#12	.00512 sq. in. (3.303mm ²)
#10	.00815 sq. in. (5.258mm ²)
#8	.01296 sq. in. (8.361mm ²)

UL Listed Wiring Capacity

	S1R8PT Series	S1R8PT FF Series
Fire Resistance Rating	2-Hrs. (D900)	2-Hrs. (D900)
Max. Copper Cross Section	Perimeter Chambers (each) .0154 sq. in.	Center Chamber .0633 sq. in. 1 in. Power Hub .1304 sq. in. 2 in. Low Voltage Hub .0962 sq. in.

UL Characteristics

Listing	UL File Number	ULC File Number
Outlet Box	E31999	CEYYC
Fire Resistance	R8429	R8429

For use in 1, 1 1/2 or 2 hour rated unprotected reinforced floors or in 1 or 2 hour rated floors employing steel floor units and concrete topping (D900 Series designs).
UL Spacing Restrictions - Minimum of 2 ft. on center and not more than one unit per each 65 square feet of floor area in each span.

Note: The above product data pertains to both kitted units and through-floor fittings.

When connecting conduit sweeps to through-floor fittings, ensure compliance with NEC fill tables.

Dimensions in Inches (mm)

Hubbell SystemOne Recessed 6 Inch Series

S1R6PT Series

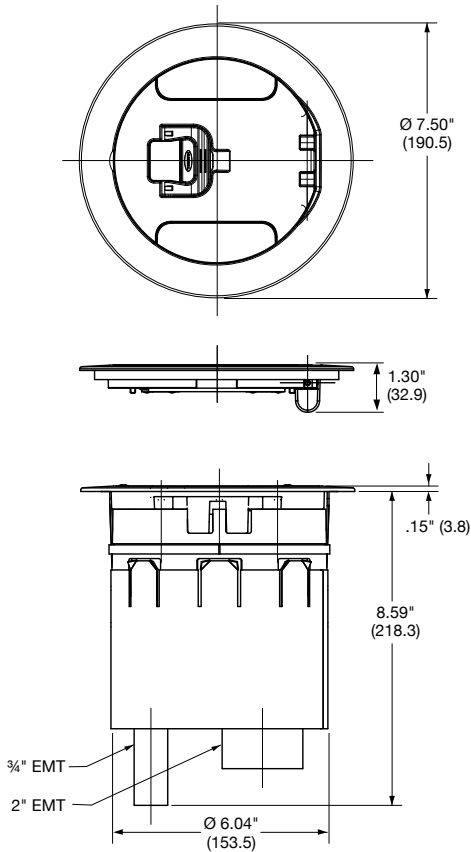

S1R6PTFF Series

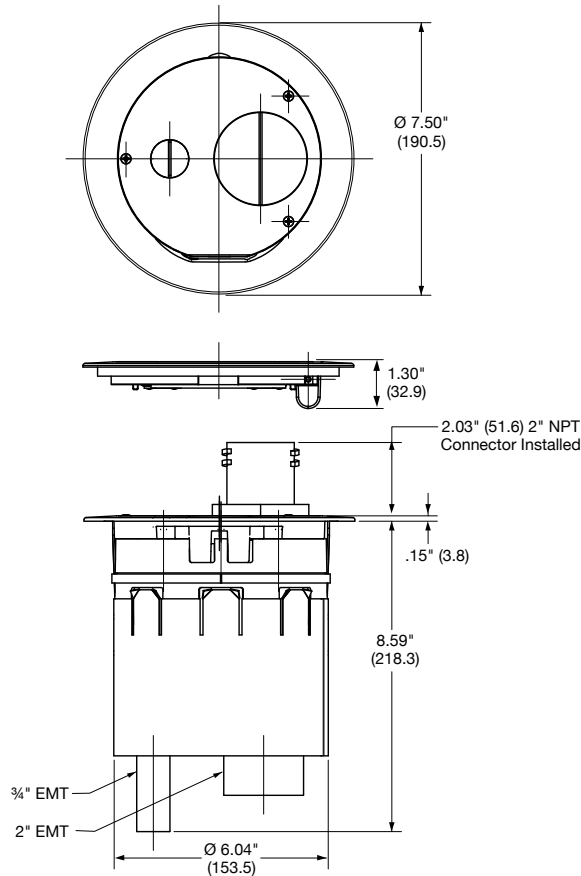

Product Information

- Plated cast aluminum covers available in brass, nickel or bronze finishes. Additionally available in brushed aluminum or black powder coat.
- S1R6SPZ sub-plate supplied with pre-wired dual 20A receptacle. Wired with three #12 AWG solid conductors.
- S1R6SPH sub-plate supplied with pre-wired quad 20A receptacle. Wired with six #12 AWG solid conductors. Receptacle can be wired as dual circuit and isolated ground.
- S1R6FFCVR series furnished with one (1) 3/4 in. and one (1) 2 in. screw-in flexible metal conduit connectors.
- Meets ADA requirements for accessible design, "changes in level."
- Meets UL 514A scrubwater exclusion requirements.
- COVER LOAD RATING: 1,000 lbs with 2x safety factor. Load applied through a 3 in. (76) dia. mandrel at the center of the cover. **Rated for static loads only.**

Application Data

- Mounted in 6 in. (152.4) cored concrete diameter through hole.
- Minimum floor thickness: 2 1/4 in. (57.2).
- UL Listed for fire resistance in 1 – 2 hour rated D900 series floors.
- Approved for use in the City of Chicago.
- Not intended to be used in high traffic installations and not intended to support furniture.

Wire Size (AWG)	Copper Cross Sectional Area for Solid or Stranded Conductors
#24	.00032 sq. in. (.206mm ²)
#23	.00040 sq. in. (.258mm ²)
#22	.00050 sq. in. (.322mm ²)
#14	.00323 sq. in. (2.083mm ²)
#12	.00512 sq. in. (3.303mm ²)
#10	.00815 sq. in. (5.258mm ²)
#8	.01296 sq. in. (8.361mm ²)

UL Listed Wiring Capacity

	S1R6PT Series		S1R6PTFF Series	
Fire Resistance Rating	2-Hrs. (D900)		2-Hrs. (D900)	
Max. Copper Cross Section	3/4 in. Power EMT .0307 sq. in.	2 in. Low Voltage EMT .0348 sq. in.	3/4 in. Power EMT .0815 sq. in.	2 in. Low Voltage EMT .0962 sq. in.

UL Characteristics

Listing	UL File Number	ULC File Number
Outlet Box	E31999	CEYYC
Fire Resistance	R8429	R8429

For use in 1, 1 1/2 or 2 hour rated unprotected reinforced floors or in 1 or 2 hour rated floors employing steel floor units and concrete topping (D900 Series designs).
UL Spacing Restrictions - Minimum of 2 ft. on center and not more than one unit per each 65 square feet of floor area in each span.

Note: The above product data pertains to both kitted units and through-floor fittings.

When connecting conduit sweeps to through-floor fittings, ensure compliance with NEC fill tables.

Dimensions in Inches (mm)

Hubbell SystemOne Recessed 4 Inch Series

S1R4PT Series

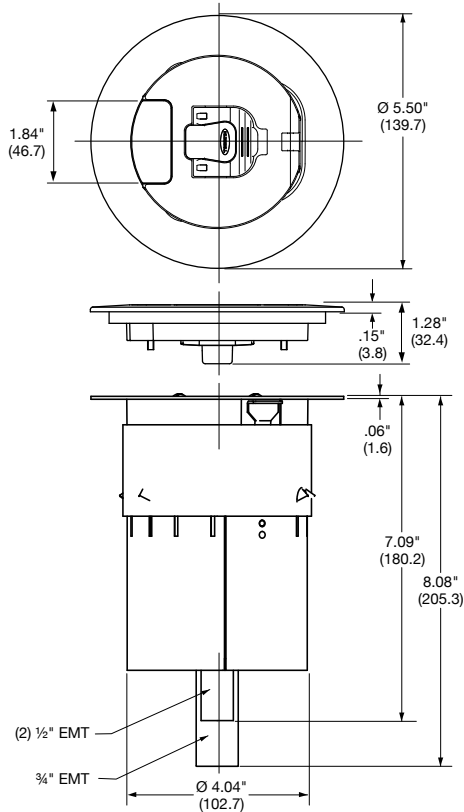

S1R4PT Series

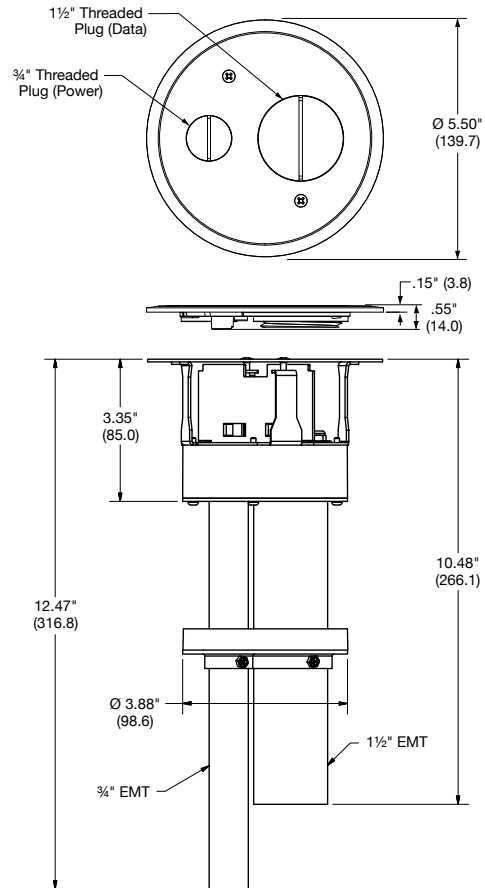

Product Information

- Plated cast aluminum covers available in brass, nickel or bronze finishes. Additionally available in brushed aluminum, black or gray powder coat.
- S1R4SPQUAD sub-plate supplied with pre-wired quad 20A receptacle. Wired with six #12 AWG solid conductors. Receptacle can be wired as dual circuit and isolated ground.
- Meets ADA requirements for accessible design, "changes in level."
- Meets UL 514A scrubwater exclusion requirements.
- COVER LOAD RATING: 1,000 lbs with 2x safety factor. Load applied through a 3 in. (76) dia. mandrel at the center of the cover. **Rated for static loads only.**

Application Data

- Mounted in 4 in. (101.6) cored concrete diameter through hole.
- Minimum floor thickness: 2 1/4 in. (57.2).
- S1R4PT Series UL Listed for fire resistance in 1-2 hour rated D900 series floors.
- S1R4PTFF & S1R4PTAV Series UL Listed for fire resistance in 1-4 hour rated D900 series floors.
- Approved for use in the City of Chicago without junction box.
- Not intended to be used in high traffic installations and not intended to support furniture.

Wire Size (AWG)	Copper Cross Sectional Area for Solid or Stranded Conductors
#24	.00032 sq. in. (.206mm ²)
#23	.00040 sq. in. (.258mm ²)
#22	.00050 sq. in. (.322mm ²)
#14	.00323 sq. in. (2.083mm ²)
#12	.00512 sq. in. (3.303mm ²)
#10	.00815 sq. in. (5.258mm ²)
#8	.01296 sq. in. (8.361mm ²)

UL Listed Wiring Capacity

	S1R4PT Series		S1R4PTFF & S1R4PTAV Series	
Fire Resistance Rating	2-Hrs. (D900)		4-Hrs. (D900)	
Max. Copper Cross Section	3/4 in. Power EMT .0408 sq. in.	1/2 in. Low Voltage EMT .008 sq. in.	3/4 in. Power EMT .072 sq. in.	1 1/2 in. Low Voltage EMT .100 sq. in.

UL Characteristics

Listing	UL File Number	ULC File Number
Outlet Box	E31999	CEYYC
Fire Resistance	R8429	R8429

S1R4PT Series use in 1, 1 1/2 or 2 hour rated unprotected reinforced floors or 1 or 2 hour rated floors employing steel floor units and concrete topping (D900 Series designs). Also as applies to S1R4PTFF & S1R4PTAV Series except for 1-4 hours. UL Spacing Restrictions - Minimum of 2 ft. on center and not more than one unit per each 65 square feet of floor area in each span.

Note: The above product data pertains to both kitted units and through-floor fittings.

When connecting conduit sweeps to through-floor fittings, ensure compliance with NEC fill tables.

Dimensions in Inches (mm)

Hubbell SystemOne Flush 4 Inch Series

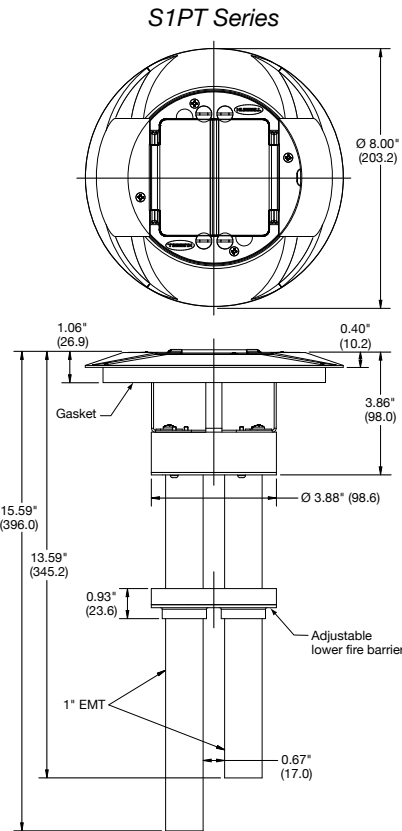
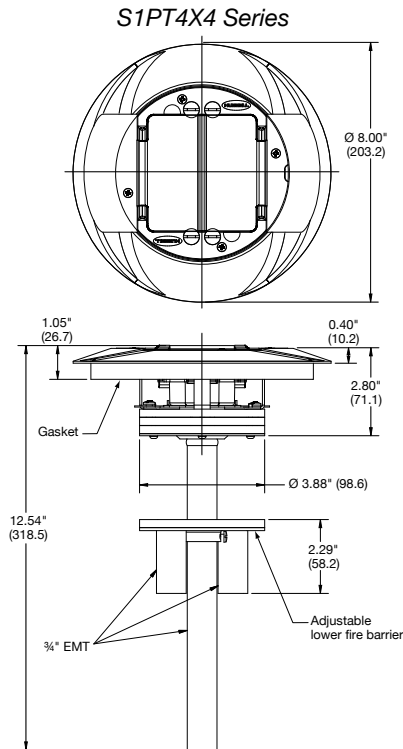

Product Information

- Powder coat cast aluminum cover and flange (color finish options: aluminum, brass, black, gray and ivory).
- Hubbell SystemOne universal cover meets ADA requirements for accessible design, "changes in level."
- S1SP4X4 sub-plate supplied with pre-wired, molded, four position 20A, 125V, black receptacle, NEMA 5-20R.
- S1SP4X4 wired with six thermally protected #14 AWG THHN stranded copper conductors, receptacle can be wired as dual-circuit and isolated ground.
- S1SP4X4 accepts four (4) Hubbell HXJ6, HXJ5E, HXJU; category 6A, 6, 5e, and USOC, and flush series jacks.
- S1SP sub-plate accepts two (2) 15A or 20A Style Line® decorator receptacles, Style Line® data frames, and/or one (1) GFCI or surge receptacle.

Application Data

- Mounted in 4 in. (101.6) cored concrete diameter through hole.
- Minimum floor thickness: 2 1/4 in. (57.2).
- UL Listed for fire resistance in 1 – 4 hour rated D900 series floors.
- Approved for use in the City of Chicago.
- Not intended to be used in high traffic installations and not intended to support furniture.

Wire Size (AWG)	Copper Cross Sectional Area for Solid or Stranded Conductors
#24	.00032 sq. in. (.206mm ²)
#23	.00040 sq. in. (.258mm ²)
#22	.00050 sq. in. (.322mm ²)
#14	.00323 sq. in. (2.083mm ²)
#12	.00512 sq. in. (3.303mm ²)
#10	.00815 sq. in. (5.258mm ²)
#8	.01296 sq. in. (8.361mm ²)

UL Listed Wiring Capacity

	S1PT4X4 Series	S1PT Series
Fire Resistance Rating	4-Hrs. (D900)	4-Hrs. (D900)
Max. Copper Cross Section	3/4 in. Power EMT .0307 sq. in.	1 in. Power EMT .0307 sq. in.
	3/4 in. Low Voltage EMT .016 sq. in.	1 in. Low Voltage EMT .024 sq. in.

UL Characteristics

Listing	UL File Number	ULC File Number
Outlet Box	E31999	CEYYC
Fire Resistance	R8429	R8429

For use in 1, 1 1/2, 2, 3, or 4 hour rated reinforced concrete floors or in 1, 1 1/2, 2, or 3 hour rated floors employing steel form units and concrete topping (D900 Series designs), or concrete floors with suspended ceilings.

Note: The above product data pertains to both one-piece units, three-piece units and through-floor fittings. When connecting conduit sweeps to through-floor fittings, ensure compliance with NEC fill tables.

Dimensions in Inches (mm)

Hubbell SystemOne Flush 4 Inch Series

S1PTAVFIT and S1PT3IM Series

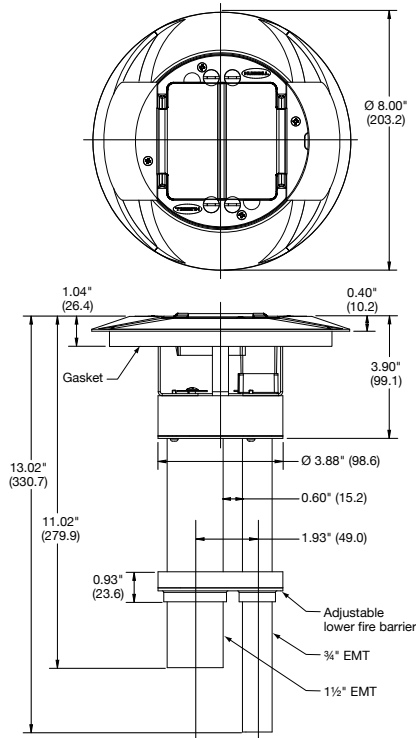

S1PTFF Series

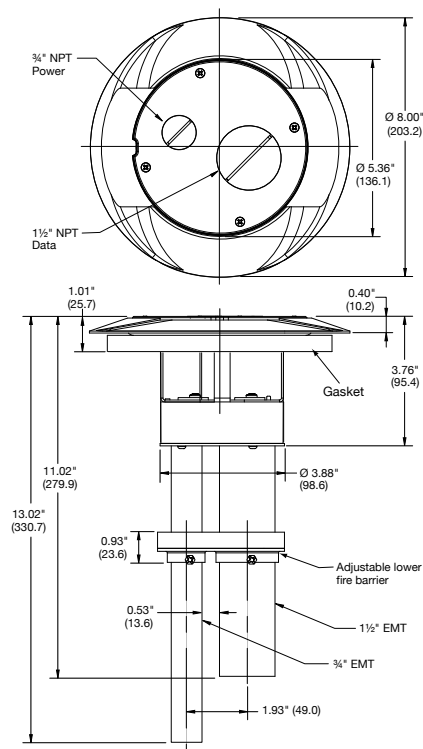

Product Information

- Powder coat cast aluminum cover and flange (color finish options: aluminum, brass, black, gray and ivory).
- Hubbell SystemOne universal cover meets ADA requirements for accessible design, "changes in level."
- S1PTFF series aluminum conduit insert cover with one (1) 3/4 in. and one (1) 1 1/2 in. die-cast threaded plugs.
- S1PTFF series furnished with one (1) 3/4 in. and one (1) 1 1/2 in. screw-in flexible metal conduit connectors.
- S1PT3IM series sub-plate supplied with pre-wired single 20A 125V black receptacle, NEMA 5-20R.
- S1PT3IM wired with three #12 AWG THHN stranded copper conductors.
- S1PT3IM sub-plate also accepts three unit recessed Hubbell iSTATION; 15-Pin VGA, RCA, S-Video, 3.5 mm stereo and XLR microphone jacks.
- Meets UL 514A scrubwater exclusion requirements.

Application Data

- Mounted in 4 in. (101.6) cored concrete diameter through hole.
- Minimum floor thickness: 2 1/4 in. (57.2).
- UL Listed for fire resistance in 1 – 4 hour rated D900 series floors.
- Approved for use in the City of Chicago.
- Not intended to be used in high traffic installations and not intended to support furniture.

Wire Size (AWG)	Copper Cross Sectional Area for Solid or Stranded Conductors
#24	.00032 sq. in. (.206mm ²)
#23	.00040 sq. in. (.258mm ²)
#22	.00050 sq. in. (.322mm ²)
#14	.00323 sq. in. (2.083mm ²)
#12	.00512 sq. in. (3.303mm ²)
#10	.00815 sq. in. (5.258mm ²)
#8	.01296 sq. in. (8.361mm ²)

UL Listed Wiring Capacity

	S1PTAVFIT and S1PT3IM Series	S1PTFF Series
Fire Resistance Rating	4-Hrs. (D900)	4-Hrs. (D900)
Max. Copper Cross Section	3/4 in. Power EMT .0307 sq. in.	3/4 in. Power EMT .072 sq. in.
	1 1/2 in. Low Voltage EMT .048 sq. in.	1 1/2 in. Low Voltage EMT .100 sq. in.

UL Characteristics

Listing	UL File Number	ULC File Number
Outlet Box	E31999	CEYYC
Fire Resistance	R8429	R8429

For use in 1, 1 1/2, 2, 3, or 4 hour rated unprotected reinforced concrete floors or in 1, 1 1/2, 2, or 3 hour rated floors employing steel form units and concrete topping (D900 Series designs), or concrete floors with suspended ceilings.

Note: The above product data pertains to both one-piece units, three-piece units and through-floor fittings. When connecting 0 conduit sweeps to through-floor fittings, ensure compliance with NEC fill tables.

Dimensions in Inches (mm)

Hubbell SystemOne Flush 4 Inch Series

S1CFC and S1TFC Series

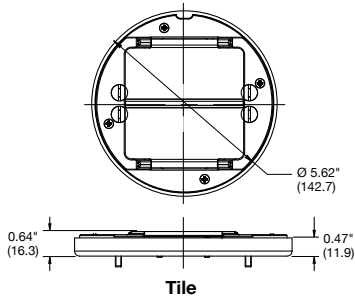
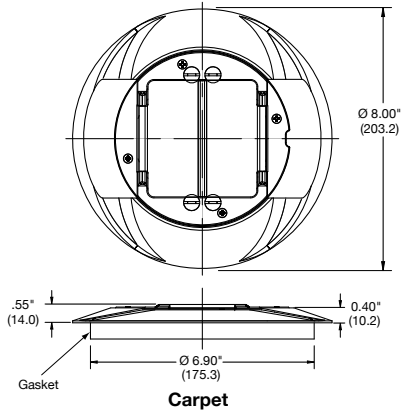

S1SPFF and S1SPFFT Series

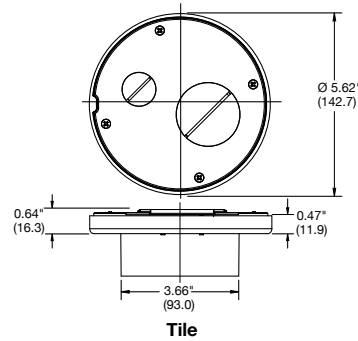
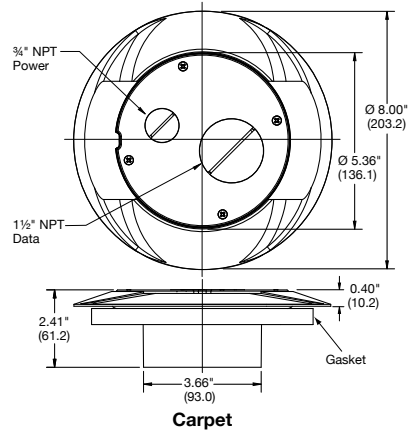

Product Information

- Powder coat cast aluminum cover and flange (color finish options: aluminum, brass, black, gray and ivory).
- Hubbell SystemOne universal cover meets ADA requirements for accessible design, "changes in level."
- S1SPFF and S1SPFFT series aluminum conduit insert cover with one (1) 3/4 in. and one (1) 1 1/2 in. die-cast threaded plugs.
- S1SPFF and S1SPFFT series furnished with one (1) 3/4 in. and one (1) 1 1/2 in. screw-in flexible metal conduit connectors.
- Meets UL 514A scrubwater exclusion requirements.

Hubbell 3 Inch Series

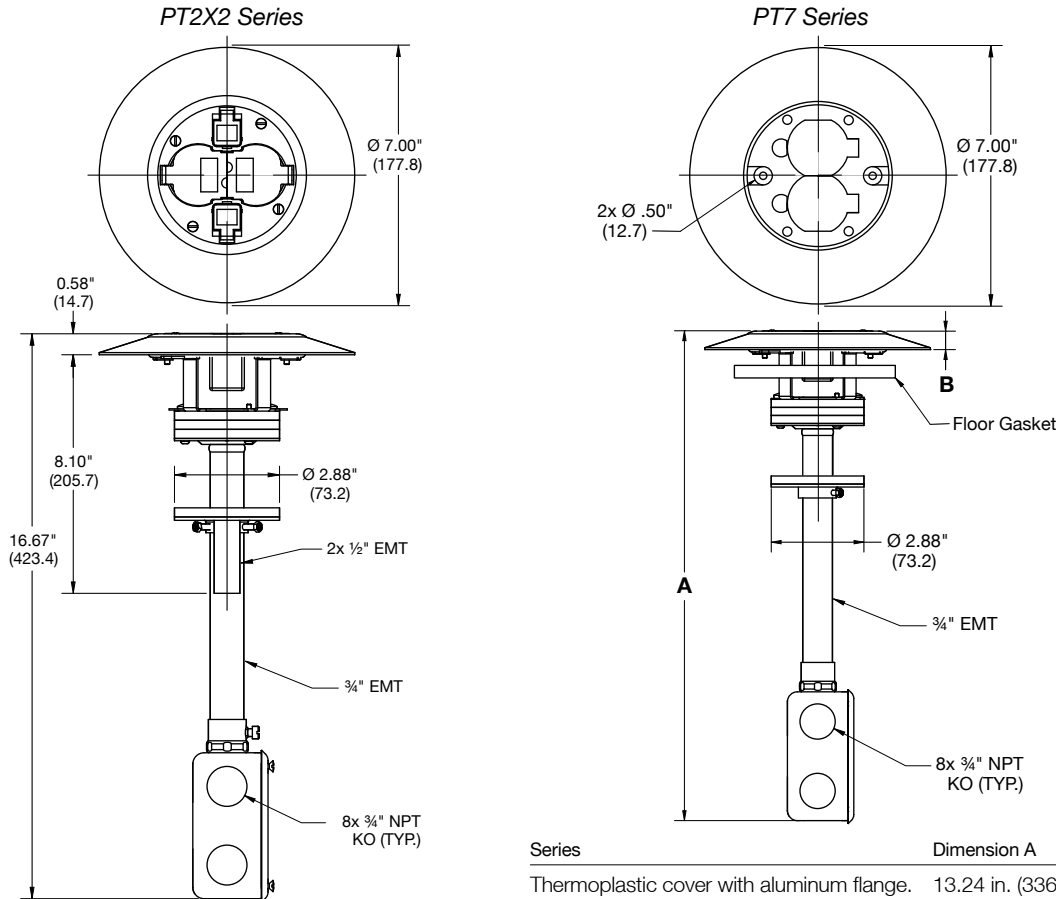

Series	Dimension A	Dimension B
Thermoplastic cover with aluminum flange.	13.24 in. (336.2)	.51 in. (13.0)
Brass cover and flange.	13.20 in. (335.2)	.49 in. (12.4)

Product Information

- PT7 series supplied with flush thermoplastic cover with matching painted aluminum flange (black, brown, gray, ivory) or solid brass cover and flange.
- PT2X2 series supplied with Hubbell pre-wired HBL2162BK; black Styte Line® or IG2162 (isolated ground) receptacle, NEMA 5-20R, 20A, 125V.
- PT2X2 series supplied with two (2) Hubbell HXJ6BK black jacks; category 6, UL Listed, 110 type contacts.
- PT7 series supplied with Hubbell pre-wired HBL5352 or IG5362 (isolated ground) series receptacle, NEMA 5-20R, 20A, 125V.
- PT7 series supplied with two (2) 1/2 in. low voltage feed through holes. Two (2) feed through bushings supplied (cover will not accept data jacks).
- Wired with three (3) #12 AWG THHN stranded copper conductors.
- Supplied with 13.0 cu. in. junction box having eight (8) 3/4 in. knockouts.

Application Data

- Mounted in 3 in. (76.2) cored concrete diameter through hole.
- Floor thickness range: 2 1/4 to 7 in. (57.2 to 177.8).
- UL Listed for fire resistance in 1 – 4 hour rated floors.
- Approved for use in the City of Chicago (PT2X2 series).
- Not intended to be used in high traffic installations and not intended to support furniture.

Wire Size (AWG)	Copper Cross Sectional Area for Solid or Stranded Conductors
#24	.00032 sq. in. (.206mm ²)
#23	.00040 sq. in. (.258mm ²)
#22	.00050 sq. in. (.322mm ²)
#14	.00323 sq. in. (2.083mm ²)
#12	.00512 sq. in. (3.303mm ²)
#10	.00815 sq. in. (5.258mm ²)
#8	.01296 sq. in. (8.361mm ²)

UL Listed Wiring Capacity

	PT2X2 Series		PT7 Series	
Fire Resistance Rating	4-Hrs. (D900)		4-Hrs. (D900)	
Max. Copper Cross Section	3/4 in. Power EMT .0155 sq. in.	1/2 in. Data EMT .0026 sq. in.	3/4 in. Power EMT .0155 sq. in.	Low Voltage EMT .0250 sq. in.

UL Characteristics

Listing	UL File Number	ULC File Number
Outlet Box	E31999	CEYYC
Fire Resistance	R8429	R8429

For use in 1, 1 1/2, 2, 3 or 4 hour rated unprotected reinforced floors or in 1, 2, or 3 hour rated floors employing steel floor units and concrete topping (D900 Series designs).
UL Spacing Restrictions - Minimum of 2 ft. on center and not more than one unit per each 65 square feet of floor area in each span.

Note: When connecting conduit sweeps to through-floor fittings, ensure compliance with NEC fill tables.

The above product data pertains to both one-piece units and through-floor fittings.

Dimensions in Inches (mm)

Hubbell 3 Inch Series

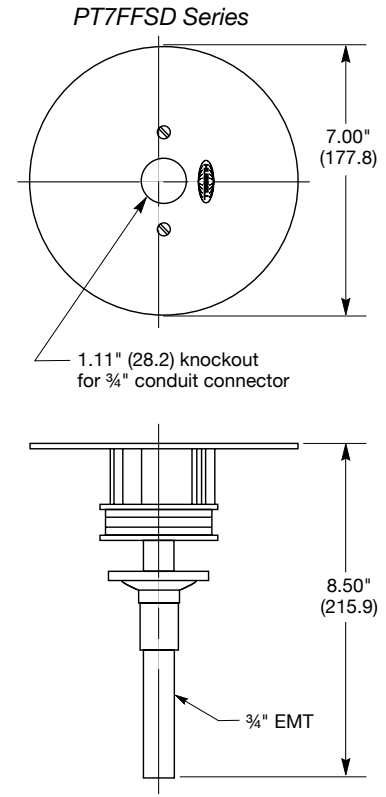
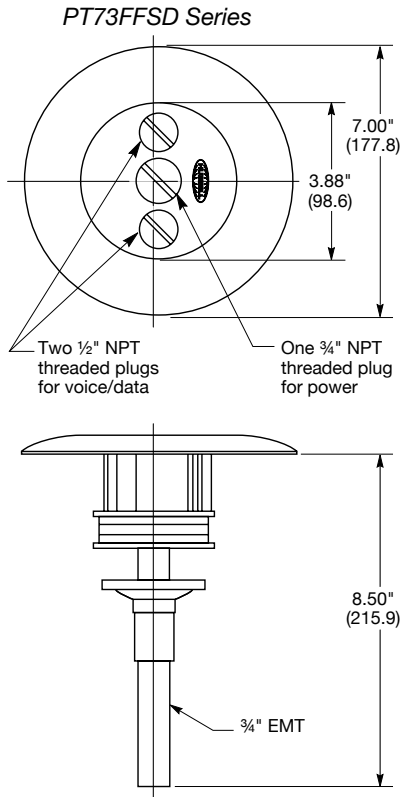
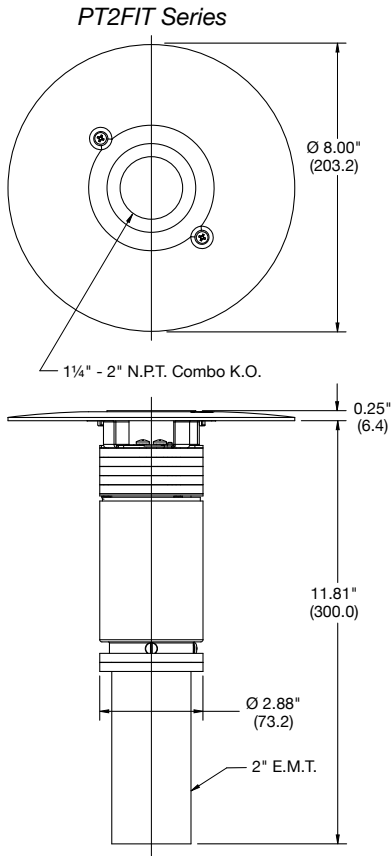

Product Information

PT2FIT series

- Flush aluminum service fitting with epoxy paint finish (gray, black and brass finish).
- Aluminum conduit cover with 2.47 in. (62.7) and 1.74 in. (44.2) combination knockouts to accept a 2 in. or 1 1/4 in. NPT flexible metal conduit connector.

PT73FFSD series

- Flush painted aluminum service fitting and carpet flange (color finish options: black, gray and ivory).
- Aluminum conduit insert cover with one (1) 3/4 in. and two (2) 1/2 in. die-cast threaded plugs.
- Supplied with one (1) 3/4 in. and two (2) 1/2 in. screw-in flexible metal conduit connectors.

PT7FFSD series

- Flush aluminum service fitting with epoxy paint finish (color finish options: gray, ivory and brass finish).
- Aluminum conduit cover with 1.11 in. (28.2) knockout to accept a 3/4 in. NPT flexible metal conduit connector.

Application Data

- Mounted in 3 in. (76.2) cored concrete diameter through hole.
- Floor thickness range: 2 1/4 in. to 7 in. (57.2 to 177.8).
- PT2FIT series has single-service, power or data.
- UL Listed for fire resistance in 1 - 2 hour (PT2FIT series) rated floors.
- UL Listed for fire resistance in 1 - 4 hour (PT73FFSD and PT7FFSD series) rated floors.
- Approved for use in the City of Chicago (PT2FIT series).
- Not intended to be used in high traffic installations and not intended to support furniture.

Wire Size (AWG)	Copper Cross Sectional Area for Solid or Stranded Conductors
#24	.00032 sq. in. (.206mm ²)
#23	.00040 sq. in. (.258mm ²)
#22	.00050 sq. in. (.322mm ²)
#14	.00323 sq. in. (2.083mm ²)
#12	.00512 sq. in. (3.303mm ²)
#10	.00815 sq. in. (5.258mm ²)
# 8	.01296 sq. in. (8.361mm ²)

UL Listed Wiring Capacity

	PT2FIT Series	PT73FFSD Series	PT7FFSD Series
Fire Resistance Rating	2-Hrs. (D900)	4-Hrs. (D900)	4-Hrs. (D900)
Max. Copper Cross Section	2 in. EMT .0922 sq. in.	3/4 in. EMT 1/2 in. Feed Through .0470 sq. in. .0250 sq. in.	3/4 in. EMT .0500 sq. in.

UL Characteristics

Listing	UL File Number	ULC File Number
Outlet Box	E31999	CEYYC
Fire Resistance	R8429	R8429

For use in 1, 1 1/2, or 2 hour rated unprotected reinforced floors or in 1 or 2 hour rated floors employing steel floor units and concrete topping (D900 Series designs).
UL Spacing Restrictions - Minimum of 2 ft. on center and not more than one unit per each 65 square feet of floor area in each span.

Note: The above product data pertains to both one-piece units and through-floor fittings.

When connecting conduit sweeps to through-floor fittings, ensure compliance with NEC fill tables.

Dimensions in Inches (mm)

Pedestal FRPT Series

Pedestal Fitting Series

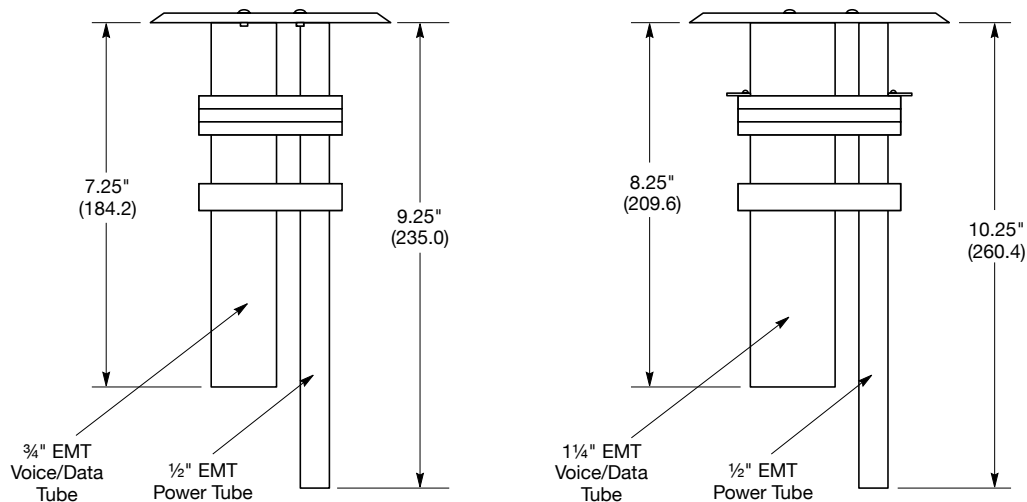

Applications

	PT27A	PT7XC
Mounting	2 in. (50.8) diameter hole.	3 in. (76.2) diameter hole.
Floor Thickness Range	2 1/4 in. to 7 in. (57.2 to 177.8)	2 1/4 in. to 7 in. (57.2 to 177.8)
Fire Rating	For use in 1, 1 1/2, 2, 3 or 4 hour rated unprotected reinforced concrete floors or in 1, 2 or 3 hour rated employing steel floor units and concrete topping (D900 series design).	For use in 1, 1 1/2, 2, 3 or 4 hour rated unprotected reinforced concrete floors or in 1, 2 or 3 hour rated floors employing steel floor units and concrete topping (D900 series design).
Service Pedestal Options	FR280, FR480, FR680 Series.	FR480 and FR680 Series.

Note: Not intended to be used in high traffic installations and not intended to support furniture.

UL Listed Wiring Capacity

Power Wiring Capacity	1/2 in. EMT power tube Handles: Up to ten #12 AWG type THHN wires, or Up to six #12 AWG and two #10 AWG type THHN wires.	1/2 in. EMT power tube Handles: Up to ten #12 AWG type THHN wires, or Up to six #12 AWG and two #10 AWG type THHN wires.
Voice/Data Wiring Capacity	3/4 in. EMT low-voltage tube Handles: Up to two 25 pair tel./data cables (100 #22 AWG tel./data conductors), or Up to two IBM Type 2 data cables.	1 1/4 in. EMT low-voltage tube Handles: Up to four 25 pair tel./data cables (200 #22 AWG tel./data conductors), or Up to five IBM Type 2 data cables and four 8-conductor tel./data cables.

Total Allowable Copper Cross-Sectional Area	1/2 in. Power EMT .0461 sq. in.	3/4 in. Low Voltage EMT .0500 sq. in.	1 1/4 in. Power EMT .0461 sq. in.	1 1/2 in. Low Voltage EMT .1000 sq. in.
---	------------------------------------	--	--------------------------------------	--

When conductors larger than #22 AWG are used, the total cross-sectional area of the copper conductors shall not exceed the total cross-sectional area of the #22 AWG conductors permitted in the low voltage compartment.

Note: When connecting conduit sweeps to through-floor fittings, ensure compliance with NEC fill tables.

UL Characteristics

Listing	UL File Number	UL File Number
Outlet Box	E31999	E31999
Fire Resistance	R8429	R8429

For use in 1, 1 1/2, 2, 3, or 4 hour rated unprotected reinforced concrete floors or in 1, 2 or 3 hour rated floors employing steel floor units and concrete topping (D900 Series designs).

UL Spacing Restrictions - Minimum of 2 ft. O.C. and not more than one unit per each 65 sq. ft. of floor area in each span.

Chicago Approved

Catalog Number	City of Chicago File Number
PT27A, PT7XC	5587E

These through-floor fittings are approved for the City of Chicago. Installation requires a plenum-rated 1900 series box or a handy box with gasketed cover. These boxes are to be affixed with compression gland-type connectors.

Dimensions in Inches (mm)

Pedestal FRPT Series

Painted and Brushed Aluminum Series

Dimensions

2-Gang – FR280 Series (Use with PT27A Only)

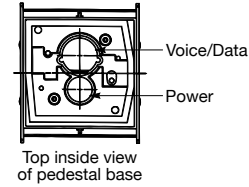
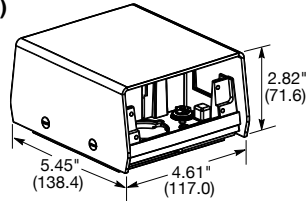

Total Cubic Inch Capacity (Single-Service) 39.00 in. (638.8cm³)

Cubic Inch Capacity Power 19.5 in. (319.4cm³)

(when divided for multi-service) Voice/Data 19.5 in. (319.4cm³)

Service Pedestal Construction Heavy gauge galvanized steel frame with aluminum housing and face plates.

Pedestal Finish Textured black or gray epoxy paint.

4-Gang – FR480 (Use with PT27A or PT7XC)

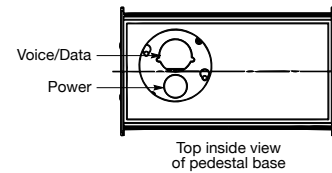
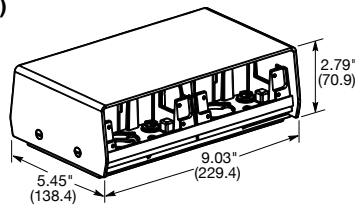

Total Cubic Inch Capacity (Single-Service) 78.00 in. (1277.6cm³)

Cubic Inch Capacity Power 39.00 in. (638.8cm³)

(when divided for multi-service) Voice/Data 39.00 in. (638.8cm³)

Service Pedestal Construction Heavy gauge galvanized steel frame with aluminum housing and face plates.

Pedestal Finish Textured black or gray epoxy paint.

6-Gang – FR680 (Use with PT27A or PT7XC)

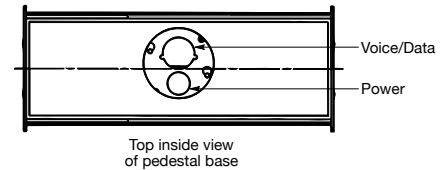
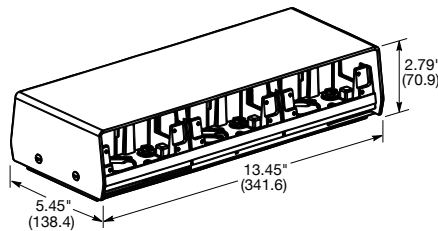

Total Cubic Inch Capacity (Single-Service) 117.00 in. (1916.4cm³)

Cubic Inch Capacity Power 58.5 in. (958.2cm³)

(when divided for multi-service) Voice/Data 58.5 in. (958.2cm³)

Service Pedestal Construction Heavy gauge galvanized steel frame with aluminum housing and face plates.

Pedestal Finish Textured black or gray epoxy paint.

2-Gang – FR80AL (Use with PT7XC Only)

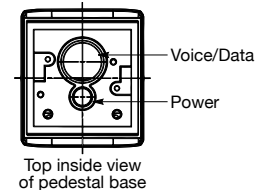
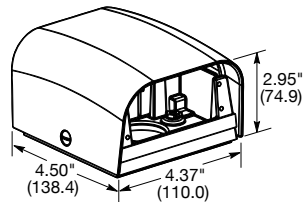

Total Cubic Inch Capacity (single service) 33.00 in. (540.9 cu cm³)

Cubic Inch Capacity Power 8.80 in. (144.2cm³)

(when divided for multi-service) Voice/Data 26.70 in. (437.6cm³)

Service Pedestal Construction Heavy gauge aluminum frame with satin anodized aluminum housing with 302/304 stainless steel face plates.

Pedestal Finish Brushed.

Dimensions in Inches (mm)

SECTION Q

Table of Contents



Powered Seating Boxes



USB Charging Receptacles



Tri-Power Countertop Pop-Up Receptacle



Product	Page
Powered Seating Boxes	Q-3
USB Charging Receptacles	
Type-C, Type A&C and Type A	Q-4
SNAPConnect® USB Charger	Q-5
4 Port and 2 Port, Switch Combo Outlets	Q-5
2X2 USB Work Surface Pop-Up Boxes	Q-5
PlugTrak® Raceway with USB Charger Outlets	Q-5
Surface Mount Countertop Receptacles	Q-6

Features and Benefits

Powered Seating Boxes

Hubbell's On-the-Go Powered Seating Boxes fulfill customers' need for power accessibility. As the use of electronic devices has increased, the demand for charging has followed. Powered Seating Boxes provide an easy means of charging user's devices while meeting custom space requirements. Seating boxes can easily be attached to waiting area seating arrangements, conference tables, lecture halls, anywhere convenient power is needed.

HUBBELL ON-the-GO CHARGING

Convenient Charging Stations



Housing Design

- Rugged design features satin aluminum construction body with impact-resistant polycarbonate end caps
- Make any furniture or seating area into a convenient charging station
- Available with up to 4 boxes per unit



Powered Seating Boxes

- Parallel module wiring keeping individual seating boxes from losing power up and downstream
- Push to reset circuit breaker—trip electronically and reset manually



Charging Power

- Fast charging speeds delivering up to 5 amps of charging power
- Green power LED provides visual indication of power to the devices



Installation

- Security Torx-screw minimizes the potential for customers to open or tamper with units
- Hardwired permanently connected power and interconnecting cords
- Available with heavy-gauge durable powder coated steel mounting bracket



USB ports

- Smooth insertion tamper-resistant devices provide an extra level of safety to your customers
- Overcurrent protection—12 amp string and 5 amp individual module protection



Configurations

- Powered seating boxes are available in convenient bracketed configurations that easily attach to any flat surface
- Unbracketed configurations are also available



SP15USB1

Powered Seating Boxes

Description	Cord Length*	Boxes per Unit*	Without Mounting Bracket	With Mounting Bracket
Powered Seating Box with dual USB ports. (1) USB Type-A port: 5A,5V, and (1) Power Delivery USB Type-C port: 55W	10 ft power and 5 ft connecting cords	1	SP15USB1	SP15USB1B
		2	SP15USB2	SP15USB2B
		3	SP15USB3	SP15USB3B
		4	SP15USB4	SP15USB4B

Note: *Special constructions are available with up to 7 boxes and up to 25 ft. of power cord. Contact your local Hubbell representative for more information.
Options for USB Type-C and hospital grade receptacles are also available

Specifications

- UL, cULus
- Meets construction and safety testing standards for UL962A Furniture Power Distribution Units

Dimensions Inches (mm)

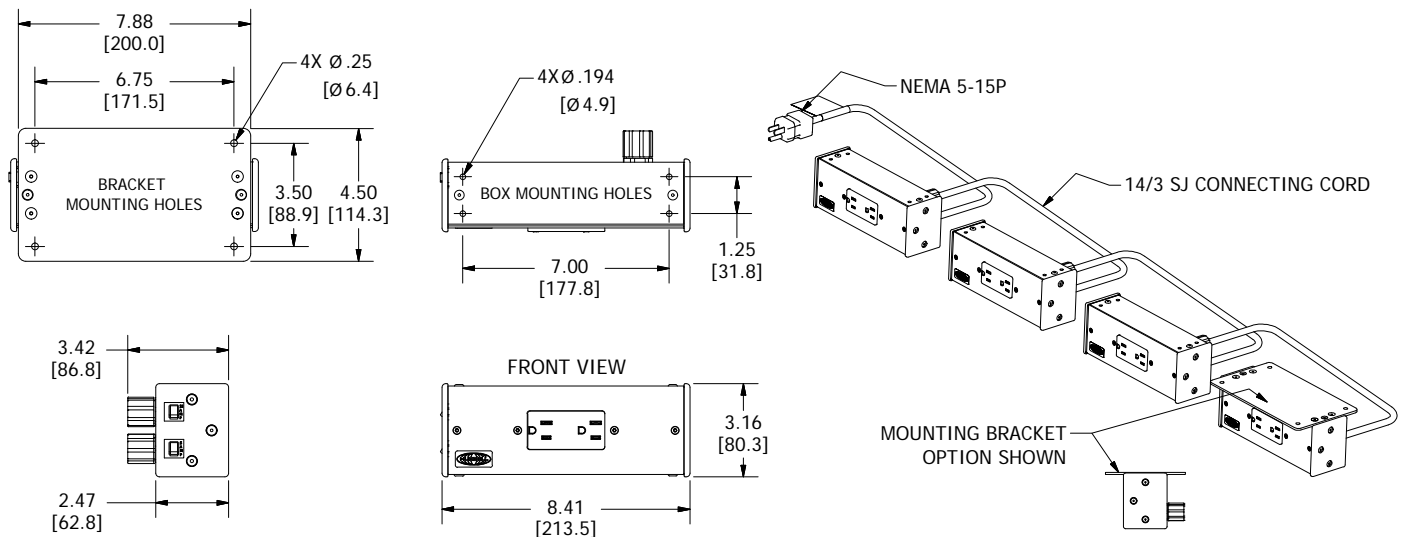

Dimensions in Inches (mm)



USB Charging Receptacles Type-C • Type A&C • Type A

Hubbell USB Chargers are available in the new Type-C port, a combination unit with Type A&C, and the legacy Type A. All with the increase in power to a 5 Amp 5 Volt USB port adds capacity so that there is always ample current to support multiple device charging. Portable mobile manufacturers are using the faster Type-C ports. More phones, tablets and other electronic devices are expected to use this new standard.

- Compliant with USB BC1.2 battery charging and 3.0 power delivery
- Compatible with USB 2.0, 3.0 and 3.1 devices
- USB Type-C port is legacy USB Type A compatible (adapter cord - not included)
- Heavy duty stainless steel USB ports; rated for 10,000 cord insertions and removals
- Patented Hubbell Tamper-Resistant technology uses cam action shutters
- Designed for commercial, industrial and home use
- Weather resistant receptacles meets Section 406.9 of NEC®
- Weather resistant receptacles available in Type A&C USB ports only



Weather Resistant USB Charger Duplex Receptacles

Description	Color	15A 125V	20A 125V
Type A&C USB Charger Receptacle, One Type A and one Type-C port configurations, high power 5 Amp, 5 Volt USB output, Tamper-Resistant Commercial Grade USB ports rated 10,000 cycles.	Black	USB15AC5BKWR	USB20AC5BKWR
	Brown	USB15AC5WR	USB20AC5WR
	Gray	USB15AC5GYWR	USB20AC5GYWR
	Ivory	USB15AC5IWR	USB20AC5IWR
	Light Almond	USB15AC5LAWR	USB20AC5LAWR
	White	USB15AC5WWR	USB20AC5WWR

Note: Outdoor circuits should be GFCI protected per national and local electric codes.

USB Charger Duplex Receptacles Type-C and Type A-C

Description	Color	15A 125V	20A 125V
Hospital Grade USB Charger Receptacle, two Type-C port configurations, (1) USB-C Power Delivery port with up to 55W output and (1) USB-C Convenience port 1.5A, 5V output, Tamper-Resistant duplex receptacle, USB ports rated 10,000 cycles.	Black	USB8200CPDBK	USB8300CPDBK
	Brown	USB8200CPD	USB8300CPD
	Gray	USB8200CPDGY	USB8300CPDGY
	Ivory	USB8200CPDI	USB8300CPDI
	Light Almond	USB8200CPDLA	USB8300CPDLA
	Red	USB8200CPDR	USB8300CPDR
Hospital Grade USB Charger Receptacle, (1) USB-C Power Delivery port with up to 55W of output and (1) USB-Type A convenience port 1.5A, 5V output, Tamper-Resistant duplex receptacle, USB ports rated 10,000 cycles.	Black	USB8200ACPDBK	USB8300ACPDBK
	Brown	USB8200ACPD	USB8300ACPD
	Gray	USB8200ACPDGY	USB8300ACPDGY
	Ivory	USB8200ACPDI	USB8300ACPDI
	Light Almond	USB8200ACPDLA	USB8300ACPDLA
	Red	USB8200ACPDR	USB8300ACPDR
Commercial Grade USB Charger Receptacle, two Type-C port configurations, (1) USB-C Power Delivery port with up to 55W output and (1) USB-C Convenience port 1.5A, 5V output, Tamper-Resistant duplex receptacle, USB ports rated 10,000 cycles.	Black	USB15CPDBK	USB20CPDBK
	Brown	USB15CPD	USB20CPD
	Gray	USB15CPDGY	USB20CPDGY
	Ivory	USB15CPDI	USB20CPDI
	Light Almond	USB15CPDLA	USB20CPDLA
	White	USB15CPDW	USB20CPDW
Commercial Grade USB Charger Receptacle, (1) USB-C Power Delivery port with up to 55W of output and (1) USB-Type A convenience port 1.5A, 5V output, Tamper-Resistant duplex receptacle, USB ports rated 10,000 cycles.	Black	USB15ACPDBK	USB20ACPDBK
	Brown	USB15ACPD	USB20ACPD
	Gray	USB15ACPDGY	USB20ACPDGY
	Ivory	USB15ACPDI	USB20ACPDI
	Light Almond	USB15ACPDLA	USB20ACPDLA
	White	USB15ACPDW	USB20ACPDW

Note: See page Tech-10 for Tamper-Resistant description. See section N for wallplates.

NEC® is a registered trademark of the National Fire Protection Association (NFPA).

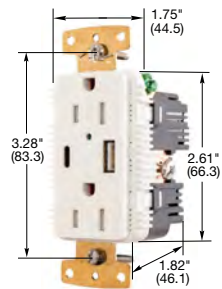

USB15AC5WWR

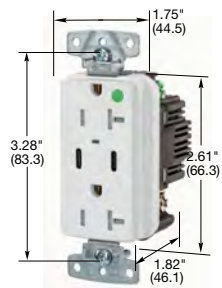

USB8300CPDW

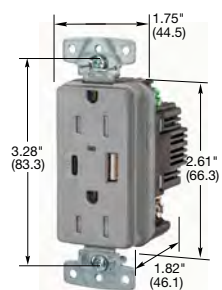

USB15ACPDGY

Dimensions in Inches (mm)

SNAPConnect® USB Charger Duplex Receptacles



Description	Color	15A 125V AC	20A 125V AC
Hospital Grade SNAPConnect USB Charger, Tamper-Resistant Style Line® decorator duplex receptacle, 15 or 20 Amp, 125 Volt AC with one type A & one type-C USB port, 3 Amp up to 9 Volt USB output.	Black	SNAP8200UACBK	SNAP8300UACBK
	Brown	SNAP8200UAC	SNAP8300UAC
	Gray	SNAP8200UACGY	SNAP8300UACGY
	Ivory	SNAP8200UACI	SNAP8300UACI
	Light Almond	SNAP8200UACLA	SNAP8300UACLA
	Red	SNAP8200UACR	SNAP8300UACR
	White	SNAP8200UACW	SNAP8300UACW
SNAPConnect USB Charger, Tamper-Resistant Style Line® decorator duplex receptacle, 15 or 20 Amp, 125 Volt AC with one type A & one type-C USB port, 3 Amp up to 9 Volt USB output.	Black	SNAP15UACBK	SNAP20UACBK
	Brown	SNAP15UAC	SNAP20UAC
	Gray	SNAP15UACGY	SNAP20UACGY
	Ivory	SNAP15UACI	SNAP20UACI
	Light Almond	SNAP15UACLA	SNAP20UACLA
	White	SNAP15UACW	SNAP20UACW
Clear right angle terminal with 6 inch leads #12 AWG THHN/THWN-2; Polycarbonate housing material.	Solid	SNAP1RNA	SNAP1RNA
	Stranded	SNAP2RNA	SNAP2RNA

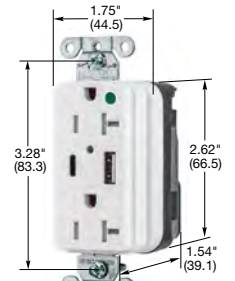

SNAP8300UACW

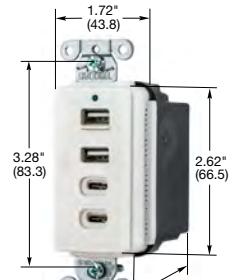

USB4W

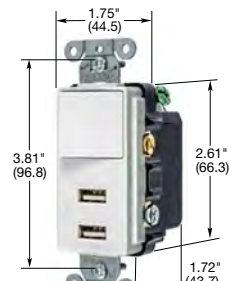

USB102W

4 Port USB Charger Outlets



Description	Color	Catalog Number
USB Charger Outlets, 4 USB ports, two Type A & two Type-C ports, 5 Amp up to 9 Volt DC, Style Line® decorator.	Black	USB4ACBK
	Brown	USB4AC
	Gray	USB4ACGY
	Ivory	USB4ACI
	Light Almond	USB4ACLA
	White	USB4ACW

Switch Combo Outlets



Description	Color	Catalog Number
Switch Combo Outlet, two USB type 2.0 ports, 2.1 Amp, 5 Volt DC, Style Line® decorator.	Black	USB102BK
	Brown	USB102
	Gray	USB102GY
	Ivory	USB102I
	Light Almond	USB102LA
	White	USB102W

2X2 USB Work Surface Pop-Up Boxes, NEMA 5-15 Duplex Receptacle

Description	Finish	Catalog Number
15A 125V duplex receptacle with (2) USB charging ports, 5 foot long cord with NEMA 5-15 plug	Brushed Aluminum	WSBUSB2X2AC5ALU
	Black Powder Paint	WSBUSB2X2AC5BLK
	White Powder Paint	WSBUSB2X2AC5WHT

Note: UL File Number E327832



WSBUSB2X2AC5ALU

PlugTrak® Raceway with USB Charger Outlets

USB type 2.0 ports, 2.4 Amp, 5 Volt DC, 15 Amp, 125 Volt AC receptacles.

Material	Length	Ends	# of USB Ports	# of Single Receptacles	Color	Catalog Number
Steel	3 ft.	6 in. leads	2	2	Ivory	HBL20GB312UIV
Steel	6 ft.	6 in. leads	4	4	Ivory	HBL20GB612UIV
Aluminium	3 ft.	6 in. leads	2	2	Aluminum	HBLALU20GB312U
Aluminium	6 ft.	6 in. leads	4	4	Aluminum	HBLALU20GB612U
Non-metallic	6 ft.	6 in. leads	4	8	Office White	PT156112U*
Portable - Plug in						
Steel	40 in.	6 ft. cord and plug	2	4	Ivory	HBL20C215UIV
Non-metallic	36 in.	6 ft. cord and plug	2	4	Office White	PT153112UP*

Note: *For additional colors add "BK" for Black or "W" for white.

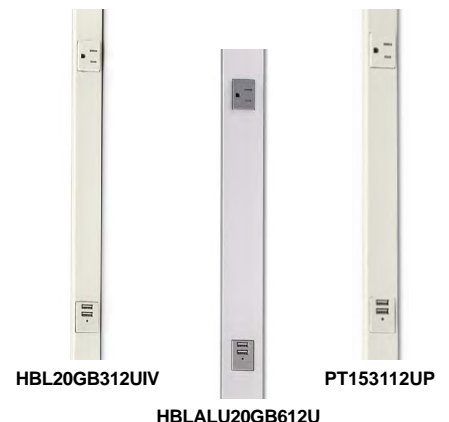

HBL20GB312UIV

HBLALU20GB612U

PT153112UP

Dimensions in Inches (mm)

Charging Solutions

Surface Mount Countertop Receptacles

Hubbell's Pop-Up Receptacles for countertops provide a power source ideal for residential and commercial locations. Hubbell is the first to market a countertop receptacle listed under UL498 Section 146 Spill Test. Silicon gaskets built into the receptacle creates a water-resistant seal up to a half gallon of liquid.

Because Spills Happen

- Spill water tested
- Self sealing silicon gaskets at the face
- Watertight interior

Install With Ease

- Permanent installation ready for hardwire
- Accepts non-metallic sheathed cable and/or metal conduit
- Suitable for 20 Amp circuit, end of line
- Push-down to pop-up function is rated for a minimum of 10,000 cycles
- Tower design ensures secure fitment

User Friendly

- Type A and C USB ports
- LED Light indicates power to the ports

Certified

- UL Listed for countertop installation (UL 498 Section 146-151)
- Meets NEC 406.5 (E) for countertop surfaces. Plug-in products are non-compliant

Tops in Black, White, and Grey

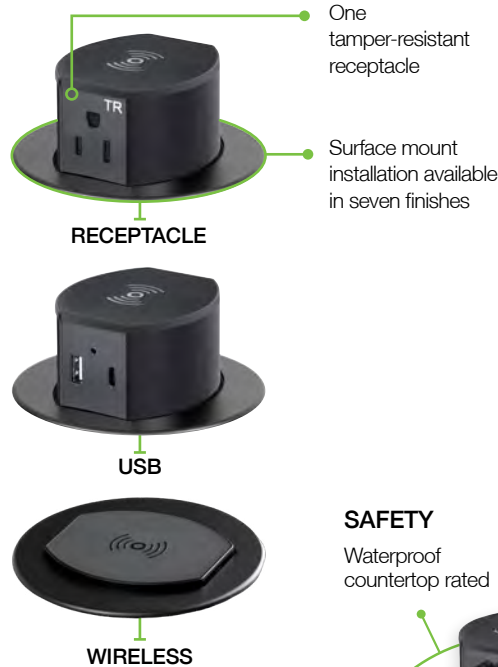

SAFETY

Waterproof countertop rated

COMPACT

Small Profile & Pop-Up Receptacles for countertops

PERFORMANCE

Able to charge devices fast and safe

COMPATIBILITY

Compatible with most phones

CONVENIENCE

Charge multiple devices at the same time

QI CERTIFIED

Has passed rigorous independent lab tests

ACCESSIBILITY

Multiple ways to charge devices: A/C power, USB ports and Wireless

Surface Mount Countertop Receptacles

Flange Color	Top Color	15 AMP	20 AMP
Nickel	Black, White, & Gray	RCT600NI	RCT620NI
Aluminum	Black, White, & Gray	RCT600ALU	RCT620ALU
Black	Black	RCT600BK	RCT620BK
White	White	RCT600W	RCT620W
Chrome	Black, White, Gray	RCT600CH	RCT620CH
Bronze	Black, White, Gray	RCT600BZE	RCT620BZE
Brass	Black, White, Gray	RCT600BR	RCT620BR

SECTION R

Table of Contents



Two Duplex Receptacles
or Blank Pole



Isolated Ground with and
without Surge Suppression



GFCI Self Test
Duplex Receptacles



Product	Page
Products at a Glance	R-2
Features and Benefits	R-3
Aluminum Series Offering	R-4
Custom Pole Configurations	R-5
Division 16 Specifications	R-6

Aluminum Service Poles

Products at a Glance



Two Duplex Receptacles or Blank Pole

- (2) 20A 125V Style Line® duplex receptacles; one circuit
- Available in three standard lengths: 10' 2", 12' 2" and 15' 2" to accommodate a variety of applications
- Available in five attractive durable paint colors: gray, ivory, black, white and office white painted or clear anodized aluminum finish to suit every need



Isolated Ground with and without Surge Suppression

- (1) Orange isolated ground 20A 125V Style Line® duplex receptacle; (1) 20A 125V Style Line® duplex receptacle; two circuits
- (2) Orange isolated ground 20A 125V Style Line® duplex receptacles; (1) isolated ground surge suppression 20A 125V duplex receptacle; one circuit



GFCI Self Test and Duplex Receptacles

- (1) 20A 125V GFCI Self Test duplex receptacle with (2) ground fault protected 20A 125V Style Line® duplex receptacles; one circuit



Adjustable T-Bar and Trim Kit

- Adjustable T-bar for mounting poles in the center of the ceiling tiles
- All service poles include ceiling trim plates, replacements also available in office white

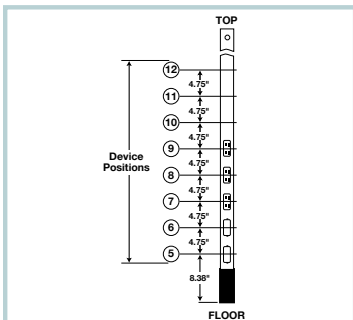

Custom Pole Configurations

- Create your own custom service poles using the chart on page R-5
- For configurations that require additional customization, please consult Hubbell Technical Services



Aluminum Service Poles

Features and Benefits

Aluminum Series Offering

Hubbell offers a line of attractive and durable Aluminum Service Poles which distribute wiring from above the ceiling to workstations below.

They are offered in standard lengths of 10' 2", 12' 2" and 15' 2" with a variety of electrical wiring devices. Poles with three service capability have a divider to separate power and low voltage wiring.

Available in varying lengths and colors, custom options maximize space and allow workstations, retail checkout areas, collaboration areas, digital signage, vending machines, appliances and kiosks to be positioned away from the wall.

- Factory ordered custom pole lengths and configurations available for special applications
- UL listed



Colors Available

- Available in five attractive durable paint colors: gray, ivory, black, white and office white painted and clear anodized aluminum finishes to suit every need

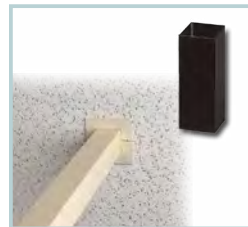

Accessories

- Each pole include a ceiling trim mounting plate and bottom scuff boot



Black



Ivory



Gray



Office White



White



Clear Anodized
Aluminum

Aluminum Service Poles



Aluminum Series Offering



HBLPP10AI



HBLPP10IGA

HBLPP10SAI



HBLPP10GFW



ATB



PPTRIM1

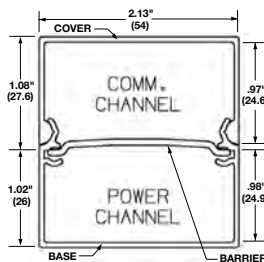

Service Pole Cross Section

Dimensions in Inches (mm)

Three Service Aluminum Service Poles

Description	Color	10' 2" (3.10m)	12' 2" (3.71m)	15' 2" (4.62m)
(2) 20A 125V Style Line® duplex receptacles; one circuit	Black	HBLPP10BK	HBLPP12BK	HBLPP15BK
	Gray	HBLPP10A	HBLPP12A	HBLPP15A
	Ivory	HBLPP10AI	HBLPP12AI	HBLPP15AI
	Office White	HBLPP10OW	HBLPP12OW	HBLPP15OW
	White	HBLPP10W	HBLPP12W	HBLPP15W
	Clear Anodized Aluminum	HBLPP10AAL	HBLPP12AAL	HBLPP15AAL
(1) Orange isolated ground 20A 125V Style Line® duplex receptacle; (1) 20A 125V Style Line® duplex receptacle; two circuits	Black	HBLPP10IGBK	—	—
	Gray	HBLPP10IGA	—	—
	Ivory	HBLPP10IGAI	—	—
	Office White	HBLPP10IGOW	—	—
	White	HBLPP10IGW	—	—
	Clear Anodized Aluminum	HBLPP10IGAL	—	—
(2) Orange isolated ground 20A 125V Style Line® duplex receptacles; (1) isolated ground surge suppression 20A 125V duplex receptacle; one circuit	Black	HBLPP10SBK	—	—
	Gray	HBLPP10SA	—	—
	Ivory	HBLPP10SAI	—	—
	Office White	HBLPP10SOW	—	—
	White	HBLPP10SW	—	—
	Clear Anodized Aluminum	HBLPP10SAL	—	—
(1) 20A 125V GFCI Self Test duplex receptacle with (2) ground fault protected 20A 125V Style Line® duplex receptacles; one circuit	Black	HBLPP10GFBK	HBLPP12GFBK	HBLPP15GFBK
	Gray	HBLPP10GF	HBLPP12GF	HBLPP15GF
	Ivory	HBLPP10GFI	HBLPP12GFI	HBLPP15GFI
	Office White	HBLPP10GFW	HBLPP12GFW	HBLPP15GFW
	White	HBLPP10GFW	HBLPP12GFW	HBLPP15GFW
	Clear Anodized Aluminum	HBLPP10GFAL	HBLPP12GFAL	HBLPP15GFAL
Blank pole; divider; (4) Style Line® device knockouts	Black	HBLPPOBK	HBLPPO12BK	HBLPPO15BK
	Gray	HBLPPOA	HBLPPO12A	HBLPPO15A
	Ivory	HBLPPOAI	HBLPPO12AI	HBLPPO15AI
	Office White	HBLPPOOW	HBLPPO12OW	HBLPPO15OW
	White	HBLPPOW	HBLPPO12W	HBLPPO15W
	Clear Anodized Aluminum	HBLPPOAAL	HBLPPO12AAL	HBLPPO15AAL

Accessories

Description	Catalog Number
Adjustable T-bar assembly for mounting poles in the middle of ceiling tile.	ATB*
Replacement service pole trim kit (office white).	PPTRIM1*

Note: * Not UL listed.

Dimensions

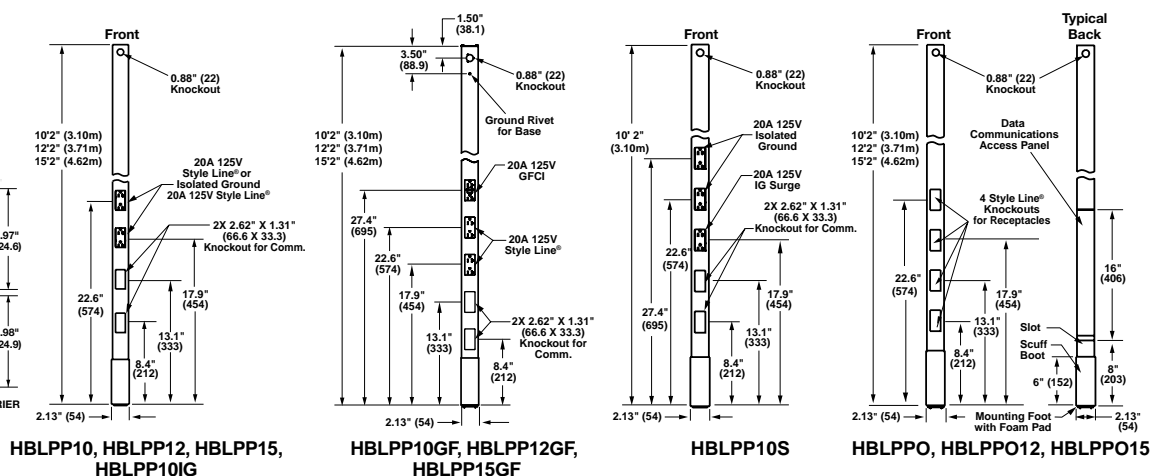

Aluminum Service Poles

Custom Pole Configurations

Using the chart below, you can create a custom service pole. For configurations that require additional customization, please consult Hubbell Technical Service at (475) 882-4800.

Position		1	2	3	4	5	6	7	8	9	10	11	12	13	14
Selections	S P	1	0	0	2	1	1	B	B	B	X	X	X	C	I

Example: SP100211BBBXXXCI

10 Feet 02 Inches, (2) Rectangular Style Line® Knockouts for Data, (3) HBL2162 Duplex Receptacles, (2) Circuits (First 2 Receptacles on Circuit #1, Remaining Receptacles on Circuit #2), Ivory.

Worksheet

Position		1	2	3	4	5	6	7	8	9	10	11	12	13	14
Selections	S P														

Position 1 & 2: Height to the nearest foot.	08-22 Feet.
Position 3 & 4: Height in inches up to 11".	00-11 Inches.
<p>Position 5, 6, 7, 8, 9, 10, 11, 12: Starting at Position 5 Select Datacom Knockouts/Device Frames followed by Power Receptacle/Power Knockout options. If the service pole is power only, select receptacle options starting at Position 5. Empty Positions should be filled with an "X" to designate an empty field.</p> <p><i>Note: If power receptacles are chosen, then power knockouts may not be chosen in the same service pole.</i></p>	<p>Data Selections</p> <ul style="list-style-type: none"> 1 - Rectangular Style Line® Knockout. 2 - ½" NPT Knockout (0.875" diameter). 3 - ¾" NPT Knockout (1.109" diameter). 4 - 2-Port Style Line® Data Frame, 1-Gang, 2 Port Voice/Data Frame. 5 - 3-Port Style Line® Data Frame, 1-Gang, 3 Port Voice/Data Frame. <p>Power Selections</p> <ul style="list-style-type: none"> 6 - Rectangular Style Line® Knockout (for blank poles only). 7 - ½" NPT Knockout (0.875" diameter, for blank poles only). 8 - ¾" NPT Knockout (1.109" diameter, for blank poles only). A - 5362, 20A, 125V AC, Duplex. B - HBL2162, 20A, 125V AC, Style Line® Decorator Duplex. C - IG5362, 20A, 125V AC, I.G. Duplex. D - IG2162, 20A, 125V AC, I.G. Style Line® Decorator Duplex. G - HBL4700, 15A, 125V AC, Twist-Lock® Duplex. H - IG4700A, 15A, 125V AC, I.G. Twist-Lock® Duplex. I - IG2310, 20A, 125V AC, I.G. Twist-Lock® Single. J - IG5361, 20A, 125V AC, I.G. Single. K - HBL5361, 20A, 125V AC, Single. L - HBL2310, 20A, 125V AC, Twist-Lock® Single. M - HBL2610, 30A, 125V AC, Twist-Lock® Single. N - HBL2320, 20A, 250V AC, Twist-Lock® Single. O - HBL2620, 30A, 250V AC, Twist-Lock® Single. Q - IG4710, 15A, 125V AC, I.G. Twist-Lock® Single. R - HBL4710, 15A, 125V AC, Twist-Lock® Single. S - HBL5662, 15A, 250V AC, Duplex. T - IG5662, 15A, 250V AC, I.G. Duplex. U - HBL5661, 15A, 250V AC, Single. V - IG5661, 15A, 250V AC, I.G. Single. W - HBL5462, 20A, 250V AC, Duplex.
Position 13: Power Circuits	<p>Z - No Circuits (Should only be selected when the service poles has ONLY Data and/or Power knockouts).</p> <ul style="list-style-type: none"> A - All devices on a single circuit. B - 2 Circuits, First Receptacle on Circuit #1, Remaining Receptacles on Circuit #2. C - 2 Circuits, First 2 Receptacles on Circuit #1, Remaining Receptacles on Circuit #2. D - 2 Circuits, First 3 Receptacles on Circuit #1, Remaining Receptacles on Circuit #2. E - 2 Circuits, First 4 Receptacles on Circuit #1, Remaining Receptacles on Circuit #2. F - 2 Circuits, First 5 Receptacles on Circuit #1, Remaining Receptacles on Circuit #2. G - 2 Circuits, First 6 Receptacles on Circuit #1, Remaining Receptacles on Circuit #2. H - 2 Circuits, First 7 Receptacles on Circuit #1, Remaining Receptacles on Circuit #2.
Position 14: Color	<ul style="list-style-type: none"> I - Ivory. G - Gray. W - White. K - Black. A - Aluminum with clear anodized finish.

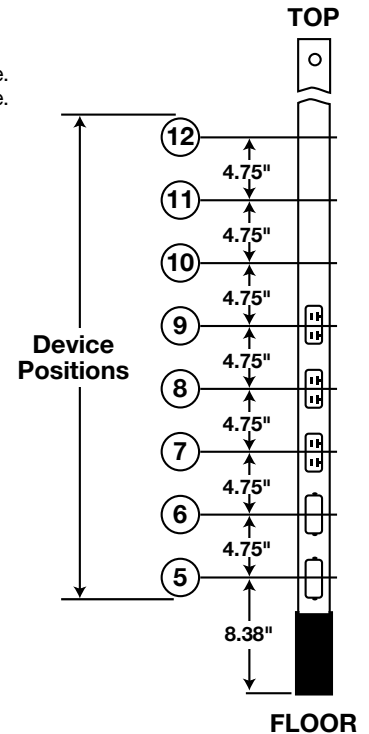

Aluminum Service Poles

Division 16 Specifications

Part 2: Products

2.01 Manufacturer

A. The power poles specified herein for branch circuit wiring shall be Hubbell Service Poles as manufactured by Hubbell Inc., Wiring Device-Kellems® or approved equal. Other manufacturers may be considered equal if they meet the performance requirements of this specification and have received prior written approval.

2.02 Components/Accessories

A. The hardware for mounting Service Poles in the middle of a ceiling tile shall be Hubbell adjustable T-Bar type ATB with trim plate kit type PPTRIM1.

2.03 Materials

A. Standard and Custom Aluminum Service Poles

These Service Poles shall be extruded aluminum with a heavy gauge body (.050 ±.005 inches thick) to resist denting. These poles shall be two-channel to accommodate both power and low voltage services on the same side of the pole. Service poles shall be pre-wired with #12 AWG wire and equipped with specification grade Style Line® decorator receptacles (20A, 125V). These receptacles shall be Hubbell type HBL2162xx or an approved equal. The low voltage (back) channel of the service pole shall incorporate an access panel that provides a passageway to two Style Line® communication knockouts located on the front of the pole.

Finish

Service Poles will include a painted or clear anodized finish.

Custom poles are available in Black, Gray, Ivory, Office White, White, and Clear Anodized Aluminum.

Heights

Standard Service Poles shall be available in three sizes to accommodate various ceiling heights: 10 ft. 2 in. (3.10m), 12 ft. 2 in. (3.71m) and 15 ft. 2 in. (4.62m). Custom Poles shall be available in a range of sizes, a configurator pole is 8 through 22 ft. Other custom poles can be as short as 6 in. through 22 ft.

10 ft. 2 in. (3.10m): Hubbell type HBLPP10BK, HBLPP10A, HBLPP10AI, HBLPP10OW, HBLPP10W, and HBLPP10AAL.

12 ft. 2 in. (3.71m): Hubbell type HBLPP12BK, HBLPP12A, HBLPP12AI, HBLPP12OW, HBLPP12W, and HBLPP12AAL.

15 ft. 2 in. (4.62m): Hubbell type HBLPP15BK, HBLPP15A, HBLPP15AI, HBLPP15OW, HBLPP15W, and HBLPP15AAL.

8-22 feet: Hubbell Custom Poles.

2. Isolated Ground

The following Service Poles contain one Hubbell isolated ground receptacle Hubbell #IG2162 and one #HBL2162xx, both 20A, 125V Style Line® decorator receptacles (wired on separate circuits). Custom poles with a variety of receptacles may also include isolated ground type devices. 10 ft. 2 in. (3.10m): Isolated Ground; Hubbell Type HBLPP10IGBK, HBLPP10IGA, HBLPP10IGAI, HBLPP10IGOW, HBLPP10IGW, and HBLPP10IGAL.

3. Surge Suppression/Isolated Ground

The following Service Poles contain one Hubbell #IG5362xxSA (20A, 125V Surge/IG Style Line® decorator duplex) and two #IG2162 (20A, 125V IG Style Line® decorator duplex) receptacles. All receptacles are wired on the same circuit, therefore providing surge protection at each outlet. Custom poles with a variety of receptacle options may also include surge suppression. 10 ft. 2 in. (3.10m): With Surge; Hubbell Type HBLPP10SBK, HBLPP10SA, HBLPP10SAI, HBLPP10SOW, HBLPP10SW, and HBLPP10SAL.

4. GFCI

The following Service Poles contain one Hubbell #GFST20 (20A, 125V GFCI Self Test Style Line® decorator duplex) and two #HBL2162 (20A, 125V Style Line® decorator duplex) receptacles. All receptacles are wired on the same circuit, the two HBL2162 are GFCI protected by being wired to the load side of the GFST20.

10 ft. 2 in. (3.10m): Hubbell type HBLPP10GFBK, HBLPP10GF, HBLPP10GFI, HBLPP10GFOW, HBLPP10GFW, and HBLPP10GFAL.

12 ft. 2 in. (3.71m): Hubbell type HBLPP12GFBK, HBLPP12GF, HBLPP12GFI, HBLPP12GFOW, HBLPP12GFW, and HBLPP12GFAL.

15 ft. 2 in. (4.62m): Hubbell type HBLPP15GFBK, HBLPP15GF, HBLPP15GFI, HBLPP15GFOW, HBLPP15GFW, and HBLPP15GFAL.

5. Blank

The following Service Poles are two-channel and do not include receptacles or wiring. All poles include a barrier which starts between the second and third knockout positions from the bottom of the pole. Custom poles with or without a barrier are available as well.

10 ft. 2 in. (3.10m): Hubbell type HBLPPOBK, HBLPPOA, HBLPPOAI, HBLPPOOW, HBLPPOW, and HBLPPOAAL.

12 ft. 2 in. (3.71m): Hubbell type HBLPPO12BK, HBLPPO12A, HBLPPO12AI, HBLPPO12OW, HBLPPO12W, and HBLPPO12AAL.

15 ft. 2 in. (4.62m): Hubbell type HBLPPO15BK, HBLPPO15A, HBLPPO15AI, HBLPPO15OW, HBLPPO15W, and HBLPPO15AAL.

B. Voice/Data Interface

All Service Poles must allow for acceptance of Hubbell Style Line® communication outlets.

SECTION S

Table of Contents



Metal Raceway and Aluminum Raceway



Non-Metallic Raceway



Pre-Wired Raceway



Metal Raceway	Page	Non-Metallic Raceway	Page
Raceway Profiles - Quick Reference Guide	S-2	PP1 PremiseTrak® (Latching) Series	S-55
HBL500, HBL700 and HBL750 Series	S-3	PL1 LANTrak® Series	S-56
HBL2000 and HBL2000A Series	S-9	PW1 WallTrak® Low Profile Series	S-57
Metal PlugTrak®	S-12	PW2 2 Channel WallTrak® Series	S-58
HBL2400 and HBL2400D Series	S-13	PB2 2 Channel BaseTrak® Series	S-59
HBL3000 Series	S-17	PB3 3 Channel BaseTrak® Series	S-60
HBL4750 Series	S-21	PS3 3 Channel Super BaseTrak®	S-61
HBL6750 Series	S-27	Non-Metallic PlugTrak® and Portable PlugTrak®	S-62
Aluminum Raceway	Page	Plates, Frames and Modular Connector Fittings	S-63
HBLALU2000 Series	S-33	Wire Fill Capacity Chart and Technical Information	S-64
Aluminum PlugTrak®	S-36	Pre-Wired Raceway	Page
HBLALU3800 and HBLALU4800 Series	S-37	Introduction	S-65
HBLALU5000 and HBLALU7620 Series	S-41	Features and Benefits	S-66
Device Brackets, Plates and Frames	S-45	Aluminum, Steel and Non-Metallic Raceways	S-67
Wire Fill Capacity Chart and Technical Information	S-47	Hubbell Pre-Wired Raceway with LINKOSITY®	S-68
Cross Reference	S-48	FloorTrak™ PRO System	Page
Non-Metallic Raceway	Page	Modular On-Floor Power, Data and AV Delivery System	S-69
PolyTrak® Non-Metallic Raceway	S-53	FloorTrak™ PRO Track and Device Fittings	S-70
PT1 PremiseTrak® (Non-Latching) Series	S-54		

Raceway Profiles - Quick Reference Guide

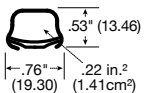
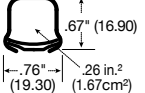
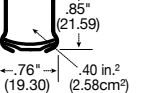
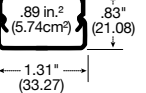
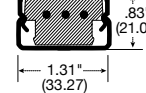
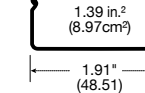
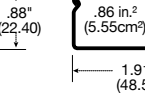
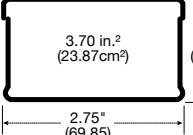
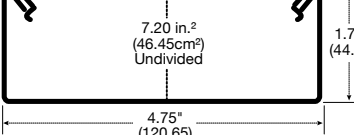
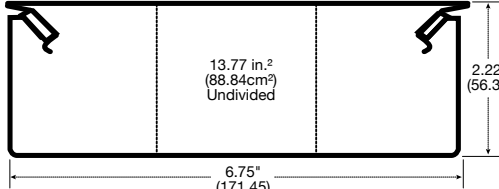
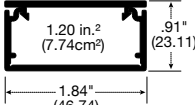
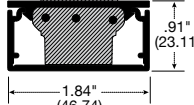
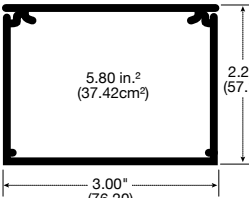
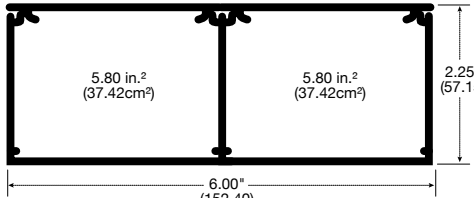
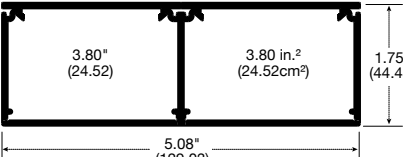
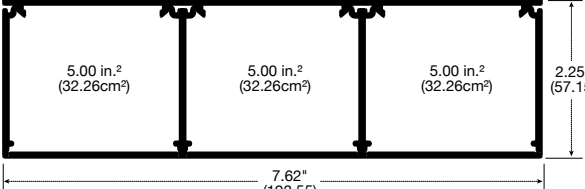
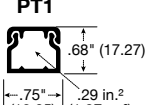
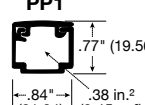
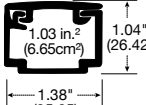
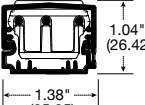
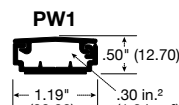
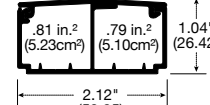
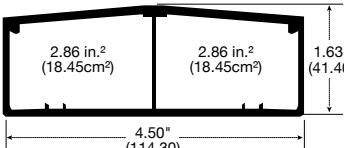
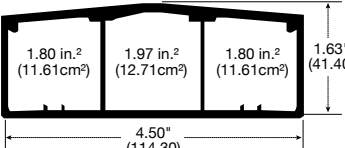
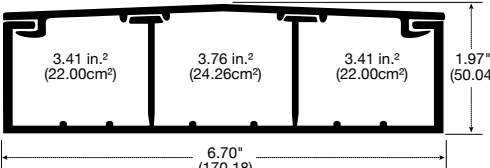
	Color - Ivory, Gray or White						
Metal Raceway	HBL500 Ivory/White  .53" (13.46) .76" (19.30) → .22 in. ² (1.41cm ²)	HBL700 Ivory/White  .67" (16.90) .76" (19.30) → .26 in. ² (1.67cm ²)	HBL750 Ivory/White  .85" (21.59) .76" (19.30) → .40 in. ² (2.58cm ²)	HBL2000/A Ivory/Gray  .89 in. ² (5.74cm ²) .83" (21.08) 1.31" (33.27)	Metal PlugTrak® Ivory/Gray  .83" (21.08) 1.31" (33.27)	HBL2400 Ivory  1.39 in. ² (8.97cm ²) .88" (22.40) 1.91" (48.51)	HBL2400D Ivory  .86 in. ² (5.55cm ²) .88" (22.40) 1.91" (48.51) → .37 in. ² (2.39cm ²)
	Page S-4	Page S-4	Page S-4	Page S-10	Page S-12	Page S-14	Page S-14
	HBL3000* Ivory/Gray  3.70 in. ² (23.87cm ²) 1.53" (38.86) 2.75" (69.85)	HBL4750* Ivory/Gray  7.20 in. ² (46.45cm ²) Undivided 1.75" (44.45) 4.75" (120.65)	HBL6750* Ivory/Gray  13.77 in. ² (88.84cm ²) Undivided 2.22" (56.39) 6.75" (171.45)				
Page S-18	Page S-22	Page S-28					
Aluminum Raceway	Color - Satin Anodized Finish						
	HBLALU2000  1.20 in. ² (7.74cm ²) .91" (23.11) 1.84" (46.74)	Aluminum PlugTrak®  .91" (23.11) 1.84" (46.74)	HBLALU3800*  5.80 in. ² (37.42cm ²) 2.25" (57.15) 3.00" (76.20)	HBLALU4800*  5.80 in. ² (37.42cm ²) 5.80 in. ² (37.42cm ²) 2.25" (57.15) 6.00" (152.40)			
	Page S-34	Page S-36	Page S-38	Page S-39			
HBLALU5000*  3.80 in. ² (24.52) 3.80 in. ² (24.52cm ²) 1.75" (44.45) 5.08" (129.03)	HBLALU7620*  5.00 in. ² (32.26cm ²) 5.00 in. ² (32.26cm ²) 5.00 in. ² (32.26cm ²) 2.25" (57.15) 7.62" (193.55)						
Page S-42	Page S-43						
Non-Metallic Raceway	Color - Office White, White and Black						
	PT1  .68" (17.27) .75" (19.05) → .29 in. ² (1.87cm ²)	PP1  .77" (19.56) .84" (21.34) → .38 in. ² (2.45cm ²)	PL1  1.03 in. ² (6.65cm ²) 1.04" (26.42) 1.38" (35.05)	Non-Metallic PlugTrak®  1.04" (26.42) 1.38" (35.05)	PW1  .50" (12.70) 1.19" (30.23) → .30 in. ² (1.94cm ²)	PW2  .81 in. ² (5.23cm ²) .79 in. ² (5.10cm ²) 1.04" (26.42) 2.12" (53.85)	
	Page S-54	Page S-55	Page S-56	Page S-62	Page S-57	Page S-58	
PB2*  2.86 in. ² (18.45cm ²) 2.86 in. ² (18.45cm ²) 1.63" (41.40) 4.50" (114.30)	PB3  1.80 in. ² (11.61cm ²) 1.97 in. ² (12.71cm ²) 1.80 in. ² (11.61cm ²) 1.63" (41.40) 4.50" (114.30)	PS3*  3.41 in. ² (22.00cm ²) 3.76 in. ² (24.26cm ²) 3.41 in. ² (22.00cm ²) 1.97" (50.04) 6.70" (170.18)					
Page S-59	Page S-60	Page S-61					

Note: *Available in PRE-WIRED.
Channel Area in Square Inches (square centimeters).

Metal Raceway

Products at a Glance



HBL500, HBL700 and HBL750 Series

- Hubbell's exclusive HBL750 Series adds an additional profile for data and electrical applications



Innovative Box Design

- Hubbell Handi-Screw® eases installation by eliminating difficult to install long screws
- Rounded corners with no sharp edges
- One seam construction provides a “clean” look
- Box design allows standard wallplates to be mounted flush with virtually no perimeter profile exposed
- Full line of metal wallplates available
See page S-45 for selection



Enhanced Datacom Capabilities

- Capacity for up to five Category 5e, three Category 6, or two Category 6A cables
- Available with 1½ in. (38.10) Category 6 and 6A bend radius fittings
- Largest single channel low profile raceway available in its class
- Ideal for datacom and oversized neutral applications



White Metal Raceway

- HBL750 Series available in white
- Full line of product
- Additional color options available for architects and interior designers



Retrofit Box for Fire Alarm Detectors

- Fits most manufacturers of audible alarm systems
- Compatible with HBL500, HBL700 and HBL750 Series Metal Raceway
- Available in white and ivory

HBL500, HBL700 and HBL750 Series

HBL500, HBL700 and HBL750 Series	Description	Color	Length	HBL500 Series	HBL700 Series	HBL750 Series
	Base and Cover Available in 5 ft. (1.5m) lengths, packed 50 ft. (15m) per carton and 10 ft. (3m) lengths, packed 100 ft. (30m) per carton. HBL5701C coupling furnished with each length.	Ivory Ivory White	5 ft. 10 ft. 10 ft.	— HBL50010IV HBL50010W A: .53" (13.46) B: .76" (19.30)	— HBL700IV HBL700W A: .67" (16.90) B: .76" (19.30)	HBL7505IV HBL75010IV HBL75010W A: .85" (21.59) B: .76" (19.30)

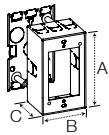

	Color	1-Gang	2-Gang	3-Gang	4-Gang	5-Gang	6-Gang
Standard	Ivory	HBL5748IVA	HBL57482IVA	HBL57483IVA	HBL57484IVA	HBL57485IVA	HBL57486IVA
	White	HBL5748WA A: 4.54" (115.32) B: 2.82" (71.63) C: 1.75" (44.45)	HBL57482WA A: 4.54" (115.32) B: 4.64" (117.86) C: 1.75" (44.45)	HBL57483WA A: 4.54" (115.32) B: 6.45" (163.88) C: 1.75" (44.45)	— A: 4.54" (115.32) B: 8.26" (209.91) C: 1.75" (44.45)	— A: 4.54" (115.32) B: 10.01" (255.93) C: 1.75" (44.45)	— A: 4.54" (115.32) B: 11.89" (301.96) C: 1.75" (44.45)
Shallow	Ivory	HBL5747IVA	HBL57472IVA	HBL57473IVA	—	—	—
	White	HBL5747WA A: 4.54" (115.32) B: 2.82" (71.63) C: 1.38" (35.05)	HBL57472WA A: 4.54" (115.32) B: 4.64" (117.86) C: 1.38" (35.05)	— A: 4.54" (115.32) B: 6.45" (163.88) C: 1.38" (35.05)	—	—	—
Deep	Ivory	HBL5744SIVA	HBL5744S2IVA	HBL5744S3IVA	—	—	—
	White	HBL5744SWA A: 4.54" (115.32) B: 2.82" (71.63) C: 2.25" (57.00)	HBL5744S2WA A: 4.54" (115.32) B: 4.64" (117.86) C: 2.25" (57.00)	— A: 4.54" (115.32) B: 6.45" (163.88) C: 2.25" (57.00)	—	—	—
Extra Deep	Ivory	HBL5744IVA	HBL57442IVA	HBL57443IVA	—	—	—
	White	HBL5744WA A: 4.54" (115.32) B: 2.82" (71.63) C: 2.75" (69.85)	HBL57442WA A: 4.54" (115.32) B: 4.64" (117.86) C: 2.75" (69.85)	— A: 4.54" (115.32) B: 6.45" (163.88) C: 2.75" (69.85)	—	—	—
Base Trade	2 - 1/2"	1 - 1/2", 3/4" Concentric	3 - 1/2"	4 - 1/2"	5 - 1/2"	6 - 1/2"	
Size KOs		1 - Rectangular					

Note: For datacom applications, box selection is dependent on depth of connectors (jacks). See pages S-45 and S-46 for datacom product selection, or visit our site at www.hubbell-wiring.com for our Full Line Catalog and additional information.

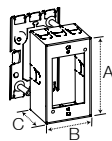

Extension Boxes	Description	Color	1-Gang	1-Gang Deep	1-Gang Blank	2-Gang	3-Gang
	Extension Boxes To extend existing flush switch and receptacle boxes. Blank is used where it is desired to blank original outlet.	Ivory White	HBL5751IVA HBL5751WA A: 4.54" (115.32) B: 2.82" (71.63) C: 1.38" (35.05)	HBL5751AIVA HBL5751AWA A: 4.54" (115.32) B: 2.82" (71.63) C: 1.75" (44.45)	HBL5760IVA — A: 4.54" (115.32) B: 2.82" (71.63) C: 1.13" (28.70)	HBL57512IVA — A: 4.54" (115.32) B: 4.64" (117.86) C: 1.38" (35.05)	HBL57513IVA — A: 4.54" (115.32) B: 6.45" (163.88) C: 1.38" (35.05)

Dimensions in Inches (mm)

HBL500, HBL700 and HBL750 Series

1-Gang Specialty Boxes	Description	Color	1-Gang	2-Gang Specialty Boxes	Description	Color	2-Gang
	Low Profile Switch/Receptacle Base has ½ in. trade size KOs.	Ivory White	HBL5748SIVA HBL5748SWA A: 4.54" (115.32) B: 2.82" (71.63) C: 1.13" (28.70)		Alarm Device Box Surface mounting of alarm devices and safety signals.	Ivory White Red	HBL5752IVA — HBL5752RA A: 4.54" (115.32) B: 4.64" (117.86) C: 1.38" (35.05)
	Combination Switch/Recept. Connects surface runs of ½ in. trade size conduit, one raceway twistout each side and three raceway twistouts top and bottom.	Ivory White	HBL5745IVA HBL5745WA A: 4.54" (115.32) B: 2.82" (71.63) C: 1.75" (44.45)		Extra Deep Alarm Device Box For surface mounting of alarm devices and safety signals. Cover is 2.75 in. (69.85) deep.	Ivory White Red	HBL5753IVA — HBL5753RA A: 4.54" (115.32) B: 4.64" (117.86) C: 2.75" (69.85)
Utility Box* For use as a tee, cross, pull box, junction box or blank box. Base has ½ in. trade size KOs.	Ivory White	HBL57242IVA HBL57242WA A: 4.12" (104.78) B: 2.00" (50.80) C: 1.39" (35.31)	Distribution Box Twistouts permit three parallel raceway runs on each side. Cover takes devices with mounting screw centers of 2.75 in. (69.85), 3.5 in. (89.00), 4.06 in. (103.00) and canopy fixture not larger than 4.63 in. (117.00). Can be used with HBL5736IV (blank cover) to create junction box.	Ivory White	HBL5735IVA — A: 4.54" (115.32) B: 4.64" (117.86) C: 1.38" (35.05)		

Note: *Use catalog number HBL5791 for connecting ½ in. EMT to HBL5745 and HBL57242 boxes.



Round Boxes	Description	Color	4.75 inches O.D.	5.50 inches O.D.	6.38 inches O.D.
	Extension Box (Open Base) For mounting on 3.25 in. (83.00) or 4 in. (102.00) round or square conduit boxes or other recessed outlets. Cover takes any device with mounting screw centers of 2.75 in. (69.85), 3.5 in. (89.00) and 4.06 in. (103.00).	Ivory White	HBL5737IVA HBL5737WA A: 1.02" (26.00) B: 4.75" (120.65)	HBL5737AIVA HBL5737AWA A: 1.02" (26.00) B: 5.50" (140.00)	HBL5739AIVA — A: 1.02" (26.00) B: 6.38" (162.01)
Fixture Box (Solid Base) To hang fixtures. Cover takes any device with mounting screw centers of 2.75 in. (69.85), 3.5 in. (89.00) and 4.06 in. (103.00). Both boxes can be used as a pull or junction box when used with HBL5736IV/W (blank cover).	Ivory White	HBL5738IVA HBL5738WA A: 1.02" (26.00) B: 4.75" (120.65)	HBL5738AIVA HBL5738AWA A: 1.02" (26.00) B: 5.50" (140.00)	HBL5739IVA HBL5739WA A: 1.02" (26.00) B: 6.38" (162.01)	

Specialty Round Boxes	Description	Color	Catalog Number	Round Covers	Description	Color	Catalog Number
	Outlet Box For devices with mounting screw centers of 1.47 in. (37.00), 1.63 in. (41.00), 1.69 in. (44.00) or 1.84 in. (46.00).	Ivory White	HBL5733IVA — A: 1.02" (26.00) B: 3.00" (76.00)		Blank Cover For use with HBL5733IVA. Has ½ in. trade size KO in center.	Ivory White	HBL5731IV — A: .24" (6.10) B: 2.40" (60.96)
	Fanbox with Solid Base Cover accepts fan bracket with mounting centers of 3.2 in. (81.00). Rated for fans and fixtures up to 50 lbs.	Ivory White	HBL5738AFIVA HBL5738AFWA A: .38" (9.75) B: 4.19" (106.30)		Blank Cover For use with HBL5735IVA, HBL5737IVA/WA, HBL5737AIVA/WA, HBL5739AIVA, HBL5738IVA/WA, HBL5738AIVA/WA and HBL5739IVA/WA. Has ½ in. trade size KO in center.	Ivory White	HBL5736IV HBL5736W A: .38" (9.75) B: 4.19" (106.30)
Retrofit Box for Fire Alarm Detectors For installing round alarm sensors.	Ivory White	HBL5739AABIVA HBL5739AABWA A: 1.62" (41.15) B: 6.50" (165.10)					

Dimensions in Inches (mm)

HBL500, HBL700 and HBL750 Series









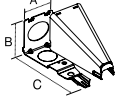

Elbows	Description	Color	HBL500 Series	HBL700 and HBL750 Series	Description	Color	HBL500, HBL700 & HBL750 Series
	Internal Elbow For inside surfaces at right angles.	Ivory White	HBL517IV HBL517W A: 3.33" (84.51) B: .58" (14.73) C: 3.33" (84.51)	HBL717IVA HBL717WA A: 3.33" (84.51) B: .90" (22.86) C: 3.33" (84.51)	Internal Elbow Bend Radius For inside surface at right angles requiring a 1.5 in. (38.10) bend radius. Suitable for Category 5, 5e, 6 and 6A applications.	Ivory White	HBL5717BRIVA — A: 3.33" (84.51) B: .91" (23.11) C: 3.33" (84.51)
	External Elbow For outside surfaces at right angles.	Ivory White	HBL518IV HBL518W A: 2.59" (65.71) B: .58" (14.73) C: 2.59" (65.71)	HBL718IVA HBL718WA A: 2.59" (65.71) B: .90" (22.86) C: 2.59" (65.71)	External Elbow Bend Radius For outside surfaces at right angles requiring a 1.5 in. (38.10) bend radius. Suitable for Category 5, 5e, 6 and 6A applications.	Ivory White	HBL5718BRIVA — A: 4.86" (123.43) B: .78" (19.80) C: 1.35" (34.28)
	90° Flat Elbow For right angle turns on same surface.	Ivory White	HBL511IV HBL511W A: 2.68" (68.13) B: .61" (15.50) C: 2.68" (68.13)	HBL711IVA HBL711WA A: 2.68" (68.13) B: .90" (22.86) C: 2.68" (68.13)	Flat Elbow Bend Radius For right angle turns requiring a 1.5 in. (38.10) bend radius. Suitable for Category 5, 5e, 6 and 6A applications.	Ivory White	HBL5711BRIVA — A: 3.16" (80.34) B: .91" (23.11) C: 3.16" (80.34)
	45° Flat Elbow For diagonal 45° turns on same surface.	Ivory White	HBL512IV — A: 2.46" (62.61) B: .58" (14.73) C: 2.46" (62.61)	HBL712IVA — A: 2.70" (68.49) B: .91" (23.06) C: 2.70" (68.49)	Internal Twisted Elbows For 90° twist with 90° turn. For double turn at right angles from one to another. From a flat run on a side wall to a flat run on a ceiling, edge of door or window trim.	Ivory White Ivory White	Right Elbow HBL5711RHIVA HBL5711RHWA Left Elbow HBL5711LHIVA HBL5711LHWA A: 2.98" (75.72) B: .94" (23.75) C: 3.00" (76.20)

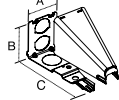

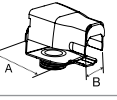

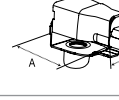

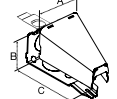
Tees	Description	Color	HBL500, HBL700 & HBL750 Series	Description	Color	HBL500, HBL700 & HBL750 Series
	Tee Fitting For branches at right angles.	Ivory White	HBL5715IVA HBL5715WA A: 3.06" (77.67) B: 1.14" (28.86) C: 3.03" (76.96)	HBL5715BRIVA — A: 5.55" (140.88) B: .90" (22.86) C: 3.16" (80.34)	Tee Fitting Bend Radius For branches at right angles requiring a 1.5 in. (38.10) bend radius. Suitable for Category 5, 5e, 6 and 6A applications.	Ivory White

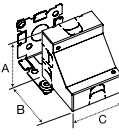
Fittings	Description	Color	HBL500, HBL700 & HBL750 Series	Description	Color	HBL500, HBL700 & HBL750 Series
	Support Clip For supporting lengths of HBL500, HBL700 or HBL750 Raceway.	Ivory White	HBL5703IV HBL5703W A: 2.51" (63.75)	HBL5700FIVA HBL5700FWA A: 18.00" (457.20)	Flexible Section For getting around offsets, side bends, twisted turns or curved surfaces.	Ivory White

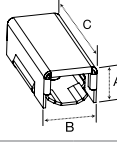
Dimensions in Inches (mm)

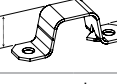
HBL500, HBL700 and HBL750 Series

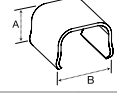
End Fittings	Description	Color	HBL500, HBL700 & HBL750 Series	Description	Color	HBL500, HBL700 & HBL750 Series		
	Entrance Connector One ¼ in. KO for panel or conduit connection. One ¾ in. chase nipple and locknut furnished.	Ivory White	HBL5786AIVA HBL5786AWA	A: 1.50" (38.10) B: 1.84" (46.74) C: 3.89" (98.87)	Adjustable Offset Connector Two ½ in. KOs for panel or conduit connection. Eliminates offsetting raceway when connecting to surface type panel boxes. One ½ in. chase nipple and locknut furnished.	Ivory White	HBL5786IVA HBL5786WA	A: 1.50" (38.10) B: 1.84" (46.74) C: 3.89" (98.87)
	 				 			
	Elbow Box Connector For connecting raceway at right angles to conduit boxes, panel boxes, etc. having ½ in. nipple for trade size conduit.	Ivory White	HBL5783IVA	— A: 2.13" (54.05) B: 1.24" (31.50)	Elbow Conduit Connector For connecting raceway at right angles to ½ in. trade size conduit or armored cable connectors.	Ivory White	HBL5784IVA	— A: 2.13" (54.05) B: 1.24" (31.50)
 				 				
Combination Connector For connecting raceway without offsetting to any 3.25 in. (83.00) or 4 in. (102.00) outlet box mounted on the surface with a KO for ½ in. trade size conduit. Spring steel bushing eliminates need for conduit nipple and locknut.	Ivory White	HBL5785AIVA HBL5785AWA	A: 1.50" (38.10) B: 1.84" (46.74) C: 3.89" (98.87)	Corner Box For connecting HBL500, HBL700 or HBL750 Raceway from ceiling or corner. Each leg of base has ½ in. trade size KO.	Ivory White	HBL5719IVA HBL5719WA	A: 2.50" (63.50) B: 2.50" (63.50) C: 2.40" (60.96)	
 				 				

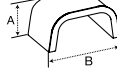
Fittings	Description	Color	HBL500 Series	HBL700 Series	HBL750 Series	
	Transition Fitting For transitioning from either Wiremold® V500 to Hubbell HBL500 Raceway or Wiremold® V700 to Hubbell HBL700 Raceway or Hubbell HBL750 Raceway.	Ivory White	HBL500TFIV	— A: .65" (16.51) B: .89" (22.61) C: 2.15" (54.61)	HBL700TFIV	— A: .78" (19.80) B: .89" (22.61) C: 2.15" (54.61)
	 					
	Mounting Strap (one- or two-hole) For mounting HBL500, HBL700 or HBL750 Raceway to surface. Convert to one-hole by breaking off at score.	Ivory White	HBL504IV HBL504W	A: .58" (14.73) B: .50" (12.70)	HBL7004IV HBL7004W	A: .70" (17.68) B: .50" (12.70)
	 					
Connection Cover To cover potential openings where two lengths of like raceways come together.	Ivory White	HBL506IV HBL506W	A: .60" (15.24) B: .80" (20.31)	HBL7006IV HBL7006W	A: .69" (17.40) B: .80" (20.31)	
 						
Bushing Protect wires from potential abrasion. Fits into end of HBL500, HBL700 or HBL750 Raceway.	Steel*	HBL502B	A: .35" (8.83) B: .70" (17.68)	HBL7002B	A: .49" (12.50) B: .78" (19.80)	
 						

Note: *Zinc Plated Steel.

Wiremold® is a registered trademark of the Wiremold Company.

Dimensions in Inches (mm)

HBL500, HBL700 and HBL750 Series

Fittings	Description	Material	HBL500, HBL700 & HBL750 Series		Description	Material	HBL500, HBL700 & HBL750 Series	
	Box Connector For connecting raceway to conduit boxes or panel boxes having KO for conduit. May also be used for conduit type fittings.	Steel*	HBL5781	HBL5781A	½" NPT (13) Male A: .75" (19.1) B: 1.24" (31.62)	¾" NPT (19) Male A: .75" (19.1) B: 1.24" (31.62)	Steel*	HBL5791 A: 1.20" (30.48) B: 1.09" (27.70)
	Conduit Connector For connecting raceway to conduit.	Steel*	HBL5782C	HBL5782A	½" NPT (13) Female A: .75" (19.1) B: 1.75" (44)	¾" (19.1) Female A: .75" (19.1) B: 1.75" (44)	Steel**	HBL5701C A: 2.00" (50.80)
Grounding Clamp Provides grounding means for ½ in. trade size conduit using locknut.	Steel**	HBL5709GC		A: 1.04" (26.03) B: 1.18" (29.84)		Steel**	HBL5709 A: 2.00" (50.80)	
Special Nipple For hanging or connecting either .375 in. (9.5) or .5 in. (12.7) fixtures to Hubbell fittings with ½ in. trade size KOs.	Steel*	HBL5780		A: .63" (16.00)		Steel**	HBL5790B A: 2.00" (50.80) B: .99" (25.25)	
Armored Cable Connector For connecting 14/2, 14/3, 12/2 and 12/3 "MC" and armored cable to Hubbell fittings. A short piece of HBL500, HBL700 or HBL750 Series Raceway must be used between this connector and the Hubbell fitting. Not for connection to ½ in. (12.7) flex conduit.						Steel**		

Note: *Zinc Plated Steel.
**Galvanized Steel.

Tools	Description	HBL500 Series	HBL700 Series	HBL750 Series	Description	Color	HBL500, HBL700 & HBL750 Series	
	Cutter Portable cutter for HBL500, HBL700 or HBL750 Series Raceways.	HBL605CUT	HBL700CUT	HBL607CUT		Raceway Bender Portable bender for HBL500, HBL700 or HBL750 Series Raceways.		HBL600B
Cutter Replacement Blade	HBL605K	HBL700K	HBL607K		Touch-Up Paint Pen	Ivory White	HBLIWEP HBLWWEPE	

Dimensions in Inches (mm)

Metal Raceway

Products at a Glance



HBL2000A Raceway

- Cover is 0.040 in. (1.016) thick which allows up to 600V AC
- Higher capacity power applications (up to 26 #12 AWG wires)
- Available in cover only or base and cover options



Innovative Box Design

- Hubbell Handi-Screw® eases installation by eliminating difficult to install long screws
- Rounded corners with no sharp edges
- One seam construction provides a “clean” look
- Box design allows standard wallplates to be mounted flush with virtually no perimeter profile exposed
- Full line of metal wallplates available
See page S-45 for selection



Bend Radius Fittings

- 1½ in. (38.10) bend radius
- Ideal for high speed data cables including Category 5, 5e, 6 and 6A applications



Metal PlugTrak® Featuring Exclusive Receptacle Design

- Gray or ivory scratch resistant finish
- Multiple spacing configurations
- Hubbell designed and manufactured single receptacle
- Insulation displacement wiring provides superior wire retention
- Mates with HBL2000 Series Metal Raceway
- Available in 3 ft. (0.9m), 5 ft. (1.5m) and 6 ft. (1.8m) lengths
- Tamper-Resistant and USB versions available

HBL2000 and HBL2000A Series

	Description	Color	Catalog Number		Description	Color	Catalog Number
HBL2000 Series	Base and Cover (300V Rated) Cover is 0.025 in. (0.635) thick up to 300V AC applications. Packed 50 ft. (15m) per carton, 5 ft. (1.5m) lengths.	Ivory Gray	HBL2000BCIV HBL2000BCGY A: 60.00" (1,524.00) B: 1.31" (33.27) C: .83" (21.08)	HBL2000A Series	Base and Cover (600V Rated) Cover is 0.040 in. (1.016) thick up to 600V AC or higher capacity power applications (up to 26 #12AWG wires). Packed 50 ft. (15m) per carton, 5 ft. (1.5m) lengths.	Ivory Gray	HBL2000BCAIV HBL2000BCAGY A: 60.00" (1,524.00) B: 1.31" (33.27) C: .83" (21.08)

	Description	Color	Catalog Number	Description	Color	Catalog Number
Base and Cover	5 Ft. Base Only For use with HBL2000 and HBL2000A raceway. Packed 50 ft. (15m) per carton, 5 ft. (1.5m) lengths.	Ivory Gray	HBL2000B5IV HBL2000B5GY A: 60.00" (1,524.00) B: 1.31" (33.27)	5 Ft. Cover Only (300V Rated) Cover is 0.025 in. (0.635) thick. Packed 50 ft. (15m) per carton, 5 ft. (1.5m) lengths.	Ivory Gray	HBL2000CIV HBL2000CGY A: 60.00" (1,524.00) B: 1.31" (33.27)
			5 Ft. Cover Only (600V Rated) Cover is 0.040 in. (1.016) thick up to 600V AC or higher capacity power applications (up to 26 #12AWG wires). Packed 50 ft. (15m) per carton, 5 ft. (1.5m) lengths.	Ivory Gray	HBL2000CAIV HBL2000CAGY A: 60.00" (1,524.00) B: 1.31" (33.27)	

	Description	Color	Catalog Number	Description	Color	Catalog Number
Device Boxes	1-Gang Device Box For deep switches and receptacles. Base has one ½ in. trade size KO and rectangular KO for extension to wall box.	Ivory Gray	HBL2048IV HBL2048GY A: 4.54" (115.32) B: 2.82" (71.63) C: 1.75" (44.45)	2-Gang Device Box For deep switches and receptacles. Base has one ½ in. trade size KO and rectangular KO for extension to wall box.	Ivory Gray	HBL20482IV HBL20482GY A: 4.54" (115.32) B: 4.64" (117.86) C: 1.75" (44.45)

Elbows	Internal Elbow Bend Radius For inside surface at right angles requiring a 1.5" (38.10) bend radius. Suitable for Category 5, 5e, 6 and 6A applications.	Ivory Gray	HBL2017BRIV* HBL2017BRGY* A: .85" (21.56) B: 3.47" (88.11)
	External Elbow Bend Radius For outside surfaces at right angles requiring a 1.5 in. (38.10) bend radius. Suitable for Category 5, 5e, 6 and 6A applications.	Ivory Gray	HBL2018BRIV* HBL2018BRGY* A: 5.11" (129.72)
	Flat Elbow Bend Radius For branches at right angles requiring a 1.5 in. (38.10) bend radius. Suitable for Category 5, 5e, 6 and 6A applications.	Ivory Gray	HBL2011BRIV* HBL2011BRGY* A: 4.29" (109.03)
Tees	Tee Fitting Bend Radius For branches at right angles. Couplings furnished. Suitable for Category 5, 5e, 6 and 6A applications.	Ivory Gray	HBL2015BRIV* HBL2015BRGY* A: 7.35" (186.78) B: 4.33" (110.00)

Note: *HBL2001C couplings included.

**Galvanized Steel.

Dimensions in Inches (mm)

HBL2000 and HBL2000A Series

	Description	Color	Catalog Number	Description	Color	Catalog Number
End Fittings	Transition Fitting For transitioning from Wiremold® 2000 Raceway to Hubbell HBL2000 Raceway.	Ivory Gray	HBL2000TFIV HBL2000TFGY A: .82" (20.71) B: 1.38" (35.12) C: 2.04" (51.82)	Entrance End Fitting For connecting HBL2000 Raceway with one ½ in. conduit and armored cable connectors.	Ivory Gray	HBL2010A2IV HBL2010A2GY A: 3.01" (76.45) B: 1.30" (33.02) C: 1.49" (37.85)
	Blank End Fitting For closing open end of HBL2000 Raceway.	Ivory Gray	HBL2010BIV HBL2010BGY A: .78" (19.94)	Large Capacity Entrance End Fitting Offers larger capacity than HBL2010A2IV/GY. One ½ in. trade size KO on each side, ½ in. and ¾ in. concentric KOs on end and bottom.	Ivory Gray	HBL2010A3IV HBL2010A3GY A: 3.69" (93.80) B: 2.02" (51.18) C: 1.79" (45.36)
	End Reducing Connector For connecting HBL2000 Raceway to HBL500 Raceway through end of HBL2000 Raceway.	Ivory	HBL2089EIV A: .78" (19.81)	Side Reducing Connector For connecting HBL2000 Raceway to HBL500 Raceway through side of HBL2000 Raceway.	Ivory	HBL2089IV* A: 6.00" (152.40) B: 3.25" (82.55)
Fittings	Cover Clip Use to cover potential openings where two pieces of HBL2000 Raceway cover come together.	Ivory Gray	HBL2006IV HBL2006GY A: .75" (19.05)	Flush Plate Adaptor For feeding HBL2000 Raceway from an existing wall outlet. ½ in. threaded stud with steel locknut for grounding.	Ivory Gray	HBL2051HIV HBL2051HGY A: 4.50" (114.30)
	Wire Clip For holding conductors in place in the raceway base. For use with HBL2000CIV/GY cover only.	Steel**	HBL2000WC A: .44" (11.18) B: .24" (6.03) C: 1.24" (31.50)	Wire Clip For holding conductors in place in the raceway base. For use with HBL2000CAIV/GY cover only.	Steel**	HBL2000WCA A: .44" (11.18) B: .60" (15.17) C: 1.24" (31.50)
	Coupling For joining lengths of HBL2000 Raceway.	Steel**	HBL2001C A: 2.00" (50.80)	Supporting Clip For temporarily supporting lengths of HBL2000 Raceway at any point. Mount with #6 flat head fastener. Has set screw for locking to raceway. Raceway must be screwed to the wall for secure fastening.	Steel**	HBL2003SC A: 2.00" (50.80)
	Ground Clamp For connection of equipment grounding conductor to provide an additional ground to raceway. Galvanized steel.	Steel**	HBL2009GC A: 1.00" (25.64)			

Note: *HBL2001C couplings included.
 **Galvanized Steel.

	Description	Catalog Number	Description	Color	Catalog Number
Tools	Cutter Portable cutter for HBL2000 Series Raceway. (Not for use with HBL2000A series).	HBL620C	Touch-Up Paint Pen	Ivory Gray	HBLIWEP HBLGWEP
	Cutter Replacement Blade Set	HBL620BCK			

Wiremold® is a registered trademark of the Wiremold Company.

Dimensions in Inches (mm)

Metal PlugTrak® Series

Available in Standard, Isolated Ground (IG), Tamper-Resistant (TR) and USB (U) versions.



	Amp Circuits	Single Recept.	USB Ports	Receptacle Spacing (in.)	Color	
					Ivory	Gray
3 Foot	15 Single	6	—	6	HBL20GB306IV	HBL20GB306GY
	15 IG/Single	6	—	6	HBL20IG306IV	HBL20IG306GY
	15 TR/Single	6	—	6	HBL20GB306IVTR	HBL20GB306GYTR
	15 USB/Single	2	2	12	HBL20GB312UIV	—
	20 Single	6	—	6	HBL24GB306IV	HBL24GB306GY
	20 TR/Single	6	—	6	HBL24GB306IVTR	HBL24GB306GYTR
5 Foot	15 Single	10	—	6	HBL20GB506IV	HBL20GB506GY
	15 Single	5	—	12	HBL20GB512IV	HBL20GB512GY
	15 Two	5	—	12	HBL20GBA512IV	HBL20GBA512GY
	15 IG/Single	5	—	12	HBL20IG512IV	HBL20IG512GY
	15 TR/Single	5	—	12	HBL20GB512IVTR	HBL20GB512GYTR
	20 Single	10	—	6	HBL24GB506IV	HBL24GB506GY
	20 Single	5	—	12	HBL24GB512IV	HBL24GB512GY
	20 Two	5	—	12	HBL24GBA512IV	HBL24GBA512GY
6 Foot	15 Single	12	—	6	HBL20GB606IV	HBL20GB606GY
	15 Single	8	—	9	HBL20GB609IV	HBL20GB609GY
	15 Single	6	—	12	HBL20GB612IV	HBL20GB612GY
	15 Single	4	—	18	HBL20GB618IV	HBL20GB618GY
	15 Two	8	—	9	HBL20GBA609IV	HBL20GBA609GY
	15 Two	6	—	12	HBL20GBA612IV	HBL20GBA612GY
	15 Two	4	—	18	HBL20GBA618IV	HBL20GBA618GY
	15 IG/Single	12	—	6	HBL20IG606IV	HBL20IG606GY
	15 USB/Single	4	4	12	HBL20GB612UIV	—
	20 Single	12	—	6	HBL24GB606IV	HBL24GB606GY
	20 Single	6	—	12	HBL24GB612IV	HBL24GB612GY
	20 Single	4	—	18	HBL24GB618IV	HBL24GB618GY
	20 Two	6	—	12	HBL24GBA612IV	HBL24GBA612GY
	20 Two	4	—	18	HBL24GBA618IV	HBL24GBA618GY



Portable	Amp Circuits	Length (in.)	Cord Length (ft.)	Single Recept.	USB Ports	Color	
						Ivory	Gray
	15 Single	40	6	6	—	HBL20C215IV	HBL20C215GY
	15 USB/Single	40	6	4	2	HBL20C215UIV	—
	15 Single	64	6	10	—	HBL20C315IV	HBL20C315GY

Note: IG = Isolated Ground, TR = Tamper-Resistant and U = USB.
 Hubbell Metal PlugTrak is supplied with two HBL2010BIV/GY blank end fittings and one HBL2001C coupling. Catalog number suffix "IV" for ivory finish and "GY" for gray finish. Outlets match raceway color. "IG" Isolated ground receptacles have orange triangles. Portable PlugTrak includes 15A circuit breaker.

Dimensions in Inches (mm)

	Description	Color	Catalog Number
Boxes	1-Gang Device Box	Ivory Gray	HBL2048IV HBL2048GY
	2-Gang Device Box	Ivory Gray	HBL20482IV HBL20482GY
Elbows and Tees	External Elbow	Ivory Gray	HBL2018BRIV HBL2018BRGY
	Flat Elbow	Ivory Gray	HBL2011BRIV HBL2011BRGY
	Tee	Ivory Gray	HBL2015BRIV HBL2015BRGY
End Fittings	Entrance End Fitting	Ivory Gray	HBL2010A2IV HBL2010A2GY
	Large Entrance End Fitting	Ivory Gray	HBL2010A3IV HBL2010A3GY
	Blank End Fitting	Ivory Gray	HBL2010BIV HBL2010BGY
	Cover Clip	Ivory Gray	HBL2006IV HBL2006GY
Fittings	Supporting Clip	Steel**	HBL2003SC*
	Coupling	Steel**	HBL2001C
	Internal Corner Coupling	Steel**	HBL2017TC

Note: *Support clip HBL2003SC for supporting Portable Metal PlugTrak only.
 **Galvanized Steel.
 See pages S-10 and S-11 for additional information.

Metal Raceway

Products at a Glance



HBL2400 and HBL2400D Raceway

- Increased capacity, over HBL2000 Series Raceway
- Divided base allows for dual services within one raceway profile



Innovative Box Design

- Hubbell Handy-Screw® eases installation by eliminating difficult to install long screws
- Rounded corners with no sharp edges
- One seam construction provides a “clean” look
- Box design allows standard wallplates to be mounted flush with virtually no perimeter profile exposed
- Full line of metal wallplates available
See page S-45 for selection



Bend Radius Fittings



- 1½ in. (38.10) bend radius
- Ideal for high speed data cables including Category 5, 5e, 6 and 6A applications

HBL2400 and HBL2400D Series

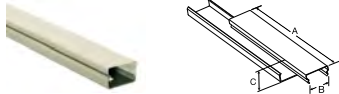
HBL2400 Series	Description	Color	Catalog Number
	Undivided Base and Cover Packed 50 ft. (15m) per carton, 5 ft. (1.5m) lengths.	Ivory	HBL2400BCIV A: 60.00" (1,524.00) B: 1.91" (48.51) C: .88" (22.40)

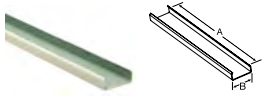

HBL2400 Series Base and Cover	Description 10 Ft. Base, Undivided Packed 50 ft. (15m) per carton, 10 ft. (3m) lengths.	Color	Catalog Number	Description 5 Ft. Cover Packed 50 ft. (15m) per carton, 5 ft. (1.5m) lengths.	Color	Catalog Number
	Description 5 Ft. Base, Undivided Packed 50 ft. (15m) per carton, 5 ft. (1.5m) lengths.	Ivory	HBL2400B10IV A: 120.00" (3,048.00) B: 1.91" (48.51)		Ivory	HBL2400CIV A: 60.00" (1,524.00) B: 1.89" (48.00)





HBL2400D Series Base and Cover	Description 10 Ft. Base, Divided Packed 50 ft. (15m) per carton, 10 ft. (3m) lengths.	Color	Catalog Number
		Ivory	HBL2400BDIV A: 120.00" (3,048.00) B: 1.91" (48.51)



Description	Color	Type	1-Gang		2-Gang	
			Standard	Extra Deep	Standard	Extra Deep
Device Box For deep switches and receptacles. Base has one ½ in. trade size KO and rectangular KO for extension to wall box.	Ivory	Divided	—	HBL2444DIVA A: 4.54" (115.32)	—	HBL2444D2AIV A: 4.54" (115.32)
	Ivory	Undivided	HBL2448IVA A: 4.54" (115.32) B: 2.82" (71.63) C: 1.75" (44.45)	HBL2444IVA A: 4.54" (115.32) B: 2.82" (71.63) C: 2.75" (69.85)	HBL24482IV A: 4.54" (115.32) B: 4.64" (117.86) C: 1.75" (44.45)	HBL24442IV A: 4.54" (115.32) B: 4.64" (117.86) C: 2.75" (69.85)

Elbows and Tees	Description Internal Elbow Bend Radius For inside surfaces at right angles, requiring a 1.5 in. (38.10) bend radius. Suitable for Category 5, 5e, 6 and 6A applications.	Color	Type	Catalog Number	Description External Elbow Bend Radius For right angle turns around external corners. Suitable for Category 5, 5e, 6 and 6A applications.	Color	Type	Catalog Number
		Ivory	Divided	HBL2417DFOIV* HBL2417IV** A: 1.91" (48.51) B: 3.60" (91.30)		Ivory	Divided	HBL2418DFOIV* HBL2418IV** A: 1.91" (48.51) B: 3.83" (97.28)
		Ivory	Undivided			Ivory	Undivided	
	Description 90° Flat Elbow Bend Radius For right angle turns on same surface. Suitable for Category 5, 5e, 6 and 6A applications.	Ivory	Divided	HBL2411DFOIV* HBL2411IV** A: 6.00" (152.40) B: 5.00" (127.00) C: .90" (22.86)	Description Tee Fitting Bend Radius For branches at right angles. Suitable for Category 5, 5e, 6 and 6A applications.	Ivory	Divided	HBL2415DFOIV* HBL2415IV** A: 7.30" (185.42) B: 4.99" (126.75) C: 1.44" (36.58)
	Ivory	Undivided			Ivory	Undivided		



Note: *HBL2401DC couplings included.

**HBL2401C couplings included.

Dimensions in Inches (mm)

HBL2400 and HBL2400D Series

	Description	Color	Type	Catalog Number	Description	Color	Type	Catalog Number
End Fittings	Entrance End Fitting End fitting with ½ in. and ¾ in. concentric trade size KOs on end and bottom. Additional ½ in. trade size KOs on sides.	Ivory Ivory	Divided Undivided	— HBL2410CIV A: 3.69" (93.8) B: 2.02" (51.2) C: 1.79" (45.4)	Entrance End Fitting Bend Radius Divided, bend radius end fitting to feed HBL2400 and HBL2400D Series Raceway. Includes 1 in. and ¾ in. trade size KOs on back and end. Removable divider and bend radius inserts included.	Ivory Ivory	Divided Undivided	HBL2410DFOIV — A: 7.08" (179.83) B: 4.72" (119.89) C: 2.76" (70.10)
	Entrance End Fitting For connecting HBL2400 Raceway with one ½ in. conduit and armored cable connectors.	Ivory Ivory	Divided Undivided	— HBL2410AIV A: 1.16" (29.50) B: 1.89" (49.00) C: 1.66" (42.20)	Entrance End Fitting Full Capacity Full capacity entrance end to feed HBL2400 Series Raceway. Includes three 1 in. and ¾ in. concentric trade size KOs.	Ivory Ivory	Divided Undivided	— HBL2410FCIV A: 3.04" (77.23) B: 2.61" (66.29) C: 2.23" (56.64)
	Transition Fitting For transitioning from Wiremold® 2400D/2400 Raceway to Hubbell HBL2400/HBL2400D Raceway.	Ivory Ivory	Divided Undivided	HBL2400DTFIV HBL2400TFIV A: 2.02" (51.31) B: 1.06" (26.92)	Blank End Fitting For closing open end of HBL2400 Raceway.	Ivory Ivory	Divided Undivided	HBL2410BDIV HBL2410BIV A: 1.17" (29.72) B: 1.96" (49.78) C: .84" (21.34)

	Description	Color	Catalog Number	Description	Color	Catalog Number
Fittings	End Reducing Connector For connecting HBL2400 Raceway to HBL2000 Raceway through end of HBL2400 Raceway.	Ivory	HBL2420REDIV* A: 3.81" (96.77) B: 2.07" (52.58) C: .90" (22.86)	End Reducing Connector For connecting HBL4750 Raceway to HBL2400 Raceway through end of HBL4750 Raceway. Includes HBL2401DC coupling (HBL4751AC not included).	Ivory	HBL4724REDIV A: 4.75" (120.65) B: 3.00" (76.20) C: 1.55" (39.37)
	Side Reducing Connector For connecting HBL2400 Raceway to HBL500 Raceway through side of HBL2400 Raceway.	Ivory	HBL2489IV* A: 3.75" (95.25) B: 1.91" (48.51) C: .82" (20.83)	Bridge Fitting For allowing HBL2400 Series Raceway to bridge over existing installations of HBL2400, HBL750 and HBL500 Series Raceways.	Ivory	HBL2475DBRIV A: 5.60" (142.24) B: 2.92" (74.17) C: 1.63" (41.40)
	Cover Clip Use to cover potential openings where two pieces of HBL2400 Raceway cover come together.	Ivory	HBL2406IV A: 1.50" (38.10)	Flush Plate Adaptor For feeding HBL2400 Raceway from an existing wall outlet box ½ in. trade size male nipple. Provided with locknut for grounding.	Ivory	HBL2451HIV* A: 4.50" (114.30)
	Wire Clip (Plated) For holding conductors in place.	Steel**	HBL2400WC A: 1.69" (42.93) B: 1.00" (25.40) C: .79" (20.00)	Ground Clamp (Plated) For connection of equipment grounding conductor to provide an additional ground to raceway.	Steel**	HBL2409GC A: .41" (10.41)
	Coupling (Plated), Divided For joining lengths of HBL2400 Raceway.	Steel**	HBL2401DC A: 2.00" (50.80) B: 1.86" (47.24)	Coupling (Plated), Undivided For joining lengths of HBL2400 Raceway.	Steel**	HBL2401C A: 2.00" (50.80) B: 1.86" (47.24)

Note: *Only used on HBL2400 Series Undivided Raceway.
**Galvanized Steel.



Wiremold® is a registered trademark of the Wiremold Company.

Dimensions in Inches (mm)

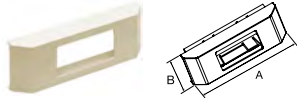
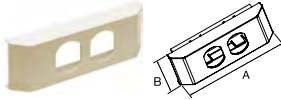
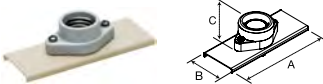
HBL2400 and HBL2400D Series

Devices and Frames	Description	Color	Catalog Number	Description	Color	Catalog Number
	<p>Receptacle Bracket and Frame For use with power devices with maximum width of 1.35 in. (84.3) and in low voltage applications with ISFxxAL frames found on page S-45.</p> 	Ivory	HBL24106RRK* A: 6.00" (152.40) B: 2.02" (51.31)	<p>Duplex Bracket and Frame For use with power devices with maximum width of 1.35 in. (84.3) and in low voltage applications with BR106AL and Q106AL frames found on page S-45.</p> 	Ivory	HBL24106DRK* A: 6.00" (152.40) B: 2.02" (51.31)
<p>Lamp Holder Medium base lamp holder 660W 250V ceramic. Ivory (Cover) White Ceramic (Lamp Holder).</p> 	Ivory	HBL2426IV* A: 5.00" (127.00) B: 1.89" (48.01) C: 1.03" (26.16)				

Note: *Only used on HBL2400 Series Undivided Raceway.

Tools	Description	Catalog Number	Description	Color	Catalog Number
	<p>Cutter Portable cutter for HBL2400/ HBL2400D Series Raceway.</p> 		HBL624CUT	<p>Touch-Up Paint Pen</p> 	Ivory
<p>Cutter Replacement Blade Set</p> 		HBL624BCK			

Dimensions in Inches (mm)

Metal Raceway

Products at a Glance



HBL3000 Series Extensive Line

- Full line of large, single channel, two piece metal raceway
- Easily mounts on walls or bench tops
- Large single channel base for power or datacom cables
- UL Listed and CSA Certified
- Available in ivory or gray powder coat finish



Innovative Box Design

- Hubbell Handi-Screw® eases installation by eliminating difficult to install long screws
- Rounded corners with no sharp edges
- One seam construction provides a “clean” look
- Large capacity allows for the installation of 30, 50 or 60A receptacles
- Utility box can be used as a tee, cross, junction box or as a branch circuit extension



Transition Fittings

- UL Classified to transition from Wiremold® 3000 Series Metal Raceway to Hubbell HBL3000 Series Metal Raceway
- Reducer fitting provides transition from Hubbell HBL3000 Series to Hubbell HBL2000 Series Raceway



Plates and Covers

- Wide range of covers and cover plates accommodate the most demanding applications
- Removable cover and cover plates provide easy access to wiring compartment
- Precut covers and plates provide quick installation and are available in common configurations

Wiremold® is a registered trademark of the Wiremold Company.

HBL3000 Series

HBL3000 Series	Description	Color	Catalog Number	Description	Color	Catalog Number
	Single Channel Base Packed 100 ft. (30.5m) per carton, 10 ft. (3m) lengths. Assembled cover and base dimensions. W: 2.75" (69.85) H: 1.53" (38.86)	Ivory Gray	HBL3000BIV HBL3000BGY A: 2.73" (69.34) B: 1.47" (37.34)	5 Ft. Cover Packed 100 ft. (30.5m) per carton, 5 ft. (1.5m) lengths.	Ivory Gray	HBL3000CEIV HBL3000CEGY A: 60.00" (1,524.00) B: 2.75" (69.85)

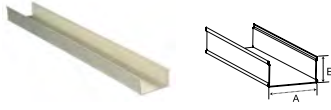

Note: *Packed 10 pieces per carton. Device centers vary based on cover selection. Consult factory for details.

Boxes	Description	Color	Catalog Number	Description	Color	Catalog Number
	Utility Box Cover has twistouts on all sides, allows for box to be used as tee, cross, junction box or for branch circuit extensions.	Ivory Gray	HBL3028IV HBL3028GY A: 6.41" (162.89) B: 6.41" (162.89) C: 1.90" (48.26)	2-Gang Extra Deep Switch and Receptacle Box For standard 30, 50 and 60A straight blade receptacles.	Ivory Gray	HBL30442IV HBL30442GY A: 6.38" (162.05) B: 6.38" (162.05) C: 2.75" (69.85)

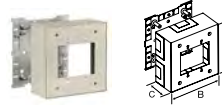
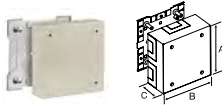

Elbows and Tees	Description	Color	Catalog Number	Description	Color	Catalog Number
	Internal Corner Coupling For surfaces at right angles or for use as a straight-through fitting.	Ivory Gray	HBL3017TCEIV HBL3017TCEGY A: 2.61" (66.29)	External Corner Coupling For right angle turns around external corners.	Ivory Gray	HBL3018AEIV HBL3018AEGY A: 4.00" (101.60)

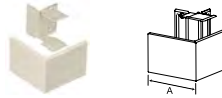

Dimensions in Inches (mm)





HBL3000 Series

End Fittings	Description	Color	Catalog Number	Description	Color	Catalog Number
	Entrance End Fitting For connecting HBL3000 Raceway with ½ in. conduit and armored cable connectors.	Ivory Gray	HBL3010AEIV HBL3010AEGY A: 2.75" (69.85) B: 3.42" (86.87)	Entrance End Fitting For connecting HBL3000 Raceway with rigid or flexible conduit. Concentric ½ in., ¾ in. and 1 in. trade size KO's on end and each side.	Ivory Gray	HBL3010CIV HBL3010CGY A: 2.75" (69.85) B: 3.25" (82.55) C: 2.00" (50.80)
	Blank End Fitting For closing open end of HBL3000 Raceway. Has concentric ½ in. and ¾ in. trade size KO's.	Ivory Gray	HBL3010BIV HBL3010BGY A: 2.71" (68.82) B: 1.79" (45.36) C: 1.41" (35.84)	Panel Connector To connect HBL3000 Raceway with surface type boxes.	Ivory Gray	HBL3086IV HBL3086GY A: 4.60" (116.71) B: 1.19" (30.16) C: 3.00" (76.20) D: 1.94" (49.40) E: 3.76" (95.50)
	Conduit Connector To connect end of HBL3000 Raceway to 1½ in. trade size conduit or connector.	Gray	HBL3082GY A: 2.91" (74.00) B: 2.75" (69.85)			

Fittings	Description	Color	Catalog Number	Description	Color	Catalog Number
	Transition Fitting For transitioning from Wiremold® 3000 Raceway to Hubbell HBL3000 Raceway.	Ivory Gray	HBL3000TFIV HBL3000TFGY A: 2.85" (72.39) B: 2.15" (54.61) C: 1.50" (38.04)	Take-Off Connector (Reducer) Transition Hubbell HBL3000 Raceway to Hubbell HBL2000 Raceway.	Ivory Gray	HBL3200REDIV HBL3200REDGY A: 2.75" (69.85) B: 2.25" (57.15)
	Wall Box Connector For connecting to HBL3000 Raceway from a flush mounted wall box.	Ivory Gray	HBL3014CIV HBL3014CGY A: 8.00" (203.20) B: 3.28" (83.31)	Tap-Off Fitting Has concentric ½ in. and ¾ in. trade size KO's and twistout for communication cables.	Ivory Gray	HBL3046H2IV HBL3046H2GY A: 4.75" (120.65)
	Cover Clip Use to cover potential openings where two pieces of HBL3000 Raceway come together.	Ivory Gray	HBL3006EIV HBL3006EGY A: 2.78" (70.60) B: .75" (19.05)	Supporting Clip For supporting lengths of HBL3000 Raceway at any point. Mount with #8 flat head fastener. Has set screw for locking to raceway.	Ivory Gray	HBL3003IV HBL3003GY A: 2.81" (71.33) B: .75" (19.05)
	Wire Clip (Plated) For holding conductors in place.	Steel*	HBL3000WCGY A: 1.00" (25.40)	Rigid Inside Coupling (Plated) For joining lengths of HBL3000 Raceway when added rigidity is required, i.e. raceway suspended overhead.	Steel*	HBL3001AGY A: 6.00" (152.40)
	Coupling (Plated) For joining lengths of HBL3000 Raceway.	Steel*	HBL3001GY A: 2.20" (55.75)			

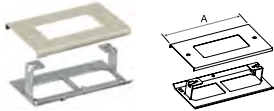
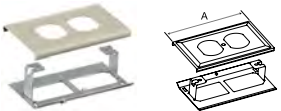
Note: *Galvanized Steel.

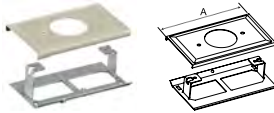
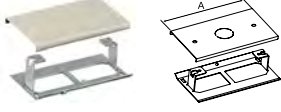
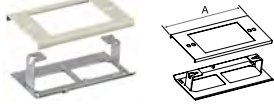
HBL3000 Series

Device Bracket and Cover Plates	Description	Color	Catalog Number	Description	Color	Catalog Number		
	Switch Cover For installing single pole, two pole, three way or four way switches. Includes HBL3007CGY device bracket.	Ivory Gray	HBL3040CEIV HBL3040CEGY A: 4.50" (114.30)		Rectangular Style Line® Recept. Cover For installing 15A and 20A rectangular duplex receptacles, GFCI, surge devices, and rectangular communication frames shown on page S-45. Includes HBL3007CGY device bracket.	Ivory Gray	HBL3048RIV HBL3048RGY A: 4.50" (114.30)	
	Duplex Receptacle Cover For installing 15A and 20A duplex receptacles and duplex communication frames shown on page S-45. Includes HBL3007CGY device bracket.	Ivory Gray	HBL3043BEIV HBL3043BEGY A: 4.50" (114.30)		Duplex Receptacle Cover For high strain/vibration. For installing 15A and 20A duplex receptacles and duplex communication frames shown on page S-45. Includes device brackets.	Ivory Gray	HBL3046BEIV HBL3046BEGY A: 5.38" (136.65)	
	Single Receptacle Cover For installing straight blade and locking single receptacles with face diameters of 1.38 in. to 1.39 in. (35.05 to 35.31). Includes HBL3007CGY device bracket.	Ivory Gray	HBL3027AEIV HBL3027AEGY A: 4.50" (114.30)		Single Receptacle Cover For installing straight blade and locking single receptacles with face diameters of 1.56 in. to 1.57 in. (39.62 to 39.88). Includes HBL3007CGY device bracket.	Ivory Gray	HBL3033JEIV HBL3033JEGY A: 4.50" (114.30)	
	Blank Cover Has one ½ in. trade size KO in center. Includes HBL3007CGY bracket.	Ivory Gray	HBL3036HEIV HBL3036HEGY A: 4.50" (114.30)		Extension Cover Cover accepts 3-wire 30A and 50A devices and standard commercially available flush plates. Includes HBL3007CGY device bracket. See page S-45 for plate options.	Ivory Gray	HBL3051LEIV HBL3051LEGY A: 4.50" (114.30)	
	Device Bracket For mounting standard devices in HBL3000 Raceway. Use with commercially available flush plate (not furnished).	Steel*	HBL3007CGY A: 4.50" (114.30) B: 3.28" (83.31)					

Note: *Galvanized Steel.

Tools	Description	Color	Catalog Number	Description	Catalog Number	
	Base Cutter Portable cutter for HBL3000 Raceway Base.			HBL630B	Cover Cutter Portable cutter for HBL3000 Raceway Cover.	HBL630C
	Replacement Blade Cutter and Die Set Base blade set.			HBL630BDK	Replacement Blade Cutter and Die Set Cover blade set.	HBL630CDK
Touch-Up Paint Per	Ivory Gray	HBLIWEP HBLGWEP				

Dimensions in Inches (mm)

Metal Raceway

Products at a Glance



HBL4750 Device Bracket

- HBL4750 Device Bracket Plate provides excellent solution for power, data, voice, audio and video applications
- For use with Hubbell KP plates and Hubbell iSTATION modules and bezels
- Provides flush finish with overlap feature to hide potential miscuts

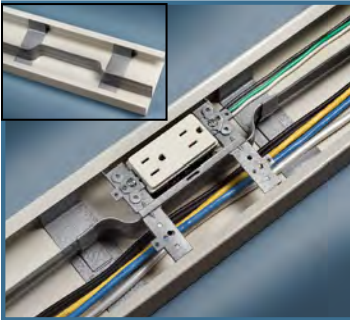

Application Capacity and Flexibility

- Flexible channel divider provides industry leading data capacity in the same profile with a 2/3 datacom split
- By-Pass Divider opening accepts GFCI or surge devices to be mounted in 70/30 divided channel
- Greater capacity offers more room for moves, adds and changes
- 50/50 split available by utilizing standard divider and divider clips
- Raceway channel can also be used with no divider for maximum cable fill in single service applications



End Reducing Connector



- Connects HBL4750 Raceway to HBL2400 Raceway through the end of HBL4750 Raceway
- Used to connect two different sized raceway profiles







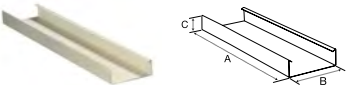

Extensive Line

- 1¼ in. (31.75mm) bend radius fittings meet TIA/EIA requirements
- Integral bend radius offers a fixed solution that does not have to be installed as an option
- Large cross sectional area provides for maximum cable capacity throughout entire system
- Available external, internal, flat, tee and entrance end fittings
- UL Listed, CSA Certified
- Available in ivory or gray powder coat finish

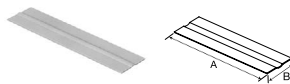
HBL4750 Series

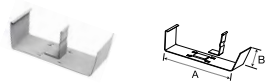
HBL4750 Series	Description	Color	Catalog Number	Description	Color	Catalog Number		
	Single Channel Base Packed 50 ft. (15.24m) per carton, 10 ft. (3m) lengths. Assembled cover and base dimensions. W: 4.75" (120.65) H: 1.75" (44.45)	Ivory	HBL4750B10IV		5 Ft. Cover Packed 50 ft. (15.24m) per carton, 5 ft. (1.5m) lengths.	Ivory	HBL4750CIV	
		Gray	HBL4750B10GY		A: 120.00" (3048.00) B: 4.75" (120.65) C: 1.62" (41.20)	A: 60.00" (1,524.0) B: 4.75" (120.65)	Gray	HBL4750CGY
						31 In. Precut Cover* For 36 in. (915.00) centers with HBL4747 and HBL4750 Plates.	Ivory	HBL4750C315IV
						A: 31.50" (800.10) B: 4.75" (120.65)	Gray	HBL4750C315GY
						19 In. Precut Cover* For 24 in. (610.00) centers with HBL4747 and HBL4750 Plates.	Ivory	HBL4750C195IV
			A: 19.50" (495.30) B: 4.75" (120.65)	Gray	HBL4750C195GY			
			13 In. Precut Cover* For 18 in. (457.00) centers with HBL4747 and HBL4750 Plates.	Ivory	HBL4750C135IV			
			A: 13.50" (342.90) B: 4.75" (120.65)	Gray	HBL4750C135GY			
			7 In. Precut Cover* For 12 in. (305.00) centers with HBL4747 and HBL4750 Plates.	Ivory	HBL4750C075IV			
			A: 7.50" (190.50) B: 4.75" (120.65)	Gray	HBL4750C075GY			
								

Note: *Packed 10 pieces per carton. Device centers vary based on cover selection. Consult factory for details.

Fittings	Description	Color	Catalog Number	Description	Color	Catalog Number	
	Divider Divides HBL4750 Raceway into two channels. Packed 50 ft. (15.24m) per carton, 5 ft. (1.5m) lengths. HBL4751DA Divider Clips are required to hold divider in place.	Painted Steel	HBL4750DGY	A: 60.00" (1,524.0) B: 1.51" (38.46)	By-Pass Divider Divides HBL4750 Raceway into two channels with a 70/30 split. Allows for a larger power or datacom wire fill HBL4751DA Divider Clips are required to hold divider in place.	Painted Steel	HBL4750BP
							
Divider Clip Required for holding HBL4750DGY in place. Use one every 2.5 ft. (.762m).	Steel**	HBL4751DA	A: 4.64" (117.77) B: 1.46" (37.07)	Wire Clip (Plated) For holding conductors in place.	Steel**	HBL4750WCGY	
							
Internal Corner Coupling (Plated) Concealed fitting for making an internal corner while continuing original run in a straight line.	Steel**	HBL4717TCAGY	A: 4.59" (116.59) B: 2.71" (68.73) C: 1.47" (37.34)	Coupling (Plated) For joining lengths of HBL4750 Raceway. Sold in pairs.	Steel**	HBL4751AC	
							

Note: **Galvanized Steel.

Dimensions in Inches (mm)





HBL4750 Series







	Description	Color	Catalog Number	Description	Color	Catalog Number	
Elbows	Internal Elbow, Divided For inside surfaces at right angles. Full capacity 1¼ in. bend radius internal elbow.	Ivory Gray	HBL4717DFOIV* HBL4717DFOGY* A: 4.74" (120.47) B: 4.75" (120.65)	Internal Elbow, Undivided For inside surfaces at right angles.	Ivory Gray	HBL4717IV* HBL4717GY* A: 4.74" (120.47) B: 4.75" (120.65)	
	External Elbow, Divided For right angle turns around external corners. Full capacity 1¼ in. bend radius external elbow.	Ivory Gray	HBL4718DFOIV* HBL4718DFOGY* A: 4.88" (123.90) B: 4.75" (120.65)	External Elbow, Undivided For right angle turns around external corners.	Ivory Gray	HBL4718IV* HBL4718GY* A: 4.88" (123.90) B: 4.75" (120.65)	
	Flat Elbow, Divided For right angle turns on same surface. Full capacity 1¼ in. bend radius flat elbow.	Ivory Gray	HBL4711DFOIV* HBL4711DFOGY* A: 7.23" (183.76) B: 1.62" (41.15)	Flat Elbow, Undivided For right angle turns on same surface.	Ivory Gray	HBL4711IV* HBL4711GY* A: 7.23" (183.76) B: 1.62" (41.15)	
	Internal or External 45° Elbow For making internal or external turns in a run of HBL4750 Raceway.	Ivory Gray	HBL4712TXIV HBL4712TXGY A: 6.04" (153.45) B: 4.59" (116.59)	Inverted Internal Elbow For connecting a vertical run of HBL4750 Raceway with a horizontal run.	Ivory Gray	HBL4717NIV HBL4717NGY A: 4.60" (116.84) B: 1.66" (42.29)	
	Tees	Tee Fitting, Divided For branches at right angles. Full capacity 1¼ in. bend radius tee fitting.	Ivory Gray	HBL4715DFOIV* HBL4715DFOGY* A: 10.93" (277.63) B: 7.27" (184.54) C: 1.62" (41.15)	Tee Fitting, Undivided For branches at right angles.	Ivory Gray	HBL4715IV* HBL4715GY* A: 10.93" (277.63) B: 7.27" (184.54) C: 1.62" (41.15)

Note: *HBL4751AC couplings included.

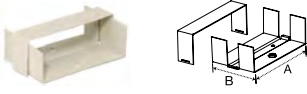
Dimensions in Inches (mm)

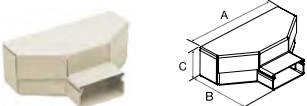
HBL4750 Series

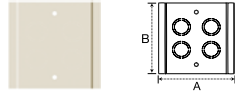
End Fittings	Description	Color	Catalog Number	Description	Color	Catalog Number
	<p>Entrance End Fitting, Divided For connecting HBL4750 Raceway with rigid or flexible conduit. Concentric 3/4 in., 1 in. and 1 1/4 in. trade size KOs on back and end. Full capacity 1 1/4 in. bend radius entrance end fitting. Includes 3/4 in., 1 in., 1 1/4 in. KO and removable divider.</p> 	Ivory Gray	HBL4710DFOIV* HBL4710DFOGY* A: 6.76" (171.70) B: 4.75" (120.65) C: 2.66" (67.50)	<p>Entrance End Fitting, Undivided For connecting HBL4750 Raceway with rigid or flexible conduit. Concentric 3/4 in., 1 in. and 1 1/4 in. trade size KOs on back and end.</p> 	Ivory Gray	HBL4710IV* HBL4710GY* A: 6.76" (171.70) B: 4.75" (120.65) C: 2.66" (67.50)
<p>Blank End Fitting For closing open end of HBL4750 Raceway. Has two 1/2 in. trade size KOs.</p> 	Ivory Gray	HBL4710BIV HBL4710BGY A: 4.59" (116.50) B: 1.64" (41.60) C: 1.31" (33.37)	<p>Panel Connector To connect HBL4750 Raceway with surface type panel boxes.</p> 	Ivory Gray	HBL4786AIV HBL4786AGY A: 7.50" (190.50)	

Fittings	Description	Color	Catalog Number	Description	Color	Catalog Number
	<p>Transition Fitting For transitioning Wiremold® 4000 Raceway to Hubbell HBL4750 Raceway.</p> 	Ivory Gray	HBL4750TFIV HBL4750TFGY A: 5.02" (127.53) B: 2.79" (70.78)	<p>Wall Box Connector For back feeding HBL4750 Raceway.</p> 	Ivory Gray	HBL4714AIV HBL4714AGY A: 12.00" (304.80) B: 4.75" (120.65) C: 1.62" (41.15)
	<p>End Reducing Connector For connecting HBL4750 Raceway to HBL2400 Raceway through the end of HBL4750 Raceway. Includes HBL2401DC coupling (HBL4751AC not included).</p> 	Ivory Gray	HBL4724REDIV A: 4.75" (120.65) B: 3.00" (76.20) C: 1.55" (39.37)	<p>Bridge Fitting To bridge HBL4750 series raceway over perpendicular run of raceway or other obstruction. Use standard raceway base and cover, cut in field to required length. Consists of two bridge pieces.</p> 	Ivory Gray	HBL4775DKITIV HBL4775DKITGY A: 4.76" (120.90) B: 5.00" (127.00) C: 3.38" (85.85)
	<p>Take-Off Connector (HBL4750 To HBL3000) For 90° tee connection of HBL3000 Raceway from HBL4750 Raceway.</p> 	Ivory Gray	HBL4774AIV HBL4774AGY A: 11.31" (287.38) B: 4.88" (124.00) C: 3.14" (79.78)	<p>2-Gang Tap-Off Fitting Has four concentric 1/2 in. and 3/4 in. trade size KOs.</p> 	Ivory Gray	HBL4746H2IV HBL4746H2GY A: 4.75" (120.65) B: 4.75" (120.65)
	<p>Connection Cover For covering potential openings where two covers come together.</p> 	Ivory Gray	HBL4756AIV HBL4756AGY A: 4.77" (121.16) B: .75" (19.05) C: .13" (3.36)			

Note: *HBL4751AC couplings included.



HBL4750 Series



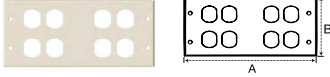
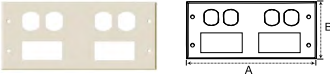
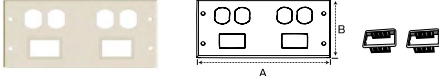

	Description	Color	Catalog Number	Description	Color	Catalog Number
Device Plates and Mounting Bracket	1-Gang Commercial Device Plate Vertical Mount Use with commercially available 1-gang flush plates. See page S-45 for plate options. For single service applications only.	Ivory Gray	HBL4747CVMIV HBL4747CVMGY A: 2.50" (63.50) B: 4.75" (120.65)	2-Gang Commercial Device Plate Vertical Mount Use with commercially available 2-gang flush plates. See page S-45 for plate options. For single service applications only.	Ivory Gray	HBL4747CVM2IV HBL4747CVM2GY A: 4.32" (109.86) B: 4.75" (120.65)
	2-Gang, One Opening for 1-Gang Comm. Device Plate, One Blank Use with commercially available 1-gang flush plates. See page S-45 for plate options.	Ivory Gray	HBL4747C1IV HBL4747C1GY A: 5.12" (130.18) B: 4.75" (120.65)	2-Gang, One Opening for 2-Gang Commercial Device Plate Use with commercially available 2-gang flush plates. See page S-45 for plate options.	Ivory Gray	HBL4747C2IV HBL4747C2GY A: 5.12" (130.18) B: 4.75" (120.65)
	Device Mounting Bracket Mounting bracket for mounting Hubbell KP Plates, iSTATION Modules and Bezels. See pages S-45 and S-46 for datacom product selection.	Ivory Gray	HBL4750IV HBL4750GY A: 5.25" (133.35) B: 4.76" (120.90)			
2-Gang Cover Plates (Include Mounting Bracket)	2-Gang Cover, Single Round Opening, One Blank For single receptacle with face diameter of 1.38 in. to 1.39 in. (35.00 to 36.00).	Ivory Gray	HBL4747AXIV HBL4747AXGY A: 5.43" (137.97) B: 4.75" (120.65)	2-Gang, Single Round Opening, One Blank For single receptacle with face diameter of 1.56 in. to 1.58 in. (39.62 to 40.13).	Ivory Gray	HBL4747JXIV HBL4747JXGY A: 5.43" (137.97) B: 4.75" (120.65)
	2-Gang, One Duplex Opening, One Blank For 15A and 20A duplex receptacles and duplex communication frames shown on page S-45.	Ivory Gray	HBL4747BXIV HBL4747BXGY A: 5.43" (137.97) B: 4.75" (120.65)	2-Gang, One Style Line® Opening, One Blank For Style Line rectangular receptacles, GFCI and surge devices and rectangular communication frames shown on page S-45.	Ivory Gray	HBL4747RXIV HBL4747RXGY A: 5.43" (137.97) B: 4.75" (120.65)
	2-Gang, Two Duplex Openings For 15A and 20A duplex receptacles and duplex communication frames shown on page S-45.	Ivory Gray	HBL4747BBIV HBL4747BBGY A: 5.43" (137.97) B: 4.75" (120.65)	2-Gang, One Style Line® Opening, One Modular Furniture For Style Line rectangular receptacles, GFCI, surge devices and rectangular communication frames shown on page S-45. Includes modular furniture with two keystone twistouts.	Ivory Gray	HBL4747RFIV HBL4747RFGY A: 5.43" (137.97) B: 4.75" (120.65)
	2-Gang, One Duplex Opening, One Modular Furniture For 15A and 20A duplex receptacles and duplex communication frames shown on page S-45. Includes modular furniture with two keystone twistouts.	Ivory Gray	HBL4747BFIV HBL4747BFGY A: 5.43" (137.97) B: 4.75" (120.65)	2-Gang, One Duplex Opening, One Style Line® Opening For 15A and 20A duplex receptacles and Style Line rectangular receptacles, GFCI, surge devices and rectangular communication frames shown on page S-45.	Ivory Gray	HBL4747BRIV HBL4747BRGY A: 5.43" (137.97) B: 4.75" (120.65)
	2-Gang, One Duplex Opening, One Ortronics® Series II® Mini Adapter Bezel For 15A and 20A duplex recept. and duplex communication plates. Includes Ortronics® Series II® Mini Adapter Bezel.	Ivory Gray	HBL4747BSIV HBL4747BSGY A: 5.43" (137.97) B: 4.75" (120.65)	2-Gang, One Duplex Opening, One Ortronics® TracJack® Mini Adapter Bezel For 15A and 20A duplex recept. and duplex communication plates. Includes Ortronics® TracJack® Mini Adapter Bezel.	Ivory Gray	HBL4747BTIV HBL4747BTGY A: 5.43" (137.97) B: 4.75" (120.65)

Ortronics®, Series II® and TracJack® are registered trademarks of The Ortronics Company.

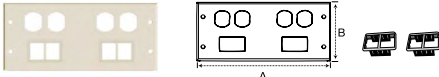
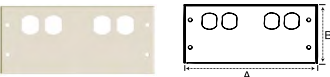
Dimensions in Inches (mm)

HBL4750 Series

4-Gang Cover Plates (Include Mounting Bracket)	Description	Color	Catalog Number	Description	Color	Catalog Number		
	4-Gang, Four Duplex Openings For 15A and 20A duplex receptacles and duplex communication frames shown on page S-45.	Ivory Gray	HBL47472BBBBIV HBL47472BBBBGY A: 10.22" (259.56) B: 4.75" (120.65)	4-Gang, Two Style Line® Openings, Two Blanks For Style Line rectangular receptacles, GFCI, surge devices and rectangular communication frames shown on page S-45. Includes two blanks.	Ivory Gray	HBL47472RRXXIV HBL47472RRXXGY A: 10.22" (259.56) B: 4.75" (120.65)		
		4-Gang, Two Duplex Openings, Two Style Line® Openings For 15A and 20A duplex receptacles. Includes Style Line openings for rectangular receptacles, GFCI, surge devices and rectangular communication frames shown on page S-45.	Ivory Gray	HBL47472BBRRIV HBL47472BBRRGY A: 10.22" (259.56) B: 4.75" (120.65)	4-Gang, Two Duplex Openings, Two Ortronics® Series II® Mini Adapter Bezels For 15A and 20A duplex receptacles and duplex communication plates. Includes two Ortronics® Series II® Mini Adapter Bezels.	Ivory Gray	HBL47472BBSSIV HBL47472BBSSGY A: 10.22" (259.56) B: 4.75" (120.65)	
		4-Gang, Two Duplex Openings, Two Modular Furniture For 15A and 20A duplex receptacles and duplex communication frames shown on page S-45. Includes two modular furniture with two keystone twistouts.	Ivory Gray	HBL47472BBFFIV HBL47472BBFFGY A: 10.22" (259.56) B: 4.75" (120.65)		4-Gang, Two Duplex Openings, Two Ortronics® TracJack® Mini Adapter Bezels For 15A and 20A duplex receptacles and duplex communication plates. Includes two Ortronics® TracJack® Mini Adapter Bezels.	Ivory Gray	HBL47472BBTTIV HBL47472BBTTGY A: 10.22" (259.56) B: 4.75" (120.65)
		4-Gang, Two Duplex Openings, Two Blanks For 15A and 20A duplex receptacles and duplex communication frames shown on page S-45. Includes two blanks.	Ivory Gray	HBL47472BBXXIV HBL47472BBXXGY A: 10.22" (259.56) B: 4.75" (120.65)				
								

Tools	Description	Color	Catalog Number	Description	Catalog Number	
	Base Cutter Cutter for cutting base of HBL4750 Raceway.			HBL640B	Cover Cutter Cutter for cutting cover of HBL4750 Raceway.	HBL640C
						
	Replacement Blade Cutter and Die Set Base blade set.			HBL640BDK	Replacement Blade Cutter and Die Set Cover blade set.	HBL640CDK
						
Touch-Up Paint Pen	Ivory Gray	HBLIWEP HBLGWEP				
						

Dimensions in Inches (mm)

Ortronics®, Series II® and TracJack® are registered trademarks of The Ortronics Company.

Metal Raceway

Products at a Glance



HBL6750 Device Bracket

- HBL6750 Device Bracket Plate provides excellent solution for three channel power, data, voice, audio and video applications
- For use with Hubbell KP plates and Hubbell iSTATION Modules and Bezels
- Provides flush finish with overlap feature to hide potential miscuts

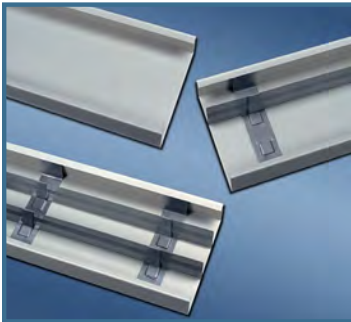

Maximum Capacity

- HBL6750 Series options include single channel (no divider), two channel (1/3, 2/3 divider) or three channel (1/3, 1/3, 1/3 divider)
- HBL6750 Series offers maximum capacity in a low profile raceway
- HBL6750, two channel version, features industry leading capacity equivalent to a HBL4750 single channel profile with an additional channel
- Low profile raceway provides a less conspicuous profile than competitive versions
- Available in 10 ft. (3m) lengths

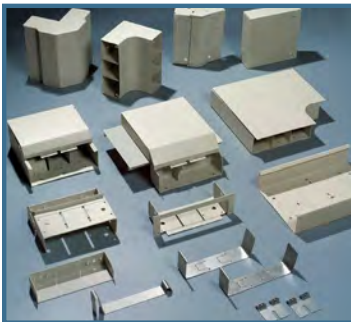

Unique Line of Fittings

- 1¼ in. (31.75mm) bend radius fittings meet TIA/EIA requirements
- Integral bend radius offers a fixed solution that does not have to be field installed
- Large cross sectional area provides for maximum cable capacity throughout entire system
- Available external, internal, flat, tee and entrance end fittings
- UL Listed, CSA Certified
- Available in ivory or gray powder coat finish





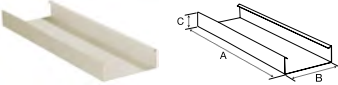
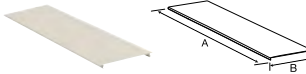

Plates and Covers

- Wide variety of overlapping cover plates provide flexibility for power, data, voice, audio and video applications
- Available in both three and six-gang options
- Cover plates accept wide selection of Hubbell iSTATION Modules and Bezels
- Cover plates help to conceal unsightly gaps caused by miscuts
- Precut cover options allow for 12 in. (304.80mm), 18 in. (457.20mm), 24 in. (609.60mm) and 36 in. (914.40mm) "on-center" mounting
- Open System architecture available

HBL6750 Series

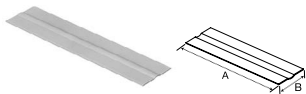
HBL6750 Series	Description	Color	Catalog Number	Description	Color	Catalog Number
	Single Channel Base Packed 20 ft. (6.1m) per carton, 10 ft. (3m) lengths. Assembled cover and base dimensions: W: 6.75" (171.45) H: 2.22" (56.39)	Ivory Gray	HBL6750B10IV HBL6750B10GY A: 120.00" (3048.00) B: 6.75" (171.45) C: 2.12" (53.85)	5 Ft. Cover Packed 20 ft. (6.1m) per carton, 5 ft. (1.5m) lengths.	Ivory Gray	HBL6750CIV HBL6750CGY A: 60.00" (1,524.0) B: 6.75" (171.45)
		31 In. Precut Cover* For 36 in. (915.00) centers with HBL6747 and HBL6750 Plates.	Ivory Gray	HBL6750C315IV HBL6750C315GY A: 31.50" (800.10) B: 6.75" (171.45)		
		19 In. Precut Cover* For 24 in. (610.00) centers with HBL6747 and HBL6750 Plates.	Ivory Gray	HBL6750C195IV HBL6750C195GY A: 19.50" (495.30) B: 6.75" (171.45)		
		13 In. Precut Cover* For 18 in. (457.00) centers with HBL6747 and HBL6750 Plates.	Ivory Gray	HBL6750C135IV HBL6750C135GY A: 13.50" (342.90) B: 6.75" (171.45)		
		7 In. Precut Cover* For 12 in. (305.00) centers with HBL6747 and HBL6750 Plates.	Ivory Gray	HBL6750C075IV HBL6750C075GY A: 7.50" (190.50) B: 6.75" (171.45)		
						

Note: *Packed 10 pieces per carton. Device centers vary based on cover selection. Consult factory for details.

Fittings	Description	Color	Catalog Number	Description	Color	Catalog Number	
	Divider Divides HBL6750 Raceway into two or three channels. Packed 50 ft. (15.24m) per carton, 5 ft. (1.5m) lengths. HBL6751DAGY Divider Clips are required to hold divider in place.	Painted Steel	HBL6750DAGY A: 60.00" (1524.00) B: 2.03" (51.56)	Wire Clip (Plated) For holding conductors in place.	Steel**	HBL6750WCGY A: 6.61" (167.80) B: 2.09" (53.05)	
		Divider Clip (Plated) Required for holding HBL6750DAGY in place. Use one every 2.5 ft. (.762m).	Steel**	HBL6751DAGY A: 6.60" (167.67) B: 1.97" (50.10)	Coupling (Plated) For joining lengths of HBL6750 Raceway. Sold in pairs.	Steel**	HBL6751A A: 2.00" (50.71) B: .42" (10.59)
			Internal Corner Coupling (Plated) Concealed fitting for making an internal corner while continuing original run in a straight line.	Steel**	HBL6717TCAGY A: 6.56" (166.62) B: 1.94" (49.28)		
							

Note: **Galvanized Steel.

Dimensions in Inches (mm)

HBL6750 Series

Elbows	Description	Color	Catalog Number	Description	Color	Catalog Number	
	Internal Elbow, Divided For inside surface at right angles. Full capacity 1¼ in. bend radius internal elbow.	Ivory Gray	HBL6717DFOIV* HBL6717DFOGY* A: 4.74" (120.47) B: 6.75" (171.45)	Internal Elbow, Undivided For inside surface at right angles.	Ivory Gray	HBL6717IV* HBL6717GY* A: 4.74" (120.47) B: 6.75" (171.45)	
		External Elbow, Divided For right angle turns around external corners. Full capacity 1¼ in. bend radius external elbow.	Ivory Gray	HBL6718DFOIV* HBL6718DFOGY* A: 5.83" (148.21) B: 6.75" (171.45)	External Elbow, Undivided For right angle turns around external corners.	Ivory Gray	HBL6718IV* HBL6718GY* A: 5.83" (148.21) B: 6.75" (171.45)
		Flat Elbow, Divided For right angle turns on same surface. Full capacity 1¼ in. bend radius flat elbow.	Ivory Gray	HBL6711DFOIV* HBL6711DFOGY* A: 9.23" (234.45) B: 6.75" (171.45) C: 2.14" (54.23) D: 9.83" (249.69) E: 6.75" (171.45)	Flat Elbow, Undivided For right angle turns on same surface.	Ivory Gray	HBL6711IV* HBL6711GY* A: 9.23" (234.45) B: 6.75" (171.45) C: 2.14" (54.23) D: 9.83" (249.69) E: 6.75" (171.45)
		Internal or External 45° Elbow For making internal or external turns in a run of HBL6750 Raceway.	Ivory Gray	HBL6712TXIV HBL6712TXGY A: 6.53" (165.93) B: 6.56" (166.62)	Inverted Internal Elbow For connecting a vertical run of HBL6750 Raceway with a horizontal run.	Ivory Gray	HBL6717NIV HBL6717NGY A: 6.56" (166.62) B: 5.13" (130.30)

Tees	Description	Color	Catalog Number	Description	Color	Catalog Number
	Tee Fitting, Divided For branches at right angles. Full capacity 1¼ in. bend radius tee fitting.	Ivory Gray	HBL6715DFOIV* HBL6715DFOGY* A: 8.75" (222.25) B: 6.63" (168.40) C: 3.56" (90.48) D: 7.92" (201.07) E: 6.75" (171.45)	Tee Fitting, Undivided For branches at right angles.	Ivory Gray	HBL6715IV* HBL6715GY* A: 8.75" (222.25) B: 6.63" (168.40) C: 3.56" (90.48) D: 7.92" (201.07) E: 6.75" (171.45)

Note: *HBL6751A couplings included.

Dimensions in Inches (mm)

HBL6750 Series

End Fittings	Description	Color	Catalog Number	Description	Color	Catalog Number
	<p>Entrance End Fitting, Divided For connecting HBL6750 Raceway with rigid or flexible conduit. Concentric ¼ in., 1 in. and 1¼ in. trade size KOs on back and end. Full capacity 1¼ in. bend radius entrance end fitting. Includes ¼ in., 1 in. and 1¼ in. KO and removable dividers.</p>	Ivory Gray	HBL6710DFOIV* HBL6710DFOGY* A: 6.75" (171.45) B: 6.75" (171.45) C: 3.18" (80.71)	<p>Entrance End Fitting, Undivided For connecting HBL6750 Raceway with rigid or flexible conduit. Concentric ¼ in., 1 in. and 1¼ in. trade size KOs on back and end.</p>	Ivory Gray	HBL6710IV* HBL6710GY* A: 6.75" (171.45) B: 6.75" (171.45) C: 3.18" (80.71)
<p>Blank End Fitting For closing open end of HBL6750 Raceway. Has three ½ in. trade size KOs.</p>	Ivory Gray	HBL6710BIV HBL6710BGY A: 6.56" (166.62) B: 1.98" (50.41) C: 1.33" (33.90)	<p>Panel Connector To connect HBL6750 Raceway with surface type panel boxes.</p>	Ivory Gray	HBL6786IV HBL6786GY A: 7.51" (190.86) B: 2.00" (50.83) C: 7.89" (200.37) D: 2.38" (60.34)	

Fittings	Description	Color	Catalog Number	Description	Color	Catalog Number
	<p>Transition Fitting For transitioning from Wiremold® 6000 Raceway to Hubbell HBL6750 Raceway.</p>	Ivory Gray	HBL6750TFIV HBL6750TFGY A: 4.35" (110.42) B: 6.96" (176.87)	<p>Wall Box Connector For back feeding HBL6750 Raceway.</p>	Ivory Gray	HBL6714AIV HBL6714AGY A: 6.75" (171.45) B: 2.14" (54.28) C: 9.90" (251.46)
<p>Take-Off Connector (HBL6750-HBL4750) For 90° tee connection of HBL4750 Raceway from HBL6750 Raceway.</p>	Ivory Gray	HBL6774AIV HBL6774AGY A: 14.36" (364.76) B: 6.75" (171.45) C: 11.47" (291.29) D: 6.72" (170.69)	<p>3-Gang Tap-Off Fitting Has six concentric ½ in. and ¾ in. trade size KOs.</p>	Ivory Gray	HBL6746HHHIV HBL6746HHHGY A: 4.35" (110.42) B: 6.96" (176.87)	
<p>Connection Cover For covering potential openings where two covers come together.</p>	Ivory Gray	HBL6756AIV HBL6756AGY A: 6.75" (171.45) B: .59" (14.89)				

Note: *HBL4751AC couplings included.

HBL6750 Series

	Description	Color	Catalog Number	Description	Color	Catalog Number
Device Plates & Mounting Bracket	3-Gang, One Opening for 1-Gang Commercial Device Plate, Two Blanks Use with commercially available 1-gang flush plates. See page S-45 for plate options.	Ivory Gray	HBL6747C1IV HBL6747C1GY A: 5.43" (137.97) B: 6.75" (171.45)	3-Gang, One Opening for 2-Gang Commercial Device Plate, One Blank Use with commercially available 2-gang flush plates. See page S-45 for plate options.	Ivory Gray	HBL6747C2IV HBL6747C2GY A: 5.43" (137.97) B: 6.75" (171.45)
	Device Mounting Bracket Mounting bracket for mounting Hubbell KP Plates, iSTATION Modules and Bezels. See pages S-45 and S-46 for datacom product selection.	Ivory Gray	HBL6750IV HBL6750GY A: 5.25" (133.35) B: 6.75" (171.45)			
3-Gang Cover Plates (Include Mounting Bracket)	3-Gang, One Duplex Opening, Two Blanks For 15A and 20A duplex receptacles and duplex communication plates.	Ivory Gray	HBL6747BXXIV HBL6747BXXGY A: 5.43" (137.97) B: 6.75" (171.45)	3-Gang, One Single Round Opening, Two Blanks For single receptacle with face diameter of 1.38 in. to 1.39 in. (35.05 to 35.31).	Ivory Gray	HBL6747AXXIV HBL6747AXXGY A: 5.43" (137.97) B: 6.75" (171.45)
	3-Gang, Three Duplex Openings For 15A and 20A duplex receptacles and duplex communication plates.	Ivory Gray	HBL6747BBBIV HBL6747BBBGY A: 5.43" (137.97) B: 6.75" (171.45)	3-Gang, One Single Round Opening, Two Blanks For single receptacle with face diameter of 1.56 in. to 1.58 in. (39.62 to 40.13).	Ivory Gray	HBL6747JXXIV HBL6747JXXGY A: 5.43" (137.97) B: 6.75" (171.45)
	3-Gang, One Duplex Opening, Two Style Line® Openings For 15A and 20A duplex receptacles and duplex communication plates. Includes Style Line openings for rectangular receptacles, GFCI, surge devices and rectangular communication frames shown on page S-45.	Ivory Gray	HBL6747BRRIV HBL6747BRRGY A: 5.43" (137.97) B: 6.75" (171.45)	3-Gang, One Style Line® Opening, Two Blanks For one Style Line rectangular receptacle, GFCI, surge device or rectangular communication device.	Ivory Gray	HBL6747RXXIV HBL6747RXXGY A: 5.43" (137.97) B: 6.75" (171.45)
	3-Gang, Two Duplex Openings, One Modular Furniture For 15A and 20A duplex receptacles and duplex communication frames shown on page S-45. Includes modular furniture with two keystone twistouts.	Ivory Gray	HBL6747BBFIV HBL6747BBFGY A: 5.43" (137.97) B: 6.75" (171.45)	3-Gang, Two Style Line® Openings, One Modular Furniture For two Style Line rectangular receptacles, GFCI, surge devices and rectangular communication frames shown on page S-45. Includes modular furniture with two keystone twistouts.	Ivory Gray	HBL6747RRFIV HBL6747RRFGY A: 5.43" (137.97) B: 6.75" (171.45)
	3-Gang, Two Duplex Openings, One Ortronics® Series II® Mini Adapter Bezel For two 15A and 20A duplex receptacles and duplex communication frames shown on page S-45. Includes Ortronics® Series II® Mini Adapter Bezel.	Ivory Gray	HBL6747BBSIV HBL6747BBSGY A: 5.43" (137.97) B: 6.75" (171.45)	3-Gang, Two Duplex Openings, One Ortronics® TracJack® Mini Adapter Bezel For 15A and 20A duplex receptacles and duplex communication frames shown on page S-45. Includes Ortronics® TracJack® Mini Adapter Bezel.	Ivory Gray	HBL6747BBTIV HBL6747BBTGY A: 5.43" (137.97) B: 6.75" (171.45)

Ortronics®, Series II® and TracJack® are registered trademarks of The Ortronics Company.

Dimensions in Inches (mm)

HBL6750 Series

6-Gang Cover Plates (Include Mounting Bracket)	Description	Color	Catalog Number	Description	Color	Catalog Number
	6-Gang, Six Duplex Openings For 15A and 20A duplex receptacles and duplex communication frames shown on page S-45.	Ivory Gray	HBL67473BBBBBIV HBL67473BBBBBBGY A: 10.22" (259.56) B: 6.75" (171.45)	6-Gang, Four Style Line® Openings, Two Blanks For four Style Line rectangular receptacles, GFCI, surge devices and rectangular communication frames shown on page S-45.	Ivory Gray	HBL67473RRRRXXIV HBL67473RRRRXXGY A: 10.22" (259.56) B: 6.75" (171.45)
	6-Gang, Two Duplex Openings, Four Style Line® Openings For 15A and 20A duplex receptacles and duplex communication frames shown on page S-45. Includes Style Line openings for rectangular receptacles, GFCI, surge devices and rectangular communication devices.	Ivory Gray	HBL67473BBRRRRIV HBL67473BBRRRRGY A: 10.22" (259.56) B: 6.75" (171.45)	6-Gang, Four Duplex Openings, Two Ortronics® Series II® Mini Adapter Bezels For 15A and 20A duplex receptacles and duplex communication frames shown on page S-45. Includes two Ortronics® Series II® Mini Adapter Bezels.	Ivory Gray	HBL67473BBBBSSIV HBL67473BBBBSSGY A: 10.22" (259.56) B: 6.75" (171.45)
	6-Gang, Four Duplex Openings, Two Modular Furniture For 15A and 20A duplex receptacles and duplex communication frames shown on page S-45. Includes two modular furniture with two keystone twistouts.	Ivory Gray	HBL67473BBBBFFIV HBL67473BBBBFFGY A: 10.22" (259.56) B: 6.75" (171.45)	6-Gang, Four Duplex Openings, Two Ortronics® TracJack® Mini Adapter Bezels For 15A and 20A duplex receptacles and duplex communication frames shown on page S-45. Includes two Ortronics® TracJack® Mini Adapter Bezels.	Ivory Gray	HBL67473BBBBTTIV HBL67473BBBBTTGY A: 10.22" (259.56) B: 6.75" (171.45)
6-Gang, Four Duplex Openings, Two Blanks For four 15A and 20A duplex receptacles and duplex communication frames shown on page S-45.	Ivory Gray	HBL67473BBBBXXIV HBL67473BBBBXXGY A: 10.22" (259.56) B: 6.75" (171.45)				

Tools	Description	Color	Catalog Number	Description	Catalog Number	
	Base Cutter Cutter for cutting base of HBL6750 Raceway.			HBL660B	Cover Cutter Cutter for cutting cover of HBL6750 Raceway.	HBL660C
	Replacement Blade Cutter and Die Set Base blade set.			HBL660BDK	Replacement Blade Cutter and Die Set Cover blade set.	HBL660CDK
Touch-Up Paint Pen	Ivory Gray	HBLIWEP HBLGWEP				

Dimensions in Inches (mm)

Ortronics®, Series II® and TracJack® are registered trademarks of The Ortronics Company.

Aluminum Raceway

Products at a Glance

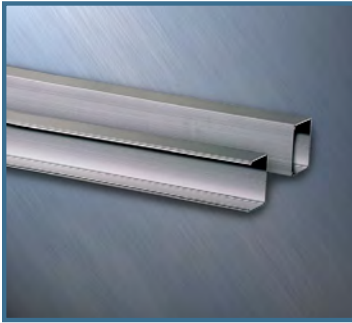

HBLALU2000 Series

- Single channel aluminum raceway
- Satin anodized finish
- Resists oxidation, corrosion and fading
- Can be installed as recessed or surface mounted
- UL Listed and CSA Certified



Aluminum Boxes

- Both in-line and standard boxes available
- Hubbell Handy-Screw® eliminates difficult to install long screws for easier installation
- Rounded corners eliminate sharp edges
- One seam construction provides “clean” look
- Box design allows standard wallplates to be mounted flush with virtually no perimeter profile exposed
- Full line of metal wallplates available. See section O for selection



Wide Selection of Fittings

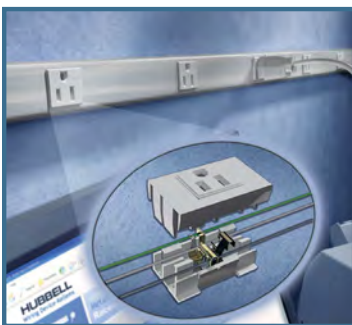

- Elbows (external, internal, flat) and tee fitting available to accommodate all types of applications
- HBLALU2001 Coupling included with elbows and tee fitting



Aluminum PlugTrak® Featuring Exclusive Receptacle Design



- Satin anodized scratch resistant finish
- Multiple spacing configurations
- Hubbell designed and manufactured single receptacle
- Insulation displacement wiring provides superior wire retention
- Mates with HBLALU2000 Aluminum Raceway
- Available in 3 ft. (0.9m), 5 ft. (1.5m) and 6 ft. (1.8m) lengths
- Tamper-Resistant versions available

HBLALU2000 Series

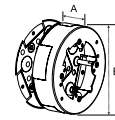
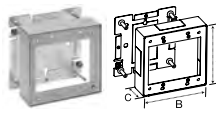
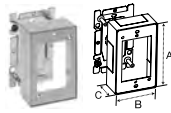
HBLALU2000 Series	Description	Material	Catalog Number	Description	Material	Catalog Number	
	5 Ft. Base Satin anodized finish. Packed 60 ft. (18.3m) per carton, 5 ft. (1.5m) lengths.	Anodized Aluminum	HBLALU2000B5	A: .82" (21.00) B: 1.84" (46.74)	Cover Satin anodized finish. Packed 60 ft. (18.3m) per carton, 5 ft. (1.5m) lengths. 	Anodized Aluminum	HBLALU2000C5
10 Ft. Base Satin anodized finish. Packed 60 ft. (18.3m) per carton, 10 ft. (3m) lengths.	Anodized Aluminum	HBLALU2000B10	A: .82" (21.00) B: 1.84" (46.74)				
Assembled cover and base dimensions. W: 1.84" (46.74) H: .91" (23.11) 							

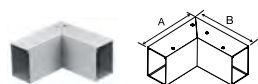
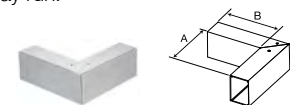

Standard	Description	Material	1-Gang	2-Gang	Description	Material	Round Box	
	Device Box For standard switches and receptacles.	Anodized Aluminum	HBLALU2047	A: 4.54" (115.32) B: 2.82" (71.63) C: 1.38" (35.05)	HBLALU20472	A: 4.54" (115.32) B: 4.64" (117.86) C: 1.38" (35.05)	Anodized Aluminum	HBLALU2038
Deep For deep switches and receptacles.	Anodized Aluminum	HBLALU2044	A: 4.54" (115.32) B: 2.82" (71.63) C: 2.25" (57.15)	HBLALU20442	A: 4.54" (115.32) B: 4.64" (117.86) C: 2.75" (69.85)	Fixture Box with Solid Base To hang fixtures. Cover takes any device with mounting screw centers of 2.75 in. (69.85), 3.5 in. (89.00) and 4.06 in. (103.00).		
Base Trade Size KO's			1 - 1/2", 3/4" Concentric	1 - 1/2"				
			1 - Rectangular	1 - Rectangular				

Elbows and Tees	Description	Material	Catalog Number	Description	Material	Catalog Number	
	Internal Elbow For making a 90° internal turn in a raceway run. 	Anodized Aluminum	HBLALU2017*	A: 3.00" (76.20) B: 3.00" (76.20)	External Elbow For making a 90° external turn in a raceway run. 	Anodized Aluminum	HBLALU2018*
Flat Elbow For making a 90° flat turn in a raceway run. 	Anodized Aluminum	HBLALU2011*	A: 3.00" (76.20) B: 3.00" (76.20)	Tee Fitting For branch connections of right angles. 	Anodized Aluminum	HBLALU2015*	A: 4.00" (101.60) B: 3.40" (86.36)

Note: *HBLALU2001 couplings included.

Dimensions in Inches (mm)

HBLALU2000 Series

	Description	Material	Catalog Number	Description	Material	Catalog Number
End Fittings	Entrance End Fitting ½ in. NPT steel fitting.	Anodized Aluminum Plate	HBLALU2010A A: 1.84" (47.74) B: .91" (23.11) C: 1.51" (38.35)	Blank End Fitting For closing end of raceway.	Anodized Aluminum	HBLALU2010B A: 1.84" (46.74) B: .91" (23.11)

	Description	Material	Catalog Number	Description	Material	Catalog Number
Fittings	Cover Clip Use to cover potential openings where two pieces of HBLALU2000 Raceway cover come together.	Stainless Steel	HBLALU2006 A: 1.00" (25.40)	Wire Clip For holding conductors in place.	Anodized Aluminum	HBLALU2000WC A: .44" (11.20)
	Flush Plate Adaptor For feeding HBL2000 Raceway from an existing wall outlet. Locknut included.	Anodized Aluminum	HBLALU2051H A: 4.50" (114.3) B: 4.50" (114.3)	Coupling (Pair) For joining lengths of HBLALU2000 Raceway.	Aluminum	HBLALU2001 A: 1.67" (42.42) B: 1.67" (42.42)

	Description	Material	Catalog Number	Description	Material	Catalog Number
Devices and In-Line Fittings	In-Line Switch Fitting (Switch sold separately).	Anodized Aluminum	HBLALU2040A A: 4.12" (104.65) B: 1.84" (46.74)	Ground Adapter (Plated) For connection of equipment grounding conductor to provide an additional ground to raceway. Screws included.	Steel**	HBLALU2009 A: 2.35" (59.8) B: 1.18" (30.0)
	Supporting Clip For mounting lengths of HBLALU2000 Raceway at any point. Mount with #6 flat head fastener. Has set screw for locking to raceway. Raceway must be screwed to the wall for secure fastening.	Stainless Steel	HBLALU2003 A: 2.00" (50.80)			

Note: *HBLALU2001 couplings included.
**Galvanized Steel.

Dimensions in Inches (mm)

Aluminum Raceway



Aluminum PlugTrak® Series

Available in Standard, Isolated Ground (IG), Tamper-Resistant (TR) and USB (U) versions.

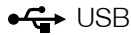

Tamper-Resistant

	Amp Circuits	Single Recept.	USB Ports	Receptacle Spacing (in.)	Catalog Number
3 Foot	15 Single	6	—	6	HBLALU20GB306
	15 IG/Single	6	—	6	HBLALU20IG306
	15 TR/Single	6	—	6	HBLALU20GB306TR
	15 USB/Single	2	2	12	HBLALU20GB312U
	20 Single	6	—	6	HBLALU24GB306
	20 IG/Single	6	—	6	HBLALU24IG306
	20 TR/Single	6	—	6	HBLALU24GB306TR
5 Foot	15 Single	10	—	6	HBLALU20GB506
	15 Single	5	—	12	HBLALU20GB512
	15 IG/Single	10	—	6	HBLALU20IG506
	15 TR/Single	5	—	12	HBLALU20GB512TR
	20 Single	10	—	6	HBLALU24GB506
	20 Single	5	—	12	HBLALU24GB512
	20 TR/Single	5	—	12	HBLALU24GB512TR
6 Foot	15 Single	12	—	6	HBLALU20GB606
	15 Single	6	—	12	HBLALU20GB612
	15 Single	4	—	18	HBLALU20GB618
	15 Two	12	—	6	HBLALU20GBA606
	15 Two	6	—	12	HBLALU20GBA612
	15 Two	4	—	18	HBLALU20GBA618
	15 IG/Single	12	—	6	HBLALU20IG606
	15 USB/Single	4	4	12	HBLALU20GB612U
	20 Single	12	—	6	HBLALU24GB606
	20 Single	6	—	12	HBLALU24GB612
	20 Single	4	—	18	HBLALU24GB618
	20 Two	12	—	6	HBLALU24GBA606
	20 Two	6	—	12	HBLALU24GBA612
20 Two	4	—	18	HBLALU24GBA618	
20 IG/Single	12	—	6	HBLALU24IG606	

	Description	Catalog Number
Device Boxes	Standard 1-Gang Device Box	HBLALU2047
	Deep 1-Gang Device Box	HBLALU2044
	Standard 2-Gang Device Box	HBLALU20472
	Deep 2-Gang Device Box	HBLALU20442
	Round Box	HBLALU2038
	Elbows and Tees	External Elbow
Internal Elbow		HBLALU2017
Flat Elbow		HBLALU2011
Tee		HBLALU2015
Fittings	Cover Clip	HBLALU2006
	Supporting Clip	HBLALU2003
	Coupling	HBLALU2001
	Entrance End Fitting	HBLALU2010A
	In-Line Switch Fitting	HBLALU2040A
	Blank End Fitting	HBLALU2010B

Note: See pages S-34 and S-35 for additional information.

Note: IG = Isolated Ground, TR = Tamper-Resistant and U = USB. Hubbell Aluminum PlugTrak is supplied with two HBLALU2010B blank end fittings and one HBLALU2001 coupling.

Dimensions in Inches (mm)

Aluminum Raceway

Products at a Glance



HBLALU3800 and HBLALU4800 Series

- Single and two channel aluminum raceways
- Satin anodized finish
- Resists oxidation, corrosion and fading
- Can be installed as recessed or surface mounted
- UL Listed and CSA Certified



Split Covers

- Single and two channel raceways utilize common cover
- Split covers allow access to one service at a time
- Common aesthetics throughout line

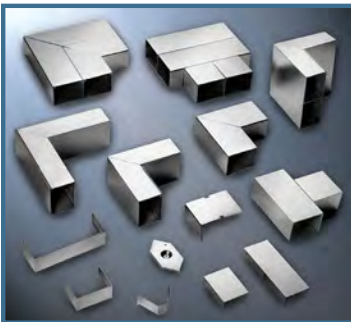

Wide Selection of Fittings

- External, internal, flat and tee fittings available to accommodate all types of applications
- Available in both single and two channel versions



Device Cover Plates

- Cover plates can be used for both HBLALU3800 and HBLALU4800 Raceways
- Cover plates offer option for most common power device applications
- Low profile bezel cover accommodates Hubbell iSTATION Modules
- Open System data option available
- Base mounted cover plates available for added strength

HBLALU3800 Series

HBLALU3800 Series	Description	Material	Catalog Number	Description	Material	Catalog Number	
	Single Channel Base Satin anodized finish. Packed 40 ft. (12.19m) per carton, 10 ft. (3m) lengths. Assembled cover and base dimensions. W: 3.00" (76.20) H: 2.25" (57.15)	Anodized Aluminum	HBLALU3800B10	A: 2.10" (53.34) B: 3.00" (76.20)	Cover Satin anodized finish. Packed 40 ft. (12.19m) per carton, 5 ft. (1.5m) lengths.	Anodized Aluminum	HBLALUC5

Elbows and Tees	Description	Material	Catalog Number	Description	Material	Catalog Number		
	Internal Elbow For making a 90° internal turn in a raceway run.	Anodized Aluminum	HBLALU3817*	A: 6.00" (152.40) B: 6.00" (152.40)	Inverted Internal Elbow For connecting a vertical run of HBLALU3800 with a horizontal run with its cover facing up.	Anodized Aluminum	HBLALU3817N*	A: 6.00" (152.40) B: 5.98" (151.89)
	External Elbow For making a 90° external turn in a raceway run.	Anodized Aluminum	HBLALU3818*	A: 6.00" (152.40) B: 6.00" (152.40)	Tee For branch connections of two runs of HBLALU3800 Raceway.	Anodized Aluminum	HBLALU3815*	A: 6.00" (152.40) B: 6.00" (152.40)
	Flat Elbow For making a 90° flat turn in a raceway run.	Anodized Aluminum	HBLALU3811*	A: 6.00" (152.40) B: 6.00" (152.40)				

End Fittings	Description	Material	Catalog Number	Description	Material	Catalog Number	
	Entrance End Fitting For feeding raceway, has concentric ½ in. and ¾ in. trade size KOs.	Anodized Aluminum	HBLALU3810B1	A: 3.00" (76.20) B: 2.31" (58.74)	Blank End Fitting For closing end of raceway.	Anodized Aluminum	HBLALU3810B

Fittings	Description	Material	Catalog Number	Description	Material	Catalog Number		
	Cover Clip To cover seam where lengths of HBLALU3800 Raceway come together.	Stainless Steel	HBLALU3806	A: 1.38" (34.92)	Wire Clip For holding conductors in place. Can be used for either HBLALU3800 or HBLALU4800 Raceway.	Anodized Aluminum	HBLALUWC	A: 1.00" (25.40)
	Internal Corner Coupling For butting two raceway sections to form an internal 90° turn in a raceway run.	Anodized Aluminum	HBLALU17A	A: 4.00" (101.80) B: 2.00" (50.83)	Grounding Adapter For connection of equipment grounding. #10-32 Locking screws included.	Galvanized Steel	HBLALU09	A: 4.00" (101.80) B: 2.00" (50.83)
Couplings (Pair) To join lengths of HBLALU3800 or HBLALU4800 base.	Aluminum	HBLALU01	A: 2.85" (72.39) B: 4.00" (101.80)					

Note: *HBLALU01 couplings included.
See page S-40 for cover plates.

Dimensions in Inches (mm)

HBLALU4800 Series



HBLALU4800 Series	Description	Material	Catalog Number	Description	Material	Catalog Number
	Two Channel Base Satin anodized finish. Packed 40 ft. (12.19m) per carton, 10 ft. (3m) lengths. Assembled cover and base dimensions. W: 6.00" (152.40) H: 2.25" (57.15)	Anodized Aluminum	HBLALU4800B10 A: 2.10" (53.34) B: 6.00" (152.40)	Cover (Single Channel) Satin anodized finish. Packed 40 ft. (12.19m) per carton, 5 ft. (1.5m) lengths.	Anodized Aluminum	HBLALUC5 A: 3.00" (76.20)

	Description	Material	Catalog Number	Description	Material	Catalog Number
Elbows and Tees	Internal Elbow (Two Channel) For making a 90° internal turn in a raceway run.	Anodized Aluminum	HBLALU4817* A: 6.00" (152.40) B: 6.00" (152.40)	Inverted Internal Elbow (Two Channel) For connecting a vertical run of HBLALU4800 with a horizontal run with its cover facing up.	Anodized Aluminum	HBLALU4817N* A: 6.00" (152.40) B: 5.98" (151.89)
	External Elbow (Two Channel) For making a 90° external turn in a raceway run.	Anodized Aluminum	HBLALU4818* A: 6.00" (152.40) B: 6.00" (152.40)	Tee (Two Channel) For branch connections of two runs of HBLALU4800 Raceway.	Anodized Aluminum	HBLALU4815* A: 9.00" (228.60) B: 9.00" (228.60)
	Flat Elbow (Two Channel) For making a 90° flat turn in a raceway run.	Anodized Aluminum	HBLALU4811* A: 9.00" (228.60) B: 9.00" (228.60)			
End Fittings	Entrance End Fitting (Two Channel) For feeding raceway, has two concentric ½ in. and ¾ in. trade size KOs.	Anodized Aluminum	HBLALU4810B2 A: 6.00" (152.40) B: 2.31" (58.74)	Blank End Fitting (Two Channel) For closing end of raceway.	Anodized Aluminum	HBLALU4810B A: 6.00" (152.40) B: 2.31" (58.74)
	Fittings	Cover Clip To cover seam where lengths of HBLALU4800 Raceway come together.	Stainless Steel	HBLALU4806 A: 1.38" (34.92)	Wire Clip Used for holding conductors in place on raceway. Can be used for either HBLALU3800 or HBLALU4800 Raceway.	Anodized Aluminum
Internal Corner Coupling For butting two raceway sections to form an internal 90° turn in a raceway run.		Anodized Aluminum	HBLALU17A A: 4.00" (101.80) B: 2.00" (50.83)	Grounding Adapter For connection of equipment grounding. #10-32 Locking screws included.	Galvanized Steel	HBLALU09 A: 4.00" (101.80) B: 2.00" (50.83)
Couplings (Pair) To join lengths of HBLALU3800 or HBLALU4800 base.		Aluminum	HBLALU01 A: 2.85" (72.39) B: 4.00" (101.80)			

Note: *HBLALU01 couplings included.
See page S-40 for cover plates.

Dimensions in Inches (mm)

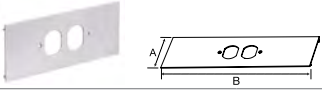
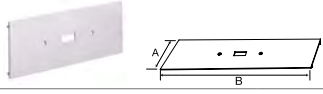
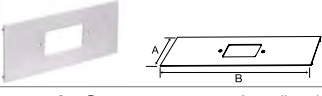
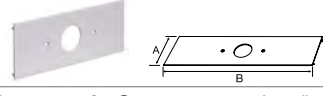
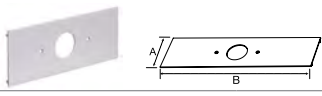
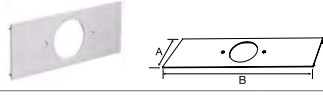
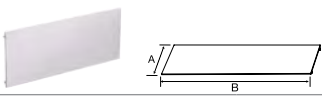
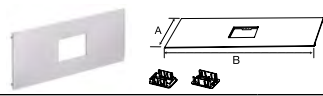
HBLALU3800 and HBLALU4800 Series

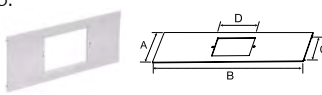
Cover Plates	Description	Material	Catalog Number	Description	Material	Catalog Number	
	Duplex Receptacle Cover For duplex receptacles and duplex communication frames shown on page S-45.	Anodized Aluminum	HBLALUDR A: 3.00" (76.20) B: 12.00" (304.80)	HBLALU34DRBM (Base Mounted Device)	Toggle Switch Cover For single pole, two pole, three way or four way switches.	Anodized Aluminum	HBLALUN A: 3.00" (76.20) B: 12.00" (304.80)
							HBLALU34NBM (Base Mounted Device)
	Rectangular Style Line® Cover For Style Line rectangular duplex receptacle, GFCI, surge device or rectangular communication frames shown on page S-45.	Anodized Aluminum	HBLALUG A: 3.00" (76.20) B: 12.00" (304.80)	HBLALU34GBM (Base Mounted Device)	Single Receptacle Cover For single receptacle with face diameters of 1.38 in. to 1.39 in. (35.05 to 35.31).	Anodized Aluminum	HBLALUE A: 3.00" (76.20) B: 12.00" (304.80)
							HBLALU34EBM (Base Mounted Device)
	Single Receptacle Cover For single receptacle with face diameters of 1.56 in. to 1.59 in. (39.62 to 40.39).	Anodized Aluminum	HBLALUF A: 3.00" (76.20) B: 12.00" (304.80)	HBLALU34FBM (Base Mounted Device)	Single Receptacle Cover For single receptacle with face diameter of 2.13 in. (54.10).	Anodized Aluminum	HBLALUJ A: 3.00" (76.20) B: 12.00" (304.80)
						HBLALU34JBM (Base Mounted Device)	
Blank Cover To cover 12 in. (305.00) section of raceway.	Anodized Aluminum	HBLALUBL A: 3.00" (76.20) B: 12.00" (304.80)		Ortronics® Cover Plate For two Ortronics TracJack® or one Series II® datacom insert. Both bezels included.	Anodized Aluminum	HBLALUABRT A: 3.00" (76.20) B: 12.00" (304.80)	
							
Hubbell iSTATION Cover For mounting Hubbell iSTATION Modules. For the HBLALULPB use the KPIMBZGY on page S-45 with modules from page S-46. For the HBLALULPBA use the IMF1GY on page S-46 or any IFPxxGY plates on page S-45.	Anodized Aluminum	HBLALULPB A: 3.00" (76.20) B: 12.00" (304.80) C: 1.90 (48.26) D: 4.21 (106.93)	HBLALULPBA A: 3.00" (76.20) B: 12.00" (304.80) C: 1.90 (48.26) D: 3.00" (76.20)				
							

Base Mounted Device Cover Design

No exposed screw holes. Receptacle is securely mounted to the raceway base rather than the cover.

Dimensions in Inches (mm)

Ortronics®, Series II® and TracJack® are registered trademarks of The Ortronics Company.

Aluminum Raceway

Products at a Glance

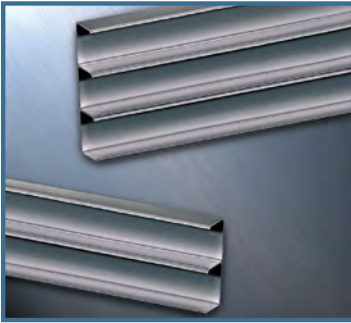

HBLALU5000 and HBLALU7620 Series

- Two and three channel aluminum raceways
- Satin anodized finish
- Resists oxidation, corrosion and fading
- Can be installed as recessed or surface mounted
- UL Listed and CSA Certified



Covers

- Two and three channel raceway utilize common covers
- Available in single and dual channel cover designs
- Single covers allow access to one service at a time
- Dual channel cover fits over two channels for a seamless look
- Common aesthetics throughout line

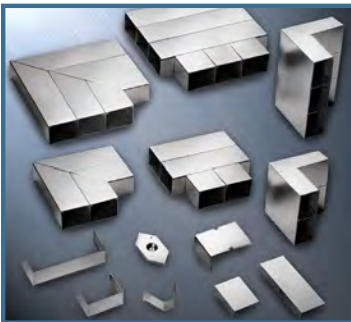

Wide Selection of Fittings



- External, internal, flat and tee fittings available to accommodate all types of applications
- Available in both two and three channel versions







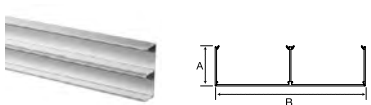

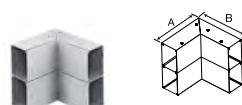
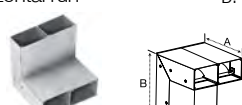
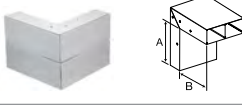

Compatible Cover Plates

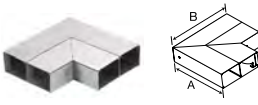
- Cover plates can be used for both HBLALU5000 and HBLALU7620 Raceways
- Cover plates offer option for most common power device applications
- Low profile bezel cover accommodates Hubbell iSTATION Modules
- Open System data option available
- Base mounted cover plates available for added strength

HBLALU5000 Series

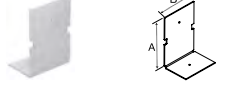
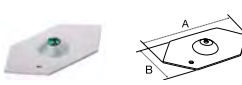

HBLALU5000 Series	Description	Material	Catalog Number	Description	Material	Catalog Number
	<p>Two Channel Base Satin anodized finish. Packed 40 ft. (12.19m) per carton, 10 ft. (3m) lengths.</p> <p>Assembled cover and base dimensions: W: 5.08" (129.03) H: 1.75" (44.45)</p> 	Anodized Aluminum	HBLALU5000B10 A: 1.66" (42.16) B: 5.08" (129.03)	<p>Cover (Single Channel) Satin anodized finish. Packed 40 ft. (12.19m) per carton, 5 ft. (1.5m) lengths.</p> 	Anodized Aluminum	HBLALUC57 A: 2.54" (64.52)

Elbows and Tees	Description	Material	Catalog Number	Description	Material	Catalog Number
	<p>Internal Elbow For making a 90° internal turn in a raceway run.</p> 	Anodized Aluminum	HBLALU5017* A: 6.00" (152.40) B: 6.00" (152.40)	<p>Inverted Internal Elbow For connecting a vertical run of HBLALU5000 with a horizontal run with its cover facing up.</p> 	Anodized Aluminum	HBLALU5017N* A: 5.91" (150.20) B: 5.98" (151.89)
	<p>External Elbow For making a 90° external turn in a raceway run.</p> 	Anodized Aluminum	HBLALU5018* A: 6.00" (152.40) B: 6.00" (152.40)	<p>Tee For branch connections of two runs of HBLALU5000 Raceway.</p> 	Anodized Aluminum	HBLALU5015* A: 9.00" (228.60) B: 8.08" (205.30)
<p>Flat Elbow For making a 90° flat turn in a raceway run.</p> 	Anodized Aluminum	HBLALU5011* A: 9.00" (228.60) B: 9.00" (228.60)				
End Fittings	<p>Entrance End Fitting For feeding raceway, has concentric ½ in. and ¾ in. trade size KOs.</p> 	Anodized Aluminum	HBLALU5010B2 A: 5.08" (129.10) B: 1.75" (44.40)	<p>Blank End Fitting For closing end of raceway.</p> 	Anodized Aluminum	HBLALU5010B A: 5.08" (129.10) B: 1.75" (44.40)
	Fittings	<p>Cover Clip To cover seam where lengths of HBLALU5000 Raceway come together.</p> 	Stainless Steel	HBLALU5006 A: 1.38" (34.92)	<p>Wire Clip For holding conductors in place. Can be used for either HBLALU5000 or HBLALU7620 Raceway.</p> 	Anodized Aluminum
<p>Internal Corner Coupling For butting two raceway sections to form an internal 90° turn in a raceway run.</p> 		Anodized Aluminum	HBLALU5717A A: 3.50" (88.90) B: 2.38" (60.30)	<p>Grounding Adapter For connection of equipment grounding. #10-32 Locking screws included.</p> 	Galvanized Steel	HBLALU5709 A: 3.37" (85.50) B: 2.00" (50.83)
<p>Couplings (Pair) To join lengths of HBLALU5000 or HBLALU7620 base.</p> 		Aluminum	HBLALU5701 A: 2.38" (60.30) B: 4.00" (101.80)			

Note: *HBLALU5701 couplings included.
See page S-44 for cover plates.

Dimensions in Inches (mm)

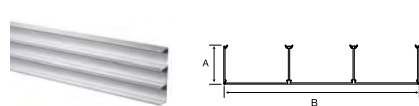
HBLALU7620 Series

	Description	Material	Catalog Number	Description	Material	Catalog Number
HBLALU7620 Series	Three Channel Base Satin anodized finish. Packed 40 ft. (12.19m) per carton, 10 ft. (3m) lengths. Assembled cover and base dimensions: W: 7.62" (193.55) H: 2.25" (57.15)	Anodized Aluminum	HBLALU7620B10 A: 2.16" (54.86) B: 7.62" (193.55)	Cover (Single Channel) Satin anodized finish. Packed 40 ft. (12.19m) per carton, 5 ft. (1.5m) lengths.	Anodized Aluminum	HBLALUC57 A: 2.54" (64.52)
						

	Description	Material	Catalog Number	Description	Material	Catalog Number
Elbow Fittings	Internal Elbow For making a 90° internal turn in a raceway run.	Anodized Aluminum	HBLALU7617* A: 6.50" (165.10) B: 6.50" (165.10)	Inverted Internal Elbow For connecting a vertical run of HBLALU7620 with a horizontal run with its cover facing up.	Anodized Aluminum	HBLALU7617N* A: 6.50" (165.10) B: 5.98" (151.89)
	External Elbow For making a 90° external turn in a raceway run.	Anodized Aluminum	HBLALU7618* A: 5.50" (139.70) B: 5.50" (139.70)	Tee For branch connections of two runs of HBLALU7620 Raceway.	Anodized Aluminum	HBLALU7615* A: 9.00" (228.60) B: 10.62" (269.80)
	Flat Elbow For making a 90° flat turn in a raceway run.	Anodized Aluminum	HBLALU7611* A: 11.54" (293.10) B: 11.54" (293.10)			
End Fittings	Entrance End Fitting For feeding raceway, has concentric ½ in. and ¾ in. trade size KOs.	Anodized Aluminum	HBLALU7610B2 A: 7.62" (193.50) B: 2.31" (58.70)	Blank End Fitting For closing end of raceway.	Anodized Aluminum	HBLALU7610B A: 7.62" (193.50) B: 2.31" (58.70)
	Cover Clip To cover seam where lengths of HBLALU7620 Raceway come together.	Stainless Steel	HBLALU7606 A: 1.38" (34.92)	Wire Clip For holding conductors in place. Can be used for either HBLALU5000 or HBLALU7620 Raceway.	Anodized Aluminum	HBLALU57WC A: 1.00" (25.40)
Fittings	Internal Corner Coupling For butting two raceway sections to form an internal 90° turn in a raceway run.	Anodized Aluminum	HBLALU5717A A: 3.50" (88.90) B: 2.38" (60.30)	Grounding Adapter For connection of equipment grounding. #10-32 Locking screws included.	Galvanized Steel	HBLALU5709 A: 3.37" (85.50) B: 2.00" (50.83)
	Couplings (Pair) To join lengths of HBLALU5000 or HBLALU7620 base.	Aluminum	HBLALU5701 A: 2.38" (60.30) B: 4.00" (101.80)			

Note: *HBLALU5701 couplings included.
See page S-44 for cover plates.

Dimensions in Inches (mm)

HBLALU5000 and HBLALU7620 Series

Cover Plates	Description	Material	Catalog Number	Description	Material	Catalog Number	
	Duplex Receptacle Cover For duplex receptacles and duplex communication frames shown on page S-45.	Anodized Aluminum	HBLALU57DR A: 2.54" (64.50) B: 12.00" (304.80)	HBLALU57DRBM (Base Mounted Device)	Toggle Switch Cover For single pole, two pole, three way or four way switches.	Anodized Aluminum	HBLALU57N A: 2.54" (64.50) B: 12.00" (304.80)
							HBLALU57NBM (Base Mounted Device)
	Rectangular Style Line® Cover For Style Line rectangular duplex receptacle, GFCI, surge device or rectangular communication frames shown on page S-45.	Anodized Aluminum	HBLALU57G A: 2.54" (64.50) B: 12.00" (304.80)	HBLALU57GBM (Base Mounted Device)	Blank Cover To cover 12 in. (305.00) section of raceway.	Anodized Aluminum	HBLALU57BL A: 2.54" (64.50) B: 12.00" (304.80)
	Single Receptacle Cover For single receptacle with face diameters of 1.38 in. to 1.39 in. (35.05 to 35.31).	Anodized Aluminum	HBLALU57E A: 2.54" (64.50) B: 12.00" (304.80)	HBLALU57EBM (Base Mounted Device)	Single Receptacle Cover For single receptacle with face diameters of 1.56 in. to 1.59 in. (39.62 to 40.39).	Anodized Aluminum	HBLALU57F A: 2.54" (64.50) B: 12.00" (304.80)
						HBLALU57FBM (Base Mounted Device)	
Hubbell iSTATION Cover For mounting Hubbell iSTATION modules. IMF1GY or IFFxxGY frames and plates on pages S-45 and S-46.	Anodized Aluminum	HBLALU57LPB A: 2.54" (64.50) B: 12.00" (304.80) C: 1.90 (48.26) D: 3.00" (76.20)		Ortronics® Cover Plate For two Ortronics TracJack® or one Series II® datacom insert. Both bezels included.	Anodized Aluminum	HBLALU57ABRT A: 2.54" (64.50) B: 12.00" (304.80)	
2-Gang Raised Device Box KP device plates only, found on page S-45.	Gray PVC	HBLALU57KP2G A: 5.08" (129.10) B: 7.64" (193.90)					



Base Mounted Device Cover Design













No exposed screw holes. Receptacle is securely mounted to the raceway base rather than the cover.













Dimensions in Inches (mm)

Ortronics®, Series II® and TracJack® are registered trademarks of The Ortronics Company.

Device Brackets, Plates and Frames

1. Choose Device Mounting Bracket	Description	Color	HBL4750 Series	HBL6750 Series
	Device Mounting Bracket for HBL4750 and HBL6750 Series Metal Raceway.	Ivory Gray	 HBL4750IV HBL4750GY	 HBL6750IV HBL6750GY



2. Choose 1-Gang "KP" Plates	Color	Catalog Number	Catalog Number	Catalog Number	Catalog Number
	Almond Gray	 KP8GY Duplex	 KP26GY Style Line®	 KP1GY Toggle	 KP7GY Receptacle (1.41 ID)
	Almond Gray	 KP14GY Blank	 KP212GY Coax (2)	 KP2140GY Jack/Coax	 KP720GY Receptacle (1.60 ID)
	Almond Gray	 KPORTGY Ortronics Series II® Data Module	 KPPANGY Panduit Mini-Com® Data Module	 KP2162GY Modular Jacks (2)	 KP2163GY Modular Jacks (3)
	Almond Gray	 KPIMBZGY 3-Unit iSTATION (Accepts all Hubbell iSTATION Modules located in Network Wiring section Y).			











Comm. "IFP" Plates & Frames	Color	Catalog Number	Catalog Number	Catalog Number	Catalog Number
	Ivory Gray	 ISF2EI ISF2GY Style Line® 2-Port	 ISF3EI ISF3GY Style Line® 3-Port	 ISF4EI ISF4GY Style Line® 4-Port	 ISF6EI ISF6GY Style Line® 6-Port
	Ivory Gray Office White	 — IFP126GY IFP126OW Style Line®	 — IFP180W Duplex	 BR106E BR106G Duplex 2-Port	 Q106E Q106G Duplex 4-Port
	Ivory Gray	 IFP12EI IFP12GY Flush 2-Port	 IFP13EI IFP13GY Flush 3-Port	 IFP14EI IFP14GY Flush 4-Port	 IFP16EI IFP16GY Flush 6-Port

Note: For HBL3000 series raceway applications, catalog number HBL3051LEIV/GY must be used with plates and devices.
See page S-46 or section Y for additional information on datacom products.









Panduit® and Mini-Com® are registered trademarks of Panduit Corp.
Ortronics® and Series II® are registered trademarks of Ortronics/Legrand.

Frame Modules and Modular Connector Fittings

1. Choose Plate Frame	Description	Color	HBL4750 Series		HBL6750 Series	
	Front loading plate will accept any modules in three unit combinations. Angled fixtures to be used in bottom opening only. Use KPIMBZOW/GY plate with modules for HBL4750 and HBL6750 Series device mounting bracket located on page S-45. See section Y for additional Hubbell iSTATION modules and datacom products.	Ivory Gray		IMF1EI IMF1GY		IMF2EI IMF2GY
<i>Note: Each gang accepts 3 module units.</i>						

2. Choose Modules	Color	Catalog Number	Catalog Number	Catalog Number	Catalog Number			
	Ivory Gray	 IMB05EI IMB05GY Blank Module .5 Unit	 IMB1EI IMB1GY Blank Module 1 Unit	 IMB15EI IMB15GY Blank Module 1.5 Unit				
	Ivory Gray	 IM1K1EI IM1K1GY Modular Flat 1 Unit	 IM2K1EI IM2K1GY Modular Flat 1 Unit	 IM1KA15EI IM1KA15GY Modular Angled 1.5 Unit	 IM2KA15EI IM2KA15GY Modular Angled 1.5 Unit			
	Ivory Gray	 IM1SCA15EI IM1SCA15GY SC 1 Duplex Angled, 1.5 Unit	 IM2SCA2EI IM2SCA2GY SC 2 Duplex Angled, 2 Unit	 IM1IA15EI IM1IA15GY Modular Recessed 1.5 Unit	 IM2IA15EI IM2IA15GY Modular Recessed 1.5 Unit			
Keystone Opening Hole size for mounting all Hubbell Jacks. <table style="display: inline-table; vertical-align: middle;"> <tr> <td style="text-align: center;">A</td> <td rowspan="2" style="border: 1px solid black; width: 20px; height: 20px; margin: 0 auto;"></td> </tr> <tr> <td style="text-align: center;">B</td> </tr> </table> A: .580" (14.73) B: .760" (19.30)						A		B
A								
B								

Modular connectors to be used with any plate with a standard modular opening. Not recommended for use with KP plates. For KP applications use KPIMBZAL/GY bezel and appropriate Hubbell iSTATION modules located in the section Y. See section Y for additional modular connectors.

Modular Connector Fittings	Color	Catalog Number	Catalog Number	Catalog Number
	Ivory Gray	 SFFGEI SFFGGY F-Type Coupler Gold	 SFFEX SFFGX F-Type Coupler Nickel	 SFBE10 SFBG10 Blank (10 Pack)
	Ivory Gray	 SFRCRFFEI SFRCRFFGY RCA Gold Pass-through F/F Coupler Red Insulator	 SFRCWFFEI SFRCWFFGY RCA Gold Pass-through F/F Coupler White Insulator	 SFRCYFFEI SFRCYFFGY RCA Gold Pass-through F/F Coupler Yellow Insulator
	Black housing only	 SFRC110R RCA 110 Punchdown Red Insulator	 SFRC110W RCA 110 Punchdown White Insulator	 SFRC110Y RCA 110 Punchdown Yellow Insulator
	Black	 SFSV110BK S-Video 110	 SFSVBK S-Video F/F Coupler	 SFSPGBK* SFSPGR** Speaker Post Connector

Note: *Office white housing with black ring color.
 **Office white housing with red ring color.

Xcelerator Modular Jacks	Color	Catalog Number	Catalog Number	Catalog Number
	Ivory Gray	 HXJ5EEI HXJ5EGY Cat. 5e, T568A, T568B, RJ45	 HXJ6EI HXJ6GY Cat. 6, T568A, T568B, RJ45	 HXJUEI HXJUGY 6 Position USOC, RJ25

Note: See section Y for additional Hubbell Xcelerator modular jacks and colors.

Dimensions in Inches (mm)

Wire Fill Capacity Chart and Technical Information

Metal and Aluminum Raceway Wire Fill Capacities																
Series	Channel Area (sq. in.)	Power (THHN/T90 Nylon)			Voice		Data (Copper Cables)					Data (Multimode Fiber Optic Cables)				
		14 AWG	12 AWG	10 AWG	4-Pair	25-Pair	Type RG59U	Cat. 5e	Cat. 6	Cat. 6A	Cat. 6 STP	(2) or (4) Fiber Round Cable	Fiber Optic Jumpers	Fiber Optic Zip Cord		
		Wire O.D. (in):	0.111	0.13	0.164	0.19	0.41	0.242	0.21	0.25	0.35	0.29	0.19	0.118	.12 X .24	
Wire Area (sq. in.):	0.0097	0.0133	0.0211	0.0283	0.1320	0.0460	0.0346	0.0491	0.0962	0.0660	0.0283	0.0109	0.0288			
Wire Fill Capacity	40%	40%	40%	40%	40%	40%	40%	40%	40%	40%	40%	40%	40%			
Metal Raceway	HBL500	0.22	7	5	3	2	0	1	2	1	1	1	2	8	2	
	HBL700	0.26	10	7	4	3	0	2	3	2	1	1	3	8	3	
	HBL750	0.40	12	9	5	6	1	3	5	3	2	2	6	15	6	
	HBL2000	0.89	7	7	0	13	3	8	10	7	4	5	13	33	12	
	HBL2000A	0.86	35	26	16	11	2	7	9	7	4	5	13	33	12	
	HBL2400	1.39	57	41	26	19	4	12	16	11	5	8	19	51	19	
	HBL2400D	Channel- A	0.86	26	19	11	12	2	7	9	7	3	5	12	31	11
		Channel- B	0.37	11	9	6	5	1	3	4	3	1	2	5	13	5
	HBL3000	3.70	152	111	70	52	11	32	43	30	15	22	52	136	51	
	HBL4750	No Barriers	7.20	296	216	136	102	22	63	83	59	30	44	102	264	100
		Barrier Centered Ch. A	3.10	127	93	58	44	9	27	36	25	13	19	44	114	43
	Barrier Centered Ch. B		3.30	127	93	58	47	10	29	38	27	14	20	47	121	46
	Barrier Offset Ch. A	2.10	86	63	39	30	6	18	24	17	9	13	30	77	29	
		Barrier Offset Ch. B	4.30	176	129	81	61	13	37	50	35	18	26	61	158	60
	HBL6750	No Barriers	13.77	566	412	259	195	42	120	159	112	57	83	195	505	191
Barrier Offset 1/3 Ch. A	4.59	189	138	86	65	14	40	53	37	19	28	65	168	64		
	Barrier Offset 2/3 Ch. B	9.18	379	278	173	130	28	80	106	75	38	56	130	337	128	
Aluminum Raceway	HBLALU2000	1.20	49	36	22	16	3	10	13	9	4	7	16	44	16	
	HBLALU3800	5.80	214	156	98	82	18	50	67	47	24	35	82	213	81	
	HBLALU4800	Center Barrier/ Both Channels	11.60	428	312	196	164	35	101	134	95	48	70	164	426	161
		Center Barrier/ 1 Channel	5.80	214	156	98	82	18	50	67	47	24	35	82	213	81
	HBLALU5000	Center Barrier/ Both Channels	7.60	312	228	142	106	22	64	86	60	30	46	106	278	104
		Center Barrier/ 1 Channel	3.80	156	114	71	53	11	32	43	30	15	23	53	139	52
	HBLALU7620	2 Barriers with 3 Equal Channels/ Total	15.00	618	450	282	210	45	129	171	120	60	90	210	549	207
		2 Barriers with 3 Equal Channels/ 1 Channel	5.00	206	150	94	70	15	43	57	40	20	30	70	183	69

Note: Pathway (Raceway) fill shall be 40% maximum. Raceway fittings and outlets/receptacles reduce the cross section of the raceway system, thus reducing overall cable fill capacity.

Physical Properties

Material Galvanized Steel or Anodized Aluminum

Metal PlugTrak Specifications

Receptacle Rating NEMA 5-15R and NEMA 5-20R
 Wire #12 AWG Stranded Copper
 Receptacle Face Thermoplastic

Codes/Standards

TIA/EIA 569B
 UL Standard UL 5
 Listings E253976 /E253830 /E253833
 CSA Standard C22.2 no. 62
 Certification LR87514

Metal and Aluminum Raceway

Cross Reference

Hubbell Catalog Number	Wiremold® Catalog Number
HBL500 Series	500 Series
HBL502B	502
HBL605CUT	605
HBL600B	600B
HBL605K	605K
HBL500TFIV	N/A
HBL50010IV	V500
HBL504IV	V504
HBL506IV	V506
HBL511IV	V511
HBL512IV	V512
HBL517IV	V517
HBL518IV	V518
HBL750 Series	700 Series
HBL607CUT	607
HBL7502B	702
HBL607K	607K
HBL750TFIV	N/A
HBL75010IV	V700
HBL7504IV	V704
HBL7506IV	V706
HBL711IVA	V711
HBL712IV	V712
HBL717IVA	V717
HBL718IVA	V718
HBL500/HBL750 Series	500/700 Series
HBL5701C	5701
HBL5709	5709
HBL5780	5780
HBL5781	5781
HBL5782C	5782
HBL5791	5791
HBL5709GC	5709GC
HBL5781A	5781A
HBL5782A	5782A
HBL5790B	5790B
HBL5752RA	R5752
HBL5753RA	R5753
HBL5700FIVA	V5700F
HBL5703IV	V5703
HBL5711LHIVA	V5711LH
HBL5711RHIVA	V5711RH
HBL5715IVA	V5715
HBL5719IVA	V5719
HBL57242IVA	V57242
HBL5731IV	V5731
HBL5733IVA	V5733
HBL5735IVA	V5735
HBL5736IV	V5736
HBL5737IVA	V5737
HBL5737AIVA	V5737A
HBL5738IVA	V5738
HBL5738AIVA	V5738A
HBL5738AFIVA	V5738AF
HBL5739IVA	V5739
HBL5739AIVA	V5739A
HBL5744IVA	V5744
HBL57442IVA	V5744-2
HBL57443IVA	V5744-3
HBL5744SIVA	V5744S
HBL5744S2IVA	V5744S-2
HBL5744S3IVA	V5744S-3
HBL5745IVA	V5745
HBL5747IVA	V5747
HBL57472IVA	V5747-2
HBL57473IVA	V5747-3
HBL5748IVA	V5748

Hubbell Catalog Number	Wiremold® Catalog Number
HBL57482IVA	V5748-2
HBL57483IVA	V5748-3
HBL57484IVA	V5748-4
HBL57485IVA	V5748-5
HBL57486IVA	V5748-6
HBL5751IVA	V5751
HBL57512IVA	V5751-2
HBL57513IVA	V5751-3
HBL5751AIVA	V5751A
HBL5752IVA	V5752
HBL5753IVA	V5753
HBL5760IVA	V5760
HBL5783IVA	V5783
HBL5784IVA	V5784
HBL5785IVA	V5785
HBL5786IVA	V5786
HBL5786AIVA	N/A
HBL5711BRIVA	N/A
HBL5715BRIVA	N/A
HBL5717BRIVA	N/A
HBL5718BRIVA	N/A
HBL2000 Series	2000 Series
HBL620C	620
HBL2001C	2001
HBL2003SC	2003
HBL2009GC	2009
HBL2000WC	2000WC
HBL2000WCA	N/A
HBL2017TC	2017TC
HBL620BCK	620BCK
HBL2000B5GY	G2000B-5
HBL2000BCGY	G2000BC
HBL2000BCAGY	N/A
HBL2000CGY	G2000C
HBL2000CAGY	G2100C
HBL2006GY	G2006
HBL2010A2GY	G2010A2
HBL2010A3GY	G2010A3
HBL2010BGY	G2010B
HBL2011GY	G2011
HBL2011BRGY	N/A
HBL2015GY	G2015
HBL2015BRGY	N/A
HBL2017BRGY	N/A
HBL2018BRGY	N/A
HBL2018CGY	G2018C
HBL2048GY	G2048
HBL20482GY	G2048-2
HBL2051HGY	G2051H
HBL2000TFIV	N/A
HBL2000TFGY	N/A
HBL2000B5IV	V2000B-5
HBL2000BCIV	V2000BC
HBL2000BCAIV	N/A
HBL2000CIV	V2000C
HBL2000CAIV	V2100C
HBL2006IV	V2006
HBL2010A2IV	V2010A2
HBL2010A3IV	V2010A3
HBL2010BIV	V2010B
HBL2011IV	V2011
HBL2011BRIV	N/A
HBL2015IV	V2015
HBL2015BRIV	N/A
HBL2017BRIV	N/A
HBL2018BRIV	N/A
HBL2018CIV	V2018C

Wiremold® is a registered trademark of The Wiremold Company.
Hubbell Inc. is not affiliated with The Wiremold Company.

Metal and Aluminum Raceway

Cross Reference

Hubbell Catalog Number	Wiremold® Catalog Number
HBL2048IV	V2048
HBL20482IV	V2048-2
HBL2051HIV	V2051H
HBL2089IV	V2089
HBL2089EIV	V2089E

HBL2400/HBL2400D 2400/2400D

Series	Series
HBL624CUT	624
HBL2401C	2401
HBL2409GC	2409
HBL2400WC	2400WC
HBL2401DC	2401D
HBL624BCK	624BCK
HBL24DRK	N/A
HBL24SRK	N/A
HBL24106DRK	N/A
HBL24106RRK	N/A
HBL4724REDIV	N/A
HBL2420REDIV	N/A
HBL2400TFIV	N/A
HBL2400DTFIV	N/A
HBL2400BIV	V2400B
HBL2400B10IV	V2400B-10
HBL2400BCIV	V2400BC
HBL2400BDIV	V2400BD
HBL2400CIV	V2400C
HBL2406IV	V2406
HBL2410AIV	V2410A
HBL2410BIV	V2410B
HBL2410BDIV	V2410BD
HBL2410CIV	V2410C
HBL2410DFOIV	V2410DFO
HBL2410FCIV	V2410FC
HBL2411DFOIV	V2411DFO
HBL2415DFOIV	V2411DFO
HBL2411IV	V2411FO
HBL2415IV	V2415FO
HBL2417DFOIV	V2417DFO
HBL2417IV	V2417FO
HBL2418DFOIV	V2418DFO
HBL2418IV	V2418FO
HBL2426IV	V2426
HBL2444IVA	V2444
HBL24442IV	V2444-2
HBL2444DIVA	V2444D
HBL2444D2AIV	V2444D-2A
HBL2448IVA	V2448
HBL24482IV	V2448-2
HBL2451HIV	V2451H
HBL2475DBRIV	V2475D
HBL2489IV	V2489

HBL3000 Series 3000 Series

HBL630B	630B
HBL630BDK	630BDK
HBL630C	630C
HBL630CDK	630CDK
HBL3000BGY	G3000B
HBL3000C075GY	G3000C075
HBL3000C195GY	G3000C195
HBL3000CEGY	G3000CE
HBL3000WCGY	G3000WC
HBL3001GY	G3001
HBL3001AGY	G3001A
HBL3003GY	G3003

Hubbell Catalog Number	Wiremold® Catalog Number
---------------------------	-----------------------------

HBL3006EGY	G3006E
HBL3007CGY	G3007C
HBL3010AEGY	G3010AE
HBL3010BGY	G3010B
HBL3010CGY	G3010C
HBL3011EGY	G3011E
HBL3014CGY	G3014C
HBL3015EGY	G3015E
HBL3017TCEGY	G3017TCE
HBL3018AEGY	G3018AE
HBL3027AEGY	G3027AE
HBL3028GY	G3028
HBL3033JEGY	G3033JE
HBL3036HEGY	G3036HE
HBL3040CEGY	G3040CE
HBL3043BEGY	G3043BE
HBL30442GY	G3044-2
HBL3046BEGY	G3046BE
HBL3046H2GY	G3046H-2
HBL3048RGY	G3048R
HBL3051LEGY	G3051LE
HBL3082GY	G3082
HBL3086GY	G3086
HBL3200REDIV	N/A
HBL3200REDGY	N/A
HBL3000TFIV	N/A
HBL3000TFGY	N/A
HBL3000BIV	V3000B
HBL3000C075IV	V3000C075
HBL3000C195IV	V3000C195
HBL3000CEIV	V3000CE
HBL3003IV	V3003
HBL3006EIV	V3006E
HBL3010AEIV	V3010AE
HBL3010BIV	V3010B
HBL3010CIV	V3010C
HBL3011EIV	V3011E
HBL3014CIV	V3014C
HBL3015EIV	V3015E
HBL3017TCEIV	V3017TCE
HBL3018AEIV	V3018AE
HBL3027AEIV	V3027AE
HBL3028IV	V3028
HBL3033JEIV	V3033JE
HBL3036HEIV	V3036HE
HBL3040CEIV	V3040CE
HBL3043BEIV	V3043BE
HBL30442IV	V3044-2
HBL3046BEIV	V3046BE
HBL3046H2IV	V3046H-2
HBL3048RIV	V3048R
HBL3051LEIV	V3051LE
HBL3086IV	V3086

HBL4750 Series 4000 Series

HBL4751AC	4001A
HBL4750IV	V4050
HBL640C	640C
HBL4750B10GY	G4000B-10
HBL4750C075GY	G4000C075
HBL4750C195GY	G4000C195
HBL640B	640B
HBL4747RXIV	V4047RX
HBL4747RFIV	V4047RF
HBL4747C1GY	G4047C-1
HBL4747BXGY	G4047BX
HBL4747RXGY	G4047RX
HBL4747RFGY	G4047RF

Wiremold® is a registered trademark of The Wiremold Company.
Hubbell Inc. is not affiliated with The Wiremold Company.

Metal and Aluminum Raceway

Cross Reference

Hubbell Catalog Number	Wiremold® Catalog Number
HBL4747JXGY	G4047JX
HBL4747C2GY	G4047C-2
HBL4715DFOGY	G4015DFO
HBL4717NGY	G4017N
HBL4746H2GY	G4046H-2
HBL4718DFOGY	G4018FO
HBL47472BBFFGY	G4047-2BBFF
HBL47472BBBBBGY	G4047-2BBBB
HBL47472BBSSGY	G4047-2BBSS
HBL47472BBXXGY	G4047-2BBXX
HBL47472BBTTGY	G4047-2BBTT
HBL4747AXGY	G4047AX
HBL47472RRXXGY	G4047-2RRXX
HBL4747BFGY	G4047BF
HBL4747BBGY	G4047BB
HBL4747BRGY	N/A
HBL4747BRIV	N/A
HBL4747BTGY	G4047BT
HBL4747BSGY	G4047BS
HBL4774AGY	G4074A
HBL4750GY	G4050
HBL47472RRXXIV	V4047-2RRXX
HBL47472BBXXIV	V4047-2BBXX
HBL4747BBIV	V4047BB
HBL4747AXIV	V4047AX
HBL4747BFIV	V4047BF
HBL4747BTIV	V4047BT
HBL4747BSIV	V4047BS
HBL4747C1IV	V4047C-1
HBL4747BXIV	V4047BX
HBL4747JXIV	V4047JX
HBL4747C2IV	V4047C-2
HBL4750CIV	V4000C
HBL4750B10IV	V4000B-10
HBL4750C315IV	V4000C315
HBL4750C195IV	V4000C195
HBL4711DFOIV	V4011FO
HBL4711IV	V4011
HBL4710DFOIV	V4010DFO
HBL4710IV	V4010
HBL4710BIV	V4010B
HBL4756AIV	V4006
HBL4714AIV	V4014A
HBL4712TXIV	V4012TX
HBL4750C135IV	V4000C135
HBL4750C075IV	V4000C075
HBL4717DFOIV	V4017FO
HBL4717IV	V4017
HBL4715DFOIV	V4015DFO
HBL4715IV	V4015
HBL4718DFOIV	V4018FO
HBL4718IV	V4018
HBL4717NIV	V4017N
HBL47472BBBBBIV	V4047-2BBBB
HBL4746H2IV	V4046H-2
HBL47472BBTTIV	V4047-2BBTT
HBL47472BBSSIV	V4047-2BBSS
HBL4747CVMGY	G6007C-1
HBL4786AGY	G4086A
HBL4750TFIV	N/A
HBL4747CVM2GY	G6007C-2
HBL4750BP	N/A
HBL4750TFGY	N/A
HBL4756AGY	G4006
HBL4751DA	4001DA
HBL640BDK	640BDK
HBL640CDK	640CDK
HBL4750CGY	G4000C
HBL4750C135GY	G4000C135

Hubbell Catalog Number	Wiremold® Catalog Number
HBL4750C315GY	G4000C315
HBL4750DGY	G4000D
HBL4750WCGY	G4000WC
HBL4710BGY	G4010B
HBL4710DFOGY	G4010DFO
HBL4710GY	G4010
HBL4711DFOGY	G4011FO
HBL4711GY	G4011
HBL4712TXGY	G4012TX
HBL4714AGY	G4014A
HBL4717DFOGY	G4017FO
HBL4717GY	G4017
HBL4717TCAGY	G4017TCA
HBL4774AIV	V4074A
HBL4786AIV	V4086A
HBL4747CVMIV	V6007C-1
HBL4747CVM2IV	V6007C-2
<hr/>	
HBL6750 Series	6000 Series
HBL6751A	6001A
HBL660C	640C
HBL660CDK	640CDK
HBL660B	660B
HBL660BDK	660BDK
HBL6718DFOGY	G4018FO
HBL6718GY	G6017TX
HBL6746HHGY	G4046H-2 (4000 Series 2-Gang)
HBL67473BBBBBBBGY	G4047-2BBBB (4000 Series 2-Gang)
HBL67473BBBBFFGY	G4047-2BBFF (4000 Series 2-Gang)
HBL67473BBBBSSGY	G4047-2BBSS (4000 Series 2-Gang)
HBL67473BBBBTTGY	G4047-2BBTT (4000 Series 2-Gang)
HBL67473BBBBXXGY	G4047-2BBXX (4000 Series 2-Gang)
HBL6747AXXGY	G4047AX (4000 Series 2-Gang)
HBL6747BBBGY	G4047BB (4000 Series 2-Gang)
HBL6747BFBGY	G4047BF (4000 Series 2-Gang)
HBL6747BSBGY	G4047BS (4000 Series 2-Gang)
HBL6747BBTGY	G4047BT (4000 Series 2-Gang)
HBL6747BXXGY	G4047BX (4000 Series 2-Gang)
HBL6747C1GY	V4047C-1 (4000 Series 1-Gang Overlapping)
HBL6747C2GY	V4047C-2 (4000 Series 2-Gang Overlapping)
HBL6747JXXGY	G4047JX (4000 Series 2-Gang)
HBL6747RRFGY	G4047RF (4000 Series 2-Gang)
HBL6747RXXGY	G4047RX (4000 Series 2-Gang)
HBL67473RRRRXXGY	G4047-2RRXX
HBL6750GY	G4050
HBL6750B10GY	G6000B-10
HBL6750CGY	G6000C
HBL6750DAGY	G6000DA
HBL6750WCGY	G6000WC
HBL6751DAGY	G6001DA
HBL6756AGY	G6006
HBL6710BGY	G6010B
HBL6711DFOGY	G6011TX
HBL6711GY	G6011TX
HBL6712TXGY	G6012TX
HBL6714AGY	G6014A
HBL6717DFOGY	G6017TX
HBL6717GY	G6017TX
HBL6774AGY	G6074A
HBL6786GY	G6086
HBL6750C075IV	N/A
HBL6750C075GY	N/A
HBL6750C135IV	N/A
HBL6750C135GY	N/A
HBL6750C195IV	N/A
HBL6750C195GY	N/A
HBL6750C315IV	N/A
HBL6750C315GY	N/A

Wiremold® is a registered trademark of The Wiremold Company.
Hubbell Inc. is not affiliated with The Wiremold Company.

Metal and Aluminum Raceway

Cross Reference

Hubbell Catalog Number	Wiremold® Catalog Number
HBL6715DFOIV	N/A
HBL6715IV	N/A
HBL6715DFOGY	N/A
HBL6715GY	N/A
HBL6717NIV	N/A
HBL6717NGY	N/A
HBL6717TCAGY	N/A
HBL6710DFOIV	N/A
HBL6710DFOGY	N/A
HBL6750TFIV	N/A
HBL6750TFGY	N/A
HBL6718DFOIV	V4018FO
HBL6746HHHIV	V4046H-2 (4000 Series 2-Gang)
HBL67473BBBBXXGY	V4047-2BBBB (4000 Series 2-Gang)
HBL67473BBBBFFIV	V4047-2BBFF (4000 Series 2-Gang)
HBL67473BBBBSSIV	V4047-2BBSS (4000 Series 2-Gang)
HBL67473BBBBTTIV	V4047-2BBTT (4000 Series 2-Gang)
HBL67473BBBBXXIV	V4047-2BBXX (4000 Series 2-Gang)
HBL6747AXXIV	V4047AX (4000 Series 2-Gang)
HBL6747BBBIV	V4047BB (4000 Series 2-Gang)
HBL6747BBFIV	V4047BF (4000 Series 2-Gang)
HBL6747BBSIV	V4047BS (4000 Series 2-Gang)
HBL6747BBTIV	V4047BT (4000 Series 2-Gang)
HBL6747BXXIV	V4047BX (4000 Series 2-Gang)
HBL6747C1IV	V4047C-1 (4000 Series 1-Gang Overlapping)
HBL6747C2IV	V4047C-2 (4000 Series 2-Gang Overlapping)
HBL6747JXXIV	V4047JX (4000 Series 2-Gang)
HBL6747RRFIV	V4047RF (4000 Series 2-Gang)
HBL6747RXXIV	V4047RX (4000 Series 2-Gang)
HBL67473RRRRXXIV	V4047-2RRRX
HBL6750IV	V4050
HBL6750B10IV	V6000B-10
HBL6750CIV	V6000C
HBL6756AIV	V6006
HBL6710BIV	V6010B
HBL6711DFOIV	V6011TX
HBL6711IV	V6011TX
HBL6712TXIV	V6012TX
HBL6714AIV	V6014A
HBL6774AIV	V6074A
HBL6786IV	V6086
Metal PlugTrak®	Metal Plugmold®
HBL20C215IV	V20-C2
HBL20C215GY	G20-C2
HBL20C315IV	N/A
HBL20C315GY	N/A
HBL20GB306GY	G20GB306
HBL20IG306GY	G20IG306
HBL20GB506GY	G20GB506
HBL20GB512GY	G20GB512
HBL20GB606GY	G20GB606
HBL20GB609GY	G20GB609
HBL20GB612GY	G20GB612
HBL20GB618GY	G20GB618
HBL20GBA512GY	G20GBA512
HBL20GBA609GY	G20GBA609
HBL20GBA612GY	G20GBA612
HBL20GBA618GY	G20GBA618
HBL20IG512GY	G20IG512
HBL20IG606GY	G20IG606
HBL24GB306GY	G24GB306
HBL24GB506GY	G24GB506
HBL24GB512GY	G24GB512
HBL24GBA512GY	G24GBA512
HBL24GB606GY	G24GB606
HBL24GB612GY	G24GB612
HBL24GB618GY	G24GB618

Hubbell Catalog Number	Wiremold® Catalog Number
HBL24GBA612GY	G24GBA612
HBL24GBA618GY	G24GBA618
HBL20GB306IV	V20GB306
HBL20IG306IV	V20IG306
HBL20GB506IV	V20GB506
HBL20GB512IV	V20GB512
HBL20GB606IV	V20GB606
HBL20GB609IV	V20GB609
HBL20GB612IV	V20GB612
HBL20GB618IV	V20GB618
HBL20GBA512IV	V20GBA512
HBL20GBA609IV	V20GBA609
HBL20GBA612IV	V20GBA612
HBL20GBA618IV	V20GBA618
HBL20IG512IV	V20IG512
HBL20IG606IV	V20IG606
HBL24GB306IV	V24GB306
HBL24GB506IV	V24GB506
HBL24GB512IV	V24GB512
HBL24GBA512IV	V24GBA512
HBL24GB606IV	V24GB606
HBL24GB612IV	V24GB612
HBL24GB618IV	V24GB618
HBL24GBA612IV	V24GBA612
HBL24GBA618IV	V24GBA618
HBLALU2000 Series	ALA2000 Series
HBLALU2000B10	AL2000B-10
HBLALU2000B5	AL2000B-5
HBLALU2000C5	AL2000C-5
HBLALU2000WC	AL2000WC
HBLALU2001	AL2001
HBLALU2003	AL2003
HBLALU2006	AL2006
HBLALU2009	AL2009
HBLALU2010A	AL2010A
HBLALU2010B	AL2010B
HBLALU2011	AL2011
HBLALU2015	AL2015
HBLALU2017	AL2017
HBLALU2018	AL2018
HBLALU2038	AL2038
HBLALU2040A	AL2040A
HBLALU2043	AL2043
HBLALU2044	AL2044
HBLALU20442	AL2044-2
HBLALU2047	AL2047
HBLALU20472	AL2047-2
HBLALU2051H	AL2051H
Aluminum PlugTrak®	Aluminum Plugmold®
HBLALU20GB306	AL20GB306
HBLALU20GB506	AL20GB506
HBLALU20GB512	AL20GB512
HBLALU20GB606	AL20GB606
HBLALU20GB612	AL20GB612
HBLALU20GB618	AL20GB618
HBLALU20GBA606	AL20GBA606
HBLALU20GBA612	AL20GBA612
HBLALU20GBA618	AL20GBA618
HBLALU20IG306	AL20IG306
HBLALU20IG506	AL20IG506
HBLALU20IG606	AL20IG606
HBLALU24GB306	N/A
HBLALU24IG306	N/A
HBLALU24GB506	N/A
HBLALU24GB512	N/A

Wiremold® is a registered trademark of The Wiremold Company.
Hubbell Inc. is not affiliated with The Wiremold Company.

Metal and Aluminum Raceway

Cross Reference

Hubbell Catalog Number	Wiremold® Catalog Number
HBLALU24IG506	N/A
HBLALU24GB606	N/A
HBLALU24GB612	N/A
HBLALU24GB618	N/A
HBLALU24GBA606	N/A
HBLALU24GBA612	N/A
HBLALU24GBA618	N/A
HBLALU24IG606	N/A

Hubbell Catalog Number	Wiremold® Catalog Number
---------------------------	-----------------------------

HBLALU3800 Series	ALA3800 Series
HBLALU3800B10	ALA3800B-10
HBLALU3806	ALA3806
HBLALU3810B	ALA3810B
HBLALU3810B1	ALA3810B1
HBLALU3811	ALA3811
HBLALU3815	ALA3815
HBLALU3817	ALA3817
HBLALU3817N	ALA3817N
HBLALU3818	ALA3818
HBLALUC5	ALAC-5
HBLALUWC	ALAWC

HBLALU4800 Series	ALA4800 Series
HBLALU01	ALA01
HBLALU09	ALA09
HBLALU17A	ALA17A
HBLALU4800B10	ALA4800B-10
HBLALU4806	ALA4806
HBLALU4810B	ALA4810B
HBLALU4810B2	ALA4810B2
HBLALU4811	ALA4811
HBLALU4815	ALA4815
HBLALU4817	ALA4817
HBLALU4817N	ALA4817N
HBLALU4818	ALA4818
HBLALUABRT	ALA-ABRT
HBLALUBL	ALA-BL
HBLALUDR	ALA-DR
HBLALUE	ALA-E
HBLALUF	ALA-F
HBLALUG	ALA-G
HBLALUJ	ALA-J
HBLALUN	ALA-N
HBLALULPB	N/A

Touch-Up Paint	Touch-Up Paint
HBLGWEP	GWE-S
HBLIWEP	IWE-S

Wiremold® is a registered trademark of The Wiremold Company.
Hubbell Inc. is not affiliated with The Wiremold Company.

Non-Metallic Raceway

Products at a Glance

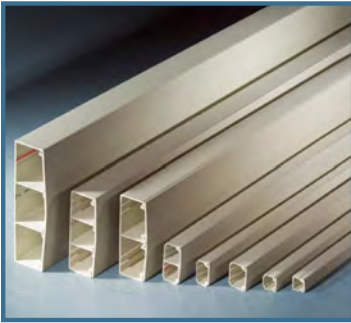

Hubbell PolyTrak® Non-Metallic Surface Raceway

- PolyTrak® Non-Metallic Surface Raceway is a complete system with raceway, fittings, boxes and devices
- Sizes range from single channel PremiseTrak® to three channel Super BaseTrak® for all types of surface raceway requirements
- Single and two channel latching raceways are dual-rated for both power and data applications, reducing inventory requirements
- UL Listed and CSA Certified to 600 volts
- Office white color

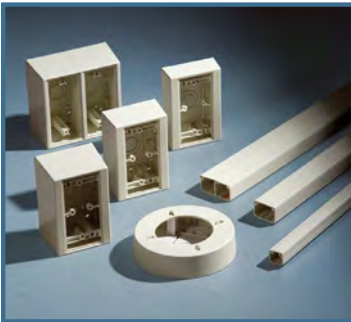

One Box, Three Systems

- Boxes have three cut-aways that can be utilized with WallTrak®, LANTrak and PremiseTrak (Latching) systems
- Reduces inventory requirements
- Eliminates need to order three separate boxes
- Boxes available in low, standard and deep profiles.
- Two-gang divided box available for power, data, voice, audio and video applications
- Boxes utilize Hubbell KP plates or Hubbell iSTATION Modules and Bezels



Flush or Full Capacity Boxes

- Super BaseTrak® and BaseTrak® Raceway offer multiple solutions for box installation
- Super BaseTrak® in-line three-gang box allows maximum capacity in a flush design
- Super BaseTrak® and BaseTrak® available in single, two and three-gang full capacity boxes
- Two and three channel BaseTrak® (PB2 and PB3) available with one and two-gang in-line boxes
- Full capacity in-line boxes eliminate the need to de-rate the wire fill capacity due to the intrusion of devices into the raceway channel



Non-Metallic PlugTrak®

- Available as hard wired multi-outlet assembly or relocatable power tap
- Hubbell designed and manufactured 15 or 20 Amp receptacles
- UL Listed and CSA Certified
- Office white color

Hard Wired Multi-Outlet PlugTrak®

- Available in 5 ft. (1.5m) or 6 ft. (1.8m) lengths
- Available in single, two circuit and is inherently an isolated ground product
- Multiple spacing configurations
- Hard wired PlugTrak® mates with LANTrak® fittings and boxes
- Tamper-Resistant versions available

Portable PlugTrak®

- Available in 3 ft. (0.9m) or 5 ft. (1.5m) lengths
- 6 ft. (1.8m) length 15 or 20 Amp molded cord set allows reliable access
- Pre-punched holes make mounting easy

PT1 PremiseTrak® (Non-Latching)

PT1 PremiseTrak®	Description	Color	Length	Without Adhesive	With Adhesive
	Base and Cover Single channel raceway. Available in 5 ft. (1.5m) and 7 ft. (2.1m) lengths.	Office White	5 ft. 7 ft.	PT1BC5 PT1BC7 A: .68" (17.27) B: .75" (19.05)	PT1ABC5 PT1ABC7 A: .68" (17.27) B: .75" (19.05)





Device Boxes	Description	Color	Catalog Number	Description	Color	Catalog Number
	1-Gang Low Profile Box For shallow switches and receptacles. See page S-63 for recommended plate options.	Office White	PT12LPB A: 4.90" (124.46) B: 3.25" (82.55) C: 1.12" (28.45)	1-Gang Deep Box For deep devices or applications where additional room is beneficial. See page S-63 for recommended plate options.	Office White	PT12DBA A: 4.90" (124.46) B: 3.25" (82.55) C: 1.91" (48.51)
	1-Gang Standard Box For standard switches and receptacles. See page S-63 for recommended plate options.	Office White	PT12SBA A: 4.90" (124.46) B: 3.25" (82.55) C: 1.63" (41.40)	2-Gang Deep Box For deep devices or applications where additional room is beneficial. Uses 2-gang "KP", "IMF", or "IFP" plates for power or data applications. See page S-63 for recommended plate options.	Office White	PT12TGB A: 4.90" (124.46) B: 5.06" (128.52) C: 1.91" (48.51)
Round Lighting Fixture Box To hang fixtures.	Office White	PT12LFB A: 5.31" (134.87) B: 1.04" (26.52)				

Fittings	Description	Color	Catalog Number	Description	Color	Catalog Number
	Internal Elbow, Cover Only For inside surfaces at right angles.	Office White	PT1IE A: 1.34" (34.04) B: 1.34" (34.04) C: 0.89" (22.61)	External Elbow, Cover Only For outside surfaces at right angles.	Office White	PT1EE A: 1.24" (31.50) B: 1.24" (31.50) C: 0.88" (22.35)
	Flat Elbow, Cover Only For right angle turns on same surface.	Office White	PT1FE A: 1.33" (33.78) B: 1.33" (33.78) C: 0.74" (18.80)	Tee, Cover Only For T-connection off PremiseTrak® Raceway.	Office White	PT1TC A: 1.77" (44.90) B: 1.33" (33.78) C: 0.74" (18.80)
	Splice Cover For covering potential openings where two lengths of raceway come together.	Office White	PT1SC A: 1.00" (25.40) B: 0.74" (18.80) C: 0.89" (22.61)	End Cap For closing end of raceway.	Office White	PT1EC A: 0.88" (22.35) B: 0.74" (18.80) C: 0.89" (22.61)
	Conduit Adapter/Ceiling Fitting For connecting conduit to raceway. Also use for ceiling feeds. Has combination ½ in., ¾ in. and 1 in. trade size KOs.	Office White	PT12CA A: 1.64" (41.66) B: 1.62" (41.15) C: 2.50" (63.50)			

Dimensions in Inches (mm)

PP1 PremiseTrak® (Latching)

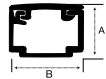
PP1 PremiseTrak®	Description	Color	Length	Without Adhesive	With Adhesive
	Base and Cover Single channel raceway. Available in 5 ft. (1.5m) and 7 ft. (2.1m) lengths.	Office White	5 ft. 7 ft.	PP1BC5 PP1BC7 A: 0.77" (19.56) B: 0.84" (21.34)	PP1ABC5 PP1ABC7 A: 0.77" (19.56) B: 0.84" (21.34)

	Description	Color	Catalog Number	Description	Color	Catalog Number
	Device Boxes	1-Gang Low Profile Box For shallow switches and receptacles. See page S-63 for recommended plate options.	Office White	PDB12LP A: 4.90" (124.46) B: 3.25" (82.55) C: 1.25" (31.75)	1-Gang Deep Box For deep devices or applications where additional room is beneficial. See page S-63 for recommended plate options.	Office White
1-Gang Standard Box For standard switches and receptacles. See page S-63 for recommended plate options.		Office White	PDB12S A: 4.90" (124.46) B: 3.25" (82.55) C: 1.78" (45.21)	Round Lighting Fixture Box To hang fixtures.	Office White	PDB12LF A: 5.31" (134.87) B: 1.29" (32.77)
2-Gang Deep Divided Box For deep switches, receptacles and communication devices. See page S-63 for single gang "KP" plate options. Comes with removable divider.		Office White	PDB12TGD A: 4.90" (124.46) B: 5.06" (128.52) C: 2.44" (61.98)	2-Gang Deep Undivided Box For low voltage applications only. Use with 2-gang "IFP" or "IMF" plates only. See page S-63 for details.	Office White	PDB12TGLV A: 4.90" (124.46) B: 5.06" (128.52) C: 2.44" (61.98)
Internal Elbow Full capacity 1¼ in. bend radius internal elbow.		Office White	PP1IE* PP1IEBC** A: 2.40" (60.96) B: 1.03" (26.16) C: 2.40" (60.96)	External Elbow Full capacity 1¼ in. bend radius external elbow.	Office White	PP1EE* PP1EEBC** A: 4.47" (113.54) B: 1.03" (26.16) C: 4.47" (113.54)
Fittings	Flat Elbow Full capacity 1¼ in. bend radius flat elbow.	Office White	PP1FE* PP1FEBC** A: 2.62" (66.55) B: 2.62" (66.55) C: 0.85" (21.59)	Tee Full capacity 1¼ in. bend radius tee.	Office White	PP1TC* PP1TCBC** A: 4.22" (107.19) B: 2.62" (66.55) C: 0.85" (21.59)
	Splice Cover For covering potential openings where two lengths of raceway come together.	Office White	PP1SC A: 1.09" (27.69) B: 1.02" (25.91) C: 0.85" (21.59)	End Cap For closing end of raceway.	Office White	PP1EC A: 1.00" (25.40) B: 0.84" (21.34) C: 0.77" (19.56)
	Conduit Adapter/Ceiling Fitting For connecting conduit to raceway. Also use for ceiling feeds. Has combination ½ in., ¾ in. and 1 in. trade size KOs.	Office White	PLP1CACF A: 2.29" (58.17) B: 3.31" (84.07) C: 3.90" (99.06)	Safety Strap For preventing potential tampering with PP1 PremiseTrak cover. Can also be used as a splice cover.	Office White	PP1SS A: 0.62" (15.75) B: 1.94" (49.28) C: 0.86" (21.84)

Note: *Cover only. **Base and Cover.

Dimensions in Inches (mm)

PL1 LANTrak® (Latching)

PL1 LANTrak®	Description	Color	Length	Without Adhesive	With Adhesive
	Base and Cover Single channel raceway. Available in 5 ft. (1.5m) and 7 ft. (2.1m) lengths.	Office White	5 ft. 7 ft.	PL1BC5 PL1BC7 A: 1.04" (26.42) B: 1.38" (35.05)	PL1ABC5 PL1ABC7 A: 1.04" (26.42) B: 1.38" (35.05)

Device Boxes	Description	Color	Catalog Number	Description	Color	Catalog Number	
	1-Gang Low Profile Box For shallow switches and receptacles. See page S-63 for recommended plate options.	Office White	PDB12LP	A: 4.90" (124.46) B: 3.25" (82.55) C: 1.25" (31.75)	1-Gang Deep Box For deep devices or applications where additional room is beneficial. See page S-63 for recommended plate options.	Office White	PDB12D
1-Gang Standard Box For standard switches and receptacles. See page S-63 for recommended plate options.	Office White	PDB12S	A: 4.90" (124.46) B: 3.25" (82.55) C: 1.78" (45.21)	Round Lighting Fixture Box To hang fixtures.	Office White	PDB12LF	
2-Gang Deep Divided Box For deep switches, receptacles and communication devices. See page S-63 for single gang "KP" plate options. Comes with removable divider.	Office White	PDB12TGD	A: 4.90" (124.46) B: 5.06" (128.52) C: 2.44" (61.98)	2-Gang Deep Undivided Box For low voltage applications only. Use with 2-gang "IFP" or "IMF" plates only. See page S-63 for details.	Office White	PDB12TGLV	
Fittings	Internal Elbow Full capacity 1¼ in. bend radius internal elbow.	Office White	PL1IE* PL1IEBC** A: 2.51" (63.75) B: 1.57" (39.88) C: 2.51" (63.75)	External Elbow Full capacity 1¼ in. bend radius external elbow.	Office White	PL1EE* PL1EEBC** A: 5.06" (128.52) B: 1.57" (39.88) C: 5.06" (128.52)	
	Flat Elbow Full capacity 1¼ in. bend radius flat elbow.	Office White	PL1FE* PL1FEBC** A: 3.19" (81.03) B: 3.19" (81.03) C: 1.11" (28.19)	Tee Full capacity 1¼ in. bend radius tee.	Office White	PL1TC* PL1TCBC** A: 4.75" (120.65) B: 3.15" (80.01) C: 1.11" (28.19)	
	Splice Cover For covering potential openings where two lengths of raceway come together.	Office White	PL1SC	A: 1.12" (28.45) B: 1.55" (39.37) C: 1.11" (28.19)	End Cap For closing end of raceway.	Office White	PL1EC
	Conduit Adapter/Ceiling Fitting For connecting conduit to raceway. Also use for ceiling feeds. Has combination ½ in., ¾ in. and 1 in. trade size KOs.	Office White	PLP1CACF	A: 2.29" (58.17) B: 3.31" (84.07) C: 3.90" (99.06)	Safety Strap For preventing potential tampering with PL1 LANTrak cover. Can also be used as a splice cover.	Office White	PL1SS

Note: *Cover only. **Base and Cover.

Dimensions in Inches (mm)

PW1 WallTrak® Low Profile (Latching)





PW1 WallTrak®	Description	Color	Length	Without Adhesive	With Adhesive
	Base and Cover Single channel raceway. Available in 5 ft. (1.5m) and 7 ft. (2.1m) lengths.	Office White	5 ft. 7 ft.	PW1BC5 PW1BC7 A: .50" (12.70) B: 1.19" (30.23)	PW1ABC5 PW1ABC7 A: .50" (12.70) B: 1.19" (30.23)

Device Boxes	Description	Color	Catalog Number	Description	Color	Catalog Number	
	1-Gang Low Profile Box For shallow switches and receptacles. See page S-63 for recommended plate options.	Office White	PW1LPB	A: 4.90" (124.46) B: 3.25" (82.55) C: 1.13" (28.70)	1-Gang Deep Box For deep devices or applications where additional room is beneficial. See page S-63 for recommended plate options.	Office White	PW1DBA
1-Gang Standard Box For standard switches and receptacles. See page S-63 for recommended plate options.	Office White	PW1SBA	A: 4.90" (124.46) B: 3.25" (82.55) C: 1.63" (41.40)	2-Gang Deep Box For deep devices or applications where additional room is beneficial. Uses 2-gang "KP" or "IFP" plates for power or data applications. See page S-63 for recommended plate options.	Office White	PW1TGB	
Round Lighting Fixture Box To hang fixtures.	Office White	PW1LFB	A: 5.31" (134.87) B: 1.04" (26.52)				
Fittings	Internal Elbow, Cover Only For inside surfaces at right angles.	Office White	PW1IE	A: 1.75" (44.45) B: 1.43" (36.32) C: 1.75" (44.45)	External Elbow, Cover Only For outside surfaces at right angles.	Office White	PW1EE
	Flat Elbow, Cover Only For right angle turns on same surface.	Office White	PW1FE	A: 2.18" (55.37) B: 2.18" (55.37) C: .60" (15.24)	Tee, Cover Only For T-connection off PremiseTrak® Raceway.	Office White	PW1TC
	Splice Cover For covering potential openings where two lengths of raceway come together.	Office White	PW1SC	A: 1.00" (25.40) B: 1.43" (36.32) C: .60" (15.24)	End Cap For closing end of raceway.	Office White	PW1EC
	Conduit Adapter/Ceiling Fitting For connecting conduit to raceway. Also use for ceiling feeds. Has combination ½ in., ¾ in. and 1 in. trade size KOs.	Office White	PW1CA	A: 1.40" (35.56) B: 2.34" (59.44) C: 3.22" (81.79)			

Dimensions in Inches (mm)

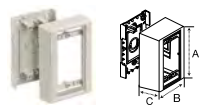
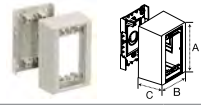
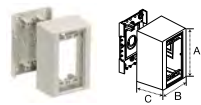
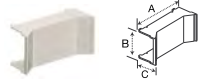
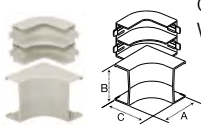
PW2 WallTrak® (Latching)

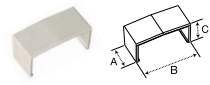
PW2 WallTrak®	Description	Color	Length	Without Adhesive	With Adhesive
	Base and Cover Two channel raceway. Available in 5 ft. (1.5m) and 7 ft. (2.1m) lengths.		Office White	5 ft. 7 ft.	PW2BC5 PW2BC7 A: 1.04" (26.42) B: 2.12" (53.85)

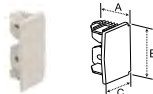
Device Boxes	Description	Color	Catalog Number	Description	Color	Catalog Number	
	1-Gang Low Profile Box For shallow switches and receptacles. See page S-63 for recommended plate options.		Office White	PDB12LP A: 4.90" (124.46) B: 3.25" (82.55) C: 1.25" (31.75)	Round Lighting Fixture Box To hang fixtures.	Office White	PDB12LF A: 5.31" (134.87) B: 1.29" (32.77)
1-Gang Standard Box For standard switches and receptacles. See page S-63 for recommended plate options. If using dual services, the PDB1DIV must be ordered.		Office White	PDB12S A: 4.90" (124.46) B: 3.25" (82.55) C: 1.78" (45.21)	2-Gang Deep Undivided Box For low voltage applications only. Use with 2-gang "IFP" or "IMF" plates only. See page S-63 for details.	Office White	PDB12TGLV A: 4.90" (124.46) B: 5.06" (128.52) C: 2.44" (61.98)	
1-Gang Deep Box For deep devices or applications where additional room is beneficial. See page S-63 for recommended plate options. If using dual services, the PDB1DIV must be ordered.		Office White	PDB12D A: 4.90" (124.46) B: 3.25" (82.55) C: 2.44" (61.98)	2-Gang Deep Divided Box For deep devices or applications where additional room is beneficial. See page S-63 for single gang "KP" plate options. Comes with removable divider. If using dual services, in a perpendicular run the PDB2DIV must be ordered.	Office White	PDB12TGD A: 4.90" (124.46) B: 5.06" (128.52) C: 2.44" (61.98)	
1-Gang Divider For use with PDB12S and PDB12D 1-gang boxes. Required when two services are passing through box.		Office White	PDB1DIV A: 2.79" (70.86) B: 1.40" (35.56) C: 0.94" (23.88)	2-Gang Divider For use with PDB12TGD 2-gang box only. Required when two services are passing through box and mounting devices perpendicular to raceway.	Office White	PDB2DIV A: 4.62" (117.35) B: 2.76" (70.10) C: 0.94" (23.88)	
Fittings	Internal Elbow Full capacity 1¼ in. bend radius internal elbow.		Office White	PW2IE* PW2IEBC** A: 2.83" (71.88) B: 2.32" (58.93) C: 2.83" (71.88)	External Elbow Full capacity 1¼ in. bend radius external elbow.	Office White	PW2EE* PW2EEBC** A: 5.00" (127.00) B: 2.32" (58.93) C: 5.00" (127.00)
	Flat Elbow Full capacity 1¼ in. bend radius flat elbow.		Office White	PW2FE* PW2FEBC** A: 3.94" (100.08) B: 3.94" (100.08) C: 1.11" (28.19)	Tee Full capacity 1¼ in. bend radius tee.	Office White	PW2TC* PW2TCBC** A: 5.42" (137.67) B: 3.91" (99.31) C: 1.90" (48.26)
	Splice Cover For covering potential openings where two lengths of raceway come together.		Office White	PW2SC A: 1.11" (28.19) B: 2.30" (58.42) C: 1.11" (28.19)	Safety Strap For preventing potential tampering with PW2 WallTrak Cover. Can also be used as a splice cover.	Office White	PW2SS A: 0.62" (15.75) B: 3.43" (87.12) C: 1.12" (28.45)
	Conduit Adapter/Ceiling Fitting For connecting conduit to raceway. Also use for ceiling feeds. Has combination ½ in., ¾ in. and 1 in. trade size KOs.		Office White	PW2CACF A: 4.18" (106.17) B: 3.32" (84.33) C: 4.20" (106.68)	Reducer Reduces from PW2 WallTrak Raceway to one or two PP1 PremiseTrak Raceway(s).	Office White	PW2RED A: 1.62" (41.15) B: 2.40" (60.96) C: 1.15" (29.21)
	End Cap For closing end of PW2 WallTrak Raceway.		Office White	PW2EC A: 1.00" (25.40) B: 2.14" (54.36) C: 1.04" (26.42)			

Note: *Cover only. **Base and Cover.

Dimensions in Inches (mm)

PB2 BaseTrak®

PB2 BaseTrak®	Description	Color	Length	Catalog Number	Description	Color	Length	Catalog Number	
	Base Two channel raceway. Available in 5 ft. (1.5m) and 10 ft. (3m) lengths.	Office White	5 ft. 10 ft.	PB2B5 PB2B10	A: 1.42" (36.07) B: 4.50" (114.30)	Cover Cover allows access to multiple channels. Available in 5 ft. (1.5m) and 10 ft. (3m) lengths.	Office White	5 ft. 10 ft.	PB2C5 PB2C10
	Assembled cover and base dimensions. W: 4.50" (114.30) H: 1.63" (41.40)				Split Cover Cover allows separation of channels and access to a single channel. Available in 5 ft. (1.5m) and 10 ft. (3m) lengths. Two split covers are required for each raceway section.	Office White	5 ft. 10 ft.	PB2SPL5 PB2SPL10	
								B: 4.50" (114.30) B: 2.22" (56.39)	

Device Boxes	Description	Color	Catalog Number
	2-Gang In-Line Box For switches, receptacles and communication devices. Provides flush look. See page S-63 for recommended single gang "KP" plate options.	Office White	PB2IND2G



A: 7.66" (194.56)
B: 4.74" (120.40)
C: 1.84" (46.74)

Fittings	Description	Color	Catalog Number	Description	Color	Catalog Number	
	Internal Elbow, Base and Cover Full capacity 1¼ in. bend radius internal elbow.	Office White	PB3IEBCA	A: 4.36" (110.74) B: 4.72" (119.89) C: 4.36" (110.74)	External Elbow, Base and Cover Full capacity 1¼ in. bend radius external elbow.	Office White	PB3EEBCA
	Flat Elbow, Base and Cover Full capacity 1¼ in. bend radius flat elbow.	Office White	PB3FEBCA	A: 7.64" (194.66) B: 7.64" (194.66) C: 1.71" (43.43)	Tee, Base and Cover Full capacity 1¼ in. bend radius tee.	Office White	PB3TCBCA
	Splice Cover For covering potential openings where two lengths of raceway come together.	Office White	PB3SC	A: 1.56" (39.62) B: 4.74" (120.40) C: 1.69" (42.93)	Safety Strap For preventing potential tampering with PB2 BaseTrak cover. Can also be used as a splice cover.	Office White	PB3SS
	Conduit Adapter/Ceiling Fitting For connecting conduit to raceway. Also use for ceiling feeds. Has combination ½ in., ¾ in., 1 in., 1¼ in. and 1½ in. trade size KOs.	Office White	PB2CACF	A: 4.72" (119.89) B: 5.22" (132.70) C: 6.30" (160.02)	Reducer Reduces from PB2 BaseTrak Raceway to PW2 WallTrak Raceway.	Office White	PB3REDA
	Transition Fitting Transitions horizontal PB2 BaseTrak to vertical PW2 WallTrak, PL1 LANTrak or PP1 PremiseTrak.	Office White	PB3TRBC	A: 3.22" (81.79) B: 7.28" (184.91) C: 2.42" (61.47)	Surface Panel Connector For connecting PB2 Raceway with surface type panel boxes.	Office White	PB3SPCA
	Wire Clip For holding conductors in place.	Office White	PB2WC	A: 1.29" (50.20) B: 1.00" (25.40)	End Cap For closing end of PB2 BaseTrak Raceway.	Office White	PB3ECA

Dimensions in Inches (mm)

PB3 BaseTrak®

	Description	Color	Length	Catalog Number	
PB3 BaseTrak®	Description				
	Base and Cover Three channel raceway. Available in 5 ft. (1.5m) and 10 ft. (3m) lengths.	Office White	5 ft. 10 ft.	PB3BC5 PB3BC10 A: 1.63" (41.40) B: 4.50" (114.30)	
Device Boxes	Full Capacity Boxes 1-, 2- and 3-Gang boxes that allows full capacity from PB3 Raceway to box for either power or datacom applications. See page S-63 for recommended single gang "KP" plate options.	Office White		PB3FCIB (1-Gang) A: 4.38" (111.25) B: 4.80" (121.92) C: 3.17" (80.52)	
				PB3FCIB2G (2-Gang) A: 7.20" (182.88) B: 4.80" (121.92) C: 3.17" (80.52)	
				PB3FCIB3G (3-Gang) A: 9.96" (252.98) B: 4.80" (121.92) C: 3.17" (80.52)	
	1-Gang In-Line Box For switches, receptacles and communication devices. Provides flush look. See page S-63 for recommended plate options.	Office White		PB3IND A: 4.90" (124.46) B: 3.25" (82.55) C: 1.25" (31.75)	
				2-Gang In-Line Box For switches, receptacles and communication devices. Barriers allow separation of power and datacom. Removal of barriers allows for expanded capacity. See page S-63 for recommended single gang "KP" plate options.	
		Office White		PB3IND2G A: 4.90" (124.46) B: 3.25" (82.55) C: 2.44" (61.98)	
	Fittings	Internal Elbow Full capacity 1¼ in. bend radius internal elbow.	Office White		PB3IE* PB3IEBCA** A: 4.36" (110.74) B: 4.72" (119.89) C: 4.36" (110.74)
					External Elbow Full capacity 1¼ in. bend radius external elbow.
			Office White		PB3EE* PB3EEBCA** A: 6.48" (164.59) B: 4.72" (119.89) C: 6.48" (164.59)
		Flat Elbow Full capacity 1¼ in. bend radius flat elbow.	Office White		PB3FE* PB3FEBCA** A: 7.64" (194.66) B: 7.64" (194.66) C: 1.71" (43.43)
				Tee Full capacity 1¼ in. bend radius tee.	
		Office White		PB3TCBCA** A: 7.37" (187.20) B: 7.08" (179.83) C: 2.72" (69.09)	
Splice Cover For covering potential openings where two lengths of raceway come together.		Office White		PB3SC* A: 1.56" (39.62) B: 4.74" (120.40) C: 1.69" (42.93)	
				Safety Strap Prevents potential tampering with PB3 BaseTrak cover. Can also be used as a splice cover.	
		Office White		PB3SS* A: 1.50" (38.10) B: 6.01" (152.65) C: 1.74" (44.20)	
Conduit Adapter/Ceiling Fitting For connecting conduit to raceway. Also use for ceiling feeds. Has combination ½ in., ¾ in., 1 in., 1¼ in. and 1½ in. trade size KOs.		Office White		PB3CACF** A: 4.72" (119.89) B: 5.22" (132.70) C: 6.30" (160.02)	
			Reducer Reduces from PB3 BaseTrak Raceway to PW2 WallTrak Raceway.		
	Office White		PB3REDA** A: 3.50" (88.90) B: 4.72" (119.89) C: 1.73" (43.94)		
Transition Fitting Transitions horizontal PB3 BaseTrak to vertical PW2 WallTrak, PL1 LANTrak or PP1 PremiseTrak.	Office White		PB3TRBC** A: 3.22" (81.79) B: 7.28" (184.91) C: 2.42" (61.47)		
			Transition Fitting Transitions from BT3 (old style) BaseTrak Raceway to PB3 (new style) BaseTrak Raceway.		
	Office White		BTPB3TF* A: 2.22" (56.39) B: 5.66" (143.76) C: 1.35" (34.29)		
Surface Panel Connector For connecting PB3 Raceway with surface type panel boxes.	Office White		PB3SPCA* A: 2.22" (56.39) B: 5.66" (143.76) C: 1.60" (40.64)		
			End Cap For closing end of PB3 BaseTrak Raceway.		
	Office White		PB3ECA* A: 2.02" (51.31) B: 4.68" (118.97) C: 1.72" (43.69)		
Wire Clip For holding conductors in place.	Office White		PB3WC A: 1.34" (34.10) B: 1.00" (25.40)		

Note: *Cover only. **Base and Cover.

Dimensions in Inches (mm)

PS3 Super BaseTrak®

PS3 BaseTrak®	Description	Color	Length	Catalog Number		
	Base and Cover Three channel raceway. Available in 5 ft. (1.5m) and 10 ft. (3m) lengths.	Office White	5 ft. 10 ft.	PS3BC5 PS3BC10 A: 1.97" (50.04) B: 6.70" (170.18)		
Device Boxes	Full Capacity Boxes 1-, 2- and 3-Gang boxes that allows full capacity from PS3 Raceway to box for either power or datacom applications. See page S-63 for recommended single gang "KP" plate options.	Office White	PS3FCIB (1-Gang) A: 4.38" (111.25) B: 6.95" (176.53) C: 3.46" (87.88)	PS3FCIB2G (2-Gang) A: 7.20" (182.88) B: 6.95" (176.53) C: 3.46" (87.88)	PS3FCIB3G (3-Gang) A: 9.96" (252.98) B: 6.95" (176.53) C: 3.46" (87.88)	
	3-Gang In-Line Box For any combination of power and datacom applications. Provides flush look. See page S-63 for recommended single gang "KP" plate options.	Office White	PS3IND A: 7.00" (177.80) B: 6.95" (176.53) C: 2.28" (57.91)			
Fittings	Internal Elbow Full capacity 1¼ in. bend radius internal elbow.	Office White	PS3IE* PS3IEBC** A: 4.36" (110.74) B: 6.93" (176.02) C: 4.36" (110.74)	External Elbow Full capacity 1¼ in. bend radius external elbow.	Office White	PS3EE* PS3EEBC** A: 6.81" (172.97) B: 6.93" (176.02) C: 6.81" (172.97)
	Flat Elbow Full capacity 1¼ in. bend radius flat elbow.	Office White	PS3FE* PS3FEBC** A: 9.85" (250.19) B: 9.85" (250.19) C: 2.08" (52.83)	Tee Full capacity 1¼ in. bend radius tee.	Office White	PS3TCBC** A: 10.00" (254.00) B: 9.68" (245.87) C: 3.30" (83.82)
	Splice Cover For covering potential openings where two lengths of raceway come together.	Office White	PS3SC* A: 1.56" (39.62) B: 6.95" (176.53) C: 2.03" (51.62)	Safety Strap Prevents potential tampering with PS3 Super BaseTrak cover. Can also be used as a splice cover.	Office White	PS3SS* A: 1.50" (38.10) B: 8.24" (209.30) C: 2.08" (52.85)
	Conduit Adapter/Ceiling Fitting For connecting conduit to raceway. Also use for ceiling feeds. Has combination ½ in., ¾ in., 1 in., 1¼ in. and 1½ in. trade size KOs.	Office White	PS3CACF** A: 6.93" (176.02) B: 4.32" (109.73) C: 6.29" (159.77)	Reducer Reduces from PS3 Super BaseTrak Raceway to PB3 BaseTrak Raceway.	Office White	PS3RED** A: 4.81" (122.17) B: 6.93" (176.02) C: 2.05" (52.07)
	Surface Panel Connector To connect PS3 Raceway with surface type panel boxes.	Office White	PS3SPC* A: 1.00" (25.40) B: 7.87" (199.90) C: 2.54" (64.52)	End Cap For closing end of PS3 Super BaseTrak Raceway.	Office White	PS3EC* A: 1.50" (38.10) B: 6.88" (174.75) C: 2.06" (52.32)
	Wire Clip For holding conductors in place.	Office White	PS3WC A: 1.62" (41.15) B: 1.00" (25.40)			

Note: *Cover only. **Base and Cover.

Dimensions in Inches (mm)

Non-Metallic Raceway



Non-Metallic PlugTrak®

Available in Standard, Isolated Ground (IG), Tamper-Resistant (TR) and USB (U) versions.



	Amp Circuits	Duplex Recept. Ports	USB Recept. Ports	Recept. Spacing (in.)	Color		
					Black	White	Office White
5 Foot Base and Cover	15 Single	5	—	12	PT155112BK	PT155112W	PT155112
	15 Two	5	—	12	PT155212BK	PT155212W	PT155212
	15 Single	4	—	15	PT155115BK	PT155115W	PT155115
	15 Single	2	—	30	PT155130BK	PT155130W	PT155130
	15 TR/Single	5	—	12	PT155112TRBK	PT155112TRW	PT155112TR
	20 Single	5	—	12	PT205112BK	PT205112W	PT205112
	20 Two	5	—	12	PT205212BK	PT205212W	PT205212
	20 Single	4	—	15	PT205115BK	PT205115W	PT205115
	20 Two	4	—	15	PT205215BK	PT205215W	PT205215
	20 Single	2	—	30	PT205130BK	PT205130W	PT205130
	20 TR/Single	5	—	12	PT205112TRBK	PT205112TRW	PT205112TR
	6 Foot Base and Cover	15 Single	6	—	12	PT156112BK	PT156112W
15 Two		6	—	12	PT156212BK	PT156212W	PT156212
15 Single		4	—	18	PT156118BK	PT156118W	PT156118
15 Single		3	—	24	PT156124BK	PT156124W	PT156124
15 USB/Single		4	4	12	PT156112UBK	PT156112UW	PT156112U
20 Single		9	—	8	PT206108BK	PT206108W	PT206108
20 Two		9	—	8	PT206208BK	PT206208W	PT206208
20 Single		6	—	12	PT206112BK	PT206112W	PT206112
20 Two		6	—	12	PT206212BK	PT206212W	PT206212
20 Single		4	—	18	PT206118BK	PT206118W	PT206118
20 Two		4	—	18	PT206218BK	PT206218W	PT206218
20 Single		3	—	24	PT206124BK	PT206124W	PT206124
20 Two	3	—	24	PT206224BK	PT206224W	PT206224	
20 Single	2	—	36	PT206136BK	PT206136W	PT206136	

Note: Each Non-Metallic PlugTrak is supplied with one PL1EC end cap and "IG" stickers for isolated ground applications.



	Length (ft.)	Cord Length (ft.)	Duplex Recept. Ports	USB Recept. Ports	Color			
					Black	White	Office White	
Portable	15	3	6	3	—	PT153112PBK	PT153112PW	PT153112P
	15	5	6	5	—	PT155112PBK	PT155112PW	PT155112P
	15	3	6	4	2	PT153112UPBK	PT153112UPW	PT153112UP
	20	3	6	2	—	PT203112PBK	PT203112PW	PT203112P
	20	5	6	5	—	PT205112PBK	PT205112PW	PT205112P
Supporting Mounting Clip for Portable PlugTrak.							PL1MC	

Note: Includes ON/OFF switch and circuit breaker.

	Descript.	Catalog No.	Descript.	Catalog No.
Device Boxes	1-Gang Low Profile	PDB12LP	1-Gang Deep	PDB12D
	1-Gang Standard	PDB12S	Round Lighting Fixture	PDB12LF
	2-Gang Deep Undivided	PDB12TGLV	2-Gang Deep Divided	PDB12TGD
Fittings	Internal Elbow Base and Cover	PL1IEBC	Internal Elbow Cover Only	PL1IE
	External Elbow Base and Cover	PL1EEBC	External Elbow Cover Only	PL1EE
	Flat Elbow Base and Cover	PL1FEBC	Flat Elbow Cover Only	PL1FE
	Tee Base and Cover	PL1TCBC	Tee Cover Only	PL1TC
	Splice Cover	PL1SC	Safety Strap	PL1SS
	Conduit Adapter/Ceiling Fitting	PT12CA	Conduit Adapter/Ceiling Fitting	PLP1CACF
	End Cap	PL1EC		

Note: For additional colors add "BK" for Black or "W" for white. See page S-56 for additional information.

Plates, Frames and Modular Connector Fittings

1-Gang and 2-Gang "KP" Plates	Color	Catalog Number	Catalog Number	Catalog Number	Catalog Number	Catalog Number
	Black	KP8BK	KP26BK	KP1BK	KP7BK	KP720BK
	White	KP8W	KP26W	KP1W	KP7W	KP720W
	Off. White	KP8 Duplex	KP26 Style Line®	KP1 Toggle	KP7 Recept. (1.41 ID)	KP720 Recept. (1.60 ID)
	Black	KP14BK	KP212BK	KP2140BK	KP2162BK	KP2163BK
White	KP14W	KP212W	KP2140W	KP2162W	KP2163W	
Off. White	KP14 Blank	KP212 Coax (2)	KP2140 Jack/Coax	KP2162 Modular Jacks (2)	KP2163 Modular Jacks (3)	
Black	KPORTBK	KPPANBK	KPIMBZBK			
White	KPORTW	KPPANW	KPIMBZW			
Off. White	KPORTOW Ortronics Series II® Data Module	KPPANOW Panduit Mini-Com® Data Module	KPIMBZOW 3-Unit iSTATION (Accepts all Hubbell iSTATION Modules located in Network Wiring section Y)			
Black	KP82BK	KP262BK	KP2BK	KP24BK		
White	KP82W	KP262W	KP2W	KP24W		
Off. White	KP82 2-Gang Duplex	KP262 2-Gang Style Line®	KP2 2-Gang Toggle	KP24 2-Gang Blank		

Note: 2-Gang "KP" plates, for use with PT12TGB and PW1TGB only.

Comm. "IFP" Plates & Frames	Color	Catalog Number	Catalog Number	Catalog Number	Catalog Number	Catalog Number
	Office	IFP126OW	ISF2OW	ISF3OW	ISF4OW	ISF6OW
	White	Style Line®	Style Line® 2-Port	Style Line® 3-Port	Style Line® 4-Port	Style Line® 6-Port
	Office	IFP18OW	BR106C	Q106O	IFP12OW	IFP13OW
	White	Duplex	Duplex 2-Port	Duplex 4-Port	Flush 2-Port	Flush 3-Port
	Office	IFP14OW	IFP16OW	IFP26OW	IFP29OW	IFP212OW
White	Flush 4-Port	Flush 6-Port	2-Gang 6-Port	2-Gang 9-Port	2-Gang 12-Port	

Frames & Modules	Description	Color	1-Gang	2-Gang
	Front loading plate will accept any modules in three unit combinations. Angled fixtures to be used in bottom opening only. See section Y for additional information on Hubbell iSTATION modules. Each gang accepts 3 module units.	Office White	IMF1OW	IMF2OW

Modular connectors to be used with any plate with a standard modular opening. Not recommended for use with KP plates. For KP applications use KPIMBZOW bezel and appropriate Hubbell iSTATION modules located in section Y. See section Y for additional information on modular connectors.

Modular Connector Fittings	Color	Catalog Number	Catalog Number	Catalog Number
	Office White	SFFX F-Connector	SFSTSOW ST Fiber Connector	SFB10 Blank (10 Pack)
	Black housing only	SFRC110R RCA 110 Punchdown	SFSV110BK Super S-Video	FASTSCDSC6 SC to ST Duplex Adapter

Xcelerator Modular Jacks	Color	Catalog Number	Catalog Number	Catalog Number
	Office White	HXJ5EOW Cat. 5e, T568A, T568B, RJ45	HXJ6OW Cat. 6, T568A, T568B, RJ45	HXJUOW 6 Position USOC, RJ25

Note: See section Y for additional Hubbell Xcelerator modular jacks and colors.

Panduit® and Mini-Com® are registered trademarks of Panduit Corp.
Ortronics® and Series II® are registered trademarks of Ortronics/Legrand.

Wire Fill Capacity Chart and Technical Information

Non-Metallic Raceway Wire Fill Capacities																
Series		Channel	Channel Area (sq. in.)	Power (THHN/T90 Nylon)			Voice		Data (Copper Cables)				Data (Multimode Fiber Optic Cables)			
				14 AWG	12 AWG	10 AWG	4-Pair	25-Pair	Type RG59U	Cat. 5e	Cat. 6	Cat. 6A	Cat. 6 STP	(2) or (4) Fiber Round Cable	Fiber Optic Jumpers	Fiber Optic Zip Cord
				Wire O.D. (in.):	0.111	0.13	0.164	0.19	0.41	0.242	0.21	0.25	0.35	0.29	0.19	0.118
		Wire Area (sq. in.):	0.0097	0.0133	0.0211	0.0283	0.1320	0.0460	0.0346	0.0491	0.0962	0.0660	0.0283	0.0109	0.0288	
			Wire Fill Capacity			40%	40%	40%	40%	40%	40%	40%	40%	40%	40%	
PT1	A	0.29	5	8	5	4	1	3	3	2	1	2	4	11	4	
PP1	A	0.38	12	11	8	5	1	3	4	3	2	2	5	14	5	
PL1	A	1.03	42	34	22	15	3	9	12	8	4	6	15	38	14	
PW1	A	0.30	6	10	4	4	0	2	3	2	1	2	4	11	4	
PW2	A+B	1.60	41	36	22	23	5	14	18	13	7	10	23	59	22	
A B	A	0.81	12	22	12	11	2	7	9	7	3	5	11	30	11	
	B	0.79	12	22	10	11	2	7	9	6	3	5	11	29	11	
PB2	A+B	5.72	60	36	45	81	17	50	66	47	24	35	81	210	79	
A B	A or B	2.86	42	30	28	40	9	25	33	23	12	17	40	105	40	
PB3	A+B+C	5.57	60	36	45	79	17	48	64	45	23	34	79	204	77	
A B C	A or C	1.80	42	30	28	25	5	16	21	15	7	11	25	66	25	
	B	1.97	42	30	28	28	6	17	23	16	8	12	28	72	27	
PS3	A+B+C	10.58	72	66	78	150	32	92	122	86	44	64	150	388	147	
A B C	A or C	3.41	42	36	42	48	10	30	39	28	14	21	48	125	47	
	B	3.76	42	36	42	53	11	33	43	31	16	23	53	138	52	

Note: Pathway (Raceway) fill shall be 40% maximum. Raceway fittings and outlets/receptacles reduce the cross section of the raceway system, thus reducing overall cable fill capacity.

Recommended Plate to Box Compatibility Selection Chart																
Non-Metallic Raceway Box Series		PS3 Series				PB3 Series					PB2 Series	PDB12 Series			PT12 & PW1 Series	
Plate Style	Sample Catalog Number	IND	FCIB	FCIB2G	FCIB3G	IND	IND2G	FCIB	FCIB2G	FCIB3G	IND2G	LP, S, D	TGD	TGLV	LP(B), S(BA), D(BA)	TGB
1-Gang KP Series Plate	KP8	X	X	X	X	X	X	X	X	X	X	X	X		X	
1-Gang KP Series Bezel	KPIMBZ	X	X	X	X	X	X	X	X	X	X	X	X		X	
1-Gang Standard Data Plate	IFP12OW		X	X	X	X		X	X	X		X			X	
1-Gang iSTATION Plate Frame	IMF1OW		X	X	X	X		X	X	X		X			X	
Style Line® Data Plate	IFP126OW		X	X	X	X		X	X	X		X			X	
Duplex Data Plate	IFP18OW		X	X	X	X		X	X	X		X			X	
2-Gang iSTATION Plate Frame	IMF2OW													X		X
2-Gang Standard Data Plate	IFP29OW													X		X
2-Gang KP Series Plate	KP82															X

Note: Hubbell Office White plates and devices color match all non-metallic raceway systems.

Physical Properties

(When tested in accordance with UL 5A)

Impact Resistance	5 ft. lbs.
Crush Resistance	300 lbs.
Temperature Range	-25.6° to 158° F
Flame Rating	UL94V-0
Material	UV Stabilized PVC

Codes/Standards

EIA/TIA	569A
UL Standard	UL 5A
Listings	E118895 / E119190
CSA Standard	C22.2 no. 62
Certified	LR87514

PlugTrak Specifications

Receptacle Rating	NEMA 5-15R & 5-20R
Wire	#12 AWG Stranded Copper
Receptacle Face	Thermoplastic

Non-Metallic Raceway

Pre-Wired Raceway Systems

Hubbell has been setting the standard in the electrical industry since 1888, through innovations such as Twist-Lock®, Hospital Grade, and AUTOGUARD™ Self Test GFCI receptacles. Again, Hubbell has listened to our customers for new innovation, capacity requirements, and flexibility. We have taken raceway systems to the next level with **Pre-Wired Raceway Systems** that are manufactured to your specifications.

Our Pre-Wired Raceway Systems will accommodate your power and data requirements as your facility changes over time. Pre-Wired Raceways provide you with the benefit of keeping your fast track projects on schedule, and helping complete the job on time! Our Pre-Wired Raceway solutions will save up to 45% of the installation time needed for field installing component raceway parts.

Pre-Wired Raceways are available in:

- ✓ Steel (Ivory and Gray)
- ✓ Aluminum (Satin Anodized)
- ✓ Non-Metallic (Office White)

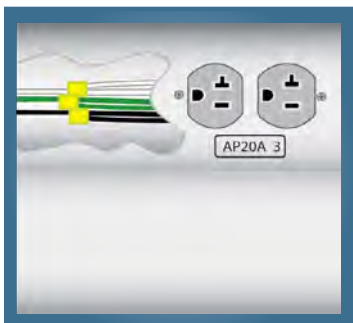

Quality by Design

All Hubbell Pre-Wired Raceways are UL Listed and CSA Certified. Each raceway receives a 100% quality inspection and testing prior to shipment. Pre-Wired Raceway is now available with the high quality and workmanship you have come to expect from Hubbell.



Labeling and Engraving

Optional labeling is available to identify branch panels and circuits at receptacle locations. Choose from adhesive labels or engraved aluminum plates.

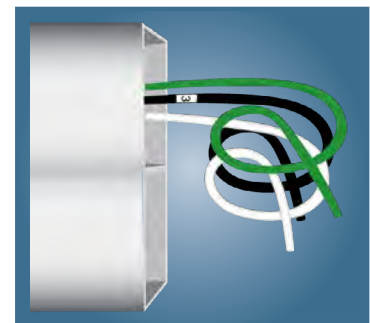

Wire Identification

Wire leads are clearly labeled with corresponding circuit numbers. This aids the installer when terminating to building wiring or connecting from duct to duct. Ample wire is provided at feed locations.

Pre-Wired Raceway Systems

Save Time and Money, Completing the Job Quicker and On Schedule, with Hubbell...

With Standard Raceway...



Unpack, identify and sort component parts.
Deliver components to work area for assembly and installation.



Measure and cut.
Clean and de-burr sharp edges.
Secure to the wall and fasten.



Pull wire.
Label and bundle each raceway circuit.
Install receptacles and test.

With Hubbell Pre-Wired Raceway...



Pallet delivered to your worksite, labeled by room, floor area and/or building.



Unpack and install!



Installed in half the time!

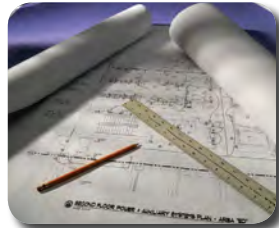

Project Support and Documentation

- ✓ A local and factory support team is there to assist in defining bills of material and project quotes, so costs can be budgeted accordingly.
- ✓ A project engineer, located at the factory, is assigned to your project as a direct point of contact.

Manufacturing and Testing

- ✓ Precisely measured, cleanly cut, wired and assembled to your specifications.
- ✓ The wiring harness is then bundled and labeled for circuit identification for ease of installation.
- ✓ Assembly is tested for assured continuity and 100% quality inspected before kitting.



Installs In A Snap

- ✓ Raceway ducts are kitted, labeled, and shipped by room, area or floor locations.
- ✓ Just remove raceway from the packaging and secure to the wall.
- ✓ Make power connections, snap on covers, test and you are done!



Options:



Circuit Identification and Labeling:

- ✓ Adhesive Labeling
- ✓ Engraving



Wiring Circuits Options:

- ✓ Insulation Displacement Connectors
- ✓ Wire Nuts
- ✓ Wiring Devices



Kit raceway for delivery by:

- ✓ Room
- ✓ Floor
- ✓ Area
- ✓ Building

Features and Benefits

Aluminum Pre-Wired Raceway (LINKOSITY® devices may be utilized with this Raceway Series)

HBLALU3800 Series Aluminum Raceway

Description

Aluminum Raceway, Single Channel,
Satin Anodized Finish.

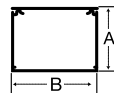

Dimension

A: 2.25" (57.15)
B: 3.00" (76.20)

HBLALU4800 Series Aluminum Raceway

Description

Aluminum Raceway, Two Channel,
Satin Anodized Finish.

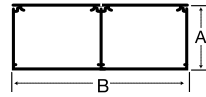

A: 2.25" (57.15)
B: 6.00" (152.40)

HBLALU5000 Series Aluminum Raceway

Description

Aluminum Raceway, Two Channel,
Satin Anodized Finish.

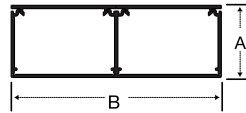

A: 1.75" (44.45)
B: 5.08" (129.03)

HBLALU7620 Series Aluminum Raceway

Description

Aluminum Raceway, Three Channel,
Satin Anodized Finish.

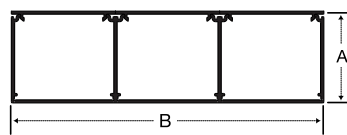

A: 2.25" (57.15)
B: 7.62" (193.55)

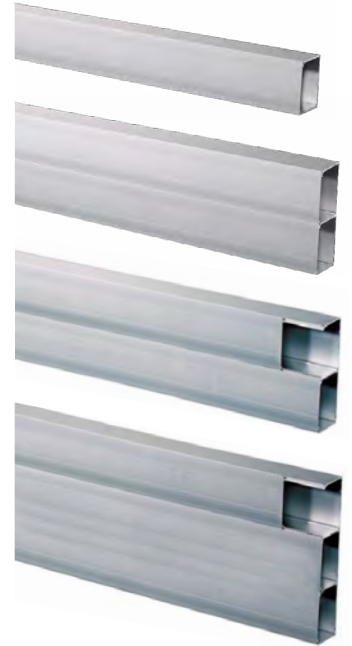

Steel Pre-Wired Raceway (LINKOSITY® devices may be utilized with this Raceway Series)

HBL3000 Series Metal Raceway

Description

Steel Raceway, Single Channel,
Ivory or Gray Finish.

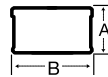

A: 1.53" (38.86)
B: 2.75" (69.85)

HBL4750 Series Metal Raceway

Description

Steel Raceway, Single or
Two Channel (with Divider),
Ivory or Gray Finish.

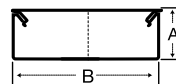

A: 1.75" (44.45)
B: 4.75" (120.65)

HBL6750 Series Metal Raceway

Description

Steel Raceway, Single,
Two Channel (with One Divider)
or Three Channel (with Two Dividers),
Ivory or Gray Finish.

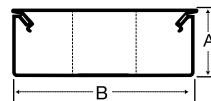

A: 2.22" (56.39)
B: 6.75" (171.45)

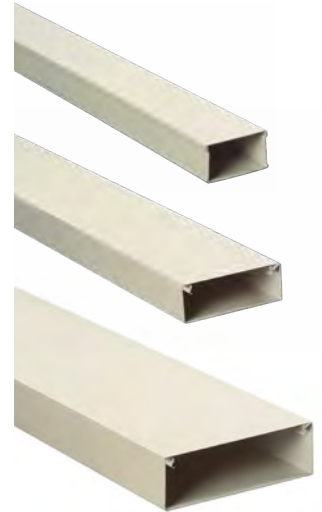

Non-Metallic Pre-Wired Raceway

PB2 BaseTrak® Series Non-Metallic Raceway

Description

Non-Metallic Raceway,
Two Channel,
Office White Color.

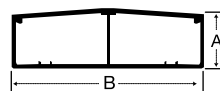

A: 1.63" (41.40)
B: 4.50" (114.30)

PS3 Super BaseTrak® Series Non-Metallic Raceway

Description

Non-Metallic Raceway,
Three Channel,
Office White Color.

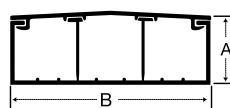

A: 1.97" (50.04)
B: 6.70" (170.18)



Dimensions in Inches (mm)

Features and Benefits



UL Listed Modular Pre-Wired Raceway Systems Featuring the Flexibility of LINKOSITY® Connections

Hubbell Pre-Wired Metal Raceway with LINKOSITY® connections is a Hubbell innovation providing a flexible, modular UL Listed System that allows users to relocate furniture and equipment without the need to access the internal wiring of the raceway. The inherent flexibility of this system greatly reduces the cost of installation and future end-user costs associated with re-configuring space.

The Hubbell Metal Raceway/LINKOSITY combination can be provided as a factory assembled system or by having a licensed electrician purchase and field install the required LINKOSITY components into the metal raceway.

Features	Benefits
UL Listed, NEC Compliant assemblies	Complete code compliance minimizes design time, startup costs and building inspector acceptance.
Flexible, modular terminations	Simplifies moves, adds and changes. Reduces long term total cost of ownership.
Pre-configured, factory wired	Minimizes field wiring. Devices are custom configured to the application, tested and ready to install.
Cable rated TC-ER, MTW, STOOW	One cable suitable for use in all commercial applications
In-line 106 data/communications frame	Data/Communications may be field installed anywhere along the raceway eliminating large boxes.



Device Type	Ratings	Wires	Conductor Colors**	Length (FT)
PH = Double Ended Cable with Male/Female Straight PM = Male Single Ended Straight PN = Male Single Ended 90° PF = Female Single Ended Straight PG = Female Single Ended 90° PQ = Double Ended Cable with Female 90° PR = Double Ended Cable with Male 90° PS = Double Ended Cable with (2) 90° Connectors RF = Female Receptacle* RM = Male Receptacle (Inlet)* <small>* 1/2 inch NPT rear thread</small>	20 = 20A up to 600V	02 03 04 05	PA = Green/Yellow Black (all others)	001 = 1' 005 = 5' 010 = 10' 015 = 15' 020 = 20' 025 = 25' 030 = 30' 035 = 35' 040 = 40' 045 = 45' 050 = 50'
	23 = 20A up to 600V Specialty construction (Includes isolated ground on 6 wire and 10AWG super neutral conductor on 5 and 6 wire devices)	03 04 05 06	PB = Green/Yellow White Black (all others)	
	30 = 30A up to 600V	04	PE = All Blue*** **other color codes available upon request. ***Two wire only.	



Cable Assemblies

The LINKOSITY® cable assemblies are code compliant with the NEC and NFPA 79, and suitable for use in virtually any environment as either a permanent or temporary installation.

Receptacles

The UL Listed LINKOSITY® male inlets or female receptacles provide the capability of interfacing directly with facility wiring by simply mounting into established fixed enclosures.

Closure Caps

Protects unused devices from the harmful effects of harsh environments.

Tees

Description	Catalog Number
LINKOSITY® M/F/F Tee, 20A, 2P	TX2002002002T00
LINKOSITY® M/F/F Tee, 20A, 3P	TX2003002003T00
LINKOSITY® M/F/F Tee, 20A, 4P	TX2004002004T00
LINKOSITY® M/F/F Tee, 20A, 5P	TX2005002005T00
LINKOSITY® M/F/F Tee, 20A SNIG, 4P	TX2304002304T00
LINKOSITY® M/F/F Tee, 20A SNIG, 6P	TX2306002306T00
LINKOSITY® M/F/F Tee, 20A SNIG, A Phase Tap	TX2306002304A00
LINKOSITY® M/F/F Tee, 20A SNIG, B Phase Tap	TX2306002304B00
LINKOSITY® M/F/F Tee, 20A SNIG, C Phase Tap	TX2306002304C00
LINKOSITY® M/F/F Tee, 30A, 4P	TX3004003004T00

Specifications

Material	
Raceway	Steel, Anodized Aluminum
LINKOSITY Cables	UL 600V Type TC-ER, MTW, STOOW, polyurethane overmolded terminations
Codes/Standards	
Raceway	UL5, surface metal raceway and fittings C22.2 no. 62, surface metal raceway and fittings TIA/EIA 569B, commercial building standard for telecom pathways and spaces
LINKOSITY	UL2238, UL50

FloorTrak™ PRO System

Modular On-Floor Power, Data and AV Delivery System

- cULus Listed
 - All In One Kits assembled from cULus Listed items
- ADA Compliant
- Power and Data Separations
- Abrasion Resistant Edges

Safely route power and data over floor and in floor with a low profile system

- Wall to conference table
- Under furniture
- Wall feeds in low and high profiles
- Removable dividers and knockouts



Left channel:	0.29 in ²	Up to 8x #12 THHN conductors
Center channel:	0.67 in ²	Up to 9x 0.215 inch diameter conductors
Right channel:	0.29 in ²	Up to 8x #12 THHN conductors

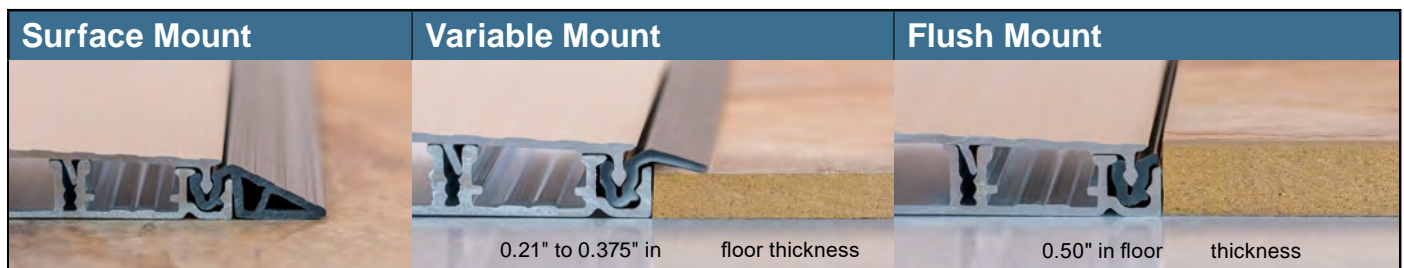

FloorTrak™ PRO System



FloorTrak™ PRO Track

- Include:**
- Precision cut extruded aluminum base and covers
 - Surface and variable edges
 - Splices included

Track	Description	Aluminum	Dark Gray
	6' Length, Base, Cover and Edges	HBLFMR6A	HBLFMR6DG
3' Length, Base, Cover and Edges	HBLFMR3A	HBLFMR3DG	
1' Length, Base, Cover and Edges	HBLFMR1A	HBLFMR1DG	
1', 2' & 3' Lengths, Base, Cover and Edges	HBLFMR123A	HBLFMR123DG	
Angles	45 Degrees	HBLFMC45A	HBLFMC45DG
	90 Degrees	HBLFMC90A	HBLFMC90DG
	T-Fitting	HBLFMTA	HBLFMTDG

Accessories	Description	Catalog Number
	Flush Mount Edges, 4 pieces, 3' each	HBLFMRFE
	Steel Splices, 6pk	HBLFMSPL

FloorTrak™ PRO Ends

- Include:**
- Cover with concealed hardware

Wall Feed	Description	Aluminum	Dark Gray
	Wall Feed, Low Profile	HBLFMWLA	HBLFMWLDG
	Wall Feed, High Profile	HBLFMWHA	HBLFMWHDG
Wall Feed, from Raceway	HBLFMWRA	HBLFMWRDG	

Accessories	Description	Catalog Number
	Track End Stop, Dark Gray	HBLFMES
	Track End with Cable Out, Dark Gray	HBLFMEX
	Transition Fitting for 4" Fire Rated Poke Thru, Dark Gray	HBLFMWPF
	Transition Fitting for PowerPole, Device Fitting included, Dark Gray	HBLFMWPB
	Transition Fitting for Conduit, Dark Gray	HBLFMWCF

All In One Kits

Prewired fitting and easy to configure kits with all components needed for a total solution that is ready to use.

- Include:**
- 1', 2', and 3' precision cut bases and covers
 - Surface mount and variable mount edge
 - Wired device fitting
 - Splices for Trak

Wired Device Box	Description	Aluminum	Dark Gray
	2 Gang: 2X NEMA 5-15R Duplex, 9'10" Cord	HBLFMPDD10A	HBLFMPDD10DG
	2 Gang: 2X NEMA 5-15R Duplex, 15'6" Cord	HBLFMPDD15A	HBLFMPDD15DG
	2 Gang: 1X NEMA 5-15R Duplex, 1 w/ USB, 9'10" Cord	HBLFMPUD10A	HBLFMPUD10DG
2 Gang: 1X NEMA 5-15R Duplex, 1 w/ USB, 15'6" Cord	HBLFMPUD15A	HBLFMPUD15DG	

FloorTrak™ PRO Device Fittings

- Include:**
- Configurable device fitting for configuring with power and data

Accessories	Description	Catalog Number
	2-Gang Deco: 1 Power & 1 Data	HBLFMD1P1D
	2-Gang Deco: 2 Power	HBLFMD2P
	2-Gang Deco: 2 Data	HBLFMD2D
	3-Gang Deco: 2 Power & 1 Data	HBLFMD2P1D
	3-Gang Deco: 1 Power & 2 Data	HBLFMD1P2D
2-Gang; 1 Deco, 1 KO (¾" + 1"): 1 Power & 1 Data	HBLFMD1D1K	



SECTION T

Table of Contents



Hubbell Trench Duct Series

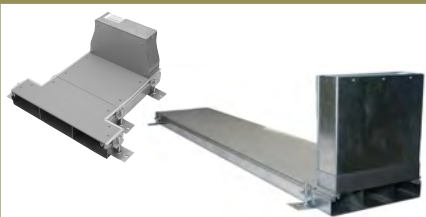

Hubbell Wall Duct Series



Hubbell Underfloor Duct Series



Hubbell Trench Duct Series	Page
Features and Benefits	T-3
Trench Duct Series and Fittings	T-4
Additional Trench Duct Fittings	T-5
Hubbell Wall Duct Series	
Features and Benefits	T-6
Wall Duct Series and Fittings	T-7
Wall Duct Fittings	T-8
Additional Wall Duct Fittings	T-9

Hubbell Underfloor Duct Series	Page
Features and Benefits	T-10
Conventional, Flush and Blank Profiles	T-11
Technical Information and Wire Fill Capacity Chart	T-12
Raceway Fittings	T-13
Raceway Junction Boxes and Accessories	T-14
Junction Box Dimensions	T-15
Raceway Activation Kits	T-16

Trench and Wall Duct Products

Products at a Glance



Hubbell Trench Duct Series

The Hubbell Trench system is an in-floor wire management system that meets today's high capacity wiring needs that require multiple circuit separation. Trench duct is commonly used as a feeder system for medical wall duct when installing radiology equipment such as X-Ray and MRI machines.



Hubbell Wall Duct Series

The Hubbell Wall Duct is available in either flush or surface mount and a combination will usually be required on any job. Vertical runs in the walls are usually flush mounted with horizontal runs on walls and all duct in ceiling plenum are typically surface type.



Hubbell Underfloor Duct Series

The Hubbell Underfloor Duct system is an in-slab wire management product for delivering power, voice and data services for applications that include retail facilities, open office workstations, fitness centers, casinos, medical facilities and libraries.

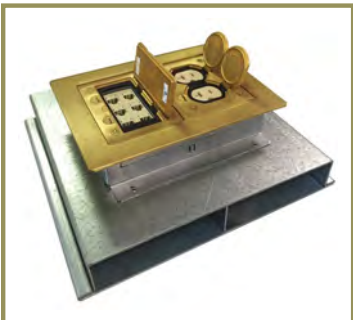

Underfloor Duct Raceway Activation Kits

- Available in brass and brushed aluminum to meet aesthetic requirements
- Available in one, two and three-gang options
- ScrubShield® Complies with UL514A scrub water requirements
- Flanged design may be used in tile, wood, carpet, terrazzo and bare concrete applications
- Uniform look when used in same areas where Hubbell floor boxes are installed

Trench and Wall Duct Products

Features and Benefits

A high capacity trench system for in-floor wire management.

The Hubbell Trench System is a UL listed in-floor wire management system that meets today's high capacity wiring needs requiring multiple circuit separation. Trench duct is commonly used as a feeder system for medical wall duct when installing radiology equipment, such as X-Ray and MRI machines. Trench duct is also used as a stand alone system for commercial and retail applications where ease of access and high capacity are crucial.



Multiple compartments provide more capacity than conventional ducts.

The Hubbell Trench System provides more capacity than conventional conduits and ducts. It features a single, high-capacity duct with multi-compartments for easy placement of additional wiring.

Its open top design allows wiring to be laid in the duct instead of being pulled, eliminating the need for junction boxes.

Removable covers are 1/4" thick and lock into the track of the trench. Internal dividers and/or support strips increase load capacity of heavy-duty covers. These removable covers allow free access to wiring and can be placed anywhere along the duct for easy wire exit relocation.

- High capacity design supports large wiring for single and multiple service requirements
- Open top design allows wire to be easily laid in duct
- Cover plates are removable and adjust horizontally to any point along the duct. Custom lengths of trench and fittings are available. Provided in either galvanized G90 steel or nonferrous aluminum.
- Multiple compartment options allows for multiple circuit and low voltage separation
- Innovative duct support assembly allows for pre-pour leveling
- Packaging and labeling by project floor and room is available

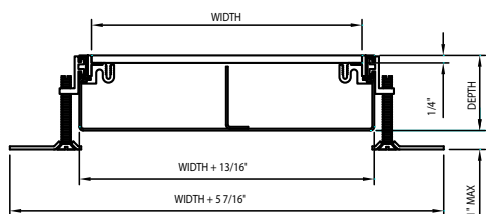
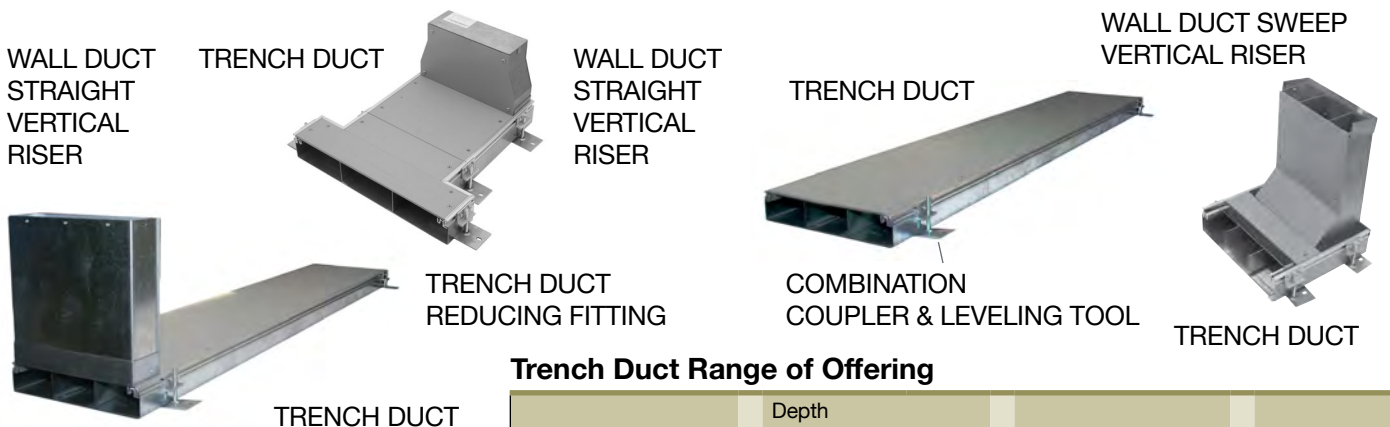

Trench Duct Range of Offering

Trench Product	Depth 1/2" Increments	Width	Compartments	Cover Plate
OKA = Trench	A = 2"	6	1C = 1 Compartment	1/4" = 1/4" thick
OKB = Pull Box	B = 2 1/2"	9	2C = 2 Compartment	
OKC = Exit Cover	C = 3"	12	3C = 3 Compartment	
OKE = End Cap	D = 3 1/2"	18	4C = 4 Compartment	
OKL = Horizontal L	E = 4"	24		
OKR = Vertical Riser	J = 6"	(Other Widths Avail.)		
OKT = T Junction Box	N = 8"	(Other Depths Available)		
OKX = X Junction Box				

Note: For Aluminum Trench Duct or Fittings, add "AL" suffix to catalog number.

Hubbell Trench Duct Series and Fittings

Ordering Information Notes:

1. Common use sizes are listed below. Contact factory for other configurations or see page 2 for Range of Offering table.
2. Trench Duct part numbers are for reference only. All Trench Duct orders are lot billed with a generic TW prefix project specific part numbers. Please contact your local Hubbell Territory Manager for all Hubbell Duct quotations.

Trench Duct	Description	Trench Depth	Cover Width	No. of Compartments	Catalog Number	
	Straight Section					
	Manufactured in standard 6' lengths with factory installed dividers.	2½"	9"	1	OKA/B9-1C-1/4	
	Provided with (3) leveling feet/couplers on each side, (3) 24" long cover plates and (3) cover plate joint protectors.	3"	9"	2	OKA/C9-2C-1/4	
	Leveling feet permits 1" of vertical pre-pour adjustment. Consult factory for additional vertical adjustment.	2½"	12"	2	OKA/B12-2C-1/4	
		3"	12"	3	OKA/C12-3C-1/4	
		2½"	18"	3	OKA/B18-3C-1/4	
		3"	18"	4	OKA/C18-4C-1/4	
		2½"	24"	3	OKA/B24-3C-1/4	
		3"	24"	4	OKA/C24-4C-1/4	

Note: For Aluminum Trench Duct or Fittings, add "AL" suffix to catalog number.

Fittings	Description	Outside Cover	No. of Compartments	Catalog Number	
	Horizontal "L" Fitting				
	Manufactured with a single cover and matching internal partitions to form a 90° horizontal "L".	12" x 12"	1	OKL/B9-1C-1/4	
	Includes cover plate joint protectors and leveling feet.	12" x 12"	2	OKL/C9-2C-1/4	
		15" x 15"	2	OKL/B12-2C-1/4	
		15" x 15"	3	OKL/C12-3C-1/4	
		21" x 21"	3	OKL/B18-3C-1/4	
		21" x 21"	4	OKL/C18-4C-1/4	
		27" x 27"	3	OKL/B24-3C-1/4	
		27" x 27"	4	OKL/C24-4C-1/4	
	Horizontal 45° Elbow Fitting	45°	1	OKL45/B9-1C-1/4	
	Manufactured with a split cover plate and matching internal partitions to form a 45° Mitered "L".	45°	2	OKL45/C9-2C-1/4	
	Other angles available. Includes cover plate joint protectors and leveling feet.	45°	2	OKL45/B12-2C-1/4	
		45°	3	OKL45/C12-3C-1/4	
		45°	3	OKL45/B18-3C-1/4	
		45°	4	OKL45/C18-4C-1/4	
		45°	3	OKL45/B24-3C-1/4	
		45°	4	OKL45/C24-4C-1/4	
	Single Level "T" Junction Fitting	15" x 12"	1	OKT/B9-1C-1/4	
	Manufactured with matching internal partitions and crossovers to isolate power and communications.	15" x 12"	2	OKT/C9-2C-1/4	
	Includes cover plate joint protectors and leveling feet.	18" x 15"	2	OKT/B12-2C-1/4	
		18" x 15"	3	OKT/C12-3C-1/4	
		24" x 21"	3	OKT/B18-3C-1/4	
		24" x 21"	4	OKT/C18-4C-1/4	
		30" x 27"	3	OKT/B24-3C-1/4	
		30" x 27"	4	OKT/C24-4C-1/4	
	Pull Box	9" x 12"	1	OKB/B9-1C-1/4	
	Manufactured to attach to trench section replacing end cap. Divided into compartments as required.	9" x 12"	2	OKB/C9-2C-1/4	
	Additional depth permits attachment of large conduits. Box is field punched for conduits.	12" x 12"	2	OKB/B12-2C-1/4	
	Standard depth is 6". Also available as a stand-alone	12" x 12"	3	OKB/C12-3C-1/4	
	SPOKB solid-sided floor box with trench rails on all 4 sides. Consult factory for details	18" x 12"	3	OKB/B18-3C-1/4	
		18" x 12"	4	OKB/C18-4C-1/4	
		24" x 12"	3	OKB/B24-3C-1/4	
		24" x 12"	4	OKB/C24-4C-1/4	

Exit Cover Fittings	Description	Trench Width	Catalog Number	
	Exit Cover			
	Designed to provide exit and feed for Trench Duct. Conduit openings are provided for power and communication exit or feed using conventional conduit fittings or service fittings. Exit Cover may be placed anywhere along the length of the trench. All Exit Covers are 6" long. Hole sizes and placement are specified at time of order.	9"	OKC/9-xx	
		12"	OKC/12-xx	
		18"	OKC/18-xx	
		24"	OKC/24-xx	
	Access Hood	9"	OKHOOD-9	
	Similar to Exit Cover except provided with a louvered opening for communication cables. Consult factory for custom Access Hoods.	12"	OKHOOD-12	
		18"	OKHOOD-18	
		24"	OKHOOD-24	

Hubbell Trench Duct Fittings

Ordering Information Notes:

1. Common use sizes are listed below. Contact factory for other configurations or see page 2 for Range of Offering table.
2. Trench Duct part numbers are for reference only. All Trench Duct orders are lot billed with a generic TW prefix project specific part numbers. Please contact your local Hubbell Territory Manager for all Hubbell Duct quotations.

	Description	Fits Trench Dim. (Width x Depth)	Max Trade Size Conduit	Catalog Number	
	End Cap	Fits over end of trench run to close trench and prevent foreign material from entering. End cap may be drilled to accept conduit.	9" x 2½" 9" x 3" 12" x 2½" 12" x 3" 18" x 2½" 18" x 3" 24" x 2½" 24" x 3"	¾" 1" ¾" 1" ¾" 1" ¾" 1"	
Fittings	Description	Outside Cover	No. of Compartments	Catalog Number	
	Single Level "X" Junction Fitting	15" x 15" 15" x 15" 18" x 18" 18" x 18" 24" x 24" 24" x 24" 30" x 30" 30" x 30"	1 2 2 3 3 4 3 4	OKX/B9-1C-1/4 OKX/C9-2C-1/4 OKX/B12-2C-1/4 OKX/C12-3C-1/4 OKX/B18-3C-1/4 OKX/C18-4C-1/4 OKX/B24-3C-1/4 OKX/C24-4C-1/4	
	Description	Fits Trench Width	No. of Compartments	Catalog Number	
	Vertical Riser Fitting (Straight)	9" 9" 12" 12" 18" 18" 24" 24"	1 2 2 3 3 4 3 4	OKR/D9-1C OKR/D9-2C OKR/D12-2C OKR/D12-3C OKR/D18-3C OKR/D18-4C OKR/D24-3C OKR/D24-4C	

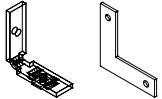
Additional Fittings	Description	Trench Width #1	Trench Width #2	Catalog Number	
	Reducer Fitting	Manufactured to transition from a wide trench duct width to a narrower trench duct width.	9" 12" 18" 24"	6" 9" 12" 18"	
Fastening Angles	Accessories to join trench sections for field fabrication of horizontal and vertical assemblies.	Horizontal Angle Vertical Angle	— —	OK/VWI OK/VVW	

Trench Duct Accessories	Description	Accessory Type	Catalog Number
	Permits 1" of pre-pour vertical adjustment and couples sections together. "x" represents screw height (max. 6") and height of trench. Additional vertical adjustment is available by increasing the length of screw "x".	Single Leveling Foot Assembly	OK/F-x
	Provides a 1½" wide surface (with gasket) for cover plate joints. "x" represents trench width.	Single Cover Plate Joint Protector	OK/DSD-x
	Separates trench duct compartments. "x" represents trench depth (see catalog number system).	Divider	OKP/x
Provided with ¼" x 18 bolts on 6" or 12" centers for increased cover plate weight loading capability.	Support Stud Strip	Consult Factory	

Tunnel Fittings	Description	Type	No. of Compartments	Catalog Number	
	Tunnels	Factory installed inside of multi-compartment "T" and "X" units to maintain separation of services. May be ordered separately and field installed.	"T" Unit "X" Unit	2, 3, or 4 2, 3, or 4	

Trench and Wall Duct Products

Features and Benefits

The Hubbell Wall Duct Series is a UL Listed metal raceway system designed for the enclosure of wiring for MRI or X-Ray equipment in medical applications. The system provides complete lay-in wiring capability in order to accommodate the large cables and connectors used in today's installations.



Hubbell Wall Duct is available in either flush or surface mount and a combination will usually be required on any job. Vertical runs in the walls are usually flush mounted with horizontal runs on walls and all duct in ceiling plenum are typically surface type.

Wall Duct is available in ferrous steel and non-ferrous aluminum versions.

- Lay in wiring accommodates large cables and connectors to connect equipment
- Corrosion resistant galvanized A60 steel or non ferrous aluminum versions
- Steel Wall Duct is provided with unpainted bodies and gray primed cover plates. Custom painted wall duct is available
- Flush (primarily wall) and Surface (primarily ceiling) mount provides flexibility to address specific equipment placement and unique room design requirements
- Hubbell Wall Duct is utilized with Hubbell Trench Duct
- Packaging and labeling by project floor and room is available

45 DEGREE
INTERNAL ELBOW

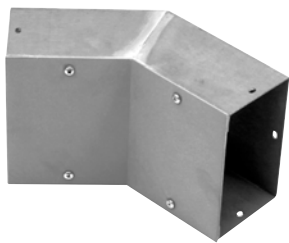

WALL DUCT WITH SPLIT
COVER PLATE

HORIZONTAL ELBOW

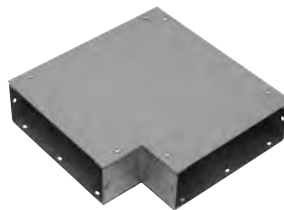

SWEEP
VERTICAL
RISER



TRENCH DUCT

Wall Duct Range of Offering

Wall Duct Product		Depth ½" Increments	Width	Cover Style
OWA = Wall Duct	OWI = Internal Elbow	A = 2"	6	S = Surface
OWB = Adapter	OWL = External Elbow	B = 2½"	10	F = Flush
OWC = Coupling	OWP = Partition	C = 3"	12	
OWD = Reducer Coupling	OWR = Vertical Riser	D = 3½"	18	
OWE = End Closure	OWT = T Unit	E = 4"	(Other	
OWF = Cabinet Connector	OWV = Trench to Wall Duct Adapter	J = 6"	Widths	
OWH = Horizontal Elbow	OWX = X Unit	N = 8"	Available)	
		(Other Depths Available)		

Note: For Aluminum Wall Duct or Fittings, add "AL" suffix to catalog number.

Hubbell Wall Duct Series and Fittings

Ordering Information Notes:

1. Common use sizes are listed below. Contact factory for other configurations or see page 5 for Range of Offering table.

2. Wall Duct part numbers are for reference only. All Wall Duct orders are lot billed with a generic TW prefix project specific part numbers.

Please contact your local Hubbell Territory Manager for all Hubbell Duct quotations.

Wall Duct	Description	Overall Depth	Body Width	Cover Width	Flush Catalog Number	Cover Width	Surface Catalog Number
	Wall and Ceiling Duct	3½"	9 ¹³ / ₁₆ "	12"	OWA/D10F	10"	OWA/D10S
	Manufactured in standard 60" lengths with two 30" long cover plates.	3½"	11 ¹³ / ₁₆ "	14"	OWA/D12F	12"	OWA/D12S
	Provided with one coupling and necessary screws.	3½"	17 ¹³ / ₁₆ "	20"	OWA/D18F	18"	OWA/D18S

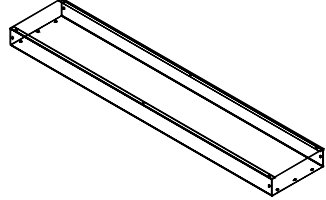

Note: For Aluminum Wall Duct or Fittings, add "AL" suffix to catalog number.

Elbow Fittings	Description	Overall Depth	Body Width	Cover Width	Flush Catalog Number	Cover Width	Surface Catalog Number
	Internal Elbow	3½"	9 ¹³ / ₁₆ "	12"	OWI/D10F	10"	OWI/D10S
	Forms a sharp 90° Internal "L"	3½"	11 ¹³ / ₁₆ "	14"	OWI/D12F	12"	OWI/D12S
	Provided with one cover plate, one coupling and necessary screws.	3½"	17 ¹³ / ₁₆ "	20"	OWI/D18F	18"	OWI/D18S
	Internal Elbow, Sweep	3½"	9 ¹³ / ₁₆ "	12"	OOWI/D10F	10"	OOWI/D10S
	Forms a chamfered 90° Internal "L" for increased cable bend radius.	3½"	11 ¹³ / ₁₆ "	14"	OOWI/D12F	12"	OOWI/D12S
	Provided with one cover plate, one coupling and necessary screws.	3½"	17 ¹³ / ₁₆ "	20"	OOWI/D18F	18"	OOWI/D18S
	Internal 45° Elbow	3½"	9 ¹³ / ₁₆ "	12"	OWI45/D10F	10"	OWI45/D10S
Forms a 45° Internal "L"	3½"	11 ¹³ / ₁₆ "	14"	OWI45/D12F	12"	OWI45/D12S	
Provided with one cover plate, one coupling and necessary screws. Also available as an External 45° elbow. Replace "OWI" with "OWL" in catalog number	3½"	17 ¹³ / ₁₆ "	20"	OWI45/D18F	18"	OWI45/D18S	
Horizontal Elbow	3½"	9 ¹³ / ₁₆ "	12"	OWH/D10F	10"	OWH/D10S	
Forms a 90° Horizontal "L"	3½"	11 ¹³ / ₁₆ "	14"	OWH/D12F	12"	OWH/D12S	
Provided with one cover plate, one coupling and necessary screws. Corner divider "OWCP" ordered separately.	3½"	17 ¹³ / ₁₆ "	20"	OWH/D18F	18"	OWH/D18S	
Horizontal 45° Elbow	3½"	9 ¹³ / ₁₆ "	12"	OWH45/D10F	10"	OWH45/D10S	
Forms a 45° Horizontal "L"	3½"	11 ¹³ / ₁₆ "	14"	OWH45/D12F	12"	OWH45/D12S	
Provided with one cover plate, one coupling and necessary screws.	3½"	17 ¹³ / ₁₆ "	20"	OWH45/D18F	18"	OWH45/D18S	
External Elbow	3½"	9 ¹³ / ₁₆ "	12"	OWL/D10F	10"	OWL/D10S	
Forms a sharp 90° External "L"	3½"	11 ¹³ / ₁₆ "	14"	OWL/D12F	12"	OWL/D12S	
Provided with two cover plates, one coupling and necessary screws.	3½"	17 ¹³ / ₁₆ "	20"	OWL/D18F	18"	OWL/D18S	

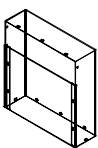
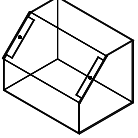
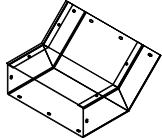
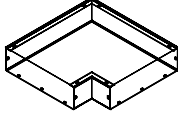
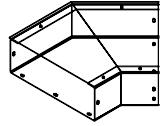
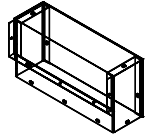
Note: Images shown are surface mount.

Hubbell Wall Duct Fittings

Ordering Information Notes:

1. Common use sizes are listed below. Contact factory for other configurations or see page 5 for Range of Offering table.
2. Wall Duct part numbers are for reference only. All Wall Duct orders are lot billed with a generic TW prefix project specific part numbers. Please contact your local Hubbell Territory Manager for all Hubbell Duct quotations.

	Description	Overall Depth	Body Width	Cover Width	Flush Catalog Number	Cover Width	Surface Catalog Number	
Internal / External Elbows	Internal / External Elbow	3½"	9 ¹³ / ₁₆ "	—	—	10"	SPOWI/D10S	
	Transitions from surface wall duct to surface style ceiling duct. Flush wall duct to surface style ceiling duct available upon request. Provided with two cover plates, one coupling and necessary screws.	3½"	11 ¹³ / ₁₆ "	—	—	12"	SPOWI/D12S	
		3½"	17 ¹³ / ₁₆ "	—	—	18"	SPOWI/D18S	
	Internal / External Elbow, Sweep	3½"	9 ¹³ / ₁₆ "	—	—	10"	SPOWSWI/D10S	
	Transitions from surface wall duct to surface style ceiling duct. Flush wall duct to surface style ceiling duct available upon request. Provided with two cover plates, one coupling and necessary screws.	3½"	11 ¹³ / ₁₆ "	—	—	12"	SPOWSWI/D12S	
		3½"	17 ¹³ / ₁₆ "	—	—	18"	SPOWSWI/D18S	
"T" Units	Vertical "T" Unit	3½"	9 ¹³ / ₁₆ "	12"	OWVT/D10F	10"	OWVT/D10S	
	Forms a 90° Vertical "T". Provided with three cover plates, two couplings and necessary screws.	3½"	11 ¹³ / ₁₆ "	14"	OWVT/D12F	12"	OWVT/D12S	
		3½"	17 ¹³ / ₁₆ "	20"	OWVT/D18F	18"	OWVT/D18S	
	Horizontal "T" Unit	3½"	9 ¹³ / ₁₆ "	12"	OWT/D10F	10"	OWT/D10S	
	Forms a 90° Horizontal "T". Provided with one cover plate, one coupling and necessary screws. Tunnels are ordered separately.	3½"	11 ¹³ / ₁₆ "	14"	OWT/D12F	12"	OWT/D12S	
		3½"	17 ¹³ / ₁₆ "	20"	OWT/D18F	18"	OWT/D18S	
"X" Unit	"X" Unit	3½"	9 ¹³ / ₁₆ "	12"	OWX/D10F	10"	OWX/D10S	
	Forms intersection of four perpendicular ducts. Provided with one cover plate, two coupling and necessary screws. Tunnels are ordered separately.	3½"	11 ¹³ / ₁₆ "	14"	OWX/D12F	12"	OWX/D12S	
		3½"	17 ¹³ / ₁₆ "	20"	OWX/D18F	18"	OWX/D18S	

	Description	For Trench Width	For Wall Duct (Width x Depth)	Flush Catalog Number	Surface Catalog Number	
Vertical Riser Fittings	Vertical Riser Fitting, Straight	10"	10" x 3½"	OWR/D10F	OWR/D10S	
	Transitions from trench duct to a vertical run of wall duct. Mounts on trench in place of cover. Removable front cover. Standard height above finish floor — 12" (7" for OWR/D12x10). Standard depth — 3½". Provided with one coupling and necessary screws.	12"	12" x 3½"	OWR/D12F	OWR/D12S	
		18"	18" x 3½"	OWR/D18F	OWR/D18S	
		12"	10" x 3½"	OWR/D12-10F	OWR/D12-10S	
	Vertical Riser Fitting, Sweep	10"	10" x 3½"	OWSWR/D10F	OWSWR/D10S	
	Transitions from trench duct to a vertical run of wall duct. Mounts on trench in place of cover. Removable front cover. Standard height above finish floor — 12". Standard depth — 3½". Provided with one coupling and necessary screws.	12"	12" x 3½"	OWSWR/D12F	OWSWR/D12S	
	18"	18" x 3½"	OWSWR/D18F	OWSWR/D18S		
	12"	10" x 3½"	OWSWR/D12-10F	OWSWR/D12-10S		

	Description	Overall Depth	Flush Wall Duct Body Width	Surface Cover Width	Catalog Number	
Adapter Fitting	Flush to Surface Adapter	3½"	9 ¹³ / ₁₆ "	10"	OWB/D10-10	
	Transitions from flush wall duct to perpendicular surface wall duct. Provided with one cover plate, two couplings and necessary screws.	3½"	11 ¹³ / ₁₆ "	18"	OWB/D12-18	
		3½"	17 ¹³ / ₁₆ "	12"	OWB/D18-12	
		3½"	17 ¹³ / ₁₆ "	18"	OWB/D18-18	

Hubbell Wall Duct Fittings

Ordering Information Notes:

1. Common use sizes are listed below. Contact factory for other configurations or see page 5 for Range of Offering table.
2. Wall Duct part numbers are for reference only. All Wall Duct orders are lot billed with a generic TW prefix project specific part numbers. Please contact your local Hubbell Territory Manager for all Hubbell Duct quotations.

Additional Fittings	Description	Overall Depth	Cover Width	Flush Catalog Number	Cover Width	Surface Catalog Number	
	End Cap Closes off end of wall duct. Screws provided.	3½"	12"	OWE/D10F	10"	OWE/D10S	
		3½"	14"	OWE/D12F	12"	OWE/D12S	
		3½"	20"	OWE/D18F	18"	OWE/D18S	
	Cabinet Connector Connects wall duct to enclosures. Designed to be positioned around outside surface of duct and secured with screws from inside of duct. Screws provided.	3½"	12"	OWF/D10	10"	OWF/D10	
		3½"	14"	OWF/D12	12"	OWF/D12	
		3½"	20"	OWF/D18	18"	OWF/D18	
Coupling Joins surface or flush wall duct sections together. Designed to be positioned around outside surface of duct and secured with screws from inside of duct. Screws provided.	3½"	12"	OWC/D10	10"	OWC/D10		
	3½"	14"	OWC/D12	12"	OWC/D12		
	3½"	20"	OWC/D18	18"	OWC/D18		
Trench to Wall Duct Adapter Transitions from trench duct to a vertical run of wall duct when not using the OWR or OKR series Vertical Risers. Mounts on trench in place of cover. Provided with necessary screws.	3½"	12"	OWV/D10	10"	OWV/D10		
	3½"	14"	OWV/D12	12"	OWV/D12		
	3½"	20"	OWV/D18	18"	OWV/D18		
Reducer Coupling Joins two sizes of surface or flush wall duct sections together. Designed to be positioned around outside surface of duct and secured with screws from inside of duct. Screws provided.	3½"	20" to 12"	OWD/D (18-10)	18" to 10"	OWD/D (18-10)		
	3½"	20" to 14"	OWD/D (18-12)	18" to 12"	OWD/D (18-12)		
Split Cover Plate Provides wire egress from raceway. Provided with assembly screws and grommet material.	—	12"	OWSC/10F	10"	OWSC/10S		
	—	14"	OWSC/12F	12"	OWSC/12S		
	—	20"	OWSC/18F	18"	OWSC/18S		

Note: Grommet material is available to cover field cut openings in Wall Duct. Outside dimensions of grommet is ¼" x 5/16" and is made from SBR rubber. Catalog number GROM-xx ("xx" represents length in feet).

Partitions Fittings	Description	For Overall Raceway Depth	For Fitting Style		
			Straight (Length 60")	Horizontal "L"	Internal Sweep Elbow
Internal Duct Partitions Divides raceway and fittings into compartments. Screws provided.	3½"	OWP/D	OWCP/D	OOWSWP/D	

Tunnel Fittings	Description	Type	No. of Compartments	Catalog Number	
	Tunnels Field installed inside of multi-compartment "T" and "X" units to maintain separation of services. May be factory installed.	"T" Unit		2, 3, or 4	Consult Factory
"X" Unit			2, 3, or 4	Consult Factory	

Underfloor Duct Products

Features and Benefits

Multi-Compartment Underfloor Duct Saves Time and Money for In-Slab Wire Management System

The Hubbell Underfloor Duct system is a UL listed in-slab wire management product for delivering power, voice and data services to applications that include retail facilities, open office workstations, fitness centers, casinos, medical facilities and libraries. This system is uniquely designed with multiple compartments, allowing unlimited design options and cost savings in labor and materials from other single-compartment systems. Matched with our strong national distribution and complete technical and application support, the Hubbell Underfloor Duct System is the perfect solution for your underfloor wire management needs.

- Eight duct profiles available to accommodate numerous in-slab wire management for power and communications.
- One-piece design multi-compartment duct, drastically reducing installation and material costs.
- Standard insert heights ranging from 1 to 3 inches (other heights available).
- Inclusive tile trim in square-top junction boxes, providing the installer the on-site option of using the trim or leaving it recessed.
- Combination duct coupler/support, reducing material and labor costs using the same part to join raceway sections together and to support/level the duct.
- Activation inserts are pre-assembled to the duct, or the inserts can be purchased separately for field installation only where you need them.
- Heavy duty junction boxes are available for areas requiring high-concentrated floor loads.
- Meets or exceeds UL 884 specifications, assuring a fully UL Listed system.

Flush Insert Duct Benefits

- Provides an aesthetic wire management solution for delivering power and communications services.
- Unique multi-gang flush inserts with removable voltage dividers provide the flexibility of installing multiple gangs of the same service at each insert location.
- Individual gangs can be activated as needed, to minimize costs.
- Activation trims accept standard Hubbell floor box covers for power and data, available in aluminum and brass.



ACTIVATION KIT

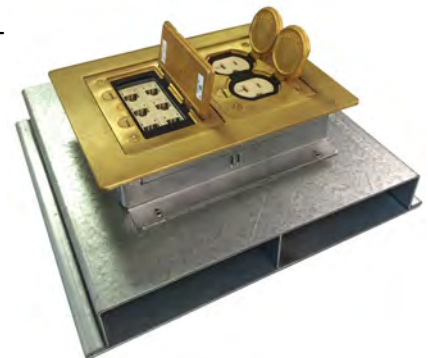

RECTANGULAR INSERT UNDERFLOOR DUCT

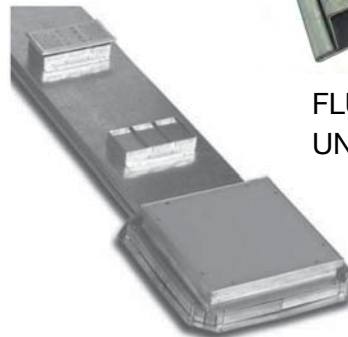

FLUSH INSERT UNDERFLOOR DUCT

JUNCTION BOX

ROUND INSERT UNDERFLOOR DUCT



Conventional, Flush and Blank Underfloor Duct Profiles

Ordering Information Note:

Floor Duct part numbers are for reference only. All Floor Duct orders are lot billed with a generic FD prefix project specific part numbers. Please contact your local Hubbell Territory Manager for all Hubbell Duct quotations.

- Provided in standard 10 ft. lengths
- 14 gauge, G90 galvanized steel
- 2 Inch IPS (Iron Pipe Size) round inserts are die-cast zinc. Reducing bushings provided by others
- Rectangular inserts are 14 gauge, G90 galvanized steel
- All duct profiles are available as Blank duct (no inserts), with factory installed 2" IPS Round Inserts or with Rectangular Inserts on 12" or 24" centers except as noted below. Consult factory for custom Insert spacing.

Catalog Number System

	SP202F -	2	-	12	
	Profile	Insert Height		Insert Spacing	
Round Insert Duct and Blank Duct	201				
	201W	B = Blank		12 = 12"	
	202	15 = 1 1/2"		24 = 24"	
	SP202	2 = 2"			
	202W	25 = 2 1/2"			
	203	3 = 3"		n/a for Blank Duct	
Flush Insert Duct	201F	B = Blank (203F only)		12 = 12"	
	201WF	1 = 1" (201F & 201 WF only)		24 = 24"	
	202F	15 = 1 1/2"			
	SP202F	2 = 2"			
	202WF	25 = 2 1/2"		n/a for Blank Duct	
	203F	3 = 3"			

Note: *Consult factory for heights greater than 3". ** 1 1/2" min. required for duplex receptacles.

Dimensions

201 & 201F

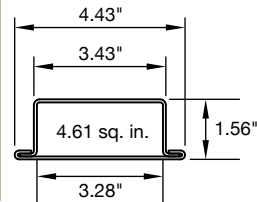

201W & 201WF

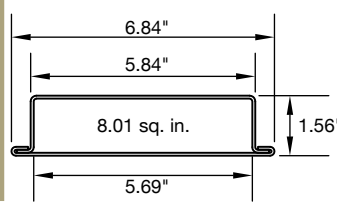

202 & 202F

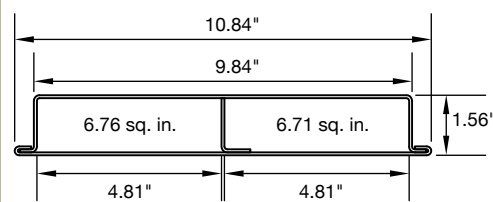

203 (Available only as Blank or with 2" IPS Round Inserts)

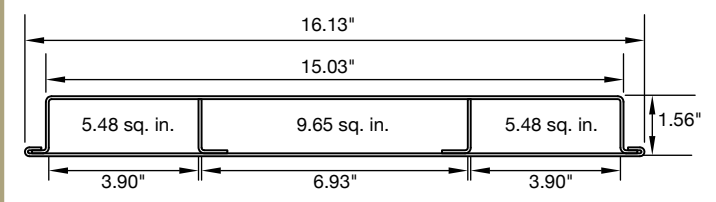

SP202 & SP202F

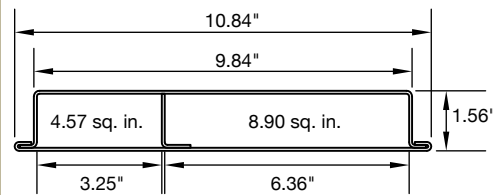

203F

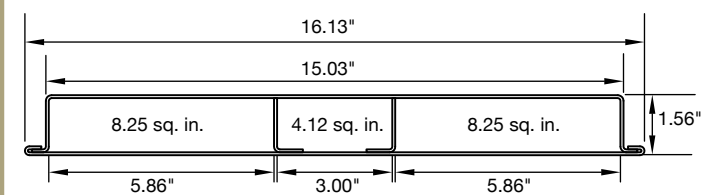

202W & 202WF

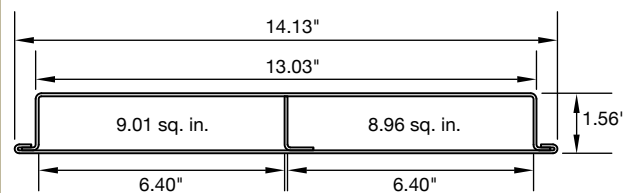

204 (Available only as Blank or with 2" IPS Round Inserts)

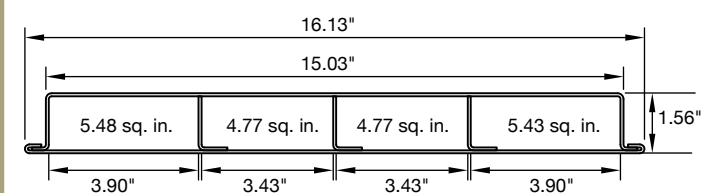

Technical Information and Wire Fill Capacity Chart

Ordering Information Note:

Floor Duct part numbers are for reference only. All Floor Duct orders are lot billed with a generic FD prefix project specific part numbers. Please contact your local Hubbell Territory Manager for all Hubbell Duct quotations.

Cable Type	Size	Approx. Dia. (in.)	Approx. Area (sq in.)	201		201W		202		SP202		202W		203			203F			204			
				201F	201WF	202F	202F	SP202F	SP202F	202WF	202WF	203			203F			204					
				4.61	8.01	6.76	6.71	4.57	8.9	9.01	8.96	5.48	9.65	5.48	8.25	4.12	8.25	5.48	4.77	4.77	5.43		
Channel	A	A	A	B	A	B	A	B	A	B	C	A	B	C	A	B	C	A	B	C	D		
Power (THHN)	14 AWG	0.111	0.0097	190	331	279	277	188	367	372	370	226	398	226	341	170	341	226	197	197	224		
	12 AWG	0.130	0.0133	138	241	203	202	137	268	271	270	165	290	165	248	124	248	165	143	143	163		
	10 AWG	0.164	0.0211	87	151	128	127	86	168	170	169	103	182	103	156	78	156	103	90	90	102		
	8 AWG	0.216	0.0366	50	87	73	73	49	97	98	97	59	105	59	90	44	90	59	52	52	59		
Coax Cables	RG-6/U	0.270	0.0573	32	55	47	46	31	62	62	62	38	67	38	57	28	57	38	33	33	37		
	RG-6/UQ	0.298	0.0697	26	45	38	38	26	51	51	51	31	55	31	47	23	47	31	27	27	31		
LAN Cables	Cat 5e	0.210	0.0346	53	92	78	77	52	102	104	103	63	111	63	95	47	95	63	55	55	62		
	Cat 6	0.250	0.0491	37	65	55	54	37	72	73	73	44	78	44	67	33	67	44	38	38	44		
	Cat 6A	0.350	0.0962	19	33	28	27	18	37	37	37	22	40	22	34	17	34	22	19	19	22		
Fiber Optic Distribution Cables	2-6 Strand	0.190	0.0284	65	113	95	94	64	125	127	126	77	136	77	116	58	116	77	67	67	76		
	8-12 Strand	0.230	0.0415	44	77	65	64	43	85	86	86	52	92	52	79	39	79	52	45	45	52		
	16-24 Strand	0.350	0.0962	19	33	28	27	18	37	37	37	22	40	22	34	17	34	22	19	19	22		

Note: Cable quantities shown in this chart are based on a 40% wire fill capacity. Sizes of COAX, LAN and Fiber Optic cables are provided for example only. Consult cable manufacturer's specification for exact cable sizes.

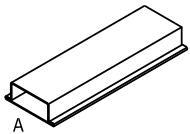

201 and 201F Series
Single Compartment

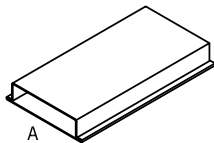

201W and 201WF Series
Single Wide Compartment

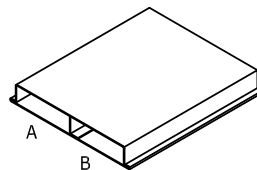

202 and 202F Series
Two Equal Compartments

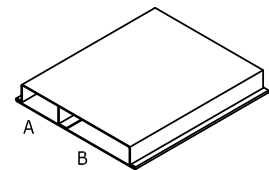

SP202 and SP202F Series
Modified Two Compartments

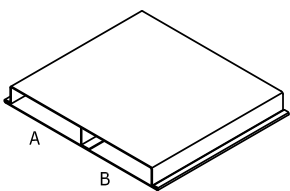

202W and 202WF Series
Two Equal Compartments

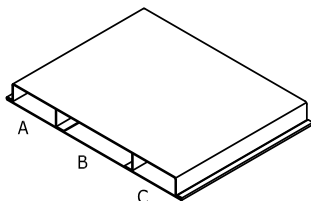

203 Series
Three Compartments

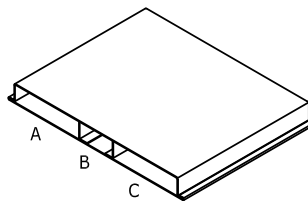

203F Series
Three Compartments

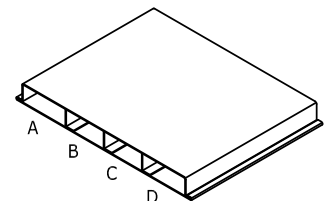

204 Series
Four Compartments

Applicable Codes & Standards

- TIA/EIA 569-C "Commercial Building Standard for Telecommunications Pathways and Spaces"
- NEC Article 390 "Underfloor Raceways"
- Ampacity derating rules of NEC applies to conductors installed in Underfloor Raceways and Trench Duct
- UL Standard UL 884 "Underfloor Raceways and Fittings"
- UL Listed E75939 (Underfloor Raceway) & E304554 (Underfloor raceway Fittings)

Underfloor Duct Raceway Fittings

Ordering Information Note:

Floor Duct part numbers are for reference only. All Floor Duct orders are lot billed with a generic FD prefix project specific part numbers. Please contact your local Hubbell Territory Manager for all Hubbell Duct quotations.

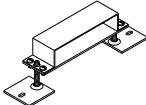
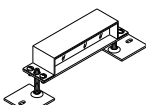
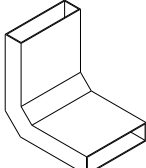
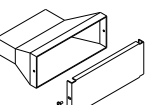
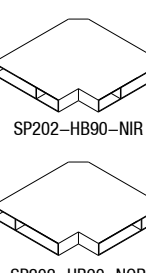
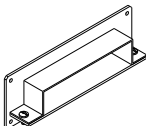
			Flush Insert Duct						Conventional Duct								
			201F	201WF	202F	SP202F	202WF	203F	201	201W	202	SP202	202W	203	204		
Coupler Support		Couples duct sections together and supports the duct. To be used every 5 feet of duct run.	201-DCS	●						●							
			201W-DCS		●						●						
			202-DCS			●	●					●	●				
			202W-DCS					●					●				
			203-DCS						●					●	●		
End Cap Support		Supports and closes unused duct ends.	201-ECS	●						●							
			201W-ECS		●						●						
			202-ECS			●	●					●	●				
			202W-ECS					●					●				
			203-ECS						●					●	●		
Vertical Riser		Transitions from duct embedded in concrete floor to vertical duct or may be used for direct connection to a Universal Conduit Adapter (UCA). Coupler / Supports (DCS) are required to attach to duct and UCA.	201-VEL	●						●							
			201W-VEL		●						●						
			202-VEL			●						●					
			SP202-VEL				●						●				
			202W-VEL					●					●				
			203-VEL						●					●			
			203F-VEL							●					●		
204-VEL								●					●				
Universal Conduit Adapter		Transitions from duct to conduit. A blank 14 gauge steel plate is provided for field punched conduit openings. For use with up to 2" trade size conduits. Consult factory for larger conduit accommodations. (may also be inserted directly into Junction Boxes)	201-UCA	●						●							
			201W-UCA		●						●						
			202-UCA			●						●					
			SP202-UCA				●						●				
			202W-UCA					●					●				
			203-UCA						●					●			
			203F-UCA							●					●		
204-UCA								●					●				
Horizontal 90 Degree Elbow		Provides a horizontal 90 degree turn in floor duct. No hand access provided. Consult factory for other angles. SP202-HB90's must be specified either with the Narrow Compartment located at the inside radius (-NIR) or at the outside radius (-NOR) as shown in illustration.	201-HB90	●						●							
			201W-HB90		●						●						
			202-HB90			●						●					
			SP202-HB90-NIR				●						●				
			SP202-HB90-NOR					●						●			
			202W-HB90					●					●				
			203-HB90						●					●			
			203F-HB90							●					●		
204-HB90								●					●				
Cabinet Connector		Provides a means for connecting duct to an electrical cabinet	201-DCC	●						●							
			201W-DCC		●						●						
			202-DCC			●	●					●	●				
			202W-DCC					●					●				
			203-DCC						●					●	●		



Underfloor Duct Raceway Junction Boxes and Accessories

Ordering Information Note:

Floor Duct part numbers are for reference only. All Floor Duct orders are lot billed with a generic FD prefix project specific part numbers. Please contact your local Hubbell Territory Manager for all Hubbell Duct quotations.

x = Preset Insert Height
 1 = 1" (201F & 201WF only)
 15 = 1 1/2" (min. required for duplex recept.)
 2 = 2"
 25 = 2 1/2"
 3 = 3" (consult factory for heights greater than 3")

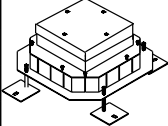
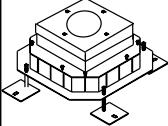
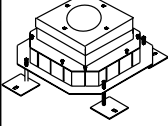
Underfloor Duct Raceway Junction Boxes and Accessories

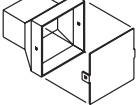
Junction Box Square Access 	For providing square opening access at intersections of Feeder Duct and Distribution Duct	201-JB-x
		201W-JB-x
		202-JB-x
		SP202-JB-x
		202W-JB-x
		203-JB-x
		203F-JB-x
Junction Box Round Access 	For providing round opening access at intersections of Feeder Duct and Distribution Duct. Provided with Brass or Stainless Steel Carpet Ring *Available in Stainless Steel. To order replace B with SS	201-JB-x-RCB*
		201W-JB-x-RCB*
		202-JB-x-RCB*
		SP202-JB-x-RCB*
		202W-JB-x-RCB*
		203-JB-x-RCB*
		203F-JB-x-RCB*
Junction Box Heavy Duty Round Access 	Same as above except cover plates are 3/8" thick and after-pour height adjustable. Carpet Rings and Closure Caps must be ordered separately. Duct Entrance Cap - HDJBDC Corner Cap - HDJBCC	202-JB-x-HD-ADJ
		SP202-JB-x-HD-ADJ
		202W-JB-x-HD-ADJ
Carpet Ring for Heavy Duty Junction Boxes 	1/8" thick Carpet Trim for Heavy Duty Junction Boxes. *Available in Stainless Steel. To order replace BRASS with SS	RD-BRASS*-202-ADJ
		RD-BRASS*-SP202-ADJ
		RD-BRASS*-202W-ADJ
Junction Box Corner Conduit Adapter 	Provides attachment point for conduit to each corner of all junction boxes. JB-CCA is provided with 14 gauge steel plate for field punched conduit opening. All other adapters are factory punched.	JB-CCA
		JB-CCA-1/2
		JB-CCA-3/4
		JB-CCA-1
		JB-CCA-1-1/2
		JB-CCA-2

Flush Insert Duct						Conventional Duct						
201F	201WF	202F	SP202F	202WF	203F	201	201W	202	SP202	202W	203	204
●						●						
	●						●					
		●						●				
			●						●			
				●						●		
					●						●	
												●

Hubbell Trench Duct is commonly used as a feeder system for Underfloor Duct Raceway systems.



Factory assembled Trench/Underfloor duct intersect units allow unrestricted capacity by the elimination of tunnels. Side mounted Underfloor duct is available for shallow concrete pours. Consult factory for details.

- High capacity design supports large cables for single and multiple service requirements.
- Open top design allows cables to be easily laid in duct.
- Cover plates are removable and adjust horizontally to any point along the duct.
- Custom lengths of trench and fittings are available.
- Multiple compartments allow complete separation of services.
- Innovative duct support assembly allows for pre-pour leveling and acts as a splice for duct sections.

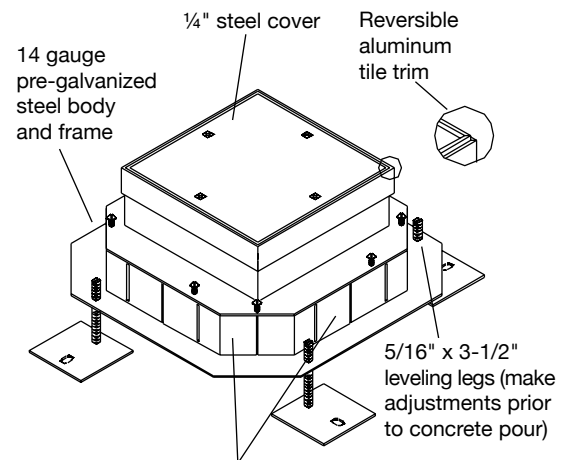

Removable pry-out sections for corner conduit adapters (JB-CCA series) and duct entrances. Additional blanking plates not required for unused junction box entrances. Blanking plates must be ordered separately for heavy duty junction boxes.

Underfloor Duct Junction Box Dimensions

Ordering Information Note:

Floor Duct part numbers are for reference only. All Floor Duct orders are lot billed with a generic FD prefix project specific part numbers. Please contact your local Hubbell Territory Manager for all Hubbell Duct quotations.

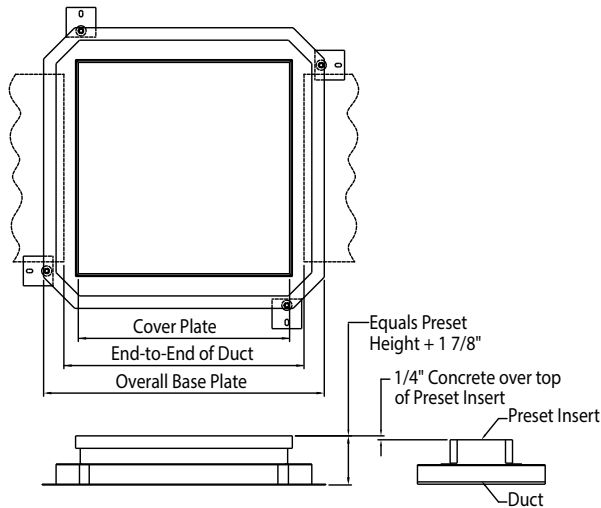

Junction Box Catalog Number	Cover Plate	End-To-End Of Duct	Overall Base Plate
201-JB-x 201-JB-x-RCx	6 ⁵ / ₁₆ "	8"	10 ¹ / ₂ "
201W-JB-x 201W-JB-x-RCx	12 ⁹ / ₁₆ "	14 ¹ / ₂ "	17 ¹³ / ₁₆ "
202-JB-x 202-JB-x-RCx			
SP202-JB-x SP202-JB-x-RCx			
202W-JB-x 202W-JB-x-RCx	17"	19 ⁵ / ₈ "	22 ¹¹ / ₁₆ "
203-JB-x 203-JB-x-RCx			
203F-JB-x 203F-JB-x-RCx			
204-JB-x 204-JB-x-RCx			
202-JB-x-HD-ADJ SP202-JB-x-HD-ADJ	14"	15 ¹ / ₈ "	18 ¹ / ₂ "
202W-JB-x-HD-ADJ	17"	18 ¹ / ₈ "	21 ¹ / ₂ "

Underfloor Duct Raceway Aftersets and Marker Caps





	Flush Insert Duct	Description	Catalog Number		
Afterset Insert		Provides means to add activation inserts in the field where needed prior to concrete pour. 14 gauge steel.	1-Gang	1 1/2" Insert Height	DAIFA-1G-15
				2" Insert Height	DAIFA-1G-2
				3" Insert Height	DAIFA-1G-3
			2-Gang	1 1/2" Insert Height	DAIFA-2G-15
				2" Insert Height	DAIFA-2G-2
				3" Insert Height	DAIFA-2G-3
			3-Gang	1 1/2" Insert Height	DAIFA-3G-15
				2" Insert Height	DAIFA-3G-2
				3" Insert Height	DAIFA-3G-3
Marker Cap		Marker caps are used in place of standard insert caps in (a) each insert adjacent to junction box, (b) inserts on each side of a permanent wall, and (c) the last insert in each run of duct.	Insert Marker Cap:		
			Zinc Screw	FA-DMC-Z	
			Brass Screw	FA-DMC-B	
Compartment Cover		Used for abandoning preset opening (one per gang). 18 gauge steel. Customer is required to fill void over top of plate with concrete.	Blank Cover	FA-MC	

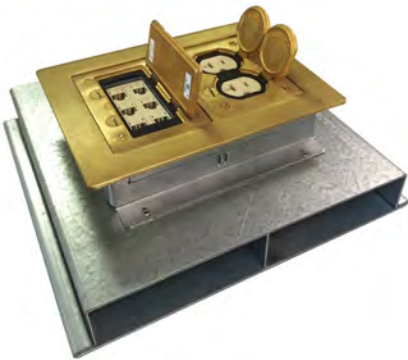



	Round Insert Duct (Reducing Bushings Provided By Others)	Description	Catalog Number	
Afterset Insert		Provides means to add activation inserts in the field where needed prior to or after concrete pour. Zinc die cast.	2" Insert Height	DAI-2
			3" Insert Height	DAI-3
			4" Insert Height	DAI-4
Marker Cap		Marker caps are used in place of standard insert caps in (a) each insert adjacent to junction box, (b) inserts on each side of a permanent wall, and (c) the last insert in each run of duct.	Insert Marker Cap:	
			Zinc Screw	DMC-Z
			Brass Screw	DMC-B

Underfloor Duct Raceway Activation Kits



- Available in brass and brushed aluminum to meet aesthetic requirements
- Available in one, two and three-gang options
- Available with beveled edges. Consult factory for details
- ScrubShield® Complies with UL514A scrub water requirements
- Flanged design may be used in tile, wood, carpet, terrazzo and bare concrete applications
- Uniform look when used in same areas where Hubbell floor boxes are installed
- Blank Closure Plates are available to close off insert opening when abandoning Activation Kits. Plates are available in single, double and triple-gang configurations in brass, aluminum and stainless steel. Consult factory for additional information.

Flush Insert Underfloor Duct		Finish	1-Gang 6" x 4.85"	2-Gang 6" x 8.13"	3-Gang 6" x 11.34"	
Flanges	Flanges are provided with adapter plates and accessories required for installing to rectangular Underfloor Duct preset inserts and aftersets.	Brass	SB3083W-UFD	SB3084W-UFD	SB3085W-UFD	
		Aluminum	SA3083W-UFD	SA3084W-UFD	SA3085W-UFD	
						
Covers	All Covers 4.15" x 2.99"		Duplex Flap	Duplex Screw	Style Line Decorator Opening	Combination 2 1/8" x 3/4"
		Brass	S3825	S3625	S3826	S2425
		Aluminum	SA3825	SA3625	SA3826	SA2425
						
			Combination 2 1/8" x 1"	2 1/8" Single Receptacle	2 3/8" Single Receptacle	Blank
		Brass	S2625	S2825	S3425	S3813
		Aluminum	SA2625	—	—	SA3813
						

Round Insert Underfloor Duct								
Housing	Die-cast aluminum frame, brushed aluminum housing, chase nipple, without plates	1" Chase Nipple	SC3099A					
		3/4" Chase Nipple	SC3098A					
Plates	Duplex Receptacle	Single Receptacle 1.39" (35.3 mm) opening	Style Line Decorator	Blank	Telephone bushing 1 in. I.D. and (2) 3/8" KO for coax	Furniture Feed aluminum plate with 3/4" trade size KO	Furniture Feed aluminum plate, blank	
		SS309D	SS309S	SS309DS	SS309B	SS309T	SS309SF	SS309BF
								

SECTION U

Table of Contents

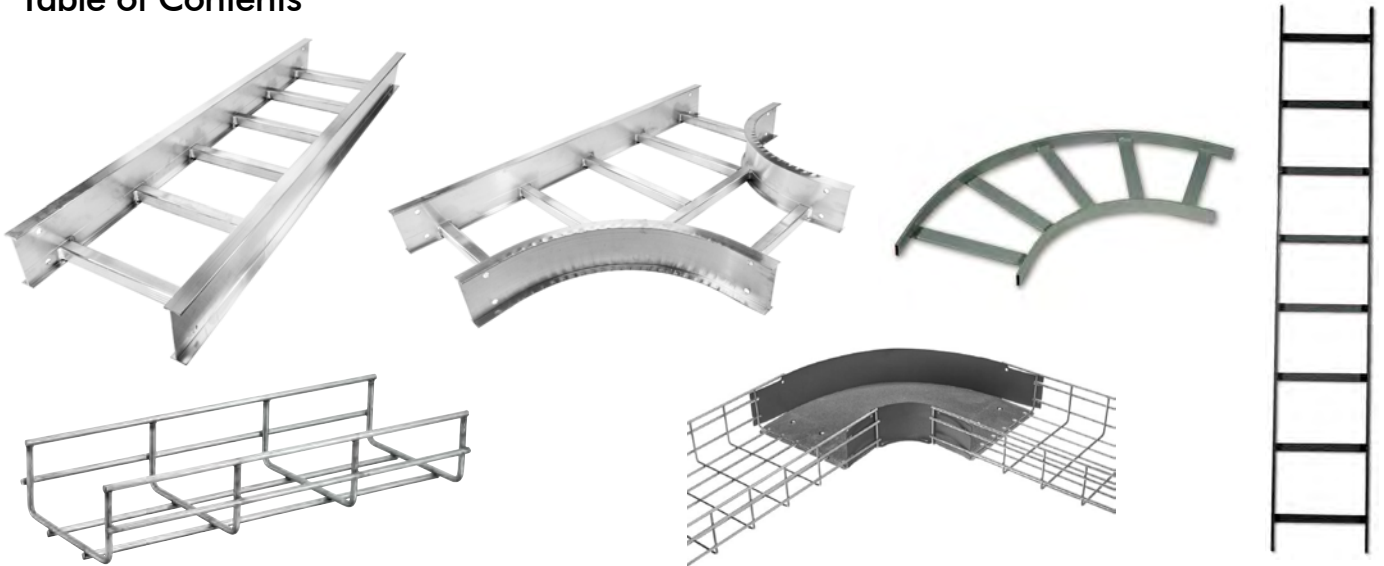

Round and Flat Style Wire Basket Tray

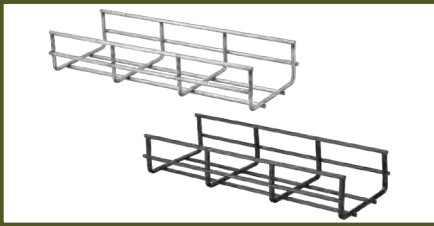

Aluminum Ladder Tray

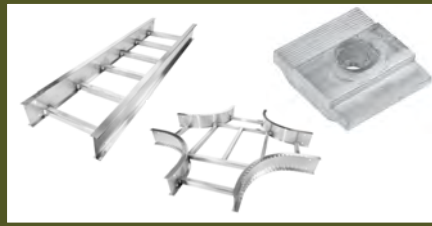

Steel Ladder Rack



Product	Page
Innovative, Flexible, Field-Configurable Wire Basket Solutions	U-2
Round Cross-Wire Basket Tray	U-3
Electroplated Zinc Round Cross-Wire Basket Tray	U-4
Flat Style Cross-Wire Basket Tray	U-5
Stainless Steel Round Cross-Wire Basket Tray	U-6
Under Floor Round Cross-Wire Basket Tray	U-7
Accessories for Wire Basket Tray	
Preformed Fittings	U-8
Supports and Brackets	U-10
Covers and Inserts	U-11
Supports and Fittings	U-12
Technical Support, Cutting and Forming Fittings	U-13
Wire Fill and Maximum Load Chart	U-14
Wire Basket Tray Technical Specifications	U-15

Product	Page
Aluminum Ladder Tray	U-16
Straight Sections	U-17
Fittings, Horizontal Elbows	U-18
Fittings, Vertical Outside Elbows	U-20
Fittings, Reducers	U-21
Fittings, Tees	U-22
Fittings, Cross	U-25
Accessories for Aluminum Ladder - Dividers	U-27
Accessories for Aluminum Ladder - Covers	U-28
Accessories for Aluminum Ladder - Supports	U-33
Accessories for Aluminum Ladder - Accessories	U-34
Steel Ladder Rack	U-36

Wire Basket Tray System

Innovative, Flexible, Field-Configurable Wire Basket Solutions

Support Broad Range of Applications

Hubbell Wiring Systems offers a comprehensive Wire Basket Tray System to handle every application. From pre-galvanized solutions for commercial controlled interior environments to stainless steel versions for industrial applications such as food processing, marine and highly corrosive environments. Hubbell also features labor savings options including No-Splice supports which also reduce material cost and preformed fittings which offer tremendous productivity enhancement to the installer by eliminating field cuts that are required when fittings are configured in the field. Hubbell also offers painted trays in virtually any color needed. The painted tray is masked to reduce on-site paint removal saving time and money. Hubbell Wire Basket Tray Systems are available in overhead and raised floor designs. Complete shipments, job site location palletization and markings, and product customization make Hubbell the choice for every wire basket tray installation.

Customer Support and Technical Assistance

Hubbell's knowledgeable sales team is just a call away for assistance in selecting the proper type basket tray for any application or providing design assistance including developing a bill of material.

Pre-Galvanized Finish is Environmentally Friendly

The standard finish for Hubbell Basket Tray is pre-galvanized which is a significantly more environmentally friendly manufacturing process as compared to galvanizing dip. Pre-galvanizing applies a zinc galvanization to the wire PRIOR to fabrication. The galvanized wire(s) then welded and formed into the appropriate basket tray size. Hubbell's pre-galvanized finish performs the same as post-zinc plated production finish while avoiding secondary chemical processing.

Sustainable Approach

Hubbell utilizes a sustainable approach to assist in maintaining the environment. Our wire basket tray systems utilize 100% recycled steel content in the manufacturing of our tray, and are packaged in kraft unbleached packaging. Packaging and strapping materials are recyclable. MillCerts are available upon request to assist in documenting recycled content for possible LEED credits.



Pre-Galvanized

- Wire is galvanized prior to fabrication
- Applications
 - Commercial
 - Controlled Interiors
- Specification, ASTM A641

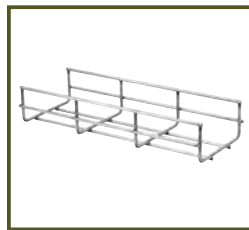

Stainless Steel ♦

- Type 304L and 316S
- Applications
 - Industrial
 - Marine
 - Food Processing
 - Outdoor
- Specification, ASTM A580



Painted Finishes

- Powder coat; Black is available as standard, other colors available as special order
- Applications
 - Data Center
 - Controlled Interiors
- Specification, N/A



Electroplated Zinc ♦

- Tray is galvanized after fabrication
- Applications
 - Commercial
 - Controlled Interiors
- Specification, ASTM B633

Note: ♦ Available as a special order.

Hot dip galvanized tray available as special order.



Wire Basket Tray System

Round Cross-Wire Basket Tray

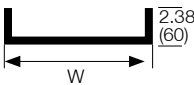

Features

- T-weld construction prevents snags
- 5mm round wire minimum
- High load rating
- Easy to cut and fabricate fittings in the field
- 100% recycled steel
- 2" x 4" mesh opening
- Use factory support hardware or fabricate supports at the job site
- Painted tray includes factory installed masking to ensure proper grounding at splices; no need to remove paint during installation

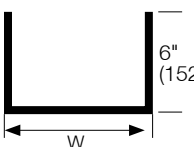
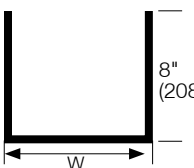
10 Feet per Length 118.3" (3m) 10 pc. min. order qty. 2" Deep Tray	Tray Width	Load (Lb/ft)	Tray Weight per Length (Lb)	Splice Quantity*		Finish	
				90° Sweep Elbow	Straight Splice	Pre-Galvanized	Black Powder Coat
	4" (102)	45	7	2	2	HBT0204	HBT0204BK
	6" (152) ●	50	9	3	4	HBT0206	HBT0206BK
	8" (203) ●	52	10.5	4	4	HBT0208	HBT0208BK
	12" (305) ●	58	12	6	4	HBT0212	HBT0212BK
	16" (406) ●	70	15	7	4	HBT0216	HBT0216BK
	18" (457) ●	70	23	9	4	HBT0218	HBT0218BK
	20" (508) ●	73	25	9	5	HBT0220	HBT0220BK
	22" (559)	73	27	12	5	HBT0222	HBT0222BK
	24" (610) ●	75	31	12	5	HBT0224	HBT0224BK
	26" (660)	73	33	13	6	HBT0226	HBT0226BK
	28" (711)	73	35	14	6	HBT0228	HBT0228BK
	30" (762)	70	38	15	6	HBT0230	HBT0230BK
32" (813)	70	39	16	6	HBT0232	HBT0232BK	
	4" (102)	49	12	2	4	HBT0404	HBT0404BK
	6" (152) ●	49	13	3	5	HBT0406	HBT0406BK
	8" (203) ●	78	15	4	6	HBT0408	HBT0408BK
	12" (305) ●	78	23	6	6	HBT0412	HBT0412BK
	16" (406) ●	108	27	7	7	HBT0416	HBT0416BK
	18" (457) ●	116	29	9	7	HBT0418	HBT0418BK
	20" (508) ●	116	31	9	7	HBT0420	HBT0420BK
	22" (559)	116	33	12	8	HBT0422	HBT0422BK
	24" (610) ●	116	35	12	8	HBT0424	HBT0424BK
	8" (203) ●	116	23	4	6	HBT0608	HBT0608BK
	12" (305) ●	123	27	6	6	HBT0612	HBT0612BK
	16" (406) ●	123	31	7	7	HBT0616	HBT0616BK
	18" (457) ●	127	33	9	7	HBT0618	HBT0618BK
	20" (508) ●	127	35	9	7	HBT0620	HBT0620BK
	22" (559) ●	127	37	12	8	HBT0622	HBT0622BK
	24" (610) ●	150	39	12	8	HBT0624	HBT0624BK
	8" (203) ●	116	27	4	8	HBT0808	HBT0808BK
	12" (305) ●	116	31	6	8	HBT0812	HBT0812BK
	16" (406) ●	116	35	7	9	HBT0816	HBT0816BK
	18" (457) ●	116	37	9	9	HBT0818	HBT0818BK
	20" (508) ●	116	39	9	9	HBT0820	HBT0820BK

Field Configurable Fittings



90° Sweep Elbow
Use appropriate quantity of splice kits



Tee Fitting
Use one HBTCS corner splice per each

Supports and Hardware

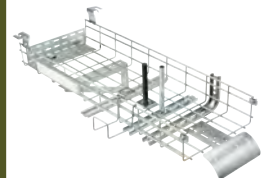

Ordering Information
See page U-12

Wire Diameter

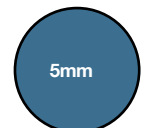

.1969" Dia.
"Round" Wire Design

Note: ●UL Classified as equipment ground conductor (painted tray cUL Classified only).
All dimensions are +/- 0.25". Custom paint colors available in addition to Black Powder Coat (Contact Hubbell).
*See page U-13 for details and page U-14 for wire fill and maximum load chart.
HBT0202 (2x2 tray) available as special order. MOQ 40 pcs. Top wire utilizes side weld.

Dimensions in Inches (mm)

Wire Basket Tray System

Electroplated Zinc Round Cross-Wire Basket Tray



Features

- T-weld construction prevents snags
- 5mm round wire minimum
- High load rating
- Easy to cut and fabricate fittings in the field
- 2" x 4" mesh opening
- Use factory support hardware or fabricate supports at the job site
- Electroplated zinc galvanized (post plated) made from carbon steel and plated to ASTM B 633, Type III, SC-1

Field Configurable Fittings



90° Sweep Elbow
Use appropriate quantity of splice kits



Tee Fitting
Use one HBTCS corner splice per each

Supports and Hardware

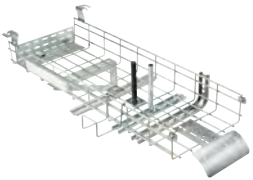

Ordering Information
See page U-12

Wire Diameter

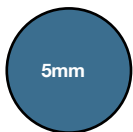

.1969" Dia.
"Round" Wire Design

10 Feet per Length 118.3" (3m) 10 pc. min. order qty. 2" Deep Tray	Tray Width	Load (Lb/ft)	Tray Weight per Length (Lb)	Splice Quantity*		Finish
				90° Sweep Elbow	Straight Splice	
	4" (102)	45	7	2	2	HBT0204ZP
	6" (152) ●	50	9	3	4	HBT0206ZP
	8" (203) ●	52	10.5	4	4	HBT0208ZP
	12" (305) ●	58	12	6	4	HBT0212ZP
	16" (406) ●	70	15	7	4	HBT0216ZP
	18" (457) ●	70	23	9	4	HBT0218ZP
	20" (508) ●	73	25	9	5	HBT0220ZP
	22" (559)	73	27	12	5	HBT0222ZP
	24" (610) ●	75	31	12	5	HBT0224ZP
	26" (660)	73	33	13	6	HBT0226ZP
	28" (711)	73	35	14	6	HBT0228ZP
	30" (762)	70	38	15	6	HBT0230ZP
	32" (813)	70	39	16	6	HBT0232ZP
4" Deep Tray	4" (102)	49	12	2	4	HBT0404ZP
	6" (152) ●	49	13	3	5	HBT0406ZP
	8" (203) ●	78	15	4	6	HBT0408ZP
	12" (305) ●	78	23	6	6	HBT0412ZP
	16" (406) ●	108	27	7	7	HBT0416ZP
	18" (457) ●	116	29	9	7	HBT0418ZP
	20" (508) ●	116	31	9	7	HBT0420ZP
	22" (559)	116	33	12	8	HBT0422ZP
	24" (610) ●	116	35	12	8	HBT0424ZP
	28" (711)	108	39	14	9	HBT0428ZP
6" Deep Tray	8" (203) ●	116	23	4	6	HBT0608ZP
	12" (305) ●	123	27	6	6	HBT0612ZP
	16" (406) ●	123	31	7	7	HBT0616ZP
	18" (457) ●	127	33	9	7	HBT0618ZP
	20" (508) ●	127	35	9	7	HBT0620ZP
	22" (559) ●	127	37	12	8	HBT0622ZP
	24" (610) ●	150	39	12	8	HBT0624ZP
8" Deep Tray	8" (203) ●	116	27	4	8	HBT0808ZP
	12" (305) ●	116	31	6	8	HBT0812ZP
	16" (406) ●	116	35	7	9	HBT0816ZP
	18" (457) ●	116	37	9	9	HBT0818ZP
	20" (508) ●	116	39	9	9	HBT0820ZP

Note: ●UL Classified/cUL Classified as equipment ground conductor.

All dimensions are +/- 0.25".

*See page U-13 for details and page U-14 for wire fill and maximum load chart.

Dimensions in Inches (mm)

Wire Basket Tray System

Flat Style Cross-Wire Basket Tray



Features

- Flat shaped cross-wires provide significantly more surface area to support weight of cables - Ideal for Cat 6 and 6A applications
- Flat ribs provide 400% more surface area and reduce stress on cables by 60%
- 100% recycled steel
- 2" x 4" mesh opening
- Reduction in stress helps maintain Cat 6 and Cat 6A performance
- Cuts and configures the same as round wire tray
- Uses the same splicing and mounting hardware as round wire tray

10 Feet per Length 118.3" (3m) 10 pc. min. order qty. 2" Deep Tray	Tray Width	Load (Lb/ft)	Tray Weight per Length (Lb)	Splice Quantity*		Finish	
				90° Sweep Elbow	Straight Splice	Pre-Galvanized	Black Powder Coat
	4" (102)	45	7	2	2	HBT0204S	HBT0204SBK
	6" (152) ●	50	9	3	4	HBT0206S	HBT0206SBK
	8" (203) ●	52	10.5	4	4	HBT0208S	HBT0208SBK
	12" (305) ●	58	12	6	4	HBT0212S	HBT0212SBK
	16" (406) ●	70	15	7	4	HBT0216S	HBT0216SBK
	18" (457) ●	70	23	9	4	HBT0218S	HBT0218SBK
	20" (508) ●	73	25	9	5	HBT0220S	HBT0220SBK
	22" (559)	73	27	12	5	HBT0222S	HBT0222SBK
	24" (610) ●	75	31	12	5	HBT0224S	HBT0224SBK
	26" (660)	73	33	13	6	HBT0226S	HBT0226SBK
	28" (711)	73	35	14	6	HBT0228S	HBT0228SBK
	30" (762)	70	38	15	6	HBT0230S	HBT0230SBK
	32" (813)	70	39	16	6	HBT0232S	HBT0232SBK
4" Deep Tray	4" (102)	49	12	2	4	HBT0404S	HBT0404SBK
	6" (152) ●	49	13	3	5	HBT0406S	HBT0406SBK
	8" (203) ●	78	15	4	6	HBT0408S	HBT0408SBK
	12" (305) ●	78	23	6	6	HBT0412S	HBT0412SBK
	16" (406) ●	108	27	7	7	HBT0416S	HBT0416SBK
	18" (457) ●	116	29	9	7	HBT0418S	HBT0418SBK
	20" (508) ●	116	31	9	7	HBT0420S	HBT0420SBK
	22" (559)	116	33	12	8	HBT0422S	HBT0422SBK
	24" (610) ●	116	35	12	8	HBT0424S	HBT0424SBK
	28" (711)	108	39	14	9	HBT0428S	HBT0428SBK
6" Deep Tray	8" (203) ●	116	23	4	6	HBT0608S	HBT0608SBK
	12" (305) ●	123	27	6	6	HBT0612S	HBT0612SBK
	16" (406) ●	123	31	7	7	HBT0616S	HBT0616SBK
	18" (457) ●	127	33	9	7	HBT0618S	HBT0618SBK
	20" (508) ●	127	35	9	7	HBT0620S	HBT0620SBK
	22" (559) ●	127	37	12	8	HBT0622S	HBT0622SBK
	24" (610) ●	150	39	12	8	HBT0624S	HBT0624SBK
8" Deep Tray	8" (203) ●	116	27	4	8	HBT0808S	HBT0808SBK
	12" (305) ●	116	31	6	8	HBT0812S	HBT0812SBK
	16" (406) ●	116	35	7	9	HBT0816S	HBT0816SBK
	18" (457) ●	116	37	9	9	HBT0818S	HBT0818SBK
	20" (508) ●	116	39	9	9	HBT0820S	HBT0820SBK

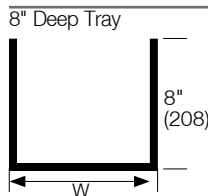
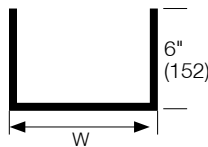
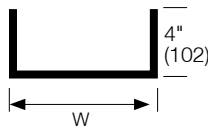
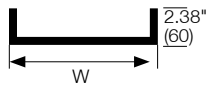

Note: ●UL Classified as equipment ground conductor (painted tray cUL Classified only).
All dimensions are +/- 0.25". Custom paint colors available in addition to Black Powder Coat (Contact Hubbell).
*See page U-13 for details and page U-14 for wire fill and maximum load chart.

Field Configurable Fittings



90° Sweep Elbow
Use appropriate quantity of splice kits



Tee Fitting
Use one HBTCS corner splice per each

Supports and Hardware

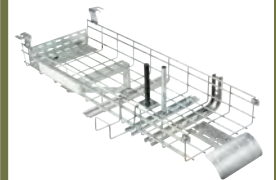

Ordering Information
See page U-12

Cable Support Area

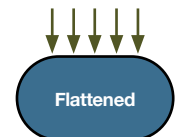

.03125 sq. inch
"Flat" Wire Design
(based on .125" dia. cable)

Dimensions in Inches (mm)

Wire Basket Tray System

Stainless Steel Round Cross-Wire Basket Tray



Features

- Type 304L and 316S stainless steel
- Meets ASTM A580 specifications
- 4.5mm round wire minimum
- Stainless splice kits and ceiling supports are available

Applications

- Food processing
- Wash down areas
- Corrosive environments
- Outdoor installations
- Marine

Stainless Steel Accessories Available



HBTSKSS
Splice Kits

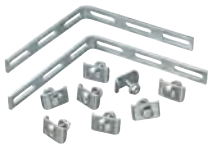

HBTCSSS
Corner Splice

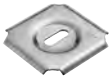

HBTWSSS
Washer Support



HBTNBSS
1/4" x 20 Nuts and Bolts

Ordering Information

See page U-12

Wire Diameter



.1772" Dia.
"Round" Wire Design

10 Feet per Length 118.3" (3m) 10 pc. min. order qty. 2" Deep Tray	Tray Width	Load (Lb/ft)	Tray Weight per Length (Lb)	Splice Quantity*		Round	
				90° Sweep Elbow	Straight Splice	Type 304L	Type 316S
	4" (102)	45	7	2	2	HBT0204S04	HBT0204S16
	6" (152)	50	9	3	4	HBT0206S04	HBT0206S16
	8" (203)	52	10.5	4	4	HBT0208S04	HBT0208S16
	12" (305)	58	12	6	4	HBT0212S04	HBT0212S16
	16" (406)	70	15	7	4	HBT0216S04	HBT0216S16
	18" (457)	70	23	9	4	HBT0218S04	HBT0218S16
	20" (508)	73	25	9	5	HBT0220S04	HBT0220S16
	22" (559)	73	27	12	5	HBT0222S04	HBT0222S16
	24" (610)	75	31	12	5	HBT0224S04	HBT0224S16
	26" (660)	73	33	13	6	HBT0226S04	HBT0226S16
	28" (711)	73	35	14	6	HBT0228S04	HBT0228S16
	30" (762)	70	38	15	6	HBT0230S04	HBT0230S16
	32" (813)	70	39	16	6	HBT0232S04	HBT0232S16
	4" (102)	49	12	2	4	HBT0404S04	HBT0404S16
	6" (152)	49	13	3	5	HBT0406S04	HBT0406S16
	8" (203)	78	15	4	6	HBT0408S04	HBT0408S16
	12" (305)	78	23	6	6	HBT0412S04	HBT0412S16
	16" (406)	108	27	7	7	HBT0416S04	HBT0416S16
	18" (457)	116	29	9	7	HBT0418S04	HBT0418S16
	20" (508)	116	31	9	7	HBT0420S04	HBT0420S16
	22" (559)	116	33	12	8	HBT0422S04	HBT0422S16
	24" (610)	116	35	12	8	HBT0424S04	HBT0424S16
	28" (711)	108	39	14	9	HBT0428S04	HBT0428S16
	8" (203)	116	23	4	6	HBT0608S04	HBT0608S16
	12" (305)	123	27	6	6	HBT0612S04	HBT0612S16
	16" (406)	123	31	7	7	HBT0616S04	HBT0616S16
	18" (457)	127	33	9	7	HBT0618S04	HBT0618S16
	20" (508)	127	35	9	7	HBT0620S04	HBT0620S16
	22" (559)	127	37	12	8	HBT0622S04	HBT0622S16
	24" (610)	150	39	12	8	HBT0624S04	HBT0624S16
	8" (203)	116	27	4	8	HBT0808S04	HBT0808S16
	12" (305)	116	31	6	8	HBT0812S04	HBT0812S16
	16" (406)	116	35	7	9	HBT0816S04	HBT0816S16
	18" (457)	116	37	9	9	HBT0818S04	HBT0818S16
	20" (508)	116	39	9	9	HBT0820S04	HBT0820S16

Note: All dimensions are +/- 0.25".

*See page U-13 for details and page U-14 for wire fill and maximum load chart.

Dimensions in Inches (mm)

Wire Basket Tray System

Accessories for Under Floor Wire Basket Tray



Splice Hardware

Description	Finish	Catalog Number	
Kit, Pedestal (2) HBTUPC and (1) Cross bar	Pre-Galvanized	HBTUPK	
C-Bracket 6" Tier 12" Tier	Pre-Galvanized Pre-Galvanized	HBTUCB6 HBTUCB12	
U-Clamp, Pedestal (1) Clamp	Pre-Galvanized	HBTUPC	
Tray Grounding Fasteners Washer supports HBTWS and 1/4" - 20 self threading screws; 50 per box. Required when installing under floor wire basket tray.	Zinc Plated	HBTUGS	
Intersection Supports For use with HBTUSUPP series support	Pre-Galvanized	HBTUFIT	
Vertical Up	Pre-Galvanized	HBTUVU	

Note: See page 10 for L-brackets and C-brackets.
See page 14 for wire fill and maximum load chart.

Saw Horse Supports

Support Height	Support Width	Finish	Catalog Number
4" (102)	22" (559)	Pre-Galvanized	HBTUSUPP4
6" (152)	22" (559)	Pre-Galvanized	HBTUSUPP6
8" (203)	22" (559)	Pre-Galvanized	HBTUSUPP8
10" (254)	22" (559)	Pre-Galvanized	HBTUSUPP10
12" (305)	22" (559)	Pre-Galvanized	HBTUSUPP12
14" (356)	22" (559)	Pre-Galvanized	HBTUSUPP14
16" (406)	22" (559)	Pre-Galvanized	HBTUSUPP16
18" (457)	22" (559)	Pre-Galvanized	HBTUSUPP18
20" (508)	22" (559)	Pre-Galvanized	HBTUSUPP20
22" (559)	22" (559)	Pre-Galvanized	HBTUSUPP22
24" (610)	22" (559)	Pre-Galvanized	HBTUSUPP24
26" (660)	22" (559)	Pre-Galvanized	HBTUSUPP26
28" (711)	22" (559)	Pre-Galvanized	HBTUSUPP28
30" (762)	22" (559)	Pre-Galvanized	HBTUSUPP30

Dimensions in Inches (mm)

Wire Basket Tray System

Accessories for Wire Basket Tray, Preformed Fittings

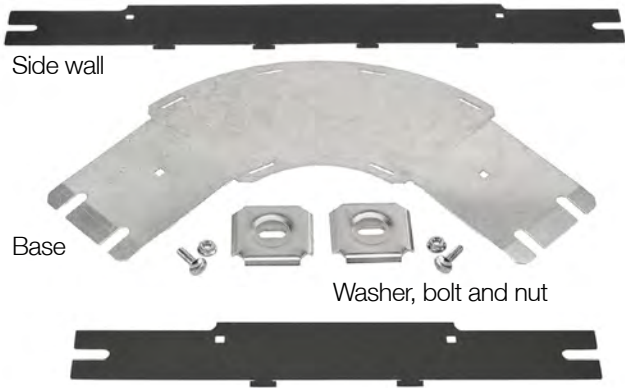

1. Splicing hardware included



2. Attach first tray with washer support and 1/4"-20 nut and bolt



4. Attach second tray



3. Washer support secured to tray



5. Install side walls

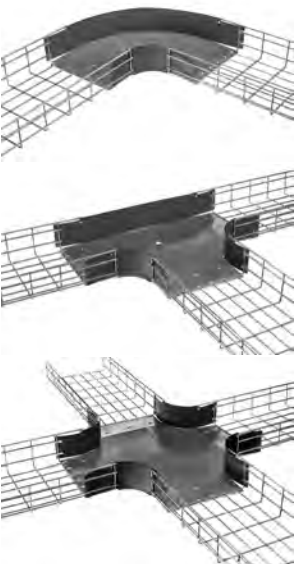

Installation Efficiency

Hubbell preformed fittings are time and cost effective solutions to installing 90 Degree Radius, Tees and Intersections, no cutting and no configuring. Hubbell offers Pre-galvanized or Black powder painted finishes. The fittings simply attach at the Intersections Tees or junctions when you want a radius bend. The fittings are manufactured precisely to the basket tray being utilized providing a clean engineered solution.

Installation of Hubbell preformed fittings can reduce installation configurations from hours to a few minutes. Labor and time savings can exceed 90% versus traditional cutting and splicing. Preformed fittings ensure a consistent installation every time and also avoids the sharp wire edges caused during the cutting process. Standard Hubbell preformed fittings consist of a pregalvanized base with black polymer sides* and splicing hardware.

*Steel wall preform fittings are available.

90 Degree Radius

Tray Width	Traditional Configuration	Hubbell Preformed Fittings	Time Savings
2 x 8	7 Minutes	1 Minute	85%
4 x 12	20 Minutes	2 Minutes	90%

Tee

Tray Width	Traditional Configuration	Hubbell Preformed Fittings	Time Savings
4 x 12	8 Minutes, 45 seconds	2 Minutes, 30 seconds	70%
4 x 18	10 Minutes	2 Minutes, 30 seconds	74%

Intersection

Tray Width	Traditional Configuration	Hubbell Preformed Fittings	Time Savings
6 x 24	29 Minutes	4 Minutes, 45 seconds	83%

Wire Basket Tray System

Accessories for Wire Basket Tray, Preformed Fittings



Features

- Labor and time savings
- Consistent installations
- For round and flat tray
- Steel pre-galvanized bases
- Interlocking polymer side walls
- Splicing hardware included
- Available with steel side walls

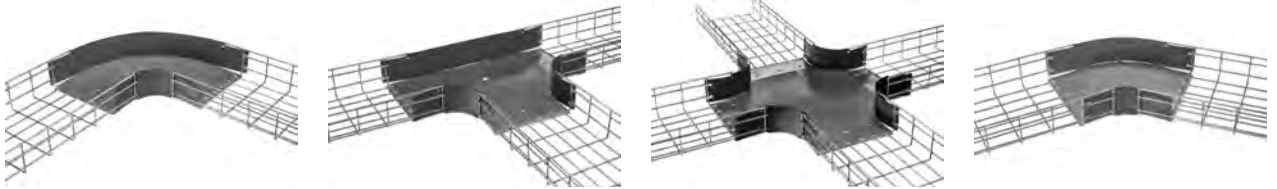

Tray Size	Tray Width	90 Degree	Tee	Intersection	45 Degree	30 Degree
2" (51) Deep	4"(102)	HBTR0204	HBTT0204	HBTI0204	HBT450204	HBT300204
	6"(152)	HBTR0206	HBTT0206	HBTI0206	HBT450206	HBT300206
	8"(203)	HBTR0208	HBTT0208	HBTI0208	HBT450208	HBT300208
	12"(305)	HBTR0212	HBTT0212	HBTI0212	HBT450212	HBT300212
	16"(406)	HBTR0216	HBTT0216	HBTI0216	HBT450216	HBT300216
	18"(457)	HBTR0218	HBTT0218	HBTI0218	HBT450218	HBT300218
	20"(508)	HBTR0220	HBTT0220	HBTI0220	HBT450220	HBT300220
	24"(610)	HBTR0224	HBTT0224	HBTI0224	HBT450224	HBT300224
4" (102) Deep	4"(102)	HBTR0404	HBTT0404	HBTI0404	HBT450404	HBT300404
	6"(152)	HBTR0406	HBTT0406	HBTI0406	HBT450406	HBT300406
	8"(203)	HBTR0408	HBTT0408	HBTI0408	HBT450408	HBT300408
	12"(305)	HBTR0412	HBTT0412	HBTI0412	HBT450412	HBT300412
	16"(406)	HBTR0416	HBTT0416	HBTI0416	HBT450416	HBT300416
	18"(457)	HBTR0418	HBTT0418	HBTI0418	HBT450418	HBT300418
	20"(508)	HBTR0420	HBTT0420	HBTI0420	HBT450420	HBT300420
	24"(610)	HBTR0424	HBTT0424	HBTI0424	HBT450424	HBT300424
6" (152) Deep	8"(203)	HBTR0608	HBTT0608	HBTI0608	HBT450608	HBT300608
	12"(305)	HBTR0612	HBTT0612	HBTI0612	HBT450612	HBT300612
	16"(406)	HBTR0616	HBTT0616	HBTI0616	HBT450616	HBT300616
	18"(457)	HBTR0618	HBTT0618	HBTI0618	HBT450618	HBT300618
	20"(508)	HBTR0620	HBTT0620	HBTI0620	HBT450620	HBT300620
	24"(610)	HBTR0624	HBTT0624	HBTI0624	HBT450624	HBT300624

Note: Add **BK** suffix for black base.
Add **SW** suffix for steel side walls.

Dimensions in Inches (mm)

Wire Basket Tray System

Accessories for Wire Basket Tray - Supports and Brackets



Supports**

Tray Width	Qty. per Box	Center Support		Ceiling Support		Qty. per Box	Trapeze Support	
		Pre-Galvanized	Black Powder Coat	Pre-Galvanized	Black Powder Coat		Zinc Plated	Black Powder Coat
4" (102)	1	HBCTRS4	HBCTRS4BK	–	–	50	HBTTSS	HBTTSSBK
6" (152)	1	HBCTRS6	HBCTRS6BK	–	–		Attaches to the side of the tray; for tray sizes 16" wide and smaller; use in pairs every 6 feet for 4" and 6" trays; can be staggered every 5 feet.	
8" (203)	1	HBCTRS8	HBCTRS8BK	–	–			
12" (305)	1	HBCTRS12	HBCTRS12BK	HBCLGS12	HBCLGS12BK			
16" (406)	1	HBCTRS16	HBCTRS16BK	HBCLGS16	HBCLGS16BK			
18" (457)	1	HBCTRS18	HBCTRS18BK	HBCLGS18	HBCLGS18BK			
20" (508)	1	HBCTRS20	HBCTRS20BK	HBCLGS20	HBCLGS20BK			
24" (610)	1	HBCTRS24	HBCTRS24BK	HBCLGS24	HBCLGS24BK			



Brackets**

Tray Width	Qty. per Box	L-Bracket		C-Bracket		Shelf Support	
		Pre-Galvanized	Black Powder Coat	Pre-Galvanized	Black Powder Coat	Pre-Galvanized	Black Powder Coat
4" (102)	1	HBTLB4	HBTLB4BK	HBTCB4	HBTCB4BK	HBTSS4	HBTSS4BK
6" (152)	1	HBTLB6	HBTLB6BK	–	–	HBTSS6	HBTSS6BK
8" (203)	1	HBTLB8	HBTLB8BK	HBTCB8	HBTCB8BK	HBTSS8	HBTSS8BK
12" (305)	1	HBTLB12	HBTLB12BK	HBTCB12	HBTCB12BK	HBTSS12	HBTSS12BK
16" (406)	1	HBTLB16	HBTLB16BK	–	–	HBTSS16	HBTSS16BK
18" (457)	1	HBTLB18	HBTLB18BK	HBTCB18	HBTCB18BK	HBTSS18	HBTSS18BK
20" (508)	1	HBTLB20	HBTLB20BK	–	–	HBTSS20	HBTSS20BK
24" (610)	1	HBTLB24	HBTLB24BK	–	–	HBTSS24	HBTSS24BK

Note: **Install every 6 feet.

Dimensions in Inches (mm)

Wire Basket Tray System

Accessories for Wire Basket Tray - Covers and Inserts

Black Polymer Inserts with Sides*

Provides a solid bottom and sides for tray - order in 10 foot increments

Tray Width	2" (51) Deep	4" (102) Deep	6" (152) Deep
4" (102)	HBTFRMIN0204BK	HBTFRMIN0404BK	—
6" (152)	HBTFRMIN0206BK	HBTFRMIN0406BK	—
8" (203)	HBTFRMIN0208BK	HBTFRMIN0408BK	HBTFRMIN0608BK
12" (305)	HBTFRMIN0212BK	HBTFRMIN0412BK	HBTFRMIN0612BK
16" (406)	HBTFRMIN0216BK	HBTFRMIN0416BK	HBTFRMIN0616BK
18" (457)	HBTFRMIN0218BK	HBTFRMIN0418BK	HBTFRMIN0618BK
20" (508)	HBTFRMIN0220BK	HBTFRMIN0420BK	HBTFRMIN0620BK
24" (610)	HBTFRMIN0224BK	HBTFRMIN0424BK	HBTFRMIN0624BK

Note: *For white insert, replace **BK** with **WHT**.



Polymer Inserts

Provides a solid bottom for tray - order in 10 foot increments

Tray Width	Length	White	Black
4" (102)	118" (3000)	HBTINSNM04WHT	HBTINSNM04
6" (152)	118" (3000)	HBTINSNM06WHT	HBTINSNM06
8" (203)	118" (3000)	HBTINSNM08WHT	HBTINSNM08
12" (305)	118" (3000)	HBTINSNM12WHT	HBTINSNM12
16" (406)	118" (3000)	HBTINSNM16WHT	HBTINSNM16
18" (457)	118" (3000)	HBTINSNM18WHT	HBTINSNM18
20" (508)	118" (3000)	HBTINSNM20WHT	HBTINSNM20
24" (610)	118" (3000)	HBTINSNM24WHT	HBTINSNM24

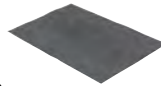

Galvanized Steel Inserts

Provides a solid bottom for tray - 5 feet length per piece; 1 piece per box

Tray Width	Length	Pre-Galvanized	Black Powder Coat
4" (102)	59" (1500)	HBTINSM04	HBTINSM04BK
6" (152)	59" (1500)	HBTINSM06	HBTINSM06BK
8" (203)	59" (1500)	HBTINSM08	HBTINSM08BK
12" (305)	59" (1500)	HBTINSM12	HBTINSM12BK
16" (406)	59" (1500)	HBTINSM16	HBTINSM16BK
18" (457)	59" (1500)	HBTINSM18	HBTINSM18BK
20" (508)	59" (1500)	HBTINSM20	HBTINSM20BK
24" (610)	59" (1500)	HBTINSM24	HBTINSM24BK

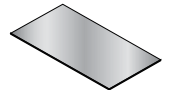

Galvanized Steel Covers

Top cable and wire protector - 5 feet length per piece; 1 piece per box

Tray Width	Length	Pre-Galvanized	Black Powder Coat
4" (102)	59" (1500)	HBTCVR4	HBTCVR4BK
6" (152)	59" (1500)	HBTCVR6	HBTCVR6BK
8" (203)	59" (1500)	HBTCVR8	HBTCVR8BK
12" (305)	59" (1500)	HBTCVR12	HBTCVR12BK
16" (406)	59" (1500)	HBTCVR16	HBTCVR16BK
18" (457)	59" (1500)	HBTCVR18	HBTCVR18BK
20" (508)	59" (1500)	HBTCVR20	HBTCVR20BK
24" (610)	59" (1500)	HBTCVR24	HBTCVR24BK



Galvanized Termination Support

Secures end of tray to wall and can serve as blank end fitting; 1 piece per box

Tray Width	Length	Pre-Galvanized	Black Powder Coat
6" (152)	6.4" (163)	HBTT6	HBTT6BK
8" (203)	8" (203)	HBTT8	HBTT8BK
12" (305)	11.2" (284)	HBTT12	HBTT12BK
16" (406)	16" (406)	HBTT16	HBTT16BK
18" (457)	17.6" (447)	HBTT18	HBTT18BK
20" (508)	19.2" (488)	HBTT20	HBTT20BK
24" (610)	24" (610)	HBTT24	HBTT24BK



Galvanized Steel Dividers

Mounting hardware to secure to tray (not included); 2 mounting holes per piece; 5 feet length per piece; 1 piece per box

For use with Tray	Length	Pre-Galvanized	Black Powder Coat
2" (51) Deep	60" (1524)	HBTDIV2	HBTDIV2BK
4" (102) Deep	60" (1524)	HBTDIV4	HBTDIV4BK
6" (152) Deep	60" (1524)	HBTDIV6	HBTDIV6BK
8" (203) Deep	60" (1524)	HBTDIV8*	HBTDIV8BK*

Note: *Minimum order quantity = 40 pieces.



Dimensions in Inches (mm)

Wire Basket Tray System

Accessories for Wire Basket Tray, Supports and Fittings

Description	Tray Width	Finish	Catalog Number
Radius Down Increases cable protection and cable bend control; 1 per box	4" (102) 6" (152) 12" (305)	Black Black Black	HBTRD4BK HBTRD6BK HBTRD12BK
Exit Radius Down* Top tray attachment, increases cable protection and cable bend control; 1 per box	4X4 Minimum Tray Size	Black	HBTEXTRDBK
Vertical Down Protects cables when dropping from the end or side of tray; 1 per box	7/4" (102)	Zinc Plated Black	HBTVD HBTVDBK
Label Clip Attachment for all sizes of tray; 1 per box		White	HBTLCL
Cable Guide* Maintains cable bend radius and acts as a divider for straight sections and fittings; 1 per box		Black	HBTCG
Electrical Box Bracket Attaches electrical box to side of tray; 1 per box		Pre-Galvanized Black	HBTEB HBTEBBL
Sidecar Attaches to outside of tray, provides additional cable support, 2" deep; 1 per box		Pre-Galvanized Black	HBTSC HBTSCBK
Splice Kit 3 piece staked bolt/washer and nut combination; splices straight sections and field formed fittings; 50 pieces per box		Zinc Plated Black Stainless Steel	HBTSK HBTSKKBK HBTSKSS
Bar Splice Slotted bar 11 ⁵ / ₁₆ " long; Splices straight sections and fittings; bend to form tray reducers; adds rigidity to tray splices; 50 pieces per box		Zinc Plated Black Stainless Steel	HBTBS HBTBSBK HBTBSSS
Corner Splice (2) 90° splice bars and (8) sets of the splice kit		Zinc Plated Black Stainless Steel	HBTCS HBTCSBK HBTCSSS
Splice Fittings Required: Use one per each Tee Fitting; Use two per each Cross Fitting			
Washer Supports Splices straight sections and fittings and can also be used as a hold down method for tray to strut (nut and bolt provided separately); 50 pieces per box		Zinc Plated Black Stainless Steel	HBTWS HBTWSBK HBTWSSS
Self Tapping Screws with Supports 1/4" - 20 self tapping screw and HBTWS; 50 pieces per box		Zinc Plated	HBTUGS

Note: *Mounting hardware included.

Description	Finish	Catalog Number
Fitting Attachment Fills the gap in tray when creating fittings in 2" tray or 4"/6" tray	Pre-Galvanized Black	HBTF2 HBTF2BK
	Pre-Galvanized Black	HBTF46 HBTF46BK
Rack Attachment Attaches tray directly to the top of a standard rack	Zinc Plated Black	HBTRA HBTRABK
Conduit Attachment Connects conduit to tray (3/4", 1" and 1 1/4" conduit)	Pre-Galvanized Black	HBTC3 HBTC3BK
Nut and Bolt Sets 1/4" - 20 nut and bolt sets; 50 pieces per box	Zinc Plated Stainless Steel	HBTNB HBTNBSS
Cable Drop Outs Black polymer inserts; Installed into the bottom of the basket tray to reduce pinch points and maintain a radius bend on the exiting cables	Black	HBTCDBK
Large Cable Drop Outs Black polymer inserts; Installed into the bottom of the basket tray to reduce pinch points and maintain a radius bend on the exiting cables (tray requires cutting to install)	Black	HBTC4X4BK
Strut Clips Used to hold down basket tray when used with any standard industry strut supports; 50 pieces per box	Pre-Galvanized	HBTSTRUTCLIP
		<ul style="list-style-type: none"> • 12" trays or smaller use 2 clips per strut support • 16" - 18" trays use 3 clips per strut support • Larger trays add one clip per strut support for every 6" of tray width
Grounding Split Bolts These are sold in packs of 10. Bolts are used for supplemental grounding. One bolt is installed per section of basket tray. The installer must supply #6 AWG grounding wire	Copper Alloy	HBTSPLITBOLTPK10



Dimensions in Inches (mm)

Wire Basket Tray System

Technical Support - Cutting and Forming Fittings

Cutting Wire Basket Tray

- Always make field cuts with the side action angle cutting tool.
- Cuts can be made on any finish, width or depth basket tray.
- Cut as many segments required for sweep elbows (see Splice Quantity column on product pages).
- Remove any sharp edges to eliminate possible damage to cables.

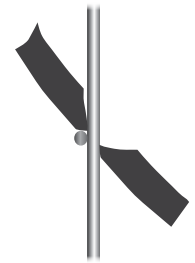

(Side action cutter)

Cutting Tool

Description	Weight (Lb/each)	Qty. per Box	Catalog Number
Manual offset angled cutting tool, 24" leveraged handle	6.0	1	HBTCUTTOOL



How to Form a 90 Degree Flat Sweep Elbow

- Determine which wires must be cut for the type of fitting or redirection required. This will usually be the side and bottom wires of every other mesh section.
- Turn the tray over and cut the bottom wires.
- Cut the top side wire.
- Cut the remaining side wires.
- This creates open gaps in the side wall and bottom of the tray.
- Bend the tray to form the desired elbow radius curve by closing the gaps.
- Install splice kits and hardware where the wedge-shaped sections come together.
- Splice kits provide the mechanical connection as well as electrical grounding continuity.

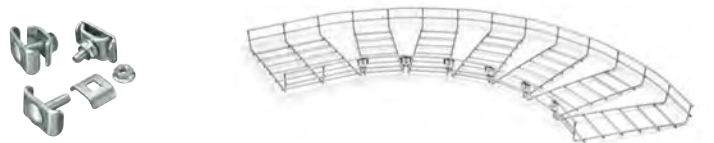

HBTSK Splice Kit
See page U-12 for ordering information.

How to Form a Tee Fitting

- Determine the location of the horizontal "tee" fitting along the length of basket tray.
- Cut the side wires from the tray which shall be the horizontal tray section, to the same width as the perpendicular tray section.
- Do not cut the bottom wires.
- Align the perpendicular tray to the opening in the side of the horizontal tray.
- Position one angle bracket from the **HBTC**S corner splice kit on each side of the opening.
- Secure the angle brackets to the horizontal and perpendicular tray sections with splice kits (nut, bolt and washer) provided in the **HBTC**S corner splice kit.
- Support the tee fitting on all three sides of the "tee" using appropriate support method.

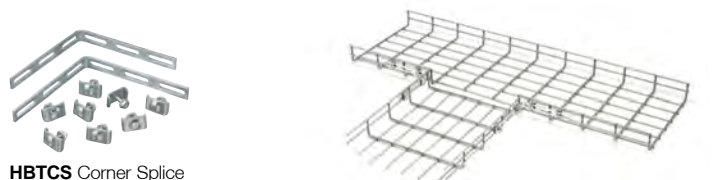
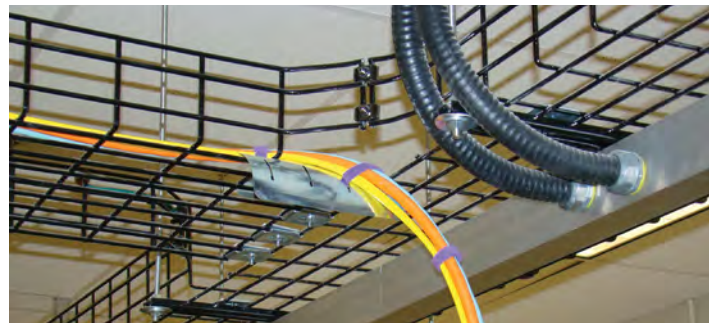

HBTCS Corner Splice
See page U-12 for ordering information.

Wire Basket Tray System

Wire Fill and Maximum Load Chart

Depth	Width	Area	Cat 5e (0.18" dia.) 50% Wire Fill	Cat 6 (0.23" dia.) 50% Wire Fill	Cat 6a (0.30" dia.) 50% Wire Fill	Max. Load (Lb/ft) (Supported at 6ft spacing)
2	4	8	157	96	57	45
2	6	12	236	144	85	50
2	8	16	315	193	113	52
2	12	24	472	289	170	58
2	16	32	629	385	226	70
2	18	36	708	433	255	70
2	20	40	786	482	283	73
2	22	44	865	530	311	73
2	24	48	944	578	340	75
2	26	52	1022	626	368	73
2	28	56	1101	674	396	73
2	30	60	1180	722	425	70
2	32	64	1258	771	453	70
<hr/>						
4	4	16	315	193	113	49
4	6	24	472	289	170	49
4	8	32	629	385	226	78
4	12	48	944	578	340	78
4	16	64	1258	771	453	108
4	18	72	1415	867	510	116
4	20	80	1573	963	566	116
4	22	88	1730	1060	623	116
4	24	96	1887	1156	679	116
4	28	112	2202	1349	793	108
<hr/>						
6	8	48	944	578	340	116
6	12	72	1415	867	510	123
6	16	96	1887	1156	679	123
6	18	108	2123	1300	764	127
6	20	120	2359	1445	849	127
6	22	132	2595	1589	934	127
6	24	144	2831	1734	1019	150
<hr/>						
8	8	64	1258	771	453	116
8	12	96	1887	1156	679	116
8	16	128	2516	1541	906	116
8	18	144	2831	1734	1019	116
8	20	160	3145	1926	1132	116

Sizes UL Classified or cUL Classified as equipment ground conductor

2" Depth	4" Depth	6" Depth	8" Depth
2 x 6	4 x 6	6 x 8	8 x 8
2 x 8	4 x 8	6 x 12	8 x 12
2 x 12	4 x 12	6 x 16	8 x 16
2 x 16	4 x 16	6 x 18	8 x 20
2 x 18	4 x 18	6 x 20	
2 x 20	4 x 20	6 x 22	
2 x 24	4 x 24	6 x 24	

Note: Applicable to pre-galvanized and powder coat painted when spliced as recommended.
Other non-UL sizes require external grounding conductor.
Stainless steel is not UL listed.

Instructions to Achieve Ground

- Use Hubbell splice kits (**HBTSK**) to achieve proper grounding at all splices, joints and fittings.
- Grounding lugs and external ground wire are not required when **HBTSK** splice kits are utilized with steel tray. (Stainless steel tray requires external grounding conductor.)

Wire Basket Tray System

Technical Specifications

2.01 ACCEPTABLE MANUFACTURES

1. Manufacturer: Subject to compliance with these specifications wire basket tray systems to be installed shall be Hubbell "HBT" series.

2.02 WIRE TRAY SECTIONS AND COMPONENTS

1. Provide wire basket of types and sizes indicated with all required splicing and mounting hardware. Construct units with T-weld edges and smooth surfaces in compliance with applicable standards and with the following additional construction features.
 - A. All straight section longitudinal wires shall be constructed with a continuous top wire safety edge. Safety edge must be T-welded on all tray sizes.
 - B. Wire basket cross-wire to be constructed with either flat shaped wire design or with round wire design as directed by engineer.
 - Flat shaped cross wire design shall provide additional surface area for cable weight support and to avoid pressure points and strain on cables.
 - Round shaped cross wire design may be used in general purpose applications where cable weight and strain are not concerns.
2. Materials and Finishes: Material and finish specifications for Carbon Steel Wire and Pre-Galvanized steel wire are as follows:
 - A. Pre-galvanized Zinc: Straight section shall be made from pre-galvanized steel meeting the minimum mechanical properties of ASTM A 641. Material must be cleaned after fabrication to remove any soot, manufacturing residue/oils or metallic particles.
 - B. Powder Coat: Straight sections shall be powder coated black with an average paint thickness of 1.2mils (30microns) to 3.0mils (75microns). Hubbell powder coat product is masked at splice points to allow conductive ground design; no field paint removal is required.
 - C. Stainless Steel: Straight sections and accessories shall be made from AISI Type 304L, 316L Stainless Steel (meeting the minimum mechanical properties of ASTM A 580).
 - D. Electro-Plated Zinc Galvanized (Post Plated) Made from Carbon Steel and plated to ASTM B 633, Type III, SC-1.
 - E. Hot Dip Galvanized: Plain steel (ASTM AS10) dip after fabricated and formed. ASTM A123.
3. Wire basket shall be made of high strength steel wires and formed into a standard 2-inch by 4-inch wire mesh pattern with intersecting wires welded together. All mesh sections must have at least one bottom longitudinal wire along entire length of straight section.
4. Wire basket sizes shall conform to the following nominal criteria:
 - A. Straight sections shall be furnished in standard 118" (3m) lengths.
 - B. Wire diameter shall be 0.195" (5mm) minimum on all mesh sections. Wire diameter shall be minimum size of 4.5mm on stainless steel.
 - C. Wire basket shall have a 2-inch usable loading depth by (4), (6), (8), (10), (12), (14), (16), (18), (20), (22), (24), (26), (28), (30), (32) inches wide.
 - D. Wire basket shall have a 4-inch usable loading depth by (4), (6), (8), (10), (12), (14), (16), (18), (20), (22), (24), (26), (28) inches wide.
 - E. Wire basket shall have a 6-inch usable loading depth by (8), (10), (12), (14), (16), (18), (20), (22), (24) inches wide.
 - F. Wire basket shall have an 8-inch usable loading depth by (8), (10), (12), (14), (16), (18), (20) inches wide.
5. All fittings shall be field formed from straight sections in accordance with manufacturer's instructions.
6. All Tray sections and splicing assemblies shall be UL/C-UL Classified as an Equipment Ground Conductor (EGC).
7. Wire mesh basket tray supports shall be ceiling trapeze type, center support, trapeze clips, or wall brackets as manufactured by Hubbell.
8. Special accessories shall be furnished as required to protect, support and install a wire basket support system.

Aluminum Ladder Tray

Hubbell Wiring Aluminum Ladder Tray system is a highly effective indoor and outdoor cable and delivery distribution management solution that stands up to the largest distance demands and the toughest environments, providing optimum protection and accessibility for infrastructure components without sagging, or the need for secondary supports.

The Aluminum Ladder Tray is a modular system – Straight sections are 12 feet long, available in 4 or 6 inch heights and widths from 6 to 36 inches—allowing easy configuration planning for the unique topologies of every installation. The Hubbell Wiring Aluminum Ladder Tray System is UL Listed and meets or exceeds NEMA standard VE1. Hubbell Wiring offers a full line of complementary supports, brackets, dividers, fittings, hardware and other accessories.



Arc-Welded Rung Construction

- Full electrical continuity
- No loosening
- Superior structural performance



Pre-Drilled Splice Plate Mounting Holes

- Reduce on-site installation time



Radius Fittings

- Available in 12-, 24- or 36-inch radius
- All Radius fittings have a 3" flat surface beyond the radius



Splice Plates

- Included with all straight sections and fittings

Aluminum Ladder Tray

Straight Sections



Features

- For use indoors, outdoors or in harsh environments
- Aluminum Alloy 6063
- NEMA Class B or C
- Splice plates and hardware included*
- 12 foot sections with 9 inch rung spacing
- Rungs are welded to stringers for strength and continuity
- Use with Class 1 Fittings

Rail Height	Width	NEMA Class	NEMA Safe Load (lb/ft)	AMP Rating	Catalog Number
4"	6"	B	81	1000	LTB406
		C	100	1000	LTC406
	9"	B	81	1000	LTB409
		C	100	1000	LTC409
	12"	B	81	1000	LTB412
		C	100	1000	LTC412
	18"	B	81	1000	LTB418
		C	100	1000	LTC418
	24"	B	81	1000	LTB424
		C	100	1000	LTC424
	30"	B	81	1000	LTB430
		C	100	1000	LTC430
	36"	B	81	1000	LTB436
		C	100	1000	LTC436
6"	6"	B	89	1200	LTB606
		C	105	1200	LTC606
	9"	B	89	1200	LTB609
		C	105	1200	LTC609
	12"	B	89	1200	LTB612
		C	105	1200	LTC612
	18"	B	89	1200	LTB618
		C	105	1200	LTC618
	24"	B	89	1200	LTB624
		C	105	1200	LTC624
	30"	B	89	1200	LTB630
		C	105	1200	LTC630
	36"	B	89	1200	LTB636
		C	105	1200	LTC636

Note: 4" Rail Height has a Load Depth of 3". 6" Rail height has a Load Depth of 5". Total Width is Width + 1.5".
*Included hardware is geomet-plated steel.

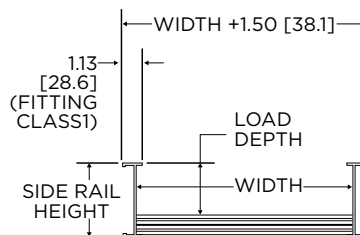

Aluminum Ladder Tray

Fittings, Horizontal Elbows

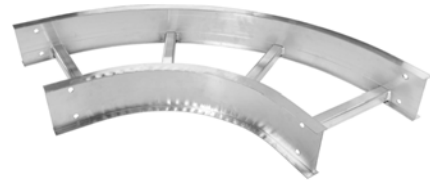

Features

- All fittings have 3" flat sections at the ends to allow space for mounting splices
- For use indoors, outdoors or in harsh environments
- Aluminum Alloy 6063
- Rungs are welded to stringers for strength and continuity
- 9" Rung spacing
- Class 1 Fitting
- Splice plates and hardware included*

Rail Height	Width	Radius	30 Degree	45 Degree	60 Degree	90 Degree	
4"	6"	12"	LFHB3040612	LFHB4540612	LFHB6040612	LFHB9040612	
		24"	LFHB3040624	LFHB4540624	LFHB6040624	LFHB9040624	
		36"	LFHB3040636	LFHB4540636	LFHB6040636	LFHB9040636	
	9"	12"	LFHB3040912	LFHB4540912	LFHB6040912	LFHB9040912	
		24"	LFHB3040924	LFHB4540924	LFHB6040924	LFHB9040924	
		36"	LFHB3040936	LFHB4540936	LFHB6040936	LFHB9040936	
	12"	12"	LFHB3041212	LFHB4541212	LFHB6041212	LFHB9041212	
		24"	LFHB3041224	LFHB4541224	LFHB6041224	LFHB9041224	
		36"	LFHB3041236	LFHB4541236	LFHB6041236	LFHB9041236	
	18"	12"	LFHB3041812	LFHB4541812	LFHB6041812	LFHB9041812	
		24"	LFHB3041824	LFHB4541824	LFHB6041824	LFHB9041824	
		36"	LFHB3041836	LFHB4541836	LFHB6041836	LFHB9041836	
	24"	12"	LFHB3042412	LFHB4542412	LFHB6042412	LFHB9042412	
		24"	LFHB3042424	LFHB4542424	LFHB6042424	LFHB9042424	
		36"	LFHB3042436	LFHB4542436	LFHB6042436	LFHB9042436	
	30"	12"	LFHB3043012	LFHB4543012	LFHB6043012	LFHB9043012	
		24"	LFHB3043024	LFHB4543024	LFHB6043024	LFHB9043024	
		36"	LFHB3043036	LFHB4543036	LFHB6043036	LFHB9043036	
	36"	12"	LFHB3043612	LFHB4543612	LFHB6043612	LFHB9043612	
		24"	LFHB3043624	LFHB4543624	LFHB6043624	LFHB9043624	
		36"	LFHB3043636	LFHB4543636	LFHB6043636	LFHB9043636	
	6"	6"	12"	LFHB3060612	LFHB4560612	LFHB6060612	LFHB9060612
			24"	LFHB3060624	LFHB4560624	LFHB6060624	LFHB9060624
			36"	LFHB3060636	LFHB4560636	LFHB6060636	LFHB9060636
9"		12"	LFHB3060912	LFHB4560912	LFHB6060912	LFHB9060912	
		24"	LFHB3060924	LFHB4560924	LFHB6060924	LFHB9060924	
		36"	LFHB3060936	LFHB4560936	LFHB6060936	LFHB9060936	
12"		12"	LFHB3061212	LFHB4561212	LFHB6061212	LFHB9061212	
		24"	LFHB3061224	LFHB4561224	LFHB6061224	LFHB9061224	
		36"	LFHB3061236	LFHB4561236	LFHB6061236	LFHB9061236	
18"		12"	LFHB3061812	LFHB4561812	LFHB6061812	LFHB9061812	
		24"	LFHB3061824	LFHB4561824	LFHB6061824	LFHB9061824	
		36"	LFHB3061836	LFHB4561836	LFHB6061836	LFHB9061836	
24"		12"	LFHB3062412	LFHB4562412	LFHB6062412	LFHB9062412	
		24"	LFHB3062424	LFHB4562424	LFHB6062424	LFHB9062424	
		36"	LFHB3062436	LFHB4562436	LFHB6062436	LFHB9062436	
30"		12"	LFHB3063012	LFHB4563012	LFHB6063012	LFHB9063012	
		24"	LFHB3063024	LFHB4563024	LFHB6063024	LFHB9063024	
		36"	LFHB3063036	LFHB4563036	LFHB6063036	LFHB9063036	
36"		12"	LFHB3063612	LFHB4563612	LFHB6063612	LFHB9063612	
		24"	LFHB3063624	LFHB4563624	LFHB6063624	LFHB9063624	
		36"	LFHB3063636	LFHB4563636	LFHB6063636	LFHB9063636	

*Included hardware is geomet-plated steel.

Aluminum Ladder Tray

Fittings, Vertical Inside Elbows



Features

- All fittings have 3" flat sections at the ends to allow space for mounting splices
- For use indoors, outdoors or in harsh environments
- Aluminum Alloy 6063
- Rungs are welded to stringers for strength and continuity
- 9" Rung spacing
- Class 1 Fitting
- Splice plates and hardware included*

Rail Height	Width	Radius	30 Degree	45 Degree	60 Degree	90 Degree	
4"	6"	12"	LFVI3040612	LFVI4540612	LFVI6040612	LFVI9040612	
		24"	LFVI3040624	LFVI4540624	LFVI6040624	LFVI9040624	
		36"	LFVI3040636	LFVI4540636	LFVI6040636	LFVI9040636	
	9"	12"	LFVI3040912	LFVI4540912	LFVI6040912	LFVI9040912	
		24"	LFVI3040924	LFVI4540924	LFVI6040924	LFVI9040924	
		36"	LFVI3040936	LFVI4540936	LFVI6040936	LFVI9040936	
	12"	12"	LFVI3041212	LFVI4541212	LFVI6041212	LFVI9041212	
		24"	LFVI3041224	LFVI4541224	LFVI6041224	LFVI9041224	
		36"	LFVI3041236	LFVI4541236	LFVI6041236	LFVI9041236	
	18"	12"	LFVI3041812	LFVI4541812	LFVI6041812	LFVI9041812	
		24"	LFVI3041824	LFVI4541824	LFVI6041824	LFVI9041824	
		36"	LFVI3041836	LFVI4541836	LFVI6041836	LFVI9041836	
	24"	12"	LFVI3042412	LFVI4542412	LFVI6042412	LFVI9042412	
		24"	LFVI3042424	LFVI4542424	LFVI6042424	LFVI9042424	
		36"	LFVI3042436	LFVI4542436	LFVI6042436	LFVI9042436	
	30"	12"	LFVI3043012	LFVI4543012	LFVI6043012	LFVI9043012	
		24"	LFVI3043024	LFVI4543024	LFVI6043024	LFVI9043024	
		36"	LFVI3043036	LFVI4543036	LFVI6043036	LFVI9043036	
	36"	12"	LFVI3043612	LFVI4543612	LFVI6043612	LFVI9043612	
		24"	LFVI3043624	LFVI4543624	LFVI6043624	LFVI9043624	
		36"	LFVI3043636	LFVI4543636	LFVI6043636	LFVI9043636	
	6"	6"	12"	LFVI3060612	LFVI4560612	LFVI6060612	LFVI9060612
			24"	LFVI3060624	LFVI4560624	LFVI6060624	LFVI9060624
			36"	LFVI3060636	LFVI4560636	LFVI6060636	LFVI9060636
9"		12"	LFVI3060912	LFVI4560912	LFVI6060912	LFVI9060912	
		24"	LFVI3060924	LFVI4560924	LFVI6060924	LFVI9060924	
		36"	LFVI3060936	LFVI4560936	LFVI6060936	LFVI9060936	
12"		12"	LFVI3061212	LFVI4561212	LFVI6061212	LFVI9061212	
		24"	LFVI3061224	LFVI4561224	LFVI6061224	LFVI9061224	
		36"	LFVI3061236	LFVI4561236	LFVI6061236	LFVI9061236	
18"		12"	LFVI3061812	LFVI4561812	LFVI6061812	LFVI9061812	
		24"	LFVI3061824	LFVI4561824	LFVI6061824	LFVI9061824	
		36"	LFVI3061836	LFVI4561836	LFVI6061836	LFVI9061836	
24"		12"	LFVI3062412	LFVI4562412	LFVI6062412	LFVI9062412	
		24"	LFVI3062424	LFVI4562424	LFVI6062424	LFVI9062424	
		36"	LFVI3062436	LFVI4562436	LFVI6062436	LFVI9062436	
30"		12"	LFVI3063012	LFVI4563012	LFVI6063012	LFVI9063012	
		24"	LFVI3063024	LFVI4563024	LFVI6063024	LFVI9063024	
		36"	LFVI3063036	LFVI4563036	LFVI6063036	LFVI9063036	
36"		12"	LFVI3063612	LFVI4563612	LFVI6063612	LFVI9063612	
		24"	LFVI3063624	LFVI4563624	LFVI6063624	LFVI9063624	
		36"	LFVI3063636	LFVI4563636	LFVI6063636	LFVI9063636	

*Included hardware is geomet-plated steel

Aluminum Ladder Tray

Fittings, Vertical Outside Elbows

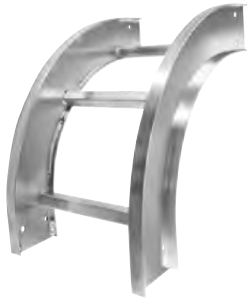

Features

- All fittings have 3" flat sections at the ends to allow space for mounting splices
- For use indoors, outdoors or in harsh environments
- Aluminum Alloy 6063
- Rungs are welded to stringers for strength and continuity
- 9" Rung spacing
- Class 1 Fitting
- Splice plates and hardware included*

Rail Height	Width	Radius	30 Degree	45 Degree	60 Degree	90 Degree	
4"	6"	12"	LFVO3040612	LFVO4540612	LFVO6040612	LFVO9040612	
		24"	LFVO3040624	LFVO4540624	LFVO6040624	LFVO9040624	
		36"	LFVO3040636	LFVO4540636	LFVO6040636	LFVO9040636	
	9"	12"	LFVO3040912	LFVO4540912	LFVO6040912	LFVO9040912	
		24"	LFVO3040924	LFVO4540924	LFVO6040924	LFVO9040924	
		36"	LFVO3040936	LFVO4540936	LFVO6040936	LFVO9040936	
	12"	12"	LFVO3041212	LFVO4541212	LFVO6041212	LFVO9041212	
		24"	LFVO3041224	LFVO4541224	LFVO6041224	LFVO9041224	
		36"	LFVO3041236	LFVO4541236	LFVO6041236	LFVO9041236	
	18"	12"	LFVO3041812	LFVO4541812	LFVO6041812	LFVO9041812	
		24"	LFVO3041824	LFVO4541824	LFVO6041824	LFVO9041824	
		36"	LFVO3041836	LFVO4541836	LFVO6041836	LFVO9041836	
	24"	12"	LFVO3042412	LFVO4542412	LFVO6042412	LFVO9042412	
		24"	LFVO3042424	LFVO4542424	LFVO6042424	LFVO9042424	
		36"	LFVO3042436	LFVO4542436	LFVO6042436	LFVO9042436	
	30"	12"	LFVO3043012	LFVO4543012	LFVO6043012	LFVO9043012	
		24"	LFVO3043024	LFVO4543024	LFVO6043024	LFVO9043024	
		36"	LFVO3043036	LFVO4543036	LFVO6043036	LFVO9043036	
	36"	12"	LFVO3043612	LFVO4543612	LFVO6043612	LFVO9043612	
		24"	LFVO3043624	LFVO4543624	LFVO6043624	LFVO9043624	
		36"	LFVO3043636	LFVO4543636	LFVO6043636	LFVO9043636	
	6"	6"	12"	LFVO3060612	LFVO4560612	LFVO6060612	LFVO9060612
			24"	LFVO3060624	LFVO4560624	LFVO6060624	LFVO9060624
			36"	LFVO3060636	LFVO4560636	LFVO6060636	LFVO9060636
9"		12"	LFVO3060912	LFVO4560912	LFVO6060912	LFVO9060912	
		24"	LFVO3060924	LFVO4560924	LFVO6060924	LFVO9060924	
		36"	LFVO3060936	LFVO4560936	LFVO6060936	LFVO9060936	
12"		12"	LFVO3061212	LFVO4561212	LFVO6061212	LFVO9061212	
		24"	LFVO3061224	LFVO4561224	LFVO6061224	LFVO9061224	
		36"	LFVO3061236	LFVO4561236	LFVO6061236	LFVO9061236	
18"		12"	LFVO3061812	LFVO4561812	LFVO6061812	LFVO9061812	
		24"	LFVO3061824	LFVO4561824	LFVO6061824	LFVO9061824	
		36"	LFVO3061836	LFVO4561836	LFVO6061836	LFVO9061836	
24"		12"	LFVO3062412	LFVO4562412	LFVO6062412	LFVO9062412	
		24"	LFVO3062424	LFVO4562424	LFVO6062424	LFVO9062424	
		36"	LFVO3062436	LFVO4562436	LFVO6062436	LFVO9062436	
30"		12"	LFVO3063012	LFVO4563012	LFVO6063012	LFVO9063012	
		24"	LFVO3063024	LFVO4563024	LFVO6063024	LFVO9063024	
		36"	LFVO3063036	LFVO4563036	LFVO6063036	LFVO9063036	
36"		12"	LFVO3063612	LFVO4563612	LFVO6063612	LFVO9063612	
		24"	LFVO3063624	LFVO4563624	LFVO6063624	LFVO9063624	
		36"	LFVO3063636	LFVO4563636	LFVO6063636	LFVO9063636	

*Included hardware is geomet-plated steel.

Aluminum Ladder Tray

Fittings, Reducers

Features

- For use indoors, outdoors or in harsh environments
- Aluminum Alloy 6063
- Rungs are welded to stringers for strength and continuity
- 9" Rung spacing
- Class 1 Fitting
- Splice plates and hardware included*

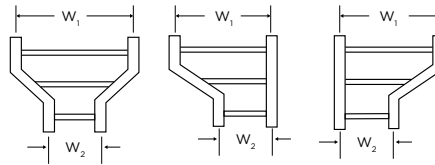

Rail Height	Width 1	Width 2	Center	left	right
4"	9"	6"	LFRC40906	LFRL40906	LFRR40906
		6"	LFRC41206	LFRL41206	LFRR41206
	12"	6"	LFRC41209	LFRL41209	LFRR41209
		9"	LFRC41806	LFRL41806	LFRR41806
	18"	9"	LFRC41809	LFRL41809	LFRR41809
		12"	LFRC41812	LFRL41812	LFRR41812
		12"	LFRC42406	LFRL42406	LFRR42406
	24"	9"	LFRC42409	LFRL42409	LFRR42409
		12"	LFRC42412	LFRL42412	LFRR42412
		18"	LFRC42418	LFRL42418	LFRR42418
		18"	LFRC43006	LFRL43006	LFRR43006
	30"	9"	LFRC43009	LFRL43009	LFRR43009
		12"	LFRC43012	LFRL43012	LFRR43012
		18"	LFRC43018	LFRL43018	LFRR43018
		24"	LFRC43024	LFRL43024	LFRR43024
		24"	LFRC43606	LFRL43606	LFRL43606
	36"	9"	LFRC43609	LFRL43609	LFRL43609
		12"	LFRC43612	LFRL43612	LFRL43612
		18"	LFRC43618	LFRL43618	LFRL43618
		24"	LFRC43624	LFRL43624	LFRL43624
30"		LFRC43630	LFRL43630	LFRL43630	
6"	9"	6"	LFRC60906	LFRL60906	LFRR60906
		6"	LFRC61206	LFRL61206	LFRR61206
	12"	6"	LFRC61209	LFRL61209	LFRR61209
		9"	LFRC61806	LFRL61806	LFRR61806
	18"	9"	LFRC61809	LFRL61809	LFRR61809
		12"	LFRC61812	LFRL61812	LFRR61812
		12"	LFRC62406	LFRL62406	LFRR62406
	24"	9"	LFRC62409	LFRL62409	LFRR62409
		12"	LFRC62412	LFRL62412	LFRR62412
		18"	LFRC62418	LFRL62418	LFRR62418
		18"	LFRC63006	LFRL63006	LFRR63006
	30"	9"	LFRC63009	LFRL63009	LFRR63009
		12"	LFRC63012	LFRL63012	LFRR63012
		18"	LFRC63018	LFRL63018	LFRR63018
		24"	LFRC63024	LFRL63024	LFRR63024
		24"	LFRC63606	LFRL63606	LFRL43606
	36"	9"	LFRC63609	LFRL63609	LFRL43609
		12"	LFRC63612	LFRL63612	LFRL43612
		18"	LFRC63618	LFRL63618	LFRL43618
		24"	LFRC63624	LFRL63624	LFRL43624
30"		LFRC63630	LFRL63630	LFRL43630	



*Included hardware is geomet-plated steel

Aluminum Ladder Tray

Fittings, Standard Horizontal Tee (Width 1 = Width 2)

Features

- All fittings have 3" flat sections at the ends to allow space for mounting splices
- For use indoors, outdoors or in harsh environments
- Aluminum Alloy 6063
- Rungs are welded to stringers for strength and continuity
- 9" Rung spacing
- Class 1 Fitting
- Splice plates and hardware included*

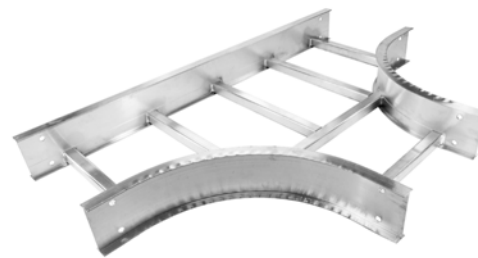

Rail Height	Width 1	Width 2	Radius	90 Degree	
4"	6"	6"	12"	LFT4060612	
			24"	LFT4060624	
			36"	LFT4060636	
	9"	9"	12"	LFT4090912	
			24"	LFT4090924	
			36"	LFT4090936	
	12"	12"	12"	LFT4121212	
			24"	LFT4121224	
			36"	LFT4121236	
	18"	18"	12"	LFT4181812	
			24"	LFT4181824	
			36"	LFT4181836	
	24"	24"	12"	LFT4242412	
			24"	LFT4242424	
			36"	LFT4242436	
	30"	30"	12"	LFT4303012	
			24"	LFT4303024	
			36"	LFT4303036	
	36"	36"	12"	LFT4363612	
			24"	LFT4363624	
			36"	LFT4363636	
	6"	6"	6"	12"	LFT6060612
				24"	LFT6060624
				36"	LFT6060636
9"		9"	12"	LFT6090912	
			24"	LFT6090924	
			36"	LFT6090936	
12"		12"	12"	LFT6121212	
			24"	LFT6121224	
			36"	LFT6121236	
18"		18"	12"	LFT6181812	
			24"	LFT6181824	
			36"	LFT6181836	
24"		24"	12"	LFT6242412	
			24"	LFT6242424	
			36"	LFT6242436	
30"		30"	12"	LFT6303012	
			24"	LFT6303024	
			36"	LFT6303036	
36"		36"	12"	LFT6363612	
			24"	LFT6363624	
			36"	LFT6363636	

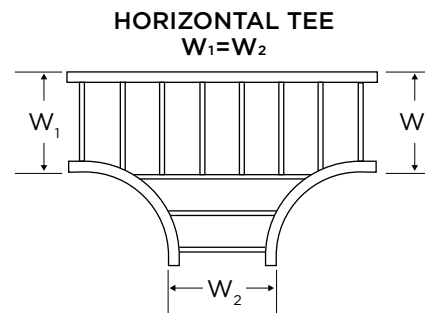

*Included hardware is geomet-plated steel.

Aluminum Ladder Tray

Fittings, Expanding Horizontal Tee (Width 1 < Width 2)

Features

- All fittings have 3" flat sections at the ends to allow space for mounting splices
- For use indoors, outdoors or in harsh environments
- Aluminum Alloy 6063
- Rungs are welded to stringers for strength and continuity
- 9" Rung spacing
- Class 1 Fitting
- Splice plates and hardware included*

Rail Height	Width 1	Width 2	Radius	Catalog	
4"	6"	9"	12"	LFT4060912	
			24"	LFT4060924	
			36"	LFT4060936	
		12"	12"	LFT4061212	
			24"	LFT4061224	
			36"	LFT4061236	
		18"	12"	LFT4061812	
			24"	LFT4061824	
			36"	LFT4061836	
		24"	12"	LFT4062412	
			24"	LFT4062424	
			36"	LFT4062436	
		30"	12"	LFT4063012	
			24"	LFT4063024	
			36"	LFT4063036	
		36"	12"	LFT4063612	
			24"	LFT4063624	
			36"	LFT4063636	
	9"	12"	12"	LFT4091212	
			24"	LFT4091224	
			36"	LFT4091236	
		18"	12"	LFT4091812	
			24"	LFT4091824	
			36"	LFT4091836	
		24"	12"	LFT4092412	
			24"	LFT4092424	
			36"	LFT4092436	
		30"	12"	LFT4093012	
			24"	LFT4093024	
			36"	LFT4093036	
		36"	12"	LFT4093612	
			24"	LFT4093624	
			36"	LFT4093636	
		12"	18"	12"	LFT4121812
				24"	LFT4121824
				36"	LFT4121836
24"	12"		LFT4122412		
	24"		LFT4122424		
	36"		LFT4122436		
30"	12"		LFT4123012		
	24"		LFT4123024		
	36"		LFT4123036		
36"	12"		LFT4123612		
	24"		LFT4123624		
	36"		LFT4123636		
18"	24"		12"	LFT4182412	
			24"	LFT4182424	
			36"	LFT4182436	
	30"		12"	LFT4183012	
			24"	LFT4183024	
			36"	LFT4183036	
	36"	12"	LFT4183612		
		24"	LFT4183624		
		36"	LFT4183636		
24"	30"	12"	LFT4243012		
		24"	LFT4243024		
		36"	LFT4243036		
	36"	12"	LFT4243612		
		24"	LFT4243624		
		36"	LFT4243636		
30"	36"	12"	LFT4303612		
		24"	LFT4303624		
		36"	LFT4303636		

Rail Height	Width 1	Width 2	Radius	Catalog	
6"	6"	9"	12"	LFT6060912	
			24"	LFT6060924	
			36"	LFT6060936	
		12"	12"	LFT6061212	
			24"	LFT6061224	
			36"	LFT6061236	
		18"	12"	LFT6061812	
			24"	LFT6061824	
			36"	LFT6061836	
		24"	12"	LFT6062412	
			24"	LFT6062424	
			36"	LFT6062436	
		30"	12"	LFT6063012	
			24"	LFT6063024	
			36"	LFT6063036	
		36"	12"	LFT6063612	
			24"	LFT6063624	
			36"	LFT6063636	
	9"	12"	12"	LFT6091212	
			24"	LFT6091224	
			36"	LFT6091236	
		18"	12"	LFT6091812	
			24"	LFT6091824	
			36"	LFT6091836	
		24"	12"	LFT6092412	
			24"	LFT6092424	
			36"	LFT6092436	
		30"	12"	LFT6093012	
			24"	LFT6093024	
			36"	LFT6093036	
		36"	12"	LFT6093612	
			24"	LFT6093624	
			36"	LFT6093636	
		12"	18"	12"	LFT6121812
				24"	LFT6121824
				36"	LFT6121836
24"	12"		LFT6122412		
	24"		LFT6122424		
	36"		LFT6122436		
30"	12"		LFT6123012		
	24"		LFT6123024		
	36"		LFT6123036		
36"	12"		LFT6123612		
	24"		LFT6123624		
	36"		LFT6123636		
18"	24"		12"	LFT6182412	
			24"	LFT6182424	
			36"	LFT6182436	
	30"		12"	LFT6183012	
			24"	LFT6183024	
			36"	LFT6183036	
	36"	12"	LFT6183612		
		24"	LFT6183624		
		36"	LFT6183636		
24"	30"	12"	LFT6243012		
		24"	LFT6243024		
		36"	LFT6243036		
	36"	12"	LFT6243612		
		24"	LFT6243624		
		36"	LFT6243636		
30"	36"	12"	LFT6303612		
		24"	LFT6303624		
		36"	LFT6303636		

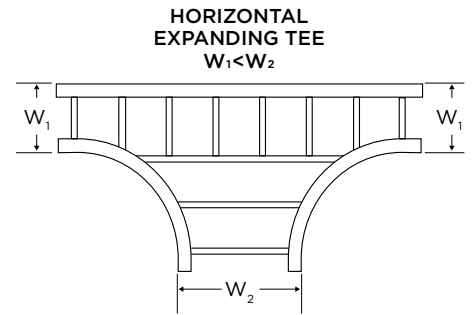
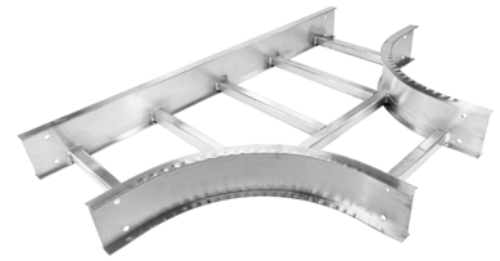

*Included hardware is geomet-plated steel.

Aluminum Ladder Tray

Fittings, Reducing Horizontal Tee (Width 1 > Width 2)

Features

- All fittings have 3" flat sections at the ends to allow space for mounting splices
- For use indoors, outdoors or in harsh environments
- Aluminum Alloy 6063
- Rungs are welded to stringers for strength and continuity

- 9" Rung spacing
- Class 1 Fitting
- Splice plates and hardware included*

Rail Height	Width 1	Width 2	Radius	Catalog	
4"	9"	6"	12"	LFT4090612	
			24"	LFT4090624	
			36"	LFT4090636	
	12"	6"	12"	LFT4120612	
			24"	LFT4120624	
			36"	LFT4120636	
		9"	12"	LFT4120912	
			24"	LFT4120924	
			36"	LFT4120936	
	18"	6"	12"	LFT4180612	
			24"	LFT4180624	
			36"	LFT4180636	
		9"	12"	LFT4180912	
			24"	LFT4180924	
			36"	LFT4180936	
		12"	12"	LFT4181212	
			24"	LFT4181224	
			36"	LFT4181236	
	24"	6"	12"	LFT4240612	
			24"	LFT4240624	
			36"	LFT4240636	
		9"	12"	LFT4240912	
			24"	LFT4240924	
			36"	LFT4240936	
12"		12"	LFT4241212		
		24"	LFT4241224		
		36"	LFT4241236		
18"		12"	LFT4241812		
		24"	LFT4241824		
		36"	LFT4241836		
6"	6"	12"	LFT4300612		
			24"	LFT4300624	
			36"	LFT4300636	
		9"	12"	LFT4300912	
			24"	LFT4300924	
			36"	LFT4300936	
		12"	12"	LFT4301212	
				24"	LFT4301224
				36"	LFT4301236
	18"		12"	LFT4301812	
			24"	LFT4301824	
			36"	LFT4301836	
	24"	12"	LFT4302412		
		24"	LFT4302424		
		36"	LFT4302436		
	36"	6"	12"	LFT4360612	
			24"	LFT4360624	
			36"	LFT4360636	
		9"	12"	LFT4360912	
			24"	LFT4360924	
			36"	LFT4360936	
		12"	12"	LFT4361212	
			24"	LFT4361224	
			36"	LFT4361236	
18"		12"	LFT4361812		
		24"	LFT4361824		
		36"	LFT4361836		
24"		12"	LFT4362412		
		24"	LFT4362424		
		36"	LFT4362436		
30"	12"	LFT4363012			
	24"	LFT4363024			
	36"	LFT4363036			

Rail Height	Width 1	Width 2	Radius	Catalog
6"	9"	6"	12"	LFT6090612
			24"	LFT6090624
			36"	LFT6090636
	12"	6"	12"	LFT6120612
			24"	LFT6120624
			36"	LFT6120636
		9"	12"	LFT6120912
			24"	LFT6120924
			36"	LFT6120936
	18"	6"	12"	LFT6180612
			24"	LFT6180624
			36"	LFT6180636
		9"	12"	LFT6180912
			24"	LFT6180924
			36"	LFT6180936
		12"	12"	LFT6181212
			24"	LFT6181224
			36"	LFT6181236
	24"	6"	12"	LFT6240612
			24"	LFT6240624
			36"	LFT6240636
		9"	12"	LFT6240912
			24"	LFT6240924
			36"	LFT6240936
12"		12"	LFT6241212	
		24"	LFT6241224	
		36"	LFT6241236	
18"		12"	LFT6241812	
		24"	LFT6241824	
		36"	LFT6241836	
30"	6"	12"	LFT6300612	
		24"	LFT6300624	
		36"	LFT6300636	
	9"	12"	LFT6300912	
		24"	LFT6300924	
		36"	LFT6300936	
	12"	12"	LFT6301212	
		24"	LFT6301224	
		36"	LFT6301236	
	18"	12"	LFT6301812	
		24"	LFT6301824	
		36"	LFT6301836	
	24"	12"	LFT6302412	
		24"	LFT6302424	
		36"	LFT6302436	
36"	6"	12"	LFT6360612	
		24"	LFT6360624	
		36"	LFT6360636	
	9"	12"	LFT6360912	
		24"	LFT6360924	
		36"	LFT6360936	
	12"	12"	LFT6361212	
		24"	LFT6361224	
		36"	LFT6361236	
	18"	12"	LFT6361812	
		24"	LFT6361824	
		36"	LFT6361836	
	24"	12"	LFT6362412	
		24"	LFT6362424	
		36"	LFT6362436	
30"	12"	LFT6363012		
	24"	LFT6363024		
	36"	LFT6363036		

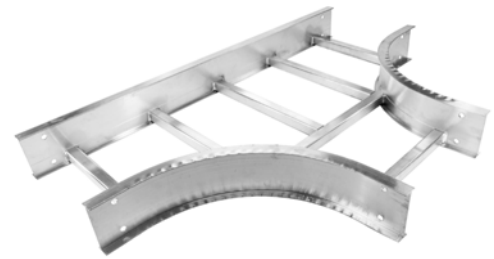

HORIZONTAL
EXPANDING TEE
W₁ > W₂

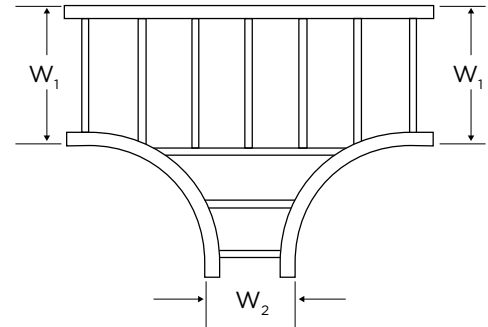

*Included hardware is geomet-plated steel.

Aluminum Ladder Tray

Fittings, Standard Cross (Width 1 = Width 2)

Features

- All fittings have 3" flat sections at the ends to allow space for mounting splices
- For use indoors, outdoors or in harsh environments
- Aluminum Alloy 6063
- Rungs are welded to stringers for strength and continuity
- 9" Rung spacing
- Class 1 Fitting
- Splice plates and hardware included*

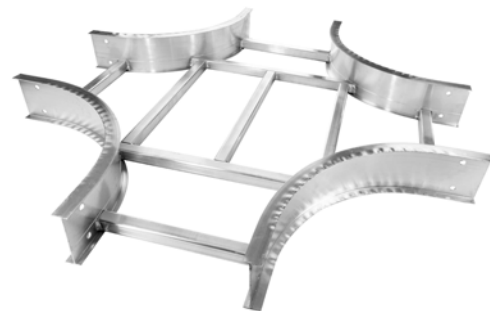

Rail Height	Width 1	Width 2	Radius	Catalog	
4"	6"	6"	12"	LFX4060612	
			24"	LFX4060624	
			36"	LFX4060636	
	9"	9"	12"	LFX4090912	
			24"	LFX4090924	
			36"	LFX4090936	
	12"	12"	12"	LFX4121212	
			24"	LFX4121224	
			36"	LFX4121236	
	18"	18"	12"	LFX4181812	
			24"	LFX4181824	
			36"	LFX4181836	
	24"	24"	12"	LFX4242412	
			24"	LFX4242424	
			36"	LFX4242436	
	30"	30"	12"	LFX4303012	
			24"	LFX4303024	
			36"	LFX4303036	
	36"	36"	12"	LFX4363612	
			24"	LFX4363624	
			36"	LFX4363636	
	6"	6"	6"	12"	LFX6060612
				24"	LFX6060624
				36"	LFX6060636
9"		9"	12"	LFX6090912	
			24"	LFX6090924	
			36"	LFX6090936	
12"		12"	12"	LFX6121212	
			24"	LFX6121224	
			36"	LFX6121236	
18"		18"	12"	LFX6181812	
			24"	LFX6181824	
			36"	LFX6181836	
24"		24"	12"	LFX6242412	
			24"	LFX6242424	
			36"	LFX6242436	
30"		30"	12"	LFX6303012	
			24"	LFX6303024	
			36"	LFX6303036	
36"		36"	12"	LFX6363612	
			24"	LFX6363624	
			36"	LFX6363636	

*Included hardware is geomet-plated steel

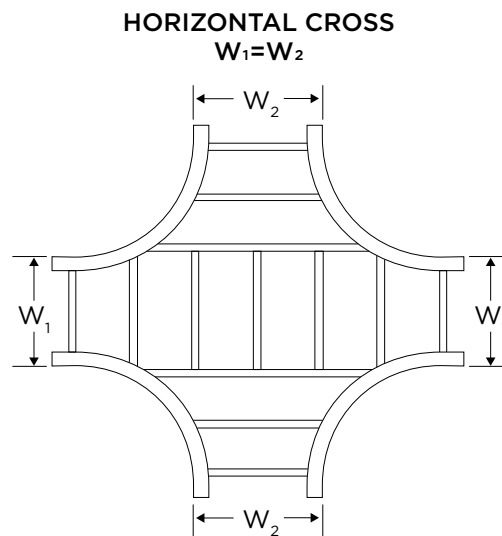

Aluminum Ladder Tray

Fittings, Reducing Cross (Width 1 > Width 2)

Features

- All fittings have 3" flat sections at the ends to allow space for mounting splices
- For use indoors, outdoors or in harsh environments
- Aluminum Alloy 6063
- Rungs are welded to stringers for strength and continuity

- 9" Rung spacing
- Class 1 Fitting
- Splice plates and hardware included*

Rail Height	Width 1	Width 2	Radius	Catalog
4"	9"	6"	12"	LFX4090612
			24"	LFX4090624
			36"	LFX4090636
	12"	6"	12"	LFX4120612
			24"	LFX4120624
			36"	LFX4120636
		9"	12"	LFX4120912
			24"	LFX4120924
			36"	LFX4120936
	18"	6"	12"	LFX4180612
			24"	LFX4180624
			36"	LFX4180636
		9"	12"	LFX4180912
			24"	LFX4180924
			36"	LFX4180936
		12"	12"	LFX4181212
			24"	LFX4181224
			36"	LFX4181236
	24"	6"	12"	LFX4240612
			24"	LFX4240624
			36"	LFX4240636
		9"	12"	LFX4240912
			24"	LFX4240924
			36"	LFX4240936
12"		12"	LFX4241212	
		24"	LFX4241224	
		36"	LFX4241236	
18"		12"	LFX4241812	
		24"	LFX4241824	
		36"	LFX4241836	
30"		6"	12"	LFX4300612
			24"	LFX4300624
			36"	LFX4300636
	9"	12"	LFX4300912	
		24"	LFX4300924	
		36"	LFX4300936	
	12"	12"	LFX4301212	
		24"	LFX4301224	
		36"	LFX4301236	
	18"	12"	LFX4301812	
		24"	LFX4301824	
		36"	LFX4301836	
	24"	12"	LFX4302412	
		24"	LFX4302424	
		36"	LFX4302436	
	36"	6"	12"	LFX4360612
			24"	LFX4360624
			36"	LFX4360636
9"		12"	LFX4360912	
		24"	LFX4360924	
		36"	LFX4360936	
12"		12"	LFX4361212	
		24"	LFX4361224	
		36"	LFX4361236	
18"		12"	LFX4361812	
		24"	LFX4361824	
		36"	LFX4361836	
24"		12"	LFX4362412	
		24"	LFX4362424	
		36"	LFX4362436	
30"		12"	LFX4363012	
		24"	LFX4363024	
		36"	LFX4363036	

Rail Height	Width 1	Width 2	Radius	Catalog
6"	9"	6"	12"	LFX6090612
			24"	LFX6090624
			36"	LFX6090636
	12"	6"	12"	LFX6120612
			24"	LFX6120624
			36"	LFX6120636
		9"	12"	LFX6120912
			24"	LFX6120924
			36"	LFX6120936
	18"	6"	12"	LFX6180612
			24"	LFX6180624
			36"	LFX6180636
		9"	12"	LFX6180912
			24"	LFX6180924
			36"	LFX6180936
		12"	12"	LFX6181212
			24"	LFX6181224
			36"	LFX6181236
	24"	6"	12"	LFX6240612
			24"	LFX6240624
			36"	LFX6240636
		9"	12"	LFX6240912
			24"	LFX6240924
			36"	LFX6240936
12"		12"	LFX6241212	
		24"	LFX6241224	
		36"	LFX6241236	
18"		12"	LFX6241812	
		24"	LFX6241824	
		36"	LFX6241836	
30"		6"	12"	LFX6300612
			24"	LFX6300624
			36"	LFX6300636
	9"	12"	LFX6300912	
		24"	LFX6300924	
		36"	LFX6300936	
	12"	12"	LFX6301212	
		24"	LFX6301224	
		36"	LFX6301236	
	18"	12"	LFX6301812	
		24"	LFX6301824	
		36"	LFX6301836	
	24"	12"	LFX6302412	
		24"	LFX6302424	
		36"	LFX6302436	
	36"	6"	12"	LFX6360612
			24"	LFX6360624
			36"	LFX6360636
9"		12"	LFX6360912	
		24"	LFX6360924	
		36"	LFX6360936	
12"		12"	LFX6361212	
		24"	LFX6361224	
		36"	LFX6361236	
18"		12"	LFX6361812	
		24"	LFX6361824	
		36"	LFX6361836	
24"		12"	LFX6362412	
		24"	LFX6362424	
		36"	LFX6362436	
30"		12"	LFX6363012	
		24"	LFX6363024	
		36"	LFX6363036	

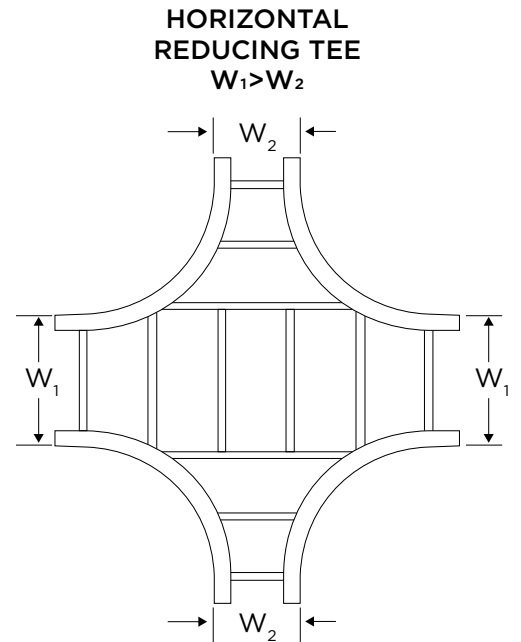
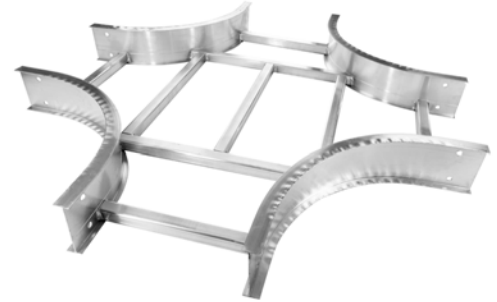

*Included hardware is geomet-plated steel.

Aluminum Ladder Tray

Accessories for Aluminum Ladder - Dividers

Features

- For use indoors, outdoors or in harsh environments
- Provided with self tapping screws



Straight Divider

Description	Rail Height	Catalog Number
12' length	4"	LD412
	6"	LD612



Flexible Divider

Description	Rail Height	Catalog Number
For use with horizontal fittings - 6' length	4"	LDF46
	6"	LDF66



Vertical Inside Divider

Rail Height	Angle	Radius	Catalog
4"	30°	12"	LDVI30412
		24"	LDVI30424
		36"	LDVI30436
	45°	12"	LDVI45412
		24"	LDVI45424
		36"	LDVI45436
	60°	12"	LDVI60412
		24"	LDVI60424
		36"	LDVI60436
	90°	12"	LDVI90412
		24"	LDVI90424
		36"	LDVI90436
6"	30°	12"	LDVI30612
		24"	LDVI30624
		36"	LDVI30636
	45°	12"	LDVI45612
		24"	LDVI45624
		36"	LDVI45636
	60°	12"	LDVI60612
		24"	LDVI60624
		36"	LDVI60636
	90°	12"	LDVI90612
		24"	LDVI90624
		36"	LDVI90636



Vertical Outside Divider

Rail Height	Angle	Radius	Catalog
4"	30°	12"	LDVO30412
		24"	LDVO30424
		36"	LDVO30436
	45°	12"	LDVO45412
		24"	LDVO45424
		36"	LDVO45436
	60°	12"	LDVO60412
		24"	LDVO60424
		36"	LDVO60436
	90°	12"	LDVO90412
		24"	LDVO90424
		36"	LDVO90436
6"	30°	12"	LDVO30612
		24"	LDVO30624
		36"	LDVO30636
	45°	12"	LDVO45612
		24"	LDVO45624
		36"	LDVO45636
	60°	12"	LDVO60612
		24"	LDVO60624
		36"	LDVO60636
	90°	12"	LDVO90612
		24"	LDVO90624
		36"	LDVO90636

Divider Splice

Description	Catalog Number
5" length	LDS5

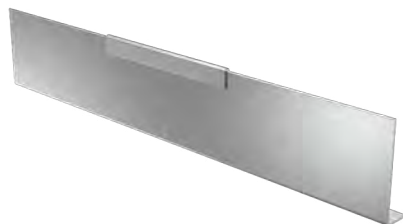

Aluminum Ladder Tray

Accessories for Aluminum Ladder - Covers For Flats, Horizontal Bends, and Vertical Inside Fittings

- For use indoors, outdoors or in harsh environments
- Flanged Cover

Horizontal Elbow Cover

Width	Radius	30 Degree	45 Degree	60 Degree	90 Degree
6"	12"	LACHB300612	LACHB450612	LACHB600612	LACHB900612
	24"	LACHB300624	LACHB450624	LACHB600624	LACHB900624
	36"	LACHB300636	LACHB450636	LACHB600636	LACHB900636
9"	12"	LACHB300912	LACHB450912	LACHB600912	LACHB900912
	24"	LACHB300924	LACHB450924	LACHB600924	LACHB900924
	36"	LACHB300936	LACHB450936	LACHB600936	LACHB900936
12"	12"	LACHB301212	LACHB451212	LACHB601212	LACHB901212
	24"	LACHB301224	LACHB451224	LACHB601224	LACHB901224
	36"	LACHB301236	LACHB451236	LACHB601236	LACHB901236
18"	12"	LACHB301812	LACHB451812	LACHB601812	LACHB901812
	24"	LACHB301824	LACHB451824	LACHB601824	LACHB901824
	36"	LACHB301836	LACHB451836	LACHB601836	LACHB901836
24"	12"	LACHB302412	LACHB452412	LACHB602412	LACHB902412
	24"	LACHB302424	LACHB452424	LACHB602424	LACHB902424
	36"	LACHB302436	LACHB452436	LACHB602436	LACHB902436
30"	12"	LACHB303012	LACHB453012	LACHB603012	LACHB903012
	24"	LACHB303024	LACHB453024	LACHB603024	LACHB903024
	36"	LACHB303036	LACHB453036	LACHB603036	LACHB903036
36"	12"	LACHB303612	LACHB453612	LACHB603612	LACHB903612
	24"	LACHB303624	LACHB453624	LACHB603624	LACHB903624
	36"	LACHB303636	LACHB453636	LACHB603636	LACHB903636



Flat Cover

Width	Catalog
6"	LACF06
9"	LACF09
12"	LACF12
18"	LACF18
24"	LACF24
30"	LACF30
36"	LACF36

Vertical Inside Elbow Cover

Width	Radius	30 Degree	45 Degree	60 Degree	90 Degree
6"	12"	LACVI300612	LACVI450612	LACVI600612	LACVI900612
	24"	LACVI300624	LACVI450624	LACVI600624	LACVI900624
	36"	LACVI300636	LACVI450636	LACVI600636	LACVI900636
9"	12"	LACVI300912	LACVI450912	LACVI600912	LACVI900912
	24"	LACVI300924	LACVI450924	LACVI600924	LACVI900924
	36"	LACVI300936	LACVI450936	LACVI600936	LACVI900936
12"	12"	LACVI301212	LACVI451212	LACVI601212	LACVI901212
	24"	LACVI301224	LACVI451224	LACVI601224	LACVI901224
	36"	LACVI301236	LACVI451236	LACVI601236	LACVI901236
18"	12"	LACVI301812	LACVI451812	LACVI601812	LACVI901812
	24"	LACVI301824	LACVI451824	LACVI601824	LACVI901824
	36"	LACVI301836	LACVI451836	LACVI601836	LACVI901836
24"	12"	LACVI302412	LACVI452412	LACVI602412	LACVI902412
	24"	LACVI302424	LACVI452424	LACVI602424	LACVI902424
	36"	LACVI302436	LACVI452436	LACVI602436	LACVI902436
30"	12"	LACVI303012	LACVI453012	LACVI603012	LACVI903012
	24"	LACVI303024	LACVI453024	LACVI603024	LACVI903024
	36"	LACVI303036	LACVI453036	LACVI603036	LACVI903036
36"	12"	LACVI303612	LACVI453612	LACVI603612	LACVI903612
	24"	LACVI303624	LACVI453624	LACVI603624	LACVI903624
	36"	LACVI303636	LACVI453636	LACVI603636	LACVI903636

*See page U-32 for Cover Clips and Cover Clamps

Aluminum Ladder Tray

Accessories for Aluminum Ladder - Covers For Vertical Outside Elbow Fittings

- For use indoors, outdoors or in harsh environments
- Flanged Cover

Vertical Outside Elbow Cover

Rail Height	Width 1	Radius	30 Degree	45 Degree	60 Degree	90 Degree	
4"	6"	12"	LACVO3040612	LACVO4540612	LACVO6040612	LACVO9040612	
		24"	LACVO3040624	LACVO4540624	LACVO6040624	LACVO9040624	
		36"	LACVO3040636	LACVO4540636	LACVO6040636	LACVO9040636	
	9"	12"	LACVO3040912	LACVO4540912	LACVO6040912	LACVO9040912	
		24"	LACVO3040924	LACVO4540924	LACVO6040924	LACVO9040924	
		36"	LACVO3040936	LACVO4540936	LACVO6040936	LACVO9040936	
	12"	12"	LACVO3041212	LACVO4541212	LACVO6041212	LACVO9041212	
		24"	LACVO3041224	LACVO4541224	LACVO6041224	LACVO9041224	
		36"	LACVO3041236	LACVO4541236	LACVO6041236	LACVO9041236	
	18"	12"	LACVO3041812	LACVO4541812	LACVO6041812	LACVO9041812	
		24"	LACVO3041824	LACVO4541824	LACVO6041824	LACVO9041824	
		36"	LACVO3041836	LACVO4541836	LACVO6041836	LACVO9041836	
	24"	12"	LACVO3042412	LACVO4542412	LACVO6042412	LACVO9042412	
		24"	LACVO3042424	LACVO4542424	LACVO6042424	LACVO9042424	
		36"	LACVO3042436	LACVO4542436	LACVO6042436	LACVO9042436	
	30"	12"	LACVO3043012	LACVO4543012	LACVO6043012	LACVO9043012	
		24"	LACVO3043024	LACVO4543024	LACVO6043024	LACVO9043024	
		36"	LACVO3043036	LACVO4543036	LACVO6043036	LACVO9043036	
	36"	12"	LACVO3043612	LACVO4543612	LACVO6043612	LACVO9043612	
		24"	LACVO3043624	LACVO4543624	LACVO6043624	LACVO9043624	
		36"	LACVO3043636	LACVO4543636	LACVO6043636	LACVO9043636	
	6"	6"	12"	LACVO3060612	LACVO4560612	LACVO6060612	LACVO9060612
			24"	LACVO3060624	LACVO4560624	LACVO6060624	LACVO9060624
			36"	LACVO3060636	LACVO4560636	LACVO6060636	LACVO9060636
9"		12"	LACVO3060912	LACVO4560912	LACVO6060912	LACVO9060912	
		24"	LACVO3060924	LACVO4560924	LACVO6060924	LACVO9060924	
		36"	LACVO3060936	LACVO4560936	LACVO6060936	LACVO9060936	
12"		12"	LACVO3061212	LACVO4561212	LACVO6061212	LACVO9061212	
		24"	LACVO3061224	LACVO4561224	LACVO6061224	LACVO9061224	
		36"	LACVO3061236	LACVO4561236	LACVO6061236	LACVO9061236	
18"		12"	LACVO3061812	LACVO4561812	LACVO6061812	LACVO9061812	
		24"	LACVO3061824	LACVO4561824	LACVO6061824	LACVO9061824	
		36"	LACVO3061836	LACVO4561836	LACVO6061836	LACVO9061836	
24"		12"	LACVO3062412	LACVO4562412	LACVO6062412	LACVO9062412	
		24"	LACVO3062424	LACVO4562424	LACVO6062424	LACVO9062424	
		36"	LACVO3062436	LACVO4562436	LACVO6062436	LACVO9062436	
30"		12"	LACVO3063012	LACVO4563012	LACVO6063012	LACVO9063012	
		24"	LACVO3063024	LACVO4563024	LACVO6063024	LACVO9063024	
		36"	LACVO3063036	LACVO4563036	LACVO6063036	LACVO9063036	
36"		12"	LACVO3063612	LACVO4563612	LACVO6063612	LACVO9063612	
		24"	LACVO3063624	LACVO4563624	LACVO6063624	LACVO9063624	
		36"	LACVO3063636	LACVO4563636	LACVO6063636	LACVO9063636	

*See page U-32 for Cover Clips and Cover Clamps

Aluminum Ladder Tray

Accessories for Aluminum Ladder - Covers For Standard Tee, Standard Cross, Reducing Cross and Joint Strips

- For use indoors, outdoors or in harsh environments
- Flanged Cover

Standard Tee Cover

Width 1	Width 2	Radius	Catalog
6"	6"	12"	LACT060612
		24"	LACT060624
		36"	LACT060636
9"	9"	12"	LACT090912
		24"	LACT090924
		36"	LACT090936
12"	12"	12"	LACT121212
		24"	LACT121224
		36"	LACT121236
18"	18"	12"	LACT181812
		24"	LACT181824
		36"	LACT181836
24"	24"	12"	LACT242412
		24"	LACT242424
		36"	LACT242436
30"	30"	12"	LACT303012
		24"	LACT303024
		36"	LACT303036
36"	36"	12"	LACT363612
		24"	LACT363624
		36"	LACT363636

Standard Cross Cover

Width 1	Width 2	Radius	Catalog
6"	6"	12"	LACX060612
		24"	LACX060624
		36"	LACX060636
9"	9"	12"	LACX090912
		24"	LACX090924
		36"	LACX090936
12"	12"	12"	LACX121212
		24"	LACX121224
		36"	LACX121236
18"	18"	12"	LACX181812
		24"	LACX181824
		36"	LACX181836
24"	24"	12"	LACX242412
		24"	LACX242424
		36"	LACX242436
30"	30"	12"	LACX303012
		24"	LACX303024
		36"	LACX303036
36"	36"	12"	LACX363612
		24"	LACX363624
		36"	LACX363636

Cover Joint Strip

Width	Catalog
6"	LACJ06
9"	LACJ09
12"	LACJ12
18"	LACJ18
24"	LACJ24
30"	LACJ30
36"	LACJ36

Reducing Cross Cover

Width 1	Width 2	Radius	Catalog
6"	6"	12"	LACX090612
		24"	LACX090624
		36"	LACX090636
12"	6"	12"	LACX120612
		24"	LACX120624
		36"	LACX120636
	9"	12"	LACX120912
		24"	LACX120924
		36"	LACX120936
18"	6"	12"	LACX180612
		24"	LACX180624
		36"	LACX180636
	9"	12"	LACX180912
		24"	LACX180924
		36"	LACX180936
	12"	12"	LACX181212
		24"	LACX181224
		36"	LACX181236
24"	6"	12"	LACX240612
		24"	LACX240624
		36"	LACX240636
	9"	12"	LACX240912
		24"	LACX240924
		36"	LACX240936
	12"	12"	LACX241212
		24"	LACX241224
		36"	LACX241236
	18"	12"	LACX241812
		24"	LACX241824
		36"	LACX241836

Reducing Cross Cover

Width 1	Width 2	Radius	Catalog
6"	6"	12"	LACX300612
		24"	LACX300624
		36"	LACX300636
	9"	12"	LACX300912
		24"	LACX300924
		36"	LACX300936
30"	12"	12"	LACX301212
		24"	LACX301224
		36"	LACX301236
	18"	12"	LACX301812
		24"	LACX301824
		36"	LACX301836
24"	6"	12"	LACX302412
		24"	LACX302424
		36"	LACX302436
	9"	12"	LACX360912
		24"	LACX360924
		36"	LACX360936
36"	12"	12"	LACX361212
		24"	LACX361224
		36"	LACX361236
	18"	12"	LACX361812
		24"	LACX361824
		36"	LACX361836
30"	24"	12"	LACX362412
		24"	LACX362424
		36"	LACX362436
	9"	12"	LACX363012
		24"	LACX363024
		36"	LACX363036

*See page U-32 for Cover Clips and Cover Clamps

Aluminum Ladder Tray

Accessories for Aluminum Ladder - Covers For Reducing Tee, Expanding Tee

- For use indoors, outdoors or in harsh environments
- Flanged Cover

Reducing Tee Cover

Width 1	Width 2	Radius	Catalog	Width 1	Width 2	Radius	Catalog	Width 1	Width 2	Radius	Catalog			
6"	6"	12"	LACT090612	24"	12"	12"	LACT241212	36"	18"	12"	LACT360612			
		24"	LACT090624			24"	LACT241224			24"	LACT360624			
		36"	LACT090636			36"	LACT241236			36"	LACT360636			
12"	6"	12"	LACT120612		18"	12"	LACT241812		36"	6"	12"	LACT360912		
		24"	LACT120624			24"	LACT241824				24"	LACT360924		
		36"	LACT120636			36"	LACT241836				36"	LACT360936		
	9"	12"	LACT120912		6"	12"	LACT300612			36"	9"	12"	LACT361212	
		24"	LACT120924			24"	LACT300624					24"	LACT361224	
		36"	LACT120936			36"	LACT300636					36"	LACT361236	
18"	6"	12"	LACT180612	9"		12"	LACT300912	36"	12"		12"	LACT361812		
		24"	LACT180624			24"	LACT300924				24"	LACT361824		
		36"	LACT180636			36"	LACT300936				36"	LACT361836		
	9"	12"	LACT180912			12"	12"		LACT301212		36"	18"	12"	LACT362412
		24"	LACT180924				24"		LACT301224				24"	LACT362424
		36"	LACT180936				36"		LACT301236				36"	LACT362436
	12"	12"	LACT181212	18"	12"		LACT301812		36"	24"		12"	LACT363012	
		24"	LACT181224		24"		LACT301824					24"	LACT363024	
		36"	LACT181236		36"		LACT301836					36"	LACT363036	
	24"	6"	12"		LACT240612	24"	12"			LACT302412	36"	24"	24"	LACT363024
			24"		LACT240624		24"			LACT302424			36"	LACT363036
			36"		LACT240636		36"			LACT302436				
9"		12"	LACT240912	30"	12"		LACT303012	36"		36"			36"	LACT363036
		24"	LACT240924		12"		LACT303024							
		36"	LACT240936		12"		LACT303036							

Expanding Tee Cover

Width 1	Width 2	Radius	Catalog	Width 1	Width 2	Radius	Catalog	Width 1	Width 2	Radius	Catalog			
6"	6"	12"	LACT090612	24"	12"	12"	LACT241212	36"	18"	12"	LACT360612			
		24"	LACT090624			24"	LACT241224			24"	LACT360624			
		36"	LACT090636			36"	LACT241236			36"	LACT360636			
12"	6"	12"	LACT120612		18"	12"	LACT241812		36"	6"	12"	LACT360912		
		24"	LACT120624			24"	LACT241824				24"	LACT360924		
		36"	LACT120636			36"	LACT241836				36"	LACT360936		
	9"	12"	LACT120912		6"	12"	LACT300612			36"	9"	12"	LACT361212	
		24"	LACT120924			24"	LACT300624					24"	LACT361224	
		36"	LACT120936			36"	LACT300636					36"	LACT361236	
18"	6"	12"	LACT180612	9"		12"	LACT300912	36"	12"		12"	LACT361812		
		24"	LACT180624			24"	LACT300924				24"	LACT361824		
		36"	LACT180636			36"	LACT300936				36"	LACT361836		
	9"	12"	LACT180912			12"	12"		LACT301212		36"	18"	12"	LACT362412
		24"	LACT180924				24"		LACT301224				24"	LACT362424
		36"	LACT180936				36"		LACT301236				36"	LACT362436
	12"	12"	LACT181212	18"	12"		LACT301812		36"	24"		12"	LACT363012	
		24"	LACT181224		24"		LACT301824					24"	LACT363024	
		36"	LACT181236		36"		LACT301836					36"	LACT363036	
	24"	6"	12"		LACT240612	24"	12"			LACT302412	36"	24"	24"	LACT363024
			24"		LACT240624		24"			LACT302424			36"	LACT363036
			36"		LACT240636		36"			LACT302436				
9"		12"	LACT240912	30"	12"		LACT303012	36"		36"			36"	LACT363036
		24"	LACT240924		12"		LACT303024							
		36"	LACT240936		12"		LACT303036							

*See page U-32 for Cover Clips and Cover Clamps

Aluminum Ladder Tray

Accessories for Aluminum Ladder - Covers For Reducers, Cover Clips and Cover Clamps

- For use indoors, outdoors or in harsh environments
- Flanged Cover

Reducer Cover

Width 1	Width 2	Center	Left	Right
9"	6"	LACRC0906	LACRL0906	LACRR0906
12"	6"	LACRC1206	LACRL1206	LACRR1206
	9"	LACRC1209	LACRL1209	LACRR1209
18"	6"	LACRC1806	LACRL1806	LACRR1806
	9"	LACRC1809	LACRL1809	LACRR1809
	12"	LACRC1812	LACRL1812	LACRR1812
24"	6"	LACRC2406	LACRL2406	LACRR2406
	9"	LACRC2409	LACRL2409	LACRR2409
	12"	LACRC2412	LACRL2412	LACRR2412
	18"	LACRC2418	LACRL2418	LACRR2418
30"	6"	LACRC3006	LACRL3006	LACRR3006
	9"	LACRC3009	LACRL3009	LACRR3009
	12"	LACRC3012	LACRL3012	LACRR3012
	18"	LACRC3018	LACRL3018	LACRR3018
	24"	LACRC3024	LACRL3024	LACRR3024
36"	6"	LACRC3606	LACRL3606	LACRR3606
	9"	LACRC3609	LACRL3609	LACRR3609
	12"	LACRC3612	LACRL3612	LACRR3612
	18"	LACRC3618	LACRL3618	LACRR3618
	24"	LACRC3624	LACRL3624	LACRR3624
	30"	LACRC3630	LACRL3630	LACRR3630

Cover Clip

Description	Catalog Number
Stainless Steel. For use with horizontally mounted covers.	LACL



Cover Clamp

Description	Width	Catalog Number
Aluminum with Stainless Steel hardware. Suitable for use with all flat covers.	6"	LACC0406
	9"	LACC0409
	12"	LACC0412
	18"	LACC0418
	24"	LACC0424
	30"	LACC0430
	36"	LACC0436
	6"	LACC0606
	9"	LACC0609
	12"	LACC0612
	18"	LACC0618
	24"	LACC0624
	30"	LACC0630
	36"	LACC0636



Number of Cover Fasteners Required	Cover Clip	Cover Clamp
Straight 12' section	6	3
Horizontal/Vertical Bends	4	2
Tees	6	3
Crosses	8	4

Aluminum Ladder Tray

Accessories for Aluminum Ladder - Supports

- For use indoors, outdoors or in harsh environments
- Center Supports and Wall Brackets are Steel with a Hot Dip Galvanized finish
- Ceiling Supports are Steel with a Mill Galvanized Finish
- Support Hardware Kits are Steel with a Zinc Plated finish

Center Support

Tray Width	Actual Width	Catalog
6"	12"	LSC06
9"	15"	LSC09
12"	18"	LSC12
18"	24"	LSC18
24"	30"	LSC24
30"	36"	LSC30
36"	42"	LSC36

Hardware Kit for Center Support

	Catalog
For 3/8" Threaded Rod	LHT38
For 1/2" Threaded Rod	LHT12
Kits includes (2) hold down clamps; (2) bolts; (2) spring nuts; (1) washer; (2) nuts	



Ceiling Support

Tray Width	Actual Width	Catalog
6"	18"	LSE06
9"	22"	LSE09
12"	24"	LSE12
18"	30"	LSE18
24"	36"	LSE24

Hardware Kit for Ceiling Support

	Catalog
For 3/8" Threaded Rod	LHC38
For 1/2" Threaded Rod	LHC12
Kit includes (2) hold down clamps; (2) bolts; (2) spring nuts; (4) washers; (4) nuts	



Wall Bracket

Tray Width	Actual Width	Catalog
6"	12"	LSW06
9"	15"	LSW09
12"	18"	LSW12
18"	24"	LSW18

Hardware Kit for Wall Bracket

	Catalog
Kit includes (2) hold down clamps (2) bolts; (2) spring nuts	LHWB



Heavy Duty Wall Bracket

Tray Width	Actual Width	Catalog
6"	12"	LSH06
9"	15"	LSH09
12"	18"	LSH12
18"	24"	LSH18
24"	30"	LSH24
30"	36"	LSH30
36"	42"	LSH42

Hardware Kit for HD Wall Bracket

	Catalog
Kit includes (2) hold down clamps (2) bolts; (2) spring nuts	LHWB



Hanger Support

Rail Height	Horizontal Hanger	Vertical Hanger	Hanger Rod Clamp
4"	LSG4	LSV4	LHC4
6"	LSG6	LSV6	LHC6



* The LSG and LSV hangers function as both a splice plate and a method of support
 * The LSG and LSV hangers are sold as a pair. The LHC hangers are sold individual.

Aluminum Ladder Tray

Accessories for Aluminum Ladder - Accessories

Splice Plates

Description	Rail Height	Catalog Number
For joining sections	4"	LCN4
	6"	LCN6



Expansion Splice Plates

Description	Rail Height	Catalog Number
When required. Bonding jumper required	4"	LCE4
	6"	LCE6



Step-Down Splice Plate

Description	Catalog Number
Transition from 6" to 4" Rail Height	LCR64



Vertical Adjustment Splice Plates

Description	Rail Height	Catalog Number
For changes in vertical direction not requiring a radius	4"	LCV4A
	6"	LCV6A



Horizontal Adjustment Splice Plates

Description	Rail Height	Catalog Number
For changes in horizontal direction not requiring a radius	4"	LCH4
	6"	LCH6



Blank End Plate

To close off end of tray

Rail Height	Width	Catalog
4"	6"	LBP406
	9"	LBP409
	12"	LBP412
	18"	LBP418
	24"	LBP424
	30"	LBP430
6"	6"	LBP606
	9"	LBP609
	12"	LBP612
	18"	LBP618
	24"	LBP624
	30"	LBP630
	36"	LBP636



Box Connector

For attaching tray end to an enclosure

Rail Height	Width	Catalog
4"	6"	LBC406
	9"	LBC409
	12"	LBC412
	18"	LBC418
	24"	LBC424
	30"	LBC430
6"	6"	LBC606
	9"	LBC609
	12"	LBC612
	18"	LBC618
	24"	LBC624
	30"	LBC630
	36"	LBC636

Cable Drop Out

Provides a radius for cables to exit through bottom of the tray

Width	Catalog
6"	LBP406
9"	LBP409
12"	LBP412
18"	LBP418
24"	LBP424
30"	LBP430
36"	LBP436



Wall Sleeve

Used for wall penetrations*

Rail Height	Width	Catalog
4"	6"	LWS406
	9"	LWS409
	12"	LWS412
	18"	LWS418
	24"	LWS424
	30"	LWS430
6"	6"	LWS606
	9"	LWS609
	12"	LWS612
	18"	LWS618
	24"	LWS624
	30"	LWS630
	36"	LWS636



Hold Down Clamp

Description	Catalog Number
Functions as both a hold down clamp and expansion guide.	LHDC



Bonding Jumper

Required with Expansion Connectors

Description	Catalog Number
#1 AWG, 600A rated	LGJ16
16" total length. Eyes are 15" on center	



Ground Wire Clamp

Description	Catalog Number
No drilling required. Accepts #6 thru 2/0	LGWAL



*Not fire rated

Aluminum Ladder Tray

Span/ Load Class Designations

Commonly called the Load Class, this defines the load-carrying capability of the tray for a specific support span distance. The design and cost of the cable tray is greatly affected by this designation. In order to determine the most appropriate and economical system, a class should be selected that reflects the actual total working load and support span for each application.

Concentrated Static Loads:

Some applications may require the cable tray to support the weight of a single, dead object in addition to the cable loads. Specifications typically require this to be applied at the midpoint of the span between the tray supports, which is the worst-case location.

To incorporate this in the tray design the following formula can be used to convert the concentrated static load in pounds to an equivalent uniform load (W_e) in pounds per foot. That equivalent load can then be combined with the weight of cables, tray contents, and other loads that are also expressed in lbs/ft to determine the total Working Load.

$$W_e = \frac{2 \times (\text{Concentrated static load, lbs})}{\text{support span length, ft}}$$

Note: This calculation is based on the load being applied at the center of the tray in the middle of a rung or bottom. If the specification requires the concentrated static load to be applied on top of one side rail, then the equivalent uniform load will be 2 times the result of this calculation.

Example: A cable tray is to be supported on 20' spans. It shall contain 50 lbs/ft of cables and support 15 lbs/ft of snow load. It is also required to support a 250 pound concentrated static load applied in the center of the tray width.

Using the calculation above, the concentrated static load is converted to an equivalent uniform load as follows: $2 \times 250 \text{ lbs} / 20 \text{ ft} = 25 \text{ lbs/ft}$

The Total Working Load will be the combination of all 3 loads, expressed in lbs/ft:

Cables	40 lbs
Snow	+ 15 lbs/ft
Concentrated Load	+25 lbs/ft
<hr/>	
Total Working Load: 80lbs/ft	

Refer to the chart on the right. With a support span of 20' and a total working load of 80 lbs/ft, a NEMA Class 20B tray rated at 75 lbs/ft will not be adequate. A NEMA Class 20C tray, rated at 100 lbs/ft, will be required.

Material: All fittings are aluminum with arc-welded construction.

Side Rails: Fitting side rails are I-beams with overall dimensions similar to straight tray sections.

Rungs and Bottoms: Rung and Bottom designs are identical to similar straight cable tray sections.

Tangents: All fittings have 3" tangents (flats) at the end of all curved side rails to accommodate splice plate connectors.

Radius: Standard NEMA VE1 12", 24" and 36" available for all curved fittings.

Square Corners: 90 Degree Horizontal Elbows, Horizontal Tees and Horizontal Crosses are available with square corners (0" Radius). The 6" through 18" square-corner fittings are designed to align with the centerline of 24" square panels of raised-floor systems

Splice Plates: All elbows are supplied with one pair of standard splice plates with hardware at no charge. Wye fittings and tees include 2 pairs and crosses include 3 pairs with hardware at no charge.

Span/Load Class Designations Per NEMA Standard VE1/CSA C22.2 No.126

Working Load LBS/FT (Kg/M)	Support Span, Feet (Meters)					
	5 Ft (1.5 M)	8 Ft (2.4 M)	10 Ft (3.0 M)	12 Ft (3.6 M)	16 Ft (4.9 M)	20 Ft (6.0 M)
25 (37)	5AA	8AA	10AA	12AA		20AA
45 (67)						D
50 (74)	5A	8A		12A	16A	20A
65 (97)			C			
75 (112)		8B		12B	16B	E* or 20B
100 (149)		8C		12C	16C	20C
120 (179)			D			
200 (299)			E			

* CSA Classes D and E are applicable to both 3.0 and 6.0 meter support spans. The appropriate support span should also be included when specifying these classes (example: D-3M).

Working Load

The total load supported by the cable tray, uniformly distributed. This will be the combined weight of all of the cables or tray contents, any environmental loads (snow, ice, dust) and any concentrated static loads.

Support Span

The maximum distance between the tray supports.

NEMA Load Classes

A number (support span in feet) combined with a letter (load capacity:A=50, B=75 and C=100 Lbs/Ft). Defined in the National Electrical ManufacturersAssoc. NEMAStandard VE1.

CSA Load Classes

A single letter (A,B,C,D,E) designates the support span and load capacity per Canadian Standards Association CSAStandard C22.2, No. 126.



All Hubbell aluminum cable trays are classified by Underwriters Laboratories as suitable for use as equipment grounding conductors per NEC 392 and are certified by UL to meet all requirements of CSA Std. C22.2 No. 126. All NEMA and CSA safe load data is based on destruction load tests that were witnessed and certified to be accurate by Underwriters Laboratories.

Steel Ladder Rack

Hubbell's NEXTFRAME® Ladder Rack is the effective and widely used cable runway that supports and delivers bundles of cable between cabinets, racks, and closets, along walls, and suspended from ceilings.

The Ladder Rack features light, rugged, tubular steel construction. It is designed for mechanical support and strain relief in long runs of cable and creates a smooth gradual bend for cable. Rail and stringer material is 16 ga steel tubing.

The NEXTFRAME® Ladder Rack is available in popular gray and black finishes to complement equipment in any data center. The complete NEXTFRAME® Ladder Rack system features a broad line of sizes and fittings required for proper installation.



Features

- Supports horizontal/vertical and overhead cable management
- Durable black or gray powder coat finish
- Supports UTP or fiber cabling
- Complete family of accessories includes: wall supports and brackets, cable drops, retaining posts, splice kits, and ceiling mounting kits

Specifications

- Material: 16 ga. tubular steel
- Durable powder coat
- Stringer dimensions: 0.375"W x 1.5"H
- Rung spacing: 9.0"
- Weight capacity: 45 lbs./foot

Applications

Use in data centers, the equipment room, and telecommunications room to provide racking, cable management, and grounding for network hardware.

Modular System: Easily Configured for New and Existing Cable Routing.

Mounts to: Floors, Walls, Ceilings, Equipment Racks, and Cabinets.

Tip: Secure Ladder to Cabinet Tops Using J-bolt Kit and Drilling Holes as Required.



Straight Sections

Width Inches (mm)	6' (1829) Length		10' (3048) Length	
	Gray	Black	Gray	Black
6" (152)	HLS0606G	HLS0606B	HLS1006G	HLS1006B
12" (305)	HLS0612G	HLS0612B	HLS1012G	HLS1012B
18" (457)	HLS0618G	HLS0618B	HLS1018G	HLS1018B
24" (610)	HLS0624G	HLS0624B	HLS1024G	HLS1024B

Note: Width = outside to outside dimensions.

90° Turns

Width Inches (mm)	Inside Radius 90°		Outside Radius 90°	
	Gray	Black	Gray	Black
6" (152)	HLI0690G	HLI0690B	HLO0690G	HLO0690B
12" (305)	HLI1290G	HLI1290B	HLO1290G	HLO1290B
18" (457)	HLI1890G	HLI1890B	HLO1890G	HLO1890B
24" (610)	HLI2490G	HLI2490B	HLO2490G	HLO2490B

Flat Turns 90°

Width Inches (mm)	Flat Turns 90°		Corner Support Bracket Internal Radius 90°, 8.25" (210) Width	
	Gray	Black	Gray	Black
6" (152)	HLF0690G	HLF0690B	HLCG	HLCB
12" (305)	HLF1290G	HLF1290B		
18" (457)	HLF1890G	HLF1890B		
24" (610)	HLF2490G	HLF2490B		

Jumper Kit

Type	Contents	Material	Catalog No.
Ladder Tray	Includes: (1) 9" #6 conductor with long barrel lugs crimped on both ends, stainless steel hardware, labeled, antioxidant	Copper	HGRKTD9D

Steel Ladder Rack

Splice Kits

		
Butt Splice Kit	Swivel Splice Kit	T-Junction Splice Kit
HLBSK	HLSSK	HLTK

Ceiling Mounting Kit

Description	Black
Ceiling mounting kit with two 6' x 0.625Ø threaded rods	HLCMK
Brackets only	HLCF



Vertical Wall Bracket

Description	Black
2 clips	HLVWBK



J-Bolt Kit

Description	Catalog Number
2-pack, galvanized	HLJB



Foot Kit

Description	Black
2-pack with splices	HLRF



Triangle Wall Supports

Width Inches (mm)	Gray	Black
6" (152)	HLTSB06G	HLTSB06B
12" (305)	HLTSB12G	HLTSB12B
18" (457)	HLTSB18G	HLTSB18B
24" (610)	HLTSB24G	HLTSB24B



Cable Retaining Fence Posts

Nominal Height Inches (mm)	Gray	Black
6" (152)	HLP06G	HLP06B
8" (203)	HLP08G	HLP08B
10" (254)	HLP10G	HLP10B



Wall Angle Supports

Width Inches (mm)	Gray	Black
6-12" (152-305)	HLX0612G	HLX0612
18" (457)	HLX1518G	HLX1518
24" (610)	HLX24G	HLX24



Wall/Rack Mounting Kit

Description	Black
Includes (1) HLMPK19, (1) HLX0612, (1) 40"L x 12"W ladder section	HLWRK



Protective End Caps

Description	Black
2-pack	HLECPK2



Ladder Standoff Support

Description	Gray	Black
14" vertical support	HLH14G	HLH14B



Mounting Kit to Relay Rack

Description	Black
3" rack	HLMPK19
6" rack	HLMPK19D



Cable Radius Drop

Ladder Width Inches (mm)	Actual Width Inches (mm)	Black
6" (152)	4.5" (114)	HLCD06*
12" (305)	10.75" (273)	HLCD12
18" (457)	16.75" (425)	HLCD18
Stringer	7.5" (191)	HLCD5



*Can also be mounted on stringer

Elevation Kit

Height Inches (mm)	Black
2-3" (51-76)	HLEK23
4-6" (102-152)	HLEK46



SECTION V

Table of Contents

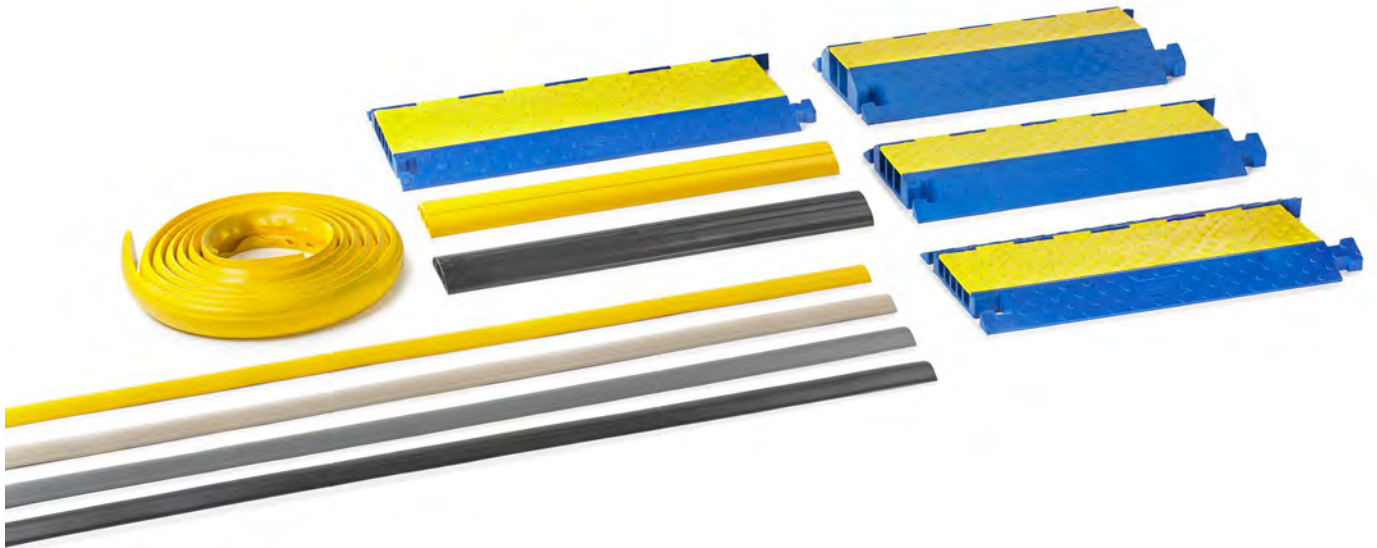

TrukTrak® and
TredTrak® Systems

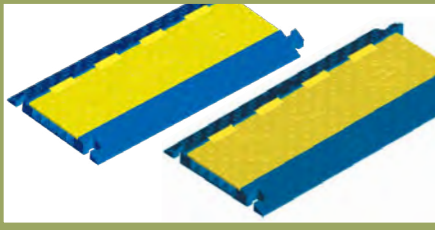

FloorTrak® Systems



Product	Page
Products at a Glance	V-2
Features and Benefits	V-3
TrukTrak® Systems	V-4
TredTrak® Systems	V-5
FloorTrak® Floor Cable Cover	V-6

Hose and Cable Protection Systems

Products at a Glance

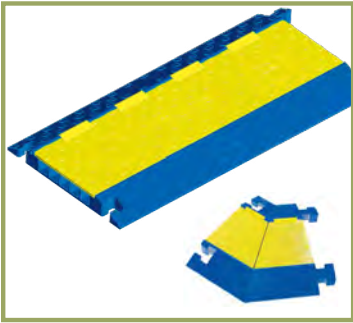

TrukTrak® Systems

- High density polyurethane construction supports heavy loads and is weather resistant
- Modular interlocking design for easy installation, breakdown and storage
- Safety surface pattern reduces slipping and skidding
- High visibility safety blue and yellow colors

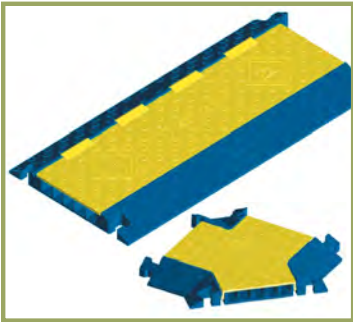

TredTrak® Systems

- High density polyurethane construction supports heavy loads and is weather resistant
- Modular interlocking design for easy installation, breakdown and storage
- Safety surface pattern reduces slipping and skidding
- High visibility safety blue and yellow colors



FloorTrak® Floor Cable Cover

- Flexible and rigid PVC material
- Protects and reduces trip hazards
- Available in four different sizes and five PVC colors to blend with the various decors
- Withstands temperatures of 0°F to +120°F (-18°C to +49°C)

Hose and Cable Protection Systems

Features and Benefits



Hubbell TrukTrak® non-metallic cable protectors are designed to safeguard electrical cables and cords from vehicle and pedestrian traffic. The TrukTrak interlocking system comes in two, three and five channel sizes and will protect cables up to 3.25 inches (82.6mm) in diameter. It is ideal for the industrial environment where it is necessary to support heavy trucks and fork lifts.



TredTrak® non-metallic cable protectors can also be interlocked to protect cables and cords of any length. The TredTrak system is a five channel modular cable protection system that will protect cable diameters up to 1.28 inches (32.5mm). It is designed to support pedestrian and light vehicle traffic in public, institutional and commercial applications. The Hubbell modular cable protection line also permits compliance with NEC® requirements (Article 525) for insulating electrical cables and cord at carnivals, amusement parks, convention centers and similar public areas.

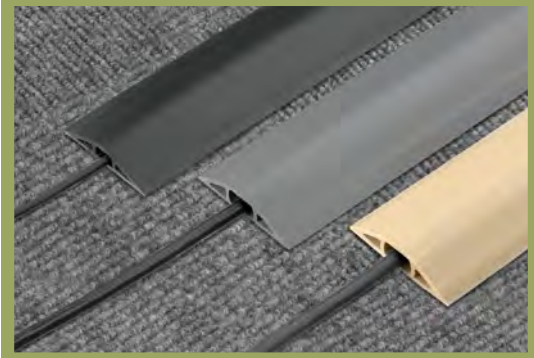

FloorTrak® is a flexible, non-metallic cover for cables that run over the floor when portable cords and cables cannot be concealed or routed away from traffic patterns. FloorTrak protects, organizes and reduces trip hazards. Four different sizes mean it will handle cables of up to 1.25 inches (31.8mm) in diameter. FT2, FT3 and FT4 are available in five PVC colors to blend with the various decors. FT10 is available in black and yellow colors only. The F10 Heavy Duty FloorTrak is ideal for applications such as industrial work areas, food processing plants and abusive areas where cable management is necessary.

NEC® is a registered trademark of the The National Electrical Code.

Hose and Cable Protection Systems

TrukTrak® Systems

Ideal for Heavy Vehicle Traffic in Industrial, Commercial or Public Applications

- High density polyurethane construction supports heavy loads and is weather resistant
- Modular interlocking design for easy installation, breakdown and storage
- Safety surface pattern reduces slipping and skidding
- High visibility safety blue and yellow colors

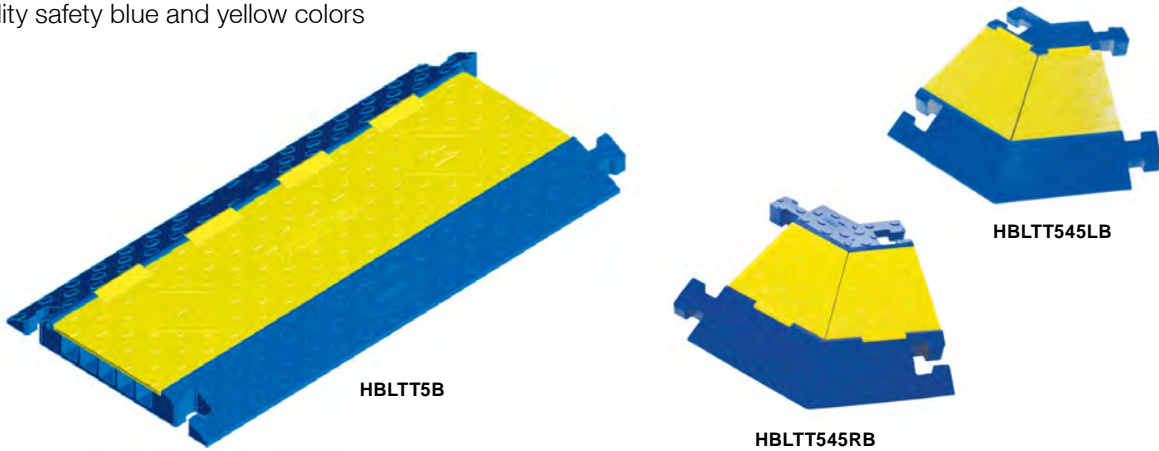

TrukTrak® Systems	Trak			Channel			Catalog Number
	A Length in. (mm)	B Width in. (mm)	C Height in. (mm)	D Width in. (mm)	E Height in. (mm)	Weight lbs. (kg)	
5 Channel TrukTrak®, blue and yellow.	36.0" (914)	20" (508)	2.31" (58.7)	1.25" (31.8)	1.25" (31.8)	30.60 (13.9)	HBLTT5B
5 Channel TrukTrak® end caps (pair only), yellow.	7.50" (190)	20" (508)	2.31" (58.7)	1.25" (31.8)	1.25" (31.8)	8.55 (3.9)	HBLTT5ECB (Female end)
	5.25" (133)	20" (508)	2.31" (58.7)	1.25" (31.8)	1.25" (31.8)	8.55 (3.9)	(Male end)
5 Channel 45° right turn TrukTrak®, blue and yellow.	25.0" (635)	20" (508)	2.31" (58.7)	1.25" (31.8)	1.25" (31.8)	15.35 (7.0)	HBLTT545RB
5 Channel 45° left turn TrukTrak®, blue and yellow.	25.0" (635)	20" (508)	2.31" (58.7)	1.25" (31.8)	1.25" (31.8)	14.45 (6.6)	HBLTT545LB
3 Channel TrukTrak®, blue and yellow.	36.0" (914)	20" (508)	3.05" (77.5)	2.25" (57.2)	2.25" (57.2)	30.85 (14.0)	HBLTT3B
3 Channel TrukTrak® end caps (pair only), yellow.	8.25" (209)	20" (508)	3.05" (77.5)	2.25" (57.2)	2.25" (57.2)	10.25 (4.6)	HBLTT3ECB (Female end)
	6.38" (162)	20" (508)	3.05" (77.5)	2.25" (57.2)	2.25" (57.2)	10.25 (4.6)	(Male end)
2 Channel TrukTrak®, blue and yellow.	36.0" (914)	22" (559)	4.13" (104.9)	3.25" (82.6)	3.25" (82.6)	41.00 (18.6)	HBLTT2B

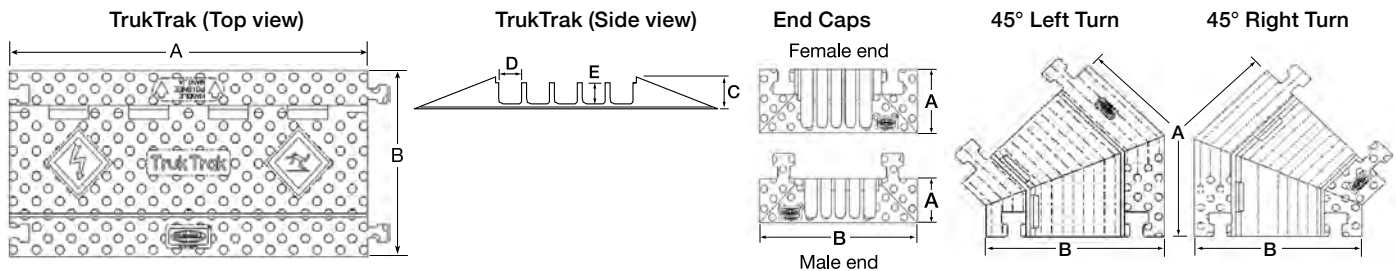

Specifications

Material	Polyurethane.
Operating Temperature	-40°F to +120°F (-40°C to +49°C).
Hinge Material	Reinforced fiberglass.
Safety Symbols	Per ANSI Z535.3.

Load Capacity

No. of Channels	Test Fixture Footprint Inches (mm)	Tire Load lbs. +/- 20%		Axle Load lbs. +/- 20%	
		70°F (21°C)	120°F (49°C)	70°F (21°C)	120°F (49°C)
5	6.9" x 17.3" (175 X 439)	20,150	9,200	40,300	18,400
3	6.9" x 17.3" (175 X 439)	14,210	4,653	28,420	9,306
2	6.9" x 17.3" (175 X 439)	10,880	2,095	21,760	4,190

Dimensions in Inches (mm)

Hose and Cable Protection Systems

TredTrak® Systems

Improves Pedestrian Safety by Decreasing Risk of Tripping

- High density polyurethane construction supports heavy loads and is weather resistant
- Modular interlocking design for easy installation, breakdown and storage
- Safety surface pattern reduces slipping and skidding
- High visibility safety blue and yellow colors

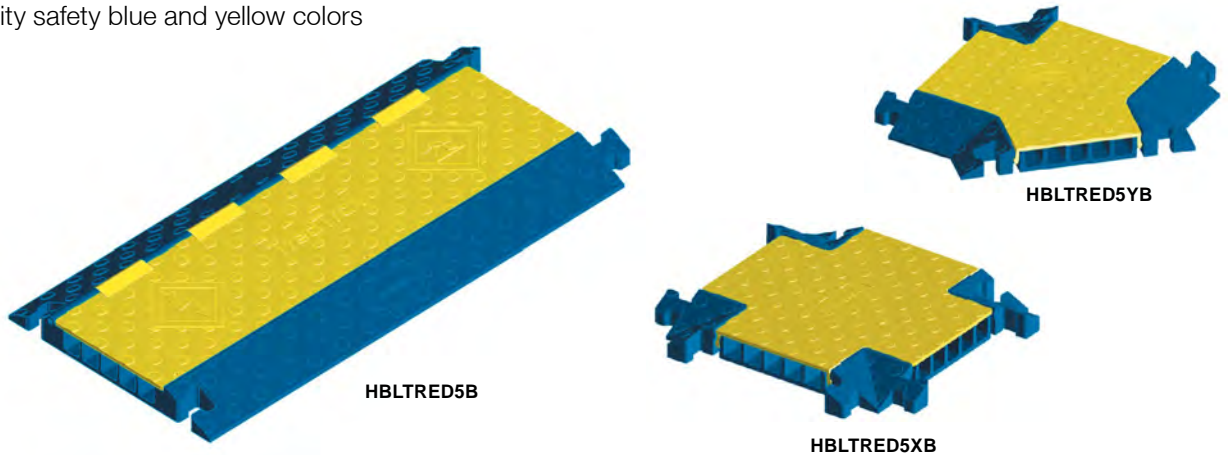

TredTrak® Systems	Trak			Channel			Catalog Number
	A	B	C	D	E	Weight	
Description	Length in. (mm)	Width in. (mm)	Height in. (mm)	Width in. (mm)	Height in. (mm)	lbs. (kg)	
5 Channel TredTrak®, blue and yellow.	36.0" (914)	17.5" (445)	1.95" (50)	1.30" (33)	1.30" (33)	21.15 (9.6)	HBLTRED5B
5 Channel TredTrak® end caps (pair only), yellow.	5.75" (146)	17.5" (445)	1.95" (50)	1.30" (33)	1.30" (33)	6.40 (2.9)	HBLTRED5ECB (Female end)
	5.75" (146)	17.5" (445)	1.95" (50)	1.30" (33)	1.30" (33)	6.40 (2.9)	(Male end)
5 Channel TredTrak® female end caps (2 females), yellow.	5.75" (146)	17.5" (445)	1.95" (50)	1.30" (33)	1.30" (33)	6.40 (2.9)	HBLTRED5ECFB
5 Channel "X" fitting, blue and yellow.	17.5" (445)	17.5" (445)	1.95" (50)	1.30" (33)	1.30" (33)	14.25 (6.5)	HBLTRED5XB
5 Channel "Y" fitting, blue and yellow.	17.5" (445)	17.5" (445)	1.95" (50)	1.30" (33)	1.30" (33)	13.95 (6.3)	HBLTRED5YB

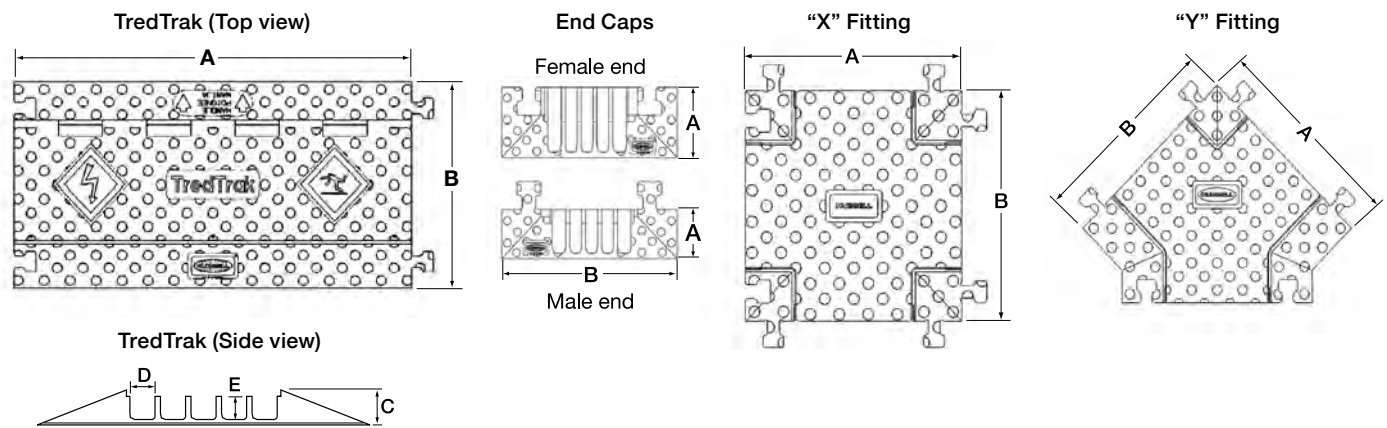

Specifications

Material	Polyurethane.
Operating Temperature	-40°F to +120°F (-40°C to +49°C).
Hinge Material	Reinforced fiberglass.
Safety Symbols	Per ANSI Z535.3.

Load Capacity

Product	Test Fixture Footprint Inches (mm)	Tire Load lbs. +/- 20%		Axle Load lbs. +/- 20%	
		70°F (21°C)	120°F (49°C)	70°F (21°C)	120°F (49°C)
TredTrak	6.9" x 17.3" (175 X 439)	10,500	6,500	21,000	13,000
"X" Fitting	6.9" x 17.3" (175 X 439)	2,900	2,300	5,800	5,600
"Y" Fitting	6.9" x 17.3" (175 X 439)	2,900	2,300	5,800	5,600

Dimensions in Inches (mm)

Hose and Cable Protection Systems

FloorTrak® Floor Cable Cover

For Pedestrian Traffic in Office and Public Areas

- Flexible and rigid PVC material
- Protects and reduces trip hazards
- Available in four different sizes and five PVC colors to blend with the various decors
- Withstands temperatures of 0°F to +120°F (-18°C to +49°C)



FloorTrak® 2*

Color	Length Feet (meters)	Catalog Number
Black	10.0' (3.05)	FT2BK10
Brown	10.0' (3.05)	FT2BR10
Beige	10.0' (3.05)	FT2BG10
Gray	10.0' (3.05)	FT2GY10
Yellow	10.0' (3.05)	FT2Y10



FloorTrak® 4

Color	Length Feet (meters)	Catalog Number
Black	5.0' (1.52)	FT4BK5
Black	25.0' (7.62)	FT4BK25
Gray	25.0' (7.62)	FT4GY25
Yellow	5.0' (1.52)	FT4Y5
Yellow	25.0' (7.62)	FT4Y25



FloorTrak® 3*

Color	Length Feet (meters)	Catalog Number
Black	5.0' (1.52)	FT3BK5
Black	25.0' (7.62)	FT3BK25
Brown	5.0' (1.52)	FT3BR5
Brown	25.0' (7.62)	FT3BR25
Beige	5.0' (1.52)	FT3BG5
Beige	25.0' (7.62)	FT3BG25
Gray	5.0' (1.52)	FT3GY5
Gray	25.0' (7.62)	FT3GY25
Yellow	5.0' (1.52)	FT3Y5
Yellow	25.0' (7.62)	FT3Y25



FloorTrak® 10 (Heavy Duty)

Color	Length Feet (meters)	Catalog Number
Black	3.0' (.914)	FT10BK3
Black	5.0' (1.52)	FT10BK5
Yellow	3.0' (.914)	FT10Y3
Yellow	5.0' (1.52)	FT10Y5



Accessories

Description	Catalog Number
1" Wide, 75' Roll Double-Sided Adhesive Tape.	FTT1
2" Wide, 75' Roll Double-Sided Adhesive Tape.	FTT2



Note: *ADA Compliant Section 4.5.2.

Dimensions

FloorTrak®	FT2 in. (mm)	FT3 in. (mm)	FT4 in. (mm)	FT10 (Heavy Duty) in. (mm)
Width (A)	2.75" (69.9)	3.00" (76.2)	3.25" (82.6)	5.6" (142.24)
Height (B)	.53" (13.5)	.75" (19.1)	1.10" (27.9)	1.7" (43.18)
Center Hole (Cx Dx)	.60" x .31" (15.2) x (7.9)	.75" x .50" (19.1) x (12.7)	1.21" x .75" (30.7) x (19.1)	1.81" x 1.25" (45.98 x 31.75)

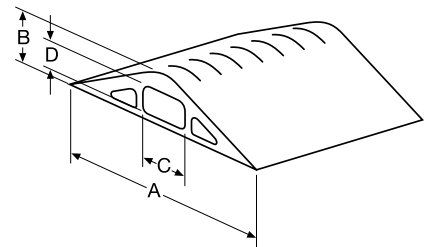

Specifications

Material	Rigid PVC.
Operating Temperature	0°F to +120°F (-18°C to +49°C).

Dimensions in Inches (mm)

SECTION W

Table of Contents



Pulling Grips



Support Grips

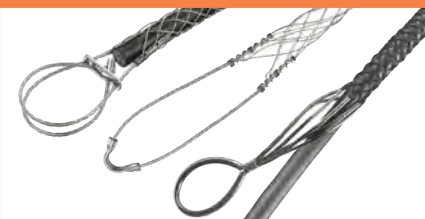

Cord Connectors



Product	Page	Product	Page
Products at a Glance	W-2	Strain Relief System Selection Chart	W-47
Quick Reference Selection Guide for Grip Applications	W-3	Deluxe Cord Grips	W-49
Kellems® Wire Mesh Grips Diagram	W-4	PG and Metric Threaded Deluxe Cord Grips	W-53
Pulling Grips		Dust-Tight Strain Relief Grips	W-54
Overhead DUA-PULL® and Multiple Strength	W-7	I-Grips	W-55
Underground K-Type and T-Type	W-8	Thread Adapters for Multi-Pin Connectors	W-56
Special Purpose	W-9	Strain Relief Grips for Liquidtight Conduit	W-57
Low Tension	W-13	Cord Connectors	
Wire Rope Splicing	W-14	Male Connectors	X-69
Cable Splicing	W-15	Female and Underground Feeder Connectors	X-72
Tools, Bands, and Swivels	W-16	Low Profile NPT, PG and Metric Thread Connectors	X-73
Support Grips		Accessories	X-74
Standard Duty	W-20	Hubbell Juniors® Miniature Cord Connectors	X-75
Special Purpose	W-24	PolyTuff® I and PolyTuff® II Non-Metallic Liquidtight	
Heavy Duty	W-24	Conduit Tubing	W-88
Service Drop	W-26	Non-Metallic Liquidtight Fittings	W-89
Bus Drop	W-28	Metallic Liquidtight Conduit Fittings	W-90
Conduit Riser	W-29		
Fiber Optic Cable Grips	W-38		
Hose Containment Grips	W-45		

Products at a Glance



Pulling Grips

- The galvanized steel mesh grip provides strength for secure pulling jobs
- Endless weave allows easy installation onto cable
- Flexible or rotating eyes will mate easily with line stringing swivels for attachment to pulling lines; they have great strength for trouble free pulling jobs
- Shoulder protectors contain the cable inside the grip



Support Grips

- Solid eye assemblies provide eye reinforcement at support hardware
- Four eye styles available: single, double, universal and offset
- Identification tag shows: catalog number, diameter range, agency approval and bar code
- Available in tin coated bronze, stainless steel and non-metallic aramid fiber



Fiber Optic Cable Grips

- Pulling Grips are used for outside plant cable; they are easy to install and remove, reusable and have a slim profile for small build up
- OPTISOK® Grip is a revolutionary tool to pull pre-terminated fiber optic cables. They will protect the connectors and guide the bundle through the pulling environment
- Will support the cable's weight as it hangs in vertical, sloping or horizontal position



Strain Relief Grips

- Stainless steel mesh is corrosion resistant. Can be used inside or outside
- Multiweave grip gives cable arc-of-bend control minimizing cable damage and extending cable life
- A liquidtight fitting is available with both cable and conduit fittings; prevents liquids from running through the fitting into the enclosure



Cord Connectors

- Machined threads provide a strong positive seal; the tapered interior dome easily drives the bushing into the connector bod
- Patented GOTCHA® ring incorporates a split hinge design to prevent friction and provide strain relief
- Lubricated neoprene bushing compresses easily for a liquidtight seal and added pull-out protection



PolyTuff® Non-Metallic Liquidtight Conduit and Fittings

- Nylon compression nut has a tapered dome to tighten ferrule onto conduit
- Tapered, machined threads fasten securely and provide additional liquidtight sealing
- Non-integral, reusable steel, ferrule is easily installed, to seal conduit
- PVC tubing handles twists, turns, bends, switchbacks and straightaways with ease
- UL listed/recognized and CSA certified

Kellems® Wire Management Products

Quick Reference Selection Guide for Grip Applications

Pulling Grips

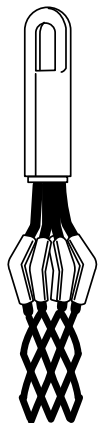

Heavy-Duty Rotating Eye

For underground wiring and overhead heavy-duty pulling of service lines and new construction cable. See pages W-8 and W-9.

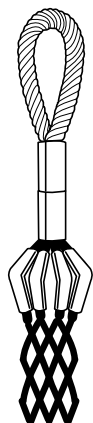

Heavy-Duty Flexible Eye

For overhead transmission and distribution line stringing. See pages W-7, W-8, and W-10.



Slack Grips

For removing underground cable and pulling slack in existing cable and new installations and when end of cable is not available. See pages W-11 and W-12.



Light-Duty Flexible Eye

For light industrial pulling of electrical cable and for underground and industrial plant wiring and re-wiring. See page W-13.

Support Grips

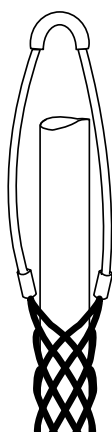

Single Eye

For single hook attachment of permanent indoor/outdoor cable. Available on heavy-duty, standard duty, and service drop grips. See pages W-20, W-24, and W-26.

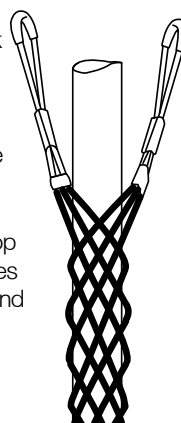

Double Eye

For double hook attachment of permanent indoor/outdoor cable. Available on heavy-duty and standard duty grips. See pages W-21 and W-25.

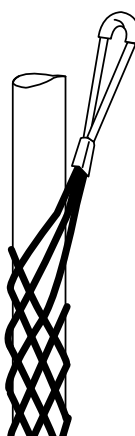

Single Offset Eye

For offset hook attachment of permanent indoor/outdoor cable. Available on standard duty and light-duty support grips. See page W-22.

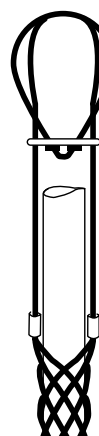

Universal Eye

Used to fasten around a structure or closed loop. Available on standard duty support and light or heavy duty service drop grips. See pages W-23 and W-27.

Support Grips

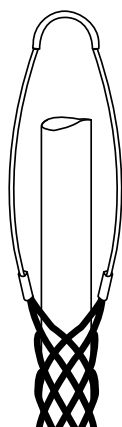

Wide Range Bus Drop

Used indoors for cable support where flexible cable connects electrical equipment to bus duct. Support air hose and water hose. See page W-28.



Dust-Tight Strain Relief

Indoor use only for wiring of electrical enclosures, machine tools, portable power tools, bus drop cable systems. See page W-55.

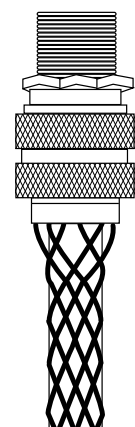

Deluxe Cord

Indoor or outdoor use where subject to moisture, splash, or washdown. Examples are enclosures, crane hoist and pendant drop stations, hand tools, pumps, and processing equipment. Available in straight, 90°, or 45° configurations. See pages W-50 to W-54.



Liquid-Tight, Flexible Metal Conduit

Wiring of machine tools, electrical enclosures, motors, and systems subjected to vibration, flexure, motion, or strain. Available in straight, 90°, or 45° configurations. See pages W-58 to W-60.

Other Specialty Grips

Splicing Grips

Used as temporary splice for cable and wire rope, or as reinforcement to protect cables and hoses. See pages W-14 and W-15.

Conduit Riser Grips

Ideal for supporting electrical wires inside rigid conduit via a supporting ring. See pages W-29 to W-31.

Hose Containment Grips

Used on flexible hose lines to prevent violent whipping of hose in the event of failure at the fitting. See pages W-46 and W-47.

Specifications are subject to change without notice.

Kellems® Wire Management Products

Kellems® Wire Mesh Grips Diagram

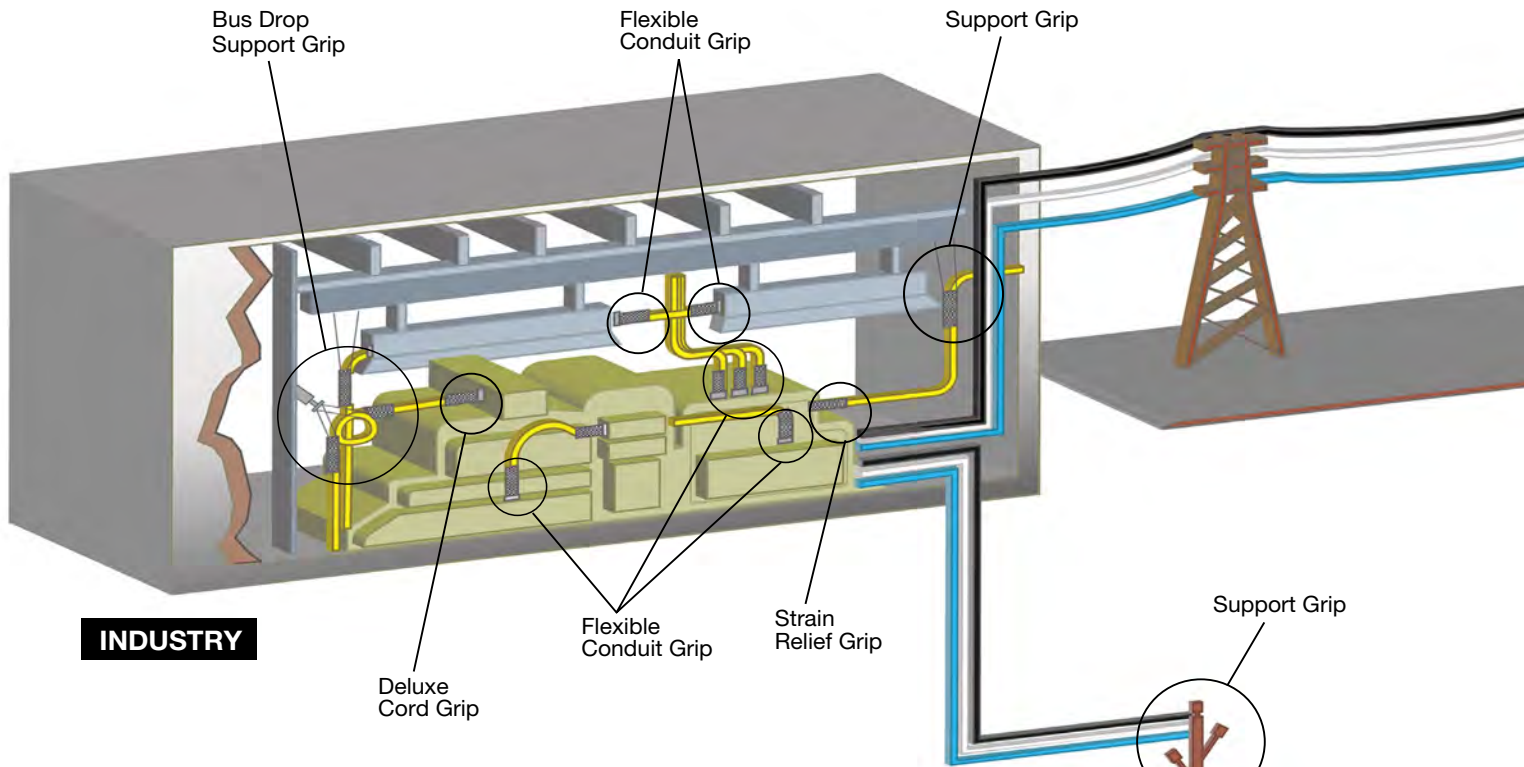

To help you fully visualize the variety of uses available to you through Hubbell-Kellems Mesh Grips, we have prepared this diagram of common applications. It follows the typical pattern of usage you would find traveling from utility to industrial, commercial and residential environments.

Pulling Grips are instrumental in the installations of transmission lines, service lines and cabling for construction and maintenance.

Support Grips provide holding management for indoor and outdoor permanent cable installations.

Strain Relief Grips are most often used to provide maximum reliability and minimum maintenance in areas where cords on machinery or equipment is impacted by motion or vibration or at risk of damage from cable pullout.

Beyond the electrical applications illustrated here, Hubbell-Kellems Mesh Grips can be used for wire management on radio and microwave communications towers, crane and hoist wire rope maintenance, elevator cable management and more.

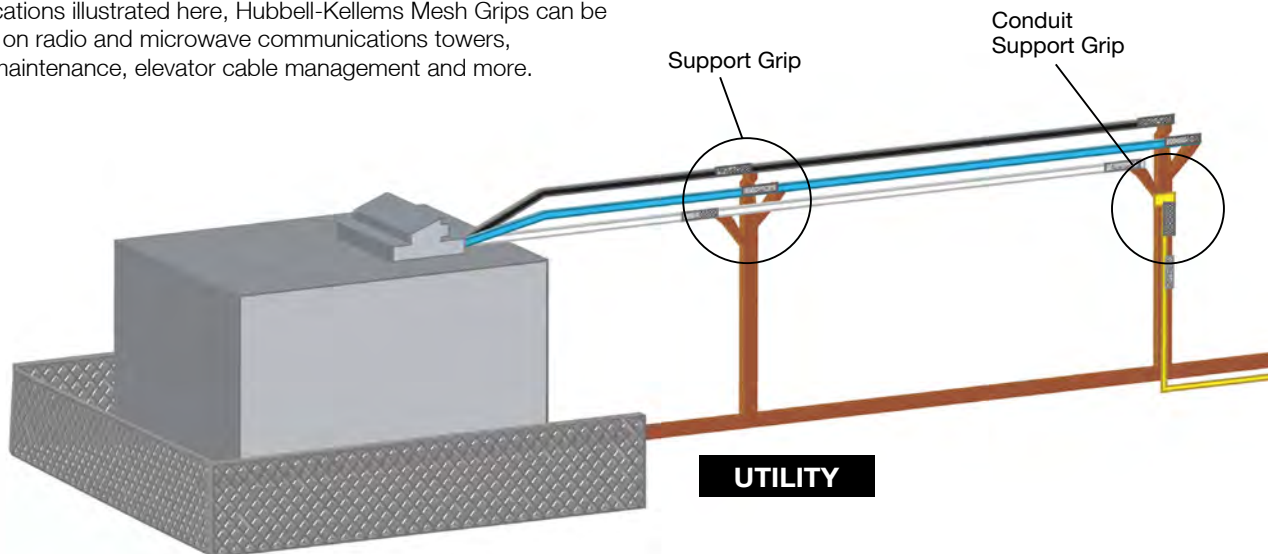

Kellems® Wire Management Products

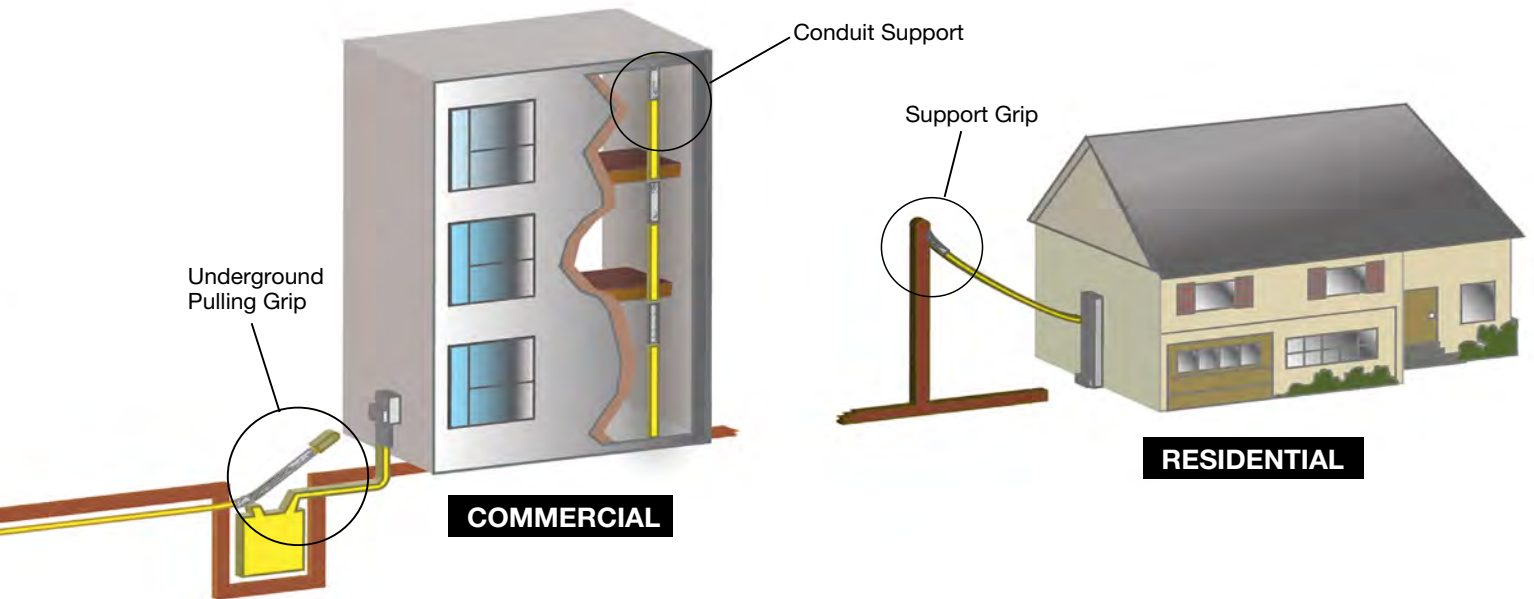
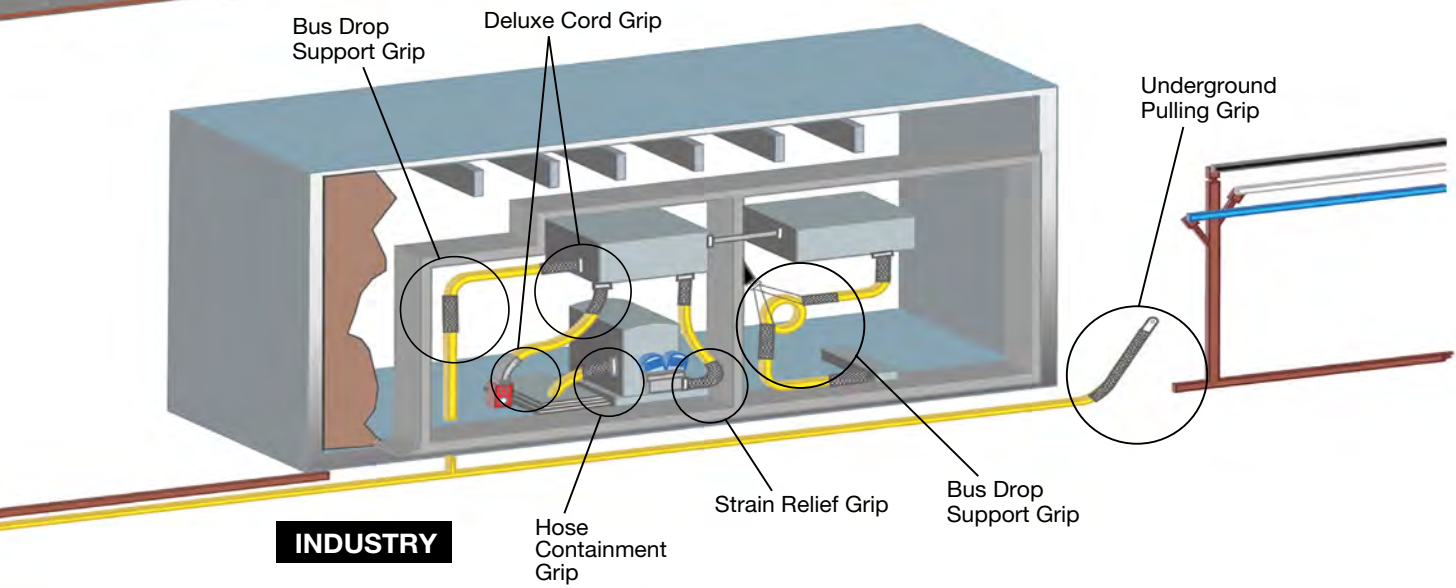
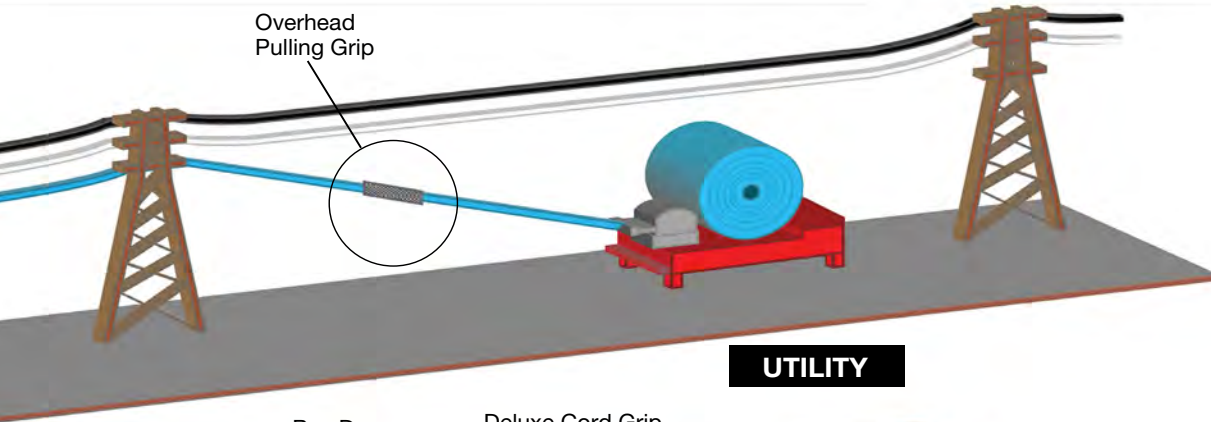

Kellems® Wire Management Products

Features and Benefits

Kellems® Pulling Grips

Pulling grips are reusable tools for pulling electrical cable, bare conductor or rope. They are easy and fast to install, providing the user with a smooth, slim profile that allows for easy passage through ducts and conduit.

These grips are made of the highest quality galvanized steel strand which assures the user of a long lasting grip. There is a Kellems Pulling Grip for every pulling job.

- Made of high strength galvanized steel strand
- Mesh design offers the greatest holding power for all pulling applications
- Each grip size is color coded for fast and accurate identification and selection
- Will mate with swivels



Mesh Grip

- The galvanized steel mesh grip provides strength for secure pulling jobs and a slim profile with little build-up; it has flexibility to follow cable path
- The multiweave styles available add strength for big pulling jobs and provide positive gripping power



Eye Styles

- Heavy-duty rotating eye for underground wiring and overhead heavy-duty pulling of service lines and new construction cable
- Flexible or rotating eyes will mate easily with line stringing swivels for attachment to pulling lines; they have great strength for trouble free pulling jobs

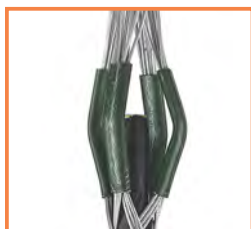

Cable Protection

- Shoulder protectors contain the cable inside the grip and smooth the passage of the grip over line stringing blocks or conduit bends; they protect the leading edge of the grip from abrasion



Accessories

- Swivels are essential to the efficiency and safety of any high tension application
- Punch-Lok® Bands are applied over the tail of a grip to prevent the mesh from being tripped or pulled loose
- Banding tools

DUA-PULL® Grips, Flexible Eye, Double Weave Mesh

DUA-PULL Pulling Grips are the highest strength pulling grips manufactured for overhead transmission line stringing applications. They have a dual function of working with both bare and insulated conductors and synthetic rope, not provided by any other grip. Kellems' patented two-over, two-under weave design gives exceptional strength and gripping ability by putting more steel mesh in contact with the cable or rope surfaces. **THIS IS THE ONLY PULLING GRIP RECOMMENDED FOR USE ON SYNTHETIC ROPE.**

IMPORTANT:
Read all breaking strength, safety and technical data relating to this product.

Refer to pages W-17 and W-18.

Benefits

- Made of high strength galvanized steel strand
- Recommended for pulling bare or insulated conductor, wire rope and synthetic rope
- DUA-PULL mesh design offers the greatest holding power for all pulling applications
- Each grip size is color coded for fast and accurate identification and selection
- Will mate with swivels, see page W-16

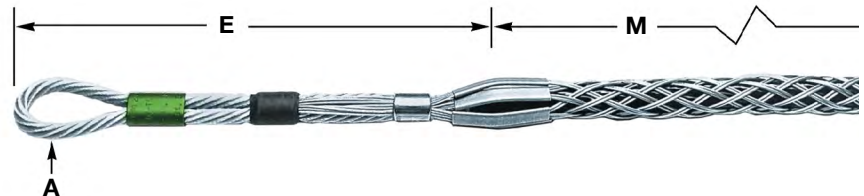

DUA-PULL® Grips

Diameter Range		Approx. Breaking Strength Lbs.	Working Load Lbs.	E Inches (cm)	M Inches (cm)	A Eye Dia. Inches (cm)	Over Cable and Grip** Inches (cm)	Color Code	Catalog Number
Conductor Inches (cm)	Rope* Inches (cm)								
.19"-.37" (.48-.94)	.25"-.65" (.63-1.65)	6,500	1,300	10" (25.40)	24" (60.96)	.220" (.56)	.200" (.51)	Black	033271037
.38"-.62" (.97-1.57)	.50"-.90" (1.27-2.29)	14,000	2,800	12" (30.48)	36" (91.44)	.375" (.95)	.280" (.71)	Dk Green	033271038
.63"-.87" (1.60-2.21)	.75"-1.10" (1.90-2.79)	20,000	4,000	13" (33.02)	48" (121.92)	.437" (1.11)	.360" (.91)	Red	033271039
.88"-1.12" (2.24-2.84)	1.00"-1.50" (2.54-3.81)	30,600	6,120	15" (38.10)	60" (152.40)	.500" (1.27)	.500" (1.27)	Dk Blue	033271040
1.13"-1.37" (2.87-3.48)	1.25"-1.70" (3.17-4.32)	46,800	9,360	18" (45.72)	76" (193.04)	.625" (1.59)	.625" (1.59)	Yellow	033271041
1.38"-1.90" (3.51-4.38)	1.50"-2.10" (3.81-5.33)	66,500	13,300	24" (60.96)	89" (226.06)	.750" (1.90)	.750" (1.90)	Aluminum	033271042

Note: E = Eye length. M = Mesh length at nominal diameter.

*For rope, select smallest size grip which meets required work load.

**Add to cable or rope diameter.

Feed Tubes

The Kellems Feed Tube is used when assembling synthetic rope into the DUA-PULL Grip. It is required on the largest two sizes of DUA-PULL Grips. Feed Tubes are available for use on all size DUA-PULL Grips.

Benefits

- Saves time, allowing fast, easy assembly
- Can be reused if not damaged



DUA-PULL® Feed Tubes

For Use with DUA-PULL Grips	Rope Diameter Inches (cm)	Feed Tube Length Inches (cm)	Catalog Number
033271037	.25"-.65" (.63-1.65)	28" (71.12)	091061043
033271038	.50"-.90" (1.27-2.29)	40" (101.60)	091061044
033271039	.75"-1.10" (1.90-2.79)	52" (132.08)	091061045
033271040	1.00"-1.50" (2.54-3.81)	67" (170.18)	091061046
033271041	1.25"-1.70" (3.17-4.32)	83" (210.82)	091061047
033271042	1.50"-2.10" (3.81-5.33)	96" (243.84)	091061048

Note: 1. Do not run grips or swivels over bullwheels while under tension.

2. Two bands should be firmly attached approximately 1" and 2" (2.54cm and 5.08cm) from the grip's tail.

Banding is required to ensure maximum reliability and guard against accidental release, see page W-16.

3. Double braided rope, such as 2-in-1 type, should be back spliced for approximately 2/3 of the mesh length for best gripping results.

Grip size should be selected by diameter of back splice.



Dimensions in Inches (mm)

Multiple Strength Style Grips

Multiple Strength Pulling Grips are designed for pulling aluminum or copper bare conductor, ground wires, messenger strands, wire rope and insulated cables. They are made of high strength galvanized steel strand and feature a multi-weave mesh construction of single, double and triple weave for firm holding power.

IMPORTANT:

Read all breaking strength, safety and technical data relating to this product.

Refer to pages W-17 and W-18.

Rotating Eye Feature

Multiple Strength Grips are available with a forged steel rotating eye which can be attached to a swivel. The forged eye is durable, compact and streamlined and will thread through blocks and sheaves without binding. **The rotating eye is not a swivel and will not turn while under tension;** it can turn to relieve pulling torque when tension is relaxed. If constant swivel action is required, a swivel should be used. For swivel dimensions, see page W-16. For rotating eye dimensions, see page W-9.

Benefits

- Economical, high strength pulling tool
- Multi-weave construction provides greater strength and holding power
- Endless Weave Grip end lies flat on the cable and will not snag



Multiple Strength Grip, Rotating Eye

Cable Diameter Range Inches (cm)	Approx. Breaking Strength Lbs.	Working Load Lbs.	E Inches (cm)	M Inches (cm)	Rotating Eye Dia. Inches (cm)	Color Code	Catalog Number
.25"--.49" (.63-1.24)	6,800	1,360	5" (12.70)	26" (66.04)	7/8" (2.22)	Dark Green	03302016
.50"-.74" (1.27-1.88)	10,000	2,000	6" (15.24)	32" (81.28)	1" (2.54)	Brown	03302018
.75"-.99" (1.90-2.51)	14,400	2,880	6" (15.24)	41" (104.14)	1" (2.54)	Light Blue	03302020
1.00"-1.24" (2.54-3.15)	24,600	4,920	8" (20.32)	52" (132.08)	1 3/8" (3.49)	Gold	03302022
1.25"-1.49" (3.17-3.78)	30,600	6,120	8" (20.32)	56" (142.24)	1 5/8" (4.13)	Black	03302024
1.50"-1.74" (3.81-4.42)	30,600	6,120	9" (22.86)	60" (152.40)	1 7/8" (4.76)	Red	03302026
1.75"-2.24" (4.44-5.69)	48,000	9,600	10" (25.40)	70" (177.80)	1 7/8" (4.76)	Dark Blue	03302028
2.00"-2.49" (5.08-6.32)	48,000	9,600	10" (25.40)	50" (127.00)	1 7/8" (4.76)	Yellow	03302066
2.50"-2.99" (6.35-7.59)	48,000	9,600	10" (25.40)	52" (132.08)	1 7/8" (4.76)	Orange	03302097
3.00"-3.49" (7.62-8.86)	48,000	9,600	10" (25.40)	50" (127.00)	1 7/8" (4.76)	Aluminum	033021030
3.50"-3.99" (8.89-10.13)	48,000	9,600	10" (25.40)	53" (134.62)	1 7/8" (4.76)	Light Green	033021031

Note: E- Eye length M-Mesh length at nominal diameter.

Flexible Eye Feature

Multiple Strength Grips are also available with a flexible, patented wire rope eye. This compact eye will mate with a swivel, and pass through blocks and sheaves without binding.

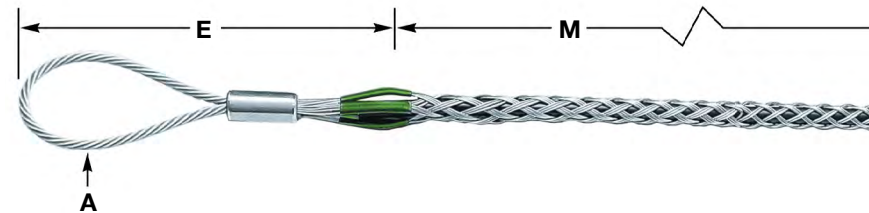

Multiple Strength Grip, Flexible Eye

Cable Diameter Range Inches (cm)	Approx. Breaking Strength Lbs.	Working Load Lbs.	E Inches (cm)	M Inches (cm)	A Eye Dia. Inches (cm)	Color Code	Catalog Number
.25"-.49" (.63-1.24)	6,800	1,360	9" (22.86)	26" (66.04)	1/4" (.63)	Dark Green	03302044
.50"-.74" (1.27-1.88)	10,000	2,000	9" (22.86)	32" (81.28)	5/16" (.79)	Brown	03302046
.75"-.99" (1.90-2.51)	14,400	2,880	11" (27.94)	41" (104.14)	3/8" (.95)	Light Blue	03302048
1.00"-1.24" (2.54-3.15)	24,600	4,920	12" (30.48)	52" (132.08)	1/2" (1.27)	Gold	03302050
1.25"-1.49" (3.17-3.78)	30,600	6,120	12" (30.48)	56" (142.24)	1/2" (1.27)	Black	03302052
1.50"-1.74" (3.81-4.42)	30,600	6,120	12" (30.48)	60" (152.40)	1/2" (1.27)	Red	03302054
1.75"-2.24" (4.44-5.69)	48,000	9,600	18" (45.72)	70" (177.80)	5/8" (1.59)	Dark Blue	03302056
2.00"-2.49" (5.08-6.32)	48,000	9,600	18" (45.72)	50" (127.00)	5/8" (1.59)	Yellow	033021078
2.50"-2.99" (6.35-7.59)	48,000	9,600	18" (45.72)	52" (132.08)	5/8" (1.59)	Orange	033021079
3.00"-3.49" (7.62-8.86)	48,000	9,600	18" (45.72)	50" (127.00)	5/8" (1.59)	Aluminum	033021080
3.50"-3.99" (8.89-10.13)	48,000	9,600	18" (45.72)	53" (134.62)	5/8" (1.59)	Light Green	033021081

Note: E- Eye length. M-Mesh length at nominal diameter.

1. Do not run grips or swivels over bullwheels while under tension.
2. Two bands should be firmly attached approximately 1" and 2" (2.54cm and 5.08cm) from the grip's tail. Banding is required to ensure maximum reliability and guard against accidental release, see page W-16.

Dimensions in Inches (mm)

K-Type Grips

Kellems® Rotating Eye, K-Type Pulling Grips are made of high strength galvanized steel strand. All Grips feature double weave mesh for greater strength and added mesh contact on the table, to handle longer or heavier pulling jobs. The forged eye mates easily with a swivel or shackle.

IMPORTANT:
Read all breaking strength, safety and technical data relating to this product.

Refer to pages W-17 and W-18.

Rotating Eye Feature

K-Type Grips come equipped with a forged steel rotating eye which can be attached to a swivel. The forged eye is durable, compact and streamlined, and will thread through blocks and sheaves without binding. **The rotating eye is not a swivel and will not turn while under tension;** it can turn to relieve pulling torque when the tension is relaxed. If constant swivel action is required, a swivel should be used. For swivel dimensions, see page W-16. For rotating eye dimensions, see below.

Benefits

- An economical tool for pulling cable
- Safe, rugged and dependable
- Equipped with a rotating eye for spin out of pulling torque after load release
- Easily installed and removed



K-Type Grips

Cable Diameter Range Inches (cm)	Approx. Breaking Strength Lbs.	Working Load Lbs.	E Inches (cm)	M Inches (cm)	Rotating Eye Dia. Inches (cm)	Catalog Number
Short						
.50"-.62" (1.27-1.57)	5,600	1,120	5" (12.70)	11" (27.94)	7/8" (2.22)	03301001
.63"-.74" (1.60-1.88)	6,800	1,360	5" (12.70)	11" (27.94)	7/8" (2.22)	03301002
.75"-.99" (1.90-2.51)	6,800	1,360	6" (15.24)	20" (50.80)	1" (2.54)	03301013
1.00"-1.24" (2.54-3.15)	12,800	2,560	7" (17.78)	20" (50.80)	1 3/8" (3.49)	03301014
1.25"-1.49" (3.17-3.78)	12,800	2,560	7" (17.78)	21" (53.34)	1 3/8" (3.49)	03301016
1.50"-1.99" (3.81-5.05)	16,400	3,280	7" (17.78)	25" (63.50)	1 3/8" (3.49)	03301017
2.00"-2.49" (5.08-6.32)	27,200	5,440	8" (20.32)	26" (66.04)	1 3/8" (4.13)	03301018
2.50"-2.99" (6.35-7.59)	33,000	6,600	10" (25.40)	28" (71.12)	1 7/8" (4.76)	03301019
3.00"-3.49" (7.62-8.86)	41,000	8,200	10" (25.40)	30" (76.20)	1 7/8" (4.76)	03301020
3.50"-3.99" (8.89-10.13)	48,000	9,600	10" (25.40)	32" (81.28)	1 7/8" (4.76)	03301021
4.00"-4.49" (10.16-11.40)	48,000	9,600	10" (25.40)	33" (83.82)	1 7/8" (4.76)	033011017
Standard						
.50"-.62" (1.27-1.57)	5,600	1,120	5" (12.70)	16" (40.64)	7/8" (2.22)	03301011
.63"-.74" (1.60-1.88)	6,800	1,360	5" (12.70)	16" (40.64)	7/8" (2.22)	03301012
.75"-.99" (1.90-2.51)	9,600	1,920	6" (15.24)	32" (81.28)	1" (2.54)	03301024
1.00"-1.49" (2.54-3.78)	16,400	3,280	7" (17.78)	33" (83.82)	1 3/8" (3.49)	03301025
1.50"-1.99" (3.81-5.05)	16,400	3,280	7" (17.78)	34" (86.36)	1 3/8" (3.49)	03301026
2.00"-2.49" (5.08-6.32)	27,200	5,440	9" (22.86)	36" (91.44)	1 5/8" (4.13)	03301027
2.50"-2.99" (6.35-7.59)	33,000	6,600	10" (25.40)	38" (96.52)	1 7/8" (4.76)	03301028
3.00"-3.49" (7.62-8.86)	41,000	8,200	10" (25.40)	39" (99.06)	1 7/8" (4.76)	03301029
3.50"-3.99" (8.89-10.13)	48,000	9,600	10" (25.40)	41" (104.14)	1 7/8" (4.76)	03301030
4.00"-4.49" (10.16-11.40)	48,000	9,600	10" (25.40)	42" (106.68)	1 7/8" (4.76)	03301031
4.50"-4.99" (11.43-12.67)	48,000	9,600	10" (25.40)	58" (147.32)	1 7/8" (4.76)	03301039
5.00"-5.99" (12.70-15.21)	40,000	8,000	10" (25.40)	60" (152.40)	1 7/8" (4.76)	03301047
6.00"-6.99" (15.24-17.75)	48,000	9,600	10" (25.40)	66" (167.64)	1 7/8" (4.76)	03301045

Note: E- Eye length. M-Mesh length at nominal diameter.
See page W-18 for multiple cables in a single pulling grip.

Rotating Eye Dimensions

Rotating Eye Dimensions Inches (cm)	A	B	C	D	F
7/8" (2.22)	7/8" (2.22)	9/32" (.71)	1/2" (1.27)	7/8" (2.22)	2 5/8" (6.67)
1" (2.54)	1" (2.54)	1/2" (1.27)	9/16" (1.43)	1 3/16" (2.06)	3 1/2" (8.89)
1 3/8" (3.49)	1 3/8" (3.49)	1/2" (1.27)	1 1/16" (1.75)	1" (2.54)	4 1/2" (11.43)
1 5/8" (4.13)	1 5/8" (4.13)	5/8" (1.59)	7/8" (2.22)	1 3/16" (3.02)	5 5/16" (13.49)
1 7/8" (4.76)	1 7/8" (4.76)	2 1/32" (1.67)	1" (2.54)	1 3/8" (3.49)	6 1/8" (15.56)

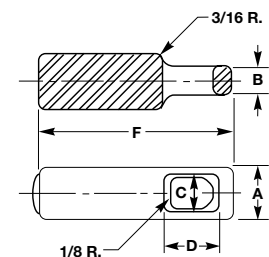

Dimensions in Inches (mm)

T-Type Grips

Kellems® Flexible T-Type Pulling Grips are made of high strength galvanized steel strand. They feature double weave mesh for positive holding power in medium to heavy pulling jobs. The grip eye will easily attach to a swivel.

IMPORTANT:

Read all breaking strength, safety and technical data relating to this product.

Refer to pages W-17 and W-18.

Application

T-Type Pulling Grips are used for the installation of underground power cables, communication lines and service lines into factories, construction projects and for general underground electrical construction. Available in two mesh lengths, short for medium pulls and standard for general purpose pulling.

Benefits

- Will pull a single cable or cable bundles
- Patented flexible eye design provides flexibility to follow line of pull
- A dependable, reusable pulling tool
- Easily installed and removed
- Mates easily with a swivel, see page W-16

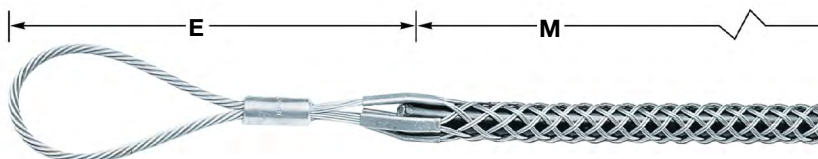

T-Type Grips

Cable Diameter Range Inches (cm)	Approx. Breaking Strength Lbs.	Working Load Lbs.	E Inches (cm)	M Inches (cm)	Catalog Number
Short					
.50"-.62" (1.27-1.57)	4,500	900	8" (20.32)	21" (53.34)	033041082
.63"-.74" (1.60-1.88)	5,600	1,120	8" (20.32)	24" (60.96)	033041083
.75"-.99" (1.90-2.51)	6,800	1,360	9" (22.86)	24" (60.96)	033041084
1.00"-1.49" (2.54-3.78)	9,600	1,920	9" (22.86)	24" (60.96)	033041085
1.50"-1.99" (3.81-5.05)	16,400	3,280	11" (27.94)	24" (60.96)	033041086
2.00"-2.49" (5.08-6.32)	18,500	3,700	12" (30.48)	24" (60.96)	033041087
2.50"-2.99" (6.35-7.59)	24,500	4,900	12" (30.48)	24" (60.96)	033041088
3.00"-3.49" (7.62-8.86)	24,500	4,900	14" (35.56)	24" (60.96)	033041089
3.50"-3.99" (8.89-10.13)	31,000	6,200	14" (35.56)	26" (66.04)	033041090
Standard					
.75"-.99" (1.90-2.51)	6,800	1,360	9" (22.86)	36" (91.44)	033041091
1.00"-1.49" (2.54-3.78)	9,600	1,920	9" (22.86)	36" (91.44)	033041092
1.50"-1.99" (3.81-5.05)	16,400	3,280	11" (27.94)	36" (91.44)	033041093
2.00"-2.49" (5.08-6.32)	18,500	3,700	12" (30.48)	36" (91.44)	033041094
2.50"-2.99" (6.35-7.59)	24,500	4,900	12" (30.48)	36" (91.44)	033041095
3.00"-3.49" (7.62-8.86)	24,500	4,900	14" (35.56)	36" (91.44)	033041096
3.50"-3.99" (8.89-10.13)	31,000	6,200	14" (35.56)	40" (101.60)	033041097

Note: E- Eye length. M-Mesh length at nominal diameter.
See page W-18 for multiple cables in a single pulling grip.

Non-Conductive Grips

Kellems® Non-Conductive Pulling Grips, made of a high strength, non-conductive aramid fiber, are available for pulling single cable or cable bundles. Their braided double weave design adds strength and positive holding power.

IMPORTANT:
Read all breaking strength, safety and technical data relating to this product.

Refer to pages W-17 and W-18.

Benefits

- Color coded for fast on-site selection
- Extra flexibility for easy installation
- Non-metallic mesh provides for safe pulls over "hot" areas
- Pellethane jacketed aramid fiber mesh resists abrasion
- Grips are corrosion resistant

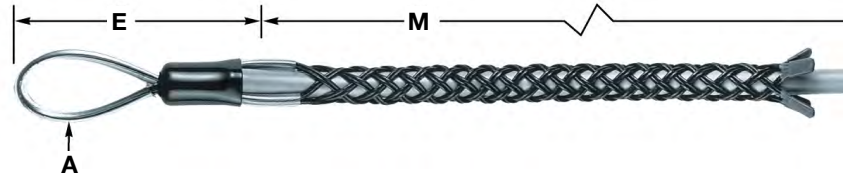

Non-Conductive Grips, Single Eye, Double Weave, Non-Metallic

Cable Diameter Range Inches (cm)	Approx. Breaking Strength Lbs.	Working Load Lbs.	E Inches (cm)	M Inches (cm)	A Inches (cm)	Color Code	Catalog Number
.50"-.62" (1.27-1.57)	1,000	200	5.5" (13.97)	24" (60.96)	.44" (1.12)	Green	03628001
.63"-.74" (1.60-1.88)	2,000	400	5.5" (13.97)	26" (66.04)	.44" (1.12)	Yellow	03628002
.75"-.99" (1.90-2.51)	2,000	400	6.0" (15.24)	31" (78.74)	.63" (1.60)	Red	03628003
1.00"-1.24" (2.54-3.15)	3,000	600	6.5" (16.51)	36" (91.44)	.63" (1.60)	Blue	03628004
1.25"-1.49" (3.17-3.78)	3,000	600	6.7" (17.02)	41.5" (105.41)	.63" (1.60)	White	03628005
1.50"-1.99" (3.81-5.05)	3,000	600	8.0" (20.32)	44.0" (121.76)	.63" (1.60)	Pink	03628006

Note: E- Eye length. M-Mesh length at nominal diameter.

Taping is required to guard against accidental release and to insure maximum reliability. Apply vinyl plastic electrical tape starting 2" to 3" (5.08cm to 7.62cm) from the tail of the grip onto 2" to 3" (5.08cm to 7.62cm) of cable.

Dimensions in Inches (mm)

Slack Pulling Grips

Slack Pulling Grips are offered in two styles made of galvanized steel. The closed type is used when the cable end is accessible. When not accessible, there are split rod closing styles. All grips feature a single offset eye for easy attachment to a pulling line.

IMPORTANT:

Read all breaking strength, safety and technical data relating to this product.

Refer to pages W-17 and W-18.

Benefits

- Easy attachment to pulling lines
- Galvanized steel for strength

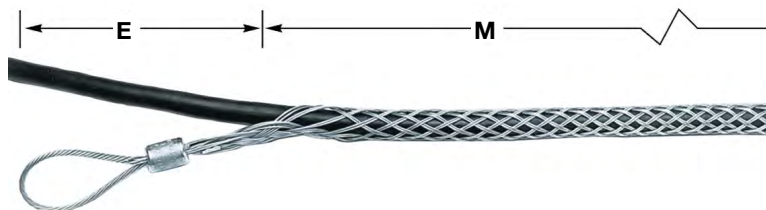

Slack Grip-Closed Mesh, Offset Eye, Double Weave, Galvanized Steel

Cable Diameter Range Inches (cm)	Approx. Breaking Strength Lbs.	Working Load Lbs.	E Inches (cm)	M Inches (cm)	Catalog Number
Standard					
.75"- .99" (1.90-2.51)	2,600	520	7" (17.78)	12" (30.48)	03308003
1.00"-1.24" (2.54-3.15)	4,000	800	8" (20.32)	15" (38.10)	03308004
1.25"-1.49" (3.17-3.78)	5,400	1,080	8" (20.32)	16" (40.64)	03308005
1.50"-1.74" (3.81-4.42)	6,600	1,320	8" (20.32)	20" (50.80)	03308006
1.75"-1.99" (4.44-5.05)	10,000	2,000	10" (25.40)	18" (45.72)	03308007
2.00"-2.49" (5.08-6.32)	11,000	2,200	10" (25.40)	19" (48.26)	03308008
2.50"-2.99" (6.35-7.59)	11,000	2,200	10" (25.40)	20" (50.80)	03308009
3.00"-3.49" (7.62-8.86)	14,500	2,900	12" (30.48)	21" (53.34)	03308010
3.50"-3.99" (8.89-10.13)	14,500	2,900	12" (30.48)	22" (55.88)	03308011

Note: E- Eye length. M-Mesh length at nominal diameter.

See page W-18 for multiple cables in a single pulling grip.

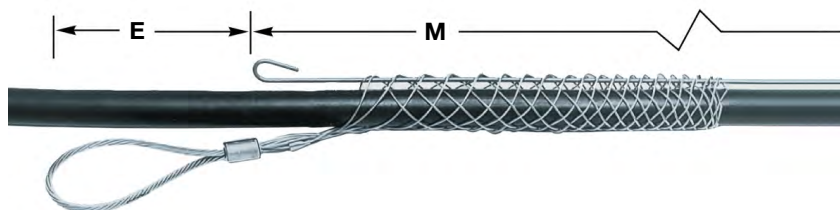

Slack Grip-Split Mesh, Rod Closing, Offset Eye, Single Weave, Galvanized Steel

Cable Diameter Range Inches (cm)	Approx. Breaking Strength Lbs.	Working Load Lbs.	E Inches (cm)	M Inches (cm)	Catalog Number
.50"- .61" (1.27-1.55)	1,500	300	7" (17.78)	6" (15.24)	03310001
.62"- .74" (1.57-1.88)	1,800	360	7" (17.78)	8" (20.32)	03310002
.75"- .99" (1.90-2.51)	2,200	440	7" (17.78)	10" (25.40)	03310003
1.00"-1.24" (2.54-3.15)	3,400	680	8" (20.32)	12" (30.48)	03310004
1.25"-1.49" (3.17-3.78)	4,500	900	8" (20.32)	14" (35.56)	03310005
1.50"-1.74" (3.81-4.42)	5,800	1,160	9" (22.86)	15" (38.10)	03310006
1.75"-1.99" (4.44-5.05)	7,600	1,520	10" (25.40)	16" (40.64)	03310007
2.00"-2.49" (5.08-6.32)	9,000	1,800	10" (25.40)	19" (48.26)	03310008
2.50"-2.99" (6.35-7.59)	11,000	2,200	10" (25.40)	20" (50.80)	03310009
3.00"-3.49" (7.62-8.86)	12,000	2,400	12" (30.48)	21" (53.34)	03310010
3.50"-3.99" (8.89-10.13)	12,000	2,400	12" (30.48)	24" (60.96)	03310011

Note: E- Eye length. M-Mesh length at nominal diameter.

See page W-35 for closing instructions.

See page W-18 for multiple cables in a single pulling grip.

Dimensions in Inches (mm)

Light Duty Grips

Light Duty Grips are made of galvanized steel in a single weave construction. They feature a flexible eye for easy attachment to a pulling line.

IMPORTANT:
Read all breaking strength, safety and technical data relating to this product.

Refer to pages W-17 and W-18.

Benefits

- Perfect tools for light pulling jobs
- Installs easily on cable
- Strong galvanized steel construction

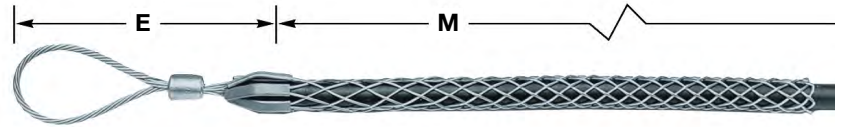

Light Duty Grips

Cable Diameter Range Inches (cm)	Approx. Breaking Strength Lbs.	Working Load Lbs.	E Inches (cm)	M Inches (cm)	Catalog Number
Short					
.50"--.62" (1.27-1.57)	2,800	560	5" (12.70)	11" (27.94)	03303001
.63"--.74" (1.60-1.88)	2,800	560	5" (12.70)	11" (27.94)	03303002
.75"--.99" (1.90-2.51)	4,000	800	6" (15.24)	12" (30.48)	03303003
1.00"-1.24" (2.54-3.15)	5,300	1,060	7" (17.78)	13" (33.02)	03303004
1.25"-1.49" (3.17-3.78)	5,300	1,060	7" (17.78)	14" (35.56)	03303005
1.50"-1.74" (3.81-4.42)	6,800	1,360	8" (20.32)	15" (38.10)	03303006
1.75"-1.99" (4.44-5.05)	8,500	1,700	9" (22.86)	17" (43.18)	03303007
2.00"-2.49" (5.08-6.32)	8,500	1,700	9" (22.86)	18" (45.72)	03303008
Standard					
.50"--.62" (1.27-1.57)	2,800	560	5" (12.70)	16" (40.64)	03303010
.63"--.74" (1.60-1.88)	2,800	560	5" (12.70)	16" (40.64)	03303011
.75"--.99" (1.90-2.51)	4,000	800	6" (15.24)	20" (50.80)	03303012
1.00"-1.24" (2.54-3.15)	6,800	1,360	7" (17.78)	20" (50.80)	03303013
1.25"-1.49" (3.17-3.78)	6,800	1,360	7" (17.78)	21" (53.34)	03303015
1.50"-1.99" (3.81-5.05)	6,800	1,360	8" (20.32)	23" (58.42)	03303016
2.00"-2.49" (5.08-6.32)	8,500	1,700	9" (22.86)	25" (63.50)	03303017
2.50"-2.99" (6.35-7.59)	10,600	2,120	9" (22.86)	27" (68.58)	03303018
3.00"-3.49" (7.62-8.86)	14,700	2,940	10" (25.40)	30" (76.20)	03303019
3.50"-3.99" (8.89-10.13)	14,700	2,940	10" (25.40)	32" (81.28)	03303029

Junior Pulling Grips

Junior Pulling Grips feature a strong galvanized steel, single weave mesh. A flexible eye easily attaches to a pulling line, snake or fish tape.

Benefits

- Installs easily over building wire
- Strong secure grip
- Reusable
- Pulls single cable or cable bundles

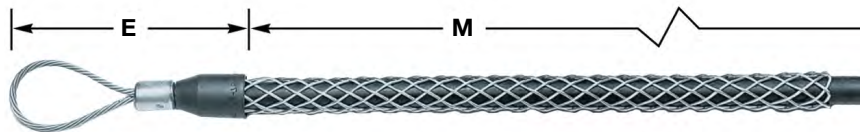

Junior Pulling Grips

Cable Diameter Range Inches (cm)	Approx. Breaking Strength Lbs.	Working Load Lbs.	E Inches (cm)	M Inches (cm)	Model	Catalog Number
.19"--.24" (.48-.61)	400	80	3¼" (8.25)	4¼" (10.79)	J19	03305011*
.25"--.37" (.63-.94)	450	90	3¼" (8.25)	4¼" (10.79)	J25	03305001
.38"--.49" (.97-1.24)	900	180	3¾" (9.52)	7" (17.78)	J37	03305002
.50"--.62" (1.27-1.57)	1,300	260	4¼" (10.79)	8½" (21.59)	J50	03305003
.63"--.74" (1.60-1.88)	1,950	390	5" (12.70)	10" (25.40)	J62	03305004
.75"--.99" (1.90-2.51)	2,800	560	5¾" (14.60)	10" (25.40)	J75	03305005
1.00"-1.24" (2.54-3.15)	3,900	780	6½" (16.51)	11½" (29.21)	J100	03305006
Junior Grip Kit contains 6 grips, one of each size above, except 03305011.						033051114

Note: E- Eye length. M-Mesh length at nominal diameter.

*Not included in Junior Grip Kit, 033051114.

See page W-18 for multiple cables in a single pulling grip.

Dimensions in Inches (mm)

Wire Rope Grips

Wire Rope Grips are made of high strength galvanized steel strand in a construction of triple, double and single weave for superior gripping ability. They are available with or without a rotating barrel which will help eliminate twist in the old rope from being transferred to the new rope.

IMPORTANT:

Read all breaking strength, safety and technical data relating to this product.

Refer to pages W-17 and W-18.

Benefits

- High strength for secure pulling
- Easy installation
- Flexible to pass through sheaves and blocks

Application

Wire Rope Grips are used for changing wire rope on oil derricks, large cranes, overhead cranes and drag lines. It provides a quick, safe, inexpensive temporary splice. By installing the used wire rope in one end and the new rope in the other, the new wire rope can be pulled in as the old one is pulled out.



Regular Wire Rope Grips

Cable Diameter Range Inches (cm)	Approx. Breaking Strength Lbs.	Working Load Lbs.	Approx. Strength of Grip Feet (m)	Catalog Number
.56"- .62" (1.43-1.59)	7,500	1,500	5.75 (1.75)	03316001
.75"- .88" (1.90-2.22)	12,500	2,500	6.75 (1.90)	03316002
1.00"-1.13" (2.54-2.86)	16,000	3,200	7.00 (2.13)	03316003
1.25"-1.38" (3.17-3.49)	20,000	4,000	8.00 (2.44)	03316004
1.38"-1.50" (3.49-3.81)	20,000	4,000	8.00 (2.44)	03316006



Rotating Wire Rope Grips

Cable Diameter Range Inches (cm)	Approx. Breaking Strength Lbs.	Working Load Lbs.	Approx. Strength of Grip Feet (m)	Barrel Dimensions Length. x O.D. In. (cm)	Catalog Number
.44"- .50" (1.11-1.27)	5,000	1,000	5.33 (1.63)	3.00" (7.62) x .87" (2.21)	03317001
.56"- .63" (1.43-1.59)	7,500	1,500	5.83 (1.78)	4.25" (10.79) x 1.00" (2.54)	03317002
.75"- .88" (1.90-2.22)	12,500	2,500	6.50 (1.98)	4.25" (10.79) x 1.00" (2.54)	03317003
1.00"-1.13" (2.54-2.86)	16,000	3,200	8.67 (2.64)	5.50" (13.97) x 1.37" (3.48)	03317004
1.25"-1.38" (3.17-3.49)	20,000	4,000	9.00 (2.74)	5.50" (13.97) x 1.37" (3.48)	03317005
1.50"-1.75" (3.81-4.44)	20,000	4,000	11.00 (3.35)	5.50" (13.97) x 1.37" (3.48)	03317006

Note: 1. During installation each end of the grip should be banded and taped down securely over the rope to insure smooth passage through sheaves and to guard against accidental release. See page W-16 for end bands.

2. The rotating barrel is not a swivel and will not turn while under tension. It can turn to relieve pulling torque when tension is relaxed.

Cable Splicing Grips

Splicing Grips are made of galvanized steel in double weave mesh construction. They are available in various lengths and sizes to suit most applications.

IMPORTANT:
Read all breaking strength, safety and technical data relating to this product.

Refer to pages W-17 and W-18.

Benefits

- Easily installed or removed
- Galvanized steel construction for strength
- Flexible to follow cable path

Application

Splicing Grips are used as a temporary splice for rope, cable or wire rope. They can also be used as cable reinforcement and can act as a shield to protect cables and hoses from abrasion.



Double Weave Splicing Grips

Cable Diameter Range Inches (cm)	.37"-.49" (.94-1.24)	.50"-.61" (1.27-1.55)	.62"-.74" (1.57-1.88)	.75"-.99" (1.90-2.51)	1.00"-1.49" (2.54-3.78)
Approx. Breaking Strength Lbs.	3,500	3,500	4,400	7,500	10,000
Mesh Length Inches (cm)	Catalog Number				
18" (45.72)	013041330	01304064	01304009	—	—
24" (60.96)	—	01304011	01304013	01304010	01304015
36" (91.44)	—	—	013041234	01304054	01304055
48" (121.92)	—	—	—	01304017	01304029
72" (182.88)	—	—	—	01304037	013041333

Junior Splicing Grips, Single Weave

Junior Splicing Grips are made of galvanized steel and are designed for use in very light duty and small splicing jobs.

Benefits

- Easily installed or removed
- Galvanized steel construction for strength
- Flexible to follow cable path



Junior Tube

Cable Diameter Range Inches (cm)	Approx. Breaking Strength Lbs.	Working Load Lbs.	Length @ Nom Diameter Inches (cm)	Catalog Number
.18"-.24" (.46-.61)	400	80	7" (17.78)	01301008
.25"-.36" (.63-.91)	400	80	8" (20.32)	01301013

Note: 1. During installation each end of the grip should be banded and taped down securely over the rope to insure smooth passage through sheaves and to guard against accidental release. See page W-16 for end bands.

Dimensions in Inches (mm)

Punch-Lok® Bands

Punch-Lok Bands are applied over the tail of a grip to prevent the mesh from being tripped or pulled loose. Also, they assure full gripping action by locking the mesh of the tail in tight contact with the cable or rope.

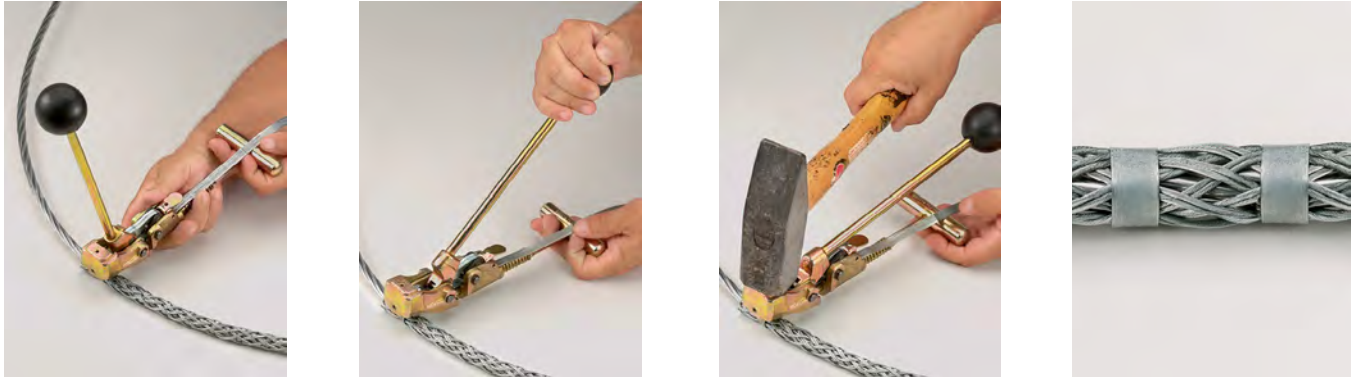

When the tail of a grip is the leading end, the bands are particularly important to prevent accidental release caused by tripping on obstructions. A conductor-to-conductor (double-socking) pulling operation is a good example: where two grips connect two conductors to form a temporary splice. In all cases two Punch-Lok® Bands should be double wrapped approximately one inch to two inches (2.54cm to 5.08cm) from the grip's tail. Banding is required to ensure maximum reliability and guard against accidental release. It is also common practice to tape over the banded tail area to assure smooth passage through the sheaves. The conductor should be installed in the grip up to the elbows of the aluminum shoulders in order to assure full and complete gripping action as illustrated above.



20320054



20320048



20320047

Punch-Lok® Bands

Grip Banding Range Inches (cm)	Band Width Inches (cm)	Band Inside Diameter Inches (cm)	Model	Catalog Number
.25"-1.13" (.63-2.86)	.38" (.95)	1.38" (3.49)	0-311	20320050
1.13"-1.63" (2.86-4.13)	.38" (.95)	2.00" (5.08)	0-316	20320051
1.63"-2.25" (4.13-5.71)	.63" (1.59)	2.50" (6.35)	0-10	20320052
2.25"-3.50" (5.71-8.89)	.63" (1.59)	4.00" (10.16)	0-16	20320053
3.50"-5.00" (8.89-12.70)	.63" (1.59)	6.00" (15.24)	0-24	20320054

Accessories

Punch-Lok Tools

	Catalog Number
P-1000 for use with .63" width Banding tool.	20320048
P-38 for use with .38" and .63" width Banding tool for tight spaces.	20320047

Stainless Steel Swivels

Swivels are essential to the efficiency and safety of any high tension application. They are particularly important where continuous pulls develop higher and higher torque levels. Torque is intensified by the pull-resistance of the cable itself and the resistance of the high tension controlling equipment regulating line sag. Ball bearing swivels release torque and prevent it from reaching dangerous levels that can damage the cable and obstruct the lines.

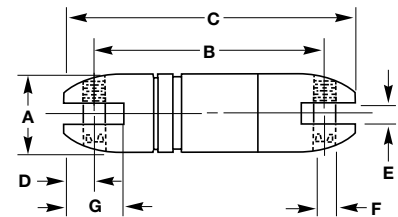

Stainless Steel Swivels



20308001A

Maximum Safe Working Load Lbs. (N)	Dimensions in Inches (cm)							Model	Catalog Number
	A	B	C	D	E	F	G		
2,250 (10,000)	.88" (2.22)	2.50" (6.35)	3.38" (8.57)	.44" (1.11)	.38" (0.95)	.31" (0.79)	.97" (2.46)	A-13L	20308001A
5,000 (22,240)	1.25" (3.17)	3.69" (9.37)	4.75" (12.06)	1.22" (1.35)	1.22" (1.35)	.41" (1.03)	1.28" (3.25)	BB-13L	20308002A
9,000 (40,030)	1.50" (3.81)	4.25" (10.79)	5.63" (14.29)	.69" (1.75)	1.28" (1.51)	.50" (1.27)	1.56" (3.97)	B-13L	20308003A
10,000 (44,480)	1.63" (4.13)	4.50" (11.43)	6.00" (15.24)	.75" (1.90)	.69" (1.75)	.63" (1.59)	1.72" (4.36)	C-13L	20308004A
30,000 (133,440)	2.38" (6.03)	7.63" (19.37)	10.00" (25.40)	1.19" (3.02)	1.03" (2.62)	.88" (2.22)	2.78" (7.06)	D-13L	20308005A

Punch-Lok® is a registered trademark of Punch-Lok Inc.

Kellems® Wire Management Products

Kellems Pulling Grips are reusable tools for pulling electrical cable, bare conductor or rope. They are easy and fast to install, providing the user with a smooth, slim profile that allows for easy passage through ducts and conduit. Kellems Pulling Grips are made of the highest quality galvanized steel strand which assures the user of a long lasting grip. There is a Kellems Pulling Grip for every pulling job.

WARNING: It is very important to read and understand all safety information before proceeding. Failure to use as directed may result in property damage, personal injury or death.

Grips are to be installed and utilized by a qualified technician in accordance with all applicable national and local safety and electrical codes. Consult a licensed project safety professional, if necessary.

Ensure that the correct grip is selected for your specific needs. Grips should only be used for their intended purpose and not for other applications.

Banding the tail end of the grip is required to prevent unintended release of the grip's hold from the cable and to achieve maximum gripping strength

The strength of a Kellems grips is based on laboratory testing and does not evaluate variable conditions such as cable type, gripping surfaces, cable movement or impact loads. Suitability for the application must be determined by the user.

Thoroughly examine the condition of the grip prior to each use. Grips that are worn, bent, corroded, or show other signs of damage, such as frayed or broken wires, should never be used and must be replaced.

Do not modify the grip in any way.

Ensure that the recommended work load of the grip is suitable for the application. Never use a grip beyond its safe working load, which is the approximate breaking strength divided by the factor of safety. The recommended factor of safety is five (5) for pulling grips and ten (10) for support grips.

Pulling hardware should only be attached to the eye of the grip.

A swivel is recommended for attachment to the grip's eye in applications where torque release is necessary. Torque can build up in high tension pulling applications.

Do not run grips and swivels around sheaves or bull wheels while under tension. For synthetic rope, use Kellems Dua-Pull Grips only.

IMPORTANT:

Under normal conditions, Kellems' recommended factor of safety is five for catalog listed pulling grips, and ten for catalog listed support grips.

Select The Correct Pulling Grip

Each Kellems Grip is designed to work on a specific range of cable diameters.

Step 1 Refer to the chart below to determine the style of grip best suited for your application.

Step 2 Determine your cable outside diameter.

Step 3 Find the grip size that encompasses your cable diameter.

Step 4 Estimate the tension to be put on the grip, establish the working load you require and compare this to the listed approximate breaking strength of the grip to insure that the grip will be strong enough. Refer to page W-34 for safety and working load factors.

Pulling Grip Selection Chart

Grip Style	Application	Page Number
DUA-PULL®, flexible eye	Extra high strength overhead transmission line stringing for bare or insulated conductor and synthetic rope.	W-7
Multiple strength, flexible eye	Normal overhead transmission and distribution line stringing for bare or insulated conductor.	W-8
Multiple strength, rotating eye	Normal overhead transmission and distribution line stringing for bare or insulated conductor.	W-8
K-type grip, rotating eye	Underground power cables and communication lines. Service lines into factories.	W-9
T-type grip, flexible eye	Underground power cables and communication lines. Service lines into factories.	W-10
Non-conductive, flexible eye	Pull insulated distribution cable into place.	W-11
Slack pulling, closed mesh	Remove underground cable. For pulling slack in final placement of new cable when end of cable is available.	W-11
Slack pulling, split mesh,	Remove underground cable. For pulling slack in final placement of new cable rawhide lace closing when end of cable is not available.	W-12
Slack pulling, split mesh,	Remove underground cable. For pulling slack in final placement of new cable rod closing when end of cable is not available, with rod closing for quick installation.	W-12
Light duty, flexible eye	Light pulling, underground electrical construction. Industrial plant wiring and rewiring jobs.	W-13
Junior, flexible eye	Connect bundled insulated building wire to a pulling tape. Pull wire through conduit.	W-13
Regular and rotating wire rope	Restraining wire rope in cranes and oil rigs.	W-14
Splicing	Temporary splice for cable or wire rope.	W-15
Pulling Grip Accessories	Tools, bands, swivels.	W-16
Fiber Optic Cable Pulling Grips	Pull fiber optic cable into place overhead, underground or through duct and conduit.	W-39 to W-43

Multiple Cable Selection Charts for Cables and Wires of Unequal Diameters

How to choose the correct grip size:

1. Find the Grip Circumference Range by measuring the circumference of the bundle of different diameter cables to be gripped (see illustration).
2. Divide the bundle circumference by 3.14 to determine the diameter.
3. Choose a grip offering a range of cable diameters the same as the cable diameter.

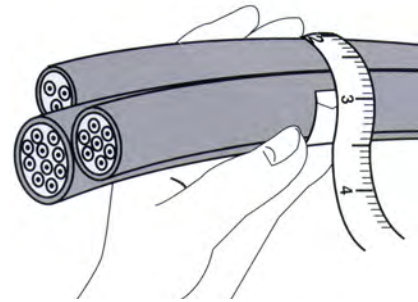

For Pulling Grips*

CAUTION: When a grip is used on multiple cables, the tail end of the grip should be banded after positioning on the cables.

For Cables of Equal Diameters

Under "Number of Cables in One Grip", find the diameter of your single cable in vertical column. Read the grip diameter range to the right.

If your diameter is the maximum of the range shown, go to the next larger size for Split Grips, stay with the same size for Closed Grips.

Example: Three cables, each with .89" (2.26cm) diameter, for a Closed Grip select the 1.50"-1.74" (3.81cm-4.42cm) range, for a Split Grip select the 1.75"-1.99" (4.44cm-5.05cm) range.

Number of Cables in One Grip

2	3	4	5	6 and 7	8	9	Grip Dia. Range Inches (cm)
.30-.38 (.76-.97)	.25-.31 (.63-.79)	.22-.27 (.56-.69)	.19-.24 (.48-.60)	.17-.22 (.43-.56)	.15-.19 (.38-.48)	.14-.18 (.36-.46)	.50-.61 (1.27-1.55)
.38-.44 (.97-1.12)	.31-.36 (.79-.91)	.27-.31 (.69-.79)	.24-.29 (.61-.74)	.22-.26 (.56-.66)	.19-.23 (.48-.58)	.18-.21 (.46-.53)	.62-.74 (1.57-1.88)
.44-.59 (1.12-1.50)	.36-.49 (.91-1.24)	.31-.42 (.79-1.07)	.29-.38 (.74-.97)	.26-.34 (.66-.86)	.23-.31 (.58-.79)	.21-.28 (.53-.71)	.75-.99 (1.90-2.51)
.59-.75 (1.50-1.90)	.49-.63 (1.24-1.60)	.42-.54 (1.07-1.37)	.38-.48 (.97-1.22)	.34-.43 (.86-1.09)	.31-.39 (.79-.99)	.28-.35 (.71-.89)	1.00-1.24 (2.54-3.15)
.75-.90 (1.90-2.29)	.63-.76 (1.60-1.93)	.54-.65 (1.37-1.65)	.48-.58 (1.22-1.47)	.43-.52 (1.09-1.32)	.39-.46 (.99-1.17)	.35-.42 (.89-1.07)	1.25-1.49 (3.17-3.78)
.90-1.07 (2.29-2.72)	.76-.89 (1.93-2.26)	.65-.77 (1.65-1.96)	.58-.67 (1.47-1.70)	.52-.60 (1.32-1.52)	.46-.54 (1.17-1.37)	.42-.49 (1.07-1.24)	1.50-1.74 (3.81-4.42)
1.07-1.22 (2.72-3.10)	.89-1.02 (2.26-2.59)	.77-.88 (1.96-2.24)	.67-.77 (1.70-1.96)	.60-.69 (1.52-1.75)	.54-.62 (1.37-1.57)	.49-.56 (1.24-1.42)	1.75-1.99 (4.44-5.05)
1.22-1.53 (3.10-3.89)	1.02-1.28 (2.59-3.25)	.88-1.10 (2.24-2.79)	.77-.96 (1.96-2.44)	.69-.86 (1.75-2.18)	.62-.77 (1.57-1.96)	.56-.71 (1.42-1.80)	2.00-2.49 (5.08-6.32)
1.53-1.83 (3.89-4.65)	1.28-1.53 (3.25-3.89)	1.10-1.32 (2.79-3.35)	.96-1.16 (2.44-2.95)	.86-1.03 (2.18-2.62)	.77-.93 (1.96-2.36)	.71-.85 (1.80-2.16)	2.50-2.99 (6.35-7.59)
1.83-2.14 (4.65-5.44)	1.53-1.79 (3.89-4.55)	1.32-1.54 (3.35-3.91)	1.16-1.35 (2.95-3.43)	1.03-1.20 (2.62-3.05)	.93-1.08 (2.36-2.74)	.85-.99 (2.16-2.51)	3.00-3.49 (7.62-8.86)
2.14-2.44 (5.44-6.20)	1.79-2.05 (4.55-5.21)	1.54-1.76 (3.91-4.47)	1.35-1.54 (3.43-3.91)	1.20-1.37 (3.05-3.48)	1.08-1.24 (2.74-3.15)	.99-1.13 (2.51-2.87)	3.50-3.99 (8.89-10.13)
2.44-2.75 (6.20-6.98)	2.05-2.30 (5.21-5.84)	1.76-1.98 (4.47-5.03)	1.54-1.74 (3.91-4.42)	1.37-1.55 (3.48-3.94)	1.24-1.39 (3.15-3.53)	1.13-1.27 (2.87-3.23)	4.00-4.49 (10.16-11.40)
2.75-3.06 (6.98-7.77)	2.30-2.56 (5.84-6.50)	1.98-2.20 (5.03-5.59)	1.74-1.93 (4.42-4.90)	1.55-1.72 (3.94-4.37)	1.39-1.55 (3.53-3.94)	1.27-1.41 (3.23-3.58)	4.50-4.99 (11.43-12.67)

Note: *This chart is not to be used for Conduit Riser Grips. Refer to the chart for Conduit Riser multiple cable section. It is always recommended that, when multiple cables are installed in a pulling grip, the tail end be banded and tightly taped after installation on the cable bundle. See page W-16 for end bands.

Kellems® Wire Management Products

Features and Benefits

Kellems® Support Grips

They are used to hold the weight of electrical cable as it hangs in a vertical, sloping or horizontal position. Electrical cable must be supported, or its dead weight can cause excessive strain or pullout at the connections resulting in power failure. Support grips also absorb additional strain from flexure, vibration, expansion and contraction.

Kellems support grips listed in this catalog are made of high grade, non-magnetic tin-coated bronze strand. Stainless steel grips, made of alloy 302–304 series stainless are for severe service or unusual environmental conditions. For exceptional immunity to rust and corrosion with superior strength and flexibility for heavy duty support application in harsh environments available upon request; contact the factory.



Mesh Grip

- The positive action mesh grip is designed for light duty up to heavy duty; closed grips fit over the cable end, split grips wrap around the cable mid-span
- The endless weave provides easy installation onto cable and can be easily repositioned



Eye Styles

- Four eye styles available: single (shown), double, universal and offset
- Solid eye assemblies provide eye reinforcement at support hardware
- Each Kellems grip is designed to work on a specific range of cable diameters



Cable Identification

- Identification tag shows: catalog number, diameter range, agency approval and bar code
- The strand equalizer positions wires for equal loading throughout the entire grip length

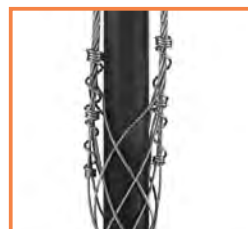

Strand Equalizer

- Positions wires for equal loading throughout the entire grip length

Standard Duty Support Grips

Single Eye, Single Weave, Tin-Coated Bronze and Stainless Steel.

IMPORTANT:

Read all breaking strength, safety and technical data relating to this product.

Refer to pages W-33 and W-34.

Single Eye, Closed Mesh

For permanent support when cable end is available to be installed through grip.

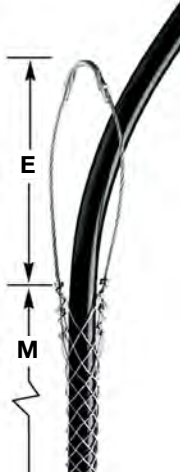

Cable Diameter Range Inches (cm)	Approx. Breaking Strength Lbs.		Working Load Lbs.		E Inches (cm)	M Inches (cm)	Tin-Coated Bronze	Stainless Steel
	Tin-Coated Bronze	Stainless Steel	Tin-Coated Bronze	Stainless Steel				
.50"--.62" (1.27-1.57)	530	1,370	53	137	7" (17.78)	10" (25.40)	02201013	02401013
.63"--.74" (1.60-1.88)	790	2,060	79	206	8" (20.32)	10" (25.40)	02201014	02401014
.75"--.99" (1.90-2.51)	1,020	2,060	102	206	8" (20.32)	13" (33.02)	02201015	02401015
1.00"-1.24" (2.54-3.15)	1,610	2,678	161	268	9" (22.86)	14" (35.56)	02201017	02401017
1.25"-1.49" (3.17-3.78)	1,610	4,490	161	449	10" (25.40)	15" (38.10)	02201018	02401018
1.50"-1.74" (3.81-4.42)	1,610	4,492	161	449	12" (30.48)	17" (43.18)	02201019	02401019
1.75"-1.99" (4.44-5.05)	2,150	5,000	215	500	14" (35.56)	19" (48.26)	02201020	02401020
2.00"-2.49" (5.08-6.32)	3,260	8,940	326	894	16" (40.64)	21" (53.34)	02201021	02401021
2.50"-2.99" (6.35-7.59)	3,260	8,947	326	895	18" (45.72)	23" (58.42)	02201022	02401022
3.00"-3.49" (7.62-8.86)	4,900	13,420	490	1,342	21" (53.34)	25" (63.50)	02201023	02401023
3.50"-3.99" (8.89-10.13)	4,900	—	490	—	24" (60.96)	27" (68.58)	02201024	—

Single Eye, Split Mesh, Lace Closing

For permanent support when cable end is not available.

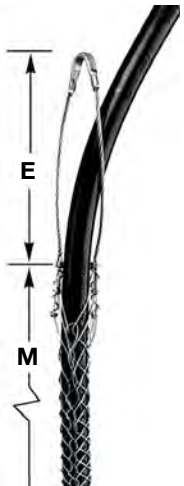

Cable Diameter Range Inches (cm)	Approx. Breaking Strength Lbs.		Working Load Lbs.		E Inches (cm)	M Inches (cm)	Tin-Coated Bronze	Stainless Steel
	Tin-Coated Bronze	Stainless Steel	Tin-Coated Bronze	Stainless Steel				
.50"--.62" (1.27-1.57)	530	1,370	53	137	7" (17.78)	10" (25.40)	02202013	02402013
.63"--.74" (1.60-1.88)	790	2,066	79	207	8" (20.32)	10" (25.40)	02202014	02402014
.75"--.99" (1.90-2.51)	1,020	2,060	102	206	8" (20.32)	13" (33.02)	02202015	02402015
1.00"-1.24" (2.54-3.15)	1,610	2,670	161	267	9" (22.86)	14" (35.56)	02202017	02402017
1.25"-1.49" (3.17-3.78)	1,610	4,490	161	449	10" (25.40)	15" (38.10)	02202018	02402018
1.50"-1.74" (3.81-4.42)	1,610	4,490	161	449	12" (30.48)	17" (43.18)	02202019	02402019
1.75"-1.99" (4.44-5.05)	2,150	4,375	215	437	14" (35.56)	19" (48.26)	02202020	02402020
2.00"-2.49" (5.08-6.32)	3,260	8,947	326	895	16" (40.64)	21" (53.34)	02202021	02402021
2.50"-2.99" (6.35-7.59)	3,260	8,940	326	894	18" (45.72)	23" (58.42)	02202022	02402022
3.00"-3.49" (7.62-8.86)	4,900	13,420	490	1,342	21" (53.34)	25" (63.50)	02202023	02402023
3.50"-3.99" (8.89-10.13)	4,900	13,420	490	1,342	24" (60.96)	27" (68.58)	02202024	02402024

Single Eye, Split Mesh, Rod Closing

For support when cable end is not available.

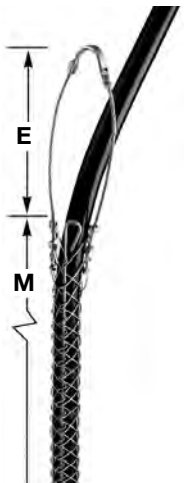

Cable Diameter Range Inches (cm)	Approx. Breaking Strength Lbs.		Working Load Lbs.		E Inches (cm)	M Inches (cm)	Tin-Coated Bronze	Stainless Steel
	Tin-Coated Bronze	Stainless Steel	Tin-Coated Bronze	Stainless Steel				
.50"--.62" (1.27-1.57)	790	1,050	79	105	7" (17.78)	8.5" (21.59)	02203013	02403013
.63"--.74" (1.60-1.88)	790	2,050	79	205	8" (20.32)	8.5" (21.59)	02203014	02403014
.75"--.99" (1.90-2.51)	1,020	2,050	102	205	8" (20.32)	10.5" (26.67)	02203015	02403015
1.00"-1.24" (2.54-3.15)	1,610	2,650	161	265	9" (22.86)	12.5" (31.75)	02203017	02403017
1.25"-1.49" (3.17-3.78)	1,610	4,500	161	450	10" (25.40)	14.5" (36.83)	02203018	02403018
1.50"-1.74" (3.81-4.42)	1,610	4,500	161	450	12" (30.48)	15.5" (39.37)	02203019	02403019
1.75"-1.99" (4.44-5.05)	2,150	6,000	215	600	14" (35.56)	16.5" (41.91)	02203020	02403020
2.00"-2.49" (5.08-6.32)	3,260	8,950	326	895	16" (40.64)	19.5" (49.53)	02203021	02403021
2.50"-2.99" (6.35-7.59)	3,260	7,750	326	775	18" (45.72)	21.5" (54.61)	02203022	02403022
3.00"-3.49" (7.62-8.86)	5,750	8,500	575	850	21" (53.34)	23.5" (59.69)	02203023	02403023
3.50"-3.99" (8.89-10.13)	5,750	—	575	—	24" (60.96)	25.5" (64.77)	02203024	—

Dimensions in Inches (mm) *Note: E-Eye length. M-Mesh length at nominal diameter.*

Standard Duty Support Grips

Double Eye, Single Weave, Tin-Coated Bronze and Stainless Steel.

IMPORTANT:
Read all breaking strength, safety and technical data relating to this product.

Refer to pages W-33 and W-34.

Double Eye, Closed Mesh

For permanent support when cable end is available to be installed through grip.

Cable Diameter Range Inches (cm)	Approx. Breaking Strength Lbs.		Working Load Lbs.		E Inches (cm)	M Inches (cm)	Tin-Coated Bronze	Stainless Steel
	Tin-Coated Bronze	Stainless Steel	Tin-Coated Bronze	Stainless Steel				
.50"-.62" (1.27-1.57)	530	1,370	53	137	4" (10.16)	10" (25.40)	02201001	02401001
.63"-.74" (1.60-1.88)	790	2,060	79	206	4" (10.16)	10" (25.40)	02201002	02401002
.75"-.99" (1.90-2.51)	1,020	2,060	102	206	4" (10.16)	13" (33.02)	02201003	02401003
1.00"-1.24" (2.54-3.15)	1,610	2,670	161	267	5" (12.70)	14" (35.56)	02201005	02401005
1.25"-1.49" (3.17-3.78)	1,610	4,490	161	449	5" (12.70)	15" (38.10)	02201006	02401006
1.50"-1.74" (3.81-4.42)	1,610	4,490	161	449	5" (12.70)	17" (43.18)	02201007	02401007
1.75"-1.99" (4.44-5.05)	2,150	5,000	215	500	6" (15.24)	19" (48.26)	02201008	02401008
2.00"-2.49" (5.08-6.32)	3,260	8,940	326	894	6" (15.24)	21" (53.34)	02201009	02401009
2.50"-2.99" (6.35-7.59)	3,260	8,940	326	894	6" (15.24)	23" (58.42)	02201010	02401010
3.00"-3.49" (7.62-8.86)	4,900	12,000	490	1,200	8" (20.32)	25" (63.50)	02201011	02401011
3.50"-3.99" (8.89-10.13)	4,900	12,000	490	1,200	8" (20.32)	27" (68.58)	02201012	02401012

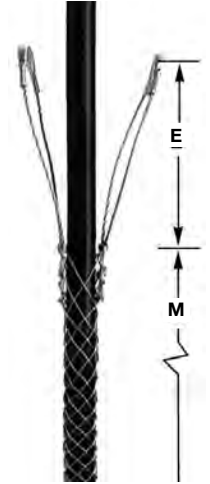

Double Eye, Split Mesh, Lace Closing

For permanent support when cable end is not available.

Cable Diameter Range Inches (cm)	Approx. Breaking Strength Lbs.		Working Load Lbs.		E Inches (cm)	M Inches (cm)	Tin-Coated Bronze	Stainless Steel
	Tin-Coated Bronze	Stainless Steel	Tin-Coated Bronze	Stainless Steel				
.50"-.62" (1.27-1.57)	530	—	53	—	4" (10.16)	10" (25.40)	02202001	—
.63"-.74" (1.60-1.88)	790	2,066	79	207	4" (10.16)	10" (25.40)	02202002	02402002
.75"-.99" (1.90-2.51)	1,020	2,060	102	206	4" (10.16)	13" (33.02)	02202003	02402003
1.00"-1.24" (2.54-3.15)	1,610	2,678	161	268	5" (12.70)	14" (35.56)	02202005	02402005
1.25"-1.49" (3.17-3.78)	1,610	4,490	161	449	5" (12.70)	15" (38.10)	02202006	02402006
1.50"-1.74" (3.81-4.42)	1,610	3,750	161	375	5" (12.70)	17" (43.18)	02202007	02402007
1.75"-1.99" (4.44-5.05)	2,150	5,000	215	500	6" (15.24)	19" (48.26)	02202008	02402008
2.00"-2.49" (5.08-6.32)	3,260	8,940	326	894	6" (15.24)	21" (53.34)	02202009	02402009
2.50"-2.99" (6.35-7.59)	3,260	—	326	—	6" (15.24)	23" (58.42)	02202010	—
3.00"-3.49" (7.62-8.86)	4,900	—	490	—	8" (20.32)	25" (63.50)	02202011	—
3.50"-3.99" (8.89-10.13)	4,900	—	490	—	8" (20.32)	27" (68.58)	02202012	—

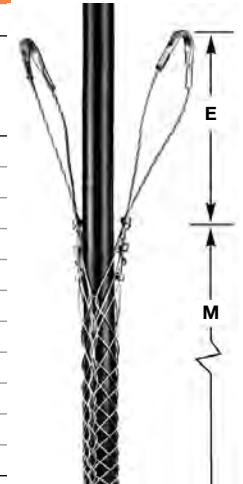

Double Eye, Split Mesh, Rod Closing

For support when cable end is not available.

Cable Diameter Range Inches (cm)	Approx. Breaking Strength Lbs.		Working Load Lbs.		E Inches (cm)	M Inches (cm)	Tin-Coated Bronze	Stainless Steel
	Tin-Coated Bronze	Stainless Steel	Tin-Coated Bronze	Stainless Steel				
.50"-.62" (1.27-1.57)	790	—	79	—	4" (10.16)	6.5"	02203001	—
.63"-.74" (1.60-1.88)	790	2,050	79	205	4" (10.16)	8.5" (21.59)	02203002	02403002
.75"-.99" (1.90-2.51)	1,020	2,050	102	205	4" (10.16)	10.5" (26.67)	02203003	02403003
1.00"-1.24" (2.54-3.15)	1,610	2,650	161	265	5" (12.70)	12.5" (31.75)	02203005	02403005
1.25"-1.49" (3.17-3.78)	1,610	3,750	161	375	5" (12.70)	14.5" (36.83)	02203006	02403006
1.50"-1.74" (3.81-4.42)	1,610	3,750	161	375	5" (12.70)	15.5" (39.37)	02203007	02403007
1.75"-1.99" (4.44-5.05)	2,150	5,000	215	215	6" (15.24)	16.5" (41.91)	02203008	02403008
2.00"-2.49" (5.08-6.32)	3,260	8,950	326	326	6" (15.24)	19.5" (49.53)	02203009	02403009
2.50"-2.99" (6.35-7.59)	3,260	8,950	326	326	6" (15.24)	21.5" (54.61)	02203010	02403010
3.00"-3.49" (7.62-8.86)	5,750	11,150	575	1,115	8" (20.32)	23.5" (59.69)	02203011	02403011
3.50"-3.99" (8.89-10.13)	5,750	—	575	—	8" (20.32)	25.5" (64.77)	02203012	—

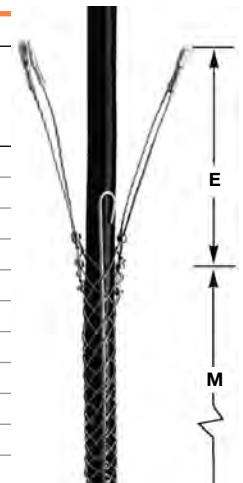

Note: E-Eye length. M-Mesh length at nominal diameter.

Dimensions in Inches (mm)

Standard Duty Support Grips

Offset Eye, Single Weave, Tin-Coated Bronze and Stainless Steel.

IMPORTANT:
Read all breaking strength, safety and technical data relating to this product.

Refer to pages W-33 and W-34.

Offset Eye, Closed Mesh

For permanent support when cable end is available to be installed through grip.

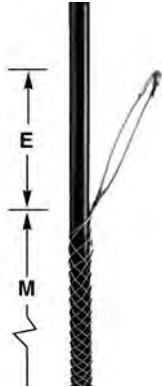

Cable Diameter Range Inches (cm)	Approx. Breaking Strength Lbs.		Working Load Lbs.		E Inches (cm)	M Inches (cm)	Tin-Coated Bronze	Stainless Steel
	Tin-Coated Bronze	Stainless Steel	Tin-Coated Bronze	Stainless Steel				
.50"--.62" (1.27-1.57)	530	1,370	53	137	4" (10.16)	10" (25.40)	02201037	02401037
.63"--.74" (1.60-1.88)	750	1,950	75	195	4" (10.16)	10" (25.40)	02201038	02401038
.75"--.99" (1.90-2.51)	950	2,060	95	206	4" (10.16)	13" (33.02)	02201039	02401039
1.00"-1.24" (2.54-3.15)	1,500	2,678	150	268	5" (12.70)	14" (35.56)	02201041	02401041
1.25"-1.49" (3.17-3.78)	1,500	4,490	150	449	5" (12.70)	15" (38.10)	02201042	02401042
1.50"-1.74" (3.81-4.42)	1,500	3,700	150	370	5" (12.70)	17" (43.18)	02201043	02401043
1.75"-1.99" (4.44-5.05)	2,000	4,375	200	437	6" (15.24)	19" (48.26)	02201044	02401044
2.00"-2.49" (5.08-6.32)	3,100	5,500	310	550	9" (22.86)	21" (53.34)	02201045	02401045
2.50"-2.99" (6.35-7.59)	3,100	—	310	—	9" (22.86)	23" (58.42)	02201046	—
3.00"-3.49" (7.62-8.86)	3,800	—	380	—	11" (27.94)	25" (63.50)	02201047	—
3.50"-3.99" (8.89-10.13)	3,250	—	325	—	11" (27.94)	27" (68.58)	02201048	—

Offset Eye, Split Mesh, Lace Closing

For permanent support when cable end is not available.

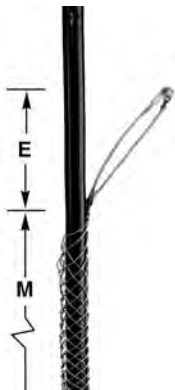

Cable Diameter Range Inches (cm)	Approx. Breaking Strength Lbs. (N)		Working Load Lbs.		E Inches (cm)	M Inches (cm)	Tin-Coated Bronze	Stainless Steel
	Tin-Coated Bronze	Stainless Steel	Tin-Coated Bronze	Stainless Steel				
.50"--.62" (1.27-1.57)	500	—	50	—	4" (10.16)	10" (25.40)	02202037	—
.63"--.74" (1.60-1.88)	750	1,952	75	195	4" (10.16)	10" (25.40)	02202038	02402038
.75"--.99" (1.90-2.51)	950	—	95	—	4" (10.16)	13" (33.02)	02202039	—
1.00"-1.24" (2.54-3.15)	1,500	—	150	—	5" (12.70)	14" (35.56)	02202041	—
1.25"-1.49" (3.17-3.78)	1,500	4,490	150	449	5" (12.70)	15" (38.10)	02202042	02402042
1.50"-1.74" (3.81-4.42)	1,500	—	150	—	5" (12.70)	17" (43.18)	02202043	—
1.75"-1.99" (4.44-5.05)	1,800	4,375	180	437	6" (15.24)	19" (48.26)	02202044	02402044
2.00"-2.49" (5.08-6.32)	2,150	5,500	215	550	9" (22.86)	21" (53.34)	02202045	02402045
2.50"-2.99" (6.35-7.59)	2,150	5,500	215	550	9" (22.86)	23" (58.42)	02202046	02402046
3.00"-3.49" (7.62-8.86)	3,250	10,190	325	1,019	11" (27.94)	25" (63.50)	02202047	02402047
3.50"-3.99" (8.89-10.13)	3,250	—	325	—	11" (27.94)	27" (68.58)	02202048	—

Offset Eye, Split Mesh, Rod Closing

For support when cable end is not available.

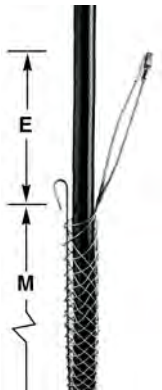

Cable Diameter Range Inches (cm)	Approx. Breaking Strength Lbs. (N)		Working Load Lbs.		E Inches (cm)	M Inches (cm)	Tin-Coated Bronze	Stainless Steel
	Tin-Coated Bronze	Stainless Steel	Tin-Coated Bronze	Stainless Steel				
.50"--.62" (1.27-1.57)	500	1,000	50	100	4" (10.16)	7" (17.78)	02203037	02403037
.63"--.74" (1.60-1.88)	750	1,950	75	195	4" (10.16)	9" (22.86)	02203038	02403038
.75"--.99" (1.90-2.51)	950	1,950	95	195	4" (10.16)	10" (25.40)	02203039	02403039
1.00"-1.24" (2.54-3.15)	1,500	2,500	150	250	5" (12.70)	12" (30.48)	02203041	02403041
1.25"-1.49" (3.17-3.78)	1,500	4,200	150	420	5" (12.70)	14" (35.56)	02203042	02403042
1.50"-1.74" (3.81-4.42)	1,500	4,500	150	450	5" (12.70)	15" (38.10)	02203043	02403043
1.75"-1.99" (4.44-5.05)	2,000	4,375	200	437	6" (15.24)	16" (40.64)	02203044	02403044
2.00"-2.49" (5.08-6.32)	3,100	8,350	310	835	9" (22.86)	19" (48.26)	02203045	02403045
2.50"-2.99" (6.35-7.59)	3,100	—	310	—	9" (22.86)	20" (50.80)	02203046	—
3.00"-3.49" (7.62-8.86)	4,300	8,400	430	840	11" (27.94)	21" (53.34)	02203047	02403047
3.50"-3.99" (8.89-10.13)	4,900	—	490	—	11" (27.94)	21" (53.34)	02203048	—

Note: E-Eye length. M-Mesh length at nominal diameter.

Dimensions in Inches (mm)

Standard Duty Support Grips

Universal Eye, Single Weave, Tin-Coated Bronze and Stainless Steel.

IMPORTANT:
Read all breaking strength, safety and technical data relating to this product.

Refer to pages W-33 and W-34.

Universal Eye, Closed Mesh

For permanent support when cable end is available to be installed through grip.

Cable Diameter Range Inches (cm)	Approx. Breaking Strength Lbs. (N)		Working Load Lbs.				Tin-Coated Bronze	Stainless Steel
	Tin-Coated Bronze	Stainless Steel	Tin-Coated Bronze	Stainless Steel	E Inches (cm)	M Inches (cm)		
.50"-.62" (1.27-1.57)	530	1,370	53	137	18" (45.72)	10" (25.40)	02201051	02401051
.63"-.74" (1.60-1.88)	790	2,060	79	206	18" (45.72)	10" (25.40)	02201052	02401052
.75"-.99" (1.90-2.51)	1,020	2,066	102	207	18" (45.72)	13" (33.02)	02201053	02401053
1.00"-1.24" (2.54-3.15)	1,610	—	161	—	18" (45.72)	14" (35.56)	02201050	—
1.25"-1.49" (3.17-3.78)	1,610	4,490	161	449	18" (45.72)	15" (38.10)	02201054	02401054
1.50"-1.74" (3.81-4.42)	1,610	4,490	161	449	18" (45.72)	17" (43.18)	02201055	02401055
1.75"-1.99" (4.44-5.05)	2,150	—	215	—	18" (45.72)	19" (48.26)	02201056	—
2.00"-2.49" (5.08-6.32)	3,260	—	326	—	18" (45.72)	21" (53.34)	02201057	—
2.50"-2.99" (6.35-7.59)	3,260	—	326	—	18" (45.72)	23" (58.42)	02201058	—



Universal Eye, Split Mesh, Lace Closing

For permanent support when cable end is not available.

Cable Diameter Range Inches (cm)	Approx. Breaking Strength Lbs. (N)		Working Load Lbs.				Tin-Coated Bronze	Stainless Steel
	Tin-Coated Bronze	Stainless Steel	Tin-Coated Bronze	Stainless Steel	E Inches (cm)	M Inches (cm)		
.50"-.62" (1.27-1.57)	530	—	53	—	18" (45.72)	10" (25.40)	02202050	—
.63"-.74" (1.60-1.88)	790	2,060	79	206	18" (45.72)	10" (25.40)	02202051	02402051
.75"-.99" (1.90-2.51)	1,020	—	102	—	18" (45.72)	13" (33.02)	02202052	—
1.00"-1.24" (2.54-3.15)	1,610	—	161	—	18" (45.72)	14" (35.56)	02202054	—
1.25"-1.49" (3.17-3.78)	1,610	—	161	—	18" (45.72)	15" (38.10)	02202055	—
1.50"-1.74" (3.81-4.42)	1,610	—	161	—	18" (45.72)	17" (43.18)	02202056	—
1.75"-1.99" (4.44-5.05)	2,150	—	215	—	18" (45.72)	19" (48.26)	02202057	—
2.00"-2.49" (5.08-6.32)	3,260	—	326	—	18" (45.72)	21" (53.34)	02202058	—
2.50"-2.99" (6.35-7.59)	3,260	—	326	—	18" (45.72)	23" (58.42)	02202059	—
3.50"-3.99" (8.89-10.13)	4,900	—	490	—	18" (45.72)	27" (68.58)	02202061	—



Universal Eye, Split Mesh, Rod Closing

For support when cable end is not available.

Cable Diameter Range Inches (cm)	Approx. Breaking Strength Lbs. (N)		Working Load Lbs.				Tin-Coated Bronze	Stainless Steel
	Tin-Coated Bronze	Stainless Steel	Tin-Coated Bronze	Stainless Steel	E Inches (cm)	M Inches (cm)		
.50"-.62" (1.27-1.57)	790	—	79	—	18" (45.72)	8.5" (21.59)	02203064	—
.63"-.74" (1.60-1.88)	790	2,050	79	205	18" (45.72)	8.5" (21.59)	02203065	02403065
.75"-.99" (1.90-2.51)	1,020	2,050	102	205	18" (45.72)	10.5" (26.67)	02203066	02403066
1.00"-1.24" (2.54-3.15)	1,610	2,650	161	265	18" (45.72)	12.5" (31.75)	02203068	02403068
1.25"-1.49" (3.17-3.78)	1,610	4,500	161	450	18" (45.72)	14.5" (36.83)	02203069	02403069
1.50"-1.74" (3.81-4.42)	1,610	4,500	161	450	18" (45.72)	15.5" (39.37)	02203070	02403070
1.75"-1.99" (4.44-5.05)	2,150	—	215	—	18" (45.72)	16.5" (41.91)	02203071	—
2.00"-2.49" (5.08-6.32)	3,260	—	326	—	18" (45.72)	19.5" (49.53)	02203072	—
2.50"-2.99" (6.35-7.59)	3,260	—	326	—	18" (45.72)	21.5" (54.61)	02203073	—
3.00"-3.49" (7.62-8.86)	5,750	—	575	—	18" (45.72)	23.5" (59.69)	02203074	—



Note: E-Eye length. M-Mesh length at nominal diameter.

Dimensions in Inches (mm)

Non-Metallic Support Grips

Single Eye, Double Weave, Non-Metallic Aramid Fiber.

IMPORTANT:

Read all breaking strength, safety and technical data relating to this product.

Refer to pages W-33 and W-34.

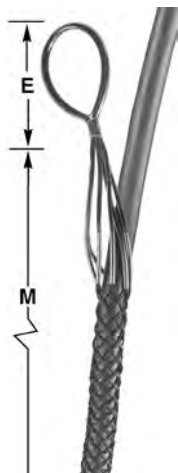

Kellems® Non-Metallic Support Grips

Kellems® Non-Metallic Support Grips, made of a high strength double weave aramid fiber, are available for supporting cable in corrosive environments.

Non-Metallic Support Grips, Single Eye, Closed Mesh

For permanent support when cable end is available to be installed through grip.

Cable Diameter Range Inches (cm)	Approx. Breaking Strength Lbs.	Working Load Lbs.	E Inches (cm)	M Inches (cm)	Color Code	Catalog Number
.50"--.62" (1.27-1.57)	1,000	100	6.0" (15.24)	22" (55.88)	Green	02601001
.63"--.74" (1.60-1.88)	2,000	200	6.0" (15.24)	24" (60.96)	Yellow	02601002
.75"--.99" (1.90-2.51)	2,000	200	6.0" (15.24)	28.5" (72.39)	Red	02601003
1.00"-1.24" (2.54-3.15)	3,000	300	6.0" (15.24)	31" (78.74)	Blue	02601004
1.25"-1.49" (3.17-3.78)	3,000	300	6.0" (15.24)	36.5" (92.71)	White	02601005
1.50"-1.99" (3.81-5.05)	3,000	300	6.0" (15.24)	40" (101.60)	Pink	02601006

Note: Specified for corrosive applications.

Heavy Duty Support Grips

Single Eye, Double Weave, Tin-Coated Bronze and Stainless Steel

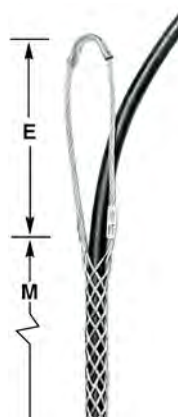

Heavy Duty, Single Eye, Closed Mesh

For heavy duty permanent support when cable end is available to be installed through grip.

Cable Diameter Range Inches (cm)	Approx. Breaking Strength Lbs.		Working Load Lbs.		E Inches (cm)	M Inches (cm)	Tin-Coated Bronze	Stainless Steel
	Tin-Coated Bronze	Stainless Steel	Tin-Coated Bronze	Stainless Steel				
.75"--.99" (1.90-2.51)	2,820	4,200	282	420	10" (25.40)	25" (63.50)	02206010	02406010
1.00"-1.24" (2.54-3.15)	4,280	7,300	428	730	12" (30.48)	28" (71.12)	02206011	02406011
1.25"-1.49" (3.17-3.78)	4,280	7,300	428	730	12" (30.48)	30" (76.20)	02206012	02406012
1.50"-1.99" (3.81-5.05)	4,280	11,150	428	1,115	12" (30.48)	34" (86.36)	02206013	02406013



Single Eye, Split Mesh, Lace Closing

For permanent support when cable end is not available to be installed through grip.

Cable Diameter Range Inches (cm)	Approx. Breaking Strength Lbs. (N)		Working Load Lbs.		E Inches (cm)	M Inches (cm)	Tin-Coated Bronze	Stainless Steel
	Tin-Coated Bronze	Stainless Steel	Tin-Coated Bronze	Stainless Steel				
.75"--.99" (1.90-2.51)	2,820	4,200	282	420	10" (25.40)	25" (63.50)	02207010	02407010
1.00"-1.24" (2.54-3.15)	4,280	7,300	428	730	12" (30.48)	28" (71.12)	02207011	02407011
1.25"-1.49" (3.17-3.78)	4,280	7,300	428	730	12" (30.48)	30" (76.20)	02207012	02407012
1.50"-1.99" (3.81-5.05)	4,280	11,150	428	1,115	12" (30.48)	34" (86.36)	02207013	02407013

Note: E-Eye length. M-Mesh length at nominal diameter.

Dimensions in Inches (mm)

Heavy Duty Support Grips

Double Eye, Double Weave, Tin-Coated Bronze and Stainless Steel.

IMPORTANT:
Read all breaking strength, safety and technical data relating to this product.

Refer to pages W-33 and W-34.

Double Eye, Closed Mesh

For permanent support when cable end is available to be installed through grip.

Cable Diameter Range Inches (cm)	Approx. Breaking Strength Lbs. (N)		Working Load Lbs.		E Inches (cm)	M Inches (cm)	Tin-Coated Bronze	Stainless Steel
	Tin-Coated Bronze	Stainless Steel	Tin-Coated Bronze	Stainless Steel				
.75"-1.99" (1.90-2.51)	2,820	4,250	282	425	10" (25.40)	25" (63.50)	02206001	02406001
1.00"-1.24" (2.54-3.15)	4,280	7,300	428	730	10" (25.40)	28" (71.12)	02206002	02406002
1.25"-1.49" (3.17-3.78)	4,280	7,300	428	730	10" (25.40)	30" (76.20)	02206003	02406003
1.50"-1.99" (3.81-5.05)	4,280	11,100	428	1,110	10" (25.40)	34" (86.36)	02206004	02406004
2.00"-2.49" (5.08-6.32)	8,050	20,100	805	2,010	12" (30.48)	36" (91.44)	02206005	02406005
2.50"-2.99" (6.35-7.59)	8,050	20,100	805	2,010	12" (30.48)	38" (96.52)	02206006	02406006
3.00"-3.49" (7.62-8.86)	10,060	25,200	1,006	2,520	12" (30.48)	40" (101.60)	02206007	02406007
3.50"-3.99" (8.89-10.13)	12,070	—	1,207	—	12" (30.48)	44" (111.76)	02206008	—
4.00"-4.49" (10.16-11.40)	12,070	—	1,207	—	12" (30.48)	46" (116.84)	02206009	—
4.50"-4.99" (11.43-12.67)	12,070	—	1,207	—	12" (30.48)	68" (172.72)	02208009	—

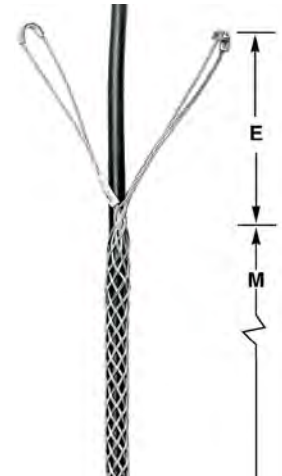

Double Eye, Split Mesh, Lace Closing

For support when cable end is not available.

Cable Diameter Range Inches (cm)	Approx. Breaking Strength Lbs. (N)		Working Load Lbs.		E Inches (cm)	M Inches (cm)	Tin-Coated Bronze	Stainless Steel
	Tin-Coated Bronze	Stainless Steel	Tin-Coated Bronze	Stainless Steel				
.75"-1.99" (1.90-2.51)	2,820	4,250	282	425	10" (25.40)	25" (63.50)	02207001	02407001
1.00"-1.24" (2.54-3.15)	4,280	7,300	428	730	10" (25.40)	28" (71.12)	02207002	02407002
1.25"-1.49" (3.17-3.78)	4,280	7,300	428	730	10" (25.40)	30" (76.20)	02207003	02407003
1.50"-1.99" (3.81-5.05)	4,280	11,150	428	1,110	10" (25.40)	34" (86.36)	02207004	02407004
2.00"-2.49" (5.08-6.32)	8,050	20,150	805	2,010	12" (30.48)	36" (91.44)	02207005	02407005
2.50"-2.99" (6.35-7.59)	8,050	20,150	805	2,010	12" (30.48)	38" (96.52)	02207006	02407006
3.00"-3.49" (7.62-8.86)	10,060	25,200	1,006	2,520	12" (30.48)	40" (101.60)	02207007	02407007
3.50"-3.99" (8.89-10.13)	12,070	30,200	1,207	3,020	12" (30.48)	44" (111.76)	02207008	02407008
4.00"-4.49" (10.16-11.40)	12,070	30,200	1,207	3,020	12" (30.48)	46" (116.84)	02207009	02407009
4.50"-4.99" (11.43-12.67)	12,070	—	1,207	—	12" (30.48)	68" (172.72)	02209009	—

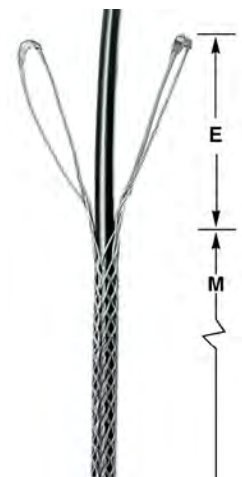

Note: E-Eye length. M-Mesh length at nominal diameter.

Dimensions in Inches (mm)

Service Drop Grips

Single Eye, Tin-Coated Bronze and Stainless Steel.

IMPORTANT:
Read all breaking strength, safety and technical data relating to this product.

Refer to pages W-33 and W-34.

Light Duty, Single Eye, Closed Mesh, Single Weave

For permanent support when cable end is available to be installed.



Cable Diameter Range Inches (cm)	Approx. Breaking Strength Lbs.		Working Load Lbs.		E Inches (cm)	M Inches (cm)	Tin-Coated Bronze	Stainless Steel
	Tin-Coated Bronze	Stainless Steel	Tin-Coated Bronze	Stainless Steel				
.23"-.31" (.58-.79)	290	700	29	70	3" (7.62)	3.75" (9.52)	02216001	02416001
.29"-.37" (.74-.94)	290	700	29	70	5" (12.70)	4.25" (10.79)	02216002	02416002
.35"-.44" (.89-1.12)	500	850	50	85	5.5" (13.97)	4.75" (12.06)	02216003	02416003
.41"-.50" (1.04-1.27)	500	850	50	85	5.5" (13.97)	5" (12.70)	02216004	02416004
.46"-.56" (1.17-1.42)	660	850	66	85	6" (15.24)	5.25" (13.33)	02216005	02416005
.52"-.62" (1.32-1.57)	790	1,050	79	105	7" (17.78)	6.25" (15.87)	02216006	02416006
.58"-.68" (1.47-1.73)	790	1,050	79	105	7" (17.78)	6" (15.24)	02216007	02416007
.64"-.75" (1.63-1.90)	790	1,050	79	105	7" (17.78)	6.75" (17.14)	02216008	02416008
.70"-.81" (1.78-2.06)	790	2,050	79	205	7" (17.78)	7.25" (18.41)	02216009	02416009
.75"-.87" (1.90-2.21)	1,020	2,050	102	205	8" (20.32)	8" (20.32)	02216010	02416010
.81"-.94" (2.06-2.39)	1,020	2,050	102	205	8" (20.32)	8.25" (20.95)	02216011	02416011
.87"-1.00" (2.21-2.54)	1,020	—	102	—	8" (20.32)	8.75" (22.22)	02216012	—
.94"-1.06" (2.39-2.69)	1,020	2,050	102	205	9" (22.86)	9" (22.86)	02216013	02416013
1.00"-1.18" (2.54-3.00)	1,020	2,050	102	205	9" (22.86)	9.5" (24.13)	02216014	02416014
1.06"-1.25" (2.69-3.17)	1,020	2,050	102	205	9" (22.86)	9.5" (24.13)	02216015	02416015

Heavy Duty, Single Eye, Closed Mesh, Multi-Weave

For permanent support when cable end is available to be installed.



Cable Diameter Range Inches (cm)	Approx. Breaking Strength Lbs.		Working Load Lbs.		E Inches (cm)	M Inches (cm)	Tin-Coated Bronze	Stainless Steel
	Tin-Coated Bronze	Stainless Steel	Tin-Coated Bronze	Stainless Steel				
.23"-.31" (.58-.79)	500	1,400	50	140	5" (12.70)	4.5" (11.43)	02217001	02417001
.29"-.37" (.74-.94)	500	1,150	50	115	5" (12.70)	5.5" (13.97)	02217002	02417002
.35"-.44" (.89-1.12)	870	1,700	87	170	6" (15.24)	6.5" (16.51)	02217003	02417003
.41"-.50" (1.04-1.27)	870	1,700	87	170	6" (15.24)	7.5" (19.05)	02217004	02417004
.46"-.56" (1.17-1.42)	1,050	2,100	105	210	6" (15.24)	8" (20.32)	02217005	02417005
.52"-.62" (1.32-1.57)	1,050	2,100	105	210	7" (17.78)	8.5" (21.59)	02217006	02417006
.58"-.68" (1.47-1.73)	1,050	2,100	105	210	7" (17.78)	9.5" (24.13)	02217007	02417007
.64"-.75" (1.63-1.90)	1,390	4,161	139	416	7" (17.78)	9.5" (24.13)	02217008	02417008
.70"-.81" (1.78-2.06)	1,390	4,100	139	410	8" (20.32)	10.5" (26.67)	02217009	02417009
.75"-.87" (1.90-2.21)	1,390	—	139	—	8" (20.32)	10.5" (26.67)	02217010	—
.81"-.94" (2.06-2.39)	1,390	—	139	—	8" (20.32)	10.5" (26.67)	02217011	—
.87"-1.00" (2.21-2.54)	1,790	5,350	179	535	8" (20.32)	11.5" (29.21)	02217012	02417012
.94"-1.06" (2.39-2.69)	1,790	5,300	179	530	9" (22.86)	12.5" (31.75)	02217013	02417013
1.00"-1.18" (2.54-3.00)	1,790	5,300	179	530	9" (22.86)	13.5" (34.29)	02217014	02417014
1.06"-1.25" (2.69-3.17)	1,790	5,350	179	535	9" (22.86)	14.5" (36.83)	02217015	02417015

Note: E-Eye length. M-Mesh length at nominal diameter.

Screw Hook
Catalog Number **20303001**
Yield Strength 900 lbs (4003 N)

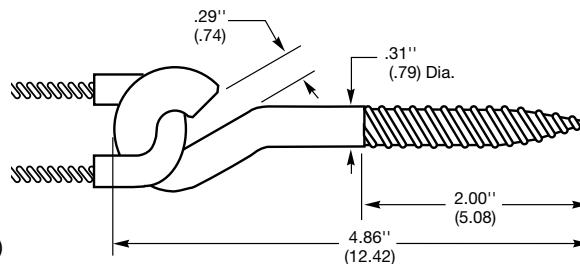

Dimensions in Inches (mm)

Service Drop Grips

Universal Eye, Tin-Coated Bronze.

IMPORTANT:
Read all breaking strength, safety and technical data relating to this product.

Refer to pages W-33 and W-34.

Light Duty, Universal Eye, Closed Mesh, Single Weave

For permanent support when cable end is available to be installed.

Cable Diameter Range Inches (cm)	Approx. Breaking Strength Lbs.	Working Load Lbs.	E Inches (cm)	M Inches (cm)	Catalog Number
.23"-.31" (.58-.79)	290	29	9" (22.86)	3.75" (9.52)	02216016
.29"-.37" (.74-.94)	290	29	10" (25.40)	4.25" (10.79)	02216017
.35"-.44" (.89-1.12)	500	50	10" (25.40)	4.75" (12.06)	02216018
.41"-.50" (1.04-1.27)	500	50	11" (27.94)	5" (12.70)	02216019
.46"-.56" (1.17-1.42)	660	66	12" (30.48)	5.25" (13.33)	02216020
.52"-.62" (1.32-1.57)	790	79	13" (33.02)	6.25" (15.87)	02216021
.58"-.68" (1.47-1.73)	790	79	13" (33.02)	6.5" (16.51)	02216022
.64"-.75" (1.63-1.90)	790	79	13" (33.02)	6.75" (17.14)	02216023
.70"-.81" (1.78-2.06)	790	79	13" (33.02)	7.25" (18.41)	02216024
.75"-.87" (1.90-2.21)	1,020	102	14" (35.56)	8" (20.32)	02216025
.81"-.94" (2.06-2.39)	1,020	102	14" (35.56)	8.25" (20.95)	02216026
.87"-1.00" (2.21-2.54)	1,020	102	14" (35.56)	8.75" (22.22)	02216027
.94"-1.06" (2.39-2.69)	1,020	102	15" (38.10)	9" (22.86)	02216028
1.00"-1.18" (2.54-3.00)	1,020	102	15" (38.10)	9.5" (24.13)	02216029
1.06"-1.25" (2.69-3.17)	1,020	102	15" (38.10)	9.5" (24.13)	02216030



Heavy Duty, Universal Eye, Closed Mesh, Multi-Weave

For permanent support when cable end is available to be installed.

Cable Diameter Range Inches (cm)	Approx. Breaking Strength Lbs.	Working Load Lbs.	E Inches (cm)	M Inches (cm)	Catalog Number
.23"-.31" (.58-.79)	500	50	11" (27.94)	4.5" (11.43)	02217016
.28"-.37" (.74-.94)	500	50	11" (27.94)	5.5" (13.97)	02217017
.35"-.44" (.89-1.12)	870	87	12" (30.48)	6.5" (16.51)	02217018
.41"-.50" (1.04-1.27)	870	87	12" (30.48)	7.5" (19.05)	02217019
.46"-.56" (1.17-1.42)	1,050	105	12" (30.48)	8" (20.32)	02217020
.52"-.62" (1.32-1.57)	1,050	105	13" (33.02)	8.5" (21.59)	02217021
.58"-.68" (1.47-1.73)	1,050	105	13" (33.02)	9.5" (24.13)	02217022
.64"-.75" (1.63-1.90)	1,390	139	13" (33.02)	9.5" (24.13)	02217023
.70"-.81" (1.78-2.06)	1,390	139	14" (35.56)	10.5" (26.67)	02217024
.75"-.87" (1.90-2.21)	1,390	139	14" (35.56)	10.5" (26.67)	02217025
.81"-.94" (2.06-2.39)	1,390	139	14" (35.56)	10.5" (26.67)	02217026
.87"-1.00" (2.21-2.54)	1,790	179	14" (35.56)	11.5" (29.21)	02217027
.94"-1.06" (2.39-2.69)	1,790	179	15" (38.10)	12.5" (31.75)	02217028
1.00"-1.18" (2.54-3.00)	1,790	179	15" (38.10)	13.5" (34.29)	02217029
1.06"-1.25" (2.69-3.17)	1,790	179	15" (38.10)	14.5" (36.83)	02217030



Note: E-Eye length. M-Mesh length at nominal diameter.

Dimensions in Inches (mm)

Bus Drop Support Grips

Single Eye, Universal Eye, Galvanized Steel.

IMPORTANT:

Read all breaking strength, safety and technical data relating to this product.

Refer to pages W-33 and W-34.



Safety Spring

Maximum Deflection Inches/Lbs (cm/N)	Approx. Breaking Strength Lbs.	Working Load Lbs.	Length* Inches (cm)	Diameter Inches (cm)	Model Lbs. (N)	Catalog Number
2¾" at 40 lbs. (6.98 at 178)	500	50	8.25" (20.95)	.75" (1.90)	40 lb. spring (178)	20302001
3⅞" at 80 lbs. (7.94 at 356)	850	85	8.25" (20.95)	1" (2.54)	80 lb. spring (356)	20302002

Note: Springs can be used with single eye grips by disassembling drawbar from coil, placing through eye and replacing drawbar.
*No load.



Single Eye, Wide Range

Cable Diameter Range Inches (cm)	Approx. Breaking Strength Lbs.	Working Load Lbs.	E Inches (cm)	M Inches (cm)	Catalog Number
.24"- .32" (.61-.81)	350	35	3" (7.62)	3.5" (8.89)	073041276**
.32"- .43" (.81-1.09)	450	45	4" (10.16)	4" (10.16)	073041277
.43"- .56" (1.09-1.42)	550	55	6" (15.24)	4.75" (12.06)	073041278
.56"- .73" (1.42-1.85)	1,000	100	7" (17.78)	6" (15.24)	073041279
.73"- .85" (1.85-2.16)	1,400	140	7" (17.78)	6.75" (17.14)	073041280
.85"-1.00" (2.16-2.54)	1,400	140	8" (20.32)	8" (20.32)	073041281
1.00"-1.25" (2.54-3.17)	1,500	150	9" (22.86)	9.5" (24.13)	073041282



Universal Eye, Wide Range

Cable Diameter Range Inches (cm)	Approx. Breaking Strength Lbs.	Working Load Lbs.	E Inches (cm)	M Inches (cm)	Catalog Number
.32"- .43" (.81-1.09)	450	45	10" (25.40)	4" (10.16)	073041284
.43"- .56" (1.09-1.42)	550	55	12" (30.48)	4.75" (12.06)	073041285
.56"- .73" (1.42-1.85)	1,000	100	13" (33.02)	6" (15.24)	073041286
.73"- .85" (1.85-2.16)	1,400	140	13" (33.02)	6.75" (17.14)	073041287
.85"-1.00" (2.16-2.54)	1,400	140	14" (35.56)	8" (20.32)	073041288
1.00"-1.25" (2.54-3.17)	1,500	150	15" (38.10)	9.5" (24.13)	073041289

Note: E-Eye length. M-Mesh length at nominal diameter.
**Item indicated is not UL listed.

Bus Drop Grips and Safety Springs

Kellems Bus Drop Grips are offered with either a single eye or universal bale attachment. The mesh is single weave galvanized steel with the patented wide range construction. They are suitable for indoor use only. Consult Technical Service for Stainless Steel Grips.

Application

Bus Drop Grips provide a safe, easy and economical method to support flexible cord or bus drop cable at bus duct and other industrial areas.

Benefits

- Easily installed
- Absorb tension, vibration and pull with no cable damage
- Patented mesh construction

Safety Spring

Springs can be used with single eye grips by disassembling drawbar from coil, placing through eye and replacing drawbar.

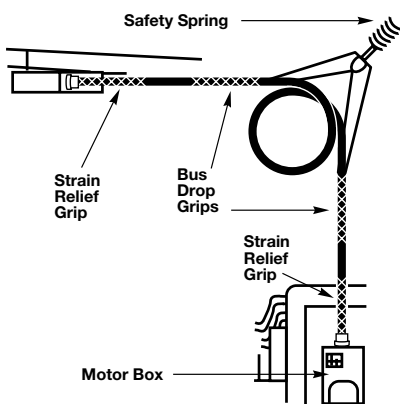

Dimensions in Inches (mm)

Conduit Riser Grips

Single Weave, Closed Mesh

Kellems® Conduit Riser Support Grips are available in closed mesh and in split mesh with lace or rod closures, to cover all applications including single cable or multiple wire support. Refer to page W-37 for grip selection assistance for cable bundles. The standard material is tin-coated bronze strand. The grip is permanently fastened to a support ring, resulting in a one piece unit which will allow air ventilation within the conduit. The ring will fit standard electrical rigid metal conduit and schedule 40 rigid PVC conduit only. See page W-32 for ring dimensions. For permanent support when cable end is available to be installed through the grip.

IMPORTANT:
Read all breaking strength, safety and technical data relating to this product.

Refer to pages W-33 and W-34.



IMPORTANT:
Recommended safety factor is ten for catalog listed support grips.

Suitable for Standard Electrical Rigid Metal Conduit and Schedule 40 Rigid PVC Conduit Only

Cable Sizes In. (cm)	.50"-.62" (1.27-1.57)	.63"-.74" (1.60-1.88)	.75"-.99" (1.90-2.51)	1.00"-1.24" (2.54-3.15)	1.25"-1.49" (3.17-3.78)	1.50"-1.74" (3.81-4.42)	1.75"-1.99" (4.44-5.05)	2.00"-2.49" (5.08-6.32)	2.50"-2.99" (6.35-7.59)	3.00"-3.49" (7.62-8.86)	3.50"-3.99" (8.89-10.13)
Model	R050	R062	R075	R100	R125	R150	R175	R200	R250	R300	R350
Length In. (cm)	8" (20.32)	9" (22.86)	11" (27.94)	12" (30.48)	12" (30.48)	14" (35.56)	15" (38.10)	17" (43.18)	18" (45.72)	20" (50.80)	21" (53.34)
Conduit Sizes											
Inches	Catalog Number Approx. Breaking Strength Lbs. (N)										
¾	02211106 530 (2,357)	—	—	—	—	—	—	—	—	—	—
1	02211100 490 (2,179)	02211101 790 (3,514)	—	—	—	—	—	—	—	—	—
1¼	02211001 450 (2,002)	02211002 740 (3,292)	02211003 1,030 (4,581)	—	—	—	—	—	—	—	—
1½	—	02211006 690 (3,069)	02211007 970 (4,315)	02211009 1,610 (7,161)	—	—	—	—	—	—	—
2	—	02211107 640 (2,847)	02211010 920 (4,092)	02211012 1,520 (6,761)	02211013 1,610 (7,161)	—	—	—	—	—	—
2½	—	—	—	—	02211017 1,510 (6,716)	02211018 1,610 (7,161)	02211019 2,150 (9,563)	—	—	—	—
3	—	—	—	02211022 1,340 (5,960)	02211023 1,400 (6,227)	02211024 1,490 (6,627)	02211025 1,990 (8,851)	02211026 3,260 (14,500)	—	—	—
3½	—	—	—	—	—	—	—	02211033 2,970 (13,211)	02211034 3,260 (14,500)	—	—
4	—	—	—	—	—	—	02211040 1,670 (7,248)	02211041 2,680 (11,921)	02211042 2,890 (12,855)	02211043 4,080 (18,148)	—
5	—	—	—	—	—	—	—	—	02211061 2,150 (9,563)	02211062 2,860 (12,721)	02211063 3,130 (13,922)
6	—	—	—	—	—	—	—	—	—	02211072 2,245 (9,986)	02211073 2,245 (9,986)

Note: See page W-37 for multiple cables in a single conduit riser grip.

Dimensions in Inches (mm)

Conduit Riser Grips

Double Weave, Split Mesh, Lace Closing

Kellems® Conduit Riser Support Grips will support cable runs in vertical or sloping standard rigid conduit. The grip is fastened to a support ring which seats on the rim of the conduit. The entire grip is supported by the conduit itself and no other hardware is required. See page W-32 for ring dimensions. The rings will fit schedule 40 rigid PVC conduit and standard electrical rigid metal conduit only. For permanent support when cable end is not available.

IMPORTANT:

Read all breaking strength, safety and technical data relating to this product.

Refer to pages W-33 and W-34.



IMPORTANT:

Recommended safety factor is ten for catalog listed support grips.

Suitable for Standard Electrical Rigid Metal Conduit and Schedule 40 Rigid PVC Conduit Only

Cable Sizes In. (cm)	.75"- .99" (1.90-2.51)	1.00"- 1.24" (2.54-3.15)	1.25"- 1.49" (3.17-3.78)	1.50"-1.74" (3.81-4.42)	1.75"- 1.99" (4.44-5.05)	2.00"- 2.49" (5.08-6.32)	2.50"- 2.99" (6.35-7.59)	3.00"- 3.49" (7.62-8.86)	3.50" -3.99" (8.89-10.13)
----------------------	---------------------------	-----------------------------	-----------------------------	----------------------------	-----------------------------	-----------------------------	-----------------------------	-----------------------------	------------------------------

Model	RS075	RS100	RS125	RS150	RS175	RS200	RS250	RS300	RS350
Length In. (cm)	11" (27.94)	12" (30.48)	12" (30.48)	14" (35.56)	15" (38.10)	17" (43.18)	18" (45.72)	20" (50.80)	21" (53.34)

Conduit Sizes Inches	Catalog Number		Approx. Breaking Strength Lbs. (N)						
1¼	02212003 1,580 (7,028)	—	—	—	—	—	—	—	—
1½	02212007 1,500 (6,672)	—	—	—	—	—	—	—	—
2	02212010 1,430 (6,361)	02212012 1,930 (8,585)	02212013 2,040 (9,074)	—	—	—	—	—	—
2½	—	—	02212017 1,910 (8,496)	02212018 2,040 (9,074)	—	—	—	—	—
3	—	—	02212023 1,780 (7,917)	02212024 1,890 (8,407)	02212025 2,520 (11,209)	02212026 4,300 (19,126)	—	—	—
3½	—	—	—	—	—	02212033 3,910 (17,392)	02212034 4,300 (19,126)	—	—
4	—	—	—	—	02212040 2,110 (9,385)	02212041 3,530 (15,701)	02212042 3,820 (16,991)	02212043 5,380 (23,930)	—
5	—	—	—	—	—	—	02212061 2,860 (12,721)	—	—
6	—	—	—	—	—	—	—	—	02212073 2,955 (13,144)

Note: See page W-37 for multiple cables in a single conduit riser grip.

Dimensions in Inches (mm)

Conduit Riser Grips

Single Weave, Split Mesh, Rod Closing

- Easy and fast to install
- Will not damage electrical cable
- Allows cable to expand or contract
- Ideal way to hold cable in vertical conduit
- Prevents cable creep in conduit
- Helps prevent cable pullouts
- The rings will fit schedule 40 rigid PVC conduit and standard electrical rigid metal conduit only
- For support when cable end is not available

IMPORTANT:
Read all breaking strength, safety and technical data relating to this product.

Refer to pages W-33 and W-34.



IMPORTANT:
Recommended safety factor is ten for catalog listed support grips.

Suitable for Standard Electrical Rigid Metal Conduit and Schedule 40 Rigid PVC Conduit Only

Cable Sizes In. (cm)	.75"-.99" (1.90-2.51)	1.00"-1.24" (2.54-3.15)	1.25"-1.49" (3.17-3.78)	1.50"-1.74" (3.81-4.42)	1.75"-1.99" (4.44-5.05)	2.00"-2.49" (5.08-6.32)	2.50"-2.99" (6.35-7.59)	3.00"-3.49" (7.62-8.86)	3.50"-3.99" (8.89-10.13)
Model	RR075	RR100	RR125	RR150	RR175	RR200	RR250	RR300	RR350
Length In. (cm)	11" (27.94)	12" (30.48)	12" (30.48)	14" (35.56)	15" (38.10)	17" (43.18)	18" (45.72)	20" (50.80)	21" (53.34)
Conduit Sizes Inches	Catalog Number		Approx. Breaking Strength Lbs. (N)						
1¼	02213003 1,020 (4,537)	—	—	—	—	—	—	—	—
1½	02213007 970 (4,315)	02213009 1,610 (7,161)	—	—	—	—	—	—	—
2	—	02213012 1,520 (6,761)	02213013 1,610 (7,161)	—	—	—	—	—	—
2½	—	—	02213017 1,510 (6,716)	02213018 1,610 (7,161)	—	—	—	—	—
3	—	—	02213023 1,400 (6,227)	02213024 1,490 (6,627)	02213025 1,990 (8,851)	02213026 3,260 (14,500)	—	—	—
3½	—	—	—	—	—	02213033 2,970 (13,211)	—	—	—
4	—	—	—	—	—	02213041 2,670 (11,876)	02213042 2,890 (12,855)	—	—

Note: See page W-37 for multiple cables in a single conduit riser grip.

Dimensions in Inches (mm)

Conduit Ring Dimensions

Ring dimensions are found in the chart below. The ring material is corrosion resistant. These rings will fit schedule 40 rigid PVC conduit and standard electrical rigid metal conduit only.

IMPORTANT:

Read all breaking strength, safety and technical data relating to this product.

Refer to pages W-33 and W-34.

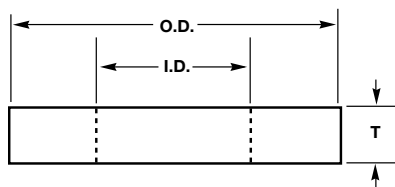

Conduit Size 3/4" and 1"

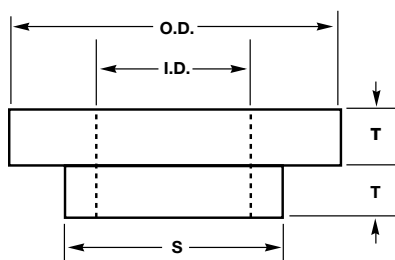

Conduit Size 1 1/4" to 6"

Conduit Size Inches	Ring Number	O.D. Inches (cm)	I.D. Inches (cm)	S Inches (cm)	T Inches (cm)
3/4	C-3/4	.94" (2.39)	.62" (1.57)	—	.19" (.48)
1	C-1	1.17" (2.97)	.80" (2.03)	—	.19" (.48)
1 1/4	C-1 1/4	1.50" (3.81)	1.03" (2.62)	1.31" (3.33)	.16" (.41)
1 1/2	C-1 1/2	1.76" (4.47)	1.23" (3.12)	1.52" (3.86)	.16" (.41)
2	C-2	2.23" (5.66)	1.55" (3.94)	1.97" (5.00)	.16" (.41)
2 1/2	C-2 1/2	2.67" (6.78)	2.05" (5.21)	2.40" (6.10)	.16" (.41)
3	C-3	3.20" (8.13)	2.55" (6.48)	2.97" (7.54)	.22" (.56)
3 1/2	C-3 1/2	3.80" (9.65)	3.05" (7.75)	3.47" (8.81)	.22" (.56)
4	C-4	4.30" (10.92)	3.55" (9.02)	3.94" (10.01)	.22" (.56)
4 1/2	C-4 1/2	4.80" (12.19)	4.03" (10.24)	4.45" (11.30)	.22" (.56)
5	C-5	5.30" (13.46)	4.46" (11.33)	4.96" (12.60)	.22" (.56)
6	C-6	6.30" (16.00)	5.36" (13.61)	5.96" (15.14)	.25" (.63)

Kellems® Support Grips

Kellems Support Grips are used to hold the weight of electrical cable as it hangs in a vertical, sloping or horizontal position. Electrical cable must be supported, or its dead weight can cause excessive strain or pullout at the connections resulting in power failure. Support grips also absorb additional strain from flexure, vibration, expansion and contraction. Kellems Support Grips listed in this catalog are made of high grade, non-magnetic tin-coated bronze strand. Stainless steel grips, made of alloy 302–304 SST for severe service or unusual environmental conditions, are available on request.

Select the Correct Support Grip

Each Kellems grip is designed to work on a specific range of cable diameters.

- Step 1** Refer to the Kellems chart below to determine the grip style best suited for your application.
- Step 2** Determine your cable outside diameter.
- Step 3** Find the grip size that encompasses your cable diameter.
- Step 4** Whenever possible, use a closed mesh that assembles over the cable end. If the cable end is not available, use a split mesh.
- Step 5** Where available, select an eye style that suits your needs.
- Step 6** Select the proper material—tinned bronze or stainless steel*.
- Step 7** Estimate the tension to be put on the grip, establish the working load you require and compare this to the listed approximate breaking strength of the grip to insure that the grip will be strong enough. Refer to page W-34 for safety and working load considerations.

WARNING: It is very important to read and understand all safety information before proceeding. Failure to use as directed may result in property damage, personal injury or death.

Grips are to be installed and utilized by a qualified technician in accordance with all applicable national and local safety and electrical codes. Consult a licensed project safety professional, if necessary.

Ensure that the correct grip is selected for your specific needs. Grips should only be used for their intended purpose and not for other applications.

Banding the tail end of the grip is required to prevent unintended release of the grip's hold from the cable and to achieve maximum gripping strength

The strength of a Kellems grips is based on laboratory testing and does not evaluate variable conditions such as cable type, gripping surfaces, cable movement or impact loads. Suitability for the application must be determined by the user.

Thoroughly examine the condition of the grip prior to each use. Grips that are worn, bent, corroded, or show other signs of damage, such as frayed or broken wires, should never be used and must be replaced.

Do not modify the grip in any way.

Ensure that the recommended work load of the grip is suitable for the application. Never use a grip beyond its safe working load, which is the approximate breaking strength divided by the factor of safety. The recommended factor of safety is five (5) for pulling grips and ten (10) for support grips.

Pulling hardware should only be attached to the eye of the grip.

A swivel is recommended for attachment to the grip's eye in applications where torque release is necessary. Torque can build up in high tension pulling applications.

Do not run grips and swivels around sheaves or bull wheels while under tension. For synthetic rope, use Kellems Dua-Pull Grips only.

Support Grip Selection Chart

Grip Styles	Application
Closed mesh	Standard, permanent support, cable end available.
Split lace closing	Standard, permanent support, cable end unavailable.
Split rod closing	Standard, temporary support, cable end unavailable. Tape or band tail end of wire mesh grip after positioning for permanent support.
Material*	Tin-coated bronze standard or stainless steel by special request.
Standard support grips	Support vertical runs to 99 ft. loads to 600 lbs.
Heavy duty grips	Support vertical runs over 100 ft. loads over 600 lbs.
Service drop	Light duty to support service entrance cable.
Bus drop	Light duty support, indoors only, on Bus drop cable.
Conduit riser	Support cable runs in rigid (Schedule 40) conduit.
Fiber optic cable support grips	Support fiber optic cable.

Note: *Most catalog listed support grips are made of tin-coated bronze strand. To order stainless steel support grips, change the first three catalog number digits from 022-0X-xxx to 024-0X-xxx. Consult Technical Service for details.

Eye Styles



Single



Double



Universal



Offset

Safety and Working Load Factors for Wire Mesh Grips

The broad application of Kellems grips on a wide variety of objects requires that adequate safety factors be used to establish working loads. The approximate breaking strength of a Kellems grip represents an average calculation based on data established from actual direct tension testing done in our engineering laboratories.

It is impossible to catalog or guarantee a safety factor suitable for all applications as operating conditions are never the same. The tension, diameter, movement, number of objects gripped, gripping surface, and the attachments used are just some of the factors which vary with each application. These factors, together with the effects of abrasion, corrosion, prior use or abuse and any other variables of a specific application, must be considered by the user and the grip replaced as appropriate. Where the

conditions of the application are not well defined or known, or where risk of injury to persons or property is involved, a greater safety factor should be utilized.

IMPORTANT:

Under normal conditions, Kellems' recommended factor of safety is five for catalog listed pulling grips, and ten for catalog listed support grips.

Any warranty as to quality, performance or fitness for use of grips is always premised on the condition that the published breaking strengths apply only to new, unused grips, and that such products are properly stored, handled, used, maintained, and inspected by the user at a frequency appropriate for the use and condition of the grip.

Examples

Grip Style	Approx. Breaking Strength Lbs. (N)	Safety Factor	Max. Recommended Load Lbs. (N)	Catalog Number
Pulling Grips	27,200 (120,986)	5	5,440 (24,197)	03301027
Support Grips	1,610 (7,161)	10	161 (716)	02202019

The maximum recommended working load is the tension to be exerted on the grip in application with a margin of safety to take care of unforeseen and unusual circumstances.

It is the end-user's decision to determine how much of a safety factor is acceptable for the application.

The metric unit of measure (force) for breaking strength and load is newtons (N). To convert from newtons to the metric unit of weight (kilograms) the conversion factor is 9.808 newtons/kilogram.

Support Grip Materials

Material	Features	Grip Type
Tin-coated bronze wire	<ul style="list-style-type: none"> • Corrosion resistant for normal outside areas • Non-magnetic • Moderate strength 	<ul style="list-style-type: none"> • Support grips • Service drop grips • Conduit riser grips
Stainless steel wire (302-304)	<ul style="list-style-type: none"> • High strength • Corrosion resistant 	<ul style="list-style-type: none"> • Support grips • Hose containment grips
Galvanized steel wire	<ul style="list-style-type: none"> • Slightly magnetic • Not subject to continuous outside environment 	<ul style="list-style-type: none"> • Bus drop grips
Non-metallic aramid fiber	<ul style="list-style-type: none"> • Corrosion resistant for highly corrosive gases 	<ul style="list-style-type: none"> • Support grips

Approvals

CSA Certifications are indicated on appropriate product catalog pages.

Note: It is always recommended that the tail end of the grip be banded after the installation on the cable to prevent accidental release of the mesh. See page W-16 for end bands.

Split Support Grip Lace Closing Instructions

Single Weave Grips should be laced with single strand lacing; double weave with double strand. Lacing strands should be the same material as the grip. Kellems supplies the appropriate lacing with each grip.

1. Start the lacing at the lead or anchoring end of the grip. Thread the lacings through the first two loops of the split and pull through until the lacings are centered at this point. Lace as you would your shoe, crossing the lacings before lacing the next two loops.
2. Don't pull lacing too tight. Leave a space between adjoining loops approximately equal to the width of one diamond of the mesh.
3. Twist the lacing strands tightly together at the tail end of the grip.
4. Wrap the ends of the lacings once or twice tightly around the tail of the grip, twisting the ends together securely. Excess lace can be cut off.



Split Support Grip Rod Closing Instructions

The stainless steel rod is a precise built-in feature which makes threading easy and fast. The strands of the mesh pass around the rod and match up with the strands from the opposite direction. The rod does not touch the cable at any point and therefore cannot cut the cable. Rod Closing Grips are reusable. They may be removed and reused as many times as desired.

1. Fast to install

Wrap the grip around the cable and thread the rod through the pre-formed loops with a corkscrew motion, using the curved end of the rod to engage the loops.

2. The action required is a steady push and twist simultaneously. The fingers of the left hand are used to bring the loops together just ahead of the hook on the end of the rod.
3. To remove, simply pull the rod out.



For Support Grips Only*

Multiple Cable Selection Charts for Cables and Wires of Unequal Diameters

How to choose the correct grip size:

1. Find the Grip Circumference Range by measuring the circumference of the bundle of different diameter cables to be gripped (see illustration).
2. Divide the bundle circumference by 3.14 to determine the diameter.
3. Choose a grip offering a range of cable diameters the same as the cable diameter.

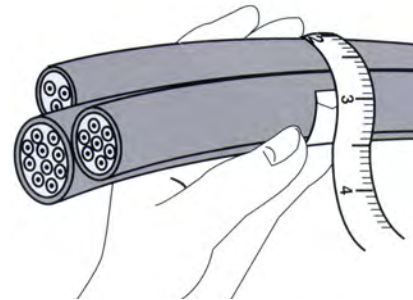

For Cables of Equal Diameters

Under "Number of Cables in One Grip", find the diameter of your single cable in vertical column. Read the grip diameter range to the right. If your diameter is the maximum of the range shown, go to the next larger size for Split Grips, stay with the same size for Closed Grips.

Example: 3 cables, each with .89" (2.26) diameter, for a Closed Grip select the 1.50"-1.74" (3.81-4.42) range, for a Split Grip select the 1.75"-1.99" (4.44-5.05) range.

Number of Cables in One Grip

2	3	4	5	6 and 7	8	9	Grip Dia. Range Inches (cm)
.30-.38 (.76-.97)	.25-.31 (.63-.79)	.22-.27 (.56-.69)	.19-.24 (.48-.61)	.17-.22 (.43-.56)	.15-.19 (.38-.48)	.14-.18 (.36-.46)	.50-.61 (1.27-1.55)
.38-.44 (.97-1.12)	.31-.36 (.79-.91)	.27-.31 (.69-.79)	.24-.29 (.61-.74)	.22-.26 (.56-.66)	.19-.23 (.48-.58)	.18-.21 (.46-.53)	.62-.74 (1.57-1.88)
.44-.59 (1.12-1.50)	.36-.49 (.91-1.24)	.31-.42 (.79-1.07)	.29-.38 (.74-.97)	.26-.34 (.66-.86)	.23-.31 (.58-.79)	.21-.28 (.53-.71)	.75-.99 (1.90-2.51)
.59-.75 (1.50-1.90)	.49-.63 (1.24-1.60)	.42-.54 (1.07-1.37)	.38-.48 (.97-1.22)	.34-.43 (.86-1.09)	.31-.39 (.79-.99)	.28-.35 (.71-.89)	1.00-1.24 (2.54-3.15)
.75-.90 (1.90-2.29)	.63-.76 (1.60-1.93)	.54-.65 (1.37-1.65)	.48-.58 (1.22-1.47)	.43-.52 (1.09-1.32)	.39-.46 (.99-1.17)	.35-.42 (.89-1.07)	1.25-1.49 (3.17-3.78)
.90-1.07 (2.29-2.72)	.76-.89 (1.93-2.26)	.65-.77 (1.65-1.96)	.58-.67 (1.47-1.70)	.52-.60 (1.32-1.52)	.46-.54 (1.17-1.37)	.42-.49 (1.07-1.24)	1.50-1.74 (3.81-4.42)
1.07-1.22 (2.72-3.10)	.89-1.02 (2.26-2.59)	.77-.88 (1.96-2.24)	.67-.77 (1.70-1.96)	.60-.69 (1.52-1.75)	.54-.62 (1.37-1.57)	.49-.56 (1.24-1.42)	1.75-1.99 (4.44-5.05)
1.22-1.53 (3.10-3.89)	1.02-1.28 (2.59-3.25)	.88-1.10 (2.24-2.79)	.77-.96 (1.96-2.44)	.69-.86 (1.75-2.18)	.62-.77 (1.57-1.96)	.56-.71 (1.42-1.80)	2.00-2.49 (5.08-6.32)
1.53-1.83 (3.89-4.65)	1.28-1.53 (3.25-3.89)	1.10-1.32 (2.79-3.35)	.96-1.16 (2.44-2.95)	.86-1.03 (2.18-2.62)	.77-.93 (1.96-2.36)	.71-.85 (1.80-2.16)	2.50-2.99 (6.35-7.59)
1.83-2.14 (4.65-5.44)	1.53-1.79 (3.89-4.55)	1.32-1.54 (3.35-3.91)	1.16-1.35 (2.95-3.43)	1.03-1.20 (2.62-3.05)	.93-1.08 (2.36-2.74)	.85-.99 (2.16-2.51)	3.00-3.49 (7.62-8.86)
2.14-2.44 (5.44-6.20)	1.79-2.05 (4.55-5.21)	1.54-1.76 (3.91-4.47)	1.35-1.54 (3.43-3.91)	1.20-1.37 (3.05-3.48)	1.08-1.24 (2.74-3.15)	.99-1.13 (2.51-2.87)	3.50-3.99 (8.89-10.13)
2.44-2.75 (6.20-6.98)	2.05-2.30 (5.21-5.84)	1.76-1.98 (4.47-5.03)	1.54-1.74 (3.91-4.42)	1.37-1.55 (3.48-3.94)	1.24-1.39 (3.15-3.53)	1.13-1.27 (2.87-3.23)	4.00-4.49 (10.16-11.40)
2.75-3.06 (6.98-7.77)	2.30-2.56 (5.84-6.50)	1.98-2.20 (5.03-5.59)	1.74-1.93 (4.42-4.90)	1.55-1.72 (3.94-4.37)	1.39-1.55 (3.53-3.94)	1.27-1.41 (3.23-3.58)	4.50-4.99 (11.43-12.67)

Note: *This chart is to be used for determining grip size when multiple cables are held in a single Support Grip. For Conduit Riser multiple cable selection, see page W-37. It is always recommended that, when multiple cables are installed in a Support Grip, the tail end of the grip be banded after installation on the cable bundle. See page Tech-23 for cable and wire charts.

For Conduit Riser Grips Only*

Multiple Cable Selection Charts for Cables and Wires of Unequal Diameters

How to choose the correct grip size:

1. Find the Grip Circumference Range by measuring the circumference of the bundle of different diameter cables to be gripped (see illustration).
2. Divide the bundle circumference by 3.14 to determine the diameter.
3. Choose a grip offering a range of cable diameters the same as the cable diameter.

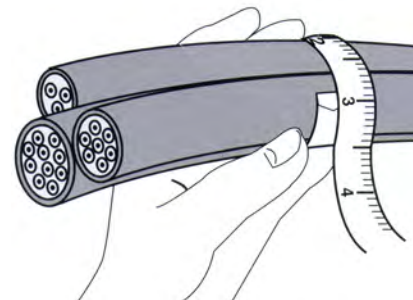

For Cables of Equal Diameters

Under "Number of Cables in One Grip", find the diameter of your single cable in vertical column. Read the grip diameter range to the right.

If your diameter is the maximum of the range shown, go to the next larger size for Split Grips, stay with the same size for Closed Grips.

Example: 3 cables, each with .85" (2.16) diameter, for a Closed Grip select the 1.50"-1.74" (3.81-4.42) range, for a Split Grip select the 1.75"-1.99" (4.44-5.05) range.

Number of Equal Diameter Cables in One Grip

2	3	4	5	6 and 7	8	9	Grip Dia. Range Inches (cm)
.29-.36 (.74-.91)	.24-.30 (.61-.76)	.21-.25 (.53-.63)	.18-.22 (.46-.56)	.16-.20 (.41-.51)	.15-.18 (.38-.46)	.14-.17 (.36-.43)	.50-.62 (1.27-1.57)
.37-.43 (.94-1.09)	.31-.36 (.79-.91)	.26-.30 (.66-.76)	.23-.27 (.58-.69)	.21-.24 (.53-.61)	.19-.22 (.48-.56)	.18-.20 (.46-.51)	.63-.74 (1.60-1.88)
.44-.58 (1.12-1.47)	.37-.48 (.94-1.22)	.31-.41 (.79-1.04)	.28-.36 (.71-.91)	.25-.32 (.63-.81)	.23-.29 (.58-.74)	.21-.27 (.53-.69)	.75-.99 (1.90-2.51)
.59-.72 (1.50-1.83)	.49-.60 (1.24-1.52)	.42-.51 (1.07-1.30)	.37-.45 (.94-1.14)	.33-.40 (.84-1.02)	.30-.36 (.76-.91)	.28-.34 (.71-.86)	1.00-1.24 (2.54-3.15)
.73-.87 (1.85-2.21)	.61-.72 (1.55-1.83)	.52-.61 (1.32-1.55)	.46-.54 (1.17-1.37)	.41-.48 (1.04-1.22)	.37-.43 (.94-1.09)	.35-.40 (.89-1.02)	1.25-1.49 (3.17-3.78)
.88-1.01 (2.24-2.57)	.73-.85 (1.85-2.16)	.62-.71 (1.57-1.80)	.55-.63 (1.40-1.60)	.49-.56 (1.24-1.42)	.44-.51 (1.12-1.30)	.41-.47 (1.04-1.19)	1.50-1.74 (3.81-4.42)
1.02-1.16 (2.59-2.95)	.86-.96 (2.18-2.44)	.72-.81 (1.83-2.06)	.64-.72 (1.63-1.83)	.57-.64 (1.45-1.63)	.52-.58 (1.32-1.49)	.48-.54 (1.22-1.37)	1.75-1.99 (4.44-5.05)
1.17-1.44 (2.97-3.66)	.97-1.20 (2.46-3.05)	.82-1.02 (2.08-2.59)	.73-.90 (1.85-2.29)	.65-.80 (1.65-2.03)	.59-.72 (1.50-1.83)	.55-.67 (1.40-1.70)	2.00-2.49 (5.08-6.32)
1.45-1.73 (3.68-4.39)	1.21-1.45 (3.07-3.68)	1.03-1.22 (2.62-3.10)	.91-1.08 (2.31-2.74)	.81-.96 (2.06-2.44)	.73-.87 (1.85-2.21)	.68-.81 (1.73-2.06)	2.50-2.99 (6.35-7.59)
1.74-2.02 (4.42-5.13)	1.46-1.69 (3.71-4.29)	1.23-1.43 (3.12-3.63)	1.09-1.26 (2.77-3.20)	.97-1.11 (2.46-2.82)	.83-1.01 (2.11-2.57)	.82-.94 (2.08-2.39)	3.00-3.49 (7.62-8.86)
2.03-2.31 (5.16-5.87)	1.70-1.93 (4.32-4.90)	1.44-1.63 (3.66-4.14)	1.27-1.44 (3.23-3.66)	1.12-1.27 (2.84-3.23)	1.02-1.15 (2.59-2.92)	.95-1.08 (2.41-2.74)	3.50-3.99 (8.89-10.13)

Note: *This chart is to be used for determining grip size when multiple cables are held in a single Conduit Riser Grip. For Support Grip multiple cable selection, see page W-36. It is always recommended that, when multiple cables are installed in a Conduit Riser Grip, the tail end of the grip be banded after installation on the cable bundle. See page Tech-23 for cable and wire charts.

Kellems® Wire Management Products

Features and Benefits

Fiber Optic Pulling Grips

Kellems has wide experience with grips for use with fiber optic cable. As the industry leader in producing wire mesh grips for the stringent requirements of fiber optic applications, Kellems has developed several series of grips for use with fiber optic communications cable.

These grips include pulling grips with built in swivels, grips with steel ends to protect fragile cable ends, grips with low profiles to pull cables in tight places and the OPTISOK® an effective tool to place pre-terminated cables. Also available are grips to support fiber optic cable.



Non-Metallic

- OPTISOK® non-metallic fiber optic pulling tool for pre-terminated, inside plant fiber optic cables and bundles of twisted pair



Comprehensive Offering

- Hubbell offers a full line of fiber optic pulling grips for all application needs
- OPTISOK® Grip is a revolutionary tool to pull pre-terminated fiber optic cables
- They will protect the connectors and guide the bundle through the pulling environment



Galvanized Steel

- Kellems flexible eye pulling grips for fiber optic cable are used for the installation of fiber optic communication lines either underground, overhead, through conduit or through enclosures
- They will fit single cables or cable bundles, are easily installed on the cable and are reusable

OPTISOK® Non-Metallic Fiber Optic Pulling Tool for Pre-Terminated, Inside Plant Fiber Optic Cables and Bundles of Twisted Pair

Kellems offers a unique and simple to use tool for the installation of pre-connectorized fiber optic cables, jumpers and bundles of twisted pair communication cables - the OPTISOK®.

The OPTISOK® is a highly flexible and expandable non-metallic sleeve open on one end and with a pulling ring on the other. It will expand to enclose the larger group of fiber optic connectors and grab the cable below the connector bundle by wrapping and taping to provide a gripping tool that will grab the cable(s) below the connectors. The pulling ring can be attached to a pulling line or fish tape and the OPTISOK® will act as the pulling tool.

OPTISOK® will contain and protect the connector bundle and save time and labor by making the pulling job easier, protecting the connectors from possible damage during the pull and facilitating the passage of the connector bundle through cramped and tight spaces. The OPTISOK® can be used to pull cables through plenums, underfloor duct, office partitions, raised access floors and conduits. Three sizes are available for all applications.

IMPORTANT:
Read all breaking strength, safety and technical data relating to this product.

Refer to pages W-44 and W-45.



OPTISOK® Non-Metallic Fiber Optic Pulling Tool

Bundle/Size Range Inches (cm)	Maximum Work Load Lbs.	Approx. O/A Length Inches (cm)	Ring O.D. Inches (cm)	Ring Thickness Inches (cm)	Catalog Number
.125"-.562" (.318-1.427)	30	28" (71.12)	.71" (1.803)	.10" (.254)	CCPS1
.250"-.750" (.635-1.905)	40	31" (78.74)	.71" (1.803)	.10" (.254)	CCPS2
.750"-1.750" (1.905-4.445)	50	33" (83.82)	1.57" (3.988)	.16" (.406)	CCPS3

How to Select OPTISOK®

- Identify connector bundle diameter to be inserted into the OPTISOK®.
- Choose appropriate catalog number based on size range.

Installation Information

Step 1 Expand open end of OPTISOK® and gently work in fiber optic connector bundle.

Step 2 Still gently, work connector bundle up to the forward section of the OPTISOK®.

Step 3 Starting at approximately 6" (15.2cm) from tail end of OPTISOK®, tightly fold over the OPTISOK® around cables and tape wrapped section 3" (7.62cm) past tail end onto the bundle.

Step 4 Securely attach pulling line or tape to pulling ring.

Note: To remove OPTISOK® carefully unwrap tape and slide out cables and connectors or cut OPTISOK® away without damaging connectors or cables.

Step 1

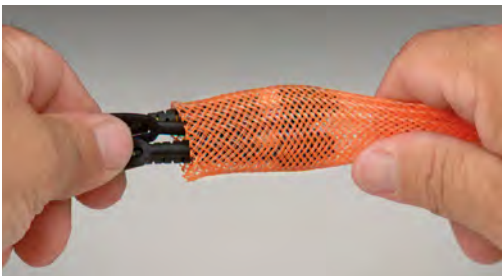

Step 2



Step 3



Step 4



Pulling Grips for Other Outside Plant Cables, Swivel Eye, Flexible Eye, Split Style, Low Profile

Kellems Pulling Grips for fiber optic cable are made of high strength galvanized steel strand. They feature a multiweave mesh, with one-half the mesh length double weave, and the second half single weave. This special weave provides positive holding power while allowing the grip to remain flexible with no damage to the cable jacket. Added features include a steel nose cone which protects the cable end and allows the grip to pass easily through conduit and enclosures. The eye connects easily to a swivel or a pulling line. Several grip sizes are available to accommodate all diameters of fiber optic cable.

IMPORTANT:
Read all breaking strength, safety and technical data relating to this product.

Refer to pages W-44 and W-45.

Application

Kellems Flexible Eye Pulling Grips for fiber optic cable are used for the installation of fiber optic communication lines either underground, overhead, through conduit or through enclosures. They will fit single cables or cable bundles, are easily installed on the cable and are reusable.

Benefits

- High strength multiweave mesh for positive holding power
- Highly flexible mesh to follow the pulling path of the cable
- Steel nose cone reduces snags and hang-ups and protects cable end
- Easily installed and removed
- A dependable, reusable pulling tool

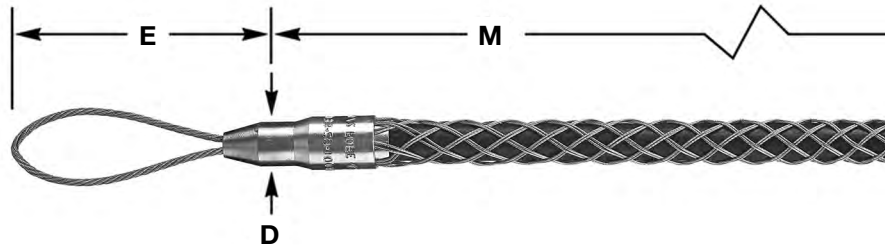

Fiber Optic Pulling Grip, Flexible Eye

Cable Diameter Range Inches (cm)	Approx. Breaking Strength Lbs.	Working Load Lbs.	E Approx. Inches (cm)	M Approx. Inches (cm)	D Approx. Inches (cm)	Catalog Number
.10"-.22" (.25-.56)	1,000	200	5.5" (14)	9" (23)	0.8" (2)	033291000
.21"-.35" (.53-.89)	1,500	300	5.5" (14)	14" (36)	0.8" (2)	033291001
.32"-.48" (.81-1.22)	2,200	440	6.0" (15)	18" (46)	0.9" (2.29)	033291002
.42"-.61" (1.07-1.55)	2,800	560	6.0" (15)	21" (53)	0.9" (2.29)	033291003
.53"-.74" (1.35-1.88)	3,300	660	6.5" (17)	24" (61)	1.3" (3.30)	033291004
.64"-.87" (1.63-2.21)	4,700	940	6.5" (17)	27" (69)	1.3" (3.30)	033291005

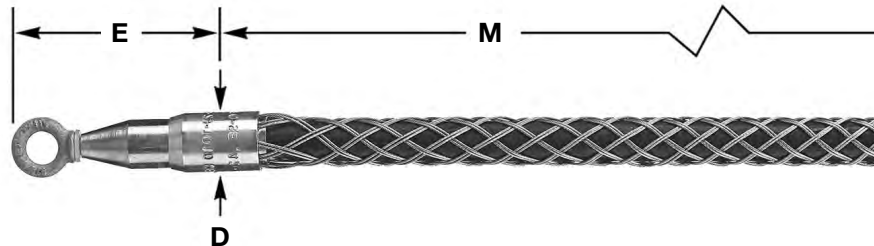

Fiber Optic Pulling Grip, Swivel Eye

Cable Diameter Range Inches (cm)	Approx. Breaking Strength Lbs.	Working Load Lbs.	E Approx. Inches (cm)	M Approx. Inches (cm)	D Approx. Inches (cm)	Catalog Number
.21"-.35" (.53-.89)	1,500	300	4.0" (10.16)	14" (35.56)	0.9" (2.29)	033291008
.32"-.48" (.81-1.22)	2,200	440	4.0" (10.16)	18" (45.72)	0.9" (2.29)	033291009
.42"-.61" (1.07-1.55)	2,800	560	4.0" (10.16)	21" (53.34)	0.9" (2.29)	033291010
.53"-.74" (1.35-1.88)	3,250	650	4.8" (12.19)	24" (60.96)	1.3" (3.30)	033291011
.64"-.87" (1.63-2.21)	4,700	940	4.8" (12.19)	27" (68.58)	1.3" (3.30)	033291012

Note: E-Eye length. M-Mesh length at nominal diameter.
Dimensions in Inches (mm)

Pulling Grips for Other Outside Plant Cables, Swivel Eye, Flexible Eye, Split Style, Low Profile

Kellems Pulling Grips for fiber optic cable are made of high strength galvanized steel strand. They feature a multiweave mesh, with one-half the mesh length double weave, and the second half single weave. This special weave provides positive holding power while allowing the grip to remain flexible with no damage to the cable jacket. Added features include a steel nose cone which protects the cable end and allows the grip to pass easily through conduit and enclosures. The eye connects easily to a swivel or a pulling line. Several grip sizes are available to accommodate all diameters of fiber optic cable.

IMPORTANT:
Read all breaking strength, safety and technical data relating to this product.

Refer to pages W-44 and W-45.

Application

Kellems Flexible Eye Pulling Grips for fiber optic cable are used for the installation of fiber optic communication lines either underground, overhead, through conduit or through enclosures. They will fit single cables or cable bundles, are easily installed on the cable and are reusable.

Benefits

- High strength multiweave mesh for positive holding power
- Highly flexible mesh to follow the pulling path of the cable
- Steel nose cone reduces snags and hang-ups and protects cable end
- Easily installed and removed
- A dependable, reusable pulling tool

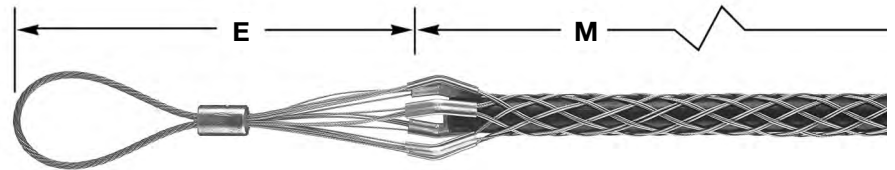

Fiber Optic Pulling Grip, Flexible Eye, Low Profile, Double/Single Weave Mesh

Cable Diameter Range Inches (cm)	Approx. Breaking Strength Lbs.	Working Load Lbs.	E Approx. Inches (cm)	M Approx. Inches (cm)	Catalog Number
.10"-.22 (.25-.56)	900	180	7.5" (19)	10" (25)	033291193
.21"-.35" (.53-.89)	1,400	280	7.5" (19)	14" (36)	033291194
.32"-.48" (.81-1.22)	2,000	400	8.5" (22)	19" (48)	033291195
.42"-.61" (1.07-1.55)	2,500	500	8.5" (22)	21" (53)	033291196
.53"-.74" (1.35-1.88)	3,000	600	8.5" (22)	23" (58)	033291197
.64"-.87" (1.63-2.21)	4,200	840	8.5" (22)	25" (64)	033291198
.75"-1.00" (1.90-2.54)	4,200	840	8.5" (22)	28" (71)	033291199

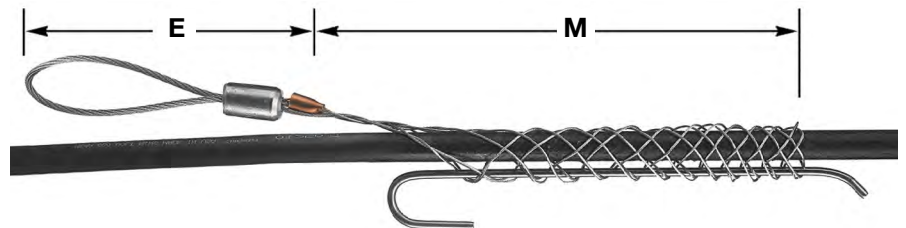

Fiber Optic Slack Pulling Grip, Split Mesh, Rod Closing, Single Weave

Cable Diameter Range Inches (cm)	Approx. Breaking Strength Lbs.	Working Load Lbs.	E Approx. Inches (cm)	M Approx. Inches (cm)	Catalog Number
.25"-.37" (.63-.94)	300	60	3" (7.6)	4.7" (12)	033291015
.38"-.49" (.97-1.24)	800	160	3" (7.6)	5" (13)	033291016
.50"-.61" (1.27-1.55)	800	160	3" (7.6)	7.5" (19)	033291017
.62"-.74" (1.57-1.88)	1,200	240	3" (7.6)	8" (20)	033291018

Note: E-Eye length. M-Mesh length at nominal diameter.

Dimensions in Inches (mm)

Fiber Optic Support Grips

Kellems Support Grips for fiber optic cable are specially designed to hold the cable weight as it hangs in a vertical or horizontal position. Fiber optic cable must be supported and Kellems Grips provide the support easily and economically.

These grips are made of high grade, non-magnetic tin-coated bronze strand. They are offered in universal bale or single eye configurations and are available in either closed mesh (for use where the cable end is available) or in split mesh, rod closing (for installation on existing cable runs or at specific locations).

IMPORTANT:

Read all breaking strength, safety and technical data relating to this product.

Refer to pages W-44 and W-45.



Fiber Optic Single Eye Cable Support Grip, Closed Mesh, Single Weave

For permanent support when cable end is available to be installed through grip.

Cable Diameter Range Inches (cm)	Approx. Breaking Strength Lbs.	Working Load Lbs.	E Approx. Inches (cm)	M Approx. Inches (cm)	Catalog Number
.18"-.25" (.46-.63)	300	30	3" (7.6)	1.7" (4.3)	022291000
.23"-.32" (.58-.81)	300	30	3" (7.6)	2.5" (6.4)	022291001
.30"-.39" (.76-.99)	300	30	4" (10)	2.5" (6.4)	022291002
.37"-.48" (.94-1.22)	300	30	5" (13)	4" (10)	022291003
.46"-.58" (1.17-1.47)	400	40	6" (15)	4" (10)	022291004
.56"-.71" (1.42-1.80)	600	60	7" (18)	5.5" (14)	022291005
.69"-.88" (1.75-2.24)	800	80	8" (20)	6" (15)	022291006

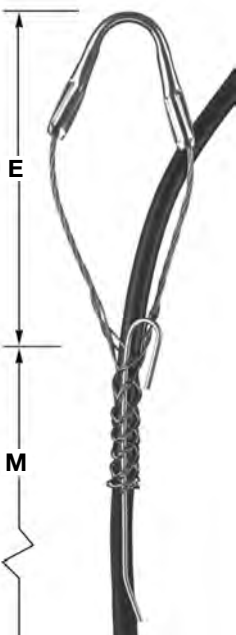

Fiber Optic Single Eye Cable Support Grip, Split Mesh, Rod Closing, Single Weave

For support when cable end not available.

Cable Diameter Range Inches (cm)	Approx. Breaking Strength Lbs.	Working Load Lbs.	E Approx. Inches (cm)	M Approx. Inches (cm)	Catalog Number
.18"-.25" (.46-.63)	300	30	3" (7.6)	2.5" (6.4)	022291016
.23"-.32" (.58-.81)	300	30	3" (7.6)	2.5" (6.4)	022291017
.30"-.39" (.76-.99)	300	30	4" (10)	2.5" (6.4)	022291018
.37"-.48" (.94-1.22)	300	30	5" (13)	4" (10)	022291019
.46"-.58" (1.17-1.47)	400	40	6" (15)	5" (13)	022291020
.56"-.71" (1.42-1.80)	600	60	7" (18)	5" (13)	022291021
.69"-.88" (1.75-2.24)	800	80	8" (20)	6" (15)	022291022

Note: E-Eye length. M-Mesh length at nominal diameter.

Dimensions in Inches (mm)

Support Grips for Fiber Optic Cable

Kellems Support Grips for fiber optic cable are specially designed to hold the cable weight as it hangs in a vertical or horizontal position. Fiber optic cable must be supported and Kellems Grips provide the support easily and economically.

These grips are made of high grade, non-magnetic tin-coated bronze strand. They are offered in universal bale or single eye configurations and are available in either closed mesh (for use where the cable end is available) or in split mesh, rod closing (for installation on existing cable runs or at specific locations).

Split Support Grip Rod Closing Instructions

The stainless steel rod is a precise built-in feature which makes threading easy and fast. The strands of the mesh pass around the rod and match up with the strands from the opposite direction. The rod does not touch the cable at any point and therefore cannot cut the cable. Rod Closing Grips are reusable. They may be removed and reused as many times as desired.

Fast to Install

- Step 1** Wrap the grip around the cable and thread the rod through the preformed loops with a corkscrew motion, using the curved end of the rod to engage the loops.
- Step 2** The action required is a steady push and twist simultaneously. The fingers of the left hand are used to bring the loops together just ahead of the hook on the end of the rod.
- Step 3** To remove, simply pull the rod out.

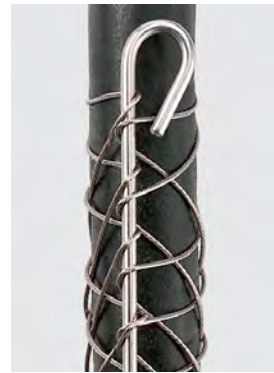

Kellems® Wire Management Products

Kellems has wide experience with grips for use with fiber optic cable. As the industry leader in producing wire mesh grips for the stringent requirements of fiber optic applications, Kellems has developed several series of grips for use with fiber optic communications cable.

These grips include pulling grips with built in swivels, grips with steel ends to protect fragile cable ends, grips with low profiles to pull cables in tight places and the OPTISOK® an effective tool to place pre-terminated cables. Also available are grips to support fiber optic cable.

Safety And Working Load Factors For Wire Mesh Grips

The broad application of Kellems grips on a wide variety of objects requires that adequate safety factors be used to establish working loads. The approximate breaking strength of a Kellems grip represents an average calculation based on data established from actual direct tension testing done in our engineering laboratories.

It is impossible to catalog or guarantee a safety factor suitable for all applications as operating conditions are never the same. The tension, diameter, movement, number of objects gripped, gripping surface, and the attachments used are just some of the factors which vary with each application. These factors, together with the effects of abrasion, corrosion, prior use or abuse and any other variables of a specific application, must be considered by the user and the grip replaced as appropriate. Where the conditions of the application are not well defined or known

Select the Correct Fiber Optic Grip

Each Kellems grip is designed to work on a specific range of cable diameters.

Step 1 Determine your cable outside diameter.

Step 2 Find the grip size that encompasses your cable diameter.

Step 3 Whenever possible, use a closed mesh that assembles over the cable end. If the cable end is not available, use a split mesh.

Step 4 Where available, select an eye style that suits your needs.

Step 5 Estimate the tension to be put on the grip, establish the working load you require and compare this to the listed approximate breaking strength of the grip to insure that the grip will be strong enough.

or where risk of injury to persons or property is involved, a greater safety factor should be utilized.

IMPORTANT:

Under normal conditions, Kellems' recommended factor of safety is five for catalog listed pulling grips, and ten for catalog listed support grips.

Any warranty as to quality, performance or fitness for use of grips is always premised on the condition that the published breaking strengths apply only to new, unused grips, and that such products are properly stored, handled, used, maintained and inspected by the user at a frequency appropriate for the use and condition of the grip.

For grip applications on materials other than those that the grips have been specifically designed for, consult the factory.

Examples

Grip Style	Approx. Breaking Strength Lbs. (N)	Safety Factor	Max. Recommended Load Lbs. (N)	Catalog Number
Pulling Grips	2,500 (11,120)	5	500 (2,224)	033291196
Support Grips	400 (1,779)	10	40 (178)	022291004

The maximum recommended working load is the tension to be exerted on the grip in application with a margin of safety to take care of unforeseen and unusual circumstances.

It is the end-user's decision to determine how much of a safety factor is acceptable to for the application.

Fiber Optic Grip Materials

Material	Features	Product Group
Galvanized steel wire	<ul style="list-style-type: none">• High strength• Not subject to continuous outside environment	<ul style="list-style-type: none">• Pulling grips
Tin-coated bronze wire	<ul style="list-style-type: none">• Corrosion resistant for normal outside areas• Non-magnetic• Moderate strength	<ul style="list-style-type: none">• Support grips
Non-metallic braid	<ul style="list-style-type: none">• Superior flex life• Non-conductive• Corrosion resistant• Moderate strength	<ul style="list-style-type: none">• OPTISOK®

Approvals

CSA Certification is indicated on appropriate product catalog pages.

Hose Containment Grips

Kellems® Hose Containment Grips are used on high pressure, flexible hose lines to prevent the hose from whipping violently in the event of hose failure at the fitting. These grips will prevent serious injury to personnel and damage to equipment by holding the hose in place in the event of hose failure.

Kellems® patented Hose Containment Grips are made of stainless steel double weave mesh construction for high strength and come complete with hose clamps.

IMPORTANT:

Read all breaking strength, safety and technical data relating to this product.

Types of Attachment

The six attachment methods shown below provide unlimited flexibility of attachment to meet any condition.

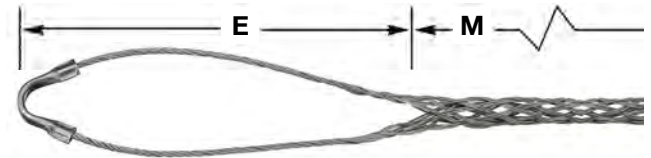

Type A

Single Eye, used where fastening is made with eyebolts or similar anchor terminations.

Cable Diameter Range Inches (cm)	Approx. Breaking Strength Lbs.	Working Load Lbs.	E Inches (cm)	M Inches (cm)	Catalog Number
.38"-.69" (.97-1.75)	2,900	290	10" (25)	24" (61)	014021285
.50"-.94" (1.27-2.39)	3,400	340	10" (25)	24" (61)	014021230
1.00"-1.56" (2.54-3.96)	9,400	940	10" (25)	36" (91)	014021453
1.25"-1.94" (3.18-4.93)	14,400	1,440	48" (122)	60" (152)	014021593
2.75"-3.44" (6.99-8.74)	12,500	1,250	10" (25)	48" (122)	014021524

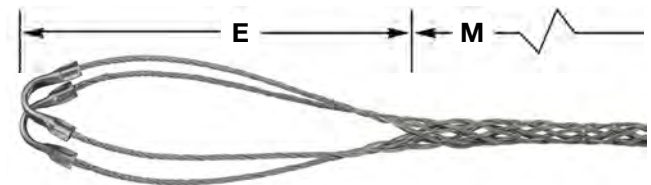

Type E

Double Eye Grip, used where fastening is made with eyebolts or similar anchor terminations.

Cable Diameter Range Inches (cm)	Approx. Breaking Strength Lbs.	Working Load Lbs.	E Inches (cm)	M Inches (cm)	Catalog Number
.50"-.94" (1.27-2.39)	4,250	425	8" (20)	24" (61)	014021224
.75"-1.25" (1.91-3.18)	6,000	600	8" (20)	24" (61)	014021223
1.00"-1.56" (2.54-3.96)	8,000	800	8" (20)	24" (61)	014021279

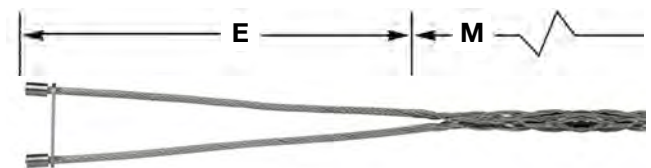

Type U

Universal Bale Grip, used to fasten around a structure or closed eye.

Cable Diameter Range Inches (cm)	Approx. Breaking Strength Lbs.	Working Load Lbs.	E Inches (cm)	M Inches (cm)	Catalog Number
.31"-.56" (.79-1.42)	2,100	210	12" (30)	24" (61)	014021304
.38"-.69" (.97-1.75)	2,600	260	12" (30)	24" (61)	014021308
.50"-.94" (1.27-2.39)	3,100	310	12" (30)	24" (61)	014021138
.50"-.94" (1.27-2.39)	3,100	310	24" (61)	24" (61)	014021139
.75"-1.25" (1.91-3.18)	4,500	450	12" (30)	24" (61)	014021140
1.00"-1.56" (2.54-3.96)	6,000	600	12" (30)	24" (61)	014021142
1.25"-1.94" (3.18-4.93)	6,000	600	12" (30)	36" (91)	014021527

Note: E- Eye length. M-Mesh length at nominal diameter.

It should be emphasized that Kellems® Hose Containment Grips are not to be used as a pressure reinforcing device for hose systems. These grips are custom made. Consult Technical Services for details.

Dimensions in Inches (mm)

Hose Containment Grips

Kellems Hose Containment Grips are supplied in diameters, length and attachments to meet individual requirements. Contact the Wiring Device-Kellems factory for specific information. These grips help meet OSHA Federal Register 1926-302 (b), 1926-603 (9), (10), JIC H-1-1973 (H13.11) and JIC P-1-1975 (P11.34) requirements.

IMPORTANT:

Read all breaking strength, safety and technical data relating to this product.

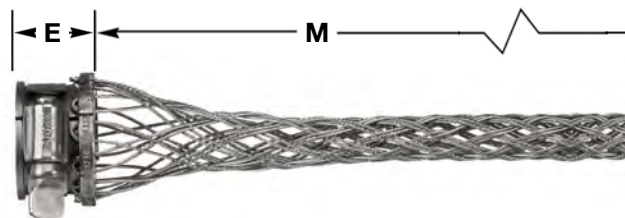

Type F

Split fitting to fit AN-818 nuts. Fitting is positioned over nut and located with internal flange. A hose clamp is furnished and required to hold the fitting in correct position.

Cable Diameter Range Inches (cm)	Approx. Breaking Strength Lbs.	Working Load Lbs.	E Inches (cm)	M Inches (cm)	Catalog Number
.38"-.69" (.97-1.75)	2,900	290	1" (2.54)	24" (61)	014021208
.50"-.94" (1.27-2.39)	3,400	340	1" (2.54)	24" (61)	014021156
.50"-.94" (1.27-2.39)	3,400	340	1" (2.54)	12" (30)	014021185
.50"-.94" (1.27-2.39)	3,400	340	1" (2.54)	12" (30)	014021186
.50"-.94" (1.27-2.39)	3,400	340	1" (2.54)	24" (61)	014021216
.75"-1.25" (1.91-3.18)	6,000	600	1" (2.54)	24" (61)	014021113
.75"-1.25" (1.91-3.18)	6,000	600	1" (2.54)	12" (30)	014021120
.75"-1.25" (1.91-3.18)	6,000	600	1" (2.54)	24" (61)	014021301
1.00"-1.56" (2.54-3.96)	6,000	600	1" (2.54)	24" (61)	014021157
1.00"-1.56" (2.54-3.96)	8,000	800	1.12" (2.84)	24" (61)	014021366
1.25"-1.94" (3.18-4.93)	8,000	800	1.12" (2.84)	36" (91)	014021314

Dimensions in Inches (mm)

Kellems® Wire Management Products

Kellems Strain Relief Grips are designed to prevent tension from being transmitted to joints and terminals on electrical cord, cable and conduit. In most applications, a Kellems grip for strain relief is stronger than the cable itself and gives much greater security than the use of a fitting alone. Kellems Grips for strain relief help make electrical systems safer, and save money by minimizing downtime from costly electrical failure due to cable pull-out. Kellems Grips also aid in compliance with the National Electric Code's terminal tension protection requirements.

Select the Correct Grip for Strain Relief

Kellems Grips for strain relief are designed to fit on electrical cord, cable or flexible conduit.

Step 1 Refer to the chart below to determine the grip style best suited for your application.







Step 2 Determine your cable outside diameter or conduit size.

Step 3 Locate environment—indoors or outdoors.

Step 4 Decide if a liquidtight seal is required.

Step 5 Select NPT size and fitting style.

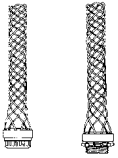
Strain Relief System Selection Chart

Grip Type	Application	Features	Cord or Conduit Range Inches (cm)	Type Fitting or Attachment	Page Number
Deluxe Cord Aluminum Fitting/ Stainless Steel Grip	 Outdoors or indoors where subjected to moisture or splash. Examples are crane and hoist pendant drop stations, hand tools, pumps and processing equipment.	Aluminum fittings, stainless steel mesh, neoprene oil-and-watertight bushing. Double-single weave.	.187"-3.250" (.47-8.25)	NPT, PG, and metric aluminum, male straight, 45° male, 90° male, female straight. Thread sizes 3/8"-3".	W-50, W-51, W-54
Deluxe Cord Nylon Fitting/ Stainless Steel Grip	 Outdoors or indoors where subjected to moisture or splash. Examples are marine and food processing equipment.	Nylon fitting, stainless steel mesh, double-single weave, neoprene oil-and-watertight bushing.	.187"-1.125" (.47-2.86)	NPT nylon, male straight, 90° male. Thread sizes 1/2"-1".	W-52
Deluxe Cord Nylon Fitting/ Non-metallic Grip	 Indoor or outdoors. Provides liquidtight seal, where exposed to moisture. Excellent for oil refining and chemical processing.	Non-metallic grip is corrosion resistant, nonconductive and provides superior gripping and flexing benefits. Neoprene liquidtight bushing. Nylon fitting.	.187"-1.000" (.47-2.54)	NPT nylon, straight male, thread sizes 3/8"-1" 90° male, thread sizes 1/2"-1".	W-53
Deluxe Cord Stainless Steel Fitting And Grip	 Indoor or outdoor use where exposed to moisture. Very strong for heavy abuse areas such as drilling platforms, steel mills and mines.	Stainless steel fitting and grip for strength. Neoprene liquidtight bushing. Double/single weave grip.	.187"-1.000" (.47-2.54)	Straight male Only with NPT Thread sizes 1/2"-1".	W-53
Dust-Tight Strain Relief	 Indoor use only for wiring of electrical enclosures, machine tools, portable power tools, bus drop cable systems.	Neoprene gasket—seals out chips, dirt, dust. One piece design with galvanized steel mesh. Insulating bushing available. Zinc-plated steel locknut.	.240"-2.450" (.61-6.22)	Straight male NPS or NPT	W-55
Liquidtight Flexible Conduit Grip (Metal and Non-Metallic)	 Wiring of machine tools, electrical enclosures, motors and systems where metallic liquidtight flexible conduit is subjected to vibration, flexure, motion or strain.	Stainless steel mesh, liquidtight fittings. Sealing "O" rings (optional). Choice of fittings.	.375"-4.000" trade sizes	NPT 1/2"-4", Hubbell fittings, Male straight, 45° male, 90° male, female straight.	W-58, W-59
Liquidtight Flexible Conduit Grip (UL Type A)	 Wiring or machine tools, electrical enclosures, motors and systems where conduit is subject to vibration and strain.	Stainless steel mesh, liquidtight fittings with "O" ring and locknut.	.375"-2.008" trade size male	NPT steel, Hubbell fittings, straight male, 90° Thread sizes 1/2"-2".	W-60

Kellems® Wire Management Products

Features and Benefits

Deluxe Cord Grip

Deluxe cord grips help to alleviate pull tension on terminals, control cable arc-of-bend, prevent cord pull-out and provide a liquidtight seal. They are offered with either aluminum, stainless steel or nylon fittings in a variety of configurations and NPT thread sizes. Additionally, a completely non-metallic product is available.

Application

Specific uses are: wiring enclosures, pendant stations, hand tools, construction, processing and material handling equipment, pumps, motors and machine tools.

Benefits

- Helps to prevent cable pull-out
- Controls cable arc-of-bend
- Provides a liquidtight seal
- Corrosion resistant stainless steel mesh with aluminum collar



Mesh Grip

- Stainless steel mesh is corrosion resistant; can be used inside or outside
- Eliminates cable or flexible conduit pull out and reduces costly downtime
- Endless weave provides easy cable/flexible conduit installation



Deluxe Cord Grips

- An NPT and PG threaded body allows easy attachment to either threaded hub or knock-out in box
- A liquidtight fitting is available with both cable and conduit fittings; prevents liquids from running through the fitting into the enclosure

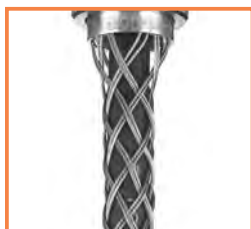

Cable Protection

- Multiweave grip gives cable arc-of-bend control minimizing cable damage and extending cable life
- It is the strongest strain relief device available; meets and exceeds all code requirements; prevents cable/conduit pull-out



Comprehensive Offering

- Hubbell offers a full line of deluxe cord grips with various material finishes
- Deluxe cord grips are used indoors or outdoors to help prevent cord pull-out and where cables are subjected to moisture, splash or submersion

Deluxe Cord Grips

Aluminum Fittings, Stainless Steel Mesh, Liquidtight for Insulated Cables.

IMPORTANT:

Read all safety and technical data relating to this product.

Refer to pages W-61 through W-68.

Straight Male Thread

NPT Thread Size Inches	Grip Diameter Range Inches (cm)		Form Size	Catalog Number
3/8	.250"-.312"	(.63-.79)	F1	07401001
	.312"-.375"	(.79-.95)		07401002
	.375"-.437"	(.95-1.11)		07401003
1/2	.187"-.250"	(.47-.63)	F2	07401004
	.250"-.375"	(.63-.95)		07401006
	.375"-.500"	(.95-1.27)		07401008
1/2	.500"-.625"	(1.27-1.59)	F3	07401010
	.625"-.750"	(1.59-1.90)		074011247*
	.750"-.875"	(1.90-2.22)		074011248*
3/4	.187"-.250"	(.47-.63)	F2	07401011
	.250"-.375"	(.63-.95)		07401013
	.375"-.500"	(.95-1.27)		07401015
3/4	.500"-.625"	(1.27-1.59)	F3	07401017
	.625"-.750"	(1.59-1.90)		07401018
	.750"-.875"	(1.90-2.22)		074011249*
1	.375"-.500"	(.95-1.27)	F4	074011195
	.500"-.625"	(1.27-1.59)		07401019
	.625"-.750"	(1.59-1.90)		07401021
1	.750"-.875"	(1.90-2.22)	F5	07401023
	.875"-.1.000"	(2.22-2.54)		07401025
	1.000"-.1.125"	(2.54-2.86)		074011250*
1	1.125"-.1.250"	(2.86-3.17)	F5	074011028*
	1.250"-.1.375"	(3.17-3.49)		074011029*
	.750"-.875"	(1.90-2.22)		074011251
1 1/4	.875"-.1.000"	(2.22-2.54)	F5	07401026
	1.000"-.1.125"	(2.54-2.86)		07401027
	1.125"-.1.250"	(2.86-3.17)		07401028
1 1/4	1.250"-.1.375"	(3.17-3.49)	F6	074011178*
	.750"-.875"	(1.90-2.22)		074011252
	.875"-.1.000"	(2.22-2.54)		07401029
1 1/2	1.000"-.1.125"	(2.54-2.86)	F5	07401030
	1.125"-.1.250"	(2.86-3.17)		07401031
	1.250"-.1.375"	(3.17-3.49)		07401032
1 1/2	1.312"-.1.437"	(3.33-3.65)	F6	074011253
	1.437"-.1.562"	(3.65-3.97)		074011254*
	1.562"-.1.687"	(3.97-4.28)		074011255*
1 1/2	1.687"-.1.812"	(4.28-4.60)	F6	074011256*
	1.750"-.1.875"	(4.44-4.76)		074011257*
	1.250"-.1.375"	(3.17-3.49)		074011258
2	1.312"-.1.437"	(3.33-3.65)	F6	074011259
	1.437"-.1.562"	(3.65-3.97)		07401033
	1.562"-.1.687"	(3.97-4.28)		07401034
2	1.687"-.1.812"	(4.28-4.60)	F7	07401035
	1.750"-.1.875"	(4.44-4.76)		074011260
	1.812"-.1.937"	(4.60-4.92)		074011261
2	1.937"-.2.062"	(4.92-5.24)	F7	074011262*
	2.062"-.2.187"	(5.24-5.55)		074011263*
	2.187"-.2.312"	(5.55-5.87)		074011264*
2 1/2	2.312"-.2.437"	(5.87-6.19)	F7	074011265*
	1.688"-.1.812"	(4.29-4.60)		074011030
	1.812"-.1.937"	(4.60-4.92)		074011031
2 1/2	1.937"-.2.062"	(4.92-5.24)	F7	074011032
	2.062"-.2.187"	(5.24-5.55)		074011033
	2.187"-.2.312"	(5.55-5.87)		074011034
3	2.312"-.2.437"	(5.87-6.19)	F7	074011036
	1.937"-.2.062"	(4.92-5.24)		074011037
	2.062"-.2.187"	(5.24-5.55)		074011038
3	2.187"-.2.312"	(5.55-5.87)	F8	074011039
	2.312"-.2.437"	(5.87-6.19)		074011186
	2.437"-.2.625"	(6.19-6.67)		074011187
3	2.625"-.2.812"	(6.67-7.14)	F8	074011188
	2.812"-.3.000"	(7.14-7.62)		074011189*
	3.000"-.3.250"	(7.62-8.25)		



Note: Kellems® Deluxe Cord Grips are suitable for use in hazardous locations per Class I Div. 2, Class II Div. 1 & 2, Class III Div. 1 & 2 of the National Electric Code Sections 501.10(b)(2), 502.10(a)(2), 502.10(b)(2), 503.10(a)(2) and 503.10(b).
*Cable jacket may have to be stripped to pass through connector body.

Dimensions in Inches (mm)

Deluxe Cord Grips

Aluminum Fittings, Stainless Steel Mesh, Liquidtight for Insulated Cables.

IMPORTANT:

Read all safety and technical data relating to this product.

Refer to pages W-61 through W-68.

Straight Female Thread

NPT Thread Size Inches	Grip Diameter Range Inches (cm)		Form Size	Catalog Number
½	.375"-.500"	(.95-1.27)	F2	07401043
	.500"-.625"	(1.27-1.59)		07401045
¾	.500"-.625"	(1.27-1.59)	F2	07401052
¾	.625"-.750"	(1.59-1.90)	F4	07401053

90° Male Thread

NPT Thread Size Inches	Grip Diameter Range Inches (cm)		Form Size	Catalog Number
¾	.250"-.312"	(.63-.79)	F1	07401071
	.312"-.375"	(.79-.95)		07401072
	.375"-.437"	(.95-1.11)		07401073
½	.187"-.250"	(.47-.63)	F2	07401074
	.250"-.375"	(.63-.95)		07401076
	.375"-.500"	(.95-1.27)		07401078
¾	.500"-.625"	(1.27-1.59)	F3	07401080*
	.375"-.500"	(.95-1.27)		07401081
	.500"-.625"	(1.27-1.59)		07401083
	.625"-.750"	(1.59-1.90)		07401084*
1	.750"-.875"	(1.90-2.22)	F4	074011275*
	.750"-.875"	(1.90-2.22)		07401085
	.875"-1.000"	(2.22-2.54)		07401087
1¼	1.000"-1.125"	(2.54-2.86)	F5	07401089
	.750"-.875"	(1.90-2.22)		07401091*
	.875"-1.000"	(2.22-2.54)		07401099*
	1.000"-1.125"	(2.54-2.86)		074011229*
1½	1.125"-1.250"	(2.86-3.17)	F5	074011230
	1.125"-1.250"	(2.86-3.17)		07401137
	1.250"-1.375"	(3.18-3.51)		07401108
	1.250"-1.375"	(3.18-3.51)		074011042*
2	1.250"-1.375"	(3.18-3.49)	F5	074011043
	1.000"-1.125"	(2.54-2.86)		074011045
	1.125"-1.250"	(2.86-3.17)		074011046
	1.250"-1.375"	(3.17-3.49)		074011047
2	1.312"-1.437"	(3.33-3.65)	F6	074011233
	1.437"-1.562"	(3.65-3.97)		074011244
	1.562"-1.687"	(3.96-4.29)		074011245
	1.687"-1.812"	(4.28-4.60)		074011246
	1.750"-1.875"	(4.44-4.76)		074011234*

45° Male Thread

NPT Thread Size Inches	Grip Diameter Range Inches (cm)		Form Size	Catalog Number
½	.250"-.375"	(.63-.95)	F2	074011236
	.375"-.500"	(.95-1.27)		074011021
	.500"-.625"	(1.27-1.59)		074011237*
¾	.500"-.625"	(1.27-1.59)	F3	074011049
	.625"-.750"	(1.59-1.90)		074011051*
	.750"-.875"	(1.90-2.22)		074011239*
1	.625"-.750"	(1.59-1.90)	F4	074011055
	.750"-.875"	(1.90-2.22)		074011057
	.875"-1.000"	(2.22-2.54)		074011199*
1¼	1.000"-1.125"	(2.54-2.86)	F5	074011059
	1.125"-1.250"	(2.86-3.17)		074011060

Note: Kellems® Deluxe Cord Grips are suitable for use in hazardous locations per Class I Div. 2, Class II Div. 1 & 2, Class III Div. 1 & 2 of the National Electric Code Sections 501.10(b)(2), 502.10(a)(2), 502.10(b)(2), 503.10(a)(2) and 503.10(b).

*Cable jacket may have to be stripped to pass through connector body.

Dimensions in Inches (mm)

Deluxe Cord Grips

Nylon Fittings, Stainless Steel Mesh, Liquidtight for Insulated Cables.

IMPORTANT:

Read all safety and technical data relating to this product.

Refer to pages W-61 through W-68.

Straight Male Thread

NPT Thread Size Inches	Grip Diameter Range Inches (cm)		Form Size	Catalog Number
1/2	.187"-.250"	(.47-.63)	F2	074011331
	.250"-.375"	(.63-.95)		074011332
	.375"-.500"	(.95-1.27)		074011333
	.500"-.625"	(1.27-1.59)		074011334*
3/4	.375"-.500"	(.95-1.27)	F3	074011335
	.500"-.625"	(1.27-1.59)		074011336
	.625"-.750"	(1.59-1.90)		074011337
1	.750"-.875"	(1.90-2.22)	F4	074011338*
	.625"-.750"	(1.59-1.90)		074011341
	.750"-.875"	(1.90-2.22)		074011342
	.875"-1.000"	(2.22-2.54)		074011343
	1.000"-1.125"	(2.54-2.86)		074011344*



90° Male Thread

NPT Thread Size Inches	Grip Diameter Range Inches (cm)		Form Size	Catalog Number
1/2	.250"-.375"	(.63-.95)	F2	074011346
	.375"-.500"	(.95-1.27)		074011347
	.500"-.625"	(1.27-1.59)		074011348*
3/4	.375"-.500"	(.95-1.27)	F3	074011349
	.500"-.625"	(1.27-1.59)		074011350
	.625"-.750"	(1.59-1.90)		074011351*



Note: Kellems® Deluxe Cord Grips are suitable for use in hazardous locations per Class I Div. 2, Class II Div. 1 & 2, Class III Div. 1 & 2 of the National Electric Code Sections 501.10(b)(2), 502.10(a)(2), 502.10(b)(2), 503.10(a)(2) and 503.10(b).

*Cable jacket may have to be stripped to pass through connector body.

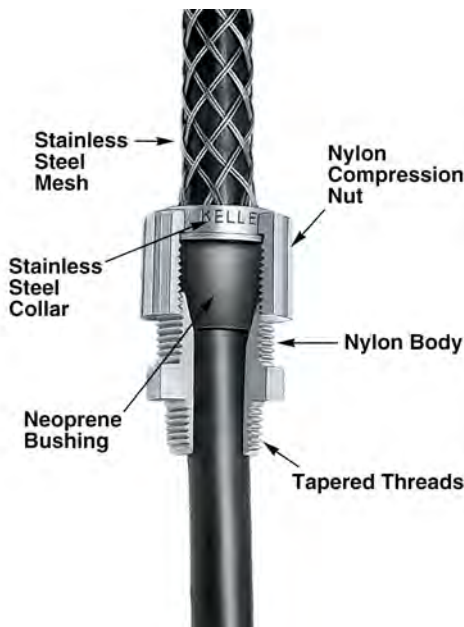

Dimensions in Inches (mm)

Deluxe Cord Grips

Nylon Fittings, Non-Metallic Mesh, and Stainless Steel Fittings, Stainless Steel Mesh, Liquidtight for Insulated Cables.

IMPORTANT:

Read all safety and technical data relating to this product.

Refer to pages W-61 through W-68.



Nylon Fittings Non-Metallic Mesh, Liquidtight for Insulated Cables Straight Male Thread

NPT Thread Size Inches	Grip Diameter Range Inches (cm)	Form Size	Catalog Number
3/8	.187"-.250" (.47-.63)	F1	CG304NM
	.250"-.312" (.63-.79)		CG305NM
	.312"-.375" (.79-.95)		CG306NM
1/2	.187"-.250" (.47-.63)	F2	CG404NM
	.250"-.375" (.63-.95)		CG406NM
	.375"-.500" (.95-1.27)		CG408NM
3/4	.375"-.500" (.95-1.27)	F3	CG608NM
	.500"-.625" (1.27-1.59)		CG610NM
	.625"-.750" (1.59-1.90)		CG612NM
1	.500"-.625" (1.27-1.59)	F4	CG810NM
	.625"-.750" (1.59-1.90)		CG812NM
	.750"-.875" (1.90-2.22)		CG814NM
	.875"-.1.000" (2.22-2.54)		CG816NM



90° Male Thread

NPT Thread Size Inches	Grip Diameter Range Inches (cm)	Form Size	Catalog Number
1/2	.250"-.375" (.63-.95)	F2	CG40690NM
	.375"-.500" (.95-1.27)		CG40890NM
3/4	.375"-.500" (.95-1.27)	F3	CG60890NM
	.500"-.625" (1.27-1.59)		CG61090NM
1	.625"-.750" (1.59-1.90)	F4	CG81290NM
	.750"-.875" (1.90-2.22)		CG81490NM

Stainless Steel Fittings, Stainless Steel Mesh, Liquidtight for Insulated Cables Straight Male Thread

NPT Thread Size Inches	Grip Diameter Range Inches (cm)	Form Size	Catalog Number
1/2	.187"-.250" (.47-.63)	F2	CG404SST
	.250"-.375" (.63-.95)		CG406SST
	.375"-.500" (.95-1.27)		CG408SST
	.500"-.625" (1.27-1.59)		CG410SST
3/4	.375"-.500" (.95-1.27)	F2	CG608SST
	.500"-.625" (1.27-1.59)		CG610SST
3/4	.625"-.750" (1.59-1.90)	F3	CG612SST
	.750"-.875" (1.90-2.22)		CG614SST
1	.500"-.625" (1.27-1.59)	F4	CG810SST
	.625"-.750" (1.59-1.90)		CG812SST
	.750"-.875" (1.90-2.22)		CG814SST
	.875"-.1.000" (2.22-2.54)		CG816SST

Note: Kellems® Deluxe Cord Grips are suitable for use in hazardous locations per Class I Div. 2, Class II Div. 1 & 2, Class III Div. 1 & 2 of the National Electric Code Sections 501.10(b)(2), 502.10(a)(2), 502.10(b)(2), 503.10(a)(2) and 503.10(b).

*Cable jacket may have to be stripped to pass through connector body.

Dimensions in Inches (mm)

PG and Metric Threaded Deluxe Cord Grips

Aluminum Fittings, Stainless Steel Mesh, Liquidtight for Insulated Cables.

IMPORTANT:

Read all safety and technical data relating to this product.

Refer to pages W-61 through W-68.

Straight PG* Male Thread

Hub Size	Cord Diameter Range Inches (cm)		Form Size	Catalog Number
PG16	.500"-.625"	(1.27-1.59)	F2	074PG16010
PG21	.500"-.625"	(1.27-1.59)	F2	074PG21010
PG21	.625"-.750"	(1.59-1.90)	F3	074PG211247
	.750"-.875"	(1.90-2.22)		074PG211248
PG29	.625"-.750"	(1.59-1.90)	F4	074PG29021
	.750"-.875"	(1.90-2.22)		074PG29023
	.875"-1.000"	(2.22-2.54)		074PG29025
PG29	1.125"-1.250"	(2.86-3.17)	F5	074PG291028*
PG36	1.125"-1.250"	(2.86-3.17)	F5	074PG36028*

Note: *Panzergewinde.



Straight Metric Male Thread

Hub Size	Cord Diameter Range Inches (cm)		Form Size	Catalog Number
M20	.500"-.625"	(1.27-1.59)	F2	074M20010
M25	.625"-.750"	(1.59-1.90)	F3	074M251247
	.750"-.875"	(1.90-2.22)		074M251248
M25	.500"-.625"	(1.27-1.59)	F2	074M25017
	.625"-.750"	(1.59-1.90)		074M32021
	.750"-.875"	(1.90-2.22)		074M32023
M32	.875"-1.000"	(2.24-2.54)	F4	074M32025
	1.000"-1.125"	(2.54-2.86)		074M321250
M32	1.125"-1.250"	(2.86-3.17)	F5	074M321028

Note: Kellems® Deluxe Cord Grips are suitable for use in hazardous locations per Class I Div. 2, Class II Div. 1 & 2, Class III Div. 1 & 2 of the National Electric Code Sections 501.10(b)(2), 502.10(a)(2), 502.10(b)(2), 503.10(a)(2) and 503.10(b).

*Cable jacket may have to be stripped to pass through connector body.



Specifications

Material	Temperature Range
Aluminum (Body)	-30°F to +240°F (-34°C to +115°C).
Stainless Steel (Mesh)	-30°F to +240°F (-34°C to +115°C).
Neoprene (Bushings)	-30°F to +240°F (-34°C to +115°C).
Hazardous Locations	Suitable for use in hazardous locations per Class I Div. 2, Class II Div. 1 & 2, Class III Div. 1 & 2 N.E.C. Reference 501.10(b)(2), 502.10(a)(2), 502.10(b)(2), 503.10(a)(2) and 503.10(b).
Approvals	
Deluxe Cord Grips	UL Listed in accordance with Standard 514B for indoor/outdoor use. UL Control numbers 898D and 899D.
Wet Locations	Suitable for use in wet locations when used with a listed sealing ring between box and fitting.

Dimensions in Inches (mm)

Dust-Tight Strain Relief Grips

Aluminum Fittings, Galvanized Steel Mesh for Insulated Cables.

IMPORTANT:

Read all safety and technical data relating to this product.

Refer to pages W-61 through W-68.



Non-Insulated, Wide Range Strain Relief

Thread Size	Cord Diameter Range Inches (cm)	Mesh Length @ Nom. Dia. Inches (cm)	Catalog Number
½ NPT	.24"-.32" (.61-.81)	3.25" (8.25)	073031200
	.32"-.43" (.81-1.09)	3.75" (9.52)	073031201
	.43"-.54" (1.09-1.37)	4.75" (12.06)	073031202
¾ NPT	.54"-.73" (1.37-1.85)	6.5" (16.51)	073031203A
1 NPT	.73"-.97" (1.85-2.46)	7" (17.78)	073031204
1¼ NPT	.97"-1.25" (2.46-3.17)	9" (22.86)	073031205
PG29*	.73"-.97" (1.85-2.46)	7" (17.78)	073PG291204

Note: *Panzergewinde.

Insulated, Wide Range Strain Relief with Insulating Bushing

Thread Size	Cord Diameter Range Inches (cm)	Mesh Length @ Nom. Dia. Inches (cm)	Dim. A Inches (cm)	Min. Space Between Grips Inches (cm)	Catalog Number
½ NPS	.24"-.32" (.61-.81)	3.25" (8.25)	1" (2.54)	1.25" (3.17)	073031206
	.32"-.43" (.81-1.09)	3.75" (9.52)	1" (2.54)	1.25" (3.17)	073031207
	.43"-.54" (1.09-1.37)	4.75" (12.06)	1" (2.54)	1.25" (3.17)	073031208
¾ NPS	.54"-.73" (1.37-1.85)	6.5" (16.51)	1" (2.54)	1.5" (3.81)	073031209A
1 NPS	.73"-.97" (1.85-2.46)	7" (17.78)	1.313" (3.02)	1.75" (4.44)	073031210
1¼ NPS	.97"-1.25" (2.46-3.17)	9" (22.86)	1.313" (3.02)	2.25" (5.71)	073031211
1½ NPT	1.25"-1.50" (3.17-3.81)	11.75" (29.84)	1.313" (3.02)	2.5" (6.35)	073031212
2 NPT	1.50"-1.70" (3.81-4.32)	13.25" (33.65)	1.375" (3.49)	3.25" (8.25)	073031213
	1.70"-2.00" (4.32-5.08)	13.5" (34.29)	1.5" (3.81)	3.625" (9.21)	073031214
2½ NPT	2.00"-2.45" (5.08-6.22)	13.75" (34.92)	1.5" (3.81)	3.625" (9.21)	073031215



Dimensions in Inches (mm)

I-Grips for Insulated Cables

Kellems® I-Grips are made of high strength, plastic coated galvanized steel strand. They are offered in six sizes to fit all cable diameters used with Hubbell Insulgrip®. Kellems I-Grips will control cable arc-of-bend and reduce high pull tensions from being transmitted to the wiring terminals.

IMPORTANT:

Read all safety and technical data relating to this product.

Refer to pages W-61 through W-68.

Application

Kellems® I-Grips will fit 2, 3, 4 and 5 wire Hubbell Insulgrip® plugs and connector bodies. The eye tabs fit under the nylon cord clamp and the screws slide through the eyelets, securing the grip in place.

I-Grips can be used on any Insulgrip cord set which requires cable, arc-of-bend control or heavy duty strain relief. Cord sets used at in-door construction sites or for plant maintenance jobs are examples.

These grips are for indoor use only.

Benefits

- Easily attached to Insulgrip plugs and connector bodies
- Controls cable arc-of-bend
- Provides heavy-duty strain relief
- Fits all sizes

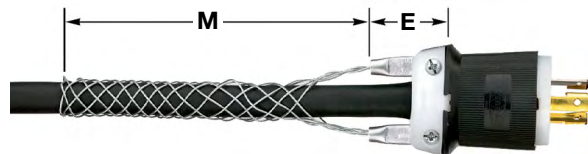

I-Grips

Cable Diameter Range Inches (cm)	E Inches (cm)	M Inches (cm)	Catalog Number
.32"-.43" (.81-1.09)	1.25" (3.17)	4" (10.16)	07310001
.43"-.56" (1.09-1.42)	1.25" (3.17)	4.75" (12.06)	07310002
.56"-.73" (1.42-1.85)	1.50" (3.81)	6" (15.24)	07310003
.73"-.85" (1.85-2.16)	1.50" (3.81)	6.5" (16.51)	07310004
.85"-1.00" (2.16-2.54)	1.50" (3.81)	8" (20.32)	07310005
1.00"-1.25" (2.54-3.17)	1.50" (3.81)	10" (25.40)	07310006

Note: E-Eye length. M-Mesh length at nominal diameter.

Eyelet hole diameter .203" (.52cm).

I-Grips should not be used on Insulgrip devices when "Seal-Tite®" weatherproof covers are to be installed.

Dimensions in Inches (mm)

Thread Adapters for Multi-Pin Connectors

Kellems® Thread Adapters are devices formatting AN-MS connectors and other multi-pin connectors to Kellems grips with NPT threaded fittings. They are made of aluminum with internal threads and replace the connector cord clamp. These adapters permit the installation of Kellems Grips, to prevent cable or conduit pull-out and control arc-of-bend.

Applications

Thread adapters allow the installation of Kellems® Grips on multi-pin connectors at electrical consoles, mobile equipment, control switches, assembly equipment and testing machines.

Benefits

- Easy installation
- Allows the use of Kellems grips
- Extends connector and cable life



091041006
Thread Adapter

Thread Adapters for Multi-Pin Connectors

Thread Adapters					Deluxe Cord Grips		Strain Relief Grips		Liquidtight Conduit Grips (Insulated Throat)
AN-MS Connector Size**	AN-MS Cable Clamp Number***	Thread Size A Inch	NPT Thread Size B	Catalog Number	Cable Diameter Range Inches (cm)	Catalog Number	Cable Diameter Range Inches (cm)	Catalog Number	Catalog Number
8S, 10S	3057-3	1/2" x 28"	3/8"	091041000	.250"-.312" (.63-.79)	07401001	—	—	—
10SL, 12, 12S	3057-4	5/8" x 24"		091041001	.312"-.375" (.79-.95)	07401002			
14, 14S	3057-6	3/4" x 20"		091041002	.375"-.437" (.95-1.11)	07401003			
14, 14S	3057-6	3/4" x 20"	1/2"	091041003	.187"-.250" (.47-.63)	07401004	.24"-.32" (.61-.81)	073031200	—
16, 16S	3057-8	7/8" x 20"		091041004	.250"-.375" (.63-.95)	07401006	.32"-.43" (.81-1.09)	073031201	074093512
18	3057-10	1" x 20"		091041006	.375"-.500" (.95-1.27)	07401008	.43"-.54" (1.09-1.37)	073031202	—
					.500"-.625" (1.27-1.59)	07401010*			
16, 16S	3057-8	7/8" x 20"	3/4"	091041005	.187"-.250" (.47-.63)	07401011	.54"-.74" (1.37-1.85)	073031203	074093513
18	3057-10	1" x 20"		091041007	.250"-.375" (.63-.95)	07401013			
20, 22	3057-12	1 3/16" x 18"		091041008	.375"-.500" (.95-1.27)	07401015			
					.500"-.625" (1.27-1.59)	07401017			
					.625"-.750" (1.59-1.90)	07401018			
20, 22	3057-12	1 3/16" x 18"	1"	091041009	.375"-.500" (.95-1.27)	074011195	.73"-.97" (1.85-2.46)	073031204	074093514
24, 28	3057-16	1 7/16" x 18"		091041010	.500"-.625" (1.27-1.59)	07401019			
32	3057-20	1 3/4" x 18"		091041012	.625"-.750" (1.59-1.90)	07401021			
36	3057-24	2" x 18"		091041015	.750"-.875" (1.90-2.22)	07401023			
					.875"-.1.000" (2.22-2.54)	07401025			
24, 28	3057-16	1 7/16" x 18"	1 1/4"	091041011	.750"-.875" (1.90-2.22)	074011251	.97"-.1.25" (2.46-3.17)	073031205	074093515
32	3057-20	1 3/4" x 18"		091041013	.875"-.1.000" (2.22-2.54)	07401026			
36	3057-24	2" x 18"		091041016	1.000"-.1.125" (2.54-2.86)	07401027			
					1.125"-.1.375" (2.86-3.17)	07401028			
32	3057-20	1 3/4" x 18"	1 1/2"	091041014	.875"-.1.000" (2.22-2.54)	07401029	—	074093516	
36	3057-24	2" x 18"		091041017	1.000"-.1.125" (2.54-2.86)	07401030			
40	3057-28	2 1/4" x 16"		091041019	1.125"-.1.250" (2.86-3.17)	07401031			
					1.250"-.1.375" (3.17-3.49)	07401032			

Note: *Cable jacket may have to be stripped to pass through connector body.

**Number stamped on connector shell.

***Number stamped on clamp shell.

Example

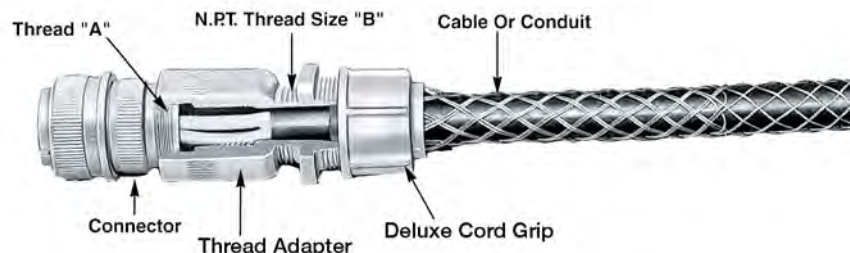

Dimensions in Inches (mm)

Strain Relief for Liquidtight Conduit

Steel Fitting, Stainless Steel Mesh for Liquidtight Metal Conduit and PolyTuff® I Non-Metallic Conduit.

IMPORTANT:

Read all safety and technical data relating to this product.

Refer to pages W-61 through W-68.

Benefits

- Helps prevent conduit pull-out and damage at the fitting
- Reduces equipment downtime

Straight With Male Fitting

Conduit Trade Size Inches	NPT Fitting Size Inches	Mesh Length Inches (cm)	Catalog Number (Insulated)	Catalog Number (Non-insulated)
3/8	1/2	3" (7.62)	074093511	074093401
1/2	1/2	3.5" (8.89)	074093512	074093402
3/4	3/4	4" (10.16)	074093513	074093403
1	1	5" (12.70)	074093514	074093404
1 1/4	1 1/4	6" (15.24)	074093515	074093405
1 1/2	1 1/2	6.75" (17.14)	074093516	074093406
2	2	8" (20.32)	074093518	074093408
2 1/2	2 1/2	9.75" (24.76)	074093520	074093410
3	3	11" (27.94)	074093522	074093412
4	4	14" (35.56)	074093526	—



90° Angle With Male Fitting

Conduit Trade Size Inches	NPT Fitting Size Inches	Mesh Length Inches (cm)	Catalog Number (Insulated)	Catalog Number (Non-insulated)
3/8	1/2	3" (7.62)	074093541	074093421
1/2	1/2	3.5" (8.89)	074093542	074093422
3/4	3/4	4" (10.16)	074093543	074093423
1	1	5" (12.70)	074093544	074093424
1 1/4	1 1/4	6" (15.24)	074093545	074093425
1 1/2	1 1/2	6.75" (17.14)	074093546	074093426
2	2	8" (20.32)	074093548	074093428
2 1/2	2 1/2	9.75" (24.76)	074093550	—
3	3	11" (27.94)	074093552	—



Note: For use with Liquidtight Metal conduit and PolyTuff® I Non-Metallic conduit.

Dimensions in Inches (mm)

Strain Relief for Liquidtight Conduit

Steel Fitting, Stainless Steel Mesh for Liquidtight Metal Conduit and PolyTuff® I Non-Metallic Conduit.

IMPORTANT:

Read all safety and technical data relating to this product.

Refer to pages W-61 through W-68.



Straight With Chase Fitting

Conduit Trade Size Inches	NPT Fitting Size Inches	Mesh Length Inches (cm)	Catalog Number
½	½	3.5" (8.89)	07406079
¾	¾	4" (10.16)	07406080
1	1	5" (12.70)	07406081
1¼	1¼	6" (15.24)	07406082
1½	1½	6.75" (17.14)	07406083



45° Angle With Male Fitting

Conduit Trade Size Inches	NPT Fitting Size Inches	Mesh Length Inches (cm)	Catalog Number (Insulated)
⅜	½	3" (7.62)	074093561
½	½	3.5" (8.89)	074093562
¾	¾	4" (10.16)	074093563
1	1	5" (12.70)	074093564
1¼	1¼	6" (15.24)	074093565
1½	1½	6.75" (17.14)	074093566
2	2	8" (20.32)	074093568

Note: For use with Liquidtight Metal conduit and PolyTuff® I Non-Metallic conduit.

Strain Relief for Liquidtight Conduit

Steel Fitting, Stainless Steel Mesh for UL Type A Liquidtight Conduit.

IMPORTANT:

Read all safety and technical data relating to this product.

Refer to pages W-61 through W-68.

Straight Male Hubbell Fitting

Conduit Trade Size Inches	NPT Fitting Size Inches	Mesh Length		Catalog Number
		Inches	(cm)	
3/8	1/2	3.75"	(9.52)	H038CNK
1/2	1/2	4.5"	(11.43)	H050CNK
3/4	3/4	6.25"	(15.87)	H075CNK
1	1	7.5"	(19.05)	H100CNK
1 1/4	1 1/4	9"	(22.86)	H125CNK
1 1/2	1 1/2	13.5"	(34.29)	H150CNK
2	2	14.5"	(36.83)	H200CNK



90° Male Hubbell Fitting

Conduit Trade Size Inches	NPT Fitting Size Inches	Mesh Length		Catalog Number
		Inches	(cm)	
3/8	1/2	3.75"	(9.52)	H0389CNK
1/2	1/2	4.5"	(11.43)	H0509CNK
3/4	3/4	6.25"	(15.87)	H0759CNK
1	1	7.5"	(19.05)	H1009CNK
1 1/4	1 1/4	9"	(22.86)	H1259CNK
1 1/2	1 1/2	13.5"	(34.29)	H1509CNK
2	2	14.5"	(36.83)	H2009CNK



Dimensions in Inches (mm)

Wire Mesh Grip Materials

Material	Features	Product Group
Galvanized steel wire	<ul style="list-style-type: none"> • High strength • Not subject to continuous outside environment 	<ul style="list-style-type: none"> • Strain relief grips • I-Grips
Stainless steel wire (302/304)	<ul style="list-style-type: none"> • High strength • Corrosion resistant • Slightly magnetic 	<ul style="list-style-type: none"> • Deluxe cord grips • Liquidtight, flexible, metal conduit grips • UL type A conduit grips
Non-metallic strand	<ul style="list-style-type: none"> • Superior flex life • Non-conductive • Corrosion resistant • Moderate strength 	<ul style="list-style-type: none"> • Non-metallic deluxe cord grips

Operating Temperatures

Material	Temperature Range
Aluminum	-40°F to +300°F (-40°C to +149°C).
Aluminum Deluxe Cord Grips	-30°F to +240°F (-34°C to +115°C).
Non-Metallic Deluxe Cord Grips	-30°F to +225°F (-34°C to +107°C).
Nylon	-40°F to +225°F (-40°C to +107°C).
Nylon Fitting with Stainless Steel Mesh	-40°F to +225°F (-40°C to +107°C).
Stainless Steel	-60°F to +1000°F (-51°C to +537°C).
Stainless Steel Deluxe Cord Grips	-30°F to +240°F (-34°C to +115°C).
Neoprene (Bushings)	-30°F to +240°F (-34°C to +115°C).

Hazardous Locations

	Product Categories
The product categories listed to the right are suitable for use in hazardous locations per Class I Div. 2, Class II Div. 1 & 2, Class III Div. 1 & 2.	Deluxe cord grip, aluminum fitting; Deluxe cord grip, nylon fitting; Deluxe cord grip, non-metallic; Seal-Tite® conduit grips; Dusttight strain relief grips.

Flammability

Non-metallic deluxe cord grips will not support combustion. Listed below are the ratings.

Component	Rating
Mesh grip	UL 94HB.
Fitting	UL 94X-2.

Approvals

UL Listing and CSA Certification are indicated on appropriate product catalog pages.

Agency	UL Control Number
Underwriters Laboratories Inc.	898D and 899D.
	UL Listed in accordance with Standard 514B for indoor/outdoor use.

Wet Locations

	Product Categories
The products noted to the right are suitable for use in wet locations when a listed sealing ring is used between box and fitting.	Deluxe cord grip, aluminum fitting; Deluxe sealing ring cord grip; Deluxe cord grip, non-metallic; Seal-Tite® conduit grips; Hubbell non-metallic conduit grips; Cord connectors; Hubbell Juniors; PolyTuff® connectors; Hubbell Seal-Tite® conduit connectors.

Form Size Definition

The term "Form Size" refers to the physical mass or overall dimensions of a cord connector. Form 1 is the smallest size, Form 8 is the largest size.

Knockout Holes

NPT Hub Size Inches	Knockout Hole Recommended Min. to Max. Inches (cm)		
¼	.540"	to	.570" (1.37-1.45)
⅜	.671"	to	.701" (1.70-1.78)
½	.859"	to	.906" (2.18-2.30)
¾	1.094"	to	1.141" (2.78-2.90)
1	1.359"	to	1.406" (3.45-3.57)
1¼	1.719"	to	1.766" (4.37-4.49)
1½	1.969"	to	2.016" (5.00-5.12)
2	2.453"	to	2.500" (6.23-6.35)
2½	2.953"	to	3.000" (7.50-7.62)
3	3.578"	to	3.625" (9.09-9.21)

Product Data

Deluxe Cord Grips, Liquidtight for Insulated Cables

Deluxe Cord Grips helps to alleviate pull tension on terminals, control cable arc-of-bend, prevent cord pull-out, and provide a liquidtight seal. They are offered with either aluminum, stainless steel or nylon fittings in a variety of configurations and NPT thread sizes. Additionally, a completely non-metallic product is offered on page W-53.

Application

Deluxe Cord Grips are used indoors or outdoors to help prevent cord pull-out, and where cables are subjected to moisture, splash or submersion. Specific uses are: wiring enclosures, pendant stations, hand tools, construction, processing and material handling equipment, pumps, motors and machine tools.

Benefits

- Helps to prevent cable pull-out
- Controls cable arc-of-bend
- Provides a liquidtight seal
- Corrosion resistant stainless steel mesh with aluminum collar

Deluxe Cord Grips Fitting Dimensions

Straight Hubbell Connectors

F NPT Inches	Aluminum, Inches (cm)						Nylon, Inches (cm)						Stainless Steel, Inches (cm)							
	A	B	C	D Throat Dia.	E		A	B	C	D Throat Dia.	E		A	B	C	D Throat Dia.	E			
	Form Dia.	Ref.			A/C*	A/F*	Dia.	Ref.			A/C*	A/F*	A/C*	A/F*	Ref.		A/C*	A/F*		
3/8-18	1	.88" (2.24)	.90" (2.29)	.46" (1.17)	.44" (1.12)	.99" (2.51)	.88" (2.24)	1.00" (2.54)	1.10" (2.79)	.43" (1.09)	.45" (1.14)	1.00" (2.54)	.93" (2.36)	1.01" (2.57)	.88" (2.24)	.90" (2.29)	.46" (1.17)	.45" (1.14)	.87" (2.21)	.75" (1.90)
1/2-14	1	.88" (2.24)	.90" (2.29)	.46" (1.17)	.44" (1.12)	.99" (2.51)	.88" (2.24)	1.00" (2.54)	1.10" (2.79)	.43" (1.09)	.45" (1.14)	1.00" (2.54)	.93" (2.36)	—	—	—	—	—	—	—
1/2-14	2	1.13" (2.87)	1.10" (2.79)	.55" (1.40)	.64" (1.63)	1.11" (2.82)	1.00" (2.54)	1.32" (3.35)	1.50" (3.81)	.53" (1.35)	.58" (1.47)	1.25" (3.17)	1.12" (2.84)	1.30" (3.30)	1.13" (2.87)	1.10" (2.79)	.54" (1.37)	.63" (1.60)	1.16" (2.95)	1.00" (2.54)
1/2-14	3	1.38" (3.51)	1.50" (3.81)	.55" (1.40)	.64" (1.63)	1.40" (3.56)	1.25" (3.17)	—	—	—	—	—	—	—	—	—	—	—	—	—
3/4-14	2	1.13" (2.87)	1.10" (2.79)	.55" (1.40)	.64" (1.63)	1.29" (3.28)	1.13" (2.87)	—	—	—	—	—	—	—	—	—	—	—	—	—
3/4-14	3	1.38" (3.51)	1.50" (3.81)	.55" (1.40)	.82" (2.08)	1.40" (3.56)	1.25" (3.17)	1.56" (3.96)	1.60" (4.06)	.55" (1.40)	.77" (1.96)	1.44" (3.66)	1.31" (3.33)	1.59" (4.04)	1.38" (3.51)	1.30" (3.30)	.56" (1.42)	.81" (2.06)	1.44" (3.66)	1.25" (3.17)
1-11 1/2	3	—	—	—	—	—	—	—	—	—	—	—	—	—	—	—	—	—	—	—
1-11 1/2	4	1.75" (4.44)	1.60" (4.06)	.71" (1.80)	1.02" (2.59)	1.81" (4.60)	1.62" (4.11)	1.88" (4.78)	1.75" (4.44)	.70" (1.78)	1.01" (2.57)	1.84" (4.67)	1.63" (4.14)	2.02" (5.13)	1.75" (4.44)	1.40" (3.56)	.70" (1.78)	1.03" (2.62)	1.88" (4.78)	1.63" (4.14)
1-11 1/2	5	2.31" (5.87)	1.70" (4.32)	.66" (1.68)	1.01" (2.57)	2.28" (5.79)	2.00" (5.08)	—	—	—	—	—	—	—	—	—	—	—	—	—
1 1/4-11 1/2	5	2.31" (5.87)	1.70" (4.32)	.74" (1.88)	1.26" (3.20)	2.28" (5.79)	2.12" (5.38)	—	—	—	—	—	—	—	—	—	—	—	—	—
1 1/2-11	5	2.31" (5.87)	1.70" (4.32)	.74" (1.88)	1.38" (3.51)	2.28" (5.79)	2.12" (5.38)	—	—	—	—	—	—	—	—	—	—	—	—	—
1 1/2-11 1/2	6	3.00" (7.62)	2.20" (5.59)	.75" (1.90)	1.50" (3.81)	2.97" (7.54)	2.75" (6.98)	—	—	—	—	—	—	—	—	—	—	—	—	—
2-11 1/2	6	3.00" (7.62)	2.20" (5.59)	.80" (2.03)	1.92" (4.88)	3.24" (8.24)	3.00" (7.62)	—	—	—	—	—	—	—	—	—	—	—	—	—
2-11 1/2	7	3.85" (9.78)	2.70" (6.86)	.88" (2.24)	1.94" (4.93)	4.05" (10.29)	3.75" (9.52)	—	—	—	—	—	—	—	—	—	—	—	—	—
2 1/2-8	7	3.85" (9.78)	2.70" (6.86)	1.30" (3.30)	2.32" (5.89)	4.34" (11.02)	4.02" (10.21)	—	—	—	—	—	—	—	—	—	—	—	—	—
2 1/2-8	8	4.75" (12.06)	2.70" (6.86)	1.25" (3.17)	2.38" (6.05)	4.86" (12.34)	4.50" (11.43)	—	—	—	—	—	—	—	—	—	—	—	—	—
3-8	7	3.85" (9.78)	2.70" (6.86)	1.30" (3.30)	2.54" (6.45)	4.34" (11.02)	4.01" (10.21)	—	—	—	—	—	—	—	—	—	—	—	—	—
3-8	8	4.50" (11.43)	2.70" (6.86)	1.38" (3.51)	3.00" (7.62)	4.86" (12.34)	4.50" (11.43)	—	—	—	—	—	—	—	—	—	—	—	—	—

Note: *A/C— Across Corners; A/F—Across Flats.

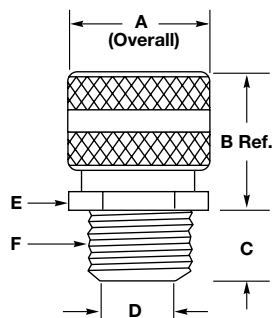

Dimensions shown are approximate and are subject to change without notice.

Deluxe Cord Grips Fitting Dimensions

45° Hubbell Connectors

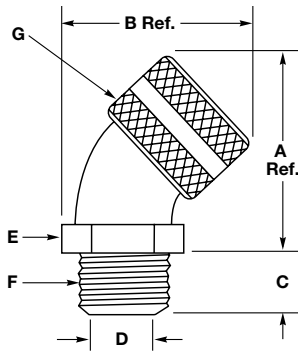

Aluminum, Inches (cm)								
F NPT Inches	Form	A	B	C	D	E		G
		Ref.	Ref.		Throat Dia.	Across Corners	Across Flats	Dia.
½-14	2	2.00" (5.08)	1.90" (4.83)	.550" (1.40)	.560" (1.42)	1.270" (3.23)	1.110" (2.79)	1.125" (2.86)
¾-14	3	2.30" (5.84)	2.50" (6.53)	.560" (1.42)	.750" (1.90)	1.480" (3.76)	1.281" (3.25)	1.375" (3.49)
1-11½	4	2.60" (6.60)	2.80" (7.11)	.700" (1.78)	1.000" (2.54)	1.690" (4.29)	1.500" (3.81)	1.750" (4.44)
1¼-11½	5	3.90" (9.91)	3.90" (9.91)	.740" (1.88)	1.250" (3.17)	2.45" (6.22)	2.125" (5.40)	2.310" (5.87)
1½-11½	5	3.90" (9.91)	3.90" (9.91)	.740" (1.88)	1.500" (3.81)	2.45" (6.22)	2.125" (5.40)	2.310" (5.87)

90° Hubbell Connectors

F NPT Inches	Aluminum, Inches (cm)							Nylon, Inches (cm)							
	Form	A	B	C	D	E		G	A	B	C	D	E		G
		Ref.	Ref.	Throat Dia.	A/C*	A/F*	Dia.		Ref.		Throat Dia.	A/C*	A/F*	Dia.	
¾-18	1	1.27" (3.23)	2.00" (5.08)	.460" (1.17)	.440" (1.12)	1.15" (2.92)	1.10" (2.79)	.875" (2.22)	—	—	—	—	—	—	
½-14	2	1.56" (3.96)	2.30" (5.84)	.500" (1.27)	.546" (1.39)	1.30" (3.30)	1.13" (2.87)	1.125" (2.86)	1.41" (3.58)	2.50" (6.35)	.550" (1.40)	.575" (1.46)	1.23" (3.12)	1.12" (2.82)	1.315" (3.34)
¾-14	3	1.79" (4.55)	2.80" (7.11)	.560" (1.42)	.765" (1.94)	1.49" (3.78)	1.31" (3.33)	1.375" (3.49)	1.65" (4.19)	2.81" (7.14)	.560" (1.42)	.765" (1.94)	1.42" (3.61)	1.29" (3.28)	1.560" (3.96)
1-11½	4	2.08" (5.28)	3.20" (8.13)	.700" (1.78)	1.000" (2.54)	1.70" (4.32)	1.50" (3.81)	1.750" (4.44)	1.99" (5.05)	3.30" (8.38)	.700" (1.78)	1.010" (2.57)	1.82" (4.62)	1.60" (4.06)	1.875" (4.76)
1¼-11½	5	3.18" (8.08)	4.30" (10.92)	.730" (1.85)	1.260" (3.20)	2.47" (6.27)	2.15" (5.46)	2.310" (5.87)	—	—	—	—	—	—	—
1½-11½	5	3.18" (8.08)	4.30" (10.92)	.750" (1.92)	1.500" (3.81)	2.47" (6.27)	2.15" (5.46)	2.310" (5.87)	—	—	—	—	—	—	—
2-11½	6	3.51" (8.92)	5.50" (13.97)	.800" (2.03)	1.920" (4.88)	2.98" (7.57)	2.78" (7.06)	3.000" (7.62)	—	—	—	—	—	—	—

Note: *A/C - Across Corners; A/F - Across Flats.

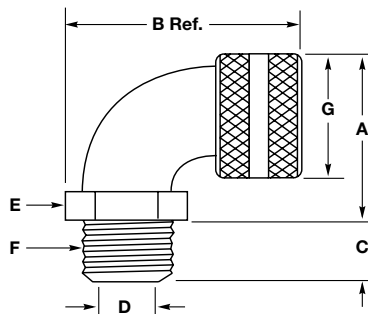

Dimensions shown are approximate and are subject to change without notice.

Deluxe Cord Grips Fitting Dimensions

Female Hubbell Connectors

Aluminum, Inches (cm)							
F NPT Inches	Form	A Dia.	B Ref.	C	D Throat Dia.	E	
						Across Comers	Across Flats
3/8-18	1	.88" (2.24)	1.40" (3.56)	.560" (1.42)	.44" (1.12)	.94" (2.39)	.81" (2.06)
1/2-14	2	1.13" (2.87)	1.80" (4.57)	.560" (1.42)	.63" (1.60)	1.15" (2.92)	1.00" (2.54)
3/4-14	2	1.13" (2.87)	2.10" (5.33)	.750" (1.90)	.63" (1.60)	1.44" (3.66)	1.25" (3.17)
1-11/2	4	1.75" (4.44)	2.30" (5.84)	.880" (2.24)	1.10" (2.79)	1.88" (4.78)	1.63" (4.14)
1 1/4-11 1/2	5	2.31" (5.87)	2.80" (7.11)	.950" (2.41)	1.43" (3.63)	2.64" (6.71)	2.29" (5.82)
1 1/2-11 1/2	5	2.31" (5.87)	2.80" (7.11)	.950" (2.41)	1.43" (3.63)	2.64" (6.71)	2.29" (5.82)

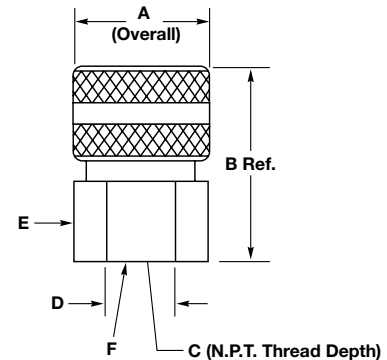

Product Data

Dust-Tight Strain Relief Grips for Insulated Cables

Kellems® Strain Relief Grips connect flexible cord or bus drop cable to electrical enclosures. For indoor use only, they are available with either insulated or non-insulated aluminum fittings, and feature single weave, galvanized steel mesh grips with patented wide range mesh construction. They come with a locknut and a neoprene gasket that provides a dust tight seal.

Application

Used to connect electrical cable to power boxes, cabinets, panel boards, power centers, machine tools and with bus drop systems.

Benefits

- Helps prevent cord or cable pull-out
- Provides a dust tight seal
- Easy installation
- Patented mesh construction
- One piece design

Dimensions shown are approximate and are subject to change without notice.

Strain Relief Grips for Liquidtight Flexible Metal and PolyTuff® I Non-Metallic Conduit

Kellems Liquidtight, Flexible Metal Conduit Grips are offered with high quality Hubbell plated steel fittings in a wide variety of NPT sizes and configurations, either insulated or non-insulated. The addition of a stainless steel mesh to these fittings makes them stronger than the conduit itself. Kellems Conduit Grips helps prevent conduit pull-out from the connecting fitting that is subject to stress, pull tension, vibration, motion or strain. They promote safe electrical systems and reduce equipment downtime.

Application

Kellems Conduit Grips are used in the wiring of machine tools, motors, molding equipment, transformers, weaving and paper machines, fans, lighting, bakeries, breweries, food processing, chemical plants, dairies, mines and any application that requires Liquidtight Conduit.

Benefits

- Helps prevent conduit pull-out and damage at the fitting
- Reduces equipment downtime
- Liquidtight fittings
- Easily installed
- Stainless steel grip resists corrosion

Kellems Conduit Grips are suitable for use in hazardous locations per Class I Div. 2, Class II Div. 1 & 2, Class III Div. 1 & 2 of the National Electric Code.

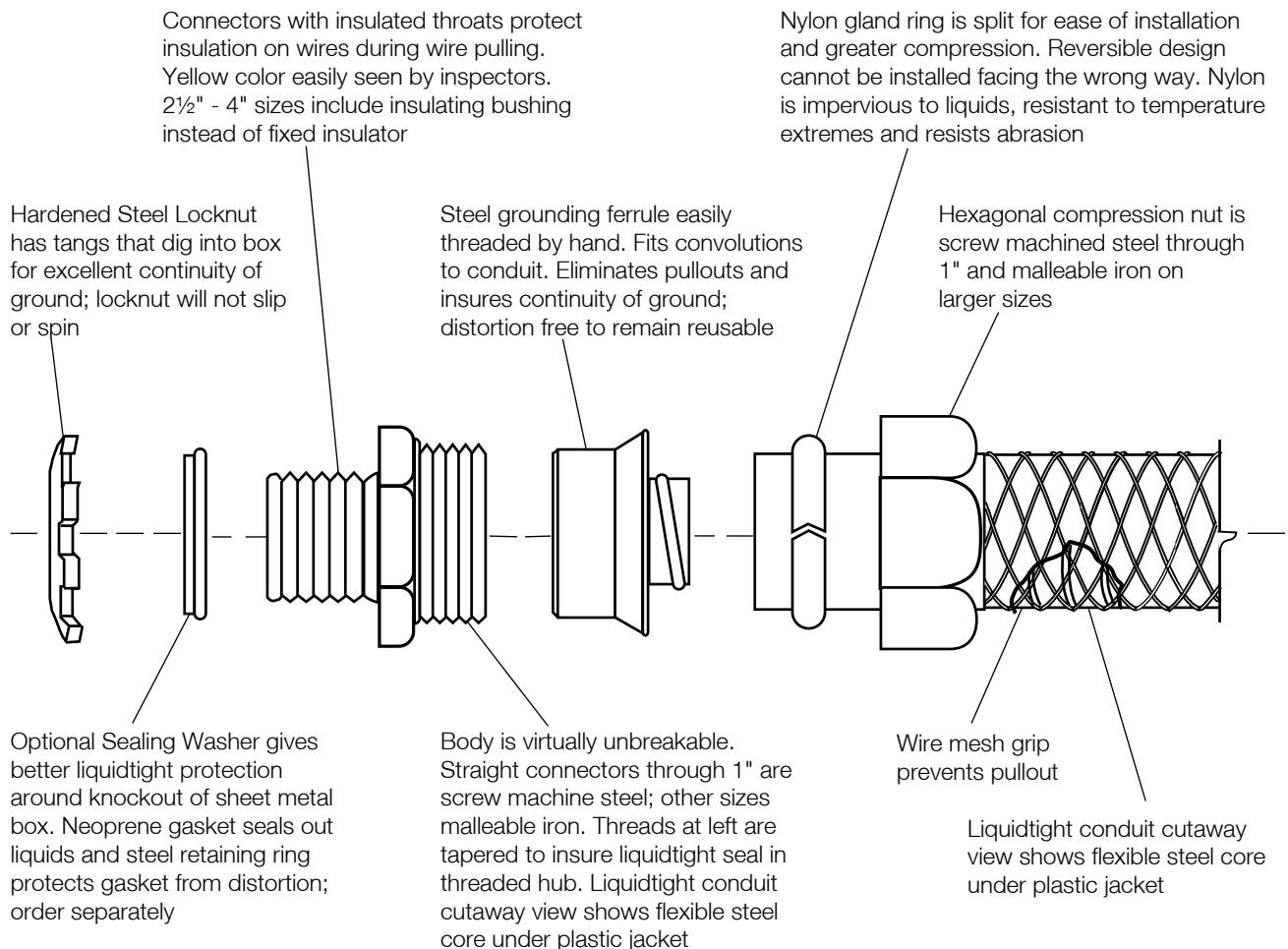

Liquidtight Conduit Grip Fitting Dimensions, Inches

Straight with Male Fitting

Dimensions, Inches

Trade Size Inches	A Ref.	B Ref.	C		D Throat Dia.	E		Catalog Number
			A/C*	A/F*		A/C*	A/F*	
3/8	1.43"	.59"	1.20"	1.06"	.61"	1.07"	.93"	074093401
1/2	1.43"	.59"	1.34"	1.19"	.61"	1.22"	1.06"	074093402
3/4	1.56"	.59"	1.55"	1.37"	.84"	1.43"	1.25"	074093403
1	1.68"	.66"	1.95"	1.69"	1.06"	1.73"	1.56"	074093404
1 1/4	2.03"	.63"	2.39"	2.06"	1.37"	2.36"	2.08"	074093405
1 1/2	2.21"	.63"	2.72"	2.38"	1.53"	2.79"	2.48"	074093406
2	2.28"	.69"	3.08"	2.87"	2.06"	3.32"	2.90"	074093408

Straight with Male Fitting with Insulated Throat

Dimensions, Inches

Trade Size Inches	A Ref.	B Ref.	C		D Throat Dia.	E		Catalog Number
			A/C*	A/F*		A/C*	A/F*	
3/8	1.50"	.66"	1.20"	1.06"	.57"	1.07"	.93"	074093511
1/2	1.50"	.66"	1.34"	1.19"	.57"	1.22"	1.06"	074093512
3/4	1.62"	.66"	1.55"	1.38"	.78"	1.43"	1.25"	074093513
1	1.75"	.72"	1.95"	1.69"	.98"	1.73"	1.56"	074093514
1 1/4	2.09"	.69"	2.39"	2.06"	1.29"	2.36"	2.08"	074093515
1 1/2	2.28"	.69"	2.72"	2.37"	1.53"	2.79"	2.48"	074093516
2	2.34"	.75"	3.08"	2.87"	1.95"	3.32"	2.90"	074093518
2 1/2	3.56"	1.06"	3.92"	3.62"	2.42"	3.85"	3.60"	074093520
3	3.81"	1.06"	4.70"	4.31"	3.01"	4.65"	4.33"	074093522
4	3.81"	1.06"	5.75"	5.31"	3.96"	5.75"	5.39"	074093526

45° Angle with Male Fitting

Dimensions, Inches

Trade Size Inches	H Ref.	J Ref.	K Ref.	L		M Throat Dia.	N		Catalog Number
				A/C*	A/F*		A/C*	A/F*	
3/8	1.19"	1.28"	.59"	1.20"	1.06"	.60"	1.16"	1.02"	074093441
1/2	1.19"	1.28"	.59"	1.34"	1.19"	.61"	1.21"	1.06"	074093442
3/4	1.19"	1.43"	.59"	1.55"	1.45"	.84"	1.50"	1.32"	074093443
1	1.38"	1.53"	.66"	1.95"	1.69"	1.05"	1.82"	1.59"	074093444
1 1/4	1.42"	1.69"	.63"	2.39"	2.06"	1.37"	2.32"	2.03"	074093445
1 1/2	1.66"	2.00"	.66"	2.72"	2.38"	1.60"	2.62"	2.29"	074093446
2	1.69"	2.25"	.66"	3.08"	2.88"	2.05"	3.21"	2.80"	074093448

45° Angle with Male Fitting with Insulated Throat

Dimensions, Inches

Trade Size Inches	H Ref.	J Ref.	K Ref.	L		M Throat Dia.	N		Catalog Number
				A/C*	A/F*		A/C*	A/F*	
3/8	1.25"	1.28"	.66"	1.20"	1.06"	.57"	1.16"	1.02"	074093561
1/2	1.25"	1.28"	.66"	1.34"	1.19"	.57"	1.21"	1.06"	074093562
3/4	1.25"	1.44"	.66"	1.55"	1.45"	.78"	1.50"	1.32"	074093563
1	1.44"	1.53"	.72"	1.95"	1.69"	.98"	1.82"	1.59"	074093564
1 1/4	1.48"	1.69"	.69"	2.39"	2.06"	1.29"	2.32"	2.03"	074093565
1 1/2	1.72"	2.00"	.72"	2.72"	2.38"	1.53"	2.62"	2.29"	074093566
2	1.75"	2.25"	.72"	3.08"	2.87"	1.95"	3.21"	2.80"	074093568

90° Angle with Male Fitting

Dimensions, Inches

Trade Size Inches	D Ref.	E Ref.	F		G Ref.	O Throat Dia.	P		Catalog Number
			A/C*	A/F*			A/C*	A/F*	
3/8	1.31"	.59"	1.20"	1.06"	1.44"	.60"	1.13"	.99"	074093421
1/2	1.31"	.59"	1.34"	1.12"	1.44"	.61"	1.21"	1.00"	074093422
3/4	1.44"	.59"	1.55"	1.45"	1.63"	.83"	1.48"	1.29"	074093423
1	1.78"	.66"	1.95"	1.60"	2.19"	1.05"	1.80"	1.57"	074093424
1 1/4	1.97"	.63"	2.39"	2.06"	2.50"	1.37"	2.32"	2.02"	074093425
1 1/2	2.19"	.66"	2.72"	2.38"	2.69"	1.61"	2.58"	2.25"	074093426
2	2.53"	.66"	3.08"	2.87"	3.25"	2.05"	3.14"	2.75"	074093428

90° Angle with Male Fitting with Insulated Throat

Dimensions, Inches

Trade Size Inches	D Ref.	E Ref.	F		G Ref.	O Throat Dia.	P		Catalog Number
			A/C*	A/F*			A/C*	A/F*	
3/8	1.38"	.66"	1.20"	1.06"	1.44"	.60"	1.13"	.99"	074093541
1/2	1.38"	.66"	1.34"	1.12"	1.44"	.57"	1.21"	1.00"	074093542
3/4	1.50"	.66"	1.55"	1.45"	1.63"	.78"	1.48"	1.29"	074093543
1	1.84"	.66"	1.95"	1.60"	2.19"	.98"	1.80"	1.57"	074093544
1 1/4	2.03"	.69"	2.39"	2.06"	2.50"	1.29"	2.32"	2.02"	074093545
1 1/2	2.25"	.69"	2.72"	2.38"	2.69"	1.53"	2.58"	2.20"	074093546
2	2.59"	.72"	3.08"	2.87"	3.25"	1.95"	3.14"	2.75"	074093548
2 1/2	3.44"	1.00"	3.92"	3.63"	4.25"	2.42"	3.78"	3.50"	074093550
3	3.75"	1.00"	4.70"	4.31"	4.87"	3.01"	4.64"	4.30"	074093552

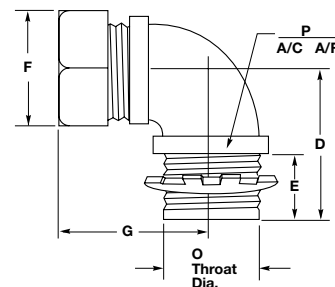
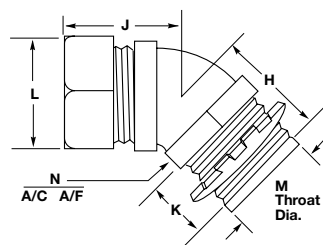
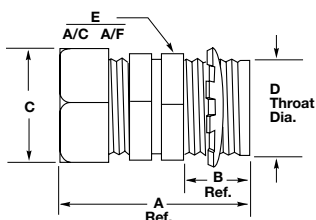

Dimensions shown are approximate and are subject to change without notice.

Strain Relief for UL Type A, Flexible, Liquidtight Conduit

Kellems Grips for UL Type A, non-metallic, flexible, liquidtight conduit are available in straight and 90° male and feature a high quality Hubbell plated steel or malleable iron fitting, complete with a sealing O-ring, lock nut and stainless steel mesh. These grips increase the retention of the conduit in the fitting, control its arc-of-bend and provide a liquidtight seal.

Application

These grips are used on UL Type A non-metallic conduit connections at limit switches, motor boxes, panel boards, control stations and on all types of machinery and machine tools.

Steel Locknut has tangs that dig into box for excellent continuity of ground; locknut will not slip or spin

Benefits

- Provides a liquidtight seal
- Helps prevent conduit pull-out
- Reduces conduit cutting, kinking, fraying and splitting at the fitting
- Easily installed

Body is virtually unbreakable. Straight connectors through 1" are screw machine steel; other sizes are malleable iron. Threads are tapered to insure liquidtight seal when used in threaded hub; octagonal shape inside holds the ferrule to prevent conduit from twisting during installation

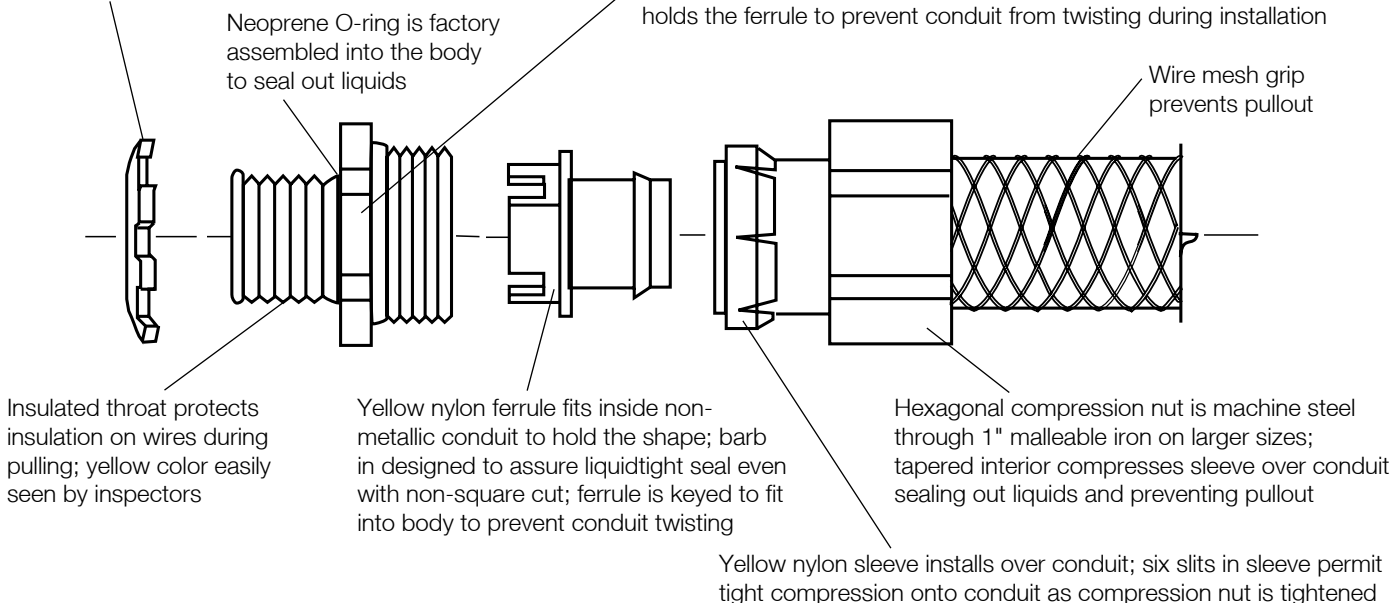

Dimensional Charts For UL Type A, Liquidtight Conduit Grip Fittings

Straight with Male Fitting with Insulated Throat

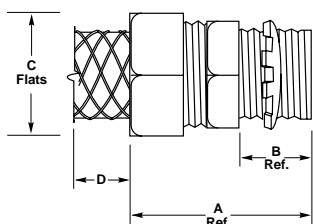

Dimensions Inches (cm)

Trade Size NPT Inches	A	B	C	D	Catalog Number
3/8	1.922" (4.88)	.594" (1.51)	1.156" (2.94)	3.75" (9.52)	H038CNK
1/2	1.922" (4.88)	.594" (1.51)	1.250" (3.17)	4.50" (11.43)	H050CNK
3/4	2.016" (5.12)	.594" (1.51)	1.500" (3.81)	6.25" (15.87)	H075CNK
1	2.157" (5.48)	.719" (1.83)	1.844" (4.68)	7.50" (19.05)	H100CNK
1 1/4	2.219" (5.64)	.750" (1.91)	2.312" (5.87)	9.00" (22.86)	H125CNK
1 1/2	2.344" (5.95)	.750" (1.91)	2.578" (6.55)	13.50" (34.29)	H150CNK
2	2.406" (6.11)	.750" (1.91)	3.187" (8.09)	14.50" (36.83)	H200CNK

90° Angle with Male Fitting with Insulated Throat

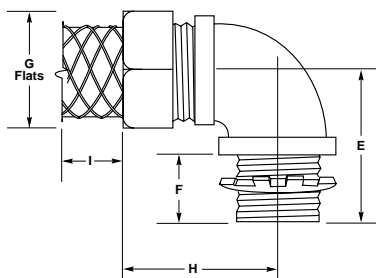

Dimensions Inches (cm)

Trade Size NPT Inches	E	F	G	H	I	Catalog Number
3/8	1.250" (3.18)	.594" (1.51)	1.156" (2.94)	1.453" (3.69)	3.75" (9.52)	H0389CNK
1/2	1.281" (3.25)	.594" (1.51)	1.250" (3.17)	1.453" (3.69)	4.50" (11.43)	H0509CNK
3/4	1.438" (3.65)	.594" (1.51)	1.500" (3.81)	1.000" (2.54)	6.25" (15.87)	H0759CNK
1	1.750" (4.44)	.719" (1.83)	1.844" (4.68)	2.125" (5.40)	7.50" (19.05)	H1009CNK
1 1/4	1.969" (5.00)	.750" (1.91)	2.312" (5.87)	2.344" (5.95)	9.00" (22.86)	H1259CNK
1 1/2	2.250" (5.71)	.750" (1.91)	2.578" (6.55)	2.500" (6.35)	13.50" (34.29)	H1509CNK
2	2.531" (6.43)	.750" (1.91)	3.187" (8.09)	2.781" (7.06)	14.50" (36.83)	H2009CNK

Kellems® Wire Management Products

Features and Benefits

Cord Connectors

Hubbell has the broadest line and the widest choice of materials in the industry. NPT hub sizes from 1/4" to 3" in straight male end, 90°, 45°, female and underground feed connectors. They are available in your choice of aluminum, plated steel, nylon and stainless steel.

The zinc-plated steel cord connectors offers the strength of steel and the corrosion resistance of zinc-plating. These heavy-duty connectors hold up to most manufacturing chemicals including acid solutions, solvents and other corrosive materials.

Their machined steel nut and body allows for tightening the compression nut and NPT hub without worrying about stripping the threads. For larger size cord, NPT hub sizes 1" to 2", Hubbell utilizes malleable iron connectors which provide excellent holding and liquidtight performance.

Hubbell's nylon cord connectors resist most common industrial corrosives and provide highly effective pullout protection in a lightweight design. They are ideal for any application where weight, conductivity or corrosion may be an issue. They're available in NPT hub sizes from 1/4" to 1".

Stainless steel cord connectors provide superior strength and corrosion resistance for industrial and military applications. They are machined from 300 series stainless steel and come in 1/4" to 1", NPT hub sizes.

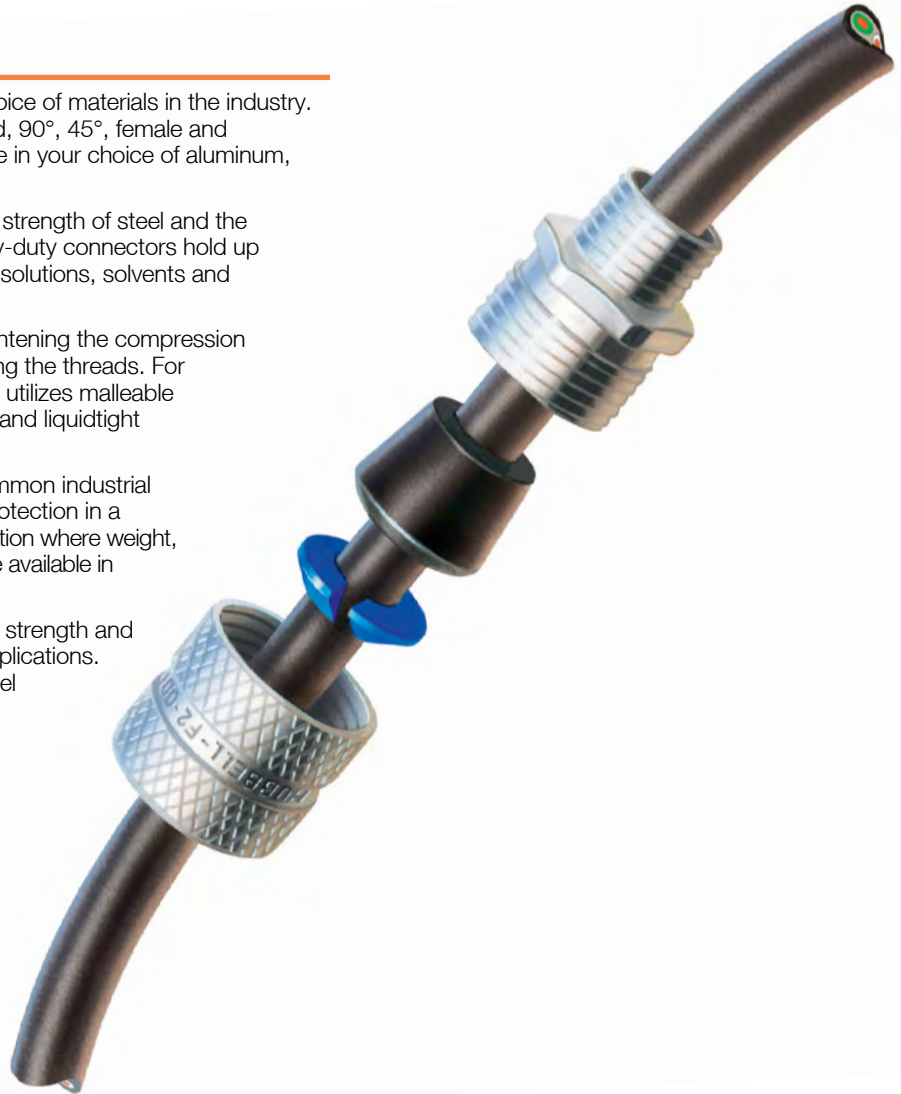

Liquidtight Seal

- Lubricated neoprene bushing compresses easily for a liquidtight seal and added pull-out protection
- The connector body is a one-piece design with machined threads; a tapered interior seats the bushing evenly for a liquidtight seal



Connector Body

- Machined threads provide a strong positive seal; the tapered interior dome easily drives the bushing into the connector body



Connector Identification

- The patented GOTCHA® ring incorporates a split hinge design to prevent friction and provide strain relief, also color-coded for sizing identification



Comprehensive Offering

- Hubbell offers a full line of machined aluminum cord connectors in NPT hub sizes 1/4" through 1" and cast aluminum 1" to 3"
- They provide durable performance and a clean attractive look without adding unwanted weight; NPT hub sizes 1/4" to 1" feature an attractive knurled finish which makes them easy to handle

Straight Male Cord Connectors

IP66*
SUITABILITY

Form Size 1-4



Straight Male

NPT Hub Size	Cord Dia. Inches (mm)	Form Size	Color Code	Machined Aluminum	Machined Zinc-Plated Steel	Stainless Steel	Nylon Gray	Nylon Black
1/4	.06"-.13" (1.6-3.2)	F1	Green	—	—	—	SHC1001CR	—
	.13"-.19" (3.2-4.7)		Orange	SHC1002	—	—	SHC1002CR	—
	.19"-.25" (4.7-6.3)		Red	SHC1003	—	SHC1003SS	SHC1003CR	—
	.25"-.31" (6.3-7.9)		Black	SHC1004	—	SHC1004SS	SHC1004CR	—
	.31"-.38" (7.9-9.5)		White	SHC1005**	—	—	SHC1005CR	SHC2005CR
	.38"-.44" (9.5-11)		Blue	—	—	—	SHC1006CR	—
3/8	.06"-.13" (1.6-3.2)	F1	Green	SHC1007	—	—	—	—
	.13"-.19" (3.2-4.7)		Orange	SHC1008	SHC1008ZP	—	SHC1008CR	SHC2008CR
	.19"-.25" (4.7-6.3)		Red	SHC1009	—	SHC1009SS	SHC1009CR	—
	.25"-.31" (6.3-7.9)		Black	SHC1010	SHC1010ZP	—	SHC1010CR	SHC2010CR
	.31"-.38" (7.9-9.5)		White	SHC1011	—	SHC1011SS	SHC1011CR	SHC2011CR
	.38"-.44" (9.5-11.0)		Blue	SHC1012	SHC1012ZP	SHC1012SS	SHC1012CR	SHC2012CR
1/2	.19"-.25" (4.7-6.3)	F1	Red	SHC1015	—	—	—	—
	.25"-.31" (6.3-7.9)		Black	SHC1016	—	—	—	—
	.31"-.38" (7.9-9.5)		White	SHC1017	—	—	—	—
	.38"-.44" (9.5-11.0)		Blue	SHC1018	—	—	—	—
1/2	.06"-.13" (1.6-3.2)	F2	Green	SHC1019	—	—	SHC1019CR	—
	.13"-.19" (3.2-4.7)		Orange	SHC1020	SHC1020ZP	SHC1020SS	SHC1020CR	—
	.19"-.25" (4.7-6.3)		Red	SHC1021	SHC1021ZP	SHC1021SS	SHC1021CR	SHC2021CR
	.25"-.38" (6.3-9.7)		White	SHC1022	SHC1022ZP	SHC1022SS	SHC1022CR	SHC2022CR
	.38"-.50" (9.7-12.7)		Blue	SHC1023	SHC1023ZP	SHC1023SS	SHC1023CR	SHC2023CR
	.50"-.63" (12.7-15.9)		Brown	SHC1024	SHC1024ZP	SHC1024SS	SHC1024CR**	SHC2024CR**
1/2	.38"-.50" (9.7-12.7)	F3	Blue	SHC1025	—	—	—	—
	.50"-.63" (12.7-15.9)		Brown	SHC1026	—	—	—	—
	.63"-.75" (15.9-19.0)		Yellow	SHC1027**	SHC1027ZP**	—	—	—
	.75"-.88" (19.0-22.2)		Orchid	SHC1028**	SHC1028ZP**	—	—	—
3/4	.06"-.13" (1.6-3.2)	F2	Green	SHC1029	—	—	—	—
	.13"-.19" (3.2-4.7)		Orange	SHC1030	SHC1030ZP	—	—	—
	.19"-.25" (4.7-6.3)		Red	SHC1031	SHC1031ZP	—	—	—
	.25"-.38" (6.3-9.7)		White	SHC1032	SHC1032ZP	—	—	—
	.38"-.50" (9.7-12.7)		Blue	SHC1033	SHC1033ZP	—	—	—
	.50"-.63" (12.7-15.9)		Brown	SHC1034	SHC1034ZP	—	—	—
3/4	.38"-.50" (9.5-12.7)	F3	Blue	—	SHC1035ZP	SHC1035SS	SHC1035CR	SHC2035CR
	.50"-.63" (12.7-15.9)		Brown	SHC1036	—	SHC1036SS	SHC1036CR	SHC2036CR
	.63"-.75" (15.9-19.0)		Yellow	SHC1037	SHC1037ZP	SHC1037SS	SHC1037CR	SHC2037CR
	.75"-.88" (19.0-22.2)		Orchid	SHC1038**	SHC1038ZP**	SHC1038SS**	SHC1038CR**	SHC2038CR**
1	.50"-.63" (12.7-15.9)	F3	Brown	—	SHC1097ZP	—	—	—
	.63"-.75" (15.9-19.0)		Yellow	—	SHC1098ZP	—	—	—
	.75"-.88" (19.0-22.2)		Orchid	—	SHC1099ZP	—	—	—
1	.38"-.50" (9.7-12.7)	F4	Blue	SHC1039	—	—	SHC1039CR	—
	.50"-.63" (12.7-15.9)		Brown	SHC1040	—	—	SHC1040CR	SHC2040CR
	.63"-.75" (15.9-19.0)		Yellow	SHC1041	—	SHC1041SS	SHC1041CR	SHC2041CR
	.75"-.88" (19.0-22.2)		Orchid	SHC1042	—	SHC1042SS	SHC1042CR	SHC2042CR
	.88"-.1.00" (22.2-25.4)		Gray	SHC1043	SHC1043ZP	SHC1043SS	SHC1043CR	SHC2043CR
	1.00"-.1.13" (25.4-28.6)		Pink	SHC1044**	—	SHC1044SS**	SHC1044CR**	SHC2044CR**

Note: See pages W-78 to W-88 for technical information and dimensional drawings.
 *IP66 Suitability when used with optional metal clad O-ring, see page W-75 for additional information.
 **Cable jacket may have to be stripped to pass through connector body.
 Form 4 aluminum and plated steel nuts are machined, bodies are cast aluminum.
 Locknuts sold separately. See page W-75 for additional information.

Straight Male Cord Connectors

IP66*
SUITABILITY

Form Size 5-8



Straight Male

NPT Hub Size	Cord Diameter Inches (mm)	Form Size	Cast Aluminum	Malleable Iron
1	.88"-1.00" (22.2-25.4)	F5	SHC1046	—
	1.00"-1.13" (25.4-28.6)		SHC1047**	—
	1.13"-1.25" (28.6-31.7)		SHC1048**	—
	1.25"-1.38" (31.7-34.9)		SHC1049**	—
1¼	.75"-.88" (19.0-22.2)	F5	SHC1050	—
	.88"-1.00" (22.2-25.4)		SHC1051	—
	1.00"-1.13" (25.4-28.6)		SHC1052	SHC1052ZP
	1.13"-1.25" (28.6-31.7)		SHC1053	SHC1053ZP
1½	1.25"-1.38" (31.7-34.9)	F5	SHC1054**	SHC1054ZP
	.75"-.88" (19.0-22.2)		SHC1055	—
	.88"-1.00" (22.2-25.4)		SHC1056	—
	1.00"-1.13" (25.4-28.6)		SHC1057	SHC1057ZP
1½	1.13"-1.25" (28.6-31.7)	F5	SHC1058	SHC1058ZP
	1.25"-1.38" (31.7-34.9)		SHC1059	SHC1059ZP
	1.38"-1.50" (34.9-38.1)		SHC1061	—
	1.50"-1.63" (38.1-41.3)		SHC1062**	—
2	1.63"-1.75" (41.3-44.4)	F6	SHC1063**	—
	1.75"-1.88" (44.4-47.6)		SHC1064**	—
	1.25"-1.38" (31.7-34.9)		SHC1065	—
	1.38"-1.50" (34.9-38.1)		SHC1066	—
2	1.50"-1.63" (38.1-41.3)	F6	SHC1067	—
	1.63"-1.75" (41.3-44.4)		SHC1068	—
	1.75"-1.88" (44.4-47.6)		SHC1069	—
	1.69"-1.81" (42.9-46.0)		SHC1070	—
2	1.81"-1.94" (46.0-49.2)	F7	SHC1071	—
	1.94"-2.06" (49.2-52.4)		SHC1072**	—
	2.06"-2.19" (52.4-55.6)		SHC1073**	—
	2.19"-2.31" (55.6-58.7)		SHC1074**	—
2½	1.69"-1.81" (42.9-46.0)	F7	SHC1076	—
	1.81"-1.94" (46.0-49.2)		SHC1077	—
	1.94"-2.06" (49.2-52.4)		SHC1078	—
	2.06"-2.19" (52.4-55.6)		SHC1079	—
3	2.19"-2.31" (55.6-58.7)	F7	SHC1080	—
	2.31"-2.44" (58.7-61.9)		SHC1081**	—
	1.69"-1.81" (42.9-46.0)		SHC1086	—
	1.94"-2.06" (49.2-52.4)		SHC1088	—
3	2.06"-2.19" (52.4-55.6)	F7	SHC1089	—
	2.19"-2.31" (55.6-58.7)		SHC1090	—
	2.31"-2.44" (58.7-61.9)		SHC1091	—
	2.44"-2.63" (61.9-66.7)		SHC1092	—
3	2.63"-2.81" (66.7-71.4)	F8	SHC1093	—
	2.81"-3.00" (71.4-76.2)		SHC1094	—
	3.00"-3.25" (76.2-82.5)		SHC1095**	—

Note: See pages W-78 to W-88 for technical information and dimensional drawings.

*IP66 Suitability when used with optional metal clad O-ring, see page W-75 for additional information.

**Cable jacket may have to be stripped to pass through connector body.

Locknuts sold separately. See page W-75 for additional information.

45° and 90° Male Cord Connectors

IP66*
SUITABILITY

Form Size 1-6



90° Male

NPT Hub Size	Cord Diameter Inches (mm)	Form Size	Color Code	Machined Aluminum†	Machined Zinc-Plated SteelΔ	Cast Aluminum	Nylon Gray	Nylon Black
3/8	.25"-.31" (6.3-7.9)	F1	Black	NHC1010	—	—	—	—
	.31"-.38" (7.9-9.5)		White	NHC1011	—	—	—	—
	.38"-.44" (9.5-11.0)		Blue	NHC1012	—	—	—	—
1/2	.06"-.13" (1.6-3.2)	F2	Green	—	—	—	—	—
	.13"-.19" (3.2-4.7)		Orange	NHC1020	—	—	NHC1020CR	—
	.19"-.25" (4.7-6.3)		Red	NHC1021	NHC1021ZP	—	NHC1021CR	—
	.25"-.38" (6.3-9.7)		White	NHC1022	NHC1022ZP	—	NHC1022CR	NHC2022CR
	.38"-.50" (9.7-12.7)		Blue	NHC1023	NHC1023ZP	—	NHC1023CR	NHC2023CR
	.50"-.63" (12.7-15.9)		Brown	NHC1024**	NHC1024ZP**	—	NHC1024CR**	NHC2024CR**
3/4	.38"-.50" (9.7-12.7)	F3	Blue	NHC1035	NHC1035ZP	—	NHC1035CR	—
	.50"-.63" (12.7-15.9)		Brown	NHC1036	NHC1036ZP	—	NHC1036CR	—
	.63"-.75" (15.9-19.0)		Yellow	NHC1037	NHC1037ZP	—	NHC1037CR	—
	.75"-.88" (19.0-22.2)		Orchid	NHC1038	NHC1038ZP	—	NHC1038CR	—
1	.50"-.63" (12.7-15.9)	F4	Brown	NHC1040	—	—	—	—
	.63"-.75" (15.9-19.0)		Yellow	NHC1041	NHC1041ZP	—	NHC1041CR	NHC2041CR
	.75"-.88" (19.0-22.2)		Orchid	NHC1042	—	—	NHC1042CR	NHC2042CR**
	.88"-.1.00" (22.2-25.4)		Gray	NHC1043**	—	—	NHC1043CR	—
1 1/4	1.00"-1.13" (25.4-28.7)	F5	Pink	NHC1044**	—	—	—	—
	.88"-.1.00" (22.2-25.4)		—	—	—	NHC1051	—	—
	1.00"-1.13" (25.4-28.6)		—	—	—	NHC1052	—	—
	1.13"-1.25" (28.6-31.7)		—	—	—	NHC1053**	—	—
1 1/2	1.25"-1.38" (31.7-34.9)	F5	—	—	—	NHC1054**	—	—
	1.00"-1.13" (25.4-28.6)		—	—	—	NHC1057	—	—
	1.13"-1.25" (28.6-31.7)		—	—	—	—	—	—
	1.25"-1.38" (31.7-34.9)		—	—	—	NHC1059	—	—
2	1.38"-1.50" (34.9-38.1)	F6	—	—	—	NHC1066	—	—
	1.50"-1.63" (38.1-41.3)		—	—	—	NHC1067	—	—



45° Male

NPT Hub Size	Cord Diameter Inches (mm)	Form Size	Color Code	Machined Aluminum†	Machined Zinc-Plated SteelΔ	Cast Aluminum
1/2	.19"-.25" (4.7-6.3)	F2	Red	VHC1021	—	—
	.25"-.38" (6.3-9.7)		White	VHC1022	VHC1022ZP	—
	.38"-.50" (9.7-12.7)		Blue	VHC1023	VHC1023ZP	—
	.50"-.63" (12.7-15.9)		Brown	VHC1024**	VHC1024ZP**	—
3/4	.38"-.50" (9.7-12.7)	F3	Blue	VHC1035	—	—
	.50"-.63" (12.7-15.9)		Brown	VHC1036	—	—
	.63"-.75" (15.9-19.0)		Yellow	VHC1037**	—	—
1	.63"-.75" (15.9-19.0)	F4	Yellow	VHC1041	—	—
	.75"-.88" (19.0-22.2)		Orchid	VHC1042	—	—
1 1/4	1.00"-1.13" (25.4-28.6)	F5	—	—	—	VHC1052
	1.13"-1.25" (28.6-31.7)		—	—	—	VHC1053**

Note: See pages W-78 to W-88 for technical information and dimensional drawings.

*IP66 Suitability when used with optional metal clad O-ring, see page W-75 for additional information.

**Cable jacket may have to be stripped to pass through connector body.

†Nuts are machined aluminum and bodies are cast aluminum.

ΔCompression nuts are machined zinc-plated steel and bodies are zinc-plated malleable iron.

Locknuts sold separately. See page W-75 for additional information.

Straight Female, Underground Feeder and Metric Connectors

Form Size 1-4



Straight Female



NPT Hub Size	Cord Diameter Inches (mm)	Form Size	Color Code	Machined Aluminum
½	.25"-.38" (6.3-9.7)	F2	White	FHC1022
	.38"-.50" (9.7-12.7)		Blue	FHC1023
¾	.38"-.50" (9.7-12.7)	F2	Blue	FHC1033
	.50"-.63" (12.7-15.9)		Brown	FHC1034
1	.75"-.88" (19.0-22.2)	F4	Orchid	FHC1042†
	.88"-.1.00" (22.2-25.4)		Gray	FHC1043†

Note: See pages W-78 to W-88 for technical information and dimensional drawings.

*Cable jacket may have to be stripped to pass through connector body.

†Nuts are machined aluminum and bodies are cast aluminum.



IP66*
SUITABILITY



Underground Feeder Connectors

NPT Hub Size	Cord Diameter Inches (mm)	Wire Size	UF** Machined Aluminum	Machined Zinc-Plated Steel	Nylon Gray	Nylon Black
½	.2"x.4" min (5.1 x 10.2) .25"-.55" max (6.3 x 14.0)	2 # 14,	UFC0001	UFC0001ZP	UFC0001CR	UFC2001CR
		2 # 12,				
		2 # 10.				
¾	.2"x.4" min (5.1x10.2) .25"-.55" max (6.3x14.0)	2 # 14,	UFC0002	—	—	—
		2 # 12,				
		2 # 10.				
¾	.2"x.6" min (5.1x15.2) .26"x.78" max (6.6x19.8)	3 # 14,	UFC0003	—	UFC0003CR	UFC2003CR
		3 # 12,				
		3 # 10.				

Note: See pages W-78 to W-88 for technical information and dimensional drawings.

*IP66 Suitability when used with optional metal clad O-ring, see page W-75 for additional information.

**Wire sizes vary among manufacturers.

Locknuts sold separately, see page W-75 for additional information.



UL Listed to
Type 4, 4X, 12 and 13†

Metric Aluminum Cord Connectors



Metric Hub Size	Cord Diameter Inches (mm)	Form Size	Color Code	Catalog Number
M16	.31"-.38" (7.9-9.7)	F1	White	SHCM161011
M20	.31"-.38" (7.9-9.7)	F1	White	SHCM201017
M20	.25"-.38" (6.3-9.7) .38"-.50" (9.7-12.7) .50"-.62" (12.7-15.8)	F2	White	SHCM201022
			Blue	SHCM201023
			Brown	SHCM201024
M25	.38"-.50" (9.7-12.7) .50"-.62" (12.7-15.8)	F2	Blue	SHCM251033
			Brown	SHCM251034
M30	.63"-.75" (15.9-19.0)	F3	Yellow	SHCM301037

Note: †When used with metal clad O-ring, see page W-75 for additional information.

Non-metallic Locknuts sold separately, see page W-75 for additional information.

Low Profile NPT, PG and Metric Thread Connectors

Non-Metallic Cord Connectors.

IP66*
SUITABILITY



Low Profile NPT Cord Connectors

NPT Hub Size	Cord Diameter Inches (mm)	Black	Gray	Non-metallic Locknuts
3/8	.18"-.31" (4.6-7.9)	SEC38BA*	SEC38GA*	31622002LPK50
1/2	.17"-.45" (4.3-11.4)	SEC50BA	SEC50GA	31622003LPK50
3/4	.25"-.48" (6.35-12.19)	—	SEC75RGA	31622007LPK50
3/4	.45"-.71" (11.4-18.0)	SEC75BA	SEC75GA	31622007LPK50
1	.59"-1.00" (15-25.4)	SEC100BA	SEC100GA	31622008LPK50

Note: See pages W-78 to W-88 for technical information and dimensional drawings.
Catalog numbers with "PK50" suffix are bulk packed 50 pieces.

Low Profile PG^A Cord Connectors

Hub Size	Cord Diameter Inches (mm)	Black	Gray	Non-metallic Locknuts
PG7	.11"-.25" (2.9-6.4)	SECP7BA*	SECP7GA*	LNP7BPK100
PG9	.18"-.31" (4.6-7.9)	SECP9BA*	SECP9GA*	LNP9BPK100
PG11	.23"-.40" (5.8-10.0)	SECP11BA*	SECP11GA*	LNP11BPK100
PG13.5	.17"-.47" (4.3-11.9)	SECP13BA	SECP13GA	LNP13BPK100
PG16	.23"-.53" (5.8-13.5)	SECP16BA	SECP16GA	LNP16BPK100
PG21	.45"-.71" (11.4-17.9)	SECP21BA	SECP21GA	LNP21BPK100
PG29	.59"-.99" (15-25.2)	SECP29BA	SECP29GA	LNP29BPK25
PG36	.88"-1.30" (22.2-32.0)	SECP36BA	SECP36GA	LNP36BPK25

Low Profile Metric Cord Connectors

Hub Size	Cord Diameter Inches (mm)	Black	Gray	Non-metallic Locknuts
M12	.12"-.25" (2.9-6.4)	SECM12B	SECM12G	LNM12BPK100
M16	.11"-.31" (2.7-7.9)	SECM16B	SECM16G	LNM16BPK100
M20	.17"-.45" (4.3-11.4)	SECM20B*	SECM20G*	LNM20BPK100
M25	.49"-.71" (12.3-18.0)	SECM25B*	SECM25G*	LNM25BPK100
M32	.59"-1.00" (15.0-25.4)	SECM32B*	SECM32G*	LNM32BPK100
M40	.87"-1.30" (22.0-32.0)	SECM40B	SECM40G	LNM40BPK100

Note: See pages W-78 to W-88 for technical information and dimensional drawings.
Catalog numbers above with "PK100" suffix, i.e. LNP7BPK100, are bulk packed 100 per carton.
Catalog numbers above with "PK25" suffix, i.e. LNP29BPK25, are bulk packed 25 per carton.
*Items indicated are UL recognized components.
ΔPanzergewinde.



Low Profile Multi-Hole Cord Grip Connectors

NPT Hub Size	Cord Diameter Inches (mm)	Color	Material	Holes	Catalog Number
1/2	.205" (5.2mm)	Black	Nylon	2	SEC50B252
3/4	.205" (5.2mm)	Black	Nylon	3	SEC75B352
3/4	.205" (5.2mm)	Black	Nylon	4	SEC75B452
1/2	.220" (5.6mm)	Black	Nylon	3	SEC50B356
1	.215" (5.5mm)	Black	Nylon	9*	SEC100BSMH9
1 1/4	.215" (5.5mm)	Black	Nylon	13*	SEC125BSMH13

Note: *Skinned bushings, field configurable.

Accessories



Multi-Hole Cord Grip Connectors

NPT Hub Size	Cord Diameter Inches (mm)	Form Size	Material	Holes	Catalog Number
1/2	0.23-0.29" (5.8-7.4mm)	F2	Aluminum	2	MHC1022
3/4	0.23-0.29" (5.8-7.4mm)	F3	Aluminum	4	MHC1032
1/2	0.23-0.29" (5.8-7.4mm)	F2	Nylon Gray	2	MHC1022CR
1/2	0.23-0.29" (5.8-7.4mm)	F2	Nylon Black	2	MHC2022CR
3/4	0.23-0.29" (5.8-7.4mm)	F3	Nylon Gray	4	MHC1032CR
3/4	0.23-0.29" (5.8-7.4mm)	F3	Nylon Black	4	MHC2032CR



Cord Connector Parts

NPT Hub Size	Cord Diameter Inches (mm)	Form Size	Bushing Catalog Number	Color Code	GOTCHA® Ring Catalog Number
1/4, 3/8, 1/2	.062"-.125" (1.58-3.17)	F1	31518101BPK100	Green	31648035GPK100
	.125"-.187" (3.17-4.76)		31518102BPK100	Orange	31648036GPK100
	.187"-.250" (4.76-6.35)		31518103BPK100	Red	31648037GPK100
	.250"-.312" (6.35-7.93)		31518104BPK100	Black	31648038GPK100
	.312"-.375" (7.93-9.50)		31518105BPK100	White	31605010GPK100
	.375"-.437" (9.50-11.1)		31518106BPK100	Blue	31648039GPK100
1/2, 3/4	.187"-.250" (4.76-6.35)	F2	31518110BPK100	Red	31648042GPK100
	.250"-.375" (6.35-9.50)		31518111BPK100	White	31605015GPK100
	.375"-.500" (9.50-12.7)		31518112BPK100	Blue	31648043GPK100
	.500"-.625" (12.7-15.8)		31518113BPK100	Brown	31648044GPK100
1/2, 3/4	.375"-.500" (9.50-12.7)	F3	31518116BPK100	Blue	31648045GPK100
	.500"-.625" (12.7-15.8)		31518117BPK100	Brown	31648046GPK100
	.625"-.750" (15.8-19.0)		31518118BPK100	Yellow	31648047GPK100
	.750"-.875" (19.0-22.2)		31518119BPK100	Orchid	31648048GPK100
1	.500"-.625" (12.7-15.8)	F4	31518123BPK100	Brown	31648050GPK100
	.625"-.750" (15.8-19.0)		31518124BPK100	Yellow	31648051GPK100
	.750"-.875" (19.0-22.2)		31518125BPK100	Orchid	31648052GPK100
	.875"-1.00" (22.2-25.4)		31518126BPK100	Gray	31648053GPK100
	1.00"-1.125" (25.4-28.5)		31518127BPK100	Pink	31648054GPK100

Note: Catalog numbers above with "PK100" suffix, i.e. 31518101BPK100, are bulk packed 100 per carton



Locknuts and Metal Clad Sealing O-Rings

NPT Hub Size	Zinc-Plated Steel Locknuts	Non-Metallic Locknuts	Metal Clad Sealing O-Rings*
1/4	—	31622001LPK50	—
3/8	—	31622002LPK50	—
1/2	00322001LPK50	31622003LPK50	20509001
3/4	00322002LPK50	31622007LPK50	20509002
1	00322003LPK50	31622008LPK50	20509003
1 1/4	00322004LPK50	—	20509004
1 1/2	00322005LPK50	—	20509005
2	00322006LPK50	—	20509006
2 1/2	00322007LPK50	—	20509007
3	00322008LPK50	—	20509008

Note: Catalog numbers above with "PK50" suffix, i.e. 00322001LPK50, are bulk packed 50 per carton. See page W-87 for technical information and dimensional drawings.
*UL listed and CSA certified.

Kellems® Wire Management Products

Features and Benefits

Hubbell Juniors® Miniature Nylon Cord Connectors

Hubbell Juniors are a miniature liquidtight version of the full-sized Hubbell cord connectors. They feature the same GOTCHA® ring technology and neoprene bushings.

They also come with or without a nylon spiral for arc-of-bend control and longer cord life. They are available in ¼", ⅜", and ½" NPT sizes in both gray and black.



Liquidtight Seal

- Lubricated neoprene bushing compresses evenly for a liquidtight seal and added pull-out protection
- Nylon connector body is a one-piece design with a tapered interior that seals the bushing evenly for a positive seal



Connector Body

- Nylon spiral provides arc-of-bend control for cord protection
- Threaded hexagon shaped nylon locknut secures tightly and is also corrosion resistant



Connector Protection

- Patented GOTCHA® ring incorporates a split hinge design to prevent friction and provide strain relief
- Nylon compression nut has a tapered interior dome to easily drive the bushing into the connector body



Comprehensive Offering

- Hubbell Juniors are a miniature liquidtight version of the full-sized Hubbell cord connectors and feature the same GOTCHA® ring technology and neoprene bushings

Hubbell Juniors® Miniature Nylon Cord Connectors



Black Cord Connector



Gray Cord Connector

Miniature Nylon Cord Connector

NPT Hub Size	Cord Diameter Range Inches (mm)	Black	Gray
1/4	.08"-.14" (1.9-3.4)	HJ1001BPK25	HJ1001GPK25
	.14"-.20" (3.4-5.1)	HJ1002BPK25	HJ1002GPK25
	.20"-.27" (5.1-6.7)	HJ1003BPK25	HJ1003GPK25
3/8	.15"-.21" (3.7-5.3)	HJ1004BPK25	HJ1004GPK25
	.21"-.28" (5.3-7.0)	HJ1005BPK25	HJ1005GPK25
	.28"-.34" (7.0-8.6)	HJ1006BPK25	HJ1006GPK25
1/2	.06"-.13" (1.6-3.2)	HJ1055BPK25	HJ1055GPK25
	.13"-.19" (3.2-4.7)	HJ1056BPK25	HJ1056GPK25
	.19"-.25" (4.7-6.3)	HJ1057BPK25	HJ1057GPK25
	.25"-.31" (6.3-7.9)	HJ1058BPK25	HJ1058GPK25
	.31"-.38" (7.9-9.5)	HJ1059BPK25	HJ1059GPK25
	.38"-.44" (9.5-11.1)	HJ1060BPK25	HJ1060GPK25



Black Cord Connector with Spiral



Gray Cord Connector with Spiral

Miniature Nylon Cord Connector with Spiral

NPT Hub Size	Cord Diameter Range Inches (mm)	Black	Gray
1/4	.08"-.14" (1.9-3.4)	HJ1010BPK25	HJ1010GPK25
	.14"-.20" (3.4-5.1)	HJ1011BPK25	HJ1011GPK25
	.20"-.27" (5.1-6.7)	HJ1012BPK25	HJ1012GPK25
3/8	.15"-.21" (3.7-5.3)	HJ1013BPK25	HJ1013GPK25
	.21"-.28" (5.3-7.0)	HJ1014BPK25	HJ1014GPK25
	.28"-.34" (7.0-8.6)	HJ1015BPK25	HJ1015GPK25
1/2	.13"-.19" (3.2-4.7)	HJ1038BPK25	HJ1038GPK25
	.19"-.25" (4.7-6.3)	HJ1039BPK25	HJ1039GPK25
	.25"-.31" (6.3-7.9)	HJ1040BPK25	HJ1040GPK25
	.31"-.38" (7.9-9.5)	HJ1041BPK25	HJ1041GPK25
	.38"-.44" (9.5-11.1)	HJ1042BPK25	HJ1042GPK25
3/4	.25"-.49" (6.4-12.3)	HJ1043BPK25*	HJ1043GPK25*
	.45"-.71" (11.4-18.0)	HJ1044BPK25*	HJ1044GPK25*

Note: *Locknuts sold separately, see page W-75 for additional information.



Black Snap-In Cord Connector



Gray Snap-In Cord Connector

Miniature Nylon Snap-In Cord Connector with Spiral

Cord Diameter Range Inches (mm)	For Chassis Thickness	Black	Gray
.22"-.27" (5.6-6.9)	.10" (2.5) Max	HS1001BPK25	HS1001GPK25
.28"-.32" (7.1-8.1)	.10" (2.5) Max	HS1002BPK25	HS1002GPK25
.30"-.36" (7.6-9.1)	.13" (3.2) Max	HS1003BPK25	HS1003GPK25
.32"-.43" (8.1-10.9)	.13" (3.2) Max	HS1004BPK25	HS1004GPK25

Note: Catalog numbers above with "PK25" suffix, i.e. HJ1001GPK25, are bulk packed 25 per carton. See page W-88 for technical information and dimensional drawings.

Kellems® Wire Management Products

Operating Temperatures

Material	Temperature Range	
Aluminum	-40°F to +300°F	(-40°C to +149°C)
Nylon (connectors and GOTCHA® rings)	-40°F to +225°F	(-40°C to +107°C)
Plated steel*	-60°F to +1000°F	(-51°C to +537°C)
Stainless steel*	-60°F to +1000°F	(-51°C to +537°C)
Neoprene (bushings)	-30°F to +240°F	(-34°C to +115°C)

Note: *Due to the limiting factors of nylon and neoprene, any complete cord connector with a GOTCHA ring, Form 1-5, will continuously perform in the range of -30°F to +225°F (-34°C to +107°C).
Cord connectors without GOTCHA rings, Form 6-8, will continuously operate in the range -30°F to +240°F (-34°C to +115°C) due to the limiting factor of neoprene.

Hazardous Locations

Hubbell cord connectors are suitable for use in hazardous locations per Class I Div. 2, Class II Div. 1 & 2, Class III Div. 1 & 2 in accordance with the NEC.

Flammability

Hubbell nylon cord connectors have a UL 94-V2 rating.

Approvals

Agency

UL Listed in accordance with Standard 514B for indoor/outdoor use.

CSA Certified.

United States Coast Guard Approved, Title 46-Part 111.

Form Size Definition

The term "Form Size" refers to the physical overall size of a cord connector.

Form 1 is the smallest size.

Form 8 is the largest size.

Knockout Holes

NPT Hub Size	Knockout Hole Recommended		Knockout Hole Recommended		Knockout Hole Recommended	
	Min.	Max.	PG Hub Size	Inches (mm)	Metric Hub Size	Inches (mm)
¼	.54"	.57"	PG7	.492" (12.5)	M12	.472" (12)
⅜	.67"	.70"	PG9	.599" (15.2)	M16	.629" (16)
½	.86"	.91"	PG11	.733" (18.6)	M20	.787" (20)
¾	1.04"	1.09"	PG13.5	.804" (20.4)	M25	.984" (25)
1	1.36"	1.41"	PG16	.888" (22.5)	M32	1.25" (32)
1¼	1.72"	1.77"	PG21	1.15" (28.3)	M40	1.57" (40)
1½	1.97"	2.02"	PG29	1.47" (34.3)		
2	2.45"	2.50"	PG36	1.85" (47.0)		
2½	2.95"	3.00"				
3	3.58"	3.63"				

NPT, PG and Metric Thread Low Profile Connectors

Specifications

Material	6/6 Nylon.
Gland	Buna N.
Temperature Range	-22°F to 225°F (-30°C to 107°C). Cord Connectors are Halogen and Silicon free.
Protection Class	IP66 Suitability.
Flammability	UL 94X-2.
Listings/Certifications	UL Listing File E-41567, UL Recognition File E-41567. CSA File LR27378C, VDE Marks Licence #136681.



Straight Hubbell Connectors

F NPT Inches	Aluminum Inches (mm)						Nylon Inches (mm)						
	Form	A	B	C	D Throat Dia.	E		A Dia.	B Ref.	C	D Throat Dia.	E	
		Dia.	Ref.			A/C*	A/F*					A/C*	A/F*
¼-18	1	.88" (22.4)	.90" (22.9)	.46" (11.7)	.32" (8.1)	.99" (25.1)	.88" (22.4)	1.00" (25.4)	1.10" (27.9)	.43" (10.9)	.33" (8.4)	1.00" (25.4)	.93" (23.6)
⅜-18	1	.88" (22.4)	.90" (22.9)	.46" (11.7)	.44" (11.2)	.99" (25.1)	.88" (22.4)	1.00" (25.4)	1.10" (27.9)	.43" (10.9)	.45" (11.4)	1.00" (25.4)	.93" (23.6)
½-14	1	.88" (22.4)	.90" (22.9)	.46" (11.7)	.44" (11.2)	1.00" (25.4)	.88" (22.4)	1.00" (25.4)	1.10" (27.9)	.46" (11.7)	.45" (11.4)	1.00" (25.4)	.93" (23.6)
½-14	2	1.13" (28.7)	1.10" (27.9)	.55" (14.0)	.64" (16.3)	1.11" (28.2)	1.00" (25.4)	1.32" (33.5)	1.50" (38.1)	.53" (13.5)	.58" (14.7)	1.25" (31.7)	1.12" (28.4)
½-14	3	1.38" (35.1)	1.50" (38.1)	.55" (14.0)	.64" (16.3)	1.40" (35.6)	1.25" (31.7)	—	—	—	—	—	—
¾-14	2	1.13" (28.7)	1.10" (27.9)	.55" (14.0)	.64" (16.3)	1.29" (32.8)	1.13" (28.7)	—	—	—	—	—	—
¾-14	3	1.38" (35.1)	1.50" (38.1)	.55" (14.0)	.82" (20.8)	1.40" (35.6)	1.25" (31.7)	1.56" (39.6)	1.60" (40.6)	.55" (14.0)	.77" (19.6)	1.44" (36.6)	1.31" (33.3)
1-11½	4	1.75" (44.4)	1.60" (40.6)	.71" (18.0)	1.02" (25.9)	1.81" (46.0)	1.62" (41.1)	1.88" (47.8)	1.75" (44.4)	.70" (17.8)	1.01" (25.7)	1.84" (46.7)	1.63" (41.4)
1-11½	5	2.31" (58.7)	1.70" (43.2)	.66" (16.8)	1.01" (25.7)	2.28" (57.9)	2.00" (50.8)	—	—	—	—	—	—
1¼-11½	5	2.31" (58.7)	1.70" (43.2)	.74" (18.8)	1.26" (32.0)	2.28" (57.9)	2.12" (53.8)	—	—	—	—	—	—
1½-11½	5	2.31" (58.7)	1.70" (43.2)	.74" (18.8)	1.38" (35.1)	2.28" (57.9)	2.12" (53.8)	—	—	—	—	—	—
1½-11½	6	3.00" (76.2)	2.20" (55.9)	.75" (19.0)	1.50" (38.1)	2.97" (75.4)	2.75" (69.8)	—	—	—	—	—	—
2-11½	6	3.00" (76.2)	2.20" (55.9)	.80" (20.3)	1.92" (48.8)	3.24" (82.4)	3.00" (76.2)	—	—	—	—	—	—
2-11½	7	3.85" (97.8)	2.70" (68.6)	.88" (22.4)	1.94" (49.3)	4.05" (102.9)	3.75" (95.2)	—	—	—	—	—	—
2½-8	7	3.85" (97.8)	2.70" (68.6)	1.30" (33.0)	2.32" (58.9)	4.34" (110.2)	4.02" (102.1)	—	—	—	—	—	—
2½-8	8	4.75" (120.6)	2.70" (68.6)	1.25" (31.7)	2.38" (60.5)	4.86" (123.4)	4.50" (114.3)	—	—	—	—	—	—
3-8	7	3.85" (97.8)	2.70" (68.6)	1.30" (33.0)	2.54" (64.5)	4.34" (110.2)	4.02" (102.1)	—	—	—	—	—	—
3-8	8	4.50" (114.3)	2.70" (68.6)	1.38" (35.1)	3.00" (76.2)	4.86" (123.4)	4.50" (114.3)	—	—	—	—	—	—

Note: *A/C—Across Corners; A/F—Across Flats.

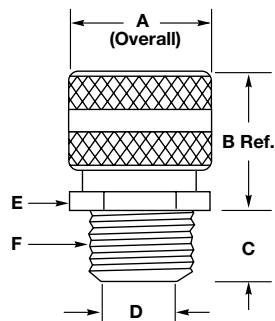

Dimensions shown are approximate and are subject to change without notice.

Straight Hubbell Connectors

F NPT Inches	Zinc-Plated Steel Inches (mm)							Stainless Steel Inches (mm)							
	Form	A		B	C	D Throat Dia.	E		A		B	C	D Throat Dia.	E	
		A/C*	A/F*	Ref.			A/C*	A/F*	A/C*	A/F*	Ref.			A/C*	A/F*
¼- 18	1	—	—	—	—	—	—	—	1.01" (25.7)	.88" (22.4)	.90" (22.9)	.46" (11.7)	.38" (9.7)	.87" (22.1)	.75" (19.0)
⅜-18	1	.98" (24.9)	.88" (22.4)	.90" (22.9)	.42" (10.7)	.45" (11.4)	.99" (25.1)	.88" (22.4)	1.01" (25.7)	.88" (22.4)	.90" (22.9)	.46" (11.7)	.45" (11.4)	.87" (22.1)	.75" (19.0)
½-14	1	.98" (24.9)	.88" (22.4)	.90" (22.9)	.55" (14.0)	.45" (11.4)	1.00" (25.4)	.88" (22.4)	—	—	—	—	—	—	—
½-14	2	1.27" (32.3)	1.13" (28.7)	1.20" (30.5)	.55" (14.0)	.64" (16.3)	1.10" (28.2)	1.00" (25.4)	1.30" (33.0)	1.13" (28.7)	1.10" (27.9)	.54" (13.7)	.63" (16.0)	1.16" (29.5)	1.00" (25.4)
½-14	3	1.55" (39.4)	1.38" (35.1)	1.50" (38.1)	.55" (14.0)	.64" (16.3)	1.40" (35.6)	1.25" (31.7)	—	—	—	—	—	—	—
¾-14	2	1.27" (32.3)	1.13" (28.7)	1.20" (30.5)	.55" (14.0)	.64" (16.3)	1.29" (32.8)	1.13" (28.7)	—	—	—	—	—	—	—
¾-14	3	1.55" (39.4)	1.38" (35.1)	1.40" (35.6)	.55" (14.0)	.82" (20.8)	1.40" (35.6)	1.25" (31.7)	1.59" (40.4)	1.38" (35.1)	1.30" (33.0)	.56" (14.2)	.81" (20.6)	1.44" (36.6)	1.25" (31.7)
1-11½	3	1.55" (39.4)	1.38" (35.1)	1.40" (35.6)	.70" (17.8)	.89" (22.6)	1.54" (39.1)	1.38" (35.1)	—	—	—	—	—	—	—
1-11½	4	1.92" (48.8)	1.69" (42.9)	1.60" (40.6)	.70" (17.8)	1.02" (25.9)	1.95" (49.5)	1.69" (42.9)	2.02" (51.3)	1.75" (44.4)	1.40" (35.6)	.70" (17.8)	1.03" (26.2)	1.88" (47.8)	1.63" (41.4)
1-11½	5	2.40" (61.0)	—	1.70" (43.2)	.70" (17.8)	1.02" (25.9)	2.46" (62.5)	2.15" (54.6)	—	—	—	—	—	—	—
1¼-11½	5	2.40" (61.0)	—	1.70" (43.2)	.73" (18.5)	1.27" (32.3)	2.48" (63.0)	2.19" (55.6)	—	—	—	—	—	—	—
1½-11½	5	2.40" (61.0)	—	1.70" (43.2)	.74" (18.8)	1.39" (35.3)	2.48" (63.0)	2.19" (55.6)	—	—	—	—	—	—	—
1½-11½	6	3.06" (77.7)	—	2.20" (55.9)	.75" (19.0)	1.52" (38.6)	3.04" (77.2)	2.83" (71.9)	—	—	—	—	—	—	—
2-11½	6	3.06" (77.7)	—	2.20" (55.9)	.78" (19.8)	1.92" (48.8)	3.32" (84.3)	3.07" (78.0)	—	—	—	—	—	—	—
2-11½	7	3.95" (100.3)	—	2.70" (68.6)	.78" (19.8)	1.99" (50.5)	4.18" (106.2)	3.89" (98.8)	—	—	—	—	—	—	—

Note: *A/C— Across Corners; A/F—Across Flats.

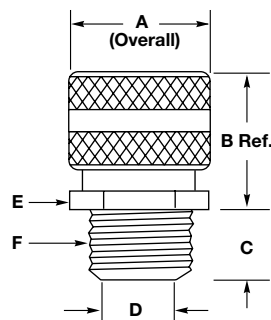

Dimensions shown are approximate and are subject to change without notice.

45° Hubbell Connectors

F NPT Inches	Aluminum Inches (mm)								Zinc Plated Steel Inches (mm)							
	Form	A Dia.	B Ref.	C	D Throat Dia.	E		G Dia.	A Dia.	B Ref.	C	D Throat Dia.	E		G	
						Across Corners	Across Flats						Across Corners	Across Flats		
1/2-14	2	2.00" (50.8)	1.90" (48.3)	.55" (14.0)	.56" (14.2)	1.27" (32.3)	1.10" (27.9)	1.13" (28.6)	1.97" (50.0)	1.90" (48.3)	.55" (14.0)	.57" (14.4)	1.24" (31.5)	1.06" (26.9)	1.27" (32.3)	1.13" (28.6)
3/4-14	3	2.30" (58.4)	2.50" (65.3)	.56" (14.2)	.75" (19.0)	1.48" (37.6)	1.28" (32.5)	1.38" (34.9)	—	—	—	—	—	—	—	—
1-11½	4	2.60" (66.0)	2.80" (71.1)	.70" (17.8)	1.00" (25.4)	1.69" (42.9)	1.50" (38.1)	1.75" (44.4)	—	—	—	—	—	—	—	—
1½-11½	5	3.90" (99.1)	3.90" (99.1)	.74" (18.8)	1.25" (31.7)	2.45" (62.2)	2.13" (54.0)	2.31" (58.7)	—	—	—	—	—	—	—	—
1½-11½	5	3.90" (99.1)	3.90" (99.1)	.74" (18.8)	1.50" (38.1)	2.45" (62.2)	2.13" (54.0)	2.31" (58.7)	—	—	—	—	—	—	—	—

90° Hubbell Connectors

F NPT Inches	Aluminum Inches (mm)								Zinc Plated Steel Inches (mm)							
	Form	A Dia.	B Ref.	C	D Throat Dia.	E		G Dia.	A Dia.	B Ref.	C	D Throat Dia.	E		G	
						Across Corners	Across Flats						Across Corners	Across Flats		
3/8-18	1	1.27" (32.3)	2.00" (50.8)	.46" (11.7)	.44" (11.2)	1.15" (29.2)	1.10" (27.9)	.88" (22.2)	—	—	—	—	—	—	—	—
1/2-14	2	1.56" (39.6)	2.30" (58.4)	.50" (12.7)	.55" (13.9)	1.30" (33.0)	1.13" (28.7)	1.13" (28.6)	1.65" (41.9)	2.38" (60.5)	.55" (14.0)	.55" (13.8)	1.29" (32.8)	1.13" (28.7)	1.27" (32.3)	1.13" (28.6)
3/4-14	3	1.79" (45.5)	2.80" (71.1)	.56" (14.2)	.77" (19.4)	1.49" (37.8)	1.31" (33.3)	1.38" (34.9)	1.88" (47.8)	2.90" (73.7)	.56" (14.2)	.77" (19.4)	1.52" (38.6)	1.33" (33.8)	1.55" (39.2)	1.38" (34.9)
1-11½	4	2.08" (52.8)	3.20" (81.3)	.70" (17.8)	1.00" (25.4)	1.70" (43.2)	1.50" (38.1)	1.75" (44.4)	2.16" (54.9)	3.20" (81.3)	.70" (17.8)	1.00" (25.4)	1.72" (43.7)	1.50" (38.1)	1.92" (48.8)	1.69" (42.8)
1¼-11½	5	3.18" (80.8)	4.30" (109.2)	.73" (18.5)	1.26" (32.0)	2.47" (62.7)	2.15" (54.6)	2.31" (58.7)	—	—	—	—	—	—	—	—
1½-11½	5	3.18" (80.8)	4.30" (109.2)	.75" (19.2)	1.50" (38.1)	2.47" (62.7)	2.15" (54.6)	2.31" (58.7)	—	—	—	—	—	—	—	—
2-11½	6	3.51" (89.2)	5.50" (139.7)	.80" (20.3)	1.92" (48.8)	2.98" (75.7)	2.78" (70.6)	3.00" (76.2)	—	—	—	—	—	—	—	—

90° Hubbell Connectors

F NPT Inches	Nylon Inches (mm)							
	Form	A Dia.	B Ref.	C	D Throat Dia.	E		G Dia.
						Across Corners	Across Flats	
3/8-18	1	—	—	—	—	—	—	—
1/2-14	2	1.41" (35.8)	2.50" (63.5)	.55" (14.0)	.58" (14.6)	1.23" (31.2)	1.12" (28.2)	1.32" (33.4)
3/4-14	3	1.65" (41.9)	2.81" (71.4)	.56" (14.2)	.77" (19.4)	1.42" (36.1)	1.29" (32.8)	1.56" (39.6)
1-11½	4	1.99" (50.5)	3.30" (83.8)	.70" (17.8)	1.01" (25.7)	1.82" (46.2)	1.60" (40.6)	1.88" (47.6)

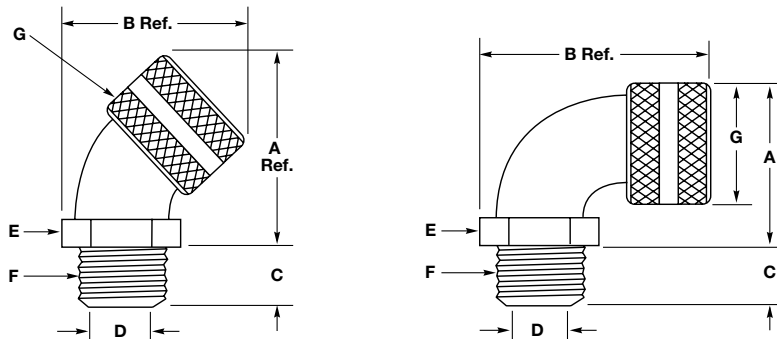

Dimensions shown are approximate and are subject to change without notice.

Female Hubbell Connectors

Aluminum Inches (mm)							
F NPT Inches	Form	A		C	D Throat Dia.	E	
		Dia.	Ref.			Across Corners	Across Flats
3/8-18	1	.88" (22.4)	1.40" (35.6)	.56" (14.2)	.44" (11.2)	.94" (23.9)	.81" (20.6)
1/2-14	2	1.13" (28.7)	1.80" (45.7)	.56" (14.2)	.63" (16.0)	1.15" (29.2)	1.00" (25.4)
3/4-14	2	1.13" (28.7)	2.10" (53.3)	.75" (19.0)	.63" (16.0)	1.44" (36.6)	1.25" (31.7)
1-11 1/2	4	1.75" (44.5)	2.30" (58.4)	.88" (22.4)	1.10" (27.9)	1.88" (47.8)	1.63" (41.4)
1 1/4-11 1/2	5	2.31" (58.7)	2.80" (71.1)	.95" (24.1)	1.43" (36.3)	2.64" (67.1)	2.29" (58.2)
1 1/2-11 1/2	5	2.31" (58.7)	2.80" (71.1)	.95" (24.1)	1.43" (36.3)	2.64" (67.1)	2.29" (58.2)

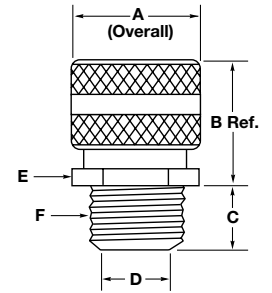
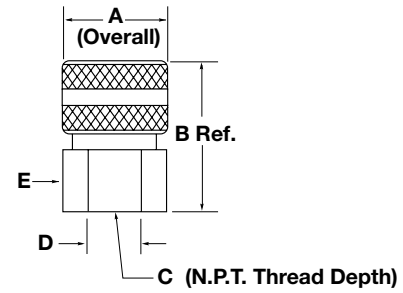

Underground Feeder Connectors

F NPT Inches	Form	Aluminum Inches (mm)				Zinc-Plated Steel Inches (mm)						Nylon Inches (mm)								
		A	B	C	D Throat Dia.	E		A	B	C	D Throat Dia.	E		A	B	C	D Throat Dia.	E		
		Dia.	Ref.		A/C*	A/F*	A/C*	A/F*	Ref.		A/C*	A/F*	Dia.	Ref.		Dia.	Ref.	A/C*	A/F*	
1/2-14	2	1.13" (28.7)	1.10" (27.9)	.55" (14.0)	.64" (16.3)	1.10" (27.9)	1.00" (25.4)	1.27" (32.3)	1.13" (28.7)	1.20" (30.5)	.55" (14.0)	.64" (16.3)	1.11" (28.2)	1.00" (25.4)	1.32" (33.5)	1.50" (38.1)	.55" (14.0)	.58" (14.7)	1.25" (31.7)	1.13" (28.7)
3/4-14	2	1.13" (28.7)	1.10" (27.9)	.55" (14.0)	.64" (16.3)	1.29" (32.8)	1.13" (25.4)	1.27" (32.3)	1.13" (28.7)	1.20" (30.5)	.55" (14.0)	.64" (16.3)	1.29" (32.8)	1.13" (28.7)	—	—	—	—	—	—
3/4-14	3	1.13" (28.7)	1.50" (38.1)	.55" (14.0)	.82" (20.8)	1.40" (35.6)	1.25" (31.7)	1.55" (39.4)	1.38" (35.1)	1.40" (35.6)	.56" (14.2)	.82" (20.8)	1.40" (35.6)	1.25" (31.7)	1.56" (39.6)	1.60" (40.6)	.56" (14.2)	.77" (19.6)	1.44" (36.6)	1.31" (33.3)

Note: *A/C - Across Corners; A/F - Across Flats.

Low Profile Non-Metallic NPT, PG and Metric Thread Connectors

Hub Size	Nylon Inches (mm)					
	A	B	C	D	E	F
3/8 NPT	0.670" (17.0)	1.41" (35.8)	0.48" (12.4)	0.21" (5.3)	0.83" (21.0)	0.55" (14.0)
1/2 NPT	0.875" (22.2)	1.70" (43.2)	0.61" (15.5)	0.21" (5.3)	0.88" (24.8)	0.66" (16.8)
3/4 NPT	1.068" (27.1)	2.00" (50.8)	0.62" (15.7)	0.25" (6.3)	1.30" (33.0)	0.85" (21.6)
1 NPT	1.375" (35.0)	2.41" (61.2)	0.76" (19.3)	0.30" (7.6)	1.73" (43.9)	1.05" (26.7)
PG7	0.492" (12.5)	1.16" (29.5)	0.32" (8.1)	0.21" (5.3)	0.63" (16.0)	0.48" (12.4)
PG9	0.599" (15.2)	1.25" (31.8)	0.32" (8.1)	0.21" (5.3)	0.83" (21.0)	0.55" (14.0)
PG11	0.733" (18.6)	1.48" (37.6)	0.38" (9.7)	0.21" (5.3)	0.94" (23.9)	0.70" (17.8)
PG13.5	0.804" (20.4)	1.53" (38.9)	0.41" (10.4)	0.21" (5.3)	0.98" (24.9)	0.66" (16.8)
PG16	0.888" (22.5)	1.68" (42.7)	0.44" (11.2)	0.25" (6.4)	1.06" (27.0)	0.76" (19.3)
PG21	1.15" (28.3)	1.89" (48.0)	0.52" (13.2)	0.25" (6.4)	1.30" (33.0)	.085" (21.6)
PG29	1.47" (37.30)	2.23" (56.6)	0.58" (14.7)	0.30" (7.6)	1.73" (43.9)	1.05" (26.7)
PG36	1.85" (47.0)	2.39" (60.7)	0.47" (11.9)	0.31" (7.9)	2.05" (52.7)	1.19" (30.2)
M12	0.473" (12.0)	1.16" (29.5)	0.32" (8.1)	0.21" (5.3)	0.63" (16.0)	0.49" (12.4)
M16	0.630" (16.0)	1.25" (31.8)	0.32" (8.1)	0.21" (5.3)	0.83" (21.0)	0.55" (14.0)
M20	0.787" (20.0)	1.53" (38.9)	0.41" (10.4)	0.21" (5.3)	0.98" (24.9)	0.66" (16.8)
M25	0.985" (25.0)	1.89" (48.0)	0.52" (13.2)	0.25" (6.3)	1.30" (33.0)	0.85" (21.6)
M32	1.260" (32.0)	2.23" (56.6)	0.58" (14.7)	0.30" (7.6)	1.73" (43.9)	1.05" (26.7)
M40	1.575" (40.0)	2.39" (60.7)	0.48" (12.2)	0.30" (7.6)	2.05" (52.1)	1.19" (30.2)

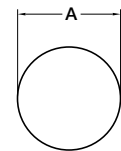
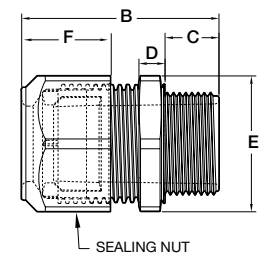

Recommended knockout size

Dimensions shown are approximate and are subject to change without notice.

Kellems® Wire Management Products

2 Conductors

Cord Type	SVO, SV, SVT	SJ, SJO, SJT, SJTO				S, SO, ST, STO					
Cord Size	#18	#18	#16	#14	#18	#16	#14	#12	#10	#8	
Approx. Dia. Inches (mm)	.25" (6.2)	.31" (7.8)	.33" (8.4)	.37" (9.3)	.38" (9.7)	.40" (10.2)	.54" (13.7)	.62" (15.6)	.68" (17.1)	.81" (20.6)	
Color	Black	Black	White	White	Blue	Blue	Brown	Brown	Yellow	Orchid	
NPT	Form	Catalog Number*									
¼	1	HC1004	HC1004	HC1005	HC1005	HC1006	HC1006	—	—	—	—
⅜	1	HC1010	HC1010	HC1011	HC1011	HC1012	HC1012	—	—	—	—
½	1	HC1016	HC1016	HC1017	HC1017	HC1018	HC1018	—	—	—	—
½	2	HC1022	HC1022	HC1022	HC1022	HC1023	HC1023	HC1024	HC1024	—	—
½	3	—	—	—	—	HC1025	HC1025	HC1026	HC1026	HC1027	HC1028
¾	2	HC1032	HC1032	HC1032	HC1032	HC1033	HC1033	HC1034	HC1034	—	—
¾	3	—	—	—	—	HC1035	HC1035	HC1036	HC1036	HC1037	HC1038
1	4	—	—	—	—	HC1039	HC1039	HC1040	HC1040	HC1041	HC1042
1	5	—	—	—	—	—	—	—	—	—	HC1045
1¼	5	—	—	—	—	—	—	—	—	—	HC1050
1½	5	—	—	—	—	—	—	—	—	—	HC1055
1½	6	—	—	—	—	—	—	—	—	—	—
2	6	—	—	—	—	—	—	—	—	—	—
2	7	—	—	—	—	—	—	—	—	—	—
2½	7	—	—	—	—	—	—	—	—	—	—
3	7	—	—	—	—	—	—	—	—	—	—

Note: *Must add prefix, see Note 1; suffix, see Note 2, on page W-86.
 ‡F5 and larger will not be color coded.

3 Conductors

Cord Type	SVO, SV, SVT	SJ, SJO, SJT, SJTO				S, SO, ST, STO					
Cord Size	#18	#18	#16	#14	#18	#16	#14	#12	#10	#8	
Approx. Dia. Inches (mm)	.26" (6.5)	.33" (8.3)	.35" (8.9)	.39" (9.8)	.39" (9.9)	.42" (10.7)	.57" (14.4)	.65" (16.4)	.71" (18.0)	.85" (21.5)	
Color	Black	White	White	Blue	Blue	Blue	Brown	Yellow	Yellow	Orchid	
NPT	Form	Catalog Number*									
¼	1	HC1004	HC1005	HC1005	HC1006	HC1006	HC1006	—	—	—	—
⅜	1	HC1010	HC1011	HC1011	HC1012	HC1012	HC1012	—	—	—	—
½	1	HC1016	HC1017	HC1017	HC1018	HC1018	HC1018	—	—	—	—
½	2	HC1022	HC1022	HC1022	HC1023	HC1023	HC1023	HC1024	—	—	—
½	3	—	—	—	HC1025	HC1025	HC1025	HC1026	HC1027	HC1027	HC1028
¾	2	HC1032	HC1032	HC1032	HC1033	HC1033	HC1033	HC1034	—	—	—
¾	3	—	—	—	HC1035	HC1035	HC1035	HC1036	HC1037	HC1037	HC1038
1	4	—	—	—	HC1039	HC1039	HC1039	HC1040	HC1041	HC1041	HC1042
1	5	—	—	—	—	—	—	—	—	—	HC1045
1¼	5	—	—	—	—	—	—	—	—	—	HC1050
1½	5	—	—	—	—	—	—	—	—	—	HC1055
1½	6	—	—	—	—	—	—	—	—	—	—
2	6	—	—	—	—	—	—	—	—	—	—
2	7	—	—	—	—	—	—	—	—	—	—
2½	7	—	—	—	—	—	—	—	—	—	—
3	7	—	—	—	—	—	—	—	—	—	—

Note: *Must add prefix, see Note 1; suffix, see Note 2, on page W-95.
 ‡F5 and larger will not be color coded.

Kellems® Wire Management Products

2 Conductors

Cord Type	SVO, SV, SVT				SJ, SJO, SJT, SJTO				S, SO, ST, STO			
Cord Size	#6	#4	#3	#2	#1	#1/0	#2/0	#3/0	#4/0	#250		
Approx. Dia. Inches (mm)	.94" (23.8)	1.08" (27.4)	1.17" (29.7)	1.27" (33.3)	1.44" (36.6)	1.52" (38.6)	1.65" (41.9)	1.77" (45.0)	1.92" (48.8)	2.16" (51.9)		
Color	Gray‡	Pink‡	‡	‡	‡	‡	‡	‡	‡	‡		
NPT	Form	Catalog Number*										
¼	1	—	—	—	—	—	—	—	—	—	—	
⅜	1	—	—	—	—	—	—	—	—	—	—	
½	1	—	—	—	—	—	—	—	—	—	—	
½	2	—	—	—	—	—	—	—	—	—	—	
½	3	—	—	—	—	—	—	—	—	—	—	
¾	2	—	—	—	—	—	—	—	—	—	—	
¾	3	—	—	—	—	—	—	—	—	—	—	
1	4	HC1043	HC1044	—	—	—	—	—	—	—	—	
1	5	HC1046	HC1047	HC1048	HC1049	—	—	—	—	—	—	
1¼	5	HC1051	HC1052	HC1053	HC1054	—	—	—	—	—	—	
1½	5	HC1056	HC1057	HC1058	HC1059	—	—	—	—	—	—	
1½	6	—	—	—	HC1060	HC1061	HC1062	HC1063	HC1064	—	—	
2	6	—	—	—	HC1065	HC1066	HC1067	HC1068	HC1069	—	—	
2	7	—	—	—	—	—	—	—	HC1070	HC1071	HC1073	
2½	7	—	—	—	—	—	—	—	HC1076	HC1077	HC1079	
3	7	—	—	—	—	—	—	—	HC1086	HC1087	HC1089	

Note: *Must add prefix, see Note 1; suffix, see Note 2, on page W-86.
‡F5 and larger will not be color coded.

3 Conductors

Cord Type	SVO, SV, SVT				SJ, SJO, SJT, SJTO				S, SO, ST, STO			
Cord Size	#6	#4	#3	#2	#1	#1/0	#2/0	#3/0	#4/0	#250		
Approx. Dia. Inches (mm)	1.00" (25.4)	1.17" (29.7)	1.24" (31.5)	1.34" (34.0)	1.51" (38.4)	1.65" (41.9)	1.75" (44.5)	1.80" (48.0)	2.07" (52.6)	2.39" (60.7)		
Color	Gray‡	‡	‡	‡	‡	‡	‡	‡	‡	‡		
NPT	Form	Catalog Number*										
¼	1	—	—	—	—	—	—	—	—	—	—	
⅜	1	—	—	—	—	—	—	—	—	—	—	
½	1	—	—	—	—	—	—	—	—	—	—	
½	2	—	—	—	—	—	—	—	—	—	—	
½	3	—	—	—	—	—	—	—	—	—	—	
¾	2	—	—	—	—	—	—	—	—	—	—	
¾	3	—	—	—	—	—	—	—	—	—	—	
1	4	HC1044	—	—	—	—	—	—	—	—	—	
1	5	HC1047	HC1048	HC1048	HC1049	—	—	—	—	—	—	
1¼	5	HC1052	HC1053	HC1053	HC1054	—	—	—	—	—	—	
1½	5	HC1057	HC1058	HC1058	HC1059	—	—	—	—	—	—	
1½	6	—	—	—	HC1060	HC1062	HC1063	HC1064	—	—	—	
2	6	—	—	—	HC1065	HC1067	HC1068	HC1069	—	—	—	
2	7	—	—	—	—	—	—	HC1070	HC1071	HC1073	HC1075	
2½	7	—	—	—	—	—	—	HC1076	HC1077	HC1079	HC1081	
3	7	—	—	—	—	—	—	HC1086	HC1087	HC1089	HC1091	

Note: *Must add prefix, see Note 1; suffix, see Note 2, on page W-86.
‡F5 and larger will not be color coded.

Kellems® Wire Management Products

4 Conductors

Cord Type	SJ, SJO, SJT, SJTO				S, SO, ST, STO					
Cord Size	#18	#16	#14	#18	#16	#14	#12	#10	#8	
Approx. Dia. Inches (mm)	.36" (9.0)	.39" (9.8)	.43" (10.8)	.42" (10.7)	.45" (11.4)	.61" (15.5)	.70" (17.8)	.77" (19.4)	.97" (24.6)	
Color	White	Blue	Blue	Blue	Blue	Brown	Yellow	Orchid	Gray‡	
NPT	Form	Catalog Number*								
¼	1	HC1005	HC1006	HC1006	HC1006	—	—	—	—	—
¾	1	HC1011	HC1012	HC1012	HC1012	—	—	—	—	—
½	1	HC1017	HC1018	HC1018	HC1018	—	—	—	—	—
½	2	HC1022	HC1023	HC1023	HC1023	HC1023	HC1024	—	—	—
½	3	—	HC1025	HC1025	HC1025	HC1025	HC1026	HC1027	HC1028	—
¾	2	—	HC1033	HC1033	HC1033	HC1033	HC1034	—	—	—
¾	3	—	HC1035	HC1035	HC1035	HC1035	HC1036	HC1037	HC1038	—
1	4	—	HC1039	HC1039	HC1039	HC1039	HC1040	HC1041	HC1042	HC1043
1	5	—	—	—	—	—	—	—	—	HC1046
1¼	5	—	—	—	—	—	—	—	—	HC1051
1½	5	—	—	—	—	—	—	—	—	HC1056
1½	6	—	—	—	—	—	—	—	—	—
2	6	—	—	—	—	—	—	—	—	—
2	7	—	—	—	—	—	—	—	—	—
2½	7	—	—	—	—	—	—	—	—	—
3	7	—	—	—	—	—	—	—	—	—

Note: *Must add prefix, see Note 1; suffix, see Note 2, on page W-86.
‡F5 and larger will not be color coded.

5 Conductors

Cord Type	S, SO, ST, STO							
Cord Size	#18	#16	#14	#12	#10	#8	#6	
Approx. Dia. Inches (mm)	.50" (12.7)	.54" (13.7)	.70" (17.7)	.76" (19.3)	.83" (21.1)	1.06" (26.9)	1.18" (30.0)	
Color	Blue	Brown	Yellow	Orchid‡	Orchid‡	Pink‡	‡	
NPT	Form	Catalog Number*						
½	2	HC1023	HC1024	—	—	—	—	
½	3	HC1025	HC1026	HC1027	HC1028	HC1028	—	
¾	2	HC1033	HC1034	—	—	—	—	
¾	3	HC1035	HC1036	HC1037	HC1038	HC1038	—	
1	4	HC1039	HC1040	HC1041	HC1042	HC1042	HC1044	
1	5	—	—	—	HC1045	HC1045	HC1047	
1¼	5	—	—	—	HC1050	HC1050	HC1052	
1½	5	—	—	—	HC1055	HC1055	HC1057	

Note: *Must add prefix, see Note 1; suffix, see Note 2, on page W-86.
‡F5 and larger will not be color coded.

4 Conductors

Cord Type	SJ, SJO, SJT, SJTO			S, SO, ST, STO						
Cord Size	#6	#4	#3	#2	#1	#1/0	#2/0	#3/0	#4/0	
Approx. Dia. Inches (mm)	.94" (23.8)	1.08" (27.4)	1.17" (29.7)	1.27" (33.3)	1.44" (36.6)	1.52" (38.6)	1.65" (41.9)	1.77" (45.0)	1.92" (48.8)	
Color	Pink‡	‡	‡	‡	‡	‡	‡	‡	‡	
NPT	Form	Catalog Number*								
¼	1	—	—	—	—	—	—	—	—	—
⅜	1	—	—	—	—	—	—	—	—	—
½	1	—	—	—	—	—	—	—	—	—
½	2	—	—	—	—	—	—	—	—	—
½	3	—	—	—	—	—	—	—	—	—
¾	2	—	—	—	—	—	—	—	—	—
¾	3	—	—	—	—	—	—	—	—	—
1	4	HC1044	—	—	—	—	—	—	—	—
1	5	HC1047	HC1049	HC1049	—	—	—	—	—	—
1¼	5	HC1052	HC1054	HC1054	—	—	—	—	—	—
1½	5	HC1057	HC1059	HC1059	—	—	—	—	—	—
1½	6	—	HC1060	HC1060	HC1061	HC1063	HC1064	—	—	—
2	6	—	HC1064	HC1065	HC1066	HC1068	HC1069	—	—	—
2	7	—	—	—	—	—	HC1070	HC1071	HC1073	HC1074
2½	7	—	—	—	—	—	HC1076	HC1077	HC1079	HC1080
3	7	—	—	—	—	—	HC1086	HC1087	HC1089	HC1090

Note: *Must add prefix, see Note 1; suffix, see Note 2, below.
 ‡F5 and larger will not be color coded.

Note:

1. Add the proper prefix to the HC number to identify the type of connector desired:
 SHC = Straight Hubbell Connector
 NHC = 90° Hubbell Connector
 FHC = Female Hubbell Connector
 VHC = 45° Hubbell Connector
2. Add the proper suffix to identify material desired:
 Aluminum = No suffix
 Zinc-Plated Steel = ZP
 Corrosion Resistant Nylon = CR
 Stainless Steel = SS

3. This chart is a general guide to assist in the selection of Hubbell Cord Connectors for various cord sizes. The Hubbell Cord Connector catalog numbers selected, have been inserted into spaces which in our judgment represent the best cord connector which will fit the listed cord size. The diameters of the cords are approximate and may vary depending on the manufacturer. It is suggested that the appropriate cord manufacturer's dimension chart be consulted for exact dimensions.
4. Cable jacket may have to be stripped to allow conductors to pass through connector body.

NPT Thread Locknuts

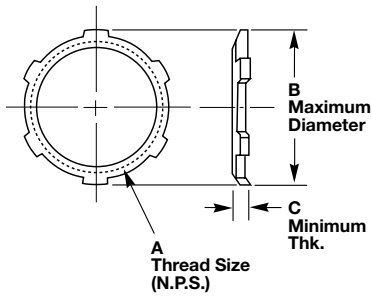

Zinc-Plated Steel

NPT Hub Size	A Inside Diameter Inches	B Outside Dia. Inches (mm)	C Thickness Inches (mm)	Steel Catalog Number
1/2	1/2"-14	1.14" (29.0)	.09" (2.3)	00322001LPK50
3/4	3/4"-14	1.43" (36.3)	.11" (2.8)	00322002LPK50
1	1"-11 1/2	1.77" (45.0)	.13" (3.3)	00322003LPK50
1 1/4	1 1/4"-11 1/2	2.28" (57.9)	.13" (3.3)	00322004LPK50
1 1/2	1 1/2"-11 1/2	2.60" (66.0)	.13" (3.3)	00322005LPK50

Metal Clad Sealing O-Rings – Sizes 1/2 - 4

Zinc-Plated Steel with Neoprene Ring

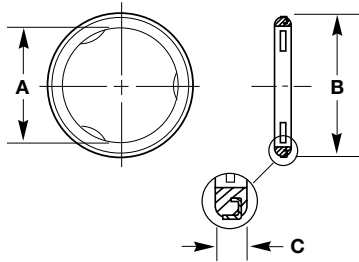

NPT Hub Size	A Inside Diameter Inches (mm)	B Outside Dia. Inches (mm)	C Thickness Inches (mm)	Catalog Number
1/2	.80" (20.3)	1.08" (27.4)	.16" (3.2)	20509001
3/4	1.00" (25.4)	1.34" (34.0)	.16" (3.2)	20509002
1	1.25" (31.6)	1.63" (41.4)	.16" (3.2)	20509003
1 1/4	1.61" (40.9)	2.00" (50.8)	.16" (3.2)	20509004
1 1/2	1.84" (46.7)	2.36" (59.9)	.16" (3.2)	20509005
2	2.31" (58.7)	2.83" (71.9)	.16" (3.2)	20509006

Chrome Plated Steel with Neoprene Ring

2 1/2	2.91" (73.9)	3.44" (87.4)	.24" (6.1)	20509007
3	3.52" (89.4)	4.08" (103.6)	.24" (6.1)	20509008

Nylon PG Thread Locknuts

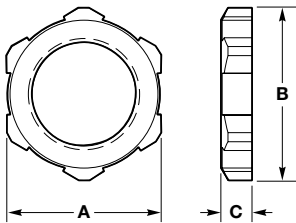

PG Thread Size	A Inches (mm)	B Inches (mm)	C Inches (mm)	Catalog Number
PG7	.75" (19.1)	.80" (20.3)	.22" (5.6)	LNP7BPK100
PG9	.86" (21.8)	.91" (23.2)	.22" (5.6)	LNP9BPK100
PG11	.94" (23.9)	1.03" (26.2)	.22" (5.6)	LNP11BPK100
PG13.5	1.06" (26.9)	1.14" (29.0)	.24" (6.1)	LNP13BPK100
PG16	1.18" (30.0)	1.30" (33.0)	.25" (6.1)	LNP16BPK100
PG21	1.41" (35.8)	1.54" (39.1)	.25" (6.1)	LNP21BPK100
PG29	1.81" (46.0)	2.00" (50.8)	.25" (6.1)	LNP29BPK25
PG36	2.24" (56.9)	2.50" (63.5)	.25" (6.1)	LNP36BPK25

Nylon Metric Thread Locknuts

PG Thread Size	A Inches (mm)	B Inches (mm)	C Inches (mm)	Catalog Number
M12	.75" (19.1)	.82" (20.8)	.22" (5.6)	LNM12BPK100
M16	.87" (22.09)	.98" (25.0)	.22" (5.6)	LNM16BPK100
M20	1.06" (27.0)	1.18" (30.0)	.25" (6.4)	LNM20BPK100
M25	1.38" (35.1)	1.54" (39.1)	.28" (7.1)	LNM25BPK100
M32	1.61" (40.9)	1.80" (45.7)	.28" (7.1)	LNM32BPK100
M40	1.97" (50.0)	2.18" (55.4)	.28" (7.1)	LNM40BPK100

Dimensions shown are approximate and are subject to change without notice.

Kellems® Wire Management Products

Hubbell Juniors®

Material	Operating Temperature Range
Nylon (connectors and GOTCHA® rings)	-40°F to +225°F (-40°C to +107°C)
Neoprene (bushings)	-30°F to +240°F (-34°C to +115°C)

Due to the limiting factors of nylon and neoprene, any complete liquidtight Hubbell Junior will continuously perform in the range of -30°F to +225°F (-34°C to +107°C).

Snap-In continuously performs -40°F to +225°F (-40°C to +107°C).

Flammability

Hubbell Juniors have a UL 94X-2 rating.

Certifications

Product	Agency
Liquidtight and Liquidtight with Spiral	UL Listed. CSA Certified.
Snap-In	UL Recognized. CSA Certified.

Knockout Holes

NPT Hub Size	Knockout Hole Recommended Min. to Max.	
	inches	(mm)
¼	.54"-.57"	(13.7-14.5)
⅜	.67"-.70"	(17.0-17.8)
½	.86"-.91"	(21.8-23.1)

Snap-In

Diameter Range Inches (mm)	For Chassis Thickness (Max.) Inches (mm)	Required Hole Size A Inches (mm)	B Inches (mm)	Dimensional Specifications					G Inches (mm)
				C Inches (mm)	D Inches (mm)	E Inches (mm)	F Inches (mm)		
.22"-.27" (5.6-6.9)	.10" (2.5)	.50" (12.7)	.45" (11.4)	.28" (7.1)	.28" (7.1)	.54" (13.7)	.12" (3.0)	1.84" (44.2)	
.28"-.32" (7.1-8.1)	.10" (2.5)	.50" (12.7)	.47" (11.9)	.28" (7.1)	.33" (8.4)	.59" (15.0)	.12" (3.0)	1.84" (44.2)	
.30"-.36" (7.6-9.1)	.13" (3.3)	.63" (16.0)	.55" (14.0)	.36" (9.1)	.37" (9.4)	.65" (16.5)	.14" (3.6)	2.18" (55.4)	
.32"-.43" (8.1-10.9)	.13" (3.3)	.75" (19.0)	.66" (16.8)	.45" (11.4)	.44" (11.2)	.75" (19.1)	.14" (3.6)	2.60" (66.0)	

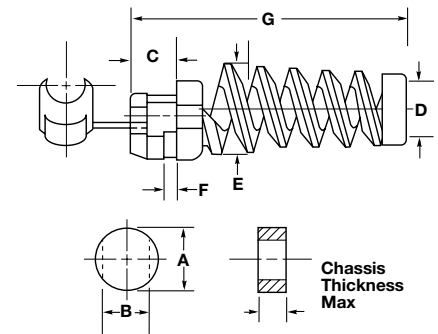

Liquidtight

F NPT Inches	A Dia. Inches (mm)	B Ref. Inches (mm)	C Inches (mm)	D Throat Dia. Inches (mm)	E	
					Across Corners Inches (mm)	Across Flats Inches (mm)
¼-18	.65" (16.5)	1.30" (33.0)	.40" (10.2)	.29" (7.4)	.65" (16.5)	.60" (15.2)
⅜-18	.81" (20.6)	1.44" (36.6)	.41" (10.4)	.36" (9.1)	.81" (20.6)	.75" (19.1)
½-14	1.00" (25.4)	1.56" (39.6)	.46" (11.7)	.45" (11.4)	.99" (25.1)	.92" (23.4)

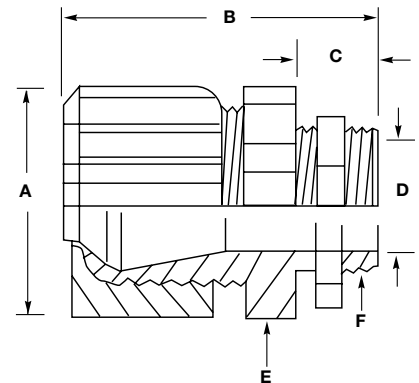

Liquidtight with Spiral

G NPT Inches	A Dia. Inches (mm)	B Ref. Inches (mm)	C Inches (mm)	D Throat Dia. Inches (mm)	E Inches (mm)	F	
						Across Corners Inches (mm)	Across Flats Inches (mm)
¼-18	.65" (16.5)	2.55" (64.8)	.40" (10.2)	.29" (7.4)	.27" (6.9)	.65" (16.5)	.60" (15.2)
⅜-18	.81" (20.6)	3.10" (78.7)	.41" (10.4)	.36" (9.1)	.35" (8.9)	.81" (20.6)	.75" (19.1)
½-14	1.00" (25.4)	3.72" (94.5)	.46" (11.7)	.45" (11.4)	.45" (11.4)	.99" (25.1)	.92" (23.4)

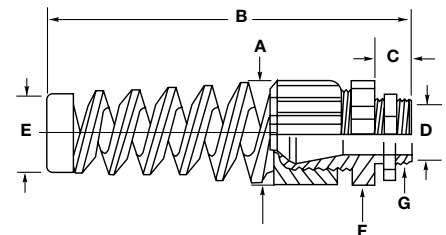

Dimensions shown are approximate and are subject to change without notice.

Kellems® Wire Management Products

Features and Benefits

PolyTuff® I and PolyTuff® II Non-Metallic Liquidtight Conduit

All non-metallic construction ends fatigue and separation problems. They can be cut cleanly with a knife or PVC cutter so there are no jagged metal edges.



PolyTuff® I Conduit, Gray

- Rigid PVC core bonded to flexible PVC jacket
- Approved for outdoor use and direct burial
- UL Listed and CSA Certified



PolyTuff® II Tubing, Black

- PVC core with corrugated walls bonded to PVC jacket
- Handles twists, turns, bends, switchbacks and straightaways with ease
- UL Recognized and CSA Certified



PolyTuff® I Conduit		
IP66 SUITABILITY		
Trade Size (metric designator)	Feet (m)	Catalog Number
¾ (12)	100 (30.5)	G1038
	1200 (365.8)	G1038R1200
½ (16)	100 (30.5)	G1050
	1000 (304.8)	G1050R1000
¾ (21)	100 (30.5)	G1075
	500 (152.4)	G1075R500
1 (27)	100 (30.5)	G1100
	500 (152.4)	G1100R500
1¼ (35)	100 (30.5)	G1125
1½ (41)	50 (15.2)	G1150
2 (53)	50 (15.2)	G1200

Note: See pages W-58 and W-59, W-90 and W-91 for approved fittings.
See pages W-92 and W-93 for technical information and dimensional drawings.

PolyTuff® II Tubing		
IP66 SUITABILITY		
Trade Size (metric designator)	Feet (m)	Catalog Number
¼ (10)	100 (30.5)	B2025
¾ (12)	100 (30.5)	B2038
	1200 (365.8)	B2038R1200
½ (16)	100 (30.5)	B2050
	1000 (304.8)	B2050R1000
¾ (21)	100 (30.5)	B2075
	800 (243.8)	B2075R800
1 (27)	100 (30.5)	B2100
	500 (152.4)	B2100R500
1¼ (35)	100 (30.5)	B2125
1½ (41)	50 (15.2)	B2150
2 (53)	50 (15.2)	B2200

Note: See page W-90 for approved fittings.
See pages W-92 and W-93 for technical information and dimensional drawings.

PolyTuff® Non-Metallic Liquidtight Fittings

Straight with Male Non-Metallic Liquidtight Fittings

Trade Size (metric designator)	Black Catalog Number	Gray Catalog Number
¼ (10)	F2025	—
⅜ (12)	P038NBKA	P038NGYA
½ (16)	P050NBKA	P050NGYA
¾ (21)	P075NBKA	P075NGYA
1 (27)	P100NBKA	P100NGYA
1¼ (35)	P125NBK	P125NGY
1½ (41)	P150NBK	P150NGY
2 (53)	P200NBK	P200NGY

Note: Fittings are to be used with PolyTuff I and PolyTuff II.
See pages W-94 and W-95 for technical information and dimensional drawings.
¾" Liquidtight conduit fitting have ½ NPT male threads.



P075NBKA



P075NGYA

SwivelLok® Multi-Position with Male Non-Metallic Liquidtight Fittings

Trade Size (metric designator)	Black Catalog Number	Gray Catalog Number
⅜ (12)	PS0389NBK	PS0389NGY
½ (16)	PS0509NBK	PS0509NGY
¾ (21)	PS0759NBK	PS0759NGY
1 (27)	PS1009NBK	PS1009NGY

Note: Fittings are to be used with PolyTuff I and PolyTuff II.
See pages W-94 and W-95 for technical information and dimensional drawings.
¾" Liquidtight conduit fitting have ½ NPT male threads.



PS0509NGY

SwivelLok® Multi-Position

Fixed 90° Fittings for Non-Metallic Conduit

Trade Size (metric designator)	Black Catalog Number	Gray Catalog Number
⅜ (12)	P0389NBK	P0389NGY
½ (16)	P0509NBK	P0509NGY
¾ (21)	P0759NBK	P0759NGY
1 (27)	P1009NBK	P1009NGY
1¼ (35)	P1259NBK	P1259NGY

Note: Fittings are to be used with PolyTuff I and PolyTuff II.
See pages W-94 and W-95 for technical information and dimensional drawings.
¾" Liquidtight conduit fitting have ½ NPT male threads.



P0759NBK



P0759NGY

SwivelLok® Flexible Conduit Kit

Trade Size (metric designator)	Fitting and Conduit	Catalog Number
½ (16)	2 PS0509NGY, 6' G1050	PS05GYKIT
¾ (21)	2 PS0759NGY, 6' G1075	PS07GYKIT

Note: See pages W-94 and W-95 for technical information and dimensional drawings.



PS05GYKIT

Metallic Liquidtight Conduit Fittings

Straight Conduit Fitting



H075



H0751

Trade Size (metric designator)	Insulated	Non-Insulated
3/8 (12)	H0381	H038
1/2 (16)	H0501	H050
3/4 (21)	H0751	H075
1 (27)	H1001	H100
1 1/4 (35)	H1251	H125
1 1/2 (41)	H1501	H150
2 (53)	H2001	H200
2 1/2 (63)	H2501	H250
3 (78)	H3001	H300
3 1/2 (91)	H3501	H350
4 (103)	H4001	H400

Note: 3/8" Liquidtight conduit fitting have 1/2 NPT male threads.
For use with Liquidtight Metal conduit and PolyTuff I Non-Metallic conduit.
See page W-96 for technical information.

45° Conduit Fitting



H0754



H07541

Trade Size (metric designator)	Insulated	Non-Insulated
3/8 (12)	H03841	H0384
1/2 (16)	H05041	H0504
3/4 (21)	H07541	H0754
1 (27)	H10041	H1004
1 1/4 (35)	H12541	H1254
1 1/2 (41)	H15041	H1504
2 (53)	H20041	H2004

Note: 3/8" Liquidtight conduit fitting have 1/2 NPT male threads.
For use with Liquidtight Metal conduit and PolyTuff I Non-Metallic conduit.
See page W-96 for technical information.

90° Conduit Fitting



H0759



H07591

Trade Size (metric designator)	Insulated	Non-Insulated
3/8 (12)	H03891	H0389
1/2 (16)	H05091	H0509
3/4 (21)	H07591	H0759
1 (27)	H10091	H1009
1 1/4 (35)	H12591	H1259
1 1/2 (41)	H15091	H1509
2 (53)	H20091	H2009
2 1/2 (63)	H25091	H2509
3 (78)	H30091	H3009
4 (103)	H40091	H4009

Note: 3/8" Liquidtight conduit fitting have 1/2 NPT male threads.
For use with Liquidtight Metal conduit and PolyTuff I Non-Metallic conduit.
See page W-96 for technical information.

Kellems® Wire Management Products

PolyTuff® I Conduit

Operating Temperature Range

Wet environment	0°F to +140°F (-18°C to +60°C).
Oil environment	0°F to +158°F (-18°C to +70°C).
Dry environment	0°F to +176°F (-18°C to +80°C).

Certifications

UL Listed CSA Certified	UL Standard 1660. Sunlight resistant approved for outdoor use, direct burial. Meets requirements of NEC.
----------------------------	---

Voltage Rating

Maximum	600V.
---------	-------

Material

Conduit	Co-extruded rigid and flexible PVC.
---------	-------------------------------------

PolyTuff® II Tubing

Operating Temperature Range

Operating environment	0°F to +140°F (-18°C to +60°C).
-----------------------	---------------------------------

Certifications

UL Recognized CSA Certified	
--------------------------------	--

Voltage Rating

Maximum	Same as wire insulation rating.
---------	---------------------------------

Material

Tubing	Co-extruded rigid and flexible PVC.
--------	-------------------------------------

PolyTuff® I Conduit

Trade Size (metric designator)	Conduit ID/OD		Bend Radius	
	Inches	(mm)	Inches	(mm)
3/8 (12)	.49"/.70"	(12.6/17.8)	2.00"	(50.8)
1/2 (16)	.63"/.83"	(16.1/21.1)	3.00"	(76.2)
3/4 (21)	.83"/1.04"	(21.1/26.4)	4.00"	(101.6)
1 (27)	1.05"/1.30"	(26.0/33.1)	5.00"	(127.0)
1 1/4 (35)	1.40"/1.65"	(35.4/41.8)	6.30"	(158.8)
1 1/2 (41)	1.59"/1.88"	(40.3/47.8)	7.50"	(190.5)
2 (53)	2.03"/2.36"	(51.6/59.9)	10.00"	(254.0)

PolyTuff® II Tubing

Trade Size (metric designator)	Conduit ID/OD		Bend Radius	
	Inches	(mm)	Inches	(mm)
1/4 (10)	.36"/.57"	(9.3/14.5)	1.50"	(38.1)
3/8 (12)	.49"/.70"	(12.6/17.8)	2.00"	(50.8)
1/2 (16)	.63"/.83"	(16.1/21.1)	2.00"	(50.8)
3/4 (21)	.83"/1.04"	(21.1/26.4)	3.00"	(76.2)
1 (27)	1.05"/1.30"	(26.0/33.1)	3.00"	(76.2)
1 1/4 (35)	1.40"/1.65"	(35.4/41.8)	5.00"	(127.0)
1 1/2 (41)	1.59"/1.88"	(40.3/47.8)	5.00"	(127.0)
2 (53)	2.03"/2.36"	(51.6/59.9)	5.00"	(127.0)

PolyTuff® I and II Conduit/Tubing; PVC Chemical Resistance

Chemical	Conc.*	Temp.		Chemical	Conc.*	Temp.		Chemical	Conc.*	Temp.	
		70°F 21°C	150°F 66°C			70°F 21°C	150°F 66°C			70°F 21°C	150°F 66°C
Acetate Solvents		D	D	Coconut Oil		C	D	Lubricating Oils		A	A
Acetic Acid		B	C	Corn Oil		A	B	Magnesium Chloride		A	A
Acetic Acid (Glacial)		C	D	Cottonseed Oil		C	D	Magnesium Hydroxide		A	A
Acetone		D	D	Creosote		D	D	Magnesium Sulfate		A	A
Acrylonitrile		A	B	Cresol		C	D	Malathion 50 in Aromatics		D	D
Alcohols (Aliphatic)		C	C	Crysylic Acid		D	D	Malic Acid		A	A
Aluminum Chloride		A	A	Cyclohexane		B	C	Methyl Acetate		D	D
Aluminum Sulfate (Alums)		A	A	DDT Weed Killer		A	C	Methyl Alcohol		C	C
Ammonia (Anhydrous Liquids)		D	D	Dibutyl Phthalate		D	D	Methyl Bromide		D	D
Ammonia (Aqueous)		A	A	Diesel Oils		C	D	Methyl Ethyl Ketone		D	D
Ammoniated Latex		A	C	Diethylene Glycol		B	C	Methylene Chloride		D	D
Ammonium Chloride		A	A	Diethyl Ether		A	C	Mineral Oil			
Ammonium Hydroxide		A	A	Di-isodecyl Phthalate		D	D	Monochlorobenzene		A	A
Amyl Acetate		D	D	Diocetyl Phthalate		D	D	Muriatic Acid (see Hydrochloric Acid)			
Aniline Oils		D	D	Dow General Weed Killer (Phenol)		D	D	Naphtha		C	D
Aromatic Hydrocarbons		D	D	Dow General Weed Killer (H2O)		B	C	Naphthalene		D	D
Asphalt		D	D	Ethyl Alcohol		C	C	Nitric Acid		10%	A B
ASTM Fuel A		C	C	Ethylene Dichloride		D	D	Nitric Acid		35%	A C
ASTM Fuel B		D	D	Ethylene Glycol		B	C	Nitric Acid		70%	D D
ASTM #1 Oil		B	C	Ferric Chloride		A	A	Oleic Acid			A C
ASTM #3 Oil		C	D	Ferric Sulfate		A	A	Oleum			D D
Barium Chloride		A	A	Ferrous Chloride		A	A	Oxalic Acid			A A
Barium Sulfide		A	A	Ferrous Sulfate		A	A	Pentachlorophenol in Oil			B C
Barium Hydroxide		A	A	Formaldehyde		D	D	Pentane			C D
Benzene (Benzol)		D	D	Fuel Oil		B	C	Perchloroethylene			B C
Benzine (Petroleum Ether)		C	C	Furfural		C	C	Petroleum Ether			C C
Black Liquor		A	A	Gallic Acid		A	A	Phenol			A A
Bordeaux Mixture		A	A	Gasoline (Hi Test)		C	D	Phosphoric Acid		10%	A A
Boric Acid		A	A	Glycerine		A	A	Pitch		50%	A B
Butyl Acetate		D	D	Grease		A	C	Potassium Hydroxide			C D
Butyl Alcohol		B	C	Green Sulfate Liquor		A	A	Sodium Cyanide			A A
Calcium Hydroxide		A	A	Heptachlor in Petroleum Solvents		A	C	Stoddard Solvent			D D
Calcium Hypochlorite		A	A	Heptane		C	D	Styrene			D D
Carbolic Acid (Phenol)		B	C	Hexane		C	D	Sulfur Dioxide (liquid)			D D
Carbon Dioxide		A	A	Hydrobromic Acid		A	A	Sulfuric Acid		50%	A B
Carbon Disulfide		D	D	Hydrochloric Acid		10%	A A	Sulfuric Acid		98%	D D
Carbon Tetrachloride		D	D	Hydrochloric Acid		40%	C C	Sulfurous Acid			B C
Carbonic Acid		A	A	Hydrofluoric Acid		70%	D D	Tall Oil			D D
Casein		A	C	Hydrofluorosilicic Acid			A A	Tannic Acid			A A
Caustic Soda		A	B	Hydrofluorosilicic Acid		10%	A A	Toluene			D D
Chlorine Gas (wet)		D	D	Hydrogen Peroxide			A B	Trichlorethylene			D D
Chlorine Gas (dry)		D	D	Iso-Octane			C C	Triethanol Amine			C D
Chlorine (water solution)		C	D	Isopropyl Acetate			D D	Tricresyl Phosphate (Skydrol)			D D
Chlorobenzene		D	D	Isopropyl Acid			B C	Turpentine			C D
Chlorinated Hydrocarbons		D	D	Jet Fuels (JP-3, and 5)			C D	Vinegar			A B
Chromic Acid		B	C	Kerosene			C C	Vinyl Chloride			D D
Citric Acid		A	A	Ketones			D D	Water			A A
Coal Tar		D	D	Linseed Oil			A A	White Liquor			A A
								Xylene			D D
								Zinc Chloride			A A
								Zinc Sulfate			A A

Note: *Conc. = Concentration.

(All ratings apply to concentrated or saturated solutions unless otherwise specified.)

Chemical resistance ratings are based upon information supplied by the raw material manufacturers.

Use as a general guide only – samples should be tested by user under actual conditions.

Rating Code

A-Excellent service

No harmful effect to reduce service life. Suitable for continuous service.

B-Good service life.

Moderate to minor effect. Good for intermittent service. Generally suitable for continuous service.

C-Fair or limited service.

Depends on operating conditions. Generally suitable for intermittent service. Not recommended for continuous service.

D-Unsatisfactory service.

Not recommended.

PolyTuff® Fittings

Operating Temperature*

Nylon (Body, Nut, Gripping Ring and Locknut)	-40°F to +225°F (-40°C to +107°C).
Neoprene (Sealing Ring)	-30°F to +240°F (-34°C to +116°C).

Flammability

Fire Gas Toxicity Product Testing	Nylon PolyTuff Fittings have a UL 94X-2 rating.
-----------------------------------	---

Certifications

UL Listed	UL50 Type 4X, 12 and 13.
CSA Certified	PolyTuff I Fittings, PolyTuff II Fittings.

Liquidtight Fittings

Operating Temperature**

Steel/Malleable Iron (Nut, Body, Ferrule)	-60°F to +1000°F (-51°C to +538°C).
Nylon (Gland Ring)	-40°F to +225°F (-40°C to +107°C).

Hazardous Locations - NEC Reference

Class I, Div. 2 - 501-10(A)(3)B
Class II, Div. 1 - 502-10(A)(2)
Class II, Div. 2 - 502-10(A)(3)
Class III, Div. 1 - 503-10(A)(2)
Class III, Div. 2 - 503-10(B)

Certifications

UL Listed to UL 514B
CSA Certified

Note: *Due to the limiting factors of nylon and neoprene, PolyTuff Fittings will continuously perform in the range -30°F to +225°F (-34°C to +107°C).

**Due to the limiting factors of nylon, metallic liquidtight flexible conduit fittings will continuously perform in the range of -40°F to +225°F (-40°C to +107°C).

Straight with Male Non-Metallic Liquidtight Fittings

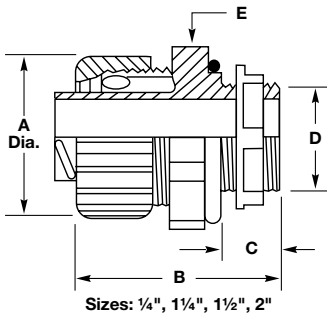

Trade Size (md**)	A	B	C	D Throat Dia.	E	
					Across Corners	Across Flats
1/4 (10)	.93" (23.6)	1.45" (36.8)	.39" (9.9)	.32" (8.1)	.86" (Dia.) (21.8)	
3/8 (12)	1.14" (29.0)	1.63" (41.4)	.57" (14.5)	.42" (10.7)	1.41" (35.8)	1.30" (33.0)
1/2 (16)	1.30" (33.0)	2.14" (54.4)	.57" (14.5)	.55" (14.0)	1.41" (35.8)	1.30" (33.0)
3/4 (21)	1.53" (38.9)	2.22" (56.4)	.58" (14.7)	.74" (18.8)	1.85" (47.0)	1.53" (38.9)
1 (27)	1.80" (45.7)	2.32" (58.9)	.72" (18.3)	.96" (24.4)	1.94" (49.3)	1.80" (45.7)
1 1/4 (35)	2.20" (55.9)	2.15" (54.6)	.74" (18.8)	1.30" (33.0)	2.38" (60.5)	2.18" (55.4)
1 1/2 (41)	2.49" (63.2)	2.35" (59.7)	.76" (19.3)	1.46" (37.1)	2.63" (66.8)	2.43" (61.7)
2 (53)	3.05" (77.4)	2.51" (63.6)	.79" (20.1)	1.90" (48.3)	3.13" (79.5)	2.93" (74.4)

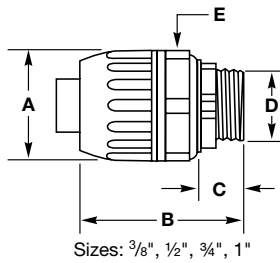

90° with Male Non-Metallic Liquidtight Fittings

Trade Size (md**)	A	B	C	D Throat Dia.	E	
					Across Corners	Across Flats
1/4 (10)	.93" (23.6)	1.88" (47.8)	.39" (9.9)	.32" (8.1)	.86" (Dia.) (21.8)	
1 1/4 (35)	2.21" (56.1)	3.57" (90.7)	.74" (18.9)	1.30" (33.0)	2.38" (60.5)	2.18" (55.4)

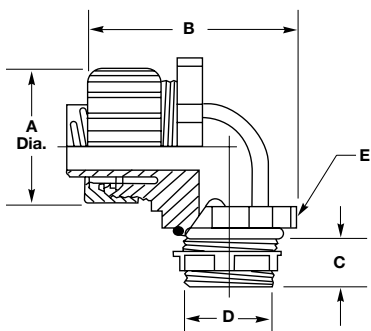

SwivelLok® Multi-Position Liquidtight Fittings

Trade Size (md**)	A	B	C	D	E	F	G	
							Across Corners	Across Flats
3/8 (12)	1.30" (33.0)	3.27" (83.1)	.57" (14.5)	.55" (14.0)	1.43" (36.3)	2.00" (50.8)	1.41" (35.8)	1.30" (33.0)
1/2 (16)	1.30" (33.0)	3.27" (83.1)	.57" (14.5)	.55" (14.0)	1.43" (36.3)	2.00" (50.8)	1.41" (35.8)	1.30" (33.0)
3/4 (21)	1.53" (38.9)	3.66" (93.0)	.58" (15.7)	.74" (18.8)	1.59" (40.4)	2.23" (56.6)	1.65" (41.9)	1.53" (38.9)
1 (27)	1.80" (45.7)	4.00" (101.6)	.72" (18.3)	.96" (24.4)	1.84" (46.7)	2.30" (58.4)	1.94" (49.3)	1.80" (45.7)

Note: *A/C = Across Corners, A/F = Across Flats.
**md = metric designator.

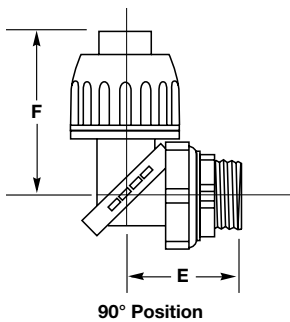

90° Position

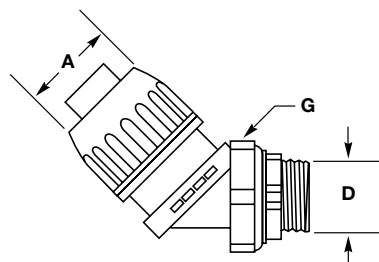

45° Position

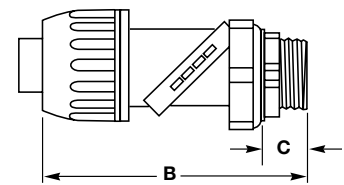

Straight Position

Straight with Male Metallic Metal Fitting

Trade Size (md**)	A Ref.	B	C		D Throat Dia.	E	
			A/C*	A/F*		A/C*	A/F*
3/8 (12)	1.43" (36.3)	.59" (15.0)	1.20" (30.0)	1.06" (26.9)	.61" (15.5)	1.07" (27.2)	.93" (23.6)
1/2 (16)	1.43" (36.3)	.59" (15.0)	1.34" (34.0)	1.19" (30.2)	.61" (15.5)	1.22" (31.0)	1.06" (26.9)
3/4 (21)	1.56" (39.6)	.59" (15.0)	1.55" (39.0)	1.37" (34.8)	.84" (21.3)	1.43" (36.3)	1.25" (31.8)
1 (27)	1.68" (42.7)	.66" (16.8)	1.95" (50.0)	1.69" (42.9)	1.06" (26.9)	1.73" (43.9)	1.56" (39.6)
1 1/4 (35)	2.03" (51.6)	.63" (16.8)	2.39" (61.0)	2.06" (52.3)	1.37" (34.8)	2.36" (59.9)	2.08" (52.8)
1 1/2 (41)	2.21" (56.1)	.63" (16.8)	2.72" (69.0)	2.38" (60.5)	1.53" (38.9)	2.79" (70.9)	2.48" (63.0)
2 (53)	2.28" (57.9)	.69" (17.5)	3.08" (78.0)	2.87" (72.9)	2.06" (52.3)	3.32" (84.3)	2.90" (73.7)
2 1/2 (63)	3.56" (90.4)	1.06" (26.9)	3.92" (100.0)	3.62" (91.9)	2.42" (61.5)	3.85" (97.8)	3.60" (91.4)
3 (78)	3.81" (96.8)	1.06" (26.9)	4.70" (119.0)	4.31" (109.5)	3.01" (76.5)	4.65" (118.1)	4.33" (110.0)
3 1/2 (91)	3.81" (96.8)	1.06" (26.9)	5.29" (134.0)	4.81" (122.2)	3.49" (88.6)	5.18" (131.6)	4.82" (122.4)
4 (103)	3.81" (96.8)	1.06" (26.9)	5.75" (146.0)	5.31" (134.9)	3.96" (100.6)	5.75" (146.1)	5.39" (136.9)

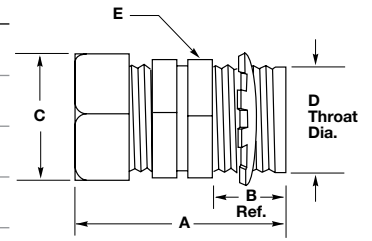

45° with Male Metallic Metal Fitting

Trade Size (md**)	A	B	C	D		E Throat Dia.	F	
				A/C*	A/F*		A/C*	A/F*
3/8 (12)	1.19" (30.2)	1.28" (32.5)	.59" (15.0)	1.20" (30.5)	1.06" (26.9)	.60" (15.2)	1.16" (29.5)	1.02" (25.9)
1/2 (16)	1.19" (30.2)	1.28" (32.5)	.59" (15.0)	1.34" (34.0)	1.19" (30.2)	.61" (15.2)	1.21" (30.7)	1.06" (26.9)
3/4 (21)	1.19" (30.2)	1.43" (36.3)	.59" (15.0)	1.55" (39.4)	1.45" (36.8)	.84" (21.3)	1.50" (38.1)	1.32" (33.5)
1 (27)	1.38" (35.1)	1.53" (38.9)	.66" (16.8)	1.95" (49.5)	1.69" (42.9)	1.05" (26.7)	1.82" (46.2)	1.59" (40.4)
1 1/4 (35)	1.42" (36.1)	1.69" (42.9)	.63" (16.0)	2.39" (60.7)	2.06" (52.3)	1.37" (34.8)	2.32" (58.9)	2.03" (51.6)
1 1/2 (41)	1.66" (42.2)	2.00" (50.8)	.66" (16.8)	2.72" (69.1)	2.38" (60.5)	1.60" (40.6)	2.62" (66.5)	2.29" (58.2)
2 (53)	1.69" (42.9)	2.25" (57.2)	.66" (16.8)	3.08" (78.2)	2.88" (73.2)	2.05" (52.1)	3.21" (81.5)	2.80" (71.1)

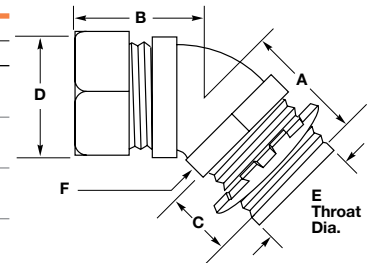

90° with Male Metallic Metal Fitting

Trade Size (md**)	A	B	C		D Ref.	E Throat Dia.	F	
			A/C*	A/F*			A/C*	A/F*
3/8 (12)	1.31" (33.3)	.59" (15.0)	1.20" (30.5)	1.06" (26.9)	1.44" (36.6)	.60" (15.2)	1.13" (29.0)	.99" (25.1)
1/2 (16)	1.31" (33.3)	.59" (15.0)	1.34" (34.0)	1.12" (28.4)	1.44" (36.6)	.61" (15.5)	1.12" (28.0)	1.00" (25.4)
3/4 (21)	1.44" (36.6)	.59" (15.0)	1.55" (39.4)	1.45" (36.8)	1.63" (41.4)	.83" (21.1)	1.48" (38.0)	1.29" (32.8)
1 (27)	1.78" (45.2)	.59" (15.0)	1.95" (49.5)	1.60" (40.6)	2.19" (55.6)	1.05" (26.7)	1.80" (46.0)	1.57" (39.9)
1 1/4 (35)	1.97" (50.0)	.63" (16.0)	2.39" (60.7)	2.06" (52.3)	2.50" (63.5)	1.36" (34.5)	2.32" (59.0)	2.02" (51.3)
1 1/2 (41)	2.19" (55.6)	.63" (16.0)	2.72" (69.1)	2.38" (60.5)	2.69" (68.3)	1.61" (40.9)	2.58" (66.0)	2.25" (57.2)
2 (53)	2.53" (64.3)	.66" (16.8)	3.08" (78.2)	2.87" (72.9)	3.25" (82.6)	2.05" (52.1)	3.14" (80.0)	2.75" (69.9)
2 1/2 (63)	3.44" (87.4)	1.00" (25.4)	3.92" (99.6)	3.63" (92.2)	4.25" (108.0)	2.42" (61.5)	3.78" (96.0)	3.50" (88.9)
3 (78)	3.75" (95.3)	1.00" (25.4)	4.70" (119.4)	4.31" (109.5)	4.87" (123.7)	3.01" (76.5)	4.64" (118.0)	4.30" (109.2)
4 (103)	4.25" (108.0)	1.00" (25.4)	5.75" (146.1)	5.31" (134.9)	5.63" (143.0)	3.96" (100.6)	5.76" (146.0)	5.38" (136.7)

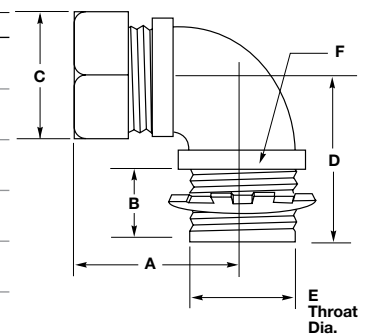

Note: *A/C = Across Corners, A/F = Across Flats.
**md = metric designator.

Power and AV Boxes

Table of Contents



Furniture and Work Surface Boxes



AV Ceiling and In-Wall Enclosures



STAB-IT Boxes and Standard Boxes

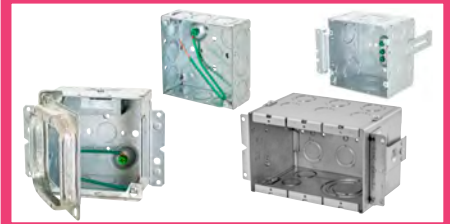

Product	Page
Furniture / Work Surface Boxes and Table Top Boxes	
2x2 USB Work Surface Pop-Up Box	X-2
Pre-Wired Work Surface Series	X-3
Pre-Wired Work Surface Elite Series	X-4
AV and Power Ceiling Boxes	X-5
AV In-Wall Boxes	X-6
AV In-Wall Enclosure	X-7
Four\eleven sixtieth STABIT-IT Connectors and Boxes	X-8
Four inch STAB-IT boxes	X-9
Mud Rings, Covers and Supports	X-10
Grand Slam Junction Boxes	X-11
AV Wall Boxes / Gangable boxes	X-12
Large capacity Wall Boxes	X-13
SNAPConnect® Devices & Accessories	X-14

Dimensions in Inches (mm)

Features and Benefits

Pre-Wired 2X2 USB Work Surface Pop-Up Box

Hubbell's UL Listed 2X2 USB Work Surface Pop-Up Boxes is ideal for work surfaces, such as desks, which require power for a computer and USB charging for smart devices. Each box includes one 125V, 15A duplex receptacle and two USB ports, one type A and one Type-C. Developed with coordination from the hotel industry, the Hubbell Pop-Up Box utilizes a pneumatic spring for providing a smooth action for opening and closing. Available in brushed aluminum, black powder coat and white powder coat, the Pop-Up Box is suited for installation with any modern décor, making it excellent for conference rooms or classrooms that are frequently rearranged.

Installation is simple and only requires a jig-saw or similar saw plus a screwdriver. The unit is supplied with a 5 foot cord with a molded plug end allowing it to be installed with ease. Designed to be installed into existing desks or by furniture manufacturers. The Hubbell 2X2 USB Work Surface Pop-Up Box is ideally suited for any work surface application.

- cULus listed to UL962A for Furniture Power Distribution Units



Box Design

- Gas-spring actuation for smooth opening and closing
- Die cast aluminum construction
- Rated for +10,000 open/close cycles
- Simple three-screw installation
- Unobtrusive low profile flange at 0.05 in.
- Charging convenience at the push of a button



USB Device

- 15A duplex with two USB ports; available with Type A & C with 5A capacity
- Tamper-resistant receptacle
- LED power indicating light
- Low .070" tapered flange height
- 5 ft, pre-wired, 12 gauge, 3 wire electrical cord

2X2 USB Work Surface Pop-Up Boxes, NEMA 5-15 Duplex Receptacle

Description	Finish	USB Type A & C, 5A-5V USB Output
15A 125V duplex receptacle with (2) USB charging ports, 5 foot long cord with NEMA 5-15 plug	Brushed Aluminum	WSBUSB2X2AC5ALU
	Black Powder Paint	WSBUSB2X2AC5BLK
	White Powder Paint	WSBUSB2X2AC5WHT

Note: UL File Number E327832.

Work Surface Pop-Up Box Specifications

Maximum	Cut Out	Surface	Tapered Flange	Product	Cord
Surface Thickness	Dimensions	Dimensions	Height	Depth	Length
1.125"	4.62" x 4.62"	5" x 5"	0.070"	3.55"	5 Feet

Dimensions

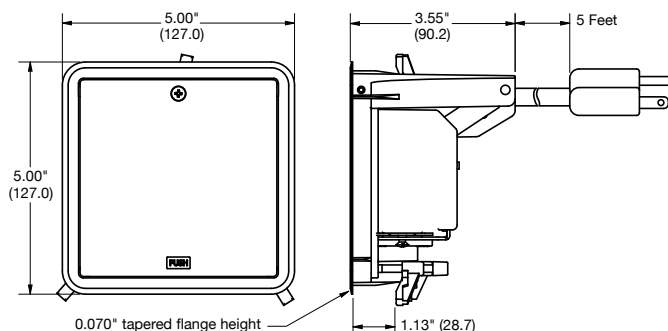

WSBUSB2X2AC5ALU



WSBUSB2X2AC5BLK



WSBUSB2X2AC5WHT

Dimensions in Inches (mm)

Power and AV Boxes

Features and Benefits

Pre-Wired Furniture and Work Surface Connectivity Boxes, Surface Series

This family of furniture and work surface connectivity boxes installs into conference tables and workstations to bring power, voice, data, and multimedia directly to the point of use. In addition, they offer an aesthetic design with improved cable management. Now, users can plug in laptops, projectors and other equipment at the desktop level - no more crawling under the table or moving obstacles to get to the electrical outlet and network connectivity.



Table Top Pre-Wired Boxes

- Round dual-service boxes easily install into a 3½ inch diameter core hole
- Power is pre-wired and keystone openings accommodate data or multi-media activation



Lift-Up Style Pre-Wired Boxes

- Two (2) pre-wired 15A outlets with 6 ft. power supply cord
- 1-Unit opening for Hubbell iSTATION modules



Pre-Wired Work Surface Elite Series

- Configured with four (4) pre-wired 15A power outlets with 6 ft. cord
- Includes Three (3) 1-Unit Hubbell iSTATION modules
- Available in Anodized and Painted finishes

Table Top Boxes

Low Voltage Only

Description	Finish	Dimensions	Catalog Number
Table Top box; 2 inch diameter hole; (1) keystone opening; Keystone modules sold separately.	Black Anod. Alum. Clear Anod. Alum. Solid Brass	2.19" Diameter	TTBKSBK TTBKSAAL TTBKSBR
Table Top box; 2 inch diameter hole; (1) XLR microphone jack installed.	Black Anod. Alum. Clear Anod. Alum. Solid Brass	2.19" Diameter	TTBXLRBK TTBXLRAL TTBXLRBR



Pre-Wired Dual-Service

Description	Finish	Dimensions	Catalog Number
Table Top box; 3.5 inch diameter hole; (1) pre-wired 15A outlet with 9 foot power supply cord; (1) 3.5mm screw terminal audio jack; (1) 15-pin gender changer F/F; (2) keystone openings; Keystone modules sold separately.	Black Anod. Alum. Clear Anod. Alum. Solid Brass	3.88" Diameter	TTBDS1BK TTBDS1AL TTBDS1BR
Table Top box; 3.5 inch diameter hole; (2) pre-wired 15A outlets with 9 foot power supply cord; (2) keystone openings; Keystone modules sold separately.	Black Anod. Alum. Clear Anod. Alum. Solid Brass	3.88" Diameter	TTBDS2BK TTBDS2AL TTBDS2BR



Note: See section A for power devices and section Y for datacom accessories.

Dimensions in Inches (mm)

Pre-Wired Furniture and Work Surface Connectivity Boxes, Surface Series



WSBF22BK



WSBF22SV



WSBFGROMSV

Grommet Style

Description	Finish	Dimensions	Catalog Number
Two (2) pre-wired 15A outlets with 6 ft. power supply cord; two (2) Hubbell Keystone openings.	Black Silver	8.62"L x 3.0"W x 2.25"H	WSBF22BK WSBF22SV

Flush grommet cover with dust shield.	Black Silver Brushed Aluminum Brushed Stainless Steel	5.68"L x 3.39"W x 0.96"H	WSBFGROMBK WSBFGROMSV WSBFGROMBAL WSBFGROMBSS
---------------------------------------	--	--------------------------	--



WSBG43UBK



WSBG43USV

(cover doors shown open)

Pre-Wired Work Surface Elite Series

Recessed Concealed Services

Description	Finish	Dimensions	Catalog Number
Four (4) pre-wired 15A outlets with 6 ft. power supply cord; three (3) low voltage openings which allow for three (3) 1-unit Hubbell iSTATION modules.	Black Silver Clear Anodized Black Anodized	15.0"L x 9.0"W x 6.25"H	WSBG43UBK WSBG43USV WSBG43UBAL WSBG43UBBA

Replacement Low Voltage Data Plates

Description	Finish	Dimensions	Catalog Number
Non-metallic low voltage plate, blank.	Black	3.18"L x 1.88"W	WSBPLATE1
Non-metallic low voltage plate, 1-unit Hubbell iSTATION cut-out.	Black	3.18"L x 1.88"W	-

Note: UL File Number E327832.

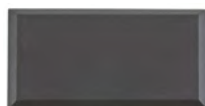

WSBPLATE1

Dimensions in Inches (mm)

Features and Benefits

AV and Power Ceiling Boxes

The AV Ceiling Enclosure is designed to house active AV devices and integrate AV distribution, data connections and power in one location, providing a direct connection to a projector or a display device. The enclosure protects and conceals your equipment and connections for a clean installation while maintaining accessibility with the hinged access doors.

- Neatly Manage AV, power, and data requirements inside one enclosure
- Two Enclosures Sizes to Match your Required Application
- Flush mounted, white enclosure for consistent look when mounted in the ceiling
- Hinged access doors accepts field installed ceiling tiles
- Enclosures with 1-1/2" conduit hubs for projector mounting
- All steel rugged construction provides the ultimate strength for installation

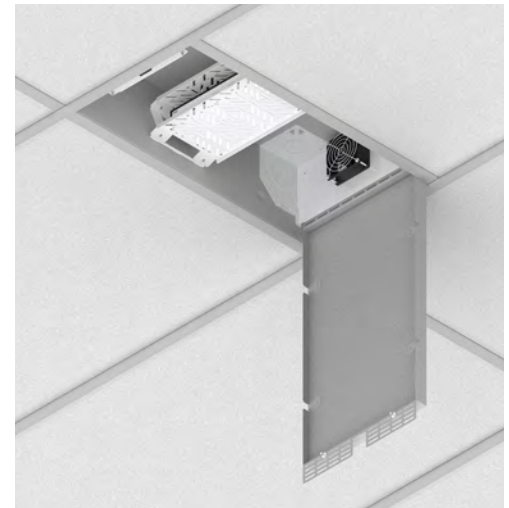

HRCB12WHT



HRCB22PWHT

1' x 2' Plenum Rated Ceiling Boxes

Description	Length	Width	Height	Color	Catalog Number
Recessed ceiling box	23.69" (601.7mm)	11.69" (296.9mm)	6.00" (152.4mm)	White	HRCB12WHT
Recessed ceiling box with 1-1/2" NPT projector pole adapter	23.69" (601.7mm)	11.69" (296.9mm)	6.00" (152.4mm)	White	HRCB12PWHT
HRCB12 Series Box hard ceiling frame kit	23.57" (598.7mm)	12.94" (328.7mm)	7.38" (187.4mm)	White Flange	HRCB12HCFK
HRCB12 series box cooling fan kit	10.88" (276.3mm)	1.89" (48.1mm)	4.91" (124.6mm)		HRCB12FAN

Note: 1'x2' ceiling boxes includes; (1) external 15A, 125V single receptacle and internal (2) 15A, 125V leaded duplex receptacles .

2' x 2' Plenum Rated Ceiling Boxes

Description	Length	Width	Height	Color	Catalog Number
Recessed ceiling box	23.69" (601.7mm)	23.69" (601.7mm)	6.00"(152.4mm)	White	HRCB22WHT
Recessed ceiling box with 1-1/2" NPT projector pole adapter	23.69" (601.7mm)	23.69" (601.7mm)	6.00" (152.4mm)	White	HRCB22PWHT
HRCB22 Series Box hard ceiling frame kit	23.57" (598.7)	24.94" (633.5)	7.38" (187.4)	White Flange	HRCB22HCFK
HRCB22 series box cooling fan kit	9.54" (242.3mm)	1.89" (48.1mm)	4.89" (124.2)		HRCB22FAN

Note: 2'x2' ceiling boxes includes; (1) external switched 15A, 125V single receptacle and internal (5) 15A, 125V single receptacles

1' x 2' & 2' x 2" Ceiling Box Accessories

Description	Length	Width	Height	Size	Catalog Number
Ceiling box cable support kit, 4 cables	95" (2413.0mm)				HRCBMNT1
Ceiling box threaded rod kit, 4 brackets	0.88" (22.2)	0.06" (1.6mm)	1.19"(30.2)	0.09" (2.4mm) Dia Up to 3/8" Threaded Rod	HRCBTHRD

AV Ceiling Enclosure

- Manage multiple applications inside one enclosure
- Flush mounted, white enclosure for consistent look when mounted in the ceiling
- Loaded with two Hubbell 20A duplex receptacles and a 2-gang back box
- All steel rugged construction provides the ultimate strength for installation



AVCE1H

Dimensions in Inches (mm)

Description	Height Inches (mm)	Width Inches (mm)	Depth Inches (mm)	Color	Catalog Number
AV ceiling enclosure.	12" (305)	24" (610)	8" (203)	White	AVCE1H

Note: Enclosure includes two 20 amp duplex receptacles and 2-gang back box.

Features and Benefits

AV In-Wall Boxes

Power, data, interfaces and more will mount discretely behind the flat screen. Covers two piece are available in white or black. Supplied with mounting screws for wood or steel stud mounting, grounding screws, tie wraps, and a rubber grommet. One of the single gang knockouts has a 1"x2" oblong internal knockout and can be used with the supplied grommets. The flush box installation allows flat panel displays and interactive "smart" boards to sit flush against walls with no dangling cords.

- Low voltage conduit feed-thru for connectorized cables with 1", 1-1/2" and 2" Knockouts
- 3/4" extension available for concrete block walls
- Two-piece paintable cover allows for better cable management
- Boxes Conforms to UL 62368-1:2019 Ed.3, Certified to CSAC22.2#62368-1:2019 Ed.3



HRWB25WHT with 2 Inch Low Voltage Feed-Through



HRWB25WHT



HRWB25WHT with HRW25BE075

Wall Boxes

Description	Height	Width	Depth	Cover Color	Catalog Number
Recessed 5-Gang wall box w/ 2" feed-thru	7.24" (183.8)	14.25" (362.0)	4.00" (141.6)	White	HRWB25WHT
HRWB25WHT replacement covers	8.34" (211.7)	15.50" (393.7)	0.16" (4.0)	White	HRWB25WHTRC
Recessed 5-Gang wall box w/ 2" feed-thru	7.24" (183.8)	14.25" (362.0)	4.00" (141.6)	Black	HRWB25BLK
HRWB25BLK replacement covers	8.34" (211.7)	15.50" (393.7)	0.16" (4.0)	Black	HRWB25BLKRC
HRWB25 series wall box 3/4" extension	7.47" (189.7)	14.50" (368.3)	0.75" (19.1)	Steel	HRWB25BE075



IFP16W



NSOKPS



IMF1W



HXJ6W



SFHC14W

Power Kits

Description	Color	Catalog Number
Standard power kit.	White	NSOKPTR
Surge protected power kit.	White	NSOKPS

AV Connectors and Plates

Description	Color	Catalog Number
1-Gang 6-Port Plate.	White	IFP16W
1-Gang Hubbell iSTATION Plate	White	IMF1W
Category 6 Jack	White	HXJ6W
HDMI Feed-Thru	White	SFHC14W

Dimensions in Inches (mm)

Features and Benefits

AV In-Wall Enclosure

2 and 4-Gang Flat Panel Television (FPTV) connection enclosure delivers high-density connectivity and power in the wall. This allows flat panel displays and interactive “smart” boards to sit flush against walls with no dangling cords. It quickly installs to studs or sheetrock without additional components or hardware.

- Optional screw on cover reduces tampering
- cULus 1863 Listed



Box Design

- Flush against walls installation
- Sheet metal base white powder coat finish
- Accepts standard electrical boxes
- Integrated cable management



Mounting

- Multiple device mounting options
- 1½ and 1¼ inch conduit knockouts
- Easily mounts to studs or sheetrock
- Easily replaceable receptacle
- Trim ring covers rough in



NSAV62M



NSAV124M

FPTV Connection Enclosure

Description	Color	Catalog Number
2-Gang In-Wall enclosure.	White	NSAV62M
Steel cover for NSAV6 series.	White	NSAV6C
4-Gang In-Wall enclosure.	White	NSAV124M
Steel cover for NSAV12 series.	White	NSAV12C

Note: UL File Number E129878.

Power Kits

Description	Color	Catalog Number
Standard power kit.	White	NSOKPTR
Surge protected power kit.	White	NSOKPS

AV Connectors and Plates

Description	Color	Catalog Number
1-Gang blank plate.	White	P14W
1-Gang decorator plate.	White	P26W



NSAV6C



NS801W

NSOKPS



SFHC14W



NSJ6W

Dimensions in Inches (mm)

4¹/₁₆" Square boxes

Featuring STAB-IT[®] connectors

Integrated into the box, our exclusive connectors are field proven to terminate MC cable up to 3 times faster than traditional cable clamps. It's easy: remove the pry-out, prep the cable, insert cable, done!

These welded large boxes provide more room for wiring and include connectors for three or six cables, plus a knockout on the same side as the connectors. Available mounting brackets and cable management offer the first means of support.

- 3-cable STAB-IT connectors install 3 times faster than traditional connectors
- Designed for quick installation of flex, MC, MCI, MCI-A, MC-PCS, AC, and HCF Cable
- HBL252MSCM & HBL252MS include far-side support on back
- Includes ground wires, box mounting brackets and cable clamps
- Easier installation for labor savings



Boxes

Boxes are 4¹/₁₆" square, 2¹/₁₆" deep. They are constructed with welded steel and have raised grounds. The boxes have 42 in.³ capacity.

Box Description	Side Knock Outs		Back Knock Outs		
	TKO	Cable Pry-outs	Concentric	TKO	Catalog Number
Standard	(12) 1/2"-3/4"		(1) 1/2"	(3) 1/2"-3/4"	HBL257*
(1) STAB-IT Connector and 8" Solid #12 Ground Pigtail	(10) 1/2"-3/4"	3	(1) 1/2"	(1) 1/2"-3/4"	HBL252S
(1) STAB-IT Connector, 8" Solid #12 Ground Pigtail and (1) Cable Management Clamp	(10) 1/2"-3/4"	3	(1) 1/2"	(1) 1/2"-3/4"	HBL252SCM
(1) STAB-IT Connector, 8" Solid #12 Ground Pigtail and (1) Mounting Bracket	(10) 1/2"-3/4"	3	(1) 1/2"	(1) 1/2"-3/4"	HBL252MS
(1) STAB-IT Connector, 8" Solid #12 Ground Pigtail, (2) Mounting Brackets and (1) Cable Management Clamp	(10) 1/2"-3/4" (1) 3/4"-1"	3	(1) 1/2"	(1) 1/2"-3/4"	HBL252MSCM
(2) STAB-IT Connectors and 8" Solid #12 Ground Pigtail	(8) 1/2"-3/4"	6	(1) 1/2"		HBL254S
(2) STAB-IT Connectors, 8" Solid #12 Ground Pigtail, and (2) Cable Management Clamps	(8) 1/2"-3/4"	6	(1) 1/2"		HBL254SCM

*UL Listed Only



Dimensions in Inches (mm)

4" Square boxes

Regular or STAB-IT[®] boxes

These popular boxes are available with our unique connectors built into the box. Terminate MC cable in one third the time of other clamps. Models are available with connectors for two or four cables. Available mounting brackets and cable management offer the first means of support.

- 2-cable STAB-IT connectors install 3 times faster than traditional connectors
- Designed for quick installation of flex, MC, MCI, MCI-A, MC-PCS, AC, and HCF Cable
- HBL232MSCM & HBL232MS includes far-side support on back
- Includes ground wires, box mounting brackets and cable clamps
- Easier installation for labor savings



Boxes

Boxes are 4" square, 2-1/8" deep. They are constructed with welded steel and have raised grounds. The boxes have 30.3 in.³ capacity.

Box Description	Side Knock Outs			Back Knock Outs		
	Concentric	TKO	Cable Pry-outs	Concentric	TKO	Catalog Number
Standard	(8) 1/2"	(4) 1/2"-3/4"		(2) 1/2"	(2) 1/2"-3/4"	HBL232
10" Solid #12 Ground Pigtail	(8) 1/2"	(4) 1/2"-3/4"		(2) 1/2"	(2) 1/2"-3/4"	HBL232SM
(1) STAB-IT Connector, 8" Solid #12 Ground Pigtail	(6) 1/2"	(3) 1/2"-3/4"	2	(1) 1/2"	(1) 1/2"-3/4"	HBL232S
(1) STAB-IT Connector, 8" Solid #12 Ground Pigtail, Back- Far Side Support, and (2) Mounting Brackets	(6) 1/2"	(3) 1/2"-3/4"	2	(1) 1/2"	(1) 1/2"-3/4"	HBL232MS
(1) STAB-IT Connector, 8" Solid #12 Ground Pigtail, and (1) Cable Management Clamp	(6) 1/2"	(3) 1/2"-3/4"	2	(1) 1/2"	(1) 1/2"-3/4"	HBL232SCM
(1) STAB-IT Connector, 8" Solid #12 Ground Pigtail, Back- Far Side Support, (1) Cable Management Clamp, and (2) Mounting Brackets	(6) 1/2"	(3) 1/2"-3/4"	2	(1) 1/2"	(1) 1/2"-3/4"	HBL232MSCM
(2) STAB-IT Connectors, 8" Solid #12 Ground Pigtail, Back- Far Side Support, (2) Cable Management Clamp, and (2) Mounting Brackets	(6) 1/2"	(3) 1/2"-3/4"	4	(1) 1/2"	(1) 1/2"-3/4"	HBL244MSCM
(2) STAB-IT Connectors, 8" Solid #12 Ground Pigtail	(4) 1/2"	(2) 1/2"-3/4"	4	(1) 1/2"		HBL248S



Boxes

Boxes are 4" square, 1 1/2" deep, and have 21 in.³ capacity. Use with standard cable connectors.

Box Description	Side Knock Outs		Back Knock Outs		
	Concentric	TKO	Concentric	TKO	Catalog Number
Welded Steel, Raised Ground, 8" Solid #12 Ground Pigtail	(8) 1/2"	(4) 1/2"-3/4"	(2) 1/2"	(2) 1/2"-3/4"	HBL189F
Welded Steel, Raised Ground, 10" Solid #12 Ground Pigtail	(8) 1/2"	(4) 1/2"-3/4"	(2) 1/2"	(2) 1/2"-3/4"	HBL189SM*
Welded Steel, Long Side Mounting Brackets	(8) 1/2"	(4) 1/2"-3/4"	(3) 1/2"	(2) 1/2"-3/4"	HBL196
Welded Steel, Raised Ground, 10" Solid #12 Ground Pigtail	(8) 1/2", (4) 3/4"		(2) 1/2", (2) 3/4"		HBL232SCM

*cULus

Dimensions in Inches (mm)

Power and AV Boxes

4" & 4 1/16" Square boxes

Mud rings, covers, supports

Steel adjustable mud rings provide flexibility after installation to match the drywall depth. Hinged mud rings allow devices to be installed during pre-assembly, then swing out of the way for final wiring on site. Protector plates can be attached during prefab to protect devices during drywall install, then removed during trim out.

- 1 & 2-Gang adjustable mud rings
- Standard 1 & 2-gang mud rings
- Adjustable open box mounting brackets
- Floor mounted box support includes fold back stabilizer prevents bracket from being pushed back in wall cavity during drywall installation

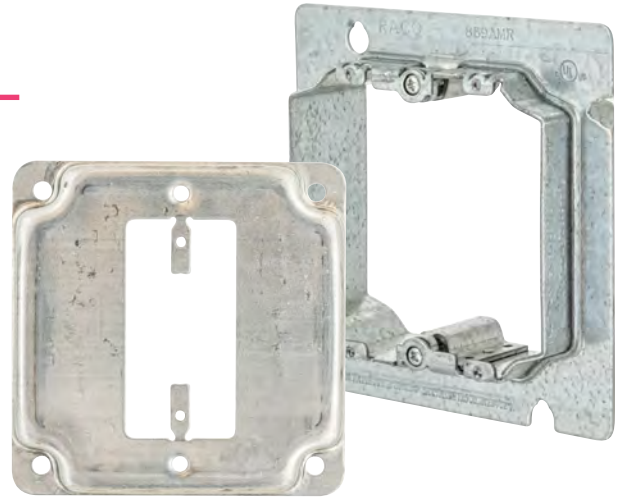

Mud Rings

For use with	Type	Raised Height	Capacity (In. ³)	Listing	Catalog Number	
4 1/16" boxes	1-Gang, Adjustable	1/2" to 1 3/8"	4 to 9.5	UL Listed	HBL868AMR HBL869AMR	
	2-Gang, Adjustable		8 to 15.5			
	1-Gang	2-Gang	5/8"	4.5	cULus	HBL843 HBL842 HBL841 HBL818 HBL840 HBL819 HBL820
			1 1/4"	9.5		
			1/2"	5.5		
			5/8"	7.3		
4" boxes	1-Gang, Adjustable	1/2" to 1 3/8"	4 to 9.5	UL Listed	HBL768AMR HBL769AMR	
	2-Gang, Adjustable		8 to 15.5			
	1-Gang	5/8"	4.5	UL Listed	HBL768	
	1-Gang, Stud Mount	5/8"	4.5	UL Listed	HBL768B	
	1-Gang, Hinged	5/8"	5.5	UL Listed	HBL768H	
	1-Gang	1 1/4"	9.5	cULus	HBL775	
	2-Gang	5/8"	7.3	cULus	HBL769	
	2-Gang, Stud Mount	5/8"	7.3	UL Listed	HBL769B	
	2-Gang, Hinged	5/8"	8.3	UL Listed	HBL769H	
	2-Gang	1 1/4"	15	cULus	HBL781	

Square Metallic Covers for Exposed Work

For use with	1 Decorator	1 Duplex	2 Decorator	2 Duplex	1 Duplex, 1 Decorator
4" boxes, UL Listed	HBL808C	HBL902C	HBL809C	HBL907C	HBL915C

Metallic Box Brackets and Supports

For use with	Type	Box Mounting	Catalog Number
4 1/16" and 4" boxes, cULus	Open Wall Adjustable Box Bracket	16" to 24"	HBL9020R
	Floor Mounted Box Support	12" 18"	HBL9009 HBL9010

Plates

Description	For use with	Height	1-Gang	2-Gang
Reuseable metallic mud ring cable protector plate	4 1/16" and 4" boxes	Flush 3/4"	HBL701F HBL701R	HBL702F HBL702R
Metallic flush-fit devices levelling plate	4 1/16" and 4" boxes	-	HBL999	—

Dimensions in Inches (mm)

Grand Slam Junction boxes

Large capacity home run boxes

Terminate home runs in commercial applications with the Grand Slam box. It offers both flexibility and space. Features built-in STAB-iT® connectors for jobsite labor savings as well as included ground bar.

- With STAB-iT® clamps, has been tested at over 3X faster than traditional connectors
- Surface mount cover and ground bar included
- Two raised grounds for installation flexibility
- Available with concentric knockouts on side and back UL Listed



Grand Slam Junction Boxes

Box, surface covers and ground bar included.

Dimensions	Concentric Knock Outs	STAB-iT Clamps	Capacity (In. ³)	Catalog Number
8" X 8" X 3"	(12) 1/2" & 3/4" (5) 3/4" & 1"	(4) 14/2 to 10/3 Up to 8 Cables	179	HBLSC080803STRC
8" X 8" X 3"	NA	(4) 14/2 to 10/3 Up to 8 Cables	179	HBLSC080803NKSTRC
12" X 12" X 4"	(12) 1/2" & 3/4" (9) 3/4" & 1" (8) 1" & 1 1/4"	(6) 14/2 to 10/3 Up to 12 Cables	546	HBLSC121204STRC
12" X 12" X 4"	NA	(6) 14/2 to 10/3 Up to 12 Cables	546	HBLSC121204NKSTRC



Grand Slam Junction Box Accessories

Description	For Use With	Dimensions	Catalog Number
Flush Style Cover	8" X 8" Boxes 12" X 12" Boxes	10" x 10" 14" x 14"	HBLSCF0808RC HBLSCF1212RC
STAB-iT® Connector (accepts 2 cables)	All Grand Slam boxes	1.032" x 1.75" x 0.983"	HBL989ST

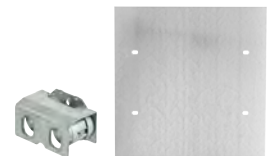

Dimensions in Inches (mm)

Av Wall Boxes

Gangable boxes

Deliver data, AV, and power side-by-side with these oversized in-wall boxes. Designed to install independently or ganged together for multiple devices. Perfect for Cat6 and 6A fiber optic cables that require a larger bend radius.

- 4" depth accepts any device
- Knockouts from 1/2" up to 2"
- Accepts low voltage partition
- NEMA spaced device mounting, accepts industry standard wallplates
- Adjustable stud mounting brackets and far side support
- Suitable for masonry application

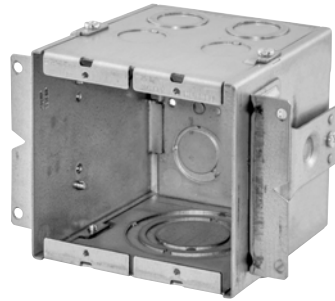

Gangable AV Wall Boxes

Box Description	Knockouts			Catalog Number
	Top	Bottom	Back	
2-Gang, 2 in. KO, 54 in ³ capacity, 4.21" X 4.06" X 4"	(2) 1/2" (2) 1/2" - 3/4" TKO	(1) 1", 1 1/4", 1 1/2", 2"	(2) 1/2"-3/4"	HBL985
3-Gang, 2 in. KO, 79 in ³ capacity, 4.21" X 5.87" X 4"	(3) 1/2" (3) 1/2" - 3/4" TKO	(1) 1/2" (1) 1/2" - 3/4" TKO (1) 1", 1 1/4", 1 1/2", 2"	(3) 1/2"-3/4"	HBL986
4-Gang, 2 in. KO, 104 in ³ capacity, 4.21" X 7.69" X 4"	(4) 1/2" (4) 1/2" - 3/4" TKO	(1) 1/2" (1) 1/2" - 3/4" TKO (2) 1", 1 1/4", 1 1/2", 2"	(4) 1/2"-3/4"	HBL987
6-Gang, 2 in. KO, 154 in ³ capacity, 4.21" X 11.31" X 4"	(6) 1/2" (6) 1/2" - 3/4" TKO	(1) 1/2" (1) 1/2" - 3/4" TKO (2) 1", 1 1/4", 1 1/2", 2"	(6) 1/2"-3/4"	HBL988



Low Voltage AV Wallbox Partition

For use with	Type	Catalog Number
HBL985, HBL986, HBL987 and HBL988	Solid divider With pass-thru capability	HBL989 HBL989AVD

Dimensions in Inches (mm)

Large capacity Wall Boxes

One, two or three gang boxes

Oversized two or three gang boxes and mud rings are perfect for AV, data and power applications. Extra-large knockouts for pulling pre-terminated cables.

- Designed to deliver power and low voltage in the same box
- Use standard mud rings and wallplates
- Two inch knockout feed-thru
- 3 1/4 Inch depth accommodates large cables and bend radii



2-Gang Large Capacity Wall Boxes

Boxes are 4 1/16" square, 3/4" deep. The boxes have 66.7 in.³ capacity. Use with industry standard 4 1/16" square mud rings for 1- or 2-gang applications

Box Description	Side Knock Outs		Back Knock Outs	Catalog Number
	Concentric	TKO	TKO	
Standard	(2) 1"-2"	(2) 3/4"-1" (2) 1"-1 1/4"	(2) 3/4"-1" (2) 1 1/2"	HBL260
With mounting brackets	(2) 1"-2"	(2) 3/4"-1" (2) 1"-1 1/4"	(2) 3/4"-1" (2) 1 1/2"	HBL260H



3-Gang Large Capacity Wall Box

Boxes are 4 1/16"H, 7 3/4"W, 3/4" deep. The boxes have 113.3 in.³ capacity. Use with industry standard 4" square mud rings for 1- or 2-gang applications

Box Description	Side Knock Outs		Back Knock Outs	Catalog Number
	Concentric	TKO	TKO	
Square 2- or 3-gang wall box	(2) 1"-2"	(4) 1/2"-3/4" (4) 3/4"-1" (2) 1"-1 1/4"	(2) 1/2"-3/4" (2) 3/4"-1" (2) 1"-1 1/4"	HBL263



Mud Rings

Description	For use with	Height	Capacity (In. ³)	Catalog Number
2-gang mud rings	HBL260	5/8"	7.3	HBL818
		3/4"	8.8	HBL840
		1"	12.0	HBL819
		1 1/4"	15.0	HBL820
3-gang mud rings	HBL263	1/2"	10.1	HBL792
		5/8"	12.3	HBL793
		1 1/4"	24.3	HBL794



Low Voltage Partition

For use with	Mud Ring Depth	Type	Catalog Number
HBL260 and HBL263	1/2", 3/4" and 1 1/4"	Solid divider With pass-thru capability	HBL981 HBL981AVD



Dimensions in Inches (mm)

SNAPConnect® Devices & Accessories

Modular wiring system

Our labor-saving receptacles and switches save up to 5 minutes per device. Perfect for prefab applications. The SNAPConnect terminal can be part of the pre-assembly. The device can be snapped in during pre-assembly or during trim out. Secure and fast, these products eliminate exposed live terminals.

- Modular wiring system eliminates screw terminals and NEC® torque requirements, speeding installation and trim-out
- Clear polycarbonate terminal connector housing to inspect contacts
- Receptacles available in standard, tamper-resistant and power indicating LED versions
- Abuse resistant nylon for extra heavy use applications
- Stainless steel autoground
- Simplifies device change out for end users



SNAPConnect® Right Angle Pigtailed Connectors for Receptacles

Description	Solid	Stranded
6 inch wire connector	SNAP1RNA	SNAP2RNA
6 inch wire with push-wire terminals	SNAP1RNAM2	SNAP2RNAM2

Hospital Grade SNAPConnect® Extra Heavy Duty Duplex Receptacles

Description	Style	Color	15A 125V	20A 125V
Standard	Duplex StyleLine Decorator	White	SNAP8200WNA SNAP2172WNA	SNAP8300WNA SNAP2182WNA
Standard with Finder Groove	Duplex	White	SNAP8200WA	SNAP8300WA
Tamper-Resistant	Duplex StyleLine Decorator	White	SNAP8200WTRA SNAP2172WTRA	SNAP8300WTRA SNAP2182WTRA
Tamper-Resistant with Split Circuit	Duplex StyleLine Decorator	White	SNAP8200WSCTRA SNAP2172WSCTRA	SNAP8300WSCTRA SNAP2182WSCTRA
Standard with Power Indicating (LED)	Duplex StyleLine Decorator	White	SNAP8200WL SNAP2172WL	SNAP8300WL SNAP2182WL
Tamper-Resistant with Power Indicating (LED)	Duplex StyleLine Decorator	White	SNAP8200WLTRA SNAP2172WLTRA	SNAP8300WLTRA SNAP2182WLTRA

Specification Grade SNAPConnect® Extra Heavy Duty Duplex Receptacles

Description	Style	Color	15A 125V	20A 125V
Standard	Duplex StyleLine Decorator	White	SNAP5262WNA SNAP2152WNA	SNAP5362WNA SNAP2162WNA
Standard with Finder Groove	Duplex	White	SNAP5262WA	SNAP5362WA
Tamper-Resistant	Duplex StyleLine Decorator	White	SNAP5262WTRA SNAP2152WTRA	SNAP5362WTRA SNAP2162WTRA
Tamper-Resistant with Split Circuit	Duplex StyleLine Decorator	White	SNAP5262WSCTRA SNAP2152WSCTRA	SNAP5362WSCTRA SNAP2162WSCTRA
Standard with Power Indicating (LED)	Duplex StyleLine Decorator	White	SNAP5262WL SNAP2152WL	SNAP5362WL SNAP2162WL
Tamper-Resistant with Power Indicating (LED)	Duplex StyleLine Decorator	White	SNAP5262WLTRA SNAP2152WLTRA	SNAP5362WLTRA SNAP2162WLTRA

Dimensions in Inches (mm)



SNAPConnect® Permanently Marked Controlled Duplex Receptacles

Description	Color	Standard		Tamper-Resistant	
		15A 125V	20A 125V	15A 125V	20A 125V
Duplex One Face Controlled Split Circuit Snap	White	SNAP5262C1W	SNAP5362C1W	SNAP5262C1WTRA	SNAP5362C1WTRA
Duplex Both faces Controlled	White	SNAP5262C2W	SNAP5362C2W	SNAP5262C2WTRA	SNAP5362C2WTRA
StyleLine Decorator One Face Controlled Split Circuit	White	SNAP2152C1W	SNAP2162C1W	SNAP2152C1WTRA	SNAP2162C1WTRA
StyleLine Decorator Both faces Controlled	White	SNAP2152C2W	SNAP2162C2W	SNAP2152C2WTRA	SNAP2162C2WTRA



SNAPConnect® Protection Receptacles

Description	Color	Hospital Grade		Specification Grade	
		15A 125V	20A 125V	15A 125V	20A 125V
Heavy Duty Commercial Ground Fault	White	SNAPGF82W	SNAPGF83W	GFRST15SNAPW	GFRST20SNAPW
Heavy Duty Commercial Ground Fault Tamper-Resistant Weather-Resistant	White	SNAPGFTW82W	SNAPGFTW83W	GFTWRST15SNAPW	GFTWRST20SNAPW
Surge Protection Tamper resistant with Power Indicating (LED)	White	SNAP8262WS	SNAP8362WS	SNAP5262WA	SNAP5362WS
USB Charger Duplex, one USB Type A and one Type-C port, 3 Amp up to 9 Volt USB output	White	SNAP8200UACW	SNAP8300UACW	SNAP15UACW	SNAP20UACW



SNAPConnect® Right Angle Pigtailed Connectors for Switches

Description	Solid		Stranded	
	15A 125V	20A 125V	15A 125V	20A 125V
6 inch wire connector for use with	single pole	SNAPSP1NA	SNAPSP2NA	
	single pole, with push-in terminals	SNAPSP1NAM2	SNAPSP2NAM2	
	single pole pilot light	SNAPSP1NA	SNAPSP2NA	
	single pole pilot light, with push-wire terminals	SNAPSP1NAM2	SNAPSP2NAM2	
	3-way pilot light	SNAP3W1NA	SNAP3W2NA	
	3-way pilot light, with push-wire terminals	SNAP3W1NAM2	SNAP3W2NAM2	



SNAPConnect® White Specification Grade Switches

Description	Style	15A, 120-277V AC		20A, 120-277V AC	
		Single Pole	Three Way	Single Pole	Three Way
Standard	Toggle Decorator	SNAP1201WNA SNAP2101WNA	SNAP1203WNA SNAP2103WNA	SNAP1221WNA SNAP2121WNA	SNAP1223WNA SNAP2123WNA
Illuminated blue LED, light ON with load OFF	Toggle Decorator	SNAP1201LWNA SNAP2101LWNA	SNAP1203LWNA SNAP2103LWNA	SNAP1221LWNA SNAP2121LWNA	SNAP1223LWNA SNAP2123LWNA
Pilot red LED, light ON with load OFF	Toggle Decorator	SNAP1201PLWNA SNAP2101PLWNA	—	SNAP1221PLWNA SNAP2121PLWNA	—



SNAPConnect® Testers

Description	Catalog Number
Circuit Tester for SNAPConnect® receptacle terminals, GFCI and standard receptacles	SNAPCTG
Switch jumper/tester, single pole, illuminated	SANPSWJUMP
Switch jumper/tester, 3-way, illuminated	SNAP3WJUMP



Polycarbonate Wallplates

Description	Standard		Mid-Size	
	1-Gang	2-Gang	1-Gang	2-Gang
StyleLine Decorator, white	P26W	P262W	PJ26W	PJ262W
Duplex, white	P8W	P82W	PJ8W	PJ82W
Toggle, white	P1W	P2W	PJ1W	PJ2W
Combination 1-Toggle and 1-Duplex, white	-	P18W	-	PJ18W
Combination 1-Duplex and 1-StyleLine Decorator, white	-	P826W	-	PJ826W
Combination 1-Toggle and 1-StyleLine Decorator, white	-	P126W	-	PJ126W



Dimensions in Inches (mm)

Dimensions in Inches (mm)

SECTION Y

Table of Contents



Jacks and Connectors



AV In-Wall Enclosure and HDMI Products



Modular Snap Fit Jacks and Molded-In Voice/Data/Video



Product	Page
Products at a Glance	Y-2
Modular Jacks	Y-4
Digital AV Connections	Y-5
Video Connections	Y-6
AV Connectors	Y-7
Audio Connectors	Y-8
Hubbell iSTATION Wallplates	Y-9
Hubbell iSTATION Outlet Frames and Secure-IT Plates	Y-10
AV 110 Everywhere™ Analog AV Over UTP	Y-11
AV Modules	Y-12
Wallplate Frames, Delivery Bezels, Modules and Gangable AV Wallboxes	Y-13
Modules and Frames	Y-14

Product	Page
Hubbell iSTATION Surface Mount Boxes	Y-15
Universal Patch Panels and Wall Mount Brackets	Y-16
NSC Patch Cords	Y-17
In-Wall AV Delivery	Y-18
HDMI Products	Y-19
Advantages and Wiring Layout	Y-20
Network Enclosures	Y-21
Network Modules	Y-22
Audio/Video Modules	Y-23
Accessories	Y-24
Molded-In Voice/Data/Video	Y-25
Molded-In Plates	Y-26
Telephone Wall Jacks	Y-27
Standard UTP Wiring Conventions	Y-28

Network Wiring and netSELECT® Products

Products at a Glance



Jacks and Connectors

- NEXTSPEED® Category 6 system is designed to deliver headroom beyond 500 MHz
- Category 5e supports 10/100/1000BASE-T applications with usable bandwidth of 190 MHz in the channel
- F-Type connectors distribute high quality video signal to the workstation
- RCA connectors distribute component and composite audio and video signals from device to device



Modular Snap Fit Jacks

- Customize the jack selections and look
- Quick and secure snap-in design
- Hi impact-resistant thermoplastic frame
- Audio/Video connectors are available in standard bulkhead or recessed



In-Wall AV Delivery and HDMI Products

- 18 Gauge white powder coated rugged steel base
- 2-Gang enclosure with two 1½ and 1¼ inch KOs
- Stud or sheetrock mounting integrated
- Supplied ABS trim ring quickly cleans up sheetrock rough-in
- Optional screw on cover reduces tampering
- cULus 1863 Listed



Patch Panels and Wall Mount Brackets

- Zero-crosstalk contact structure provides the highest performance while maintaining true balance
- Rear cable manager bars maintain termination integrity
- Integrated port and panel labeling, as well as port icon attachment
- Labeling, termination and aesthetics shared across all performance categories, sizes and configurations

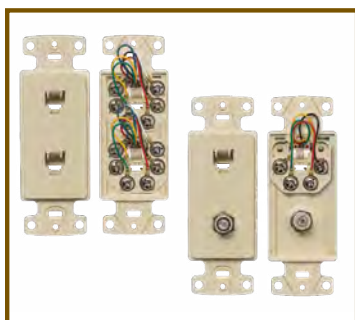

Molded-In Voice/Data/Video

- Decorator frames provide a stylized look for that finishing touch
- Elongated strap for better wall box mounting
- High impact-resistant thermoplastic frame
- UL Listed 1863 - Communication Circuit Accessory and CSA Certified



Network Enclosures

- Flush or surface mount enclosure (hardware provided)
- Hinged cover can be mounted to swing from either side
- Integral trim ring hides rough-in hole in sheet rock providing a finished appearance
- Horizontal and vertical module mounting holes for maximum flexibility



Network and Audio/Video Modules

- netSELECT® modular components enable the designer to select performance requirements specifically for the application
- Modules snap horizontally or vertically into the enclosures for maximum flexibility and optimum space usage
- netSELECT® video modules support bidirectional signal by splitting to 4, 6, or 8 separate work areas

Features and Benefits

Hubbell Xcelerator Jacks, Category 6, 5e and USOC

The NEXTSPEED® Category 6 system is designed to deliver headroom beyond 500 MHz for dependable Multi-gigabit Ethernet applications. NEXTSPEED's extended bandwidth provides reliability with zero bit error rate performance for today's high speed digital communications. The Category 5e supports 10/100/1000BASE-T applications with usable bandwidth of 190 MHz in the channel.

Hubbell's work area solutions and modular connectivity have many innovative features that integrate into a wide range of Hubbell products—floor boxes, patch panels, conference table boxes, fire-rated poke-throughs and wallplates.

- TIA-568.2-D Category 6 component
- IEC 60603-7-4 Category 6 component
- Qualified to 150% of IEEE 802.3bt current level
- IEEE 802.3an 10GBASE-T

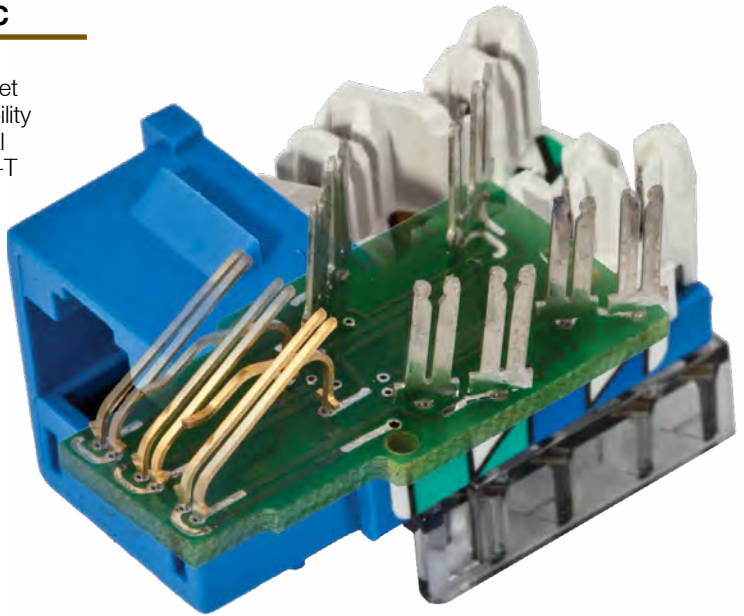

Housing Design

- One-piece, engineered thermoplastic housing is impact-resistant for heavy-duty industrial environments
- Blades are recessed for protection against bending and breaking
- Closure cap is included for environmental seal when device is not in use

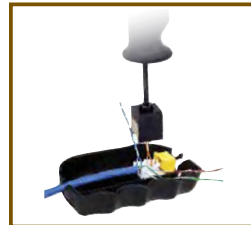

Labor Savings

- Exclusive 1-Punch Tool, terminates within seconds



Universal Wiring

- Two distinct labels eliminate wiring confusion, T568B or T568A



IDC Lacing

- IDC towers have a blade feature to assist pair splitting during termination



Specifications

- Mating cycles: 2500
- Manufacturing: 100% factory tested

Enterprise Grade Jacks



NEXTSPEED® Category 6 Jacks

Color	Single Pack	25-Pack
Black	HXJ6BK	HXJ6BK25
Blue	HXJ6B	HXJ6B25
Electric Ivory	HXJ6EI	HXJ6EI25
Gold	–	HXJ6GL25
Gray	HXJ6GY	HXJ6GY25
Green	HXJ6GN	HXJ6GN25
Office White	HXJ6OW	HXJ6OW25
Orange	HXJ6OR	HXJ6OR25
Purple	–	HXJ6P25
Red	HXJ6R	HXJ6R25
White	HXJ6W	HXJ6W25
Yellow	HXJ6Y	HXJ6Y25

NEXTSPEED® Category 5e Jacks

Color	Single Pack	25-Pack
Black	HXJ5EBK	HXJ5EBK25
Blue	HXJ5EB	HXJ5EB25
Electric Ivory	HXJ5EEI	HXJ5EEI25
Gold	–	HXJ5EGL25
Gray	HXJ5EGY	HXJ5EGY25
Green	HXJ5EGN	HXJ5EGN25
Office White	HXJ5EOW	HXJ5EOW25
Orange	HXJ5EOR	HXJ5EOR25
Purple	–	HXJ5EP25
Red	HXJ5ER	HXJ5ER25
White	HXJ5EW	HXJ5EW25
Yellow	HXJ5EY	HXJ5EY25

USOC Jacks, RJ-25

Color	Single Pack
Black	HXJUBK
Blue	HXJUB
Electric Ivory	HXJUEI
Gold	–
Gray	HXJUGY
Green	HXJUGN
Office White	HXJUOW
Orange	HXJUOR
Purple	–
Red	HXJUR
White	HXJUW
Yellow	HXJUW

Note: Also available in 100 packs.



netSELECT® Jacks

Color	Category 6 Jack		Category 5e Jack		USOC Jack (single)
	(single)	(25 pack)	(single)	(25 pack)	
Black	NSJ6BK	NSJ6BK25	NSJ5EBK	NSJ5EBK25	NSJUBK
Blue	NSJ6B	NSJ6B25	NSJ5EB	NSJ5EB25	NSJUB
Gray	NSJ6GY	NSJ6GY25	NSJ5EGY	NSJ5EGY25	NSJUGY
Green	NSJ6GN	NSJ6GN25	NSJ5EGN	NSJ5EGN25	NSJUGN
Ivory	NSJ6I	NSJ6I25	NSJ5EI	NSJ5EI25	NSJUI
Light Almond	NSJ6LA	NSJ6LA25	NSJ5ELA	NSJ5ELA25	NSJULA
Orange	NSJ6OR	NSJ6OR25	NSJ5EOR	NSJ5EOR25	NSJUOR
Red	NSJ6R	NSJ6R25	NSJ5ER	NSJ5ER25	NSJUR
White	NSJ6W	NSJ6W25	NSJ5EW	NSJ5EW25	NSJUW
Yellow	NSJ6Y	NSJ6Y25	NSJ5EY	NSJ5EY25	NSJUW



Jack Icons, XJ Series

100-Pack, snaps onto jack nose



Color	Blank Catalog Number	Computer Catalog Number	Telephone Catalog Number
Black	IBK100	IBK100C	IBK100T
Blue	IB100	IB100C	IB100T
Brown	IBN100	IBN100C	IBN100T
Electric Ivory	IEI100	IEI100C	IEI100T
Gray	IGY100	IGY100C	IGY100T
Green	IGN100	IGN100C	IGN100T
Orange	IOR100	IOR100C	IOR100T
Purple	IP100	IP100C	IP100T
Red	IR100	IR100C	IR100T
White	IW100	IW100C	IW100T
Yellow	IY100	IY100C	IY100T

Note: Cannot be used with SJ jack series.

Custom Icon numbering and labeling available. Contact Customer Service for details.



SecureIT™ RJ-45 Port Blocker

Description	Catalog Number
Locking RJ-45 port blocker	RJ45PB50

Note: Fits any RJ-45 port.



Jack Dust Covers, XJ Series

Description	Catalog Number
Polypropylene, clear, 25-pack	HXJDC25

Note: Mounts within the icon slots located above the RJ45 opening. Cannot be used with SJ jack series.

Digital AV Connections



RJ-45 Couplers

Female to female couplers

Housing Color	Category 6, Pass-Thru	Category 5e, Pass-Thru	Category 5e, Cross Over 10/100BASE-T	Category 6, Shielded Pass-Thru
Black	SFC6BK	SFC5EBK	–	Lead free tinned shield
Gray	–	–	SF5ECOY	SFSC6
White	SFC6W	SFC5EW	–	



USB Connectors

Pass-thru, female to female couplers

Housing Color	USB 3.0, A to A	USB 3.0, A to B	USB 2.0, A to A	USB 2.0, A to B
Black	SFUSBA3BK	SFUSBAB3BK	–	–
Blue	–	–	SFUSBAAB	SFUSBABB
Office White	–	–	SFUSBAAOW	SFUSBABOW
White	–	–	SFUSBAAW	SFUSBABW



HDMI Connectors for IMB and ISFB Series

Color	HDMI Feed-Thru	HDMI Feed-Thru Coupler	HDMI Feed-Thru 3-Inch Tail
Black	SFHC14BK	HDMIC14	HDMIT14
White	SFHC14W	–	–



HDMI Decorator Frames

Color	1-Port	2-Port
Black	NS801BK	NS802BK
Gray	NS801GY	NS802GY
Ivory	NS801I	NS802I
Light Almond	NS801LA	NS802LA
White	NS801W	NS802W



HDMI Non-Active Horizontal Patch Cords

Black, non-plenum, #24 AWG, HDMI 4K

Length (ft)	HDMI Device Patch Cords
3	HDPC03BK
6	HDPC06BK



Length (ft)	In-Wall Cords (Male w/ Screw to Male w/ Screw)
10	HDH10BK
15	HDH15BK
20	HDH20BK
25	HDH25BK
30	HDH30BK

Video Connections



F-Type Connectors

Pass-thru, F/F coupler

Color	Nickel		Gold			
	2GHz	netSELECT F-Type Coupler Bulkhead, Female to Female	3GHz	2GHz	Recessed	RCA to F-Connector
Black	SFFBX	NSF70BK	SFF3GBK	SFFGBK	SFGRFBK	SFRFGBK
Gray	SFFGX	NSF70GY	SFF3GGY	SFFGGY	SFGRFGY	SFRFGGY
Ivory	SFFEX	NSF70I	SFF3GEI	SFFGEI	SFGRFEI	SFRFGEI
Office White	SFFX	NSF70LA	SFF3GOW	SFFGOW	SFGRFOW	SFRFGOW
White	SFFWX	NSF70W	SFF3GW	SFFGW	SFGRFW	SFRFGW

RCA Connectors, 110 Punch-Down

Extend up to 75ft (23m) over single 4-pair UTP cable; housing color is black

Insulator Color	Catalog Number
Blue	SFRC110B
Green	SFRC110GN
Red	SFRC110R
White	SFRC110W
Yellow	SFRC110Y



3.5mm to 110 Termination Stereo Jacks

Extend up to 75ft (23m) over single 4-pair UTP cable

Color	Catalog Number
3.5mm to 110 Termination, Black	SF35110BK



S-Video Connectors

Extend up to 75ft (23m) over single 4-pair UPT cable

Color	Catalog Number
S-Video 110 Punch-Down Black	SFSV110BK



F-Connector Plugs

Termination Type	Cable Type	Catalog Number
Compression	RG6	FRG625



Screw Terminal

Description	Catalog Number
HD 15-Pin, 10-Pack	15ST10
HD 15-Pin, Front Mount	SF15ST



Gender Changers

Female to female couplers

Description	Catalog Number
HD 15-Pin, 10-Pack	15GC10



Blank Connectors

Color	10-pack	
	Blank Connector	Smooth Blank Connector
Black	SFBB10	SFSBBK10
Gray	SFBG10	SFSBGY10
Ivory	SFBE10	SFSBEI10
Light Almond	–	SFSBLA10
Office White	SFB10	–
White	SFBW10	SFSBW10



AV Connections



RCA Connectors, Solder Termination

Housing Color	Insulator Color						
	Black	Blue	Green	Orange	Red	White	Yellow
Black	SFRCBKBK	SFRCCBBK	SFRCCGNBK	SFRCCORBK	SFRCCRBK	SFRCCWBK	SFRCCYBK
Gray	SFRCCBKGY	SFRCCBGY	SFRCCNGY	SFRCCORGY	SFRCCRGY	SFRCCWGY	SFRCCYGY
Ivory	SFRCCBKEI	SFRCCBEI	SFRCCGNEI	SFRCCOREI	SFRCCREI	SFRCCWEI	SFRCCYEI
Office White	–	SFRCCBOW	SFRCCGNOW	SFRCCOROW	SFRCCR	SFRCCW	SFRCCY
White	SFRCCBKW	SFRCCBW	SFRCCGNW	SFRCCORW	SFRCCRW	SFRCCWW	SFRCCYW



RCA Connectors, Pass-Thru, Recessed

Housing Color	Insulator Color						
	Black	Blue	Green	Orange	Red	White	Yellow
Black	SFRCCBKR BK	SFRCCBR BK	SFRCCGNR BK	SFRCCORR BK	SFRCCRR BK	SFRCCWR BK	SFRCCYR BK
Gray	SFRCCBKRGY	SFRCCBRGY	SFRCCGNRGY	SFRCCORRGY	SFRCCRRGY	SFRCCWRGY	SFRCCYRGY
Ivory	SFRCCBKREI	SFRCCBREI	SFRCCGNREI	SFRCCORREI	SFRCCRREI	SFRCCWREI	SFRCCYREI
Office White	SFRCCBKROW	SFRCCBROW	SFRCCGNROW	SFRCCORROW	SFRCCRRROW	SFRCCWROW	SFRCCYROW
White	SFRCCBKRW	SFRCCBRW	SFRCCGNRW	SFRCCORRW	SFRCCRRW	SFRCCWRW	SFRCCYRW



RCA Connectors, Pass-Thru, Gold, Female to Female Coupler

Housing Color	Insulator Color						
	Black	Blue	Green	Orange	Red	White	Yellow
Black	SFRCCBKFFBK	SFRCCBFFBK	SFRCCGNFFBK	SFRCCORFFBK	SFRCCRFFBK	SFRCCWFFBK	SFRCCYFFBK
Gray	SFRCCBKFFGY	SFRCCBFFGY	SFRCCGNFFGY	SFRCCORFFGY	SFRCCRFFGY	SFRCCWFFGY	SFRCCYFFGY
Ivory	SFRCCBKFFEI	SFRCCBFFEI	SFRCCGNFFEI	SFRCCORFFEI	SFRCCRFFEI	SFRCCWFFEI	SFRCCYFFEI
Office White	SFRCCBKFF	SFRCCBFFOW	SFRCCGNFFOW	SFRCCORFFOW	SFRCCRFF	SFRCCWFF	SFRCCYFF
White	SFRCCBKFFW	SFRCCBFFW	SFRCCGNFFW	SFRCCORFFW	SFRCCRFFW	SFRCCWFFW	SFRCCYFFW

Audio Connections



3.5mm Stereo Jacks

Color	3.5mm to Solder	3.5mm to Screw Terminal	3.5mm Pass-Thru, F/F Coupler	3.5mm Pass-Thru, Gold, F/F Coupler
Black	SF35SJBK	SF35STBK	SF35FFBK	SF35GFFBK
Gray	SF35SJGY	SF35STGY	SF35FFGY	SF35GFFGY
Ivory	SF35SJEI	SF35STEI	SF35FFEI	SF35GFFEI
Office White	SF35SJ	SF35STOW	SF35FFOW	SF35GFFOW
White	SF35SJW	SF35STW	SF35FFW	SF35GFFW



1/4" Stereo Jack

Solder	Catalog Number
Black	SF14SJBK
Gray	SF14SJGY
Ivory	SF14SJEI
Office White	SF14SJOW
White	SF14SJW



BNC Connectors

Color	Nickel Finish	Gold Finish
Black	SFBBK	SFBGBK
Gray	SFBGY	SFBGGY
Ivory	SFBEI	SFBGEI
Light Almond	SFBLA	SFBGLA
Office White	SFBOW	SFBGOW
White	SFBW	SFBGW

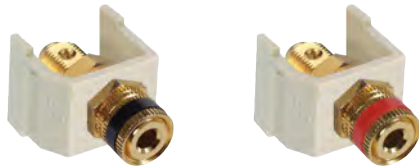

Speaker Post Connectors

Color	Black	Red
Black	SFSPGBKBK	SFSPGRBK
Gray	SFSPGBKGY	SFSPGRGY
Ivory	SFSPGBKEI	SFSPGREI
Office White	SFSPGBK	SFSPGR
White	SFSPGBKW	SFSPGRW



Speaker Banana Plugs

Color	Black	Red
10-pack	SPPBK10	SPPR10

Network Wiring and netSELECT® Products

Hubbell iSTATION Wallplates

IFP Wallplates with Label Fields, 1 and 2-Gang



Color	1-Gang					2-Gang		
	1-Port	2-Port	3-Port	4-Port	6-Port	6-Port	9-Port	12-Port
Black	IFP11BK	IFP12BK	IFP13BK	IFP14BK	IFP16BK	IFP26BK	IFP29BK	IFP212BK
Gray	IFP11GY	IFP12GY	IFP13GY	IFP14GY	IFP16GY	IFP26GY	IFP29GY	IFP212GY
Ivory	IFP11EI	IFP12EI	IFP13EI	IFP14EI	IFP16EI	IFP26EI	IFP29EI	IFP212EI
Light Almond*	IFP11LA	IFP12LA	IFP13LA	IFP14LA	IFP16LA	IFP26LA	IFP29LA	IFP212LA
Office White	IFP11OW	IFP12OW	IFP13OW	IFP14OW	IFP16OW	IFP26OW	IFP29OW	IFP212OW
White	IFP11W	IFP12W	IFP13W	IFP14W	IFP16W	IFP26W	IFP29W	IFP212W

Note: *Light Almond wallplates match Office White non-metallic raceway, boxes, jacks and connectors.

Multimedia Nylon Wallplates, 1-Gang



Color	1-Gang				
	1-Port	2-Port	3-Port	4-Port	6-Port
Black	NSP11BK	NSP12BK	NSP13BK	NSP14BK	NSP16BK
Gray	NSP11GY	NSP12GY	NSP13GY	NSP14GY	NSP16GY
Ivory	NSP11I	NSP12I	NSP13I	NSP14I	NSP16I
Light Almond	NSP11LA	NSP12LA	NSP13LA	NSP14LA	NSP16LA
White	NSP11W	NSP12W	NSP13W	NSP14W	NSP16W

Stainless Steel Wallplates without Label Fields, 1 and 2-Gang



Catalog Number	1-Gang					2-Gang			
	1-Port	2-Port	3-Port	4-Port	6-Port	4-Port	6-Port	9-Port	12-Port
	SSF11	SSF12	SSF13	SSF14	SSF16	SSF204	SSF206	SSF209	SSF212

Stainless Steel Wallplates with Label Fields



1-Gang	Catalog Number
1-Port	SSFL11
2-Port	SSFL12
3-Port	SSFL13
4-Port	SSFL14
6-Port	SSFL16

Duplex and Decorator Wallplates with Label Fields



Color	Duplex Wallplate	Decorator Wallplate
Office White	IFP18OW	IFP126OW

Stainless Steel Wall Mount Phone Plates, 1-Gang

630 Stainless steel, 1-gang wall phone plate.



SPUF SPUR

Jack Format	Includes Gray Jack	Catalog Number
Flush	6-position USOC, RJ25	SPUF
Flush	8-position Cat. 5e, RJ45	SP5EF
Flush	8-position Cat. 6, RJ45	SP6F
Recessed	6-position USOC, RJ25	SPUR
Recessed	8-position Cat. 5e, RJ45	SP5ER
Recessed	8-position Cat. 6, RJ45	SP6R

Opening

Hole size for mounting all Hubbell Jacks.

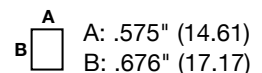

Network Wiring and netSELECT® Products

Hubbell iSTATION Outlet Frames and Secure-IT Plates

Decorator Frames, Unloaded

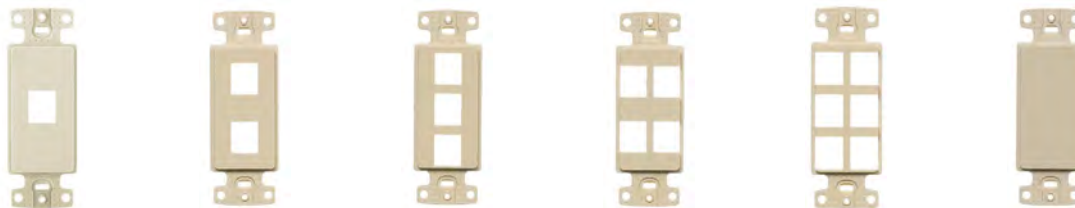

Color	1-Gang, 1-Port	1-Gang, 2-Port	1-Gang, 3-Port	1-Gang, 4-Port	1-Gang, 6-Port	1-Gang, Adapter Blank**
Black	NS611BK	NS612BK	NS613BK	NS614BK	NS616BK	NS620BK
Gray	NS611GY	NS612GY	NS613GY	NS614GY	NS616GY	NS620GY
Ivory	NS611I	NS612I	NS613I	NS614I	NS616I	NS620I
Light Almond	NS611LA	NS612LA	NS613LA	NS614LA	NS616LA	NS620LA
White	NS611W	NS612W	NS613W	NS614W	NS616W	NS620W

Note: *For use with rotary dimmers or to pull through AV or telephone cable.

**To fill an extra decorator opening or to create customized openings.

Decorator HD15/9-Pin or HDMI Frames, Unloaded



Color	HD15/9 or HDMI	(2) HD15/9 or HDMI	(1) Recessed HD15/9 or HDMI
Black	ISFB15BK	ISFB215BK	ISFBR15BK
Gray	ISFB15GY	ISFB215GY	ISFBR15GY
Ivory	ISFB15EI	ISFB215EI	ISFBR15EI
Office White	ISFB15OW	ISFB215OW	ISFBR15OW
White	ISFB15W	ISFB215W	ISFBR15W

Duplex Outlet Frames, Unloaded



Color	2-Port	4-Port
Black	BR106B	Q106B
Gray	BR106G	Q106G
Ivory	BR106E	Q106E
Office White	BR106C	Q106O
White	BR106W	Q106W

Secure-IT Plates



Secure-IT Plates protect mated and unmated connections from physical damage and unauthorized tampering. Available in Tamper-Resistant and Weatherproof versions.



TPF1W

Tamper-Resistant Plates

Color	1-Gang/4-Port
Black	TPF1BK
Gray	TPF1GY
Office White	TPF1OW
White	TPF1W



TWPF1GY

NEMA 3R Weatherproof Plates

Color	1-Gang/4-Port
Gray	TWPF1GY

Network Wiring and netSELECT® Products

AV 110 Everywhere™ Analog AV Over UTP

Tamper-Resistant Receptacle with 5V DC Power Output

Description	Color	Catalog Number
USB charger	Black	AVPS15BK
TR receptacle,	Ivory	AVPS15I
(1) USB port 3A,	Gray	AVPS15GY
switched 5V DC output,	Office White	AVPS15LA
15A, 125V AC	White	AVPS15W
decorator duplex		



USB 2.0 High Speed 110 Extenders, 100ft

Description	Color	1.5 Unit Module
4-pair UTP cable	Black	IMU11015BK
installation, up to	Ivory	IMU11015EI
100ft (305m)	Gray	IMU11015GY
	Office White	IMU11015OW
	White	IMU11015W

Note: Product consists of send and receive pair.



HDMI 1080P 110 UTP Extenders

(2) 4-pair UTP cable installation, 5V DC, up to 147ft (45m)

Color	Decorator	2 Unit Module
Black	ISFH110BK	IMH110ST2BK
Ivory	ISFH110EI	IMH110ST2EI
Gray	ISFH110GY	IMH110ST2GY
Office White	ISFH110OW	IMH110ST2OW
White	ISFH110W	IMH110ST2W

Note: Product consists of send and receive pair.



VGA and 3.5mm HD AV Extender

Extend up to 75ft (23m) over two 4-pair UTP cables, 1.5 unit

Color	Catalog Number
Black	IM15311015BK
Gray	IM15311015GY
Ivory	IM15311015EI
Office White	IM15311015OW
White	IM15311015W

Note: Product consists of send and receive pair.



RCA Component with Audio 110 Audio/Video Modules

Extend up to 75ft (23m) over (2) 4-pair UTP cables, 1.5 unit

Color	RCA Component Video, Left/Right Audio	RCA Component Video, 3.5mm Audio
Black	IMCAR11015BK	IMC3511015BK
Gray	IMCAR11015GY	IMC3511015GY
Ivory	IMCAR11015EI	IMC3511015EI
Office White	IMCAR11015OW	IMC3511015OW
White	IMCAR11015W	IMC3511015W



RCA 110 Audio/Video Modules

Extend up to 100ft (30.5m) over (1) 4-pair UTP cables, 1 unit

Color	75ft (23m) max. RCA Component Video, HD
Black	IMCR1101BK
Gray	IMCR1101GY
Ivory	IMCR1101EI
Office White	IMCR1101OW
White	IMCR1101W

Color	100ft (30.5m) max. RCA Composite Video, Left/Right Audio	RCA Left/Right Audio
Black	IMR1101BK	IMAR1101BK
Gray	IMR1101GY	IMAR1101GY
Ivory	IMR1101EI	IMAR1101EI
Office White	IMR1101OW	IMAR1101OW
White	IMR1101W	IMAR1101W

AV Modules



Solder Audio/Video Modules

	1.5 Unit	1 Unit		
Color	RCA Component Video with Left/Right Audio or RGBHV	RCA Component Video	RCA Composite Video with Left/Right Audio	RCA Composite Video, 3.5mm Stereo Audio Jack
Black	IMCRS15BK	IMCRS1BK	IM3RS1BK	IMRSJ1BK
Gray	IMCRS15GY	IMCRS1GY	IM3RS1GY	IMRSJ1GY
Ivory	IMCRS15EI	IMCRS1EI	IM3RS1EI	IMRSJ1EI
Office White	IMCRS15OW	IMCRS1OW	IM3RS1OW	IMRSJ1OW
White	IMCRS15W	IMCRS1W	IM3RS1W	IMRSJ1W



Gold Pass-Through Audio/Video Modules

	Female to female coupler, 1 unit	Speaker post		
Color	RCA Component Video	RCA Composite Video with Left/Right Audio	RCA Left/Right Audio with 3.5mm Stereo Audio Jack	Black and Red, Screw Termination
Black	IMCRF1BK	IM3RF1BK	IM35AR1BK	IMSP1BK
Gray	IMCRF1GY	IM3RF1GY	IM35AR1GY	IMSP1GY
Ivory	IMCRF1EI	IM3RF1EI	IM35AR1EI	IMSP1EI
Office White	IMCRF1OW	IM3RF1OW	IM35AR1OW	IMSP1OW
White	IMCRF1W	IM3RF1W	IM35AR1W	IMSP1W



Speaker Banana Plugs

	Screw termination, gold	
	Black	Red
10-pack	SPPBK10	SPPR10

Wallplate Frames, Delivery Bezels, Modules and Gangable AV Wallboxes



Hubbell iSTATION Modular Wallplate Frames

Single-service, low voltage

Color	1-Gang	2-Gang	3-Gang	4-Gang
Black	IMF1BK	IMF2BK	IMF3BK	IMF4BK
Gray	IMF1GY	IMF2GY	IMF3GY	IMF4GY
Ivory	IMF1EI	IMF2EI	IMF3EI	IMF4EI
Office White	IMF1OW	IMF2OW	IMF3OW	IMF4OW
White	IMF1W	IMF2W	IMF3W	IMF4W

Multi-service, power and low voltage

Color	1-Gang Decorator 1-Gang iSTATION	2-Gang Decorator	1-Gang Decorator 2-Gang iSTATION	1-Gang Decorator 3-Gang iSTATION	2-Gang Decorator 2-Gang iSTATION
Black	IMFP1D1BK	IMFP2BK	IMFP1D2BK	IMFP1D3BK	IMFP2D2BK
Gray	IMFP1D1GY	IMFP2GY	IMFP1D2GY	IMFP1D3GY	IMFP2D2GY
Ivory	IMFP1D1EI	IMFP2EI	IMFP1D2EI	IMFP1D3EI	IMFP2D2EI
Office White	IMFP1D1OW	IMFP2OW	IMFP1D2OW	IMFP1D3OW	IMFP2D2OW
White	IMFP1D1W	IMFP2W	IMFP1D2W	IMFP1D3W	IMFP2D2W

Hubbell iSTATION Stainless Steel Plates

1-Gang	2-Gang	3-Gang	4-Gang
IMSS1	IMSS2	IMSS3	IMSS4



Delivery Bezels and Modules

Color	Raceway Bezel	Hubbell iSTATION Bezel for Third-Party Raceway	Furniture Boxes
Black	–	–	HBLIMFBK
Gray	KPIMBZGY	HWAPLGY	HBLIMFGY
Ivory	–	–	HBLIMFI
Office White	KPIMBZOW	HWAPLOW	–
White	–	HWAPLW	HBLIMFWA

Third-Party Raceway Modules

Unloaded, 2-port, 10-pack

Color	Catalog Number
Black	HWM2KBK10
Gray	HWM2KGY10
Ivory*	HWM2KI10
White	HWM2KW10

Note: *Equivalent to Hubbell Office White.

Two and Three Gangable AV Wallboxes

Box	Dimensions	Top Knockouts	Bottom Knockouts	Back Knockouts	Catalog Number
2-Gang, 2" KO, 54in ³ capacity	H: 4.21" W: 4.06" D: 4.0"	(2) ½" (2) ½" – ¾" TKO*	(1) 1", 1¼", 1½" & 2"	(2) ½" – ¾" TKO	HBL985
3-Gang, 2" KO, 79in ³ capacity	H: 4.21" W: 5.87" D: 4.0"	(3) ½" (3) ½" – ¾" TKO*	(1) ½" (1) ½" – ¾" TKO* (1) 1", 1¼", 1½" & 2"	(3) ½" – ¾" TKO	HBL986

Note: *TKO (Tangential Knockout).



Low Voltage AV Wallbox Partitions

Compatible With	Description	Quantity	Catalog Number
HBL985 and HBL986	Solid divider	1	HBL989
	With pass-thru capability	1	HBL989AVD



Network Wiring and netSELECT® Products

Modules and Frames



HD15/9-Pin or HDMI Modules

	1 Unit	1.5 Unit		2 Unit
Color	HD15/9-Pin or HDMI	Angled, HD15/9-Pin or HDMI	HD15/9-Pin or HDMI with 3.5mm Stereo Jack*	HD15/9-Pin or HDMI with 3.5mm SJ+AV Conn
Black	IMBDS1BK	IMBDSA15BK	IMB15315BK	IMB153X2BK
Gray	IMBDS1GY	IMBDSA15GY	IMB15315GY	IMB153X2GY
Ivory	IMBDS1EI	IMBDSA15EI	IMB15315EI	IMB153X2EI
Office White	IMBDS1OW	IMBDSA15OW	IMB15315OW	IMB153X2OW
White	IMBDS1W	IMBDSA15W	IMB15315W	IMB153X2W

Note: *Screw termination or solder.

DVI Modules

	DVI Blank, Unloaded, 1.5 Unit	
Color	1-Pack	10-Pack
Black	IMBDVI15BK	IMBDVI1015BK
Gray	IMBDVI15GY	IMBDVI1015GY
Ivory	IMBDVI15EI	IMBDVI1015EI
Light Almond	IMBDVI15LA	IMBDVI1015LA
Office White	IMBDVI15OW	IMBDVI1015OW
White	IMBDVI15W	IMBDVI1015W

Modules



	1 Unit		1.5 Unit		Recessed, Angled, 1-Port	Recessed, Angled, 2-Port
Color	Flat, 1-Port	Flat, 2-Port	Angled, 1-Port	Angled, 2-Port		
Black	IM1K1BK	IM2K1BK	IM1KA15BK	IM2KA15BK	IM1IA15BK	IM2IA15BK
Gray	IM1K1GY	IM2K1GY	IM1KA15GY	IM2KA15GY	IM1IA15GY	IM2IA15GY
Ivory	IM1K1EI	IM2K1EI	IM1KA15EI	IM2KA15EI	IM1IA15EI	IM2IA15EI
Office White	IM1K1OW	IM2K1OW	IM1KA15OW	IM2KA15OW	IM1IA15OW	IM2IA15OW
White	IM1K1W	IM2K1W	IM1KA15W	IM2KA15W	IM1IA15W	IM2IA15W

Blank Modules

Color	0.5 Unit	1 Unit	1.5 Unit
Black	IMB05BK	IMB1BK	IMB15BK
Gray	IMB05GY	IMB1GY	IMB15GY
Ivory	IMB05EI	IMB1EI	IMB15EI
Office White	IMB05OW	IMB1OW	IMB15OW
White	IMB05W	IMB1W	IMB15W

SC Angled Modules

	1.5 Unit, 1 Duplex	2 Unit, 2 Duplex
	IM1SCA15BK	IM2SCA2BK
	IM1SCA15GY	IM2SCA2GY
	IM1SCA15EI	IM2SCA2EI
	IM1SCA15OW	IM2SCA2OW
	IM1SCA15W	IM2SCA2W

Hubbell iSTATION Audio/Video Modules

XLR, speakON® and ¼ inch modules applications include video distribution, desktop and laptop computers, monitors, cameras, microphones and projectors, home theater and entertainment. Note: Order IMAVB15 series blank modules with AV connectors for Hubbell iSTATION applications.



Color	AV Blank 1.5 Unit, 10-Pack	XLR Screw Terminal, 10-Pack	XLR Solder-Type, 10-Pack	speakON® Conn. Solder-Type, 10-Pack	USB Feed-Thru A-to-B, 10-Pack	¼" Stereo Jack Solder-Type, 10-Pack
Black	IMAVB15BK	XLRST10	XLR10	SC10	USB10	14S10
Gray	IMAVB15GY					
Ivory	IMAVB15EI					
Office White	IMAVB15OW					
White	IMAVB15W					

Note: *Not UL Listed.

speakON® is a registered trademark of Neutrik® AG.

Hubbell iSTATION Surface Mount Boxes

Ideal for open office MUTOA cabling, compact surface mount environments and retrofits to support data, voice and multimedia applications. Features adjustable furniture latches to provide an additional mounting option to common ANSI/TIA standard furniture openings and solutions requiring fiber. Box bases feature fiber storage posts that can store one meter fiber cable after termination.

Can be mounted with supplied surface mounting screws or double-sided adhesive tape and mounted to NEMA electric boxes or relay racks.

Features

- Low-profile design
- Accepts XJ jacks, audio video and fiber connectors
- Provided with double-sided tape and mounting screws for easy installation
- UL and cULus listed
- Constructed with a high-impact resistant, flame-retardant polymer
- ANSI/TIA-606B compliant

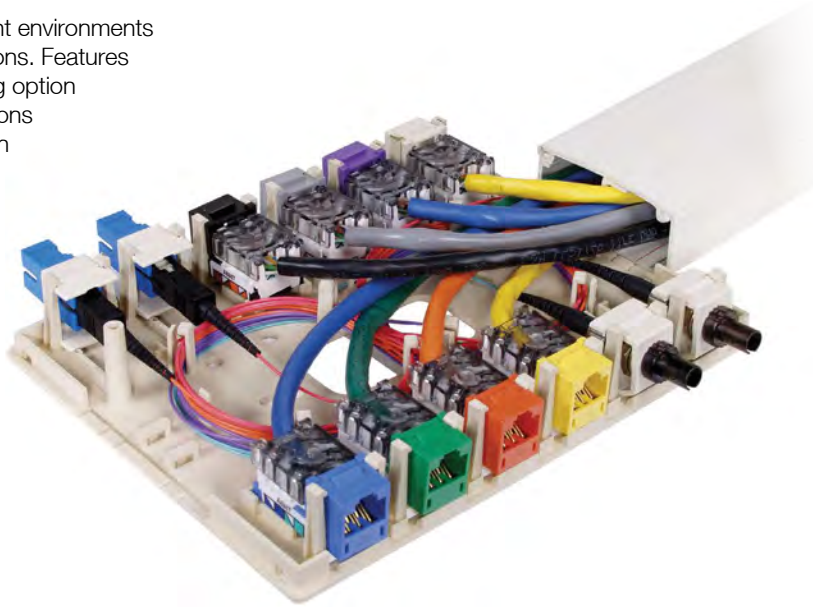

HSB Surface Mount Boxes

Color	1-Port	2-Port	4-Port	6-Port	12-Port
Black	HSB1BK	HSB2BK	HSB4BK	HSB6BK	HSB12BK
Ivory	HSB1EI	HSB2EI	HSB4EI	HSB6EI	HSB12EI
Gray	HSB1GY	HSB2GY	HSB4GY	HSB6GY	HSB12GY
Office White	HSB1OW	HSB2OW	HSB4OW	HSB6OW	HSB12OW
White	HSB1W	HSB2W	HSB4W	HSB6W	HSB12W

UL Plenum Rated HSB Surface Mount Boxes

Color	1-Port	2-Port
Black	HSB1BKP	HSB2BKP
Ivory	HSB1EIP	HSB2EIP
Gray	HSB1GYP	HSB2GYP
Office White	HSB1OWP	HSB2OWP
White	HSB1WP	HSB2WP

Note: HSB surface mount boxes are not compatible with SJ shielded jacks.

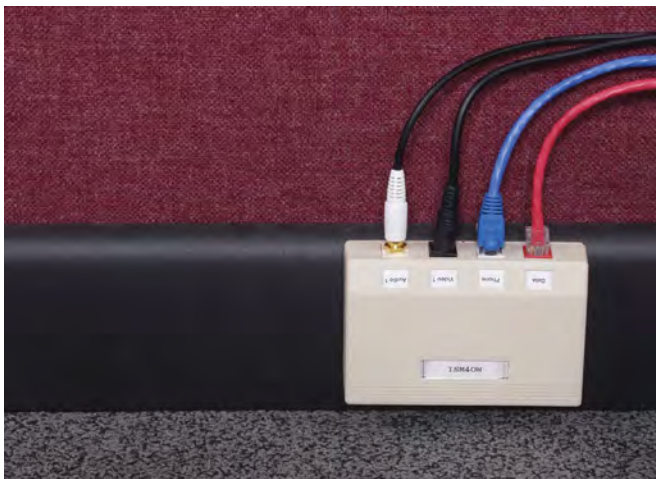

Non-Metallic Raceway Compatibility Chart

Series	PP	PL	PW	PB
HSB1	✓			✓*
HSB2	✓			✓*
HSB4	✓	✓	✓	✓*
HSB6	✓	✓	✓	✓*
HSB12	✓	✓	✓	✓*

Note: *Use PB3REDA transition fitting.
See section T for Raceway product information.

- PP1 = PREMISETRAK Latching Raceway
- PL1 = LANTRAK® Latching Raceway
- PW2 = WALLTRAK® Latching Raceway
- PB2 = BASETRAK® Non-Latching Raceway
- PB3 = BASETRAK Non-Latching Raceway
- PS3 = SUPER BASETRAK® Non-Latching Raceway

Universal Patch Panels and Wall Mount Brackets



Consolidation Point Block, Category 6 and Category 5e

Description	Catalog Number
Category 6, 12-Port, Universal, 89D.	HP612
Category 5e, 12-Port, Universal, 89D.	HP5E12

Universal Patch Panel, Category 5e

Description	Catalog Number
24-Port, 1.75" H.	HP5E24
48-Port, 3.50" H.	HP5E48
96-Port, 7.0" H.	HP5E96

Universal Patch Panel, Category 6

Description	Catalog Number
24-Port, 1.75" H.	HP624
48-Port, 3.50" H.	HP648
96-Port, 7.0" H.	HP696

Jack Panel, Unloaded

Description	Catalog Number
Wall Mount, 12-Port, Black.	HPJ1289
Rack Mount, 24-Port, 1.75" H, Black.	NSPJ24
Rack Mount, 48-Port, 3.5" H, Black.	NSPJ48

Rear Cable Management Bar*

Description	Catalog Number
Screws to the rear flange of a 19-inch rack.	CMBR
HPW panel mount.	HPRCMB

Note: *Not UL Listed.

Wall Mount Brackets, Bottom-Hinged

Includes assembled bottom-hinged wall bracket.

Rack Units	Width Inches (mm)	Depth Inches (mm)	Height Inches (mm)	Catalog Number
1	19" (483)	4" (102)	1.75" (45)	HPWWB1U4
2	19" (483)	4" (102)	3.50" (89)	HPWWB2U4
		8" (203)	3.50" (89)	HPWWB2U8
4	19" (483)	4" (102)	7.00" (178)	HPWWB4U4
		8" (203)	7.00" (178)	HPWWB4U8
6	19" (483)	4" (102)	10.50" (267)	HPWWB6U4
		8" (203)	10.50" (267)	HPWWB6U8
		18" (457)	10.50" (267)	HPWWB6U18

Wall Mount Brackets, Side-Hinged

Includes assembled side-hinged wall bracket.

Rack Units	Width Inches (mm)	Depth Inches (mm)	Height Inches (mm)	Catalog Number
2	19" (483)	4" (102)	3.50" (89)	BRMCCMB19X35X4
4	19" (483)	4" (102)	7.00" (178)	BRMCCMB19X7X4
2	19" (483)	8" (203)	3.50" (89)	BRMCCMB19X35X8
4	19" (483)	8" (203)	7.00" (178)	BRMCCMB19X7X8



Network Wiring and netSELECT® Products

Features and Benefits

NSC Patch Cords

- Conductor: #24 AWG UTP
- Jacket: Flame-Retardant PVC-CM Rated
- Plug Body: Polycarbonate UL 94V-0
- Plug Boot: PVC
- Contact Plating: 50 micro-inch Gold

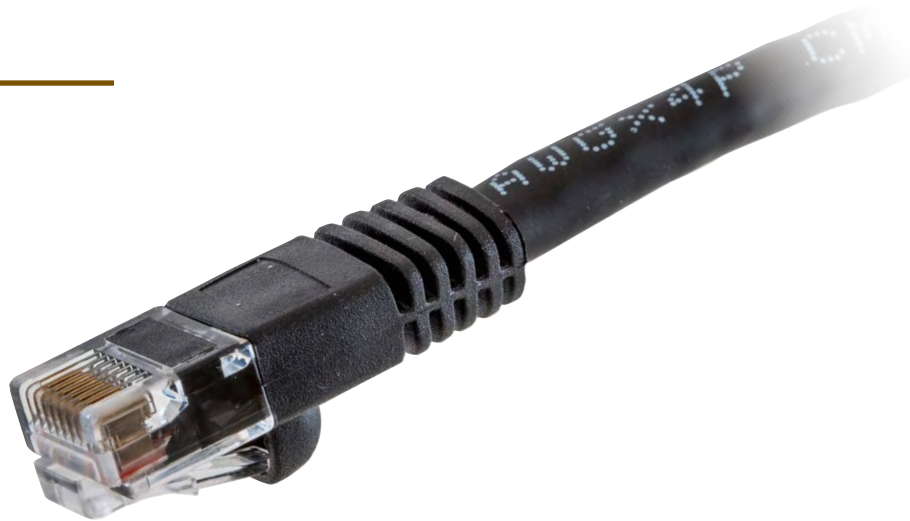

Housing Design

- Category 6 performance
- Slim snagless boot for high density ports
- PoE ready



Performance, Mechanical

- Cable to plug tensile strength: 20+ lbs.
- Mating cycles: 2000+

NSC Patch Cords, Category 6

Length (ft)	Color			
	Black	Blue	Gray	White
1'	NSC6BK01	NSC6B01	NSC6GY01	NSC6W01
3'	NSC6BK03	NSC6B03	NSC6GY03	NSC6W03
5'	NSC6BK05	NSC6B05	NSC6GY05	NSC6W05
7'	NSC6BK07	NSC6B07	NSC6GY07	NSC6W07
10'	NSC6BK10	NSC6B10	NSC6GY10	NSC6W10
15'	NSC6BK15	NSC6B15	NSC6GY15	NSC6W15



NSC6B01

NSC Patch Cords, Category 5e

Length (ft)	Color			
	Black	Blue	Gray	White
1'	NSC5EBK01	NSC5EB01	NSC5EGY01	NSC5EW01
3'	NSC5EBK03	NSC5EB03	NSC5EGY03	NSC5EW03
5'	NSC5EBK05	NSC5EB05	NSC5EGY05	NSC5EW05
7'	NSC5EBK07	NSC5EB07	NSC5EGY07	NSC5EW07
10'	NSC5EBK10	NSC5EB10	NSC5EGY10	NSC5EW10
15'	NSC5EBK15	NSC5EB15	NSC5EGY15	NSC5EW15



NSC5EW01

Features and Benefits

AV In-Wall Enclosure

Hubbell's netSELECT® Flat Panel Television (FPTV) connection enclosure delivers high-density connectivity and power in the wall. This allows flat panel displays and interactive "smart" boards to sit flush against walls with no dangling cords. It quickly installs to studs or sheetrock without additional components or hardware.

- 18 Gauge white powder coated rugged steel base
- 2 and 4-gang enclosure with two 1½ and 1¼ inch KOs
- Optional screw on cover reduces tampering
- cULus 1863 Listed

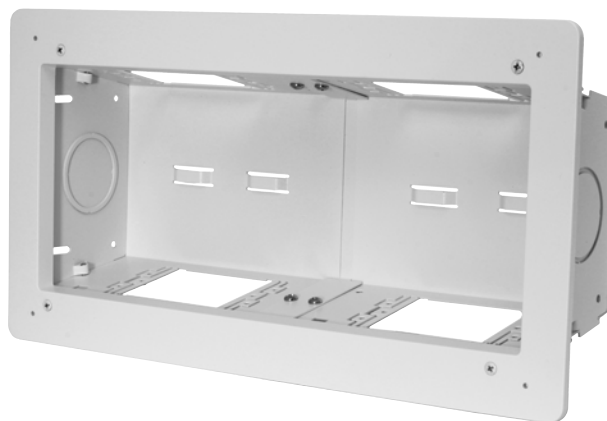

Box Design

- Flush against walls installation
- Sheet metal base white powder coat finish
- Accepts standard electrical boxes
- Integrated cable management



Mounting

- Multiple device mounting options
- 1½" And 1¼" conduit knockouts
- Easily mounts to studs or sheetrock
- Easily replaceable receptacle
- Trim ring covers rough-in



NSAV6C



NS801W



NSOKPS



NP26W



SFHC14W



NSJ6W

FPTV Connection Enclosure

Description	Height Inches (mm)	Width Inches (mm)	Depth Inches (mm)	Color	Catalog Number
2-gang in-wall enclosure.	8.16" (207)	7.92" (201)	3.37" (86)	White	NSAV62M
4-gang in-wall enclosure.	14.80" (376)	7.92" (201)	3.37" (86)	White	NSAV124M
Steel cover for NSAV6 series.	7.2" (183)	7.2" (183)	0.05" (1)	White	NSAV6C
Steel cover for NSAV12 series.	13.80" (351)	7.2" (183)	0.05" (1)	White	NSAV12C
Block wall adapter.					NSAV6BW
New work stud brackets.					NSAV6NW

Accessories

Power Kits

Description	Color	Catalog Number
Standard power kit.	White	NSOKPTR
Surge protected power kit.	Blue	NSOKPS

Unloaded Wallplates and Frames

Description	Color	Catalog Number
1-gang blank wallplate.	White	P14W
1-gang decorator wallplate.	White	P26W
1-gang Hubbell iSTATION wallplate.	White	IMF1W
1-gang 4-port wallplate.	White	NSP14W

AV Connectors and Wallplates

Description	Color	Catalog Number
1-port HDMI frame.	White	NS801W
2-port HDMI frame.	White	NS802W
HDMI snap fit.	White	SFHC14W
F-connector snap fit.	White	NSF70W
USB A-to-B snap fit.	White	SFUSBABW
Cat 6 snap fit jack.	White	NSJ6W

Note: See pages Y-4 to Y-8 for snap fit multimedia jacks and AV connectors.

Network Wiring and netSELECT® Products

HDMI Products

AV Ceiling Enclosure

The AV Ceiling Enclosure is designed to work with active AV devices to integrate AV distribution, data connections and power in one location, providing a direct connection to a projector or a display device. An additional AV/data kit can be added or customized to address all connector, mounting and patching needs, reducing multiple pieces on site.

- Manage multiple applications inside one enclosure
- Flush mounted, white enclosure for consistent look when mounted in the ceiling
- Loaded with two Hubbell 20A duplex receptacles and a 2-gang back box
- All steel rugged construction provides the ultimate strength for installation



Description	Height Inches (mm)	Width Inches (mm)	Depth Inches (mm)	Color	Catalog Number
AV Ceiling Enclosure	12" (305)	24" (610)	8" (203)	White	AVCE1H

Note: Enclosure includes two 20 amp duplex receptacles and 2-gang back box.

HDMI Decorator Frames

netSELECT® HDMI Decorator Frames deliver uncompromising digital audio and video wherever you need it. Unleash the full potential of your high definition display and audio installations.

- Third party tested for 1080p resolutions
- UL Listed - Communications Circuit Accessory and CSA Certified



Frame Design

- High impact thermoplastic frame
- Connector flush to frame face



Connector

- Thumbscrew prevents accidental disconnection only when used with Hubbell's HDMI patch cords
- Connector sized to fit 1 inch conduit
- 4 inch flexible extension reduces bend radius issues in confined spaces

HDMI Products

Description	Color	1-Gang, 1-Port	1-Gang, 2-Port
HDMI, Decorator Frame, Female to Female	Black	NS801BK	NS802BK
	Gray	NS801GY	NS802GY
	Ivory	NS801I	NS802I
	Light Almond	NS801LA	NS802LA
	White	NS801W	NS802W



HDMI Patch Cords, #24 AWG



Length	HDMI Device Patch Cords	Length	Horizontal Cords (Connector to Connector)
3 ft.	HDPC03BK	10 ft.	HDH10BK
6 ft.	HDPC06BK	15 ft.	HDH15BK
		20 ft.	HDH20BK
		25 ft.	HDH25BK
		30 ft.	HDH30BK

Note: Black and Non-Plenum only.

Advantages and Wiring Layout

Connect Your Home to Internet, Voice and Video Services

netSELECT® is an innovative network solution that's perfect for any home or small office. Specifically positioned as the voice/data segment for the Residential brand, the netSELECT® System satisfies the need for a dependable, flexible system that can accommodate all of today's fast-changing voice, data and video requirements.

This cost-effective solution incorporates all the quality you'd expect from Hubbell. Built-in flexibility makes it easy to upgrade and keep pace with evolving technologies.

- Share single analog, cable or DSL internet connection
- Local file access
- Shared peripherals
- Multiple telephone distribution
- Call handling (PBX)
- Video distribution
- Play games that allow multi-users
- Control home automation systems

Specifications

- Material: high-impact thermoplastic to minimize WiFi degradation
- Finish: White, satin finish
- UL and cULus Listed

Today's Communications Entail A Lot More Than Just Talking. netSELECT® Keeps You Connected—Internet, Voice, Data and Entertainment

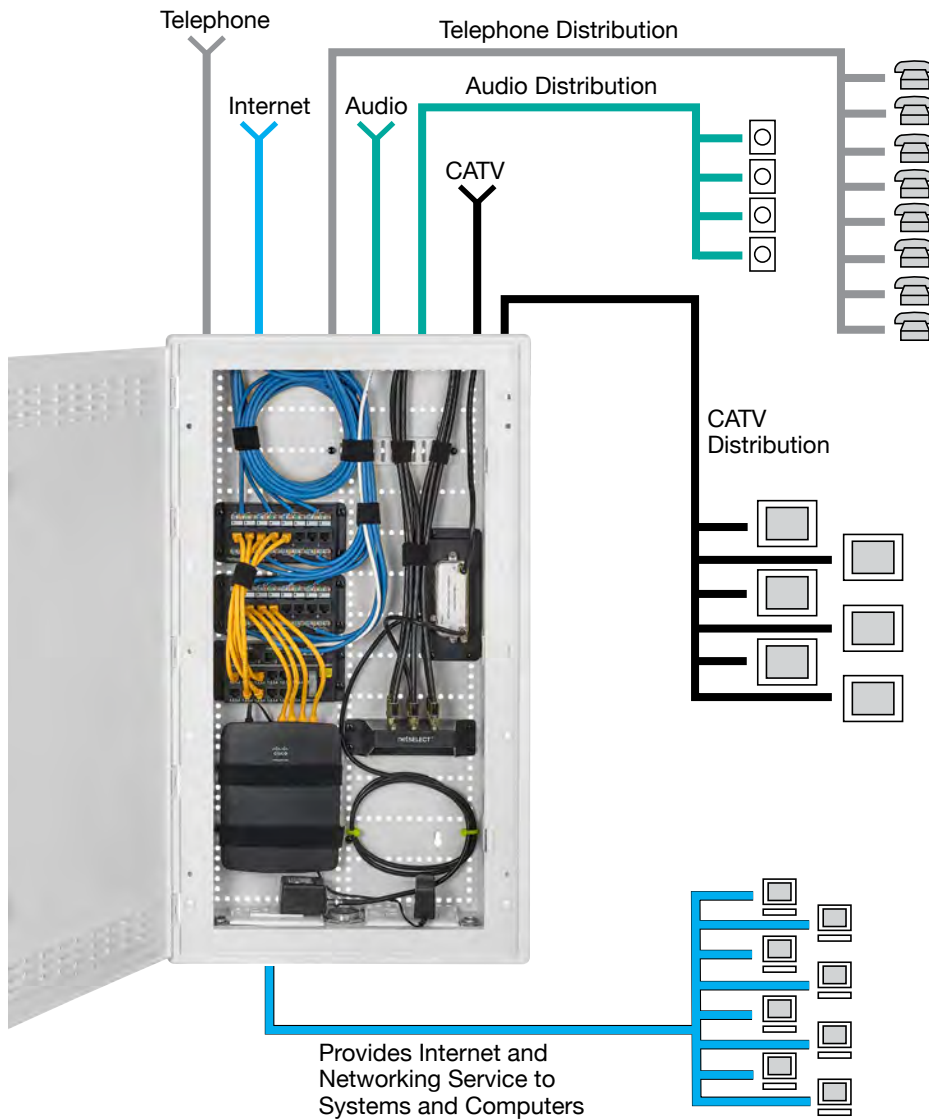

Flexibility

- Hinged door can be mounted to swing from either side



Options

- Horizontal and vertical module mounting holes for maximum flexibility



Installation

- Additional nylon push pins provided to assist module mounting

Network Enclosures

Features

- Flush or surface mount enclosure (hardware provided)
- Hinged cover can be mounted to swing from either side
- Integral trim ring hides rough-in hole in sheet rock providing a finished appearance (except NSOBOX48)
- Horizontal and vertical module mounting holes for maximum flexibility
- Unique 89D bracket mounting holes allow easy mounting of 66 blocks and peripherals
- Provisions to mount optional duplex power and lock kit available
- Integral cable management slots and tie-wraps provided to help dress cable runs
- Additional nylon push pins provided to assist module mounting
- Material: 20-18 gauge steel
- Finish: white, powder coat
- cULus Listed 1863

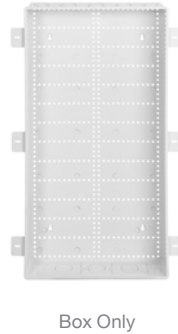

14-Inch Network Enclosure

Description	Height Inches (mm)	Width Inches (mm)	Depth Inches (mm)	Module Unit Capacity	Catalog Number
With hinged vented door	16.2" (412)	17.5" (445)	4.35" (111)	5	NSOBXP14
14" height box only	13.5" (343)	17.1" (434)	3.95" (100)	5	NSOBXP14B
Hinged vented door	16.2" (412)	17.5" (445)	0.4" (10)	–	NSOBXP14D



28-Inch Network Enclosure

Description	Height Inches (mm)	Width Inches (mm)	Depth Inches (mm)	Module Unit Capacity	Catalog Number
With hinged vented door	30" (762)	17.5" (445)	4.35" (111)	11	NSOBXP28
28" height box only	27.7" (704)	17.1" (434)	3.95" (100)	11	NSOBXP28B
Hinged vented door	30" (762)	17.5" (445)	0.4" (10)	–	NSOBXP28D



42-Inch Network Enclosure

Description	Height Inches (mm)	Width Inches (mm)	Depth Inches (mm)	Module Unit Capacity	Catalog Number
With hinged, vented, 2-piece door	45.1" (1146)	17.5" (445)	4.35" (111)	16	NSOBXP42
42" height box only	42.6" (1082)	17.1" (434)	3.95" (100)	16	NSOBXP42B
Hinged vented door (2-piece)	45.1" (1146)	17.5" (445)	0.4" (10)	–	NSOBXP42D



Network Modules

Features

netSELECT® Modular Components enable the designer to select performance requirements specifically for the application. Modules snap horizontally or vertically into the enclosures for maximum flexibility and optimum space usage.

- Dimensions: 6.47 in. W x 2.95 in. H, except NSOMTM24 6.47 in. W x 6.00 in. H
- Meets FCC Part 68 standard
- Material: High impact plastic
- cULus Listed 1863
- All data and phone modules 568A wired



NSOTVDM6



NSOPTM8



NSOETM8



NSODM8



NSOMTM24



NSOMTM12

Combination Modules

Description	Units	Catalog Number
6-port telephone panel and 6-port coaxial splitter with optional 6-port Category 5e panel provides voice, video, and data distribution in a space efficient package; perfect for use with NSOBOX10 and NS790xx plates to quickly establish a comprehensive home network.		
6-port telephone and video	3	NSOTVM6
6-port telephone, video and Category 5e	3	NSOTVDM6
6-port Category 5e data upgrade kit	3	NSODK6

Primary Telephone Module

Description	Units	Catalog Number
8-port phone outlets with up to (4) incoming lines for voice, fax or modem applications in a protected PCB module; pre-mounted push pins snap the module quickly into place; RJ31X interface jack included for security system connection; RJ45 jack interfaces with optional NSOETM8 telephone expansion module for additional extensions.	1	NSOPTM8

Expansion Telephone Module

Description	Units	Catalog Number
8-port adds an additional (8) phone outlets with up to (4) incoming lines when used with the primary telephone module; pre-mounted push pins snap the module quickly into place; includes RJ45 jumper cord to connect with NSOPTM8 primary telephone module.	1	NSOETM8

Data Modules

Description	Units	Catalog Number
Category 5e data module, 8-port supports Gigabit Ethernet for up to (8) Category 5e data lines with front 110 punch-down terminations in a protected PCB module; pre-mounted push pins snap the module quickly into place.	1	NSODM8
Category 6 data module, 8-port supports enhanced transmission speeds beyond Gigabit Ethernet; future-proof for tomorrow's applications.	1	NSODM8C6

Patchable Telecom Module

Description	Units	Catalog Number
Terminates lines via modular plug to accommodate flexibility, by changing plug locations; reconfigure where phone lines go at the panel level; allows data lines to be converted to voice, with the move of a patch cord; includes nine RJ45 jumper cords.	2	NSOMTM24

Multi-Provider Patchable Telcom Module

Description	Units	Catalog Number
12-port telephone module distributes 4 incoming lines out to 12 locations through RJ-45 jacks; allows data lines to be converted to voice with the move of a patch cord; RJ31X interface jack is included for security system connection.	1	NSOMTM12

Audio/Video Modules

Features

netSELECT® Video Modules support bidirectional signal by splitting to 4, 6, or 8 separate work areas. Pre-mounted push pins snap the module quickly into place.

- Dimensions for VAMP, AM8 and BM: 6.47 in. W x 2.95 in. H
- Dimensions for video splitters: 6.47 in. W x 2.09 in. H x 3.20 in. D
- Material: High impact plastic
- cULus Listed 1863

4-Way Coaxial Splitter Modules

One incoming line, four outgoing.

Description	Units	Catalog Number
1GHz, basic unit	1	NSOVM4
2.3GHz, enhanced capability	1	NSOVM42G



NSOVM4

6-Way Coaxial Splitter Modules

One incoming line, six outgoing.

Description	Units	Catalog Number
1GHz, basic unit	1	NSOVM6
2.3GHz, enhanced capability	1	NSOVM62G



NSOVM6

8-Way Coaxial Splitter Modules

One incoming line, eight outgoing.

Description	Units	Catalog Number
1GHz, basic unit	1	NSOVM8
2.3GHz, enhanced capability	1	NSOVM82G



NSOVM8

Fixed Video Amplifier Module

120 Volt rated

Description	Units	Catalog Number
Provides 10dB video signal amplification for incoming cable feeds recommended for use when more than four outputs are installed or when signal level is low; provides 10dB forward path gain and supports current digital cable systems and modems with a passive return; pre-mounted push pins snap the module quickly into place; includes RG-59 cable jumper to connect amplifier to passive video splitter.	1	NSOVAMP



NSOVAMP

Eight Room Audio Module

Description	Units	Catalog Number
Distributes audio from an amplifier to matching volume controllers; supports up to eight rooms of audio; power handling – 200W RMS@20° C; requires impedance matching volume controls (see page Y-24).	1	NSOAM8



NSOAM8

Blank Module Bracket

Description	Units	Catalog Number
Allows mounting of active components (i.e. switches, routers) or other devices onto a modular platform; (2) VELCRO® brand fasteners included to mount components onto module; pre-mounted push pins snap the module quickly into place; 2-pack	1	NSOBM2

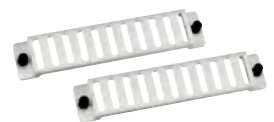

NSOBM2

VELCRO® is a registered trademark of Velcro Industries B.V.

Accessories

Features

netSELECT® Accessories enhance system capabilities. Volume controls expand home audio applications. Cabinet mounted receptacle kits provide convenience power to the enclosure.

- Audio controls available in slide or rotary
- Receptacles available in surge and standard kits



NSOSAVC



NSORAVC



NSOKPS



FLOCK1



NSOFSB



FSPFP6X



FSPHD6X

Accessories

Description	Color	Catalog Number
Slide Audio Volume Controller, Decorator Styling, Power handling - 70W RMS@20° C. Impedance matching for up to 8 pairs of speakers. Includes both ivory and white slides and frames.	Ivory/White	NSOSAVC
Rotary Audio Volume Controller Power handling - 70W RMS@20° C. Impedance matching for up to 8 pairs of speakers. Includes both ivory and white knobs and frames.	Ivory/White	NSORAVC
Standard Power Kit, Includes tamper-resistant duplex receptacle 15A 125V NEMA 5-15R, electrical steel box and wallplate.		NSOKPTR
Surge Suppression Power Kit, Includes surge receptacle 15A 125V NEMA 5-15R, 240 Joules/15,000A protection per mode, electrical steel box and wallplate.		NSOKPS
Chromed Steel Lock Kit, Includes two keys. Eliminates unwanted tampering.		FLOCK1

Panel Bracket Adapter, For use with Adapter Panels shown below, and FSP series modules. Snap mounts into structured cabling enclosures.

NSOFSB

F-Connector Adapter Panel, with Six Populated Coaxial Connectors.

FSPFP6X

Jacks Adapter Panel, with Six Blank Openings for jacks and snap fits.

FSPHD6X

Molded-In Voice/Data/Video

Features

Designed to complement decorator styling, these jacks offer voice and Cat. 5e devices to fit within a decorator wallplate.

- High impact-resistant thermoplastic frame
- Meets FCC part 68
- cULus Listed 1863 - Communication Circuit Accessory and CSA Certified

Molded-In Voice/Low-Speed Data

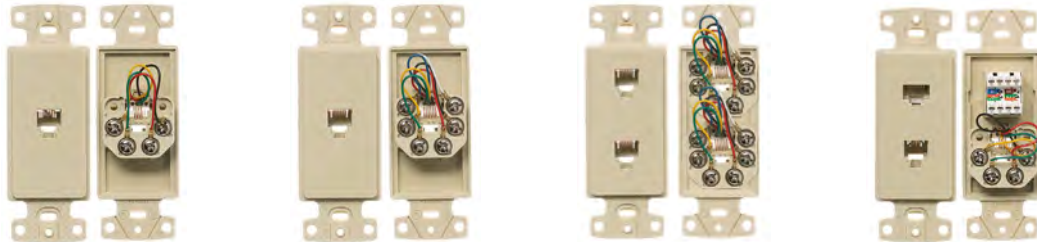

Description	Decorator Frame, One RJ11 Jack, 6-Position, 4-Conductor	Decorator Frame, One RJ11 Jack, 6-Position, 6-Conductor	Decorator Frame, Duplex RJ11 Jacks, 6-Position, 6-Conductor	Decorator Frame, One Cat. 5e 110 Punch-Down, One RJ11 Jack, 6-Position, 4-Conductor
Color	Screw Terminations	Screw Terminations	Screw Terminations	110 Punch-Down/Screw Terminations
Black	NS770BK	—	—	NS784BK
Brown	NS770	NS771	—	NS784
Gray	NS770GY	—	—	NS784GY
Ivory	NS770I	NS771I	NS772I	NS784I
Light Almond	NS770LA	NS771LA	NS772LA	NS784LA
White	NS770W	NS771W	NS772W	NS784W

Features

Coaxial video and combination jacks complement multimedia needs in a 1-gang decorator opening.

- High impact-resistant thermoplastic frame
- Jacks meet FCC part 68
- UL Listed 1863 - Communication Circuit Accessory and CSA Certified

Molded-In Voice/Low-Speed Data



Description	Decorator Frame, Single F-Type Coupler Bulkhead, Female to Female	Decorator Frame, One RJ11 Jack, 6-Position, 4-Conductor, One F-Type Coupler Bulkhead, Female to Female	Decorator Frame, One Cat. 5e 110 Punch-Down, One F-Type Coupler Bulkhead, Female to Female
Color	Screw Terminations	Screw Terminations	110 Punch-Down Terminations
Black	—	—	NS785BK
Brown	—	—	NS785
Gray	—	—	NS785GY
Ivory	—	—	—
Light Almond	NS780LA	NS783LA	NS785LA
White	NS780W	NS783W	NS785W

Molded-In Plates

Features

Designed for voice, these devices provide an economical alternative to wall phone outlet placement.

- High impact-resistant thermoplastic wallplate
- Convenient screw down terminals
- Meets FCC part 68
- cULus Listed 1863 - Communication Circuit Accessory and CSA Certified

Molded-In Plates for Voice



1-Gang Plate,
One RJ11 Jack,
6-Position, 4-Conductor,
Screw Terminations



1-Gang Plate,
One RJ11 Jack,
6-Position, 6-Conductor,
Screw Terminations



1-Gang Plate,
Duplex RJ11 Jacks,
6-Position, 4-Conductor,
Screw Terminations

Description	Standard	Mid-Size	Standard	Standard	Mid-Size
Brown	NS730	—	NS732	—	—
Ivory	NS730I	NS735I	NS732I	NS744I	NS745I
Light Almond	NS730LA	NS735LA	NS732LA	—	—
White	NS730W	NS735W	NS732W	NS744W	NS745W

Molded-In Plates for Voice and CATV/Satellite



1-Gang Plate,
One F-Type Coupler Bulkhead,
Female to Female,
One RJ11 Jack,
6-Position, 6-Conductor



1-Gang Plate,
One F-Type Coupler Bulkhead, Female to Female,
One RJ11 Jack,
6-Position, 4-Conductor



1-Gang Plate,
One F-Type Coupler Bulkhead,
Female to Female



1-Gang Plate,
Duplex F-Type Coupler Bulkhead,
Female to Female

Description	Standard	Mid-Size	Standard	Standard	Mid-Size	Standard
Ivory	NS748I	NS755I	NS747I	NS750I	NS751I	NS752I
Light Almond	NS748LA	NS755LA	NS747LA	NS750LA	NS751LA	—
White	NS748W	NS755W	NS747W	NS750W	NS751W	NS752W



1-Gang Plate,
One Cat. 5e 110 Punch-Down
One RJ11 Jack,
6-Position, 4-Conductor
One F-Type Coupler Bulkhead,
Female to Female

Description	Standard
Black	NS790BK
Brown	NS790
Gray	NS790GY
Ivory	NS790I
Light Almond	NS790LA
White	NS790W

Telephone Wall Jacks

Features

Designed for voice applications, these jacks provide an economical alternative to basic wall mount and performance needs.

- Available in high impact-resistant thermoplastic or stainless steel
- Meets FCC part 68
- cULus Listed 1863 - Communication Circuit Accessory and CSA Certified

Telephone Wall Jacks

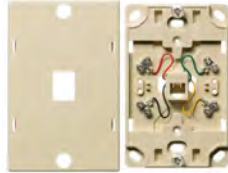

Wall Phone Jack,
6-Position, 4-Conductor,
Screw Terminations

Description

Ivory
White

NS722I
NS722W

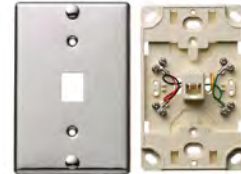

Wall Phone Jack,
6-Position, 4-Conductor,
Screw Terminations

Description

Stainless Steel

NS726SS

Features

Telephone surface mount jacks are available in 4 or 6-conductor configurations for voice. Alternatively, multimedia surface mount boxes can be custom loaded for computer and media use.

- High impact-resistant thermoplastic
- Mounts using screws or double sided tape (both included)
- Meets FCC part 68
- UL Listed 1863 - Communication Circuit Accessory and CSA Certified

Telephone Surface Mount Jacks



Telephone Surface
Mount Jack,
6-Position, 4-Conductor,
Screw Terminations

Description

Black
Gray
Ivory
Office White
White

—
—
NS760I
—
NS760W



Multimedia 1-Port
Surface Mount Box,
Jack Not Included

HSB1BK*
HSB1GY*
HSB1EI*
HSB1OW*
HSB1W*



Multimedia 2-Port
Surface Mount Box,
Jacks Not Included

HSB2BK*
HSB2GY*
HSB2EI*
HSB2OW*
HSB2W*

Note: *cULus Listed 1863 - Communication Circuit Accessory.
See pages Y-4 to Y-8 for snap fit multimedia jacks and AV connectors.

Network Wiring and netSELECT® Products

Standard UTP Wiring Conventions

Horizontal UTP Cable and Patch Cords

- Solid copper 4-pair #24 or better AWG UTP is specified for distribution cabling. Stranded UTP is specified for patch cords for flexibility. Shielded cable is not commonly used in the U.S. splices and bridge taps are not permitted.
- Cable, connectors and patch cords shall be marked with the performance category. Always match performance categories of cables and components throughout the infrastructure.
- All cable, cords and connecting hardware shall meet performance requirements of ANSI/TIA/EIA-568-C.1 and 568-C.2. Hubbell assures this compliance with all products and cable partners.

COLOR CODING:



Recognized Connector and Wiring Configurations

- 8-position modular jack/plug.
- 8-position modular panel/plug.
- T568A wiring or T568B wiring options.
- Cat. 5e or Cat. 6 recommended.

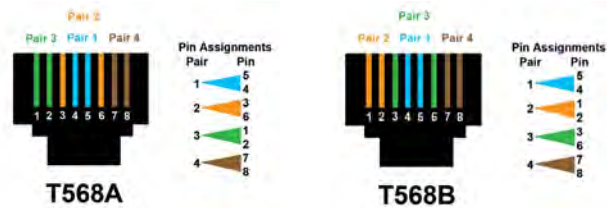

RJ45 - TIA-568 Conventions

Two wiring standards were adopted. Both configurations provide equivalent transmission performance.

8 Position / 8 Wire

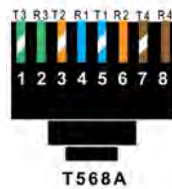

- Preferred method
- Directly compatible with 2-pair voice and Token Ring systems utilizing 6-position connectors

8 Position / 8 Wire

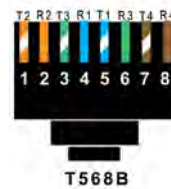

- Optional method
- AT&T's standard
- Directly compatible with AT&T phone systems

LAN Wiring Conventions

Local Area Network standards designed to operate over UTP specify pin/pair assignments on modular connectors for various signal transmission protocols. While TIA/EIA-568A and 568B conventions support all of these designations, there are some cases where the user chooses to cable only the number of pairs required to support these applications.

8 Position / 4 Wire



- 10 Mbps Ethernet over UTP
- 100 Mbps Ethernet

8 Position / 4 Wire



- 4/16 Mbps Token Ring over copper

8 Position / 4 Wire

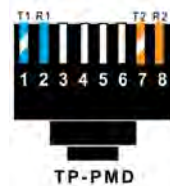

- 100 Mbps FDDI over copper (pending)

8 Position / 8 Wire



- 1000 Mbps/10Gb Ethernet over UTP
- Uses all four pairs

SECTION Z

Table of Contents



Decorator Products



USB Charger Receptacles and Outlets



Power Delivery



Decorator Products	Page	Lighting Controls	Page
Products at a Glance	Z-2	Dimmers and Fan Speed Controls	Z-19
Rocker Switches	Z-3	Wall Switches and Digital Timer	Z-20
Combination Rocker Switches/Devices	Z-4	Power Delivery	
Standard Receptacles, Weather/Tamper-Resistant, and Single Receptacles	Z-5	Floor Boxes for Concrete Floors	Z-21
USB Charger Receptacles and Outlets	Z-7	Floor Boxes for Wood Floors	Z-22
GFCI Receptacles with Auto Grounding	Z-8	Countertop Receptacles	Z-25
Recessed Receptacles and AV Wallboxes	Z-9	Under Cabinet/Counter Power Distribution	Z-26
Decorator Frames and Modular Snap Fit Jacks	Z-10	JLOAD® Multimedia Outlet	Z-27
Molded-In Voice/Data/Video	Z-11	Technical Information	Z-28
Plastic and Metal Wallplates	Z-12		
Combination Wallplates	Z-13		
Switches and Receptacles			
Toggle Switches	Z-14		
Combination Switches/Devices	Z-15		
XClamp and Duplex Receptacles	Z-16		
Single Receptacles and Range/Dryer Power Receptacles and Plugs	Z-17		
Special Use Products	Z-18		

Products at a Glance



Decorator Switches

- Smooth, quiet rocker
- Self-grounding feature is standard
- Nightlight version is available
- Ultrasonically welded cover and base
- Operating temperature : -20°C to 60°C
- UL Listed, CSA Certified



Passive Infrared Wall Switches and Timers

- Passive infrared technology
- Photocell (WS2000 series)
- No neutral required
- Steel mounting strap
- Compatible with most LED and CFL
- CEC Title 24 and Ashrae 90.1 compliant
- cULus



Decorator Duplex Receptacles

- Self-grounding feature is standard
- Tamper and weather resistant availability
- Multiple-drive Slot/Phillips/Robertson head screws
- Nightlight version is available
- Hi-visibility yellow base for easy installation
- Operating temperature: -20°C to 60°C
- UL Listed, CSA Certified



Modular Snap Fit Jacks

- Customize the jack selections and look
- Molded-In voice/low-speed data, modular snap fit
- AV connectors, standard bulkhead
- AV connectors, recessed



USB Charger Receptacles

- Two USB ports 5 Amp, 5V DC
- Patented Hubbell Tamper-Resistant technology uses cam action shutters
- Standard and Hospital grade
- cULus listed to UL498 and UL1310



USB Wall Chargers

- Flexible holder to hold phone firmly in place
- Phone can be inserted vertically or horizontally
- Green LED indicates power available and blue LED indicates wireless charging
- Available in combination with 15A or 20A 125V tamper-resistant receptacle with USB



4 Port and 2 Port USB Outlets

- Switch activated port door; when open enables power; when closed, all power is switched OFF, for a "zero" no-load draw
- Shallow depth design for two port



GFCI Receptacles

- Patented AUTOGUARD® self test technology includes disconnecting power to the receptacle if critical components are damaged and GFCI protection is lost
- Internal back wiring clamp and guide for quick and secure termination
- Night light option includes light sensor controls for automatic ON and OFF, custom dual lens for optimum light output



Power Delivery

- Hubbell Pop-Up receptacles for countertops provide a power source ideal for kitchen or bath counters and islands
- Round non-metallic floor boxes for concrete floors
- Height adjustable wood floor boxes
- Drop-in floor boxes are perfect for quick and easy installations
- Under cabinet/counter power distribution boxes can also be placed under counter islands or kitchen cabinets
- JLOAD® multimedia outlet Isolates low voltage and power in the same box

Decorator Quiet Rocker Switches

Decorator Products - Smart Style, Good Looks

Residential Decorator Switches and Receptacles provide solid, dependable performance and more. Indeed, they are fashion statements, masterfully complementing the look and feel of any room in any home.

Single Pole Decorator Quiet Rocker Switches

Description	Single Pole	Single Pole, Illuminated	Single Pole, Pilot Light	Single Pole with Nightlight	Single Pole with ON/OFF Marking
Termination	Self-Grounding, Push, Back and Side Wire	Self-Grounding, Push, Back and Side Wire	Self-Grounding, Push, Back and Side Wire	Self-Grounding, Push, Back and Side Wire	Self-Grounding, Push, Back and Side Wire
Rating	15A 120-277V AC	15A 120V AC	15A 120V AC	20A 120-277V AC	15A 120-277V AC
Black	RSD115BK	—	—	DS120NLBK**	—
Brown	RSD115	—	—	DS120NLBR**	—
Gray	RSD115GY	—	—	DS120NLGY**	—
Ivory	RSD115I	RSD115ILI*	RSD115PLI**	DS120NLIV**	RSD115IM
Light Almond	RSD115LA	RSD115ILLA*	RSD115PLLA**	DS120NLLA**	RSD115LAM
White	RSD115W	RSD115ILW*	RSD115PLW**	DS120NLWH**	RSD115WM

Note: *Light glows through the top portion of the rocker when switch is in the OFF position. Does not require a neutral wire.
 **Light glows through the top portion of the rocker when switch is in the OFF position. Requires a neutral wire.



RSD115PLW

Double Pole, Three Way and Four Way Decorator Quiet Rocker Switches

Description	Double Pole	Three Way	Three Way, Illuminated	Four Way
Termination	Self-Grounding, Back and Side Wire	Self-Grounding, Push, Back and Side Wire	Self-Grounding, Push, Back and Side Wire	Self-Grounding, Back and Side Wire
Rating	15A 120-277V AC	15A 120-277V AC	15A 120V AC	15A 120-277V AC
Black	RSD215BK	RSD315BK	—	RSD415BK
Brown	RSD215	RSD315	—	RSD415
Gray	RSD215GY	RSD315GY	—	RSD415GY
Ivory	RSD215I	RSD315I	RSD315ILI*	RSD415I
Light Almond	RSD215LA	RSD315LA	RSD315ILLA*	RSD415LA
White	RSD215W	RSD315W	RSD315ILW*	RSD415W

Note: *Light glows through the top portion of the rocker when switch is in the OFF position. Does not require a neutral wire.



DS120NLWH



RSD115WM

Decorator Weatherproof Series

Description	Color	Catalog Number
Style Line® rocker, weatherproof, self-grounding, 20A, 120/277V AC, back and side wire	Gray	RSD120WPGY
	Light Almond	RSD120WPLA
	White	RSD120WPW



RSD120WPW



RSD215W

Dimensions

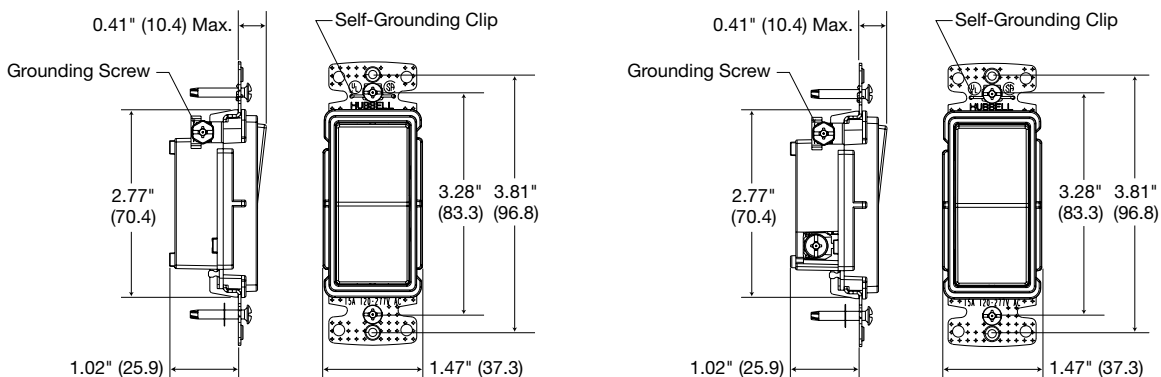

Single Pole Decorator Switch

Three Way Decorator Switch

Dimensions in Inches (mm)

Decorator Combination Quiet Rocker Switches/Devices

Features

- Low profile, less than 1 inch deep
- Self-grounding feature is standard
- Operating temperature: -20°C to 60°C
- UL Listed, CSA Certified

Combination Quiet Rocker Switches/Devices



RCD111W



RCD101W



RCD108W



RCD109W



DD100NLWH

Description	Three (3) Single Pole Switches	Two (2) Single Pole Switches	Single Pole and Three Way Switch	Single Pole Switch, 2 Pole, 3 Wire Receptacle
Termination	Self-Grounding, Side Wire	Self-Grounding, Side Wire	Self-Grounding, Side Wire	Self-Grounding, Side Wire
Rating	15A 120-277V AC	15A 120-277V AC	15A 120-277V AC	15A 120V (switch) 15A 125V (recept.) NEMA 5-15R
Black	—	RCD101BK	RCD103BK	RCD108BK
Gray	—	RCD101GY	RCD103GY	RCD108GY
Ivory	RCD111I	RCD101I	RCD103I	RCD108I
Light Almond	RCD111LA	RCD101LA	RCD103LA	RCD108LA
White	RCD111W	RCD101W	RCD103W	RCD108W

Description	* Single Pole Switch, Tamper-Resistant, 2 Pole, 3 Wire, Receptacle	Two (2) Three Way Switches	* Three Way Switch, Tamper-Resistant, 2 Pole, 3 Wire, Receptacle
Termination	Self-Grounding, Side Wire	Self-Grounding, Side Wire	Self-Grounding, Side Wire
Rating	15A 120V (switch) 15A 125V (recept.) NEMA 5-15R	15A 120-277V AC	15A 120V (switch) 15A 125V (recept.) NEMA 5-15R
Black	RCD108BKTR	RCD303BK	RCD308BKTR
Gray	RCD108GYTR	—	RCD308GYTR
Ivory	RCD108ITR	RCD303I	RCD308ITR
Light Almond	RCD108LATR	RCD303LA	RCD308LATR
White	RCD108WTR	RCD303W	RCD308WTR

Description	Single Pole Switch, Pilot Light, Clear Lens, Amber Neon Bulb	Three Way Switch, Pilot Light, Clear Lens, Amber Neon Bulb	Nightlight Only
Termination	Self-Grounding, Side Wire	Self-Grounding, Side Wire	Self-Grounding, 6" Pre-wired Stranded Wire, 1/2" Stripped Ends
Rating	15A 120V	15A 120V	120V
Ivory	RCD109I**	RCD309I**	DD100NLIV**
Light Almond	RCD109LA**	RCD309LA**	DD100NLLA**
White	RCD109W**	RCD309W**	DD100NLWH**

Note: See page Tech-10 for Tamper-Resistant description.

**Requires neutral wire.

Pilot Light Wiring Diagram

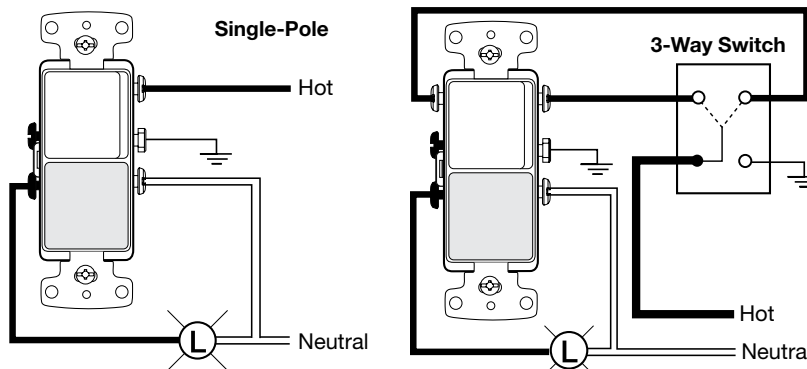

Dimensions in Inches (mm)

Decorator Weather Resistant, Tamper-Resistant, Standard and Single Receptacles

Decorator Duplex Receptacles, 2 Pole, 3 Wire

Description	* *	*	
	Weather and Tamper-Resistant	Tamper-Resistant	Standard
Termination	Self-Grounding, Push and Side Wire	Self-Grounding, Push and Side Wire	Push and Side Wire
Rating	15A 125V NEMA 5-15R	15A 125V NEMA 5-15R	15A 125V NEMA 5-15R
Black	RRD15SBKWRTR	RRD15SBKTR	RRD15BK
Brown	RRD15SWRTR	RRD15STR	RRD15
Gray	RRD15SGYWRTR	RRD15SGYTR	RRD15GY
Ivory	RRD15SIWRTR	RRD15SITR	RRD15I
Light Almond	RRD15SLAWRTR	RRD15SLATR	RRD15LA
White	RRD15SWWRTR	RRD15SWTR	RRD15W

Description	*
	Tamper-Resistant, Nightlight Receptacle
Termination	Self-Grounding, Two Nightlight Sources for 0.5 Lumens Total, Back and Side Wired
Rating	15A 125V NEMA 5-15R
Black	—
Brown	—
Gray	—
Ivory	DR15NLIV
Light Almond	DR15NLLA
White	DR15NLWH

Note: See page Tech-10 for Weather and Tamper-Resistant descriptions.
 **100 per case, bulk packed. Mounting screws inserted into strap.

Decorator Single Receptacles, 2 Pole, 3 Wire

Description	*	*
	Tamper-Resistant	Tamper-Resistant
Termination	Self-Grounding, Side Wire	Self-Grounding, Side Wire
Rating	15A 125V NEMA 5-15R	20A 125V NEMA 5-20R
Black	RRD151BKTR	RRD201BKTR
Brown	RRD151TR	RRD201TR
Gray	RRD151GYTR	RRD201GYTR
Ivory	RRD151ITR	RRD201ITR
Light Almond	RRD151LATR	RRD201LATR
White	RRD151WTR	RRD201WTR

Description	Standard	Standard
	Termination	Self-Grounding, Side Wire
Rating	15A 250V NEMA 6-15R	20A 250V NEMA 6-20R
Black	RRD155BK	RRD205BK
Brown	RRD155	RRD205
Gray	RRD155GY	RRD205GY
Ivory	RRD155I	RRD205I
Light Almond	RRD155LA	RRD205LA
White	RRD155W	RRD205W

Note: See page Tech-10 for Tamper-Resistant description.

Weather Resistant Recessed Receptacle with While-In Use Cover

Description	Housing Color	Horizontal Mount	Vertical Mount
	Weather and tamper-resistant duplex receptacle with clear while-in-use cover, 15A 125V	Gray	RW15300GY
White		RW15300W	RW15400W
Brown		RW15300BR	RW15400BR



RRD15SWTR



RRD15SW



DR15NLWH



RRD151W



RRD205W



RW15400GY

Dimensions in Inches (mm)

tradeSELECT® Products

Features and Benefits

USB Charger Receptacles and Outlets

Hubbell's new fast charging USB-C Power Delivery receptacles provide more power. Users can quickly charge laptops and other large devices. The USB-C port marked PD (Power Delivery) provides up to 55 Watt of output. The additional Type-C or Type-A port delivers up to 1.5 Amp, 5 Volt (7.5 Watt) of power.

Common Features

- LED ON to indicate USB and line voltage power available
- USB stainless steel ports rated for minimum 10,000 insertions and removals
- Complies with battery charging specification BC1.2 and 3.0 Power Delivery specifications
- Designed for commercial, industrial and home use
- Compatible with USB 1.1/2.0/3.0 devices, including Apple® products



USB15ACPDW



USB4ACW



Type-C USB Charger

- Two Type C port configurations
- USB-C PD port (up to 20 Volt, 55 Watt output)
- 2nd USB-C convenience port (up to 1.5 Amp, 5 Volt, 7.5 Watt output)
- Heavy duty spec grade
- Tamper resistant commercial grade duplex receptacle



Weather Resistant Type A&C USB Charger

- One Type A and one Type-C port configurations
- Meets Section 406.9 of NEC®
- 5 Amp, 5 Volt USB output
- Power indicating green LED light



Type A&C USB Charger

- One Type A and one Type C port configurations
- USB-C PD port (up to 20 Volt, 55 Watt output)
- 2nd USB-A convenience port (up to 1.5 Amp, 5 Volt, 7.5 Watt output)
- Heavy duty spec grade
- Tamper resistant commercial grade duplex receptacle



4 Port USB Charger

- 4 Port outlet, 5 Amp, 5V DC, Type-C, Type A&C and Type A class 2.0
- Switch activated port door; when open enables power. When closed, all power is switched off, for a "zero" no-load draw



USB Wall Chargers

- Flexible holder to hold phone firmly in place
- Phone can be inserted vertically or horizontally
- Green LED indicates power available and blue LED indicates wireless charging
- Available in combination with 15A or 20A 125V tamper-resistant receptacle with USB



Switch Combo Outlets

- Two USB ports 2.1 Amp, 5 Volt DC, Type A, class 2.0
- Isolated 15 Amp, 120V AC single pole/3-way switch

USB Charger Receptacles and Outlets

Wireless Chargers

Description	Color	Rating	Receptacle	Catalog Number
Wireless wall mount phone charger	White	Coil: 7.5 watt inductive, 125V AC input	-	USB1518



Combination Wireless Chargers

Description	Color	Rating	Receptacle	Catalog Number
Combination wireless wall mount phone charger, inductive coil with USB Type A&C ports, and tamper-resistant receptacle	White	Coil: 7.5 watt inductive, USB: 5A 5V DC Input: 125V AC	15A 125V 20A 125V	USB1528AC USB2028AC



USB-C Power Delivery Charger

Tamper-Resistant Duplex Receptacles

Description	Color	15A 125V	20A 125V
Type-C USB Power Delivery Charger Receptacle, two Type-C port configurations, one USB-C Power Delivery port with up to 55 Watt output and one USB Type-C convenience port with up to 1.5 Amp, 5 Volt USB output.	Black	USB15CPDBK	USB20CPDBK
	Brown	USB15CPD	USB20CPD
	Gray	USB15CPDGY	USB20CPDGY
	Ivory	USB15CPDI	USB20CPDI
	Light Almond	USB15CPDLA	USB20CPDLA
Type A&C USB Power Delivery Charger Receptacle, one Type-A and one Type-C port configurations, one USB-C Power Delivery port with up to 55 Watt output and one USB-A convenience port with up to 1.5 Amp, 5 Volt USB output.	Black	USB15ACPDBK	USB20ACPDBK
	Brown	USB15ACPD	USB20ACPD
	Gray	USB15ACPDGY	USB20ACPDGY
	Ivory	USB15ACPDI	USB20ACPDI
	Light Almond	USB15ACPDLA	USB20ACPDLA
	White	USB15ACPDW	USB20ACPDW



USB1528AC



USB15CPDW



USB15ACPDW

Note: See page Tech-10 for Tamper-Resistant description.
See section L for Hospital grade series.

4 Port USB Charger Outlets



Description	Color	4 Type A ports	2 Type A and 2 Type-C ports	4 Type-C ports
USB Charger Outlets, 4 USB ports, 5 Amp, 5 Volt DC, Style Line® decorator.	Black	USB4BK	USB4ACBK	USB4CBK
	Brown	USB4	USB4AC	USB4C
	Gray	USB4GY	USB4ACGY	USB4CGY
	Ivory	USB4I	USB4ACI	USB4CI
	Light Almond	USB4LA	USB4ACLA	USB4CLA
White	USB4W	USB4ACW	USB4CW	



USB4CBK



USB4C

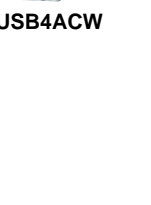

USB4CW

Switch Combo Outlets



Description	Color	Catalog Number
Switch Combo Outlet, two USB type 2.0 ports, 2.1 Amp, 5 Volt DC, Style Line® decorator	Black	USB102BK
	Brown	USB102
	Gray	USB102GY
	Ivory	USB102I
	Light Almond	USB102LA
	White	USB102W



USB102W

Weather Resistant USB Charger Duplex Receptacles

Description	Color	15A 125V	20A 125V
Type A&C USB Charger Receptacle, One Type A and one Type-C port configurations, high power 5 Amp, 5 Volt USB output, Tamper-Resistant USB ports rated 10,000 cycles; Commercial Grade	Black	USB15AC5BKWR	USB20AC5BKWR
	Brown	USB15AC5WR	USB20AC5WR
	Gray	USB15AC5GYWR	USB20AC5GYWR
	Ivory	USB15AC5IWR	USB20AC5IWR
	Light Almond	USB15AC5LAWR	USB20AC5LAWR
	White	USB15AC5WWR	USB20AC5WWR



USB15AC5WWR

Note: Outdoor circuits should be GFCI protected per national and local electric codes.

NEC® is a registered trademark of the National Fire Protection Association (NFPA).

GFCI Receptacles with Auto Grounding

Features

- Patented AUTOGUARD® self test technology includes disconnecting power to the receptacle if critical components are damaged and GFCI protection is lost
- Internal back wiring clamp and guide for quick and secure termination
- Night light option includes light sensor controls for automatic ON and OFF, custom dual lens for optimum light output

Meets UL Standard 943
Class A GFCI



Tamper-Resistant

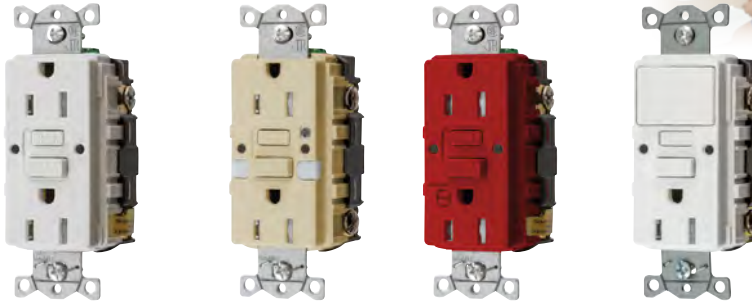

Rating	Color	Standard	Night Light Two LED Night Lights	Alarm	Combination Switch 15A 120V Switch	
	Almond	GFTRST15AL	GFTRST15ALNL	GFTRST15ALB	—	
	Black	GFTRST15BK	GFTRST15BKNL	GFTRST15BKB	—	
	Brown	GFTRST15	GFTRST15NL	GFTRST15B	—	
	Gray	GFTRST15GY	GFTRST15GYNL	GFTRST15GYB	—	
	Ivory	GFTRST15I	GFTRST15INL	GFTRST15IB	GFSPST15I	
	Light Almond	GFTRST15LA	GFTRST15LANL	GFTRST15LAB	GFSPST15LA	
	Red	GFTRST15R	GFTRST15RNL	GFTRST15RB	—	
	White	GFTRST15W	GFTRST15WNL	GFTRST15WB	GFSPST15W	
		Almond	GFTRST20AL	GFTRST20ALNL	GFTRST20ALB	—
		Black	GFTRST20BK	GFTRST20BKNL	GFTRST20BKB	—
Brown		GFTRST20	GFTRST20NL	GFTRST20B	—	
Gray		GFTRST20GY	GFTRST20GYNL	GFTRST20GYB	—	
Ivory		GFTRST20I	GFTRST20INL	GFTRST20IB	—	
Light Almond		GFTRST20LA	GFTRST20LANL	GFTRST20LAB	—	
Red		GFTRST20R	GFTRST20RNL	GFTRST20RB	—	
White		GFTRST20W	GFTRST20WNL	GFTRST20WB	—	



Tamper-Resistant Weather Resistant



Rating	Color	Standard	Isolated Ground	
	Almond	GFTWRST15AL	GFTWRST15ALIG	
	Black	GFTWRST15BK	GFTWRST15BKIG	
	Brown	GFTWRST15	GFTWRST15IG	
	Gray	GFTWRST15GY	GFTWRST15GYIG	
	Ivory	GFTWRST15I	GFTWRST15IIG	
	Light Almond	GFTWRST15LA	GFTWRST15LAIG	
	Red	GFTWRST15R	GFTWRST15RIG	
	White	GFTWRST15W	GFTWRST15WIG	
		Almond	GFTWRST20AL	GFTWRST20ALIG
		Black	GFTWRST20BK	GFTWRST20BKIG
Brown		GFTWRST20	GFTWRST20IG	
Gray		GFTWRST20GY	GFTWRST20GYIG	
Ivory		GFTWRST20I	GFTWRST20IIG	
Light Almond		GFTWRST20LA	GFTWRST20LAIG	
Red		GFTWRST20R	GFTWRST20RIG	
White		GFTWRST20W	GFTWRST20WIG	

Note: See page Tech-10 for Weather and Tamper-Resistant descriptions.
See section K for complete Hubbell GFCI offering.

Recessed Receptacles and AV Wallboxes

Hubbell has solutions for residential environments where wire management is a concern. Products sit flush against the wall and are available in multiple colors, creating an aesthetically pleasing look. Large connectors and cables are held securely and bundled together neatly. Wires are concealed behind the wall and out of view. Snap Fit options are used for customizing your connections.

Features

Receptacles

- Snap Fit is configurable to accommodate multiple connectors such as: HDMI, AV and Voice/Low-speed data
- Feed-through options allows you to make direct connections

Boxes

- Available in plastic or metal boxes to accommodate local building requirements



Recessed Receptacle with Feed-Through

Metal Wallbox with Divider



RR1510I



RR1512I



RR1514I



NSAV1I



NSAV2I

Recessed Receptacles

Color	15A 125V, Tamper-Resistant Duplex Receptacle		
	1-Gang	2-Gang with Feed-Through	2-Gang with Snap Fit
Ivory	RR1510I	RR1512I	RR1514I
Light Almond	RR1510LA	RR1512LA	RR1514LA
White	RR1510W	RR1512W	RR1514W

Feed-Through Plates

Color	1-Gang	2-Gang
Ivory	NSAV1I*	NSAV2I*
White	NSAV1W*	NSAV2W*

Note: *Not UL Listed.

Two and Three Gangable AV Wallboxes



HBL985



HBL986



HBL989

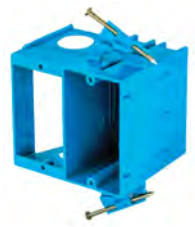

RR1500

Box	Dimensions			Top Knockouts	Bottom Knockouts	Back Knockouts	Catalog Number
	Height	Width	Depth				
2-Gang, 2" KO, 54 in ³ capacity	4.21" (107)	4.06" (103)	4.0" (102)	(2) 1/2" (2) 1/2" - 3/4" TKO*	(1) 1", 1 1/4", 1 1/2" and 2"	(2) 1/2" - 3/4" TKO	HBL985
3-Gang, 2" KO, 79 in ³ capacity	4.21" (107)	5.87" (149)	4.0" (102)	(3) 1/2" (3) 1/2" - 3/4" TKO*	(1) 1/2", (1) 1/2" - 3/4" TKO* (1) 1", 1 1/4", 1 1/2" and 2"	(3) 1/2" - 3/4" TKO	HBL986

Note: *TKO (Tangential Knockout).

Wallbox

Description	Color	Catalog Number
2-Gang, nail-on box, thermoplastic	Blue	RR1500

Low Voltage AV Wallbox Partitions

Compatible With	Description	Quantity	Catalog Number
HBL985 and HBL986	Solid divider	1	HBL989
	With pass-through capability	1	HBL989AVD

Dimensions in Inches (mm)

Decorator Frames and Modular Snap Fit Jacks

Decorator Frames



Color	1-Gang, 1-Port	1-Gang, 2-Port	1-Gang, 3-Port	1-Gang, 4-Port	1-Gang, 6-Port	1-Gang, Adapter .406" (10.30) Dia. Hole*	1-Gang, Adapter Blank**
Black	NS611BK	NS612BK	NS613BK	NS614BK	NS616BK	—	NS620BK
Gray	NS611GY	NS612GY	NS613GY	NS614GY	NS616GY	—	NS620GY
Ivory	NS611I	NS612I	NS613I	NS614I	NS616I	NS621I	NS620I
Light Almond	NS611LA	NS612LA	NS613LA	NS614LA	NS616LA	NS621LA	NS620LA
White	NS611W	NS612W	NS613W	NS614W	NS616W	NS621W	NS620W

Note: *For use with rotary dimmers or to pull through AV or telephone cable.
 **To fill an extra decorator opening or to create customized openings.

Molded-In Voice/Low-Speed Data - Modular Snap Fit



Category 6 Jack



Category 5e Jack



USOC Jack

Color	Category 6 Jack		Category 5e Jack		USOC Jack
	(single)	(25 pack)	(single)	(25 pack)	(single)
Black	NSJ6BK	NSJ6BK25	NSJ5EBK	NSJ5EBK25	NSJUBK
Blue	NSJ6B	NSJ6B25	NSJ5EB	NSJ5EB25	NSJUB
Gray	NSJ6GY	NSJ6GY25	NSJ5EGY	NSJ5EGY25	NSJUGY
Green	NSJ6GN	NSJ6GN25	NSJ5EGN	NSJ5EGN25	NSJUGN
Ivory	NSJ6I	NSJ6I25	NSJ5EI	NSJ5EI25	NSJUI
Light Almond	NSJ6LA	NSJ6LA25	NSJ5ELA	NSJ5ELA25	NSJULA
Orange	NSJ6OR	NSJ6OR25	NSJ5EOR	NSJ5EOR25	NSJUOR
Red	NSJ6R	NSJ6R25	NSJ5ER	NSJ5ER25	NSJUR
White	NSJ6W	NSJ6W25	NSJ5EW	NSJ5EW25	NSJUW
Yellow	NSJ6Y	NSJ6Y25	NSJ5EY	NSJ5EY25	NSJUY

HDMI 1.4 Connectors



HDMI Keystone Feed-Through for IMB and ISFB Series

Color	
Black	SFHC14BK
White	SFHC14W

Audio/Video Connectors - Standard Bulkhead



Nickel F-Type Coupler Bulkhead, Female to Female



Gold F-Type Coupler Bulkhead, Female to Female



RCA Gold Pass-Through, Female to Female, Red Interior



RCA Gold Pass-Through, Female to Female, White Interior



RCA Gold Pass-Through, Female to Female, Yellow Interior



RCA Gold Pass-Through, Female to Female, Blue Interior



RCA Gold Pass-Through, Female to Female, Green Interior

Color	Nickel F-Type Coupler Bulkhead, Female to Female	Gold F-Type Coupler Bulkhead, Female to Female	RCA Gold Pass-Through, Female to Female, Red Interior	RCA Gold Pass-Through, Female to Female, White Interior	RCA Gold Pass-Through, Female to Female, Yellow Interior	RCA Gold Pass-Through, Female to Female, Blue Interior	RCA Gold Pass-Through, Female to Female, Green Interior
Black	NSF70BK	SFFGBK	SFRCRFFBK	SFRCWFFBK	SFRCYFFBK	SFRCBFFBK	SFRCGNFFBK
Gray	NSF70GY	SFFGGY	SFRCRFFGY	SFRCWFFGY	SFRCYFFGY	SFRCBFFGY	SFRCGNFFGY
Ivory	NSF70I	SFFGEI	SFRCRFFEI	SFRCWFFEI	SFRCYFFEI	SFRCBFFEI	SFRCGNFFEI
Light Almond	NSF70LA	SFFGLA	SFRCRFFLA	SFRCWFFLA	SFRCYFFLA	SFRCBFFLA	SFRCGNFFLA
White	NSF70W	SFFGW	SFRCRFFW	SFRCWFFW	SFRCYFFW	SFRCBFFW	SFRCGNFFW

Audio/Video Connectors - Recessed



Gold F-Type Coupler Bulkhead, Female to Female



RCA Gold Pass-Through, Female to Female, Red Interior



RCA Gold Pass-Through, Female to Female, White Interior



RCA Gold Pass-Through, Female to Female, Yellow Interior



RCA Gold Pass-Through, Female to Female, Blue Interior



RCA Gold Pass-Through, Female to Female, Green Interior



Blank Insert

Color	Gold F-Type Coupler Bulkhead, Female to Female	RCA Gold Pass-Through, Female to Female, Red Interior	RCA Gold Pass-Through, Female to Female, White Interior	RCA Gold Pass-Through, Female to Female, Yellow Interior	RCA Gold Pass-Through, Female to Female, Blue Interior	RCA Gold Pass-Through, Female to Female, Green Interior	Blank Insert
Black	SFGRFBK	SFRCRRBK	SFRCWRBK	SFRCYRBK	SFRCBRBK	SFRCGNRBK	SFSBBK10*
Gray	SFGRFGY	SFRCRRGY	SFRCWRGY	SFRCYRGY	SFRCBRGY	SFRCGNRGY	SFSBGY10*
Ivory	SFGRFEI	SFRCRREI	SFRCWREI	SFRCYREI	SFRCBREI	SFRCGNREI	SFSBEI10*
Light Almond	SFGRFLA	SFRCRRLA	SFRCWRLA	SFRCYRLA	SFRCBRLA	SFRCGNRLA	SFSBLA10*
White	SFGRFW	SFRCRRW	SFRCWRW	SFRCYRW	SFRCBRW	SFRCGNRW	SFSBW10*

Note: *Sold in a package of 10. Order 1 to receive a bag of 10 blanks.

Dimensions in Inches (mm)

Molded-In Voice/Data/Video

Features

Designed to complement decorator styling, these jacks offer voice and Cat. 5e devices to fit within a decorator wallplate.

- High impact-resistant thermoplastic frame
- Meets FCC part 68
- UL Listed 1863 - Communication Circuit Accessory and CSA Certified

Molded-In Voice/Low-Speed Data

Description	Decorator Frame, One RJ11 Jack, 6-Position, 4-Conductor	Decorator Frame, One RJ11 Jack, 6-Position, 6-Conductor	Decorator Frame, Duplex RJ11 Jacks, 6-Position, 6-Conductor	Decorator Frame, One Cat. 5e One RJ11 Jack, 6-Position, 4-Conductor
Termination	Screw Terminations	Screw Terminations	Screw Terminations	110 Punch-Down
Color				
Black	NS770BK	—	—	NS784BK
Brown	NS770	NS771	—	NS784
Gray	NS770GY	—	—	NS784GY
Ivory	NS770I	NS771I	NS772I	NS784I
Light Almond	NS770LA	NS771LA	NS772LA	NS784LA
White	NS770W	NS771W	NS772W	NS784W

Features

Coaxial video and combination jacks complement multimedia needs in a 1-gang decorator opening.

- High impact-resistant thermoplastic frame
- Jacks meet FCC part 68
- UL Listed 1863 - Communication Circuit Accessory and CSA Certified

Molded-In Voice/Low-Speed Data

Description	Decorator Frame, Single F-Type Coupler Bulkhead, Female to Female	Decorator Frame, One RJ11 Jack, 6-Position, 4-Conductor, One F-Type Coupler Bulkhead, Female to Female	Decorator Frame, One Cat. 5e One F-Type Coupler Bulkhead, Female to Female
Termination	Screw Terminations	Screw Terminations	110 Punch-Down
Color			
Black	—	—	NS785BK
Brown	—	—	NS785
Gray	—	—	NS785GY
Ivory	NS780I	NS783I	NS785I
Light Almond	NS780LA	NS783LA	NS785LA
White	NS780W	NS783W	NS785W

Dimensions in Inches (mm)

Plastic and Metal Wallplates

More Style In a Snap

Snap-on wallplates offer a clean, elegant look that can be installed in seconds. Screw the mounting plate onto the device and press the snap-on cover into place. Snaps securely hold the cover to the sub-plate.

- Clean, elegant look
- No visible screws
- Snap-on cover plate completely covers sub-plate eliminating dirt build-up around the edges
- Snap-on cover plate hides any paint or scratches on sub-plate caused during installation
- Appearance is consistent with other Hubbell wallplates
- Meets UL and CSA standards



Snap-On Wallplates

Color	1-Gang, 1-Decorator	1-Gang, 1-Duplex	1-Gang, 1-Toggle	2-Gang, 2-Decorator	2-Gang, 2-Toggle	3-Gang, 3-Decorator	3-Gang, 3-Toggle	4-Gang, 4-Decorator
Ivory	NPS26I	NPS8I	NPS1I	NPS262I	NPS2I	NPS263I	NPS3I	NPS264I
Light Almond	NPS26LA	NPS8LA	NPS1LA	NPS262LA	NPS2LA	NPS263LA	NPS3LA	NPS264LA
White	NPS26W	NPS8W	NPS1W	NPS262W	NPS2W	NPS263W	NPS3W	NPS264W

Decorator, Screw-On, Standard, Nylon Wallplates

Color	1-Gang, 1-Decorator	2-Gang, 2-Decorator	3-Gang, 3-Decorator	4-Gang, 4-Decorator	5-Gang, 5-Decorator	6-Gang, 6-Decorator
Black	NP26BK	NP262BK	NP263BK	NP264BK	NP265BK	NP266BK
Brown	NP26	NP262	NP263	NP264	NP265	NP266
Gray	NP26GY	NP262GY	NP263GY	NP264GY	NP265GY	NP266GY
Ivory	NP26I	NP262I	NP263I	NP264I	NP265I	NP266I
Light Almond	NP26LA	NP262LA	NP263LA	NP264LA	NP265LA	NP266LA
White	NP26W	NP262W	NP263W	NP264W	NP265W	NP266W

Decorator, Screw-On, Mid-Size, Nylon Wallplates

	1-Gang, 1-Decorator	2-Gang, 2-Decorator	3-Gang, 3-Decorator	4-Gang, 4-Decorator	5-Gang, 5-Decorator	6-Gang, 6-Decorator
Color	1-Gang, 1-Decorator	2-Gang, 2-Decorator	3-Gang, 3-Decorator	4-Gang, 4-Decorator	5-Gang, 5-Decorator	6-Gang, 6-Decorator
Black	NPJ26BK	NPJ262BK	NPJ263BK	NPJ264BK	—	—
Brown	NPJ26	NPJ262	NPJ263	NPJ264	—	—
Gray	NPJ26GY	NPJ262GY	NPJ263GY	NPJ264GY	—	—
Ivory	NPJ26I	NPJ262I	NPJ263I	NPJ264I	—	—
Light Almond	NPJ26LA	NPJ262LA	NPJ263LA	NPJ264LA	—	—
White	NPJ26W	NPJ262W	NPJ263W	NPJ264W	—	—

Decorator, Screw-On, Mid-Size, Metal Wallplates

	1-Gang, 1-Decorator	2-Gang, 2-Decorator	3-Gang, 3-Decorator	4-Gang, 4-Decorator	5-Gang, 5-Decorator	6-Gang, 6-Decorator
Material	1-Gang, 1-Decorator	2-Gang, 2-Decorator	3-Gang, 3-Decorator	4-Gang, 4-Decorator	5-Gang, 5-Decorator	6-Gang, 6-Decorator
Brass	SB26	SB262	—	—	—	—
Brass Plated	SBP26	SBP262	SBP263	—	—	—
Chrome	SCH26	SCH262	—	—	—	—
S/S 302/304	SS26	SS262	SS263	SS264	SS265	SS266
S/S 430	SS26L	SS262L	—	—	—	—

Note: See section O for complete selection of wallplates.

Combination Wallplates

Combination, Nylon, Standard Wallplates

Color	2-Gang, 1-Toggle 1-Decorator	2-Gang, 1-Duplex, 1-Decorator	2-Gang, 1-Blank Box Mount 1-Decorator	3-Gang, 2-Toggle 1-Decorator	3-Gang, 1-Toggle 2-Decorator	4-Gang, 3-Toggle 1-Decorator	4-Gang, 2-Toggle 2-Decorator
Black	NP126BK	NP826BK	NP1326BK	NP226BK	NP1262BK	NP326BK	NP2262BK
Brown	NP126	NP826	NP1326	NP226	NP1262	NP326	NP2262
Gray	NP126GY	NP826GY	NP1326GY	NP226GY	NP1262GY	NP326GY	NP2262GY
Ivory	NP126I	NP826I	NP1326I	NP226I	NP1262I	NP326I	NP2262I
Light Almond	NP126LA	NP826LA	NP1326LA	NP226LA	NP1262LA	NP326LA	NP2262LA
White	NP126W	NP826W	NP1326W	NP226W	NP1262W	NP326W	NP2262W

Combination, Nylon, Mid-Size Wallplates

Color	2-Gang, 1-Toggle 1-Decorator	2-Gang, 1-Duplex, 1-Decorator	2-Gang, 1-Blank Box Mount 1-Decorator	3-Gang, 2-Toggle 1-Decorator	3-Gang, 1-Toggle 2-Decorator	4-Gang, 3-Toggle 1-Decorator	4-Gang, 2-Toggle 2-Decorator
Black	NPJ126BK	NPJ826BK	—	NPJ226BK	—	—	—
Brown	NPJ126	NPJ826	NPJ1326	NPJ226	—	—	—
Gray	NPJ126GY	NPJ826GY	—	NPJ226GY	—	—	—
Ivory	NPJ126I	NPJ826I	NPJ1326I	NPJ226I	—	—	—
Light Almond	NPJ126LA	NPJ826LA	NPJ1326LA	NPJ226LA	—	—	—
White	NPJ126W	NPJ826W	NPJ1326W	NPJ226W	—	—	—

Combination, Standard, Metal Wallplates

Material	2-Gang, 1-Toggle 1-Decorator	2-Gang, 1-Duplex, 1-Decorator	2-Gang, 1-Blank Strap Mount 1-Decorator	3-Gang, 2-Toggle 1-Decorator	3-Gang, 1-Toggle 2-Decorator	4-Gang, 3-Toggle 1-Decorator	4-Gang, 2-Toggle 2-Decorator
Brass	SB126	SB826	—	—	—	—	—
Brass Plated	SBP126	—	—	—	—	—	—
Chrome	—	—	—	—	—	—	—
SS 302/304	SS126	SS826	SS1426	SS226	—	SS326	—
SS 430	SS126L	—	—	—	—	—	—

Note: See section O for complete selection of wallplates.

Dimensions

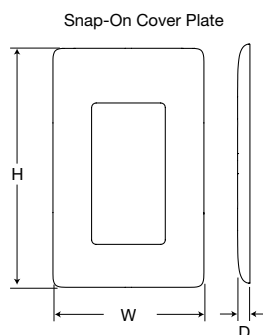

Gang	Height (H)	Width (W)	Depth (D)
1	4.75" (120.6)	3.00" (76.2)	.25" (6.2)
2	4.75" (120.6)	4.81" (122.2)	.25" (6.2)
3	4.75" (120.6)	6.62" (168.2)	.25" (6.2)
4	4.75" (120.6)	8.44" (214.3)	.25" (6.2)

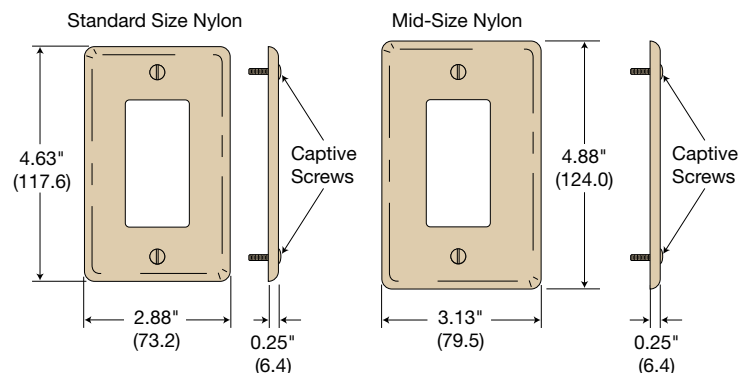

Dimensions in Inches (mm)

Toggle Switches

Features



Standard toggle switches provide the basic ON/OFF control for home lighting and appliances.

- Tough thermoplastic with ultrasonically welded cover and base
- Elongated strap for easier wall box mounting
- Quiet snap action mechanism
- Multiple-drive Slot/Phillips/Robertson head screws
- Hi-visibility yellow base for easy installation
- Operating temperature: -20°C to 60°C
- UL Listed, CSA Certified





RS115W

Single Pole Toggle Switches

Description	Single Pole	Single Pole, Illuminated
Termination	Grounding, Push and Side Wire	Self-Grounding, Push and Side Wire
Rating	15A 120V AC	15A 120V AC
		
Color		
Clear	—	RS115ILC
Black	RS115BK	—
Brown	RS115	—
Ivory	RS115I	RS115ILI*
Light Almond	RS115LA	RS115ILLA*
White	RS115W	RS115ILW*

Note: *Frame is clear and illuminates, toggle is colored. Does not require a neutral wire.

Three and Four Way Toggle Switches

Description	Three Way	Three Way, Illuminated	Four Way
Termination	Grounding, Push and Side Wire	Self-Grounding, Push and Side Wire	Self-Grounding, Side Wire
Rating	15A 120V AC	15A 120V AC	15A 120V AC
			
Color			
Clear	—	RS315ILC	—
Black	RS315BK	—	—
Brown	RS315	—	RS415
Ivory	RS315I	RS315ILI*	RS415I
Light Almond	RS315LA	RS315ILLA*	RS415LA
White	RS315W	RS315ILW*	RS415W

Note: *Frame is clear and illuminates, toggle is colored. Does not require a neutral wire.

Dimensions in Inches (mm)

Combination Switches/Devices

Features

Mini-toggles provide for multiple switches in a compact single gang. Maximize control while maintaining function and appearance.

- Low profile, less than 1 inch
- Self-grounding feature is standard
- Combination devices provide compact switches in a single-gang opening
- Smooth toggle action
- Multiple-drive Slot/Phillips/Robertson head screws
- Hi-visibility yellow base for easy installation
- Operating temperature: -20°C to 60°C
- UL Listed, CSA Certified



RC108I

Combination Toggle Switches/Devices

Description	Two (2) Single Pole Switches	Single Pole Switch, Tamper-Resistant, 2 Pole, 3 Wire, Receptacle	Single Pole Switch, 2 Pole, 3 Wire, Receptacle	Single Pole Switch, Pilot Light, Clear Lens, Amber Neon Bulb*
Termination	Self-Grounding, Side Wire	Self-Grounding, Side Wire	Self-Grounding, Side Wire	Self-Grounding, Side Wire
Rating	15A 120V AC	15A 120V (switch) 15A 125V (recept.) NEMA 5-15R	15A 120V (switch) 15A 125V (recept.) NEMA 5-15R	15A 120V AC
Color				
Brown	RC101	RC108TR	RC108	RC109
Ivory	RC101I	RC108ITR	RC108I	RC109I
Light Almond	RC101LA	RC108LATR	RC108LA	RC109LA
White	RC101W	RC108WTR	RC108W	RC109W

Note: See page Tech-10 for Tamper-Resistant description.
*Neutral required for pilot light, see page Z-4 for wiring diagram.

Combination Toggle Switches/Devices

Description	Single Pole and Three Way Switch	Two (2) Three Way Switches	Three Way Switch, Tamper-Resistant, 2 Pole, 3 Wire, Receptacle	Three Way Switch, 2 Pole, 3 Wire, Receptacle	Three Way Switch, Pilot Light, Clear Lens, Amber Neon Bulb*
Termination	Self-Grounding, Side Wire	Self-Grounding, Side Wire	Self-Grounding, Side Wire	Self-Grounding, Side Wire	Self-Grounding, Side Wire
Rating	15A 120V AC	15A 120V AC	15A 120V (switch) 15A 125V (recept.) NEMA 5-15R	15A 120V (switch) 15A 125V (recept.) NEMA 5-15R	15A 120V AC
Color					
Brown	RC103	RC303	RC308TR	RC308	RC309
Ivory	RC103I	RC303I	RC308ITR	RC308I	RC309I
Light Almond	RC103LA	RC303LA	RC308LATR	—	—
White	RC103W	RC303W	RC308WTR	RC308W	RC309W

Note: See page Tech-10 for Tamper-Resistant description.
*Neutral required for pilot light, see page Z-4 for wiring diagram.

Dimensions in Inches (mm)

XClamp and Duplex Receptacles

Features

- Eliminates the need to loop the wire
- External back-wire clamp for fast and easy installation of 15A & 20A branch circuits in residential applications
- Compression plates maximize holding power to provide a stronger, more secure connection
- Terminate up to 8 wires
- Accommodates #12 & #14 AWG wire
- Break-off tabs for switched receptacle applications
- Tamper-resistant shutter complies with NEC®

Best Solution for Residential 15A & 20A Branch Circuit Wiring

Fast and Secure

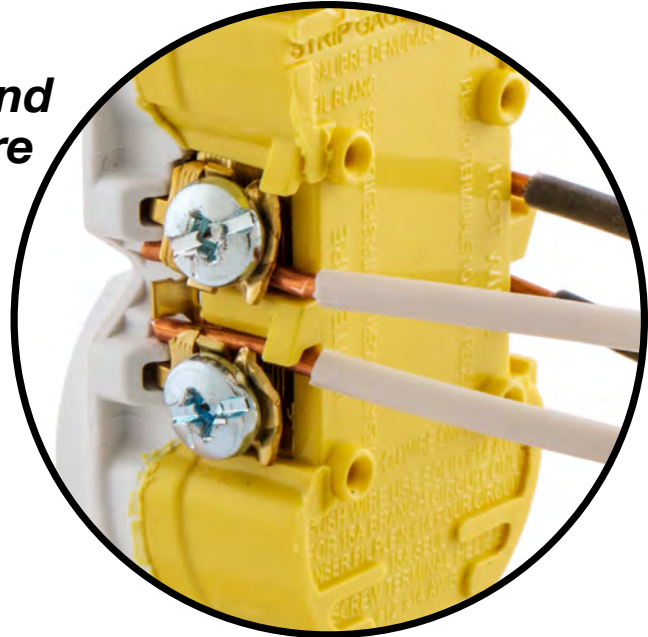

- 1** Strip the wire
- 2** Insert the wire
- 3** Clamp the connection



RR15SWTRX

XClamp Duplex Receptacles

Description	Color	Catalog Number
Tamper-Resistant, 15A 125V, 2 Pole, 3 Wire Grounding, 20A Circuit Rated	Ivory Light Almond White	RR15SITRX RR15SLATRX RR15SWTRX

Listings

UL listed to UL498 File No. E2186
Certified to CSA C22.2, No. 42
NEMA® WD-6 Compliant

Duplex Receptacles, 2 Pole, 3 Wire



RR15W

RR15QW

Description	Tamper-Resistant, Quick Thread	Standard	Weather and Tamper-Resistant	Tamper-Resistant
	Termination	Self-Grounding, Push and Side Wire	Grounding, Push and Side Wire	Self-Grounding, Push and Side Wire
Rating	15A 125V NEMA 5-15R	15A 125V NEMA 5-15R	15A 125V NEMA 5-15R	15A 125V NEMA 5-15R
Black	—	RR15BK	RR15SBKWRTR	RR15SBKTR
Brown	—	RR15	RR15SWRTR	RR15STR
Gray	—	—	RR15SGYWRTR	—
Ivory	RR15QITR	RR15I	RR15SIWRTR	RR15SITR
Light Almond	RR15QLATR	RR15LA	RR15SLAWRTR	RR15SLATR
White	RR15QWTR	RR15W	RR15SWWRTR	RR15SWTR

NEC® is a registered trademark of the National Fire Protection Association (NFPA).

Singles, Range and Dryer Power Receptacles and Plugs

Single Receptacles, 2 Pole, 3 Wire

	Weather and Tamper-Resistant	Tamper-Resistant	Standard	Weather Resistant	Standard
Description	Weather and Tamper-Resistant	Tamper-Resistant	Standard	Weather Resistant	Standard
Termination	Self-Grounding, Side Wire	Self-Grounding, Side Wire	Self-Grounding, Side Wire	Self-Grounding, Side Wire	Self-Grounding, Side Wire
Rating	15A 125V NEMA 5-15R	15A 125V NEMA 5-15R	15A 125V NEMA 5-15R	15A 250V NEMA 6-15R	15A 250V NEMA 6-15R
Black	RR151BKWRTR	RR151BKTR	RR151BK	RR155BKWR	RR155BK
Brown	RR151WRTR	RR151TR	RR151	RR155WR	RR155
Gray	RR151GYWRTR	RR151GYTR	RR151GY	RR155GYWR	RR155GY
Ivory	RR151IWRTR	RR151ITR	RR151I	RR155IWR	RR155I
Light Almond	RR151LAWRTR	RR151LATR	RR151LA	RR155LAWR	RR155LA
White	RR151WWRTR	RR151WTR	RR151W	RR155WWR	RR155W



	Weather and Tamper-Resistant	Tamper-Resistant	Standard	Weather Resistant	Standard
Description	Weather and Tamper-Resistant	Tamper-Resistant	Standard	Weather Resistant	Standard
Termination	Self-Grounding, Side Wire	Self-Grounding, Side Wire	Self-Grounding, Side Wire	Self-Grounding, Side Wire	Self-Grounding, Side Wire
Rating	20A 125V NEMA 5-20R	20A 125V NEMA 5-20R	20A 125V NEMA 5-20R	20A 250V NEMA 6-20R	20A 250V NEMA 6-20R
Black	RR201BKWRTR	RR201BKTR	RR201BK	RR205BKWR	RR205BK
Brown	RR201WRTR	RR201TR	RR201	RR205WR	RR205
Gray	RR201GYWRTR	RR201GYTR	RR201GY	RR205GYWR	RR205GY
Ivory	RR201IWRTR	RR201ITR	RR201I	RR205IWR	RR205I
Light Almond	RR201LAWRTR	RR201LATR	RR201LA	RR205LAWR	RR205LA
White	RR201WWRTR	RR201WTR	RR201W	RR205WWR	RR205W



Note: See page Tech-10 for Weather and Tamper-Resistant descriptions.

Range and Dryer Power Receptacles

	30A 125/250V NEMA 14-30R UL/CSA	50A 125/250V NEMA 14-50R UL/CSA	30A 125/250V NEMA 10-30R UL/CSA	50A 125/250V NEMA 10-50R UL/CSA
Description	Flush Mount for 1- or 2-Gang Box	Flush Mount for 1- or 2-Gang Box	Flush Mount for 1- or 2-Gang Box	Flush Mount for 1- or 2-Gang Box
Rating	30A 125/250V 3 Pole, 4 Wire with Ground	50A 125/250V 3 Pole, 4 Wire with Ground	30A 125/250V 3 Pole, 3 Wire without Ground	50A 125/250V 3 Pole, 3 Wire without Ground
Black	RR430F	RR450F	RR330F*	RR350F*
White	RR430FW	RR450FW	—	—
White w/ plate	RR430WIPCN	—	—	—
Description	Surface Mount	Surface Mount	Surface Mount	Surface Mount
Rating	30A 125/250V 3 Pole, 4 Wire with Ground	50A 125/250V 3 Pole, 4 Wire with Ground	30A 125/250V 3 Pole, 3 Wire without Ground	50A 125/250V 3 Pole, 3 Wire without Ground
Black	RR430	RR450	RR330*	RR350*
Description	Panel Mount	Panel Mount	Panel Mount	Panel Mount
Rating	30A 125/250V 3 Pole, 4 Wire with Ground	50A 125/250V 3 Pole, 4 Wire with Ground	—	—
Black	RR430PM	RR450PM	—	—

Note: *For replacement use only.

Range and Dryer Power Angled Plugs

	30A 125/250V NEMA 14-30R UL/CSA	50A 125/250V NEMA 14-50R UL/CSA	30A 125/250V NEMA 10-30R UL/CSA	50A 125/250V NEMA 10-50R UL/CSA
Description	With Interchangeable Blades for 30 or 50 Amp		With Interchangeable Blades for 30 or 50 Amp	
Rating	30/50A 125/250V 3 Pole, 4 Wire with Ground		30/50A 125/250V 3 Pole, 3 Wire without Ground	
Black	RR435P		RR335P	



Special Use Products



RW15400GY

Weather Resistant Recessed Receptacle with While-In Use Cover

Description	Housing Color	Horizontal Mount	Vertical Mount
Weather and tamper-resistant duplex receptacle with clear while-in-use cover, 15A 125V	Gray	RW15300GY	RW15400GY
	White	RW15300W	RW15400W
	Brown	RW15300BR	RW15400BR



RR151CHWTR



Special Use Products

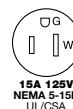

Description	Color	Tamper-Resistant	Tamper-Resistant
Clock Hanger/Recessed Single Receptacle, Tamper-Resistant, 2 pole, 3 wire, grounding, side wire terminations	Brass	RR151CHBSTR	RR201CHBSTR
	Stainless Steel	RR151CHSSTR	RR201CHSSTR
	Ivory (Nylon)	RR151CHITR	RR201CHITR
	White (Nylon)	RR151CHWTR	RR201CHWTR
Recessed Duplex Receptacle, Tamper-Resistant, 2 pole, 3 wire, grounding, side wire terminations	Ivory	RR1510I	—
	Light Almond	RR1510LA	—
	White	RR1510W	—
JLOAD® Multimedia Outlet, Provides power, Cat. 5e and coaxial in a single gang box. Requires RJ600 Box. Includes decorator frame, one Cat. 5e, one F-connector and one power receptacle 125V with voltage dividers*.	Black	RJ650BKTR	RJ620BKTR
	Gray	RJ650GYTR	RJ620GYTR
	Ivory	RJ650ITR	RJ620ITR
	Light Almond	RJ650LATR	RJ620LATR
	White	RJ650WTR	RJ620WTR
JLOAD® Multimedia Outlet, Includes decorator frame with two open ports for custom configuration and one power receptacle 125V with voltage dividers*.	Black	RJ65BKTR	RJ62BKTR
	Gray	RJ65GYTR	RJ62GYTR
	Ivory	RJ65ITR	RJ62ITR
	Light Almond	RJ65LATR	RJ62LATR
	White	RJ65WTR	RJ62WTR
JLOAD® Multimedia Box, 3 inches deep with seven ½-inch knockouts, non-metallic sheathed cable clamps on each side. Screw in mounting to stud.	Steel	RJ600	RJ600



RR1510W

RJ650BKTR



Dividers



RJ600

Note: *Dividers provided for use with the RJ600, RF515 series and RU200 series boxes. RF408 required for use with the RF400 series floor boxes.

See page Z-10 for snap fit inserts.

See pages Z-21 to Z-26 for floor boxes and under cabinet power distribution options.

See page Tech-10 for Tamper-Resistant description.



RS100W



RS101W

In-Line Cord Switches

Description	Mini For Use with Flat Lamp Cord	Heavy Duty
Rating	6A 125V AC	6A 125V AC, 1/6 HP
Wire	#18 AWG SPT 1 and SPT 2	#18 to #16 AWG SPT 1 and SPT 2
Ivory	—	RS101I
White	RS100W	RS101W

Dimensions in Inches (mm)

Dimmers and Fan Speed Controls

Features

Standard rocker, toggle, slide and rotary styles for any interior design.

- Optimum CFL and LED Control
- Low End Adjustment for Fine Tuning
- For single-pole and 3-way applications
- Decorator and Traditional Toggle Styling Available
- Ivory, Light Almond, and White available for all SKUs
- No Neutral Required
- 0-10V Low Voltage loads supported with Decorator and Rocker styles



LCD300DW



LCD150SW

LED/CFL Dimmers

Description	Color	Rocker Dimmer	Slide Dimmer	Toggle Dimmer
LED/CFL 200W, Incandescent/Halogen 600W, 120V AC, 60Hz, single pole/three way	Ivory Light Almond White	LCD150DI LCD150DLA LCD150DW	LCD150SI LCD150SLA LCD150SW	— — —
LED/CFL 150W, Incandescent/Halogen 600W, 120V AC, 60Hz, single pole/three way	Ivory Light Almond White	— — —	— — —	LCD150TI LCD150TLA LCD150TW
LED/CFL 300W, Incandescent/Halogen 600W, 120V AC, 60Hz, single pole/three way, with indicator light	Ivory Light Almond White	LCD300DI LCD300DLA LCD300DW	— — —	— — —



LCD150TW



LCD0108SW

Low Voltage Dimmers

Description	Color	Rocker Dimmer	Slide Dimmer
01-10V Low Voltage Loads, 10 A @120V AC, 5 A @277V AC, 60Hz, single pole/three way	Ivory Light Almond White	LCD0108DI LCD0108DLA LCD0108DW	LCD0108SI LCD0108SLA LCD0108SW

Fan Speed Controls, 3 Speed

Description	Toggle	Rotary ON/OFF Knobs Provided
Termination	Single Pole/Three Way	Single Pole
Rating	1.5A 120V AC	1.5A 120V AC
Ivory	RAYFSQFI	—
Light Almond	RAYFSQFLA	—
White	RAYFSQFW	—
Ivory/White	—	RFSQ2FDK

Replacement Knobs

Rotary Fan Control Replacement Knobs
—
R28032406
—
R28032401
—



R28032401

R28032406



RFSQ2FDK

Fan Speed Controls, 3 Speed

Description	Rocker Slide Adjustment	Slide Control Slide to OFF
Termination	Single Pole/Three Way	Single Pole
Rating	1.5A 120V AC	1.5A 120V AC
Ivory	RDVFSQFI	RSFSQFI
Light Almond	RDVFSQFLA	RSFSQFLA
White	RDVFSQFW	RSFSQFW

Replacement Knobs

Slide Control Replacement Knobs
—
—
RSKI
RSKLA
RSKW

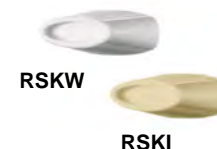

RSKW

RSKI



RSFSQFW

Wall Switches and Digital Timer

Passive Infrared Wall Switches

- Passive infrared technology
- Photozell (WS2000 series)
- No neutral required
- 1200 sq. ft. coverage
- Steel mounting strap
- Compatible with most LED and CFL
- CEC Title 24 and ASHRAE 90.1 compliant
- cULus



Description	Color	Standard	with Nightlight	with Neutral	with Nightlight and Neutral
Manual adjusting; selectable manual/auto ON operation; dual-voltage 120/277V AC; multi-way capable.	Gray	WS2000GY	WS2000NGY	—	—
	Ivory	WS2000I	WS2000NI	WS2004I	WS2004NI
	Light Almond	WS2000LA	WS2000NLA	—	—
	White	WS2000W	WS2000NW	WS2004W	WS2004NW
Manual adjusting; selectable manual/auto ON operation; 120V AC only.	Ivory	WS1000I	WS1000NI	—	—
	Light Almond	WS1000LA	WS1000NLA	—	—
	White	WS1000W	WS1000NW	—	—
Manual adjusting; manual ON operation; 120V AC only.	Ivory	WS1001I	WS1001NI	—	—
	Light Almond	WS1001LA	WS1001NLA	—	—
	White	WS1001W	WS1001NW	—	—
Manual adjusting; auto ON operation; dual circuit; 120V AC only.	Gray	WS1020GY	WS1020NGY	—	—
	Ivory	WS1020I	WS1020NI	WS1024I	WS1024NI
	Light Almond	WS1020LA	WS1020NLA	WS1024LA	WS1024NLA
	White	WS1020W	WS1020NW	WS1024W	WS1024NW
Manual adjusting; manual ON operation; dual circuit; 120V AC only.	Gray	WS1021GY	WS1021NGY	—	—
	Ivory	WS1021I	WS1021NI	WS1025I	WS1025NI
	Light Almond	WS1021LA	WS1021NLA	WS1025LA	WS1025NLA
	White	WS1021W	WS1021NW	WS1025W	WS1025NW

Note: See below for coverage patterns.

Count Down Timer Wall Switch

Description	Color	30 Minutes: OFF, 5, 10, 20, 30	60 Minutes: OFF, 15, 30, 45, 60	12 Hours: OFF, 2, 4, 8, 12
1000W @ 120V AC and 1400W @ 277V AC.	Ivory	DT5030I	DT5060I	DT5012I
	Light Almond	DT5030LA	DT5060LA	DT5012LA
	White	DT5030W	DT5060W	DT5012W

Note: Neutral required.

Digital Timer Wall Switch

Description	Color	120V AC	277V AC	Catalog Number
Dip switch enabled preset intervals. User adjustable 1 min up to 4 hours, 3-way capable. Includes an ON/OFF momentary push button switch feature.	White	960W	1200W	DT2000W

Note: Neutral required.



Wall Switches Coverage Patterns

Minor Motion: ■ PIR Major Motion: ■ PIR

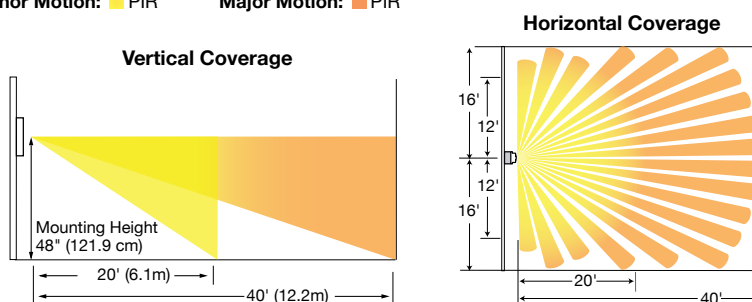

WS1000, WS2000 SERIES

Floor Boxes for Concrete Floors

Residential Round Non-Metallic Floor Box offers an economical solution for electrical power or a combination of power and voice/data applications. Designed specifically for slab-on-grade installation. Quick and easy installation is assured using a push in place leveling system. UL Listed.

Features

After the box has been secured in concrete, cut for height, apply PVC glue and push the cover assembly into the box. No fasteners or adjustment screws required.

- 4 inch minimum concrete pour
- Removable neoprene gaskets allow for independent use of either side of the receptacle with the cover closed
- Self height and leveling ring, no adjustments
- Pre-assembled flange, cover and leveling ring for quick installation
- Parallel PVC hubs for 1 inch and ¾ inch conduit
- Recessed GFCI/decorator opening
- Tamper-Resistant duplex receptacle included
- UL listed floor box



RF406BK
with RF400

Floor Boxes for Concrete Floors

Description	Rating	Material/Color	Catalog Number
Flange and Hinged Door Cover Assembly. Includes tamper-resistant duplex receptacle, gasket, floor leveling PVC ring, high impact and chemically resistant nylon. Factory pre-assembled for easy drop-in installation.	15A 125V NEMA 5-15R	Brushed Aluminum Brushed Brass Plated Solid Brass Almond Black Chestnut Brown Gray	RF406ALU RF406BP RF406BR RF406AL RF406BK RF406BN RF406GY
Flush fit cover for hardwood and tile floors (similar to above).		Solid Brass	RF409BR
PVC Floor Box with Concrete Protective Cover. Accepts ¾ in. and 1.0 in. schedule 40 and schedule 80 PVC conduit. Includes round box (47/8 in. diameter x 6.0 in. deep), four reducers, closure plugs, and concrete cover with locator flag.		Gray	RF400
Hinged Nylon Replacement Door Cover. Includes neoprene gasket to seal plug openings. Replacement cover for RF406 series.		Solid Brass Almond Black	RF407BR RF407AL RF407BK
Low Voltage Divider. For use in PVC box RF400, when JLOAD® Multimedia Outlet is used.		Gray	RF408



RF406ALU



RF409BR



RF408

Adjustable Non-Metallic Concrete Floor Box Stand

Description	Color	Catalog Number
PVC floor box stand, adjusts up to 4 inches.	Gray	PFBSTANDGY



JLOAD® Multimedia Outlet - See page Z-27 for Features



Description	Color	Tamper-Resistant	Tamper-Resistant
JLOAD® Multimedia Outlet. Specifically designed to provide power, Cat. 5e and coaxial in a single gang box. Requires Low Voltage Divider RF408 when used in PVC Box RF400. Includes decorator frame, one Cat. 5e, one F-connector and one power receptacle 125V with voltage dividers*.	Black Gray Ivory Light Almond White	RJ650BKTR RJ650GYTR RJ650ITR RJ650LATR RJ650WTR	RJ620BKTR RJ620GYTR RJ620ITR RJ620LATR RJ620WTR
JLOAD® Multimedia Outlet Includes decorator frame with two open ports for custom configuration and one power receptacle 125V with voltage dividers*.	Black Gray Ivory Light Almond White	RJ65BKTR RJ65GYTR RJ65ITR RJ65LATR RJ65WTR	RJ62BKTR RJ62GYTR RJ62ITR RJ62LATR RJ62WTR



PFBSTANDGY



RJ650BKTR

Note: *Dividers provided for use with the RJ600, RF515 series and RU200 series boxes. RF408 required for use with the RF400 series floor boxes. See page Z-10 for snap fit inserts. See pages Z-21 to Z-26 for floor boxes and under cabinet power distribution options. See page Tech-10 for Tamper-Resistant description.

Floor Boxes for Wood Floors

Hubbell Wood Floor Boxes allow for the placement of electrical power or a combination of power and voice/data devices. Specifically designed for use with structural wood floors. The boxes are height adjustable (up to ¾ inch) for optimal alignment and fit.

Features

- Available surface mount or flush fit
- Pre-assembled flange and cover for fast installation
- Removable neoprene gaskets allow for independent use of either side of the receptacle with the cover closed
- Low voltage divider optional provides for power and voice/data in a compact space
- Height accessible adjustments after the box is mounted
- Back and side knockouts for proper wiring access
- Recessed receptacle minimizes plug protrusion; allowing furniture to be located over the plug
- Top screw fastening and side joist mounting provided



**RF509BR, RJ650BKTR,
RF500 with Divider**

Note: Template cutout provided with instructions for proper installation.

The Right Choice for that Perfect Finishing Touch!

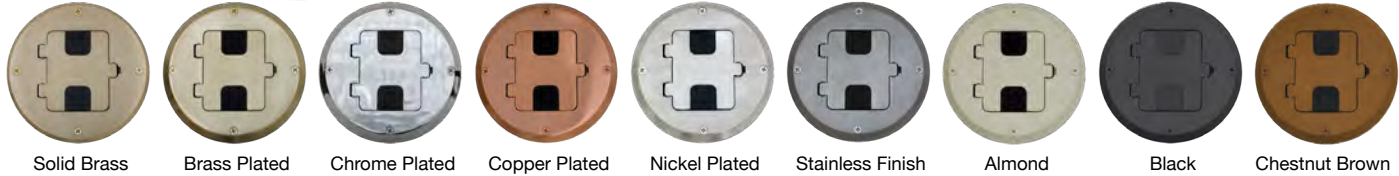

Note: Not all configurations are available in all colors. See below for details.



Floor Boxes for Structural Wood Floors

Description	Material	Finish	Catalog No.	Material	Finish	Catalog No.
Decorator duplex receptacle floor box kit; includes steel box, flange and hinged door cover assembly with 15A 125V tamper-resistant duplex receptacle; designed for installation in wood floors; mounts to sub-floor or joists.	Solid Brass	Clear Lacquer	RF515BR	Aluminum	Brass Plated	RF515BP
	Aluminum	Stainless Paint	RF515SS	Aluminum	Chrome Plated	RF515CH
	Aluminum	Almond Paint	RF515AL	Aluminum	Copper Plated	RF515CU
	Aluminum	Black Paint	RF515BK	Aluminum	Nickel Plated	RF515NI
	Aluminum	Chestnut Brown Paint	RF515BN			
Flange and hinged door cover assembly; includes tamper-resistant duplex receptacle; neoprene gaskets; for use with steel box RF500.	Solid Brass	Clear Lacquer	RF506BR	Aluminum	Brass Plated	RF506BP
	Aluminum	Stainless Paint	RF506SS	Aluminum	Chrome Plated	RF506CH
	Aluminum	Almond Paint	RF506AL	Aluminum	Copper Plated	RF506CU
	Aluminum	Black Paint	RF506BK	Aluminum	Nickel Plated	RF506NI
	Aluminum	Chestnut Brown Paint	RF506BN			
Flush fit cover for hardwood and tile floors (similar to above).	Solid Brass	Clear Lacquer	RF509BR			
Adjustable floor box; 3 inch deep; three (3) ½ inch knockouts: one on bottom; one on each side; non-metallic sheathed cable clamps on each side.				Steel	—	RF500
Hinged Door Cover Only Replacement door for RF515, RF509 and RF506 series.	Solid Brass	Solid Brass	RF507BR	Aluminum	Brass Plated	RF507BP
	Aluminum	Stainless Finish	RF507SS	Aluminum	Chrome Plated	RF507CH
	Aluminum	Almond	RF507AL	Aluminum	Copper Plated	RF507CU
	Aluminum	Black	RF507BK	Aluminum	Nickel Plated	RF507NI
	Aluminum	Chestnut Brown Paint	RF507BN			



Floor Boxes for Wood Floors

Features

Duplex floor receptacles provide ample connections to service lighting, entertainment equipment and computers for family rooms and offices. Single receptacle configurations available for minimum requirements.

- Low profile, solid brass flange and cover
- Cut out template provided to assure proper sub-flooring preparation
- Line and low voltage options
- 2½ inch hole, ample wiring room
- For use with single or feed through service



RF151R

Drop-In Floor Box

Drop-In Floor Boxes are perfect for quick and easy installation of power or low voltage. Simply cut a hole between the floor and joists and drop through. The flange lip holds it in place.



Floor Boxes for Wood Floors



Description	Material	Catalog Number	Catalog Number
Drop In Floor Box Mounts in 2½ inch hole opening. Includes solid brass cover, single tamper-resistant receptacle, optional device mounts for two (2) voice/data video ports. Suitable for feed through circuitry. Impact resistant box.	Solid Brass	RF151R	RF201R
Duplex Receptacle Floor Box Rated Includes steel box, duplex TR receptacle and cover.	Solid Brass	RF6500BR	—
Single Receptacle Floor Box Rated Includes steel box, single receptacle and cover.	Solid Brass	RF151TR	—
Single Receptacle Display Rated Receptacle and cover only, excludes box.	Solid Brass	RF151DTR	—

Note: See page Tech-10 for Tamper-Resistant description.



RF151R



RF6500BR



RF151TR



RF151DTR

Dimensions

Wood Floor Boxes

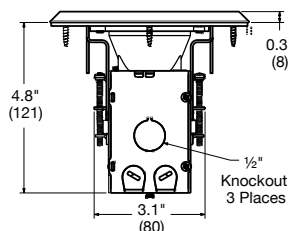
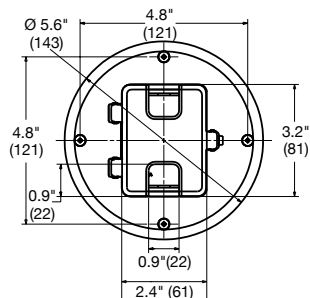

Drop-In Floor Box

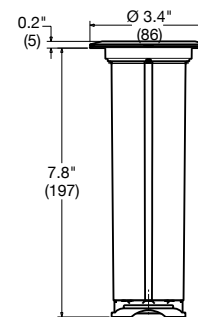
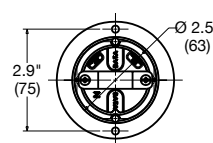

Dimensions in Inches (mm)

Countertop Receptacles

Hubbell Pop-Up Receptacles for countertops provide a power source ideal for kitchen and bath counters and islands. Hubbell is the first to market a countertop receptacle that is UL Listed. It allows compliance with NEC® 406.5(E) [countertops], 406.5(F) [work surfaces], and 406.5(H) [seating areas]. Pop-Up Receptacles are tested and water resistant to a half gallon spill. The receptacles feature Hubbell's patent pending silicone gaskets and patented cam action tamper-resistant technology. The compact design minimizes space required on the countertop as well as underneath in the cabinet area.

Features

- Surface or flush mount options
- Self sealing silicone gaskets at the receptacle face
- Compact design
- Permanent installation ready (suitable for MC cable or non-metallic sheath cable)
- Seven different finishes available
- Features two water and tamper-resistant receptacles
- Easy push down to pop-up function is rated for a minimum of 10,000 cycles (OPEN/CLOSE)
- Easy installation - simply drop in and tighten
- Listed



Because Spills Happen



**Hubbell Countertop Receptacles
are Spill Test Compliant**

Hubbell Countertop Receptacles are the first pop-up receptacles UL listed for countertop applications and permanent installations.

UL 498 Section 146

Built and listed to be water resistant to a half gallon of liquid spilled on the device.

NEC 406.5(E)

Receptacle assemblies for installation in countertop surfaces shall be listed for countertop application.

NEC 406.5(E) "Receptacles in Countertops"

For a receptacle to meet this requirement it must be part of a listed assembly for use in countertops

- *May be exposed to a larger liquid spill*
- *Can also be installed in work surfaces*
- *Must be GFCI protected surface*

NEC 406.5(F) "Receptacles in Work Surfaces"

For a receptacle to meet this requirement it must be part of a listed assembly for use in work surfaces

- *Does not require as high of a spill rating*
- *Cannot be used in countertop applications*

NEC® is a registered trademark of the National Fire Protection Association (NFPA).

Countertop Receptacles

Description	Finish	Color/Material	15A 125V Receptacle		20A 125V Receptacle	
			Surface Mount	Flush Mount	Surface Mount	Flush Mount
Tamper-resistant pop-up kitchen counter receptacle, rated for 20A circuits Cover: machined aluminum, wiring chamber accepts 1/2" MC or non-metallic sheath cable	Powder Coated	Black	RCT200BK	RCT201BK	RCT220BK	RCT221BK
		White	RCT200W	RCT201W	RCT220W	RCT221W
		Bronze	RCT200BZE	RCT201BZE	RCT220BZE	RCT221BZE
	Brushed	Aluminum	RCT200ALU	RCT201ALU	RCT220ALU	RCT221ALU
		Brass	RCT200BR	RCT201BR	RCT220BR	RCT221BR
		Nickel	RCT200NI	RCT201NI	RCT220NI	RCT221NI
	Polished	Chrome	RCT200CH	RCT201CH	RCT220CH	RCT221CH



RCT200BK

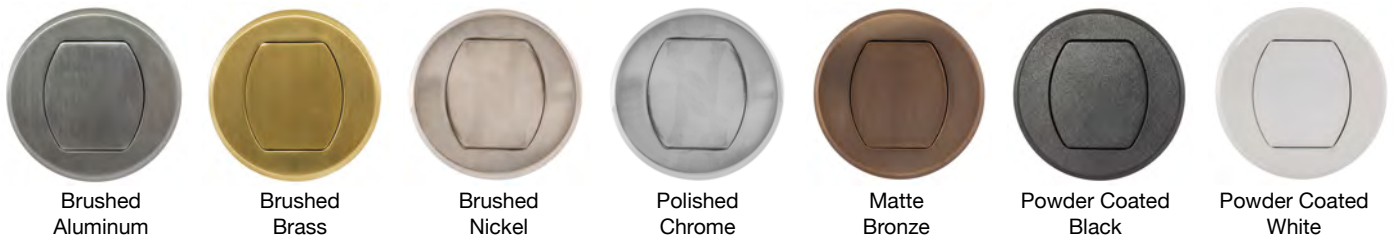

Tri-Power AC, includes: tamper-resistant pop-up kitchen counter receptacle, USB Type AC and wireless inductive, rated for 20A circuits Cover: machined aluminum, wiring chamber accepts 1/2" MC or non-metallic sheath cable; surface mount only	Powder Coated	Black	RCT600BK	—	RCT620BK	—
		White	RCT600W	—	RCT620W	—
		Bronze	RCT600BZE	—	RCT620BZE	—
	Brushed	Aluminum	RCT600ALU	—	RCT620ALU	—
		Brass	RCT600BR	—	RCT620BR	—
		Nickel	RCT600NI	—	RCT620NI	—
	Polished	Chrome	RCT600CH	—	RCT620CH	—



RCT221ALU



RCT600NI

Customizable Color Kits

Installable in surface mount option only, available in 7 different finishes



Note: Recommended to be fed by a GFCI circuit, up to 20 Amp Service.

Dimensions in Inches (mm)

Under Cabinet/Counter Power Distribution

Features

These boxes comply with the NEC® for kitchen receptacles, with placement not more than 20 inches above the counter surface. They can also be placed under counter islands, not lower than 15 inches from the surface.

- Available with nylon or metal cover
- Custom configurable, accepts any decorator style device
- Mounting hardware included
- UL Listed and CSA Certified under cabinet boxes



Under Cabinet/Counter Power Distribution

Description	Material	Catalog Number
Slim Box	Stainless Steel	RU100SS
	White Metal	RU100W
	White Nylon	RU170W*
GFCI Fit Box	Stainless Steel	RU200SS
	White Metal	RU200W
	White Nylon	RU270W*

Note: *Steel box with nylon cover.



RU100W



RU200SS

Dimensions

Slim Box

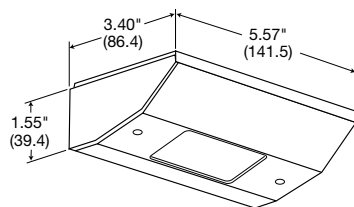

GFCI Fit Box

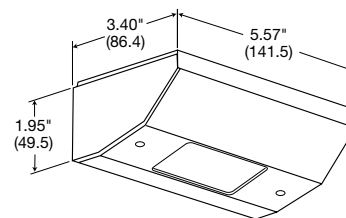

Vertical Mount

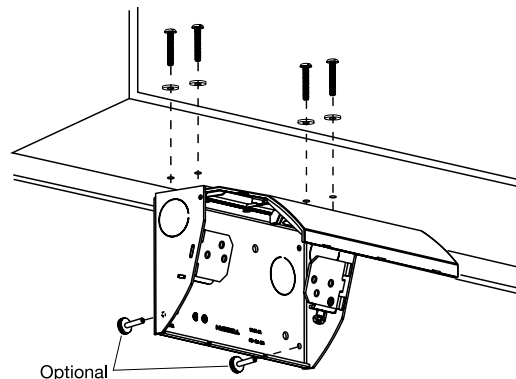

Horizontal Mount

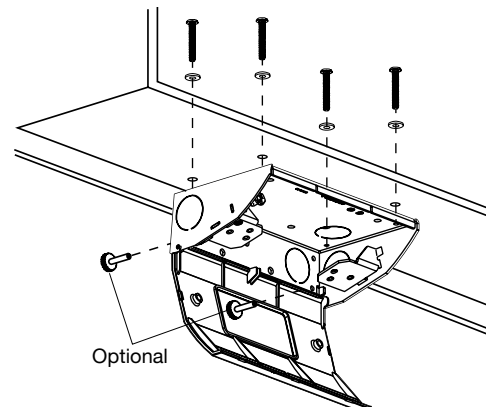

Dimensions in Inches (mm)

NEC® is a registered trademark of the National Fire Protection Association (NFPA).

JLOAD® Multimedia Outlet

Make the Most of a Perfect Location

Install receptacles and voice/data devices exactly where they are needed, in the smallest space possible.

Features

- Accepts any snap fit jack configuration (see page Z10)
- Isolates low voltage and power in the same box
- Custom box mounting
- Provides for data, telephone and coaxial
- Available in 15 or 20 Amp



RJ620WTR

Note: Requires unique box shown below.



Special Use Products



Description	Color	Tamper-Resistant	Tamper-Resistant
JLOAD® Multimedia Outlet Specifically designed to provide power, Cat. 5e and coaxial in a single gang box. Requires JLOAD® Multimedia Box RJ600. Perfect for HDTV and computer use where a combination of power and data are needed. Includes decorator frame, one Cat. 5e, one F-connector and one power receptacle 125V with voltage dividers*.	Black	RJ650BKTR	RJ620BKTR
	Gray	RJ650GYTR	RJ620GYTR
	Ivory	RJ650ITR	RJ620ITR
	Light Almond	RJ650LATR	RJ620LATR
	White	RJ650WTR	RJ620WTR
JLOAD® Multimedia Outlet Includes decorator frame with two open ports for custom configuration and one power receptacle 125V with voltage dividers*.	Black	RJ65BKTR	RJ62BKTR
	Gray	RJ65GYTR	RJ62GYTR
	Ivory	RJ65ITR	RJ62ITR
	Light Almond	RJ65LATR	RJ62LATR
	White	RJ65WTR	RJ62WTR
JLOAD® Multimedia Box 3 inches deep with seven ½-inch knockouts, non-metallic sheathed cable clamps on each side. Screw in mounting to stud.	Steel	RJ600	RJ600



Dimensions in Inches (mm)

Note: *Dividers provided for use with the RJ600, RF515 series and RU200 series boxes. RF408 required for use with the RF400 series floor boxes. See page Z-10 for snap fit inserts. See pages Z-21 to Z-26 for floor boxes and under cabinet power distribution options. See page Tech-10 for Tamper-Resistant description.

Dimensions

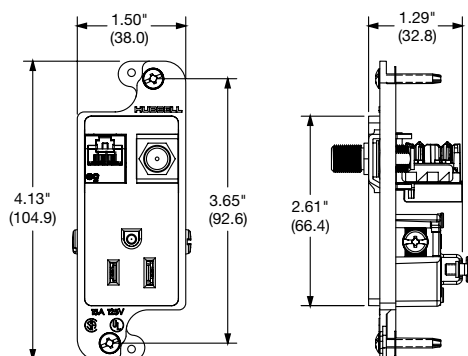

Decorator Switches - Technical Information

Features

- Smooth, quiet rocker action
- Self-grounding feature standard
- Ultrasonically welded cover and base provides maximum strength
- Push, back and side wiring
- Available colors: Black, Brown, Gray, Ivory, Light Almond and White



RSD115W

Specifications

Switches	Component	Material
Typical Specification — Catalog Number RSD115xx	Base and body	PVC
Description — Decorator series rocker switch	Rocker	Polycarbonate
Type — Single Pole	Terminals	Brass
Rating — 15A, 120-277V AC	Mounting strap	Galvanized steel
Certification — Listed to UL Standard 20	Contacts	Silver alloy
CSA Certified	Movable contact arm	Copper alloy
	Terminal screws	Steel

Note: **xx** = Color: **BK** (Black), **BL** (Brown), **GY** (Gray), **I** (Ivory), **LA** (Light Almond), and **W** (White).

Performance

Electrical	
Dielectric voltage	Withstands 1,500V AC minimum for 1 minute.
Max. working voltage	120V.
Overload	1.5 times rating.
Endurance	30,000 cycles minimum.
Mechanical	
Terminal accommodation	Back and side wire: #14 AWG min. - #12 AWG max. solid and stranded copper wire only; push wire: #14 AWG solid copper wire only.
Environmental	
Flammability	UL V0.
Operating temperatures	Maximum continuous 60°C; minimum -20°C (without impact).

Dimensions

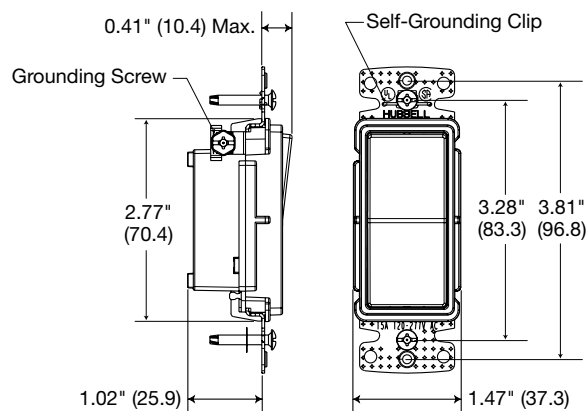

Single-Pole Decorator Switch

Dimensions in Inches (mm)

SECTION AA

Table of Contents



30, 50, 100 & 200 Amp Cable Sets and Devices



Marine Adapters



Marine Isolation Transformers



Product	Page	Product	Page
New Marine Products	AA-2	30A 28V DC Rated	AA-34
Ship-to-Shore Selection Guide	AA-4	12V DC Rated Switches	AA-35
ELCI Interface Solutions	AA-7	15A Twist-Lock® and Straight Blade Devices	AA-36
Ship-to-Shore Cable Sets and Devices		20A Twist-Lock® and Straight Blade Devices	AA-38
30A Twist-Lock®	AA-9	Circuit Testers	AA-40
50A Twist-Lock®	AA-14	USB Charger Receptacles	AA-41
100A Pin and Sleeve	AA-19	GFCI and Portable Ground Fault Circuit Interrupters	AA-42
200A Pin and Sleeve	AA-23	Inside the Boat	
Internationally Rated		Receptacles	AA-43
Pin and Sleeve Devices	AA-24	Switches and Weatherproof Switch Plates	AA-44
Twist-Lock® Devices	AA-25	Wallplates	AA-45
Adapters		Communication Frames and Connectors	AA-46
Intelligent Y Adapters	AA-26	Boatyard Accessory Items	
Adapter Selection Guide	AA-28	Non-Metallic While-In-Use Weatherproof Covers	AA-47
Molded Straight and Y Adapters	AA-29	Stainless Steel Lift Covers	AA-48
Marine Isolation Transformers		Marine Grade Lift Covers	AA-49
Features and Benefits	AA-30	Marine Grade Dockside Boxes and Covers	AA-50
Isolation Transformers	AA-31	Lighting Fixtures and Cord Connectors	AA-51
Product Dimensions	AA-31	Codes and Specifications	AA-52
Telephone and Cable TV Devices	AA-32		

New Marine Products



Hubbell Marine 100 Amp Pin & Sleeve

The Best Just Got Better. Page AA-20



Hubbell Marine was the first to offer 100 amp marine grade devices that are considered second to none. Hubbell developed the standard for 100 amp pin and sleeve devices with the National Electric Code and the American Boat and Yacht Council.

100 Amp Pin and Sleeve Devices

Improved Features:

- UL Type 4X and IP69k Rated
- Compact and durable cap hinge is fully shrouded and protected
- VO flammability rating
- UV stabilized, impact resistant and chemical resistant housing to withstand the harshest environments

Hubbell Marine Isolation Transformers

Constant Clean Safe Power Page AA-30



#316 Stainless Steel Housing



Standard White Powder Coated Steel Housing

- Protects sensitive equipment on board from fluctuating or low voltage
- Converts various dockside power, such as 208 volt systems to the 120/240 volts needed on board
- Greatly reduces the possibility of stray current from your boat from leaking into the water, known as Electrical Shock Drowning (ESD)

Available Options:

- 15 kVA and 25 kVA Models
- 60 Hz and 50/60 Hz Models
- 12.5% Auto-Boost
- White Powder Coated Steel Housing (Non-Boost Only)
- #316 Stainless Steel Housing (with and without Auto-Boost)

Additional Features

- Compact Size and Weight
- Two Full Current-Carrying Shields
- Vibration Resistant
- Exceeds ABYC's 4000 Volt HIPOT Test
- Full Capacity Taps = 1:1 Voltage Ratio

Marine Products

New Marine Products

USB Charger Receptacles with Type-C

Charge Faster with Hubbell Page AA-41

The smaller size USB Type-C connection will replace the traditional larger Type A connection

Now, with 5 amps of fast charging power
Available in standard tamper-resistant version
and in weather resistant versions

USB Type-C connection is:

- Smaller, 24 pin configuration
- More robust for reliable connection
- Quicker, simply plug in your cord



Type-C



Type A&C



Type A

New Hubbell Weather Resistant and Extra Heavy Duty Corrosion Resistant Ground Fault ReceptaclesPage AA-42

Ground Fault Receptacle Features:

Hubbell's Weather Resistant offering:

- Meets NEC requirements for weather resistant, UV and corrosion resistance for harsh and damp locations
- Protects against line and load reversal

Extra heavy duty ground fault receptacles are designed to withstand the most demanding environments and applications:

- Nickel plated face contacts, mounting strap and terminals
- Stainless steel hardware
- Tamper and weather resistant make this the only corrosion resistant ground fault receptacle available



Weather Resistant



Extra Heavy Duty
Corrosion Resistant

Stainless Steel Weatherproof and Watertight Flip Covers

Flip Cover FeaturesPage AA-48

- Heavy duty #316 stainless steel covers provide superior corrosion resistance while maintaining their smooth, polished finish
- Available in rain-tight or watertight, duplex and GFCI versions
- Horizontal or vertical mounting positions
- UL and cUL listed



Marine Products

Ship-to-Shore Selection Chart - Boatside

**30A
125V AC
2 Pole
3 Wire**

Pages AA-8 to AA-12



HBL303NM



HBL303SS



HBL26CM13



HBL60CM33
HBL60CM33W

**50A
125V AC
2 Pole
3 Wire**

Pages AA-13 to AA-15



HBL503NM



HBL503SS



HBL63CM60



HBL77CM15
HBL77CM15W

**50A
125/250V AC
3 Pole
4 Wire**

Pages AA-16 and AA-17



HBL504NM



HBL504SS



HBL63CM64



HBL77CM15
HBL77CM15W

**100A
125/250V AC
3 Pole
4 Wire**

Pages AA-18 to AA-20



M4100B12R



M4100C12R

**100A
3ØY
4 Pole
5 Wire**

Page AA-21
120/208V AC
277/480V AC



M5100B9R
M5100B7R



M5100C9R
M5100C7R

**200A
600V AC/250V DC
50-400 Hertz
4 Pole
5 Wire**

Pages AA-22 and AA-23



M5200BS1R



M5200CS1R

**Portable
Telephone and
Cable TV
Devices**

Pages AA-32 and AA-33



HBLPHTVNM



HBLPHTVSS



HBLTVSS



PH6624



PH7440

Marine Products

Ship-to-Shore Selection Chart - Dockside

 <p>YC310250 - 280' (85.3m) Yellow cable only. WC310280 - 280' (85.3m) White cable only.</p> <p>HBL61CM08 & HBL61CM08LED - 50' (15.2m) HBL61CM05 & HBL61CM05LED - 35' (10.7m) HBL61CM03 & HBL61CM03LED - 25' (7.6m) HBL61CM08W & HBL61CM08WLED - 50' (15.2m) HBL61CM03W & HBL61CM03WLED - 25' (7.6m)</p>	 <p>HBL60CM31 HBL60CM31W</p>	 <p>HBL26CM11</p>	 <p>HBL26CM10</p>	 <p>HBL74CM25WOA HBL74CM25WOAW</p>
 <p>YC306250 - 250' (76.2m) Yellow cable only.</p> <p>HBL61CM53 & HBL61CM53LED - 50' (15.2m) HBL61CM43 & HBL61CM43LED - 25' (7.6m)</p>	 <p>HBL77CM16 HBL77CM16W</p>	 <p>HBL63CM61</p>	 <p>HBL63CM70</p>	 <p>HBL77CM74WO</p>
 <p>YC406250 - 250' (76.2m) Yellow cable only.</p> <p>HBL61CM52 & HBL61CM52LED - 50' (15.2m) HBL61CM42 & HBL61CM42LED - 25' (7.6m) HBL61CM52W & HBL61CM52WLED - 50' (15.2m) HBL61CM42W & HBL61CM42WLED - 25' (7.6m)</p>	 <p>HBL77CM16 HBL77CM16W</p>	 <p>HBL63CM65</p>	 <p>HBL63CM69</p>	 <p>HBL77CM74WO</p>
 <p>CS1004 - 100' (30.4m) 4-Wire CS754 - 75' (22.8m) 4-Wire CS100IT4 - 100' (30.4m) 3-Wire CS754IT4 - 75' (22.8m) 3-Wire</p> <p>CW125IT4 - 125' (38.0m) One-ended cable set for winches. CW100IT4 - 100' (30.4m) One-ended cable set for winches. CW754 - 75' (22.8m) One-ended cable set for winches. CS50EXT4 - 50' (15.2m) Extension cord.</p>	 <p>M4100P12</p>	 <p>M4100C12</p>	 <p>M4100R12</p>	
 <p>CS100IT5 - 100' (30.4m) 4-Wire CS75IT5 - 75' (22.8m) 4-Wire</p> <p>CW125IT5 - 125' (38.0m) One-ended cable set for winches. CW100IT5 - 100' (30.4m) One-ended cable set for winches. CS50EXT5 - 50' (15.2m) Extension cord.</p>	 <p>M5100P9 M5100P7</p>	 <p>M5100C9 M5100C7</p>	 <p>M5100R9 M5100R7</p>	
	 <p>M5200PS1</p>	 <p>M5200CS1</p>	 <p>M5200RS1</p>	
 <p>PH6630 - 250' (76.2m) Yellow cable only. PH6599 - 50' (15.2m) PH6598 - 25' (7.6m)</p> <p>75 Ohm TV Cable TV99 - 50' (15.2m) TV98 - 25' (7.6m) TV99W - 50' (15.2m) TV98W - 25' (7.6m)</p>	 <p>PH7440</p>	 <p>PH6625</p>	 <p>PH6596</p>	 <p>TV97</p>  <p>PH6597TV</p>

Marine Products

ELCI Interface Solutions

ABYC Code Requirements

Hubbell Marine Electrical continues its tradition of innovation by developing a simple, flexible method of adapting a variety of ELCI Sensors and Breakers to our traditional Stainless Steel and Non-Metallic Shore Power Inlet Housings.

Effective July 31, 2012, ABYC, E-11.11.1 requires that "An Equipment Leakage Circuit Interrupter (ELCI) shall be installed with or in addition to the main shore power disconnect circuit breaker(s) or at the additional over current protection as required by E-11.10.2.8.3, whichever is closer to the shore power connection".

Note: A faulty electrical connection at the dock or on a boat could result in stray electrical current in the water. Such stray current in Electrical Shock Drowning (ESD).

Hubbell's family of ELCI adaptive Shore Power Inlet Kits provide a simple, flexible, low-cost solution.

Kits Contain:

- Hubbell Shore Power Inlet
- Matching Shore Power Inlet Housing(s)
- Mounting Adapter Plate(s) for use with various ELCI Sensors and ELCI Breakers (not provided)
- Stainless Steel Hardware



An Equipment Leakage Circuit Interrupter (ELCI) provides 30mA ground fault protection for the entire AC shore power system beyond the ELCI



Marine Products

ELCI Interface Solutions

Hubbell ELCI Adapter Kits for North Shore Safety, Ltd® PGFM Series (ELCI Marine) Sensing Module and Sensata Technologies® ELCI Breakers

Description	Breaker	Sensor	Power Inlet	Catalog Number
30 Amp, 125 Volt Non-Metallic Inlet (HBL303NM) and (2) Non-Metallic Inlet Housings, Adapter Plates and Hardware.				HBL303NMELCI
30 Amp, 125 Volt Non-Metallic Inlet (HBL303NM) and (1) Non-Metallic Inlet Housing that adapts to North Shore Safety's Sensor only (no circuit breaker inlet housing), Adapter Plate and Hardware.				HBL303NMELCIS
30 Amp, 125 Volt Stainless Steel Inlet (HBL303SS) and (2) Stainless Steel Inlet Housings, Adapter Plates and Hardware.				HBL303SSELCI
30 Amp, 125 Volt Stainless Steel Inlet (HBL303SS) and (1) Stainless Steel Inlet Housing that adapts to North Shore Safety's Sensor only (no circuit breaker inlet housing), Adapter Plate and Hardware.				HBL303SSELCIS
50 Amp, 125/250 Volt Stainless Steel Inlet (HBL504SS) and (2) Stainless Steel Inlet Housings, Adapter Plates and Hardware.				HBL504SSELCI
50 Amp, 125/250 Volt Stainless Steel Inlet (HBL504SS) and (2) Stainless Steel Inlet Housing that adapts to a standard overcurrent-type circuit breaker.				HBL504SSELCIH
Blank Non-Metallic Inlet Housing and Hardware for mounting North Shore Safety ELCI Sensor only.				HBLRRELCI

Note: North Shore Safety's Sensor and Sensata Technologies Circuit Breakers (not provided) are separate devices each requiring their own blank shore power inlet interface.

Features and Benefits

30 Amp Cable Sets

- Bright, durable, LED (green) indicates “Power-ON”
- High intensity LED is visible—even in bright sunlight
- Totally molded design for superior waterproofing and durability
- Exclusive copper crimp barrel terminations for tighter connections and longer life
- Marine UL and cUL Listed



Note: Cable sets must be fully extended before using.



Housing Design

- New improved ergonomic styling
- Line-up notches to indicate: Locked - Unlocked
- Arrow indicating lock or unlock position
- Available in yellow or white colors



Interior Design

- Molded design totally encased in solid PVC material, for superior waterproofing and durability
- Locking ring assures proper alignment of connector to inlet for complete contact and waterproofing; prevents accidental disengagement

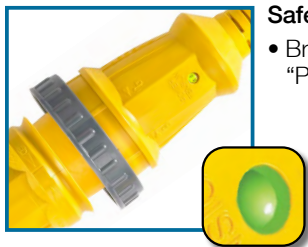

Safety

- Bright green LED indicates “Power-ON”

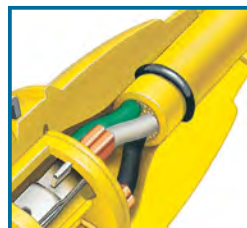

Interior Design

- Strain relief bull ring protects against stress and strain on the conductors caused by boat movement, crew traffic and rough handling
- Exclusive copper crimp barrel termination provides protection against internal overheating as well as additional strain relief

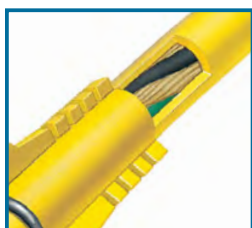

Cord Flexibility

- Molded flexneck adds life to cable set by helping to prevent right-angle cable damage and pullout
- Jute fillers inside jacket for maximum cable flexibility; Hubbell cable coils neater, lighter and lays flatter; particularly in colder climates



Cable Set Options

- Available in 50, 35 and 25 foot lengths
- Available with or without LED
- Available in UV resistant yellow or white
- Marine UL and cUL Listed

30A Ship-to-Shore Devices

30 Amp Cable Sets and Bulk Cable

Our 30A 125V cable set is packed with high performance details from end to end that make a real difference. Completely factory pre-wired with molded-on devices. Designed to coil easily and lay flat.

IP55
SUITABILITY
(Boatside)



HBL61CM08
HBL61CM05
HBL61CM03

30A 125V Cable Sets and Bulk Cable

Description	Catalog Number
Yellow 50 ft. (15.2m) vinyl jacketed shore power cable set. #10 AWG is factory pre-wired with molded-on devices. Connector end has non-metallic threaded sealing ring which makes inlet/connector interface watertight.	HBL61CM08
Same as HBL61CM08 except 35 ft. (10.7m) in length.	HBL61CM05
Same as HBL61CM08 except 25 ft. (7.6m) in length.	HBL61CM03
Same as HBL61CM08 except in white in color.	HBL61CM08W
Same as HBL61CM05 except in white in color.	HBL61CM05W
Same as HBL61CM03 except in white in color.	HBL61CM03W

Note: See page AA-8 for features and benefits.



HBL61CM08W
HBL61CM05W
HBL61CM03W

30A Cable Sets with LED "Power-ON" Indicator

Description	Catalog Number
Yellow 50 ft. (15.2m) vinyl jacketed shore power cable set. #10 AWG is factory pre-wired with molded-on devices. Connector end has non-metallic threaded sealing ring which makes inlet/connector interface watertight.	HBL61CM08LED
Same as HBL61CM08LED except 35 ft. (10.7m) in length.	HBL61CM05LED
Same as HBL61CM08LED except 25 ft. (7.6m) in length.	HBL61CM03LED
Same as HBL61CM08LED except in white in color.	HBL61CM08WLED
Same as HBL61CM05LED except in white in color.	HBL61CM05WLED
Same as HBL61CM03LED except in white in color.	HBL61CM03WLED

Note: See page AA-8 for features and benefits.



HBL61CM08LED
HBL61CM05LED
HBL61CM03LED

Accessories

Description	Catalog Number
Yellow 250 ft. (76.2m) three conductor, #10 AWG type STW, PVC jacketed portable cord with jute fillers for added flexibility. Ideal for making cable sets, extension cord, and adapters that will not mark boat's deck. 250 ft. (76.2m) lengths only.	YC310250
White 280 ft. (85.3m) three conductor, #10 AWG type STW, PVC jacketed portable cord with jute fillers for added flexibility. Ideal for making cable sets, extension cord, and adapters that will not mark boat's deck. 280 ft. (85.3m) lengths only.	WC310280
Replacement non-metallic sealing ring for 30A cable sets and boots.	RPL30P*

Note: *Not UL Listed.



YC310250



RPL30P

30A Ship-to-Shore Devices

30 Amp 125 Volt Shore Power Inlets and Outlet

Traditional, stainless steel shore power inlet has easy-to-wire terminations. Interior is transparent for quick and easy visual inspection. Interior is shielded from the elements by a gasketed, self-closing cover, watertight when cover is screwed in place. Mounting holes are 2.38 in. (60.3) on centers. Mounting screws and gasket included. Protective rear enclosure/strain relief also included.

- Friction tight self-closing cover assures the interior is shielded from the elements when the inlet is not in use
- Neoprene gasket on underside of cover. For sealing when the cover is closed
- Mirror stainless steel finish for superior appearance



Housing Design

- Base and cover are #316 type stainless steel for strength and corrosion resistance
- Threaded base for making a watertight seal. When in use, it mates to the threaded ring of the weatherproof cover on the connector body; when not in use, it mates to the threaded cover

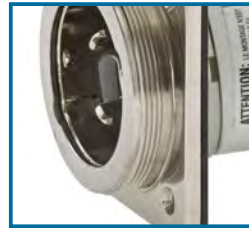

Interior Design

- Contact blades are nickel plated brass for corrosion resistance
- Mounting holes are 2.38 in. (60.3) on center
- Polycarbonate interior has superior heat resistance



HBL303NM



Terminations

- Easy-to-wire interior is transparent for quick, visual inspection of terminations
- #SR3050 protective rear enclosure cap attaches to contact carrier with 3 screws



HBLCBISS

30A 125V Twist-Lock® Devices

Description

Stylized UV resistant non-metallic shore power inlet has white Centrex® cover which makes unit weatherproof when completely closed. Interior has easy-to-wire terminations and is transparent for quick and easy visual inspection. Mounting holes are 2.38 in. (60.3) on centers and match existing mounting patterns. Mounting screws and gasket included. Protective rear enclosure/strain relief also included. **IP55 SUITABILITY.**

Catalog Number

HBL303NM



HBLCBINM

Traditional, stainless steel shore power inlet has easy-to-wire terminations. Interior is transparent for quick and easy visual inspection. Interior is shielded from the elements by a gasketed, self-closing cover, watertight when cover is screwed in place. Mounting holes are 2.38 in. (60.3) on centers. Mounting screws and gasket included. Protective rear enclosure/strain relief also included. **IP56 SUITABILITY.**

HBL303SS

Traditional stainless steel inlet housing; blank for attaching a circuit breaker (not included). Mounting hardware for Carling series breakers included. **IP56 SUITABILITY.**

HBLCBISS

Stylized non-metallic inlet housing; blank for attaching a circuit breaker (not included). Mounting hardware for Carling series breakers included. **IP55 SUITABILITY.**

HBLCBINM

Protective rear cover. Fits all 30A shore power inlets. Secures to back of inlets with three screws which are provided.

SR3050*

Replacement interior for HBL303SS and 60CM61 shore power inlets.

HBL303INT

Traditional stainless steel power outlet has gasketed, self-closing cover, watertight when cover is screwed in place. Mounting holes are 2.38 in. (60.3) on centers. Mounting screws and gasket included. **IP56 SUITABILITY.**

HBL303SSO

Nickel plated brass adapter plate for mounting 30A traditional style shore power inlets and outlets to FS/FD box.

HBL60CM75



HBL303SSO

Note: *Not UL Listed or CSA Certified.

Centrex® is a registered trademark of LANXESS Corporation.

30A Ship-to-Shore Devices



30A 125V Twist-Lock® Devices

Description	Catalog Number
Yellow Insulgrip® plug has rugged nylon housing and cord grip with range of .36–.93 in. (9–24) that utilizes a unique offset jaws arrangement to provide secure strain relief. IP20 SUITABILITY.	HBL26CM11
Yellow Insulgrip connector body has rugged nylon housing and cord grip with range of .36–.93 in. (9–24) that utilizes a unique offset jaws arrangement to provide secure strain relief.	HBL26CM13
Yellow single receptacle has Rynite® body and abuse resistant nylon face. IP20 SUITABILITY.	HBL26CM10



HBL26CM11



HBL26CM13

Boots and Weatherproof Plates

Description	Catalog Number
Yellow Seal-Tite® cover for weatherproofing HBL26CM11 plugs. IP44 SUITABILITY. Note: Fits Insulgrip devices only.	HBL60CM31+
White Seal-Tite cover for weatherproofing HBL26CM11 plugs. IP44 SUITABILITY. Note: Fits Insulgrip devices only.	HBL60CM31W+
Yellow Seal-Tite cover for weatherproofing HBL26CM13 connector bodies when used with shore power inlets. Threaded sealing ring makes connection watertight. Also for weatherproofing HBL26CM11 plug when used with HBL303SSO power outlet. IP56 SUITABILITY. Note: Fits Insulgrip devices only.	HBL60CM33+
White Seal-Tite cover for weatherproofing HBL26CM13 connector body when used with shore power inlets. Threaded sealing ring makes connection watertight. Also for weatherproofing HBL26CM11 plug when used with HBL303SSO power outlet. IP56 SUITABILITY. Note: Fits Insulgrip devices only.	HBL60CM33W+
Yellow Seal-Tite cover for weatherproofing HBL26CM13 connector bodies when used on extension cords or adapters. IP44 SUITABILITY. Note: Fits Insulgrip devices only.	HBL60CM32+
Yellow polycarbonate spring-loaded lift cover for weather-proofing old style 26CM10 receptacle. Meets the most stringent requirements of UL's three listing categories for weatherproof plates. Stainless steel screws and neoprene gasket included for mounting to FS/FD type weatherproof boxes. IP44 SUITABILITY.	HBL74CM24WO**
Same as HBL74CM24WO except gray in color. IP44 SUITABILITY.	HBL7424WO**
Yellow polycarbonate spring-loaded lift cover for weather-proofing HBL26CM10 receptacle. Meets the most stringent requirements of UL's three listing categories for weatherproof plates. Stainless steel screws and neoprene gasket included for mounting to FS/FD type weatherproof boxes. IP44 SUITABILITY.	HBL74CM25WOA**
Same as HBL74CM25WOA except white in color. IP44 SUITABILITY.	HBL74CM25WOAW
Same as HBL74CM25WOA except gray in color. IP44 SUITABILITY.	HBL7425WOA**
Stainless steel wall plate for old 26CM10.	SS725
Stainless steel wall plate for new HBL26CM10.	SS720



HBL26CM10



HBL60CM31



HBL60CM33



HBL60CM32



HBL74CM25WOA



HBL74CM25WOAW



SS725

Note: +Boots are not UL Listed or CSA Certified.
**See page AA-49 for additional weatherproof plates.

Rynite® is a registered trademark of E. I. DuPont.

30A Ship-to-Shore Devices

30 Amp Valise® Devices

A unique system of special locking lugs interlock the blade holder and sides as the plug is closed. These load bearing lugs provide strength and security and keep the Valise intact.

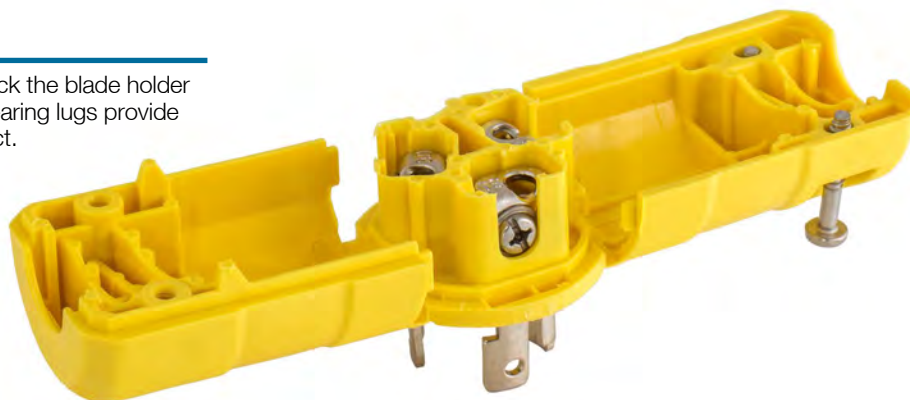

Housing Design

- Nylon body
- Wiring time is reduced. Large easy to wire clamp type terminals eliminate the need to wrap conductors around a screw



Interior Design

- Exclusive nylon webs are provided to make wiring quick and easy by joining the three sections together during assembly
- Powerful cord grips resist conductor slip and strain on wiring terminals
- Nickel plated brass contacts for corrosion resistance



Terminations

- Terminals provide a superior electrical connection by "bundling" the conductors when the clamps are tightened
- Two captive stainless steel assembly screws



HBL26CM11V



HBL26CM11VB



HBL26CM13V



HBL60CM31V



HBL60CM33V

30A 125V Twist-Lock® Devices

Description	Catalog Number
Yellow Valise® plug has one-piece nylon housing and assembles easily with two screws. Built-in cord grip has range of .59-.93 in. (15.0-23.6). IP20 SUITABILITY.	HBL26CM11V
Black Valise plug for use on bass boats with trolling motor. One-piece nylon housing assembles easily with two screws. Built-in cord grip has a range of .59-.93 in. (15.0-23.6). IP20 SUITABILITY.	HBL26CM11VB
Yellow Valise connector body has a one-piece nylon housing and assembles easily with two screws. Built-in cord grip has range of .59-.93 in. (15.0-23.6). IP20 SUITABILITY.	HBL26CM13V

Boots and Replacement Parts

Description	Catalog Number
Yellow Seal-Tite® cover for weatherproofing HBL26CM11V plugs. IP44 SUITABILITY. Note: Fits Valise devices only.	HBL60CM31V**
Yellow Seal-Tite cover for HBL26CM13V connector body when used with shore power inlets. Threaded sealing ring makes connection watertight. IP56 SUITABILITY. Note: Fits Valise devices only.	HBL60CM33V**
Yellow Seal-Tite cover for weatherproofing HBL26CM13V connector bodies when used on extension cords or adapters. IP44 SUITABILITY. Note: Fits Valise devices only.	HBL60CM32V**
Replacement non-metallic sealing ring for 30A cable sets and boots. Not UL listed.	RPL30P*

Note: **Not UL Listed or CSA Certified.
*Not UL Listed.



Features and Benefits

50 Amp Cable Sets

- Two bright and durable LEDs. GREEN indicates “Power-ON” and RED indicates “Incorrect Wiring” at the power source
- High intensity LEDs are visible—even in bright sunlight
- Totally molded design for superior waterproofing and durability
- Exclusive copper crimp barrel terminations for tighter connections and longer life
- Marine UL and cUL Listed



Note: Cable sets must be fully extended before using.



Housing Design

- New improved ergonomic styling
- Line-up notches to indicate: Locked - Unlocked
- Stainless steel threaded sealing ring to provide a watertight seal when mated with the shore power inlet
- Nickel plated brass shell for positive alignment of keying and corrosion-resistance

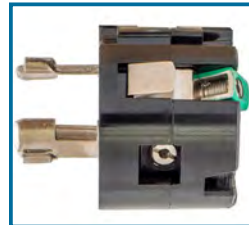

Interior Design

- Thermoset contact carrier is arcing and heat resistant
- Nickel plated brass contact blades for corrosion-resistance



Safety

- Arrow with ground symbol allows lining up with ground of receptacle
- Bright green LED indicates “Power-ON”; Bright red LED indicates “Incorrect Wiring” at the power source



Superior Termination

- Bull ring for strain relief on the terminals
- Exclusive copper crimp barrel termination provides protection against internal overheating and burnout compared to brass crimps

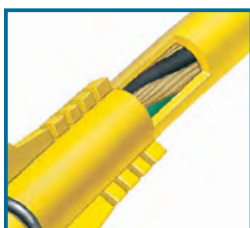

Cord Flexibility

- Molded-in flex feature controls the angle of cord entry and keeps water out
- Jute fillers inside jacket for maximum cable flexibility; Hubbell cable coils neater, lighter and lays flatter



Cable Set Options

- Available in 50 and 25 foot lengths
- Available in yellow or white
- Cords for winch systems available upon request
- Marine UL and cUL Listed

50A Ship-to-Shore Devices

50 Amp 125 Volt Traditional Stainless Steel Inlets

Traditional stainless steel shore power inlet has gasketed, self-closing cover so interior is shielded from the elements when not in use. Watertight when cover is securely fastened. Mounting holes are 2.38 in. (60.3) on centers and rear portion has 2.17 in. (55.1) diameter. Mounting screws and gasket included.

- Self-closing cover is friction tight to remain open while engaging cable set and shields the interior from the elements when the inlet is not in use
- Neoprene gasket on underside of cover, for sealing when the cover is closed



Housing Design

- Base and cover end threads are #316 type stainless steel for strength and corrosion resistance
- Threaded base for making a watertight seal. When in use, it mates to the threaded ring of the weatherproof cover on the connector body; when not in use, it mates to the threaded cover

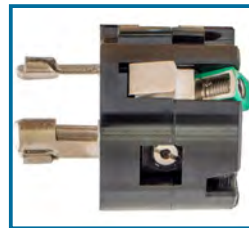

Interior Design

- Contact blades are nickel plated brass for corrosion resistance
- Pressure screw terminals for secure terminations clearly marked for easy identification
- Thermoset contact carrier is arcing and heat resistant



HBL503NM



Terminations

- Three screws "lock-in" the interior once it is in place
- Rear enclosure is nickel plated for corrosion resistance



50A 125V

50A 125V Twist-Lock® Devices

Description	Catalog Number
Stylized non-metallic shore power inlet has UV resistant white Centrex® cover which makes unit weatherproof when completely closed. Interior has easy to wire terminals. Mounting holes are 2.38 in. (60.3) on centers and match existing mounting patterns. Mounting screws and gasket included. IP55 SUITABILITY.	HBL503NM
Traditional stainless steel shore power inlet has gasketed, self-closing cover so interior is shielded from the elements when not in use. Watertight when cover is securely fastened. Mounting holes are 2.38 in. (60.3) on centers and rear portion has 2.17 in. (55.1) diameter. Mounting screws and gasket included. IP56 SUITABILITY.	HBL503SS
Nickel plated brass connector body has heat resistant thermoset interior and combination metal and rubber cord grip provides superior strain relief capability. Cord grip range is .44–1.14 in. (11.1–29.0). IP20 SUITABILITY.	HBL63CM60

Boots and Replacement Parts

Description	Catalog Number
Protective rear cover. Fits all inlets except HBL503SS. Secures to back of inlets with three screws which are provided.	SR3050**
Replacement interior for HBL503SS and 63CM72 shore power inlets.	CR16277
Yellow Seal-Tite® cover for connector bodies when used with 50A shore power inlets. Threaded sealing ring makes connections watertight. IP56 SUITABILITY.	HBL77CM15**
White Seal-Tite cover for connector bodies when used with 50A shore power inlets. Threaded sealing ring makes connections watertight. IP56 SUITABILITY.	HBL77CM15W**
Nickel plated brass cord clamp assembly with clamp range of .44–1.14 in. (11.1–29.0) provides strain relief for terminations on shore power inlets.	HBL77CM67
Yellow Seal-Tite cover for weatherproofing 50A connector bodies on extension cords or adapters. IP56 SUITABILITY.	HBL77CM17**

Note: **Not UL Listed or CSA Certified.

Centrex® is a registered trademark of LANXESS Corporation.



HBL63CM60



HBL77CM15



HBL77CM17

50A Ship-to-Shore Devices

50 Amp 125 Volt Cable Sets and Bulk Cable

Our 50A 125V cable set is packed with high performance details from end to end that make a real difference. Completely factory pre-wired with molded-on devices. Designed to coil easily and lay flat.

IP56
SUITABILITY
(Boatside)



50A 125V



HBL61CM53
HBL61CM43

50A 125V Cable Sets and Twist-Lock® Devices

Description	Catalog Number
Yellow 50 ft. (15.2m) vinyl jacketed shore power cable set. #6 AWG type STOW is completely factory pre-wired with molded-on devices. Connector end has threaded metallic sealing ring to make inlet/connector interface watertight. IP54 SUITABILITY (BOATSIDE).	HBL61CM53
Same as HBL61CM53 except with two high intensity LEDs.	HBL61CM53LED
Same as HBL61CM53 except 25 ft. (7.6m) in length.	HBL61CM43
Same as HBL61CM43 except with two high intensity LEDs.	HBL61CM43LED
Three conductor, #6 AWG type STOW, yellow PVC jacketed portable cord with jute fillers for added flexibility. Ideal for making cable sets, extension cords and adapters will not mark boat's deck. 250 ft. (75.2m) lengths only.	YC306250
Nickel plated brass plug has heat resistant thermoset interior and combination metal and rubber cord grip, provides superior strain relief capability. Cord grip range is .44–1.14 in. (11.1–29.0). IP20 SUITABILITY.	HBL63CM61*
Single receptacle has a heat-resistant thermoset base. IP20 SUITABILITY.	HBL63CM70*

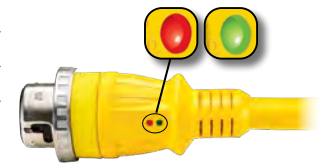

HBL61CM53LED
HBL61CM43LED

Note: *UL Listed and CSA Certified.

See page AA-13 for features and benefits.



HBL63CM61

Boots and Weatherproof Plates

Description	Catalog Number
Yellow Seal-Tite® cover for weatherproofing 50A plugs. IP55 SUITABILITY.	HBL77CM16**
White Seal-Tite cover for weatherproofing 50A plugs. IP55 SUITABILITY.	HBL77CM16W**
Yellow Valox® lift cover for weatherproofing 50A receptacles. Meets requirements of the most stringent of UL's three listing categories for weatherproof plates. Stainless steel screws and a neoprene gasket included. For mounting to FS/FD type weatherproof boxes. IP44 SUITABILITY.	HBL77CM74WO
Same as HBL77CM74WO except gray in color. IP44 SUITABILITY.	HBL7774WO
Stainless steel wall plate for 50A receptacle.	SS750

Note: **Not UL Listed or CSA Certified.



HBL63CM70



HBL77CM16



HBL77CM74WO



HBL7774WO



SS750



HBL77CM16W

Valox® is a trademark of SABIC Innovative Plastics, acquired from General Electric Company.

50A Ship-to-Shore Devices

50 Amp 125/250 Volt Traditional Stainless Steel Inlets

Traditional stainless steel shore power inlet has gasketed, self-closing cover so interior is shielded from the elements when not in use. Watertight when cover is securely fastened. Mounting holes are 2.38 in. (60.3) on centers and rear portion has 2.17 in. (55.1) diameter. Mounting screws and gasket included.

- Self-closing cover is friction tight to remain open while engaging cable set and shields the interior from the elements when the inlet is not in use
- Neoprene gasket on underside of cover. For sealing when the cover is closed



Housing Design

- Base and cover are #316 type stainless steel for strength and corrosion resistance
- Threaded base for making a watertight seal; when in use, it mates to the threaded ring of the weatherproof cover on the connector body; when not in use, it mates to the threaded cover

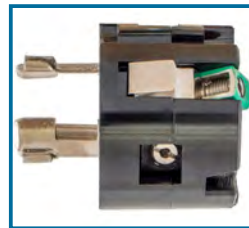

Interior Design

- Contact blades are nickel plated brass for corrosion resistance
- Pressure screw terminals for secure terminations clearly marked for easy identification
- Thermoset contact carrier is arcing and heat resistant



HBL504NM



Terminations

- Three screws "lock-in" the interior once it is in place
- Rear enclosure is nickel plated for corrosion resistance



50A
125/250V
UL/CSA

50A 125/250V Twist-Lock® Devices

Description	Catalog Number
Stylized non-metallic shore power inlet has UV resistant white Centrex® cover which makes unit weatherproof when completely closed. Interior is heat resistant thermoset material and has box lug terminals. Mounting holes are 2.38 in. (60.3) on centers and match existing mounting patterns. Mounting screws and gasket included. IP55 SUITABILITY.	HBL504NM
Traditional stainless shore power inlet has gasketed, self-closing cover so that the interior is shielded from the elements when not in use. It is watertight when the cover is securely fastened. The mounting holes are 2.38 in. (60.3) on centers and the rear portion has a 2.17 in. (55.1) diameter. Mounting screws and gasket are included. IP56 SUITABILITY.	HBL504SS
Nickel plated brass connector body has a heat resistant thermoset interior and combination metal and rubber cord grip, which provides superior strain relief capability. Cord grip range is .44–1.14 in. (11.1–29.0). IP20 SUITABILITY.	HBL63CM64

Boots and Weatherproof Plates

Description	Catalog Number
Protective rear cover. Fits all inlets except HBL504SS. Secures to back of inlets with three screws which are provided.	SR3050**
Replacement interior for 63CM74 and HBL504SS power inlets.	CR16279**
Yellow Seal-Tite® cover for connector bodies when used with 50A shore power inlets. Threaded sealing ring makes connections watertight. IP56 SUITABILITY.	HBL77CM15**
White Seal-Tite cover for connector bodies when used with 50A shore power inlets. Threaded sealing ring makes connections watertight. IP56 SUITABILITY.	HBL77CM15W**
Yellow Seal-Tite cover for weatherproofing 50A connector bodies on extension cords or adapters. IP55 SUITABILITY.	HBL77CM17**
Nickel plated brass cord clamp assembly with clamp range of .44–1.14 in. (11.1–29.0) provides strain relief for terminations on shore power inlets.	HBL77CM67

Note: **Not UL Listed or CSA Certified.

Centrex® is a registered trademark of LANXESS Corporation.



HBL63CM64



HBL77CM15



HBL77CM17

50A Ship-to-Shore Devices

50 Amp 125/250 Volt AC Cable Sets and Bulk Cable

Our 50A 125/250V AC cable set is packed with high performance details from end to end that make a real difference. Completely factory pre-wired with molded-on devices. Designed to coil easily and lay flat.



HBL61CM52
HBL61CM52LED
HBL61CM42
HBL61CM42W

50A 125/250V Cable Sets and Twist-Lock® Devices

Description	Catalog Number
Yellow 50 ft. (15.2m) vinyl jacketed shore power cable set, #6 AWG type STOW is completely factory pre-wired with molded-on devices. The connector end has a metallic threaded sealing ring for making the inlet/connector interface watertight. IP56 SUITABILITY (BOATSIDE).	HBL61CM52
Same as HBL61CM52 except with two high intensity LEDs	HBL61CM52LED
Same as HBL61CM52 except white in color.	HBL61CM52W
Same as HBL61CM52LED except white in color.	HBL61CM52WLED
Yellow 25 ft. (7.6m) vinyl jacketed shore power cable set, #6 AWG type STOW is completely factory pre-wired with molded-on devices. The connector end has a metallic threaded sealing ring for making the inlet/connector interface watertight. IP56 SUITABILITY (BOATSIDE).	HBL61CM42
Same as HBL61CM52LED except 25 ft. (7.6m) in length.	HBL61CM42LED
Same as HBL61CM42 except white in color.	HBL61CM42W
Same as HBL61CM42LED except white in color.	HBL61CM42WLED
Four conductor, #6 AWG type STOW, yellow PVC jacketed portable cord with jute fillers for added flexibility is ideal for making cable sets, extension cords and adapters that will not mark the boats deck. Available in 250 ft. (76.2m) lengths only.	YC406250
Nickel plated brass plug has a heat resistant thermoset interior and combination metal and rubber cord grip, which provides superior strain relief capability. Cord grip range is .44-1.14 in. (11.1-29.0). IP20 SUITABILITY.	HBL63CM65*
Single receptacle has a heat resistant thermoset base. IP20 SUITABILITY.	HBL63CM69*

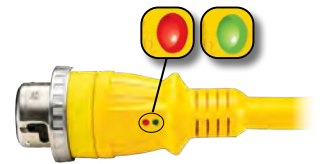

HBL61CM52LED
HBL61CM42LED



HBL63CM65

Boots and Weatherproof Plates

Description	Catalog Number
Yellow Seal-Tite® cover for weatherproofing 50A plugs. IP55 SUITABILITY.	HBL77CM16**
White Seal-Tite® cover for weatherproofing 50A plugs. IP55 SUITABILITY.	HBL77CM16W**
Yellow Valox® lift cover for weatherproofing 50A receptacles. Meets requirements of the most stringent of UL's three listing categories for weatherproof plates. Stainless steel screws and a neoprene gasket included. For mounting to FS/FD type weatherproof boxes. IP44 SUITABILITY.	HBL77CM74WO
Same as HBL77CM74WO except gray in color. IP44 SUITABILITY.	HBL774WO
Stainless steel wall plate for 50A receptacle.	SS750

Note: **Not UL Listed or CSA Certified.



HBL77CM16



HBL77CM74WO



HBL774WO



SS750



HBL77CM16W

Valox® is a trademark of SABIC Innovative Plastics, acquired from General Electric Company.

Features and Benefits

100 Amp Pin and Sleeve Devices

- Hubbell Marine was the first to offer 100 amp marine grade devices that are considered second to none
- Hubbell developed the standard for 100 amp Pin and Sleeve devices with the National Electric Code and the American Boat and Yacht Council



Housing Design

- Supertough nylon housing provides increased safety and abuse resistance
- High visibility yellow, STOW cable, 105°C rated and UL listed
- The gasketed locking ring engages the mating device and when rotated and locked makes the interface between the devices watertight



Housing Design

- Nylon housing provides increased safety and resistance
- The gasketed, self-closing cover is keyed to normally seat in a position that provides a weatherproof seal; simply rotating the cover and locking it makes it watertight
- The device is marked with its catalog number and rating for easy identification



Interior Design

- High impact thermoset contact carrier is arcing and heat resistant
- Two screw pressure terminals provide reliable terminations
- Nickel plated solid brass pins provide for long life and reliable electrical contact in corrosive environments
- Special keying makes proper alignment of mating devices quick and easy



Interior Design

- High impact thermoset contact carrier is arcing and heat resistant
- The terminals are clearly identified with large markings for easy recognition
- Nickel plated solid brass contacts provide for long life and reliable electrical contact in corrosive environments
- Special keying makes proper alignment of mating devices quick and easy



Exterior Design

- Massive external cable grips protect the wiring from conductor movement which can cause strain on the terminals
- All screws are stainless steel for corrosion resistance
- The device is marked with its catalog number and rating for easy identification

Marine Products

100A Ship-to-Shore Devices

100 Amp Cable Sets

- Only Hubbell offers 3, 4 and 5 wire 100 amp cable sets for your shore power requirements
- Cable sets manufactured in factory-controlled conditions using specially compounded cable to accommodate a full 100 amperes



Note: Cable sets must be fully extended before using.

IP56
SUITABILITY



100A
125/250V AC



100A 3ØY
120/208V AC

100A Pin and Sleeve Cable Sets

Description	Catalog Number	
Yellow 75 ft. (22.8m) corrosion-resistant shore power cable set, 105°C rated, #2 AWG, (no neutral), STOW cable with plug and connector body for use with boats with isolation transformer on board.	CS75IT4*	CS75IT5
Same as above except 100 ft. (30.4m) in length.	CS100IT4	CS100IT5
Yellow 75 ft. (22.8m) corrosion-resistant shore power cable set, 105°C rated, #2 AWG, STOW cable.	CS754	—
Same as CS754/5 except 100 ft. (30.4m) in length.	CS1004	—
Yellow 50 ft. (15.2m) corrosion-resistant extension cord, 105°C rated, #2 AWG, STOW cable. For mating with existing shore power cable set.	CS50EXT4	CS50EXT5
Yellow 75 ft. (22.8m) corrosion-resistant one-ended (male only) power supply cable, 105°C rated, #2 AWG, STOW cable with 3 pole 4 wire male plug only; for use with boats using a cable winch system.	CW754	—
Yellow 100 ft. (30.4m) corrosion-resistant one-ended (male only) power supply cable, 105°C rated, #2 AWG, (no neutral) STOW cable with male plug only; for use with boats with isolation transformer on board and a cable winch system.	CW100IT4	CW100IT5
Same as CW100IT4/5 except 125 ft. (38.0m) in length.	CW125IT4	CW125IT5
Same as CW100IT4/5 except white in color.	CW100IT4W	—



CS75IT4
CS100IT4



CS100IT4W

Note: Periodic cleaning and lubrication (such as LPS-1® made by Holt Lloyd Corp.) of the pins and sleeves of these devices is necessary to enjoy years of optimal use.
*Also available in white, consult factory.

100A Ship-to-Shore Devices



M4100P12



M4100R12



M4100C12



M4100B12R



M4100C12R



FW60100



BB1001W
BB1002W

Dimensions in Inches (mm)

100A 125/250V Pin and Sleeve Devices

Description	Catalog Number
Yellow Zytel® super tough nylon watertight plug has gasketed locking ring to make plug/receptacle interface watertight. Cord grip range is 1.06–1.94 in. (26.9–49.3). IP56 SUITABILITY.	M4100P12
Gray nylon docksides receptacle has gasketed, spring-loaded cover. Closes automatically when not in use and is watertight when securely fastened. Mounting holes are 4.88 in. (123.8) on centers. Mounting screws and gasket included. IP56 SUITABILITY.	M4100R12
Yellow Zytel® super tough nylon watertight connector body for mating plug to connector interface on extension cords or adapters. Cord grip range is 1.06–1.94 in. (26.9–49.3). Note: It cannot be mated to the shore power inlet. IP56 SUITABILITY.	M4100C12
Gray nylon shore power inlet has gasketed, spring-loaded cover which closes automatically when not in use and is watertight when securely fastened. Mounting holes are 4.88 in. (123.8) on centers and rear portion has 3.94 in. (100.0) diameter. Mounting screws and gasket included. IP56 SUITABILITY.	M4100B12R
Yellow Zytel® super tough nylon watertight connector body has gasketed locking ring to make inlet/connector interface watertight. Cord grip range is 1.06–1.94 in. (26.9–49.3). Note: This device mates with shore power inlet only. IP56 SUITABILITY.	M4100C12R



100A
125/250V AC

100A Back Boxes and Accessories

Description	Catalog Number
Back box for inlets and receptacles has 15° angle section which can be installed in any of 4 positions. Box is cast aluminum with corrosion-resistant gray alkyd-based enamel finish and 1½ in. NPT hub which can be mounted for either top or bottom feed. IP56 SUITABILITY.	FW60100
15° angle cast aluminum back box has corrosion-resistant gray finish and top hub with 1½ in. NPT 100A receptacles can be mounted directly to it.	BB1001W
Same as BB1001W except threaded top hub is 2 in. NPT.	BB1002W
15° angle non-metallic back box, made of high-grade engineered thermoplastic Valox® to resist chemicals, abuse and U.V. rays. Has integral grounding plate, 1½ in. NPT hub size and 120 cu. in. capacity (hub is not included - Raco part number 1706 is recommended). IP57 SUITABILITY.	BB100N
Closure Cap for 100A plugs and connector bodies that (do not have a cap attached) have locking rings.	PC100
Replacement lift cover assembly; includes cover, arm and assembly tool.	CA100
Replacement locking ring and cord clamp.	CC100
Replacement locking ring only.	LR100

Note: Periodic cleaning and lubrication (such as LPS-1® made by Holt Lloyd Corp.) of the pins and sleeves of these devices is necessary to enjoy years of optimal use.

Product Dimensions Inches (mm)

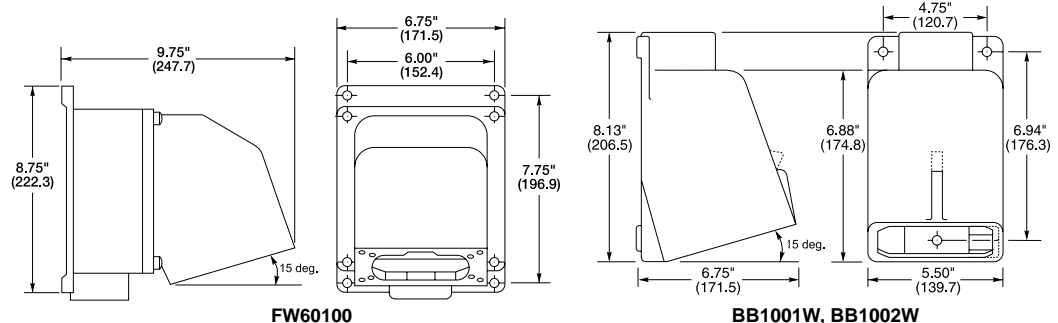

Zytel® is a registered trademark of E.I. DuPont.

Valox® is a trademark of SABIC Innovative Plastics, acquired from General Electric Company.

100A Ship-to-Shore Devices

100A 3ØY 120/208V and 3ØY 277/480V Devices



Description	Catalog Number	
Yellow Zytel® super tough nylon watertight plug has gasketed locking ring to make plug/receptacle interface watertight. Cord grip range is 1.06–1.94 in. (26.9–49.3). IP56 SUITABILITY.	M5100P9	M5100P7
Gray nylon dockside receptacle has gasketed, spring-loaded cover. Closes automatically when not in use and is watertight when securely fastened. Mounting holes are 4.88 in. (123.8) on centers. Mounting screws and gasket included. IP56 SUITABILITY.	M5100R9	M5100R7
Yellow Zytel® super tough nylon watertight connector body for making plug to connector interface on extension cords or adapters. Cord grip range is 1.06–1.94 in. (26.9–49.3). Note: It cannot be mated to the shore power inlet. IP56 SUITABILITY.	M5100C9	M5100C7
Gray nylon shore power inlet has gasketed, spring-loaded cover which closes automatically when not in use and is watertight when securely fastened. Mounting holes are 4.88 in. (123.8) on centers and rear portion has 3.94 in. (100.0) diameter. Mounting screws and gasket included. IP56 SUITABILITY.	M5100B9R	M5100B7R
Yellow Zytel® super tough nylon watertight connector body has gasketed locking ring to make inlet/connector interface watertight. Cord grip range is 1.06–1.94 in. (26.9–49.3). Note: This device mates with shore power inlet only. IP56 SUITABILITY.	M5100C9R	M5100C7R



M5100P9



M5100R9



M5100C9



M5100B9R



M5100C9R

100A Back Boxes and Accessories

Description	Catalog Number
Back box for inlets and receptacles has 15° angle section which can be installed in any of 4 positions. Box is cast aluminum with corrosion-resistant gray alkyd-based enamel finish and 1½ in. NPT hub which can be mounted for either top or bottom feed. IP56 SUITABILITY.	FW60100
15° angle cast aluminum back box has corrosion-resistant gray finish and top hub with 1½ in. NPT 100A receptacles can be mounted directly to it.	BB1001W
Same as BB1001W except threaded top hub is 2 in. NPT.	BB1002W
15° angle non-metallic back box, made of high-grade engineered thermoplastic Valox® to resist chemicals, abuse and U.V. rays. Has integral grounding plate, 1½ in. NPT hub size and 120 cu. in. capacity (hub is not included - Raco part number 1706 is recommended). IP57 SUITABILITY.	BB100N
Closure Cap for 100A plugs and connector bodies that (do not have a cap attached) have locking rings.	PC100
Replacement lift cover assembly; includes cover, arm and assembly tool.	CA100
Replacement locking ring and cord clamp.	CC100
Replacement locking ring only.	LR100

Note: Periodic cleaning and lubrication (such as LPS-1® made by Holt Lloyd Corp.) of the pins and sleeves of these devices is necessary to enjoy years of optimal use.

Product Dimensions Inches (mm)

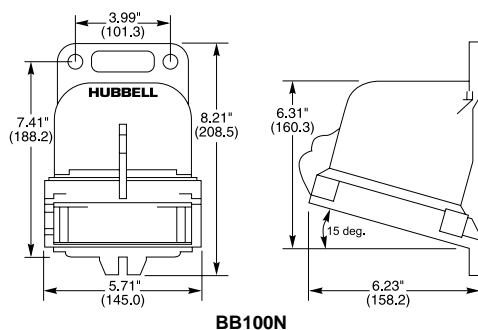

BB100N

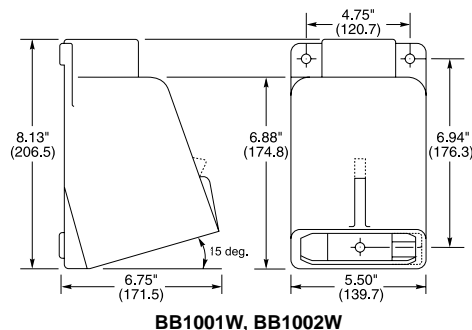

BB1001W, BB1002W



BB100N



PC100

Zytel® is a registered trademark of E.I. DuPont.
Valox® is a trademark of SABIC Innovative Plastics, acquired from General Electric Company.

Dimensions in Inches (mm)

Features and Benefits

200 Amp Pin and Sleeve Devices

Hubbell was the first to offer a UL listed 100 amp Marine Ship-To-Shore System... and now, we are the first to offer a UL listed 200 amp Marine Ship-To-Shore System.

The only 200 amp rated Ship-to-Shore System - built specifically for Mega-Yachts.

Hubbell 200 amp devices are listed to UL1682 and UL Classified for the mating and operation of 200 amp devices. Mates with Cooper® Crouse-Hinds® Arkrite® or Appleton® Powertite® (when installed in accordance with instructions furnished with device).



Housing Design

- Pins and Sleeves are made of nickel-plated Tellurium copper for superior corrosion and heat resistance
- UL Listed and CSA Certified



Housing Design

- Housing is made of copper-free aluminum with an electrostatically applied epoxy/polyester finish
- Type 3, 4, 4X Rated per UL50 standard for superior water resistance



Interior Design

- Interchangeable with other "UL1686 Series C1" Listed devices
- Terminal screws feature swivel/pressure pads to secure and prevent damage to conductors strands



Interior Design

- Interchangeable with other "UL1686 Series C1" Listed devices
- Terminal screws feature swivel/pressure pads to secure and prevent damage to conductors strands



Exterior Design

- Cable clamp captures cable at four points, provides superior retention
- Accepts a cord range of #1 AWG – 250 MCM

Appleton® and Powertite® are registered trademarks of Appleton Electric Company. Cooper Crouse-Hinds® and Arkrite® are registered trademarks of Cooper Industries, Inc.

200A Ship-to-Shore Devices



200A
600V AC/250V DC

200A 600V AC/250V DC, 50-400 Hertz Pin and Sleeve Devices

Description	Catalog Number
Gray metallic, watertight boatside power inlet with wingnut-secured lid for water tightness when not in use.	M5200BS1R
Gray/yellow metallic, watertight boatside connector body with locking ring to make inlet/connector body interface watertight. Cord grip range is #1 AWG-250 MCM 1.00-2.5 in. (25.4-6.35).	M5200CS1R
Gray/yellow metallic, watertight dockside plug with locking ring to make plug/receptacle interface watertight. Cord grip range is #1 AWG-250 MCM 1.00-2.5 in. (25.4-6.35).	M5200PS1
Gray metallic, watertight dockside receptacle with wing nut-secured lid for water tightness when not in use.	M5200RS1
Gray/yellow metallic, watertight dockside connector body with wing nut-secured lid for water tightness when not in use. For making plug/connector body interface on extension cords or adapters.	M5200CS1



M5200BS1R



M5200CS1R



M5200PS1



M5200RS1



M5200CS1



MB2003W

200A Back Boxes

Description	Catalog Number
Gray metallic back box for inlets and receptacles has 45° angle section which can be installed in any of 4 positions, 2 in. NPT hub.	MB2003W
Gray metallic back box – same as above but 2½ in. NPT hub.	MB2004W

Product Dimensions Inches (mm)

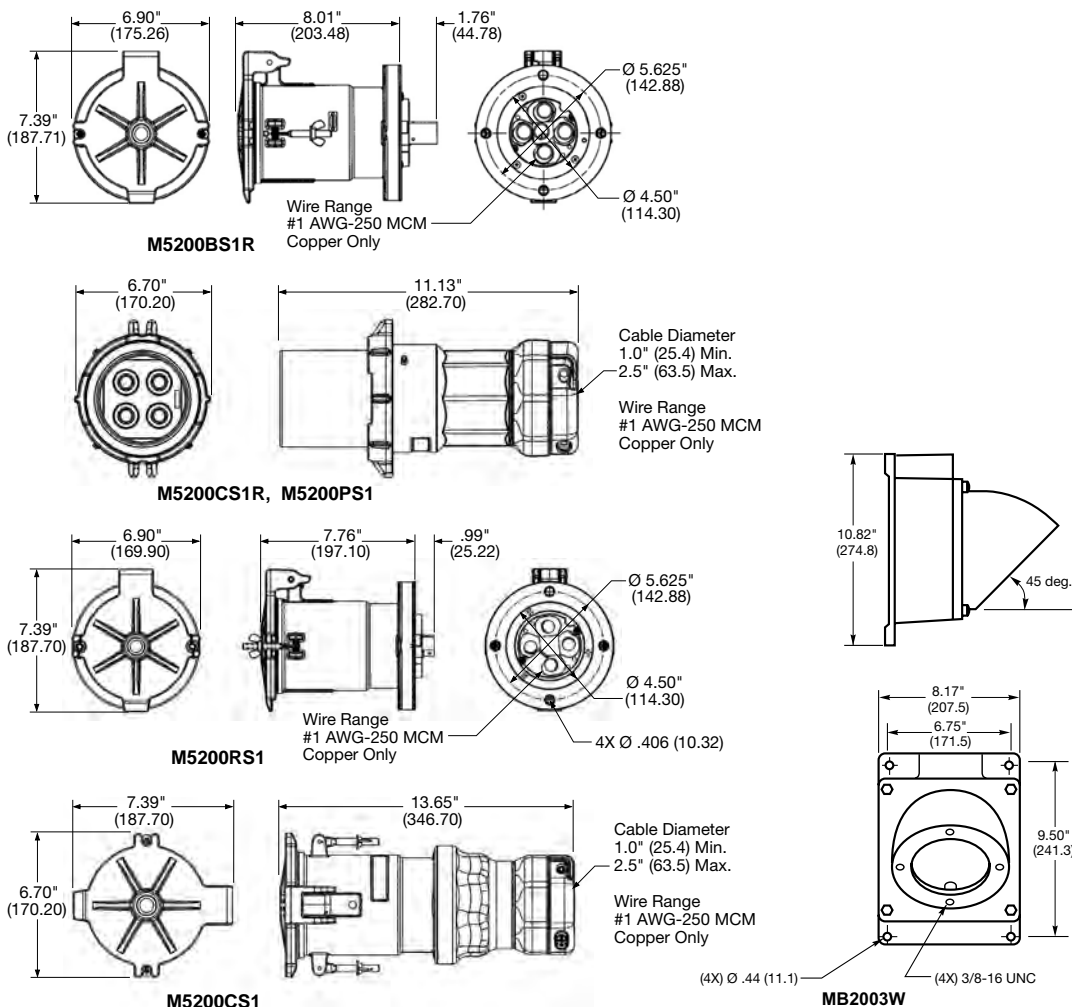

Dimensions in Inches (mm)

Features and Benefits

Internationally Rated Conventional-Styled Devices

Hubbell offers the only CE certified electrical shore power systems truly dedicated for boats destined for Europe and the International community. Hubbell's offering of international shore power inlets are available in traditional #316 stainless steel and attractive white non-metallic types resembling our domestic offering in style and appearance but are not interchangeable with the domestic shore power system.

Utilizing standard NEMA (National Electrical Manufacturer's Association) configurations not typically used in the marine market, Hubbell can offer a safe and non-interchangeable 16 amp 230 volt system and 32 amp 230 volt system for use with 50 cycle systems. The system includes white power supply cables (one-end, female only) in both the 16 amp and 32 amp categories.

Hubbell also offers a series of Internationally Rated Pin and Sleeve Devices, available in 16A, 32A and 63A 240V, these devices are interchangeable with other manufactures of UL1686 C1 devices.



Housing Design

- Base and cover are #316 type stainless steel for strength and corrosion resistance
- Self-closing cover is friction tight to remain open while engaging cable set and shields the interior from the elements when the inleet is not in use

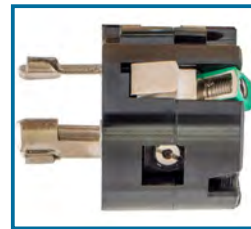

Interior Design

- Contact blades are nickel plated brass for corrosion resistance
- Watertight seal when in use, threaded base mates to the threaded ring of the watertight cover on the connector body; when not in use, it mates to the threaded cover



Housing Design

- White Centrex® cover and PBT base, weatherproof when closed
- Easy to wire polycarbonate interior is heat resistant and clear for visual inspection (16 amp and 32 amp)



Terminations (63 Amp)

- Thermoset contact carrier is arcing and heat resistant
- Three screws "lock-in" the interior once it is in place
- Rear enclosure is nickel plated for corrosion resistance



HBL320R6W

HBL320B6W

HBL320C6W

HBL320P6W

IP66
SUITABILITY

Internationally Rated* Pin and Sleeve Devices, 2 Pole Plus Earth (⊥)

*Now Dual-Rated to match North American Configurations as well as International

Description	16A / 20A	30A / 32A	60A / 63A
	220-240V / 250V		
Shore power inlet with mounting holes 3.13 in. (79.3) on centers and 2.72 in. (69.1) diameter on rear portion.	HBL320B6W	HBL330B6W	HBL360B6W
Connector body with cord grip range of .36-.83 in. (9.1-21.1).	HBL320C6W	HBL330C6W	HBL360C6W
Shore power receptacle with mounting holes 3.13 in. (79.3) on centers and 2.72 in. (69.1) diameter on rear portion.	HBL320R6W	HBL330R6W	HBL360R6W
Plug with cord grip range of .36-.83 in. (9.1-21.1).	HBL320P6W	HBL330P6W	HBL360P6W
Closure plug for inlets.	PC320**	PC3430**	PC60**
Back box for inlets and receptacles is cast aluminum with corrosion-resistant alkyd-based enamel finish and two ¼ in. NPT hubs.	BB201W	BB301W	BB601W
Feed-thru box for inlets and receptacles is cast aluminum with corrosion-resistant alkyd-based enamel finish and one ¼ in. NPT hubs.	FT202W	FT202W	FW60100

Note: **Not CSA Certified.

Centrex® is a registered trademark of LANXESS Corporation.

Marine Products

Internationally Rated Conventional-Styled Devices

Twist-Lock® Devices, Ship-To-Shore Power System

Description	16A 230V	32A 230V, 50 Cycle
Non-metallic, white, stylized, UV resistant shore power inlet. White Centrex® cover makes the inlet weatherproof when closed. Mounting holes are 2.38 in. (60.3) on centers and match most existing mounting patterns. Rear enclosure strain/relief cap is provided. IP55 SUITABILITY.	HBL316NM	HBL332NM
Traditional, stainless steel shore power inlet has easy-to-wire terminations. Interior is transparent for quick and easy visual inspection. Interior is shielded from the elements by a gasketed, self-closing cover, watertight when cover is screwed in place. Mounting holes are 2.38 in. (60.3) on centers. Mounting screws and gasket included. Protective rear enclosure/strain relief also included. IP56 SUITABILITY.	HBL316SSX	HBL332SSX
Yellow locking connector replacement end for HBL316CS25 and HBL316CS. IP20 SUITABILITY.	HBL316CRCX	HBL332CRCX
White Seal-Tite® cover with threaded sealing ring for use with HBL316CRC and HBL332CRC connector bodies. IP56 SUITABILITY.	HBL60CM33W	HBL60CM33W
White Seal-Tite® cover with threaded sealing ring for use with HBL316CRC and HBL332CRC connector bodies. IP56 SUITABILITY.	HBL60CM33	HBL60CM33



HBL316NM
HBL332NM



HBL316SSX
HBL332SSX



HBL316CRCX
HBL332CRCX



HBL60CM33
HBL60CM33W



63A
230V



HBL363SSX

63A 230V Ship-To-Shore Power Systems

Description	Catalog Number
Traditional, stainless steel shore power inlet, including higher-quality metal threads, heat-resistant thermoset interior and box lug terminals. IP56 SUITABILITY.	HBL363SSX
Nickel plated brass plug with heat-resistant thermoset interior and box lug terminals cord grip range is .44 – 1.14 in. (11.1 - 29.0). IP55 SUITABILITY.	HBL363CRP
Nickel plated brass connector body with heat-resistant thermoset interior and box lug terminals. Cord grip range is .44 – 1.14 in. (11.1 - 29.0). IP55 SUITABILITY.	HBL363CRC
Single receptacle with heat-resistant thermoset base. IP20 SUITABILITY.	HBL363CRR
Yellow Seal-Tite® cover for connector bodies when used with 63A shore power inlets. Stainless steel threaded sealing ring makes connections watertight. IP56 SUITABILITY.	HBL77CM15
Same as HBL77CM15 except white in color.	HBL77CM15W
Yellow Seal-Tite® cover for 63A plugs. IP55 SUITABILITY.	HBL77CM16
Same as HBL77CM16 except white in color.	HBL77CM16W



HBL363CRP



HBL363CRC



HBL363CRR



HBL77CM15



HBL77CM16W

Centrex® is a registered trademark of LANXESS Corporation.

Marine Products

Features and Benefits

Intelligent Y Adapters

YQ230 - Safely powers a 50A 125/250V AC boat from two 30A 125V AC receptacles at dockside.*

Problem: A boat owner with one electrical system on board docks in a marina that can only provide a different electrical system.

Solution: Use of the Hubbell YQ series of Intelligent Adapters can correct many electrical system mismatches.

*Note: *The two 30 amp receptacles must be on separate phases to function.*



YQ230



Housing Design

- Rugged UV resistant high-impact housing
- Environmentally sealed against humidity, fog and rain
- Cord clamps prevent strain on terminals
- Sealing grommets keep moisture out



Safety

- Safety indicator light, (when ON, safe operation is indicated)
- 3 pole contactor breaks both hots and neutrals to prevent possibility of "live" plug when not engaged

Intelligent Y Adapters

Description	Catalog Number
Adapter that permits use of 50A 125/250V AC cable set. (HBL61CM52), with two 30A 125V AC receptacles, HBL26CM10.	YQ230
Adapter that permits use of 100A 125/250V AC cable set. (CS754, CS1004) with one or two 50A 125/250V AC receptacles, HBL63CM69.	YQ100PLUS

Note: The YQ230 Adapter will only work with two 30A receptacles that are on different phases.

The YQ100PLUS Adapter must be plugged into two 50A 125/250V AC receptacles that are on the same phase to achieve 100 amp, 125/250 volts power — or the "A" leg 50A male can be plugged into a single 50A 125/250V AC receptacle to achieve 50 amp, 125/250 volts power.

Intelligent Y Adapters

YQ100PLUS - Safely powers a 100A 125/250V AC boat from two 50A 125/250V AC receptacles at dockside -or- from a single 50A 125/250V AC receptacle acting as a single adapter.

Internal Logic Senses That:

- Both plugs are fully engaged (i.e., one is not dangling loose while the other is plugged in) -or- the "A" leg plug is engaged to access a single 50A 125/250V receptacle
- The polarity of the receptacle on the dock is correct (i.e., no mis-wiring of the hot and neutral wires)
- The two receptacles are from correct phases

CAUTION: This adapter must be connected to an onboard, center-tapped isolation transformer or shore power converter. DO NOT USE this adapter if such a transformer or converter is not available.



YQ100PLUS



Housing Design

- Rugged, smaller, lighter-weight enclosure
- Environmentally sealed against humidity, fog and rain
- Sealing grommets keep moisture out



Safety

- Indicator lights indicate correct polarity and safe operation
- "A" leg for accessing a single 50A 125/250V receptacle

Marine Products

Features and Benefits

Hubbell Molded Adapters

Hubbell Straight Adapters (pigtails) and “Y” Adapters are built to the same standards as all Hubbell Shore Power Cords.

Filled with end-to-end features and weathertight when mated with Hubbell shore cords without the need for extra collars, etc.

Hubbell Marine Adapters deliver the power you need.

- Available in a variety of configurations
- Now CSA Compliant



Housing Design

- Fully molded fittings (except 100A) for superior waterproofing and durability
- Hubbell adapters are weatherproof when mated with Hubbell cable sets



Interior Design

- Terminations utilize exclusive copper crimp barrel terminations, holds over 300% more securely
- Bull ring for strain relief on the terminals
- Nickel plated brass contact blades for corrosion-resistance



Safety

- Provides 15 amp convenience power with GFCI protection
- Manual reset button
- High impact PVC housing, UV stabilized
- Sealed GFCI housing and keypad
- Large LED power “ON” light

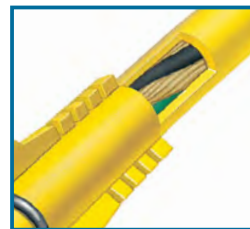

Cord Flexibility

- Molded-in flex feature controls the angle of cord entry and keeps water out
- Jute fillers inside jacket for maximum cable flexibility; Hubbell cable coils neater, lighter and lays flatter

Adapter Selection Guide

Boat/Cable Set Side Connector Body (Female End)	Molded Straight Adapters		Power Center/Dock Side Plug (Male End)
15A 125V, 2P 3W Straight Blade with GFCI protection		HBL105GF	30A 125V, 2P 3W Twist-Lock®
30A 125V, 2P 3W Twist-Lock		HBL61CM22 HBL61CM22W	15A 125V, 2P 3W Straight Blade (lock type)
30A 125V, 2P 3W Twist-Lock		HBL61CM25	20A 125V, 2P 3W Twist-Lock
50A 125V, 2P 3W Twist-Lock		HBL61CM54	15A 125V, 2P 3W Straight Blade
30A 125V, 2P 3W Twist-Lock		HBL61CM55	50A 125V, 2P 3W Twist-Lock
50A 125V, 2P 3W Twist-Lock		HBL61CM56	30A 125V, 2P 3W Twist-Lock
30A 125V, 2P 3W Twist-Lock		HBL61CM71	50A 125/250V, 3P 4W Twist-Lock
50A 125V, 2P 3W Twist-Lock		HBL61CM72	50A 125/250V, 3P 4W Twist-Lock
100A 125/250V, 3P 4W Pin and Sleeve		HBL61CM100	50A 125/250V, 3P 4W Twist-Lock
Molded Y Adapters			
(2) 30A 125V, 2P 3W Twist-Lock		HBL64CM54	50A 125/250V, 3P 4W Twist-Lock
(2) 50A 125V, 2P 3W Twist-Lock		HBL64CM55	50A 125/250V, 3P 4W Twist-Lock
(2) 30A 125V, 2P 3W Twist-Lock		HBL64CM56	30A 125V, 2P 3W Twist-Lock
(2) 30A 125V, 2P 3W Twist-Lock		HBL64CM57	50A 125V, 2P 3W Twist-Lock
One Piece Adapters			
30A 125V, 2P 3W Twist-Lock		HBL31CM28	15A 125V, 2P 3W Straight Blade
15 or 20A 125V, 2P 3W Straight Blade		HBL31CM29	30A 125V, 2P 3W Twist-Lock
20A 125V, 2P 3W Twist-Lock		HBL21CM28	15A 125V, 2P 3W Straight Blade
15 or 20A 125V, 2P 3W Straight Blade		HBL21CM29	20A 125V, 2P 3W Twist-Lock

Note: See page AA-27 for features and benefits.
See page AA-29 for photographs and descriptions.

Molded Adapters

Molded Straight Adapters – Now CSA Compliant

Description	Catalog Number
Permits use of 20A 125V Twist-Lock® locking type plug with 15 or 20A 125V straight blade receptacle. IP20 SUITABILITY.	HBL21CM28*
Permits use of 15A or 20A 125V straight blade plug with 20A 125V Twist-Lock locking type receptacle. IP20 SUITABILITY.	HBL21CM29*
Permits use of 30A 125V Twist-Lock locking type plug with 15 or 20A 125V straight blade receptacle. IP20 SUITABILITY.	HBL31CM28
Permits use of 15A or 20A 125V straight blade plug with 30A 125V Twist-Lock locking type receptacle. IP20 SUITABILITY.	HBL31CM29
Permits use of 30A 125V cable set, HBL61CM08 with 15 or 20A 125V straight blade receptacle. Anchor locking screw on plug when screwed down resists pullout of the cable set. IP55 SUITABILITY (CONNECTOR).	HBL61CM22
Same as HBL61CM22, except white.	HBL61CM22W
Permits use of 30A 125V cable set, HBL61CM08 with 20A 125V Twist-Lock receptacle, HBL23CM10. IP55 SUITABILITY (CONNECTOR).	HBL61CM25
Permits use of 50A 125V cable set, HBL61CM53 with 15 or 20A 125V straight blade receptacle. IP55 SUITABILITY (CONNECTOR).	HBL61CM54
Permits use of 30A 125V cable set, HBL61CM08 with 50A 125V Twist-Lock receptacle, HBL63CM70. IP55 SUITABILITY (CONNECTOR).	HBL61CM55
Permits use of 50A 125V cable set, HBL61CM53 with 30A 125V Twist-Lock receptacle, HBL26CM10. IP55 SUITABILITY (CONNECTOR).	HBL61CM56
Permits use of 30A 125V cable set, HBL61CM08 with 50A 125/250V Twist-Lock receptacle, HBL63CM69. IP55 SUITABILITY (CONNECTOR).	HBL61CM71^
Permits use of 50A 125V cable set, HBL61CM53 with 50A 125/250V Twist-Lock receptacle, HBL63CM69. IP55 SUITABILITY (CONNECTOR).	HBL61CM72^
Permits use of 15A 125V 3 wire straight blade plug with 15 or 20A 125V 2 wire straight blade receptacle. IP55 SUITABILITY (CONNECTOR).	HBL5273L*
Permits a 100A 125/250V cable set to plug into a single 50A 125/250V outlet. IP55 SUITABILITY (CONNECTOR).	HBL61CM100**
Permits use of 15A straight blade plug with 30A 125V Twist-Lock receptacle; with GFCI protection. IP55 SUITABILITY (PLUG).	HBL105GF**



HBL31CM28



HBL21CM29



HBL61CM22



HBL61CM25



HBL61CM54



HBL61CM55



HBL61CM56



HBL105GF

Molded Y Adapters – Now CSA Compliant

Description	Catalog Number
Permits use of two 30A 125V cable sets, HBL61CM08, with one 50A 125/250V receptacle, HBL63CM69. IP55 SUITABILITY (CONNECTORS).	HBL64CM54
Permits use of two 50A 125V cables sets, HBL61CM53, with one 50A 125/250V receptacle, HBL63CM69. IP55 SUITABILITY (CONNECTORS).	HBL64CM55
Permits use of two 30A 125V cable sets, HBL61CM08, with one 30A 125V receptacle, HBL26CM10. IP55 SUITABILITY (CONNECTORS).	HBL64CM56
Permits use of two 30A 125V cable sets, HBL61CM08, with one 50A 125V receptacle, HBL63CM70. IP55 SUITABILITY (CONNECTORS).	HBL64CM57**

Note: *UL Listed.

**Not CSA Certified.

^ The male plug end (50A 125/250V) has a blade removed and the blade slot filled with epoxy. Omitting the blade ensures achieving 125V safely.

Adapters do not provide overcurrent protection and do not provide GFCI protection except HBL105GF.



HBL64CM54



HBL64CM55



HBL64CM56



HBL64CM57

Marine Products

Features and Benefits

Hubbell Marine Isolation Transformers

Hubbell Isolation Transformers can protect your vessel's sensitive electronic equipment from damaging electrical spikes or surges. These transformers will also convert various dockside power systems to the 120/240 volt power required to operate all of the equipment on board.

And most importantly, Hubbell Isolation Transformers greatly reduce the possibility of stray current leaking from your boat's electrical system into the water, which could otherwise result in Electrical Shock Drowning (ESD) or electrocution.

Available Options:

- Available in White Powder Coated Steel or #316 Stainless Steel Housing
- 15 kVA and 25 kVA Models
- 60 Hz and 50/60 Hz Models
- 12.5% Taps

Constant Clean Safe Power



Standard White Powder Coated Steel Housing



Housing Design

- Available in #316 stainless steel or white powder coated steel finish
- Compact size and weight



Exterior Design

- 1 Easy access wiring chamber/drip lid
- 2 Auto boost connector
- 3 1" and 1½" knockouts
- 4 Weep holes



Neatly Routed Wiring Chamber (Top view with cover removed)

- Easy access wiring chamber
- Pre-wired for 120/240 volt applications



Safety/Installation

- Mounting brackets
- Vibration resistant



Interior Design

- Main module cleanly mounted in easy access wiring chamber
- High-quality terminal block for wire management
- Sand-filled and epoxy topped
- Auto-boost/remote cable receptacle



Auto-Boost Unit

- Factory programmed module automatically boosts voltage up to 12.5% if the reading at the dock falls between 195 – 220 Volts.

Constant Clean Safe Power

Hubbell Marine Isolation Transformers

15 kVA and 25 kVA Models

- Protects Sensitive Equipment on Board
- Virtually Eliminates Potential for In-Water Stray Current
- Can be wired per ABYC E-11 for either a Polarization or Isolation Transformer system



Isolation Transformers

Description	Weight (Lbs.)	Color	60 Hz	50/60 Hz
			Catalog Number	Catalog Number
15 kVA isolation transformer.	170	White powder coated steel	HBL50AITW	HBL32AITW
15 kVA isolation transformer.	170	#316 Stainless steel	HBL50AITSS	HBL32AITSS
15 kVA isolation transformer with auto-boost.	175	#316 Stainless steel	HBL50AITSSB	HBL32AITSSB
25 kVA isolation transformer.	250	White powder coated steel	HBL100AITW	HBL63AITW
25 kVA isolation transformer.	250	#316 Stainless steel	HBL100AITSS	HBL63AITSS
25 kVA isolation transformer with auto-boost.	255	#316 Stainless steel	HBL100AITSSB	HBL63AITSSB

Product Dimensions Inches (mm)

Description	Weight (Lbs.)	A - Height	B - Width	C - Depth
15 kVA Models	170	16.94" (43.0)	14.12" (35.9)	11.59" (29.4)
25 kVA Models	250	18.44" (46.8)	16.13" (41.0)	13.34" (33.9)



Recommended Seal-tite Cord Connectors

- For input and output cables
- Straight connectors for 1 and 1½ inch KOs

Cord Connectors

Description	NPT Hub Size	Cord Diameter Inches (mm)	Form Size	Cast Aluminum Catalog Number
Straight male connectors	1	1.13"-1.25" (28.6-31.7)	F5	SHC1048*
	1½	1.25"-1.38" (31.7-34.9)	F5	SHC1059
	1½	1.38"-1.50" (34.9-38.1)	F6	SHC1061



Note: *Cable jacket may have to be stripped to pass through connector body.

Dimensions in Inches (mm)

Marine Products

Telephone and Cable TV Devices



HBLPHTVNM



HBLPHTVSS



HBLTVSS



PH6625



PH6624



PH7440

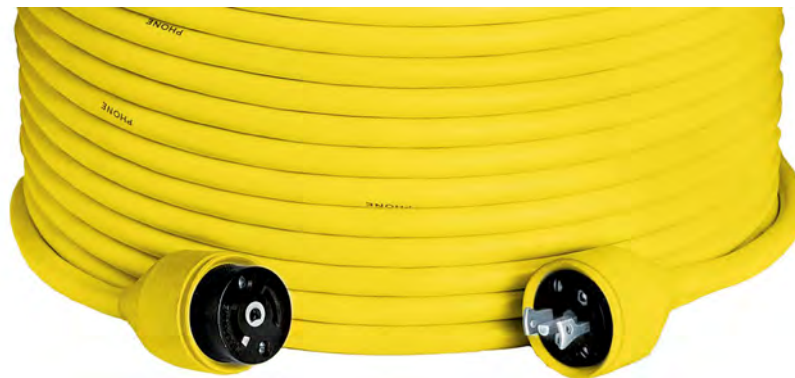

PH6599
PH6598

Telephone and Cable TV Ship-to-Shore Devices

Description	Catalog Number
Stylized non-metallic inlet provides telephone and cable TV connections in one unit. UV resistant white Centrex® cover makes unit weatherproof when completely closed. Mounting holes are 2.38 in. (60.3) on centers and match existing mounting patterns. Mounting screws and gasket provided. IP55 SUITABILITY.	HBLPHTVNM
Traditional stainless steel inlet provides connections for telephone and cable TV in one unit. Connections can be used individually or together. Gasketed cover is self-closing so interior is shielded from the elements when not in use. Watertight when cover is screwed in place. Mounting holes are 2.38 in. (60.3) on centers. Mounting screws and gasket included. IP56 SUITABILITY.	HBLPHTVSS
Same as HBLPHTVSS above except no phone.	HBLTVSS
Replacement int. for PH6594TV and HBLPHTVSS series inlets.	CR16914
Black locking type plug for telephone cable sets or adapters.	PH6625
Black locking type connector body used on telephone cable sets or adapters.	PH6624
Yellow Seal-Tite® cover for weatherproofing PH6624 connector body on cable sets when connecting to an inlet and for weather-proofing PH6625 plug. IP20 SUITABILITY.	PH7440
Yellow Seal-Tite cover for weatherproofing PH6624 connector body when used on extension cords or adapters. IP55 SUITABILITY.	PH7499
Factory pre-wired 50 ft. (15.2m) telephone cable set. Uses 3 conductor, #16 AWG type SJTO, yellow vinyl cord for marine and recreational vehicle applications. IP20 SUITABILITY.	PH6599
Same as PH6599 except white in color.	PH6599W*
Same as PH6599 except 25 ft. (7.6m) in length.	PH6598
Same as PH6598 except white in color.	PH6598W*

Note: *Discontinued.

Centrex® is a registered trademark of LANXESS Corporation.

Marine Products

Telephone and Cable TV Devices

Telephone and Cable TV Ship-to-Shore Devices

Description	Catalog Number
Black polycarbonate combination telephone/TV outlet with spring-loaded weatherproof lift cover. Can be wired for telephone service only or for telephone and MATV/CATV services in one FS/FD box in both marinas and RV parks. Can be padlocked to prevent unauthorized use. IP44 SUITABILITY.	PH6597TV
Black polycarbonate cable TV outlet has coax connector and gasketed, spring-loaded lift cover for weatherproofing. Designed for mounting to FS/FD type weatherproof boxes in both marinas and RV parks. IP20 SUITABILITY.	TV97
Black polycarbonate telephone outlet has gasketed, spring-loaded lift cover for weatherproofing. Designed for mounting to FS/FD type weatherproof boxes in both marinas and RV parks. IP20 SUITABILITY.	PH6597
Black polycarbonate telephone outlet has gasketed, spring-loaded lift cover for weatherproofing. Can be used to retrofit old style telephone outlets of Pauluhn Manufacturing Company (2833 and 2843) in both marinas and RV parks. IP20 SUITABILITY.	PH6596
Black polycarbonate RV inlet for telephone connection only. Has spring-loaded, gasketed weatherproof lift cover designed for mounting to FS/FD type weatherproof boxes. IP20 SUITABILITY.	PH6595
50 ft. (15.2m) yellow jacketed ship-to-shore TV cable set is the industry standard 75 Ohm, RG59-U with male plugs on both ends. Adapter included for a quick, slip-on connection to inlet on boat.	TV99
Same as TV99 except white in color.	TV99W
Same as TV99 except 25 ft. (7.6m) in length.	TV98
Same as TV98 except white in color.	TV98W



PH6597TV



TV97



PH6597



PH6596



PH6595



TV99
TV99W
TV98
TV98W

30 Amp 28 Volt DC Rated

Electric Fishing Reel Devices

Hubbell has a DC rated electrical system designed specifically for larger electric fishing reel systems. Up until now, larger electric fishing reel systems typically utilized conventional 30 Amp AC rated devices since an appropriately rated DC system was not available.

The system features a corrosion-resistant plug, connector body and receptacle and can be used along with a Hubbell outlet box and weatherproof cover plate to complete the installation. These devices are all rated at 28 Volt DC and applicable for all 12, 24 and 32 Volt DC fishing reel systems. The devices are UL listed and CSA certified. All devices are made of high-visibility yellow nylon that is impact resistant and UV stabilized for longer life. Also, the contacts are nickel plated for corrosion resistance.



HBL328DCR



HBL328DCP



HBL328DCC



HBL60CM83A



HBL74CM25WOA

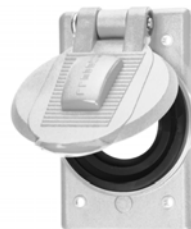

HBL74CM25WOAW

30A 28V DC Rated Devices

Description	Catalog Number
Yellow locking single receptacle with abuse-resistant face. Can be mounted in Hubbell box HBL6083 and used with HBL74CM25WOA weatherproof plate.	HBL328DCR
Same as HBL328DCR except white in color.	HBL328DCRW
Yellow locking plug has rugged nylon housing and rear dust seal to keep dust and foreign matter out.	HBL328DCP
Same as HBL328DCP except white in color.	HBL328DCPW
Yellow locking connector body has rugged, nylon housing and rear dust seal to keep dust and foreign matter out.	HBL328DCC

Accessories

Description	Catalog Number
Gray, high-impact thermoplastic FD (deep) weatherproof box with ¼ in. (19.1) NPT threaded hub, with 30 cubic inch capacity.	HBL6083
Same as HBL6083 except yellow in color.	HBL60CM83A
Same as HBL6083 except white in color.	HBL60CM83WA
Spring-loaded lift cover, for weatherproofing HBL328DCR outlet. Yellow in color.	HBL74CM25WOA
Same as HBL74CM25WOAW except white in color.	HBL74CM25WOAW
Same as HBL74CM25WOAW except gray in color.	HBL7425WOA

Note: See page AA-50 for 55° angle adapters and additional accessories.

Marine Products

12 Volt DC Rated Switches

KEY CHART



M11SP

1. Toggle switch

Fits panels up to ¼ in. thick when not using the back-up nut provided; fits panels up to ⅜ in. thick when using the back-up nut. Requires a ½ in. mounting hole.



M11LRGSP

2. Lighted toggle switch

Built-in pilot light (R=red, G=green) for night vision. Same panel specs as 1.



M11LTR

3. Lighted-tip toggle switch

Red pilot light visible in tip of toggle only. Same panel specs as 1.



MR11SP

4. Rocker switch

Requires a 1½ in. high x ⅞ in. wide rectangular opening.



MR123LRSP

5. Lighted rocker switch

Built-in pilot light for night vision. Same panel specs as 4.

Panel Mount Toggle and Rocker Switches

Description	Typical Applications	Key	Catalog Number
Single pole, single throw, ON/OFF.	Lights, bilge blower, bilge pump(s), accessories	1	M11SP
		2	M11LRSP
		2	M11LRGSP
		3	M11LTR
		4	MR11SP
Single pole, single throw, ON/OFF/ON.	Horn, starter, winches, gauges		M11MSP
			MR11MSP
Single pole, double throw, ON/OFF/ON.	Bilge pumps, speed selector, lights, navigation lights		M123SP
			M123LTR
			MR123SP
			MR123LRSP
Single pole, double throw, Momentary ON/OFF/ON.	Bilge pumps	1	M123MSP
		4	MR123MSP
Single pole, double throw, Momentary ON/OFF/Momentary ON.	Trim Tabs	1	M123MMSP
		4	MR123MMSP
Double pole, single throw, ON/OFF.	Lights, accessories	1	M21SP
		4	MR21SP
Double pole, double throw, ON/OFF/ON.	Navigation lights, wipers, dual fuel tanks	1	M223SP
		4	MR223SP
Double pole, double throw, ON/OFF/ON (with jumper).	Navigation lights, windlass	1	M223JSP
Double pole, double throw, Momentary ON/OFF/Momentary ON.	Winches, trim tabs, dual fuel tanks	1	M223MMSP
		4	MR223MMSP
Black silicone rubber boot bonded to brass nut.	Provides positive seal against moisture, oil, etc. Fits any non-lighted toggle switch.		MSB1
Push-button horn switch with 1½/32 in. long nickel plated brass mounting stem. Terminals are .25 in. spade.	For remote operation of horn.		MH11
Black push-button (horn) boot.	Fits MH11 horn switch.		MHB11



M11SP



MR11SP



M21SP



M223SP



MSB1



MH11



MHB11

15 Amp Twist-Lock® Devices and Accessories



HBL47CM00

15A 125V AC Twist-Lock® Devices

Description	Catalog Number
Yellow duplex receptacle has heat resistant body. IP20 SUITABILITY.	HBL47CM00
Yellow Insulgrip® plug has rugged nylon housing and detachable cord grip with range of .30-.69 in. (7.5-17.4) that utilizes a unique offset jaws arrangement to provide secure strain relief. IP20 SUITABILITY.	HBL47CM20C
Yellow Insulgrip connector body has rugged nylon housing and detachable cord grip with range of .30-.69 in. (7.5-17.4) that utilizes a unique offset jaws arrangement to provide secure strain relief. IP20 SUITABILITY.	HBL47CM29C
Panel mount flanged outlet has heat resistant melamine interior and stainless steel casing. IP20 SUITABILITY.	HBL47CM15
Panel mount flanged inlet has heat resistant melamine interior and stainless steel casing. IP20 SUITABILITY.	HBL47CM16



HBL47CM20C



HBL47CM29C

Accessories

Description	Catalog Number
Yellow Valox® spring-loaded lift cover for weatherproofing duplex receptacles. Stainless steel screws and neoprene gasket included for mounting to FS/FD type weatherproof boxes. IP20 SUITABILITY.	HBL52CM21
Same as HBL52CM21 except white in color	HBL52CM21W
Same as HBL52CM21 except gray in color.	HBL5221
Same as HBL52CM21 except for mounting to standard boxes.	HBL52CM22
Same as HBL52CM22 except gray in color.	HBL5222
Short yellow Seal-Tite® cover for weatherproofing HBL47CM20C Insulgrip plug when used with receptacles or connector bodies. Also can be used to weatherproof HBL47CM29C Insulgrip connector body when used with HBL47CM16 flanged inlet. IP44 SUITABILITY.	HBL60CM23**
Yellow Seal-Tite cover for weatherproofing HBL47CM29C Insulgrip connector body when used on extension cords and adapters. IP20 SUITABILITY.	HBL60CM24**

Note: **Not UL Listed or CSA Certified.



HBL47CM15



HBL47CM16



HBL60CM23



HBL60CM24



HBL52CM21W

Valox® is a trademark of SABIC Innovative Plastics, acquired from General Electric Company.

15 Amp Straight Blade Devices and Accessories



15A 125V
NEMA 5-15R
UL/CSA

15A 125V AC Straight Blade Devices

Description	Catalog Number
Yellow corrosion-resistant/weather resistant duplex receptacle. Use outdoors or where salt and other corrosive materials are a problem. Accepts 15A 125V, 2 pole 3 wire straight blade plugs. IP20 SUITABILITY.	HBL52CM62
Same as HBL52CM62 except ivory in color.	HBL52CM62I
Single version of HBL52CM62 duplex yellow receptacle. IP20 SUITABILITY.	HBL52CM61
Yellow Insulgrip® plug has rugged nylon housing and detachable cord grip with range of .23-.72 in. (5.8-18.3) that utilizes a unique offset jaws arrangement for secure strain relief. IP20 SUITABILITY.	HBL52CM66C
Yellow Insulgrip connector body has rugged nylon housing and detachable cord grip with range of .23-.72 in. (5.8-18.3) that utilizes a unique offset jaws arrangement for secure strain relief. IP20 SUITABILITY.	HBL52CM69C
Yellow Valise® plug has one-piece nylon housing that assembles easily with two screws. Built-in cord grip has range of .22-.66 in. (5.6-16.8). IP20 SUITABILITY.	HBL52CM66V
Yellow Valise connector body has one-piece nylon housing that assembles easily with two screws. Built-in cord grip has range of .22-.66 in. (5.6-16.8). IP20 SUITABILITY.	HBL52CM69V
Yellow Insulgrip plug with anchor locking screw to prevent accidental pull-out. The plug is "locked" into the receptacle when the screw is turned down so the head is flush with the plug surface. The cord grip range is .30-.69 in. (7.5-17.4). UL Recognized Component. IP20 SUITABILITY.	HBL52CM80C
Compact gray nylon panel mount inlet ideal for bass boat battery charging connection. Has gasketed spring-loaded lift cover for weatherproofing front and neoprene boot for weatherproofing rear. Will accept both 15A 125V and 20A 125V, 2 pole 3 wire straight blade connector bodies. IP44 SUITABILITY.	HBL61CM64
Same as HBL61CM64 except black in color.	HBL61CM64BK

Note: See page Tech-10 for Weather Resistant description.

Accessories

Description	Catalog Number
Yellow Seal-Tite® cover for weatherproofing straight blade Insulgrip plugs, HBL52CM66C and HBL53CM66C, when used with receptacles and connector bodies. Can also be used to weatherproof Insulgrip connector bodies when mating with flanged inlets. IP44 SUITABILITY. Note: For Insulgrip devices only.	HBL60CM17**
Yellow Seal-Tite cover for weatherproofing straight blade Insulgrip connector bodies, HBL52CM69C and HBL53CM69C, on extension cords and adapters. IP55 SUITABILITY. Note: For Insulgrip devices only.	HBL60CM18**
Yellow Valox® spring-loaded lift cover for weatherproofing duplex receptacles. Stainless steel screws and neoprene gasket included for mounting to FS/FD type weatherproof boxes. IP20 SUITABILITY.	HBL52CM21
Same as HBL52CM21 except gray in color.	HBL5221
Same as HBL52CM21 except for mounting to standard boxes.	HBL52CM22
Same as HBL52CM22 except gray in color.	HBL5222
Yellow Valox spring-loaded lift cover for weatherproofing single straight blade receptacles. Stainless steel screws and neoprene gasket included. For mounting to FS/FD type weatherproof boxes. IP44 SUITABILITY.	HBL74CM23WO
Same as HBL74CM23WO except gray in color.	HBL7423WO

Note: **Not UL Listed or CSA Certified.

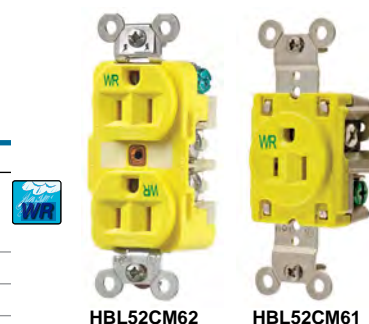

HBL52CM62

HBL52CM61



HBL52CM66C



HBL52CM69C



HBL52CM80C



HBL52CM66V



HBL52CM69V



HBL61CM64



HBL60CM17

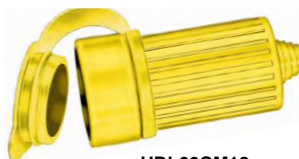

HBL60CM18
HBL60CM19



HBL52CM21



HBL74CM23WO

Rynite® is a registered trademark of E. I. DuPont.

Valox® is a trademark of SABIC Innovative Plastics, acquired from General Electric Company.

20 Amp Twist-Lock® Devices and Accessories

Plugs, receptacles and connectors only.



HBL23CM10

20A 125V Twist-Lock® Devices

Description	Catalog Number
Yellow single receptacle has Rynite® body and abuse resistant nylon face. IP20 SUITABILITY.	HBL23CM10
Yellow Insulgrip® plug has rugged nylon housing and cord grip with range of .36-.93 in. (9-24) that utilizes a unique offset jaws arrangement to provide secure strain relief. IP20 SUITABILITY.	HBL23CM11
Yellow Insulgrip connector body has rugged nylon housing and cord with range of .36-.93 in. (9-24) that utilizes a unique offset jaws arrangement to provide secure strain relief. IP20 SUITABILITY.	HBL23CM13
Yellow Valise plug has one-piece nylon housing, assembles easily with two screws. Built-in cord grip has range of .33-.72 in. (8.3-18.2). IP20 SUITABILITY.	HBL23CM11V



HBL23CM11



HBL23CM13

Accessories

Description	Catalog Number
Yellow polycarbonate spring-loaded lift cover for weather-proofing HBL23CM10 receptacle. Meets the most stringent requirements of UL's three listing categories for weatherproof plates. Stainless steel screws and neoprene gasket included for mounting to FS/FD type weatherproof boxes. IP44 SUITABILITY.	HBL74CM25WOA
Same as HBL74CM25WOA except gray in color.	HBL7425WOA
Same as HBL74CM25WOA except white in color.	HBL74CM25WOAW
Yellow Seal-Tite® cover for weatherproofing HBL26CM11 or HBL23CM11 plugs. IP44 SUITABILITY. Note: Fits Insulgrip devices only.	HBL60CM31**
Same as HBL60CM31 except white in color.	HBL60CM31W**
Yellow Seal-Tite cover for weatherproofing HBL26CM13 or HBL23CM13 connector bodies when used on extension cords or adapters. IP44 SUITABILITY. Note: Fits Insulgrip devices only.	HBL60CM32**
Yellow vinyl Seal-Tite cover for weatherproofing HBL23CM13V or HBL26CM13V connector bodies. IP44 SUITABILITY. Note: Fits Valise® devices only.	HBL60CM32V**
Yellow Seal-Tite cover for weatherproofing HBL23CM11V or HBL26CM11V plugs. IP44 SUITABILITY. Note: Fits Valise devices only.	HBL60CM31V**

Note: **Not UL Listed or CSA Certified.



HBL23CM11V



HBL60CM31



HBL60CM31V



HBL60CM32



HBL60CM32V



HBL74CM25WOA

Rynite® is a registered trademark of E. I. DuPont.

20 Amp Straight Blade Devices and Accessories



20A 125V AC Straight Blade Devices

Description	Catalog Number
Yellow corrosion-resistant/weather resistant duplex receptacle. Use outdoors or where salt and other corrosive materials are a problem. Accepts both 20A 125V and 15A 125V, 2 pole 3 wire straight blade plugs. IP20 SUITABILITY.	HBL53CM62
Single version of HBL53CM62 duplex yellow receptacle. IP20 SUITABILITY.	HBL53CM61
Yellow Insulgrip® plug has rugged nylon housing and detachable cord grip with range of .23-.72 in. (5.8-18.3) that utilizes unique offset jaws arrangement to provide secure strain relief. IP20 SUITABILITY.	HBL53CM66C
Yellow Insulgrip connector body has rugged nylon housing and cord grip with range of .23-.72 in. (5.8-18.3) that utilizes unique offset jaws arrangement for secure strain relief. IP20 SUITABILITY.	HBL53CM69C
Compact gray nylon panel mount outlet ideal for electric trolling motors and reel applications. Features gasketed spring-loaded lift cover for weatherproofing front and neoprene boot for weatherproofing rear. Accepts both 20A 125V and 15A 125V, 2 pole 3 wire straight blade plugs. IP44 SUITABILITY.	HBL61CM65

Note: See page Tech-10 for Weather Resistant description.



HBL53CM62 HBL53CM61



HBL53CM66C

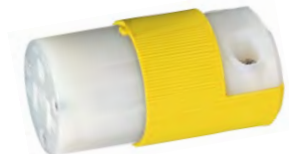

HBL53CM69C



HBL52CM66V



HBL52CM69V



HBL61CM65

Accessories

Description	Catalog Number
Yellow Seal-Tite® cover for weatherproofing straight blade Insulgrip plugs, HBL52CM66C and HBL53CM66C, when used to mate receptacles and connector bodies. Can also be used with Insulgrip connector bodies when mating with flanged inlets. IP44 SUITABILITY. Note: For Insulgrip devices only.	HBL60CM17**
Yellow Seal-Tite cover for weatherproofing straight blade Insulgrip connector bodies, HBL52CM69C and HBL53CM69C, on extension cords and adapters. IP55 SUITABILITY. Note: For Insulgrip devices only.	HBL60CM18**
Yellow closure plug used with HBL60CM18 long Seal-Tite cover to prevent water from entering front of device when not in use. IP55 SUITABILITY.	HBL60CM19**
Yellow polycarbonate spring-loaded lift cover for weatherproofing duplex receptacles. Stainless steel screws and neoprene gasket included for mounting to FS/FD type weatherproof boxes. IP20 SUITABILITY. Not CSA certified.	HBL52CM21
Same as HBL52CM21 except white in color.	HBL52CM21W
Same as HBL52CM21 except gray in color.	HBL5221
Same as HBL52CM21 except for mounting to standard boxes.	HBL52CM22
Same as HBL52CM22 except gray in color.	HBL5222
Yellow polycarbonate spring-loaded lift cover for weatherproofing single straight blade receptacles. Stainless steel screws and neoprene gasket included. For mounting to FS/FD type weatherproof boxes. IP44 SUITABILITY. Not CSA certified.	HBL74CM23WO
Same as HBL74CM23WO except gray in color.	HBL7423WO

Note: **Not UL Listed or CSA Certified.



HBL60CM17



HBL52CM21



HBL52CM21W



HBL74CM23WO



HBL7423WO

Rynite® is a registered trademark of E. I. DuPont.

Circuit Testers

Hubbell Twist-Lock® Circuit Tester

The Hubbell Twist-Lock® Tester is an exclusive patented design that easily tests the circuit condition without the need for traditional measurement techniques. Whether it is a boater, marina operator or electrician, knowing that power is present at any receptacle or connector is critical. By plugging the tester into an outlet, an LED output will immediately provide the state of the circuit.

An easy to read card is provided with the tester, to help determine if the connections are made properly and in the correct position. This unique NEMA configuration ensures that the proper connection was made through an easy to read output display. It also easily attaches to a tool belt so it is available when needed.



For Testing the Wiring Condition of Receptacles and Connectors

- Quickly diagnose mis-wiring situation or application
- Great for dark, difficult to reach spaces
- No measurement readings to interpret
- Easy to read LED output and condition tables
- Insulgrip® nylon housing for secure gripping
- Carabiner style clip to secure to work belt
- UL 1436 listed



HBLT26CM11

Hubbell Twist-Lock® Circuit Tester

Description

Styled and sized like a standard Hubbell Twist-Lock® Plug. Simply plug it in and the LED back panel immediately identifies if the connections are made correctly and are in the correct position, ensuring the device is wired properly. An easy to read card is provided with the tester, to help determine if the connections are correct. This tester is compact and can easily clip onto your tool belt. The Hubbell Circuit Tester is UL and C-UL Listed.

Catalog Number

HBLT26CM11

Additional Testers

Description

This unit is designed to measure the trip level of GFCI portables, receptacles, or breakers within any range from 2 to 7 milliamperes, or the leakage in portable tools or appliances within a leakage range of 1 to 7 milliamperes. It can be used on any AC circuit of 110 to 130V.

This outlet circuit tester has a simple arrangement of neon lights which visually indicate correct wiring, reversed polarity, open ground wire, open neutral wire, open hot wire, hot and ground reversed and hot wire on neutral terminal and hot terminal unwired. Simply plug the HBL5200 into a single phase 125V 2 pole 3 wire outlet and the combination of lighted and/or unlighted lamps will immediately indicate the condition of the circuit. The instructions and symbol identification are printed on durable polyester labels permanently attached to the tester. To test other 2 pole 3 wire single phase 125V outlets, use one of the proper adapters shown on page AA-29.

Note: *Not UL Listed or CSA Certified.

**Not CSA Certified.

Catalog Number

GFT2G*

HBL5200**



GFT2G



HBL5200

Features and Benefits

USB Charger Receptacles

Hubbell's new fast charging USB-C Power Delivery receptacles provide more power. Users can quickly charge laptops and other large devices. The USB-C port marked PD (Power Delivery) provides up to 55 Watt of output. The additional Type C or Type A port delivers up to 1.5 Amp, 5 Volt, (7.5 Watt) of power.

More Ways to Charge Faster with Hubbell's line of USB Chargers, available in Type-C, Combination Type A&C or the legacy Type A, all with a USB high power output of 5 Amp 5 Volt DC. Hubbell's USB Charger Duplex Receptacle provides both USB and electrical power in a standard single gang opening. Designed to provide maximum charging for portable electronics, the USB ports are capable of charging two tablets simultaneously.

Hubbell's weather resistant USB charger receptacle offers a safe and reliable solution, conveniently expanding way to charge portable electronics. Now, being outdoors no longer means worrying about finding a charging source. Weather resistant receptacles comply with Section 406.9 of the National Electrical Code when used with covers.

Common Features

- LED ON to indicate USB and line voltage power available
- USB stainless steel ports rated for minimum 10,000 insertions and removals
- Complies with battery charging specification BC1.2
- Designed for commercial, industrial and home use
- Compatible with USB 1.1/2.0/3.0 devices, including Apple® products



USB-C Power Delivery Charger Receptacles

- Two Type C or One Type A and One Type-C port configurations
- USB-C PD port (up to 20 Volt, 55 Watt output)
- 2nd USB-A or USB-C convenience port (up to 1.5 Amp, 5 Volt, 7.5 Watt output)
- Heavy duty spec grade
- Tamper resistant commercial grade duplex receptacle



Weather Resistant Type A&C USB Charger

- One Type A and one Type-C port configurations
- Meets Section 406.9 of NEC® with cover
- 5 Amp, 5 Volt USB output
- Power indicating green LED light

Weather Resistant USB Charger Duplex Receptacles



Description	Color	15A 125V AC	20A 125V
Type A&C USB Charger receptacle, one Type A and one Type-C port configurations, high power 5 Amp, 5 Volt USB output, Tamper-Resistant USB ports rated 10,000 cycles; Commercial Grade.	Ivory	USB15AC5IWR	USB20AC5IWR
	Light Almond	USB15AC5LAWR	USB20AC5LAWR
	White	USB15AC5WWR	USB20AC5WWR

Note: Outdoor circuits should be GFCI protected per national and local electric codes. Also available in black, brown and gray. See page Tech-10 for Weather and Tamper-Resistant descriptions.



USB15AC5WWR

USB-C Power Delivery Charger Tamper Resistant Duplex Receptacles



Description	Color	15A 125V AC
Type-C USB Power Delivery Receptacle, two Type-C port configurations, one USB-C Power Delivery port with up to 55 Watt output and one USB Type-C convenience port with up to 1.5 Amp, 5 Volt output.	Ivory	USB15CPDI
	Light Almond	USB15CPDLA
	White	USBCPDW
Type A/C USB Power Delivery Receptacle, one USB-C Power Delivery port with up to 55 Watt output and one USB Type-A convenience port with up to 1.5 Amp, 5 Volt output.	Ivory	USB15ACPDI
	Light Almond	USB15ACPDLA
	White	USB15ACPDW

Note: Also available in black, brown and gray.



USB15ACPDW

Apple® is a registered trademark of Apple Inc.
NEC® is a registered trademark of the The National Electrical Code.

GFCI and Portable Ground Fault Circuit Interrupters

The American Boat and Yacht Council recommends the use of ground fault protected receptacles in a head, galley, machinery space or on a weather deck. Refer to ABYC "Ground Fault Protection" on page AA-52.

New Hubbell Weather Resistant and Extra Heavy Duty Corrosion Resistant Weather and Tamper-Resistant Ground Fault Receptacles

Hubbell now offers a Ground Fault Receptacle for every application.

Hubbell's GFCI offering, with patented self-test technology, continually tests and monitors itself to insure proper functioning.

Hubbell's GFCI Receptacle line-up now includes:

- Standard Commercial Series; for typical standard use
- Weather Resistant Series; meets NEC® requirements for weather resistance, UV and corrosion resistance for harsh and damp applications.
- Extra Heavy Duty Corrosion Resistant Series; has high-impact and UV stabilized housing, nickel-plated face contacts, mounting strap and terminals to withstand the most demanding environments and applications.



Ground Fault Receptacles



Description	Color	OEM Version	Marine Packaging	
		Standard Series	Weather Resistant Series	Extra Heavy Duty Series
15A 125V GFCI receptacle.	Ivory	GFRST15I	GFRST52MI	GFSG5262I
	Light Almond	GFRST15LA	GFRST52MLA	-
	White	GFRST15W	GFRST52MW	GFSG5262W

Note: Also available in black, brown and gray. See page Tech-10 for Tamper and Weather Resistant descriptions.



GFSG5262I



CWP26CRW



GFP15M



GFP315A



GFP6C15M
GFP25C15M

Hubbell's GFCI receptacles can be mounted on any standard 2.50 inch (63.5) deep box. A feed-through feature provides protection not only at that receptacle but also at any other receptacle located downstream from it on the same circuit. These devices meet the requirements of The National Electric Code (NEC®) and American Boat and Yacht Council Standard and will accept locking fork terminals.

Caution: Ground Fault Receptacles should not be mounted in locations exposed to salt spray nor in the engine room. For GFCI protection of such locations, downstream feeding from an internally located Ground Fault Receptacle is recommended.

Description	Color	Catalog Number
PVC weatherproof lift cover for ground fault receptacles (such as GFRST52M series) and Style Line® receptacles. For vertical mounting in standard or FS/FD type boxes.	Gray White	CWP26CR CWP26CRW

Portable Ground Fault Circuit Interrupters (GFCI)

Ideal for providing safety in applications requiring multiple outlets, features gasketed cover to protect outlets not in use. Ensures safety by interrupting power when leakage to ground is 4 to 6 milliamperes. A test button allows the user to test that the GFCI is in working order. This portable solution provides open neutral protection.

Description	Catalog Number
The housing is high-impact yellow polycarbonate as are the liftcovers which protect the receptacles from dirt and damage. Incorporates a 20 Amp GFCI module that can be replaced in the field. The module provides not only ground fault protection, but also contains the no voltage release feature.	GFP15M

3-outlet plug-in unit. Plugs into boat convenience receptacles to provide ground fault protection. **GFP315A**

Note: GFCI devices will not protect against overloads or short circuits.

15A 125V GFCI Line Cord Devices

Description	Line Cord Length	Catalog Number
Ideal for personal plug-in protection at marinas and onboard boats when used with pumps, drills, sanders and all portable electrical equipment. GFCI mechanism is watertight and approved for outdoor use. High visibility yellow SJTW-A power cord resists moisture, chemicals and sunlight.	6 ft. (1.8m)	GFP6C15M
	25 ft. (7.6m)	GFP25C15M

NEC® is a registered trademark of the The National Electrical Code.

15 and 20 Amp Receptacles

Style Line® Decorator Receptacles

- High-impact nylon face resists breaking, chipping and cracking.
- Will accept locking fork terminal to comply with ABYC standards.
- Available in 4 colors for any decor with matching wall plates.
- Smooth, high-gloss finish for rich appearance.

Commercial Style Line® Decorator Series



Description	Color	Standard Duplex	Duplex, Tamper-Resistant	Duplex, Weather and Tamper-Resistant
15A 125V duplex receptacle.	Black	DR15BLK	DR15BLKTR	DR15BLKWTRTR
	Brown	DR15	DR15TR	DR15WRTR
	Gray	DR15GRY	DR15GRYTR	DR15GRYWTRTR
	Ivory	DR15I	DR15ITR	DR15IWRTR
	Light Almond	DR15LA	DR15LATR	DR15LAWTRTR
	White	DR15WHI	DR15WHITR	DR15WHIWRTR



DR15ITR



DR15GRYWTRTR

Commercial Series



Description	Color	Standard Duplex, Spec. Grade, Side Wired	Duplex, Tamper-Resistant	Duplex, Weather and Tamper-Resistant, Back and Side Wired
15A 125V duplex receptacle.	Black	CR15BLK	CR15BLKTR	BR15BLKWTRTR
	Brown	CR15	CR15TR	BR15WRTR
	Gray	CR15GRY	CR15GRYTR	BR15GRYWTRTR
	Ivory	CR15I	CR15ITR	BR15IWRTR
	Light Almond	CR15LA	CR15LATR	BR15LAWTRTR
	White	CR15WHI	CR15WHITR	BR15WHIWRTR



CR15TR



BR15IWRTR

Note: All devices above will accept locking fork terminal to comply with ABYC standards. See page Tech-10 for Tamper and Weather Resistant descriptions.

Extra Heavy Duty Single Receptacles

Description	Color	Catalog Number
15A 125V single receptacle.	Brown	HBL5251
	Ivory	HBL5251I
20A 125V single receptacle.	Brown	HBL5361
	Ivory	HBL5361I



HBL5251



HBL5361I

Corrosion-Resistant Receptacles



Description	Color	Catalog Number
15A 125V yellow corrosion-resistant duplex receptacle. Use where salt or other corrosive elements are a problem.	Yellow	HBL52CM62
Same as HBL52CM62 except ivory in color.	Ivory	HBL52CM62I



HBL52CM62I



HBL8200II

Special Application Illuminated Receptacle

Description	Color	Catalog Number
Illuminated receptacle 15A 125V grounding. A high quality receptacle with an illuminated face. Ideal for use in halls or as a gentle night light.	Ivory	HBL8200II

Note: See page Tech-10 for Weather Resistant description.

Switches and Accessories



CS115I

Commercial Series

Description	Toggle Color	Catalog Number
15A single-pole toggle switch for controlling AC load from one point.	Black	CS115BK
	Brown	CS115
	Gray	CS115GY
	Ivory	CS115I
	Light Almond	CS115LA
15A three-way toggle switch for controlling AC load from two points.	Black	CS315BK
	Brown	CS315
	Gray	CS315GY
	Ivory	CS315I
	Light Almond	CS315LA
White	CS315W	

Note: All devices above will accept locking fork terminal to comply with ABYC standards.



HBL1221IL



HBL1221PL

Special Application Series

Description	Catalog Number
20A 120V toggle switch with LED lamp set in ivory handle. Handle illuminates when switch is in "OFF" position.	HBL1221IL
20A 120V three-way toggle switch with LED illuminated ivory handle for controlling AC load from two points. Handle illuminates when "OFF".	HBL1223IL
20A 120V single-pole toggle switch with LED lamp set in clear red handle. Handle illuminates when switch is "ON". Serves as instant reminder that current is flowing to an appliance.	HBL1221PL
20A 120V three-way toggle switch with LED for controlling AC load from two points. Red handle illuminates when "ON".	HBL1223PL
Single-pole PresSwitch® for controlling AC load from one point. Switch activated brown button.	HBL1281
Same as HBL1281 except ivory button.	HBL1281I
Three-way PresSwitch for controlling AC load from two points. Switch activated brown button.	HBL1283*
Same as HBL1283 except ivory button.	HBL1283I*



HBL1281



HBL1283



HBL17CM50



HBL1795

Accessories

Description	Catalog Number
Yellow neoprene weatherproof plate for use only with PresSwitches. PresSwitch button is activated when bubble is pressed. Not CSA certified.	HBL17CM50*
Clear silicone rubber weatherproof bubble plate for use with all AC toggle switches and PresSwitches. Also ideal for use with lighted handle toggle switches. Not CSA certified.	HBL1795
Plastic switch/receptacle box. Measures 3.281" x 2.188" x 2.50" (83.3 x 55.6 x 63.5) deep. For mounting in walls without studs. A support strap is provided which pulls box tightly against back side of wall.	HBL6079**

Note: *Not UL Listed.
**Not CSA Certified.



HBL6079











Wallplates

Non-metallic Plates

- High-impact polycarbonate thermoplastic is virtually unbreakable
- Smooth satin finish, blends into the wall
- Screws are factory-inserted for fumble-free installation

Stainless Steel Plates

- Type 302/304
- Non-magnetic
- Ideal for highly corrosive environments

Description	Color	Thermoplastic		Material	Metal Catalog Number
		Standard	Mid-Size		
 1-Gang, 1-Toggle	Black Brown Gray Ivory White	P1BK P1 P1GY P1I P1W	PJ1BK PJ1 PJ1GY PJ1I PJ1W	Brass Stainless Steel	SB1 SS1
 1-Gang, 1-Duplex	Black Brown Gray Ivory White	P8BK P8 P8GY P8I P8W	PJ8BK PJ8 PJ8GY PJ8I PJ8W	Brass Stainless Steel	SB8 SS8
 1-Gang, 1-Decorator	Black Brown Gray Ivory White	P26BK P26 P26GY P26I P26W	PJ26BK PJ26 PJ26GY PJ26I PJ26W	Brass Stainless Steel	SB26 SS26
 2-Gang, 2-Toggle	Black Brown Gray Ivory White	P2BK P2 P2GY P2I P2W	PJ2BK PJ2 PJ2GY PJ2I PJ2W	Brass Stainless Steel	SB2 SS2
 2-Gang, 2-Duplex	Black Brown Gray Ivory White	P82BK P82 P82GY P82I P82W	PJ82BK PJ82 PJ82GY PJ82I PJ82W	Brass Stainless Steel	SB82 SS82
 2-Gang, 2-Decorator	Black Brown Gray Ivory White	P262BK P262 P262GY P262I P262W	PJ262BK PJ262 PJ262GY PJ262I PJ262W	Brass Stainless Steel	SB262 SS262
 2-Gang, 1-Toggle, 1-Duplex	Black Brown Gray Ivory White	– P18 P18GY P18I P18W	PJ18BK PJ18 PJ18GY PJ18I PJ18W	Brass Stainless Steel	SB18 SS18
 2-Gang, 1-Toggle, 1-Decorator	Black Brown Gray Ivory White	P126BK P126 P126GY P126I P126W	PJ126BK PJ126 PJ126GY PJ126I PJ126W	Brass Stainless Steel	SB126 SS126
 1-Gang, 1-Single 1.40" Dia. Hole	Black Brown Gray Ivory White	P7BK P7 P7GY P7I P7W	PJ7BK PJ7 PJ7GY PJ7I PJ7W	Brass Stainless Steel	SB7 SS7
 1-Gang, 1-Blank, Box Mount	Black Brown Gray Ivory White	P13BK P13 P13GY P13I P13W	PJ13BK PJ13 PJ13GY PJ13I PJ13W	Brass Stainless Steel	SB13 SS13

Communication Frames and Connectors

Hubbell Now Offers The Ability To Put 2 or 3 Communication Devices In a Single, Style Line® Plate

Any combination of phone (6-position jack), cable TV (F-type connector) and Category 5e modular data jacks can be assembled onto a 2-port or 3-port frame—each sold individually so you can customize them as needed. Or the highly popular phone and cable TV combination is available with the frame and matching wallplate under a single catalog number, in all the popular colors.

Finally—a single communications plate that can take the place of 2 or 3 plates—available from a company you can trust for superior quality.

Hubbell's Marine communication frames and connectors deliver high quality data and multimedia transmission to the point of connection. Hubbell's 2 and 3 port Style Line® frames and leading edge connections allow for customized configurations. Install Hubbell's Marine communication offering and be assured a reliable connection.



NS783W

2 Port Communication Frame, Fully Loaded (6-Position Phone Jack, F-Type Cable TV Jack and Style Line® Plate Included)

Color	No. of Ports	Connection Type	Catalog Number
White	2	USOC, F-Type	NS783W

Style Line® Frames, 2 Port and 3 Port Unloaded

Color	No. of Ports	Connection Type	Catalog Number
Black	2	—	NS612BK
Gray	2	—	NS612GY
Ivory	2	—	NS612I
White	2	—	NS612W
Black	3	—	NS613BK
Gray	3	—	NS613GY
Ivory	3	—	NS613I
White	3	—	NS613W

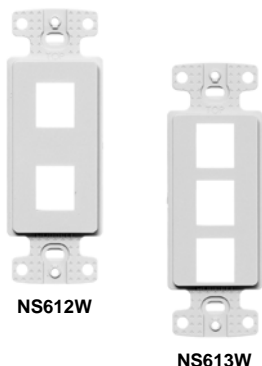

NS612W

NS613W

Category 6 Modular Keystone Jacks

Color	Wiring	No. Positions	Catalog Number
Black	T568A/T568B	8-Positions	NSJ6BK
Gray	T568A/T568B	8-Positions	NSJ6GY
Ivory	T568A/T568B	8-Positions	NSJ6I
White	T568A/T568B	8-Positions	NSJ6W

Category 5e Modular Keystone Jacks

Color	Wiring	No. Positions	Catalog Number
Black	T568A/T568B	8-Positions	NSJ5EBK
Gray	T568A/T568B	8-Positions	NSJ5EGY
Ivory	T568A/T568B	8-Positions	NSJ5EI
White	T568A/T568B	8-Positions	NSJ5EW

USOC Modular Keystone Jacks

Color	Wiring	No. Positions	Catalog Number
Black	USOC	6-Positions	NSJUBK
Gray	USOC	6-Positions	NSJUGY
Ivory	USOC	6-Positions	NSJUI
White	USOC	6-Positions	NSJUW

F-Type Connector Keystone

Color	Catalog Number
Black	SFFGBK
Gray	SFFGGY
Ivory	SFFGEI
White	SFFGW

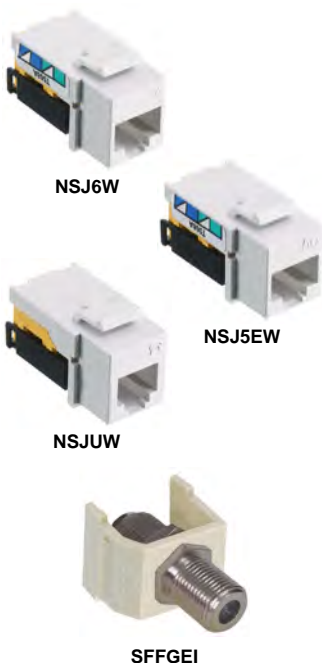

NSJ6W

NSJ5EW

NSJUW

SFFGEI

Boatyard Accessory Items

Non-Metallic While-In-Use Weatherproof Covers

- High-impact polycarbonate construction provides maximum durability
- Patented keyhole mounting system allows installation in under a minute
- Includes attached gasket and mounting hardware
- Pre-configured for GFCI with patented knockout technology for alternate devices
- Lockable tab
- NEMA 3R rated
- EXTRA DUTY® 5800 Series covers meet or exceed the extra duty rating per UL 514D and are NEMA 3R rated
- 2017 NEC® Compliant (Article 406.9A & B)
- cULus Listed



1-Gang Weatherproof Covers for Vertical or Horizontal Mounting

Description	Standard	EXTRA DUTY®
Non-metallic, black (standard) or gray (extra duty) with clear tinted cover, while-in-use, 16-in-1 configurations below.	RW57300	RW58300
Jumbo, non-metallic, black (standard) or gray (extra duty) with clear tinted cover, while-in-use, 16-in-1 configurations below.	RW57350	RW58350

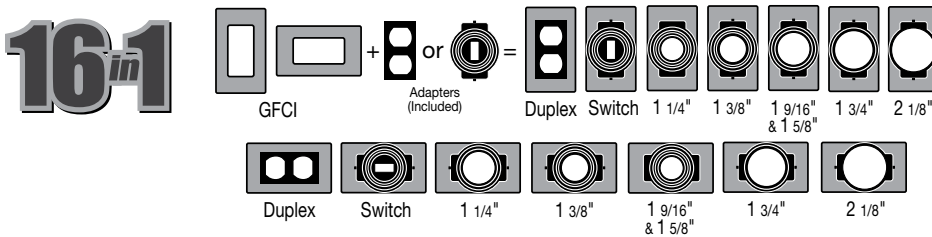

2-Gang Weatherproof Covers for Vertical Mounting Only

Description	Standard	EXTRA DUTY®
Non-metallic, black (standard) or gray (extra duty) with clear tinted cover, while-in-use, 55-in-1 configurations below	RW57750	RW58750

Note: Required by the NEC® for while-in-use outdoor power distribution. Thermoplastic covers provide protection for use in wet locations with the cover closed, NEMA® 3R rated. Meets 2017 NEC 406.9 – receptacles in damp or wet locations. Holes for padlocks are .40 inch.

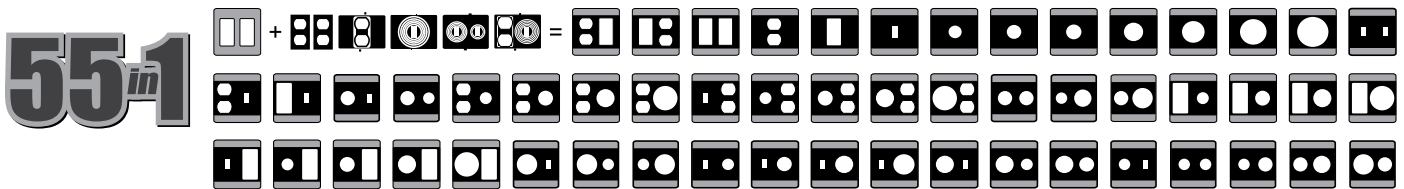

Multiple combinations of duplex, GFCI, switch, and rounds: 1 1/4", 1 3/8", 1 9/16", 1 5/8", 1 11/16", 2 1/8", 2 1/4", 2 7/16"

Product Dimensions Inches (mm)

	1-Gang		Jumbo, 1-Gang		2-Gang	
	Standard	EXTRA DUTY®	Standard	EXTRA DUTY®	Standard	EXTRA DUTY®
A	5.54" (140.7)	5.90" (149.9)	5.54" (140.7)	5.92" (150.4)	5.54" (140.7)	5.54" (140.7)
B	3.79" (96.3)	4.18" (106.2)	3.79" (96.3)	4.20" (106.7)	5.43" (137.9)	5.43" (137.9)
C	3.07" (78.0)	3.00" (76.2)	5.08" (129.0)	5.10" (129.5)	3.07" (78.0)	3.07" (78.0)

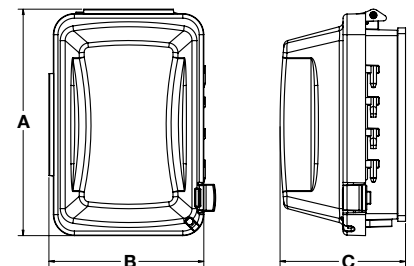

Dimensions in Inches (mm)

NEC® is a registered trademark of the The National Electrical Code.
NEMA® is a registered trademark of The National Electrical Manufacturers Association.

Features and Benefits

Stainless Steel Weatherproof and Watertight Flip Covers

Stainless steel weatherproof flip covers are suitable for use in applications where corrosion and sanitation are vital concerns. Heavy duty #316 stainless steel provides an excellent finish and superior corrosion resistance in all applications. Models listed are typically used in indoor/outdoor applications such as, food/chemical processing, pharmaceutical and water treatment facilities. Meets Section 406.9 of NEC®.

- UL Type 3R:
 - Rain-tight and sleet (Ice) resistant
 - Self-closing lid
- UL Type 4X:
 - Watertight, dust-tight and corrosion resistant for wash-down application
 - Latching cover



Flip Cover Design

- Manufactured in heavy duty #316 stainless steel for increased corrosion resistance
- Polished finish for a clean aesthetic appearance
- Smooth surfaces to allow ease of cleaning
- Horizontal and vertical mounting positions
- Duplex and GFCI versions



Self-Closing Design

- Self-closing cover
- Neoprene gasket on underside of cover. For sealing when the cover is closed



HBLSS83R



HBLSS263R



HBLSS84X



HBLSS264X

Stainless Steel Weatherproof Flip Covers

Description	Catalog Number
1-Gang, stainless steel duplex, 3R, self-closing cover.	HBLSS83R
1-Gang, stainless steel GFCI, 3R, self-closing cover.	HBLSS263R
1-Gang, stainless steel duplex, 4X, latching cover.	HBLSS84X
1-Gang, stainless steel GFCI, 4X, latching cover.	HBLSS264X

Product Dimensions Inches (mm)

Catalog Number	Height	Width	Depth	Opening
HBLSS83R	3.04" (77.2)	4.85" (123.2)	.88" (22.4)	2.62" (66.5)
HBLSS263R	3.04" (77.2)	4.85" (123.2)	.88" (22.4)	2.76" (70.0)
HBLSS84X	3.04" (77.2)	4.85" (123.2)	.88" (22.4)	2.62" (66.5)
HBLSS264X	3.04" (77.2)	4.85" (123.2)	.88" (22.4)	2.76" (70.0)

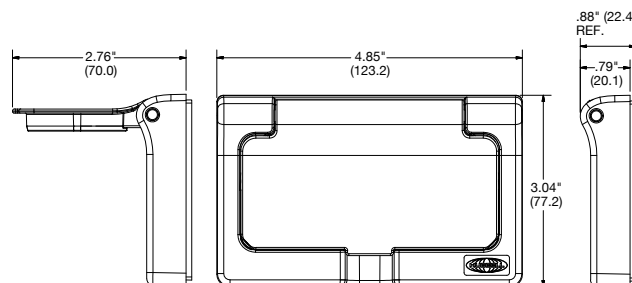

Specifications

Base & Cover	Stainless Steel
Hinge Pin & Spring	Stainless Steel
Base & Cover Gasket	Elastomer
Back Gasket	Eva Form
Ground Screw	Steel, Zinc Plated
Mounting Screw	Stainless Steel

Dimensions in Inches (mm)

NEC® is a registered trademark of the The National Electrical Code.

Boatyard Accessory Items

Marine Grade Weatherproof Plates

Description	Color	Catalog Number
Thermoplastic vertical spring-loaded lift cover plate for weatherproofing ground fault receptacles and decorator-type devices. Marine drip-proof rated with stainless steel hardware. IP44 SUITABILITY.	Gray Yellow	HBL5226 HBL52CM26
Same as above except for horizontal mounting.	Gray Yellow	HBL5226H HBL52CM26H
Valox® spring-loaded lift cover for weatherproofing duplex receptacles. Stainless steel screws and neoprene gasket included for mounting to FS/FD type weatherproof boxes. IP20 SUITABILITY.	Gray Yellow White	HBL5221 HBL52CM21 HBL52CM21W
Same as HBL52CM21 except for mounting to standard boxes.	Gray Yellow	HBL5222 HBL52CM22
Valox spring-loaded lift cover for weatherproofing single straight blade receptacles. Stainless steel screws and neoprene gasket included. For mounting to FS/FD type weatherproof boxes. IP44 SUITABILITY.	Gray Yellow	HBL7423WO HBL74CM23WO
Valox spring-loaded lift cover for weatherproofing old style 26CM10 receptacle. Meets the most stringent requirements of UL's three listing categories for weatherproof plates. Stainless steel screws and neoprene gasket included for mounting to FS/FD type weatherproof boxes. IP44 SUITABILITY.	Gray Yellow	HBL7424WO HBL74CM24WO
Valox spring-loaded lift cover for weatherproofing HBL26CM10 receptacle. Meets the most stringent requirements of UL's three listing categories for weatherproof plates. Stainless steel screws and neoprene gasket included for mounting to FS/FD type weatherproof boxes. IP44 SUITABILITY.	Gray Yellow White	HBL7425WOA HBL74CM25WOA HBL74CM25WOAW
Valox lift cover for weatherproofing 50A receptacles. Meets requirements of the most stringent of UL's three listing categories for weatherproof plates. Stainless steel screws and a neoprene gasket included. For mounting to FS/FD type weatherproof boxes. IP44 SUITABILITY.	Gray Yellow	HBL7774WO HBL77CM74WO



HBL52CM26



HBL52CM21W



HBL52CM26H

Commercial Grade Weatherproof Plates

Available in a host of configurations—Twist-Lock® and straight blade receptacles in single or duplex as well as switches—these plates are perfect for marine use. The PVC resists deterioration over time and has high tensile and impact strength. Each plate comes with a tightly sealing, rubberized gasket and a super strong lift cover spring.

Description	Catalog Number
Gray thermoplastic weatherproof lift cover for toggle switches (such as CS115). For vertical mounting in standard or FS/FD type boxes.	HBL5201
Gray PVC weatherproof lift cover for duplex receptacles (such as HBL52CM62). For vertical mounting in standard or FS/FD type boxes.	CWP8CR
Gray PVC weatherproof lift cover for ground fault receptacles (such as GF5252MGYA) and Style Line® receptacles. For vertical mounting in standard or FS/FD type boxes.	CWP26CR
Same as CWP26CR except white in color.	CWP26CRW



HBL52CM21



HBL74CM23WO



CWP8CR



CWP26CR



HBL5201



HBL77CM74WO

Valox® is a trademark of SABIC Innovative Plastics, acquired from General Electric Company.

Marine Products

Boatyard Accessory Items

Marine Grade Dockside Boxes and Covers

30 cu. in. FD box made of high impact thermoplastic material. Accepts duplex and single receptacles up to 50A Twist-Lock®.



Housing Design

- ¾" NPT and 1" NPT threaded hub options
- 30 cu. in. FD box made of high impact thermoplastic material
- External mounting feet, accepts #10 screw
- Stainless steel mounting/grounding bracket



Housing Design

- 55° angle adapter (15 cu. in.)
- External mounting feet, accepts #8 screw
- Stainless steel mounting/grounding bracket



HBL60CM83A



HBL60CM88



HBLP14FS



HBL6081



HBL6082

FD Boxes, Angled Adapters, Kits and Covers

Boxes	Gray	White	Yellow
(2) ¾" NPT Hubs, FD Boxes	HBL6083	HBL60CM83WA	HBL60CM83A
(2) 1" NPT Hubs, FD Boxes	HBL6084	HBL60CM84WA	HBL60CM84A

Adapters*

55° Angle Adapters	HBL6055*	HBL60CM55W*	HBL60CM55*
--------------------	-----------------	--------------------	-------------------

Kits

(2) ¾" NPT Hubs, Box/Adapter Kits	HBL6083AK	HBL60CM83WAK	HBL60CM83AK
(2) 1" NPT Hubs, Box/Adapter Kits	HBL6084AK	HBL60CM84WAK	HBL60CM84AK

Covers

Blank Cover Plates	HBLP14FS	HBL60CM88W	HBL60CM88
--------------------	-----------------	-------------------	------------------

Note: *Adapters are not UL Listed, nor UL Type 4X. For UL Type 4X rating, use receptacles in a FD box.

Marine Grade Dockside Boxes and Covers

Description	Catalog Number
Black phenolic junction box with four ¾ in. (19.1) I.P.S. molded-in knock-outs. Has 4.13 in. (104.8) diameter and is 1.88 in. (47.6) deep.	HBL6081
Phenolic blank cover, ¼ in. (6.4) thick, for HBL6081 box.	HBL6082
Black phenolic blank cover plate.	HBL6087
Yellow Valox® blank cover plate for use with FS and FD type boxes.	HBL60CM88

Valox® is a trademark of SABIC Innovative Plastics, acquired from General Electric Company.

Boatyard Accessory Items

Non-Metallic Vapor-tight Incandescent Fixtures

These non-metallic, vapor-tight incandescent fixtures offer long life and trouble-free lighting in wet locations in marinas and on boats. Some features of these new units are:

- UV resistant, gray, glass filled thermoplastic polyester box, mounting adapters and globe guards resists abuse and harmful effects of the elements
- Excellent temperature operating range of -40°F (-40°C) to +302°F (150°) for use in areas with wide temperature variations or extreme ambient temperatures
- High temperature silicone gasketing maintains integrity and molded threads for ease of installation/removal
- Heat resistant glass globe withstands thermal shock in wet locations and has thread type mounting to assure weathertight sealing
- High strength protective globe guard helps prevent accidental globe and lamp breakage
- Accommodates Type A incandescent lamps up to 150 watts
- UL 1598 Standard for luminaries
- UL 1598A Marine type luminaries



NVX15GHGA



NVA15GHGA



NVBA

Lighting and Lighting Fixtures

Description	Catalog Number
Ceiling mount non-metallic, vapor-tight incandescent luminaries including the fixture, mounting box, guard and heat resistant glass globe. Accepts up to 150 watt Type A incandescent lamp (not included).	NVX15GHGA
Pendant mount non-metallic, vapor-tight incandescent luminaries including fixture, mounting cap, guard and heat resistant glass globe. Accepts up to 150 watt Type A incandescent lamp (not included).	NVA15GHGA
Wall mount bracket only to adapt NVX15GHGA ceiling mount fixture to a wall mount fixture. Order NVBA and NVX15GHGA to get wall mount fixture.	NVBA
Replacement guard to NVX15GHGA and NVA15GHGA.	NVGA
Heat resistant replacement globe for NVX15GHGA and NVA15GHGA. Made of tempered glass.	VCGP100



VCGP100

Nylon Watertight Strain Relief Cord Connectors

These Hubbell nylon cord connectors provide strain relief and a watertight seal where cable enters a piece of equipment, panel, or box. A patented GOTCHA® ring, with a split and hinge design, allows for better adjustment to the cord as the connector nut is tightened, providing superior cord gripping compared to other types. A soft neoprene bushing compresses to keep liquids out and allows the nut to be easily tightened.

Description			Catalog Number
A gray male PVC adapter with ¼ in. NPT pipe thread for adapting PVC conduit to FS and FD boxes with ¼ in. NPT hub (HBL6080, HBL60CM83). Not UL Listed.			HBL6085
Description	NPT Hub Size	Diameter Range	Catalog Number
Straight nylon cord connector	½ in.	.25–.38 in. (6.4–9.5)	HBL10CM22S
	½ in.	.38–.50 in. (9.5–12.7)	HBL10CM23S
	¾ in.	.38–.50 in. (9.5–12.7)	HBL10CM35S
	¾ in.	.50–.63 in. (12.7–15.9)	HBL10CM36S
	¾ in.	.63–.75 in. (15.9–19.1)	HBL10CM37S
	1.0 in.	.63–.75 in. (15.9–19.1)	HBL10CM41S



HBL6085



HBL10CM22S

Electrical Standards

Codes and Specifications

ABYC Standard, July 2015, E-11 Excerpts.

11.4 DEFINITIONS – For the purposes of this standard, the following definitions apply.

11.4.11 Equipment Leakage Circuit Interrupter (ELCI) - A residual current device which detects equipment ground fault leakage current and disconnects all current carrying conductors from the supply source at a preset trip threshold.

11.4.14 Ground fault circuit interrupter (GFCI) - A device intended for the protection of personnel that functions to de-energize a circuit, or portion thereof, within an established period of time when a current to ground exceeds some predetermined value that is less than that required to operate the overcurrent protective device of the supply circuit.

11.4.34 Watertight - Constructed so that water will not enter the enclosure under the test conditions specified in NEMA Standard 250, Type 6P or IEC Standard 60529 Type IP67.

11.4.35 Weatherproof - Constructed or protected so that exposure to the weather will not interfere with successful operation under the test conditions specified in NEMA Standard 250, Type 3 or IEC Standard 60529 Type IP54.

11.11 GROUND FAULT PROTECTION – AC SYSTEMS

11.11.1 An Equipment Leakage Circuit Interrupter (ELCI) or Type A Residual Current Device (RCD) shall be installed with or in addition to the main shore power disconnect circuit breaker(s) or at the additional overcurrent protection as required by E-11.10.2.8.3 whichever is closer to the shore power connection.

11.11.1.1 Trip level shall be a maximum of 30mA. The trip time shall be a maximum of 100ms.

11.11.1.4 The ELCI shall be readily accessible.

Note: A ground fault circuit interrupter (GFCI) may be used on single phase AC circuits to provide additional protection for personnel and equipment.

11.11.5 GFCI receptacle devices shall meet the requirements of Underwriters Laboratories' standard UL 943, Ground Fault Circuit Interrupters and the requirements of UL 498, Electrical Attachment Plugs and Receptacles.

Note: GFCI receptacle devices may be installed as part of a convenience outlet installation either in single outlet applications or in multiple feed through installations. (See E-11.13.3.5)

11.12 SWITCHES

11.12.1.1 Switches shall have voltage ratings not less than the system voltage, current ratings not less than the connected load and shall be rated for the type of load, i.e., inductive or resistive.

11.12.3.1 Switches used in branch circuits shall simultaneously open all ungrounded conductor(s) of the branch circuit.

11.13 PLUGS AND RECEPTACLES

11.13.1.1 Receptacles shall be installed in locations not normally subject to rain, spray, or flooding but if receptacles are used in such areas the following shall apply:

11.13.1.1.1 Receptacles installed in locations subject to rain, spray, or splash shall be weatherproof when not in use.

Note: Weatherproofing may be provided by means such as spring-loaded, self-closing, or snap type receptacle covers.

11.13.1.1.2 Receptacles installed in areas subject to flooding or momentary submersion shall be of a watertight design as may be provided by a threaded, gasketed cover.

11.13.1.3 Receptacles and matching plugs used on AC systems shall not be interchangeable with receptacles and matching plugs used on DC systems.

11.13.3.1 Receptacles shall be installed in boxes that meet the requirements of UL 514A, Metallic Outlet Boxes, or 514C, Non-metallic Outlet Boxes, Flush Device Boxes And Covers.

11.13.3.2 Receptacles shall be of the grounding type with a terminal provided for the grounding (green) conductor as shown in Figure 11, Figure 12 and Figure 13 of ABYC E-11.

11.13.3.3 Power wiring for receptacles shall be connected so that the grounded (white) conductor attaches to the terminal identified by the word "white" or a light color (normally white or silver). The ungrounded conductor(s) shall be attached to the terminal(s) identified by a dark color (normally brass or copper) and, optionally, the letters X, Y and Z or L1, L2 and L3.

11.13.3.4 A branch circuit supplying a combination of receptacle loads and permanently connected loads shall not supply permanently connected loads in excess of the following:

11.13.3.4.1 600 watts for a 15 ampere circuit.

11.13.3.4.2 1000 watts for a 20 ampere circuit.

11.13.3.5 If installed in a head, galley, machinery space, or on a weather deck, the receptacle shall be protected by a Type A (nominal 5 milliamperes) Ground Fault Circuit Interrupter (GFCI). (See E-11.11.)

Note: GFCI receptacle devices are not necessarily ignition protected per E-11.5.1.4.

11.6.2.2 SHORE POWER

11.6.2.2.1 Power Inlet - The receptacle, or receptacles, installed to receive a connecting cable to carry AC shore power aboard shall be a male type connector.

11.6.2.2.2 Power inlets installed in locations subject to rain, spray, or splash shall be weatherproof whether or not in use.

11.6.2.2.2.1 Power inlets installed in areas subject to flooding or momentary submersion shall be watertight whether or not in use.

11.6.2.2.2.3 Metallic power inlets installed on metallic or carbon fiber reinforced boats using an isolation transformer or a galvanic isolator shall be insulated from metallic structure and components. On non-metallic boats using an isolation transformer or a galvanic isolator the power inlet shall be insulated from metallic components connected to the boat's ground.

11.6.2.2.1.1 Shore Power Cable – On each boat equipped with an AC shore power system, a shore power cable that contains the conductors for the power circuit and a grounding (green) conductor shall be provided.

11.6.2.2.1.2 Except where the shore power cable is permanently connected to the boat, the boat end of this cable shall be terminated with a locking and grounding female type connector to match the boat power inlet. (See Figure 12 and Figure 13 of ABYC E-11).

11.6.2.2.1.3 The shore power cable shall be flexible cord with the minimum properties of Type SOW, STW, STOW, SEOW, or STOOV and shall be suitable for outdoor use. The shore connection end of this cable shall be fitted with a locking and grounding type plug with the required number of poles and shall comply with Article 555 of the National Electrical Code. (See Figure 13 and Table VII-A of ABYC E-11).

EXCEPTION: Pin and sleeve devices in accordance with Figure 14 of ABYC E-11.

SECTION BB

Table of Contents



Circuit Testers,
Adapters and Starters



Lockout Devices



Lampholders



Product	Page
Circuit Testers	
Features and Benefits	BB-2
Twist-Lock®, Receptacle and GFCI	BB-3
Adapters and Fluorescent Starters	BB-4
Lockout Devices	BB-5

Product	Page
Lampholders	BB-6
Fluorescent Lampholders	BB-7
Incandescent Lampholders	BB-8
Lampholder Accessories	BB-9
Taps, Adapters, Plugs and Connectors	BB-10

Other Wiring Products

Features and Benefits

Twist-Lock® Circuit Testers

The Hubbell Twist-Lock® Tester is an exclusive patented design that easily tests the circuit condition without the need for traditional measurement techniques. Whether it is a contractor, electrician, or entertainment stage crew, knowing that power is present at any receptacle or connector is critical. By plugging the tester into an outlet, an LED output will immediately provide the state of the circuit.

An easy to read card is provided with the tester, to help determine if the connections are made properly and in the correct position. This unique NEMA configuration ensures that the proper connection was made through an easy to read output display. It also easily attaches to a tool belt so it is available when needed.

- Quickly diagnose mis-wiring situation or application
- Great for dark, difficult to reach spaces
- No measurement readings to interpret
- UL 1436 listed



Housing Design

- Insulgrip® nylon housing for secure gripping
- Brass blades
- Steel (nickel plated) assembly screws
- Styles available: L21-20P, L21-30P, L5-20P, L5-30P, L5-30P Marine, L6-20P, L6-30P, L7-20P, L14-20P, L14-30P, L24-20P



Attachment Clip

- Carabiner style clip to secure to work belt



Proper Connection

- Easy to read LED output and condition tables

CONDITIONS	X	Y	Z	G
Correct	X	Y	Z	G
Open Neutral				G
Open Ground	X	Y	Z	
Open X		Y	Z	
Open Y	X		Z	G
Open Z	X	Y		G



CONDITIONS	X	Y	Z	G
X & N Rev.	X	Y	Z	▲
Y & N Rev.	X	Y	Z	G ▲
Z & N Rev.	X	Y	Z	G ▲
X & G Rev.		Y	Z	G ▲
Y & G Rev.	X		Z	G ▲
Z & G Rev.	X	Y		G ▲

Other Wiring Products

Twist-Lock® Circuit Testers



Description	Rating	20 Amp		30 Amp	
		Configuration	Catalog Number	Configuration	Catalog Number
3-Phase Circuit Tester	3Ø 120/208V AC Min. Voltage: 90V AC	NEMA L21-20P 	HBL3PT2511	NEMA L21-30P 	HBL3PT2811
Circuit Tester	125V	NEMA L5-20P 	HBLT2311	NEMA L5-30P 	HBLT2611 HBLT26CM11 (Marine)
	250V	NEMA L6-20P 	HBLT2321	NEMA L6-30P 	HBLT2621
	277V	NEMA L7-20P 	HBLT2331		
	125/250V	NEMA L14-20P 	HBLT2411	NEMA L14-30P 	HBLT2711
	347V	NEMA L24-20P 	HBLT3721		
	128/208V AC	Non-NEMA	HBLT3521		

Note: Testers in other NEMA configurations can be developed upon request.



HBL3PT2511



HBLT26CM11



SNAPCTG

SNAPConnect® Receptacle Wiring Tester with GFCI Test Button

Description	Catalog Number
Circuit Tester for SNAPConnect receptacle terminals, GFCI and standard receptacles.	SNAPCTG

Receptacle Circuit Tester



Description	Catalog Number
Receptacle circuit tester.	HBL5200

How It Operates

The Hubbell HBL5200 Receptacle Circuit Tester has a simple arrangement of neon lights which visually indicate and identify various fault conditions in electrical circuits (see chart below). By plugging the HBL5200 Tester into a single phase, 125V, 2 pole, 3 wire outlet the combination of lighted and/or unlighted lamps will immediately indicate circuit condition.

- Large, easy to read symbols.
- Recessed indicating lamps with one piece Polycarbonate lens.
- Tough impact resistant nylon housing.
- User information and instructions printed on durable Polyester labels permanently attached to the tester.
- Rotatable labels can be easily read regardless of tester position.



Correct Wiring Reversed Polarity Open Ground Wire Open Neutral Wire Open Hot Wire Hot and Ground Reversed Hot on Neutral Term. and Hot Term. Unwired

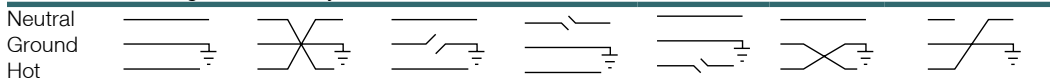

Note: □ △ ○ Indicates Unlighted Lamp. ■ ▲ ● Indicates Lighted Lamp.
When testing other receptacle types, use HBL5200 only with polarized adapters.

CAUTION: This device introduces low level current into the grounding path. Use with caution in critical care areas.



HBL5200



GFT2G

GFCI Tester

Description	Rating	Catalog Number
Ground fault tester.	120V AC	GFT2G

- Designed to measure the trip level of portable or "wired-in" GFCI's in a range of 2-7mA. Leakage level can be adjusted from 2-7mA.
- Ideal for measuring leakage level of GFCI breakers, GFCI portables and GFCI receptacles.

Other Wiring Products

Features and Benefits

Adapters and Fluorescent Starters

- Available in 6 different configurations
- One female slot end and one male blade end
- UL listed, except for adapter **HBL31CM29**



HBL2271



HBL5273L



HBL5289



9053A



9054A



FS2

Nylon Convenience Adapters

NEMA Configuration

Catalog Number	HBL2270	HBL2271	HBL2128	HBL2274	HBL2129	HBL31CM29*
Male Blade End	15A 125V NEMA 5-15P	15A 125V NEMA 5-15P	15A 125V NEMA 5-15P	15A 125V NEMA L5-15P	20A 125V NEMA L5-20P	30A 125V NEMA L5-30P
Female Slot End	20A 125V NEMA 5-20R	15A 125V NEMA L5-15R	20A 125V NEMA L5-20R	20A 125V NEMA 5-20R	20A 125V NEMA 5-20R	20A 125V NEMA 5-20R

Note: *Not UL Listed.

CAUTION: Where adapters have different ratings on the blade and slot end the following precautions must be exercised in their use.
 (1) Remember that overcurrent protection is determined by the blade end.
 (2) The use of the adapter should be limited to the lowest rated end of the adapter in order to prevent overheating.
 (3) Adapters do not provide GFCI, overcurrent or short circuit protection.

Plug In Adapters

Description	Catalog Number
Male end - 2 wire parallel polarized blades, 15A, 125V. Female end - 3 wire 15A, 125V straight slot grounding.	HBL5273L
Male end - 3 wire crow foot 15A, 125V blades. Female end - 3 wire 15A, 125V straight slot grounding.	HBL5289 ♦*
Male end - 3 wire 10A, 250V, 15A, 125V Twist-Lock® blades. Female end - 3 wire 15A, 125V straight slot grounding.	9053A ♦*
Male end - 3 wire 15A, 125V straight blade grounding. Female end - 10A, 250V, 15A 125V Twist-Lock® slots.	9054A ♦*

Note: ♦Must always be used with a grounded receptacle.
 *Not UL Listed.

Fluorescent Starters



Neostart	Lamps	Catalog Number
The Hubbell Neostart is a glow discharge type of starter which combines fast starting speed with rugged, dependable operation. The Neostart lights the lamp very rapidly and insures proper lamp operation throughout rated life. Because of its rugged construction, it can be depended upon to withstand continued punishment resulting from lamp failure. In addition, it operates satisfactorily over a wide temperature range. In dual lamp circuits, the Neostart lights both lamps quickly and uniformly.	14, 15 and 20 watt lamps	FS2
	13, 30 and 40 watt lamps	FS4
	4, 6 and 8 watt lamps	FS5
	22 watt circle line, 25 watt standard lamps	FS25

Other Wiring Products

Lockout Devices

PLUGOUT®, Keyed PLUGOUT® and SWITCHOUT® Lockout Devices

Description	Typical Devices Accommodated	Catalog Number
Small yellow lockout device.	15 and 20A straight blade plugs. 15A Twist-Lock® plugs.	HLDMP
Medium yellow lockout device.	15 and 20A, 125V straight blade plugs. 20 and 30A Twist-Lock® plugs.	HLD
Large yellow lockout device.	20, 30 and 60A metallic and non-metallic Pin and Sleeve, Hubbellock® and 50A Twist-Lock® plugs.	HLD2
Yellow SWITCHOUT device.	Toggle switch.	HSLDPK2*
Yellow lockout kit.	One each of above lockout devices.	HLDKIT
Yellow keyed PLUGOUT, keyed differently.	15 and 20A, 125V straight blade plugs with holes in blades.	HKLD

Note: *Two devices per package.

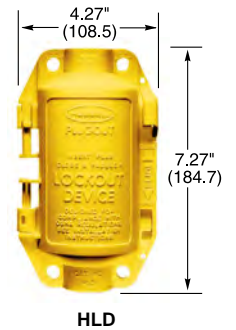
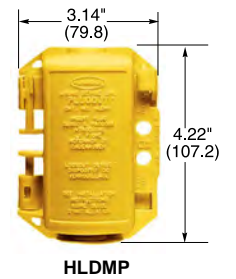

Cord Grip

Description	Catalog Number
Cord grip for ½ inch knockouts.	HBL112*

Note: *Not UL Listed.



Other Wiring Products

Lampholders

Lampholders provide lighting in unfinished areas, such as attics and basements.

Porcelain White Lampholders



Catalog Number	RL8804	RL8806	RL8812	RL8816	RL8822
Description	Keyless, 4 Terminal Screws	Keyless, 6 inch Pigtails	Pull Chain, 2 Terminal Screws	Pull Chain, 6 inch Pigtails	Pull Chain with Receptacle, 2 Terminal Screws
Rating	660W 250V	660W 250V	660W 250V	660W 250V	660W 125V 15A 125V NEMA 5-15R

Plastic White Lampholders



Catalog Number	RL8504	RL8506	RL8512	RL8516
Description	Keyless, 4 Terminal Screws	Keyless, 6 inch Pigtails	Pull Chain, 2 Terminal Screws	Pull Chain, 6 inch Pigtails
Rating	660W 600V	660W 600V	660W 250V	660W 250V

Incandescent Brass Lampholders, Medium Base



Catalog Number	RL101*	RL102*	RL105*	RL100**	RL106*
Description	Turn Knob, On/Off	Turn Knob, Three Way	Push Through, On/Off	Keyless	Pull Chain, On/Off
Rating	250W 250V	250W 250V	660W 250V	660W 250V	660W 250V

Note: *UL or cUL.
**UL or CSA.

Other Wiring Products

Fluorescent Lampholders

Compact Fluorescent Lampholders

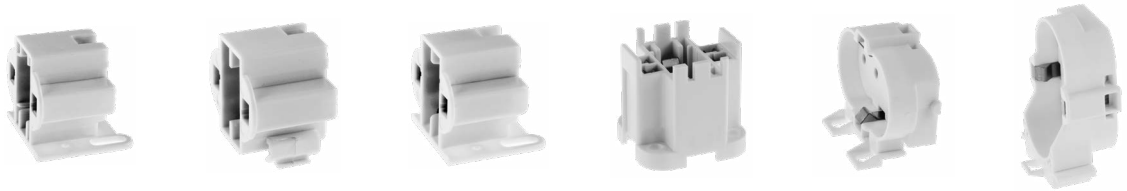

Catalog Number	RL479HSM	RL413HSI	RL413HSM	RL426G24	RL42G11HSM	RL42G11H9
Description	G23 base	GX23 base	GX23 base	G24Q-3, GX24Q-4	2G11 base, 4 pin	2G11 base, 4 pin
Lamp Type	5W, 7W, 9W	13W	13W	26-32W	18-55W	18-55W
Rating	75W, 600V	75W, 600V	75W, 600V	75W, 600V	75W, 600V	75W, 600V
Mounting	Horizontal, screw-down	Horizontal, snap-in	Horizontal, screw-down	Horizontal, screw-down	Horizontal, screw-down	Vertical 90°, snap-in

RL42G11C



Clip for 2G11 Base Lampholders, Adjustable, Snap-in

High Output Fluorescent Lampholders



Catalog Number	RL305*	RL306*	RL307	RL308	RL356	RL357
Description	Plunger	Fixed	Plunger	Fixed	Plunger	Fixed
Lamp Type	Horizontal - Recessed double contact	Horizontal - Recessed double contact	Horizontal - Recessed double contact	Horizontal - Recessed double contact	Vertical - Power groove & jacketed lamps	Vertical - Power groove & jacketed lamps
Rating	660W, 600V	660W, 600V	660W, 600V	660W, 600V	660W, 600V	660W, 600V
Mounting	Pedestal, slide-on	Pedestal, slide-on	Slide-on, snap-in	Slide-on, snap-in	Slide-on, snap-in	Slide-on, snap-in

Note: *UL or cUL.

Medium Bi-Pin Fluorescent Lampholders - T8 and T12



Slimline Type Fluorescent Lampholder



Catalog Number	RL320	RL325	RL325B
Description	Disconnect 4 wire	Disconnect 4 wire	Shunted 2 wire
Lamp Type	Bi-pin/tall profile	Bi-pin/low profile	Bi-pin/low profile
Rating	660W, 600V	660W, 600V	660W, 600V
Mounting	Slide-on and snap-in with captive nut	Slide-on and snap-in with captive nut	Slide-on and snap-in

Catalog Number	RL310*	RL311*
Description	Plunger	Fixed
Lamp Type	Single pin	Single pin
Rating	660W, 600V	660W, 600V
Mounting	Slide-on and snap-in	Slide-on and snap-in

Note: *UL or cUL.

Other Wiring Products

Incandescent Lampholders

HID Incandescent Lampholders, Porcelain Keyless



Catalog Number	RL4221*	RL5221	RL3742
Description	Mogul base	Mogul base	Medium base prefocus
Lamp Type	E39 socket	EX39 socket	Bayonet socket
Rating	1500W, 600V Max, 4KV or 5KV PULSE	1500W, 600V Max, 5KV PULSE	1200W, 250V
Mounting	Screw mount, 12 inch leads	Screw mount, 12 inch leads	Screw mount

Note: *UL Listed, CSA Certified.

Straight Body Keyless Porcelain



Catalog Number	RL162	RL156	RL157	RL160	RL158	RL159
Description	Medium base	Medium base	Medium base	Medium base	Medium base, low profile	Medium base, shallow base
Lamp Type	E26 socket	E26 socket	E26 socket	E26 socket	E26 socket	E26 socket
Rating	660W, 250V	660W, 250V	660W, 250V	660W, 250V	660W, 250V	660W, 250V
Mounting	Screw mount, screw terminals	Screw mount, 12 inch leads	NPSF1/8 hickey with terminals	NPSF1/8 hickey with 12 inch leads	Front mount, panel mount snap-in	Front mount, panel mount snap-in

Surface and Sign Mount, Medium Base



Catalog Number	RL152	RL153	RL161	RL163	RL164
Description	Medium base, Porcelain, Pony Cleat	Medium Base, Plastic, Black, Pony Cleat	Medium base, Porcelain	Medium base, Porcelain	Medium base, Porcelain
Lamp Type	E26 socket	E26 socket	E26 socket	E26 socket	E26 socket
Rating	660W, 600V	660W, 250V	660W, 250V	660W, 250V	660W, 250V
Mounting	1 piece, surface mount	1 piece, surface mount	2 piece, surface mount	2 piece, sign mount with leads	2 piece, sign mount with terminals

Other Wiring Products

Lampholder Accessories

Incandescent Lampholders, Medium Base



Catalog Number	RL124*	RL124H	RL202
Description	Pigtail Medium Base Socket with 6 inch Leads, Rubber with #18 Gauge Wire	Phenolic Medium Base Socket with Hook, Insulation Piercing Termination	Medium Lampholder to Lampholder Adapter, Pull Chain with Two 2-Prong Outlets without Ground
Rating	660W 250V	660W 250V	660W 125V 15A 125V

Note: *cCSAus Certified only.

Incandescent Adapters, Medium Base



Catalog Number	RL150	RL154	RL200	RL201
Description	Medium to medium base extension, Screw-in, E26 to E26 socket	Mogul to medium base adapter, Screw-in E39 to E26 socket	Outlet Adapter, 2 Prong Plug to Medium Lampholder	Medium Lampholder Adapter, Medium Lampholder to Outlet without Ground
Rating	250W, 250V	660W, 250V	15A 660W 125V 15A 125V NEMA 1-15R	15A 125V NEMA 1-15R

Lamp Switches



Catalog Number	RL120	RL121	RL122	RL125
Description	Pull chain switch, 2 circuit, L1/L2/L1+L2/off	Pull chain switch, SPST on/off	Pull chain switch, L1/L2/L3/off	Rotary switch, SPST on/off
Rating	6A 125V AC, 3A 250V AC, 3A 125V "L"	6A 125V AC, 3A 250V AC, 3A 125V "L"	6A 125V AC, 3A 250V AC	6A 125V AC, 3A 250V AC, 3A 125V "L"

Note: 6 inch wire leads are #18 AWG AWM/TEW 105°C 600V.

Snap-in Receptacles



Catalog Number	RR374	RR374W
Description	Single receptacle, Black	Single receptacle, White
Rating	15A 125V, 3 wire NEMA 5-15R	15A 125V, 3 wire NEMA 5-15R

- Accommodate panel thickness of .031 to .062 inch (0.7 to 1.5 mm).
- Panel cutout .95 x .95 inch (24.1 x 24.1 mm).
- #14 AWG 6 inch AWM/TEW FT1 105°C 600V on black and white leads.
- #14 AWG 6 inch AWM/TEW FT1 600V on green lead.

Other Wiring Products

Taps, Adapters, Plugs and Connectors



Taps and Adapters



Color	RT600I	RT300I	—	RT200*	—
Ivory	—	—	—	—	—
Orange	—	—	RT303	—	—
White	RT600W	RT300W	—	—	RT100W
Description	Duplex Receptacle to Six Outlets with Ground	Single Receptacle to Three Outlets with Ground	Single Receptacle to Three Outlets, Heavy Duty Rubber, with Ground	Two Wire to U-Ground	Cube Tap without Ground
Rating	15A 125V AC NEMA 5-15	15A 125V AC NEMA 5-15	15A 125V AC NEMA 5-15	15A 125V AC NEMA 5-15	15A 125V AC NEMA 1-15

Note: *UL Listed only.

Plugs and Connectors



Color	RP101BK RP101W	RP102BK RP102W	RP646 —	RP648 —	RP649 —
Black	—	—	—	—	—
White	—	—	—	—	—
Description	Straight Plug, Polarized, Two Blade Light Duty	Straight Connector, Polarized, Two Blade, Light Duty	Straight Plug, Non-Polarized, Two Blade, Heavy Duty	Straight Plug, Polarized, Two Blade, Heavy Duty	Straight Connector, Polarized, Two Blade, Heavy Duty
Wire Range Cord	#16,18 AWG, Up to .250 inch Dia.	#16,18 AWG, Up to .250 inch Dia.	#14-18 AWG, Up to .330 inch Dia.	#14-18 AWG, Up to .330 inch Dia.	#14-18 AWG, Up to .330 inch Dia.
Rating	15A 125V NEMA 1-15P	15A 125V NEMA 1-15P	15A 125V NEMA 1-15P	15A 125V NEMA 1-15P	15A 125V NEMA 1-15P



Color	RP123I RP123W
Ivory	—
White	—
Description	Straight Plug, Non-Polarized, Two Blade
Cord	SPT 1 and 2 Cord 18/2 & 16/2 AWG
Rating	15A 125V NEMA 1-15P

SECTION Tech

Table of Contents



Certification Agencies and Markings



Circuit Wiring Diagrams

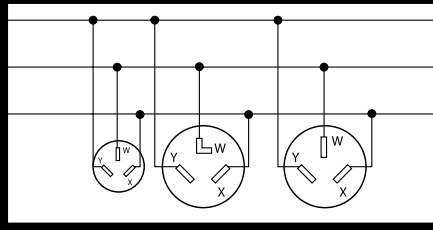

Electrical Symbols and Abbreviations

- ◻ Push Button ◻ Buzzer
- ◻ Bell ◊ Annunciator
- ◀ Outside telephone
- ◀ Interconnecting telephone
- ◀ Telephone switchboard
- ⊕ Bell ringing transformer
- ◻ Electric door opener

Product	Page
Product Standards and Installation Codes	Tech-2
Certification Agencies and Markings	Tech-4
Industry Associations, Organizations and Standards	Tech-5
Codes and Standards Organizations	Tech-6
AC Switch Data and Horsepower Explanation	Tech-7
Wiring Device Standards and Testing	Tech-8
RoHS, WR, TR and LED Power Descriptions	Tech-10
NEMA and IEC Classifications - Enclosures	Tech-11
IP Code and Their Meanings	Tech-11
Enclosure Types for Self-Certified Non-Hazardous Locations	Tech-12

Product	Page
Circuit Wiring Diagrams	Tech-14
Horsepower Ratings for NEMA Configurations	Tech-19
UL 508A Table SB4.1	Tech-19
Isolated Ground Story	Tech-20
Decimal Equivalents Table	Tech-21
Electrical Symbols and Abbreviations	Tech-22
Diameter Ranges of Jacketed Cord and Wire Charts	Tech-23
IEC Pin and Sleeve Terminal Identification	Tech-24
Horsepower Ratings for IEC Pin and Sleeve	Tech-25
Network Cabling Requirements	Tech-26

General Technical Data

Product Standards and Installation Codes

Standards and codes of many types developed by and for our industry form a vital consideration in the design of our products. The following pages in this section briefly describe the functions of the organizations producing the standards which influence the safety and design of wiring devices.

The American Boat and Yacht Council Inc. (ABYC) is a not-for-profit membership organization that has been developing and updating the safety standards for boat building and repair for over 50 years. ABYC is actively involved with the International Organization for Standardization (ISO) and is a leader in education for the marine industry, as well as certification programs for marine technicians. ABYC's membership includes boat builders, boat owners, surveyors, boat yards, insurance companies, law firms, trade associations, marinas, dealerships, government agencies, educational institutions and equipment and accessory manufacturers. Over 400 volunteers donate time, expertise, and research while serving on technical committees, which develop and revise the ABYC standards and technical information reports. We ensure quality and professionalism in each of ABYC's services.

UL LLC, formerly Underwriters Laboratories Inc. (UL) A for-profit corporation, operating in two distinct roles, as a certifier and testing facility, and as a developer of safety standards. By its own definition, Underwriters Laboratories defines itself as follows: "Underwriters Laboratories Inc. founded in 1894, is chartered as a not-for-profit organization without capital stock, under the laws of the state of Delaware to establish, maintain, and operate laboratories for the examination and testing of devices, systems and materials to determine their relation to hazards to life and property." On January 1, 2012, UL moved to a for-profit structure.

Separate from product certifications, UL develops consensus safety standards for the U.S. UL evaluates products for paying "clients" and if the product submitted passes the requirements of the UL standard for which it is submitted, a UL "Listing" is granted which allows the manufacturer to use the UL manifest or "Label" on its products. Electrical inspectors or other Authorities Having Jurisdiction (AHJs) use UL Listings of products to determine acceptability of electrical installations. It is important to remember that UL is not an approval agency. It approves nothing, but lists a product as meeting minimum standards for safety. The Underwriters "Listing" mark on a product is generally accepted by the public and government agencies as evidence of a "safe" product, not necessarily a "quality" product.

CSA Group, formerly Canadian Standards Association (CSA) is a not-for-profit membership-based association and performs a function for manufacturers similar to that performed in the USA by Underwriters Laboratories Inc. (UL) and National Fire Protection Association (NFPA). CSA Standards develops product safety standards for Canada, which parallel UL standards in many aspects but are not always identical. CSA International evaluates products and grants paying clients "Certification" that their products meet CSA Standards. CSA Standards also sponsors the Canadian Electrical Code (CE Code).

American National Standards Institute, Inc. (ANSI) as the voice of the U.S. standards and conformity assessment system, the American National Standards Institute (ANSI) empowers its members and constituents to strengthen the U.S. marketplace position in the global economy while helping to assure the safety and health of consumers and the protection of the environment.

The Institute oversees the creation, promulgation and use of thousands of norms and guidelines that directly impact businesses in nearly every sector: from acoustical devices to construction equipment, from dairy and livestock production to energy distribution, and many more. ANSI is also actively engaged in accrediting programs that assess conformance to standards – including globally-recognized cross-sector programs such as the ISO 9000 (quality), ISO 14000 (environmental) and ISO 17025 (laboratory) management systems.

The International Electrotechnical Commission (IEC) is the leading global organization that prepares and publishes international standards for all electrical, electronic and related technologies. These serve as a basis for national standardization and as references when drafting international tenders and contracts. Through its members, the IEC promotes international cooperation on all questions of electrotechnical standardization and related matters, such as the assessment of conformity to standards, in the fields of electricity, electronics and related technologies.

IEC's international standards facilitate world trade by removing technical barriers to trade, leading to new markets and economic growth. Put simply, a

General Technical Data

Product Standards and Installation Codes

component or system manufactured to IEC standards and manufactured in country A can be sold and used in countries B through Z. IEC's standards are vital since they also represent the core of the World Trade Organization's Agreement on Technical Barriers to Trade (TBT), whose 100-plus central government members explicitly recognize that international standards play a critical role in improving industrial efficiency and developing world trade.

The National Electrical Code® (NEC®)

The NEC is a model installation code developed by NFPA's Committee on the National Electrical Code®, which consists of 19 Code-Making Panels and a Technical Correlating Committee. Work on the NEC is sponsored by the National Fire Protection Association (NFPA). The NEC is approved as an American National Standard by the American National Standards Institute (ANSI). It is formally identified as ANSI/NFPA 70. The NEC must be adopted locally by legislation or regulation.

First published in 1897, the NEC is updated and published every three years. The 2017 edition will be published in October 2016. Most states adopt the most recent edition within a couple of years of its publication. As with any "uniform" code, a few jurisdictions regularly omit or modify some sections, or add their own requirements (sometimes based upon earlier versions of the NEC, or locally accepted practices). However, the NEC is the least amended model code, even with it setting minimum standards. No court has faulted anyone for using the latest version of the NEC, even when the local code was not updated to the most recent edition.

National Electrical Manufacturers Association (NEMA®) An organization of over 450 manufacturers of electrical equipment, including, but not limited to, wiring devices, wire and cable, conduit, load centers, pressure wire connectors, circuit breakers, fuses, etc. NEMA is the "voice" of the electrical industry, and through it, standards are developed for electrical distribution.

Generally these standards promote interchangeability between products of one manufacturer with like products made by another manufacturer. In some cases, standards relating to product "performance" are also formulated by NEMA but these are the exception rather than the rule.

NEMA standards are not compulsory, but generally are accepted by those manufacturers that help to write them as a way of making their products more saleable and acceptable. However, many NEMA

standards, such as ANSI/NEMA WD 6, are approved by the American Standards Institute and referenced by mandatory UL and CSA product standards. NEMA standards are utilized by many consumers in writing specifications for the materials they purchase. NEMA does not evaluate or certify products or enforce regulations.

General Services Administration Federal Supply Service (GSA) Federal Supply Service (FSS) provides federal customers with the products, services, and programs to meet their supply, service, procurement, vehicle purchasing and leasing, travel and transportation, and personal property management requirements. Hubbell offers devices listed by UL as FED SPEC and can be found throughout this catalog.

Occupational Safety and Health Administration (OSHA) is a branch of the US Department of Labor which was created to assure safe and healthful working conditions for working men and women. OSHA uses regulations from the Federal Register, NFPA and the National Electric Code to establish and enforce safety standards for the workplace. It is important to note: OSHA does NOT approve products. OSHA enforces existing safety regulations.

Canadian Electrical Code, Part I (CE Code)

The CE Code is a model installation code developed by the Committee on CE Code, Part I, composed of members representing inspection authorities, manufacturing and utilizing industries, utilities and allied interests. The Committee meets annually to address reports submitted by 43 section subcommittees. Work on CE Code, Part I is sponsored by CSA Standards. The product standards of CSA Standards comprise the Canadian Electrical Code, Part II.

First published in 1927, the CE Code, Part I, is updated and published every three years, prior to 2006 every four years. The 2012 CE Code, Part I, is the latest edition. As with any "uniform" code, provinces and a few jurisdictions regularly modify or add their own requirements.

NSF International, formerly National Sanitation Foundation (NSF) NSF International is a not-for-profit organization founded in 1944 from the University of Michigan's School of Public Safety. NSF develops public health standards, and provides and enforces certifications to protect food, water, and beverages. NSF is the leading certifier of food service equipment.









General Technical Data

Certification Agencies and Markings

Understanding Certification Marks:

Certification marks vary significantly with respect to testing required to achieve a particular mark. In some cases, (i.e.: Specification Grade), no outside certification agency is involved. The manufacturer decides which of their products they wish to be so identified. The following table for 15 and 20A Straight Blade receptacles demonstrates these wide differences. The understanding of these marks permits the user/specifier to make more meaningful product selections.

Understanding Product Certification Marks - 15 and 20 Amp Straight Blade Receptacles
Products that carry certification marks must meet the specific testing standards indicated

Certification Mark	Description	UL 498	CSA, C22.2 No. 42	UL 498 Hospital Grade	CSA, C22.2 No. 42 M Hospital Grade	DESC WC596
Spec Grade*	Self Certified, No Testing Required- Advertising/Trade Name					
	Used on recognized component parts that are part of a Listed product or system intended for the United States. Component "C" intended for Canada. Recognized components are intended only for installation by Original Equipment Manufacturers (OEMs) within their Listed products, and are not accepted by electrical inspectors for general-use field installations due to limitations called Conditions Of Acceptability (COA).	X				
	Used on recognized component parts that are part of a Listed product or system intended for the United States and Canada. Recognized components are intended only for installation by Original Equipment Manufacturers (OEMs) within their Listed products, and are not accepted by electrical inspectors for general-use field installations due to limitations called Conditions Of Acceptability (COA).	X				
	Products found with this mark means Underwriters Laboratory or CSA International found that representative samples of this product met Underwriters Laboratory's published Standards for Safety intended for the US market.	X				
	Products found with this mark are certified primarily for the Canadian market.		X			
	Products intended for US and Canada.	X	X			
 • Hospital Grade	In addition to complying with general use requirements, this mark denotes these device have been specially designed and are subject to additional requirements of the standards.	X		X		
 • Hospital Grade	In addition to complying with general use requirements, this mark denotes these device have been specially designed and are subject to additional requirements of the standards.		X		X	
 Fed. Spec.	In addition to complying with general use grade requirements, this mark denotes receptacles also have been investigated for compliance with United States Federal Specification W-C-596.	X				X
 Fed. Spec. • Hospital Grade	In addition to complying with general use and hospital grade requirements, this mark denotes receptacles also have been investigated for compliance with United States Federal Specification W-C-596.	X		X		X

Note: *Includes such variation as Premium Spec, Super Spec, etc.
**End Product test also required.

Cross Reference Note:

Recognize that cross reference guides supplied by some manufacturers should be used only to determine compatible devices (rating and configuration). It does not, in any way, deal with performance levels (which will vary widely by manufacturer). Common catalog numbers are often used for convenience of selection. The use of the same catalog number is solely the discretion of the manufacturer. It in no way implies compliance to any standard or testing criteria.

General Technical Data

Industry Associations, Organizations and Standards

For convenience, the following listings define common acronyms for a variety of organizations.

Standards Development Organizations: Organizations primarily involved in the development and/or promulgation of standards.

ANSI	American National Standards Institute.
CANENA	Consejo de Armonizacion de los Naciones de America.
CSA	Canadian Standards Association.
IEC	International Electrotechnical Commission.
IEEE	Institute of Electrical & Electronics Engineers, Inc.
ISA	The Instrumentation, Systems and Automation Society.
ISO	International Organization for Standardization.
LEEDS	Leadership in Energy and Environmental Design.
NFPA	National Fire Protection Association, Inc.
NSF	National Sanitation Foundation.
SAE	Society of Automotive Engineers.
SME	Society of Manufacturing Engineers.
USGBC	United States Green Building Council.
UL	Underwriters Laboratories Inc.



Installation Codes

CEC Part I	Canadian Electrical Code, Part I.
NEC®	National Electrical Code®.
NOM	Normas Oficiales Mexicanas (Mexican Electrical Code).



Industry Associations: Associations of companies or individuals for the purpose of standardization, trade, and professional development, etc.

ABYC	American Boat and Yacht Council.
ASTM	American Society for Testing and Materials.
BICSI	Building Industry Consulting Services International.
BOMA	Building Owner Management Association.
CANAME	Camara Nacional de Manufacturas Electricas.
CEMRA	Canadian Electrical Manufacturers Representative Association.
ECOC	Electrical Contractors of Canada.
EF-C	Electro-Federation-Canada.
EIA	Electronic Industries Alliance.
EPRI	Electric Power Research Institute.
IAEI	International Association of Electrical Inspectors.
IECI	Independent Electrical Contractors International.
IFMA	International Facilities Management Association.
NAED	National Association of Electrical Distributors.
NAW	National Association of Wholesalers.
NECA	National Electrical Contractors Association.
NEMA	National Electrical Manufacturers Association.
NEMRA	National Electrical Manufacturers Representatives Association.
NMDA	National Marine Distributor Association.
NMRA	National Marine Representative Association.
SEMI	Semi Conductor Equipment and Material International.
TIA	Telecommunication Industry Association.



General Technical Data

Codes and Standards Organizations

For convenience, the following listings define common acronyms for a variety of organizations.

Certification Agencies: Primarily involved in certification of products or manufacturers to standards developed by the certification agency or by others.

ANCE	National Association of Normalization and Certification of the Electrical Sector.
BSI	British Standards Institute.
CE	Self Certification Marking of European Community.
CCC	China Compulsory Certification.
CSA	Canadian Standards Association or CSA International.
FM	Factory Mutual.
NRTL	Nationally Recognized (by OSHA) Testing Laboratory.
PSE	Product Safety Electrical Appliance and Material (Japan).
TÜV	TÜV Rheinland of N.A., Inc.
UL	Underwriters Laboratories Inc.
VDE	Verband Deutscher Elektrotechniker (Germany).



Note:  Hubbell products are in the process of being certified in Mexico. Many have already been certified. Consult with the factory for specific data.

Government Agencies

DSCC	Defense Supply Center – Columbus.
EU	European Union.
FCC	Federal Communications Commission.
IAPA	Industrial Accident & Prevention Association (Canada).
OSHA	Occupational Safety and Health Administration.

Copies of standards referred to on the preceding pages may be purchased from the following:

American Boat and Yacht Council, Inc. (ABYC)
613 Third Street, Suite 10
Annapolis, MD 21403
USA

The American National Standards Institute (ANSI)
25 West 43rd Street,
(between 5th and
6th Avenues), 4 floor
New York, NY 10036

or

1819 L Street, NW
(between 18th and
19th Streets), 6th floor
Washington, DC 20036
USA

CSA Group (CSA)
178 Rexdale Boulevard
Toronto, Ontario
M9W 1R3
CANADA

National Electrical Manufacturers Association (NEMA)
1300 North 17th Street
Rosslyn, VA 22209
USA

National Fire Protection Association (NFPA)
1 Batterymarch Park
Quincy, MA 02169-7471
USA

NSF International (NSF)
789 North Dixboro Road
Ann Arbor, MI 49105
USA

The International Electrotechnical Commission (IEC)
IEC Central Office
3, rue de Varembe
P.O. Box 131
CH - 1211 GENEVA 20
Switzerland

Asociacion Nacional de Normalizacion y Certificacion del Sector Electrico A.C. (NOM – ANCE)
Ibsen No.13,
Colonia Chapultepec Polanco,
C.P.11560 México, D.F.,
Conmutador 5280-6775

Occupational Safety and Health Administration (OSHA)
Occupational Safety & Health Administration
200 Constitution Avenue, NW
Washington, DC 20210
USA

UL LLC (UL)
Underwriters Laboratories Inc.
333 Pfingsten Road
Northbrook, IL 60062-2096
USA

General Technical Data

AC Switch Data and Horsepower Explanation

AC Test Requirements

When AC general use switches were considered by the industry and Underwriters' Laboratories, Inc. thought was given to the ratings and it was decided to rate the switches in accordance with NEC branch circuit ratings of 15, 20 and 30 amperes. It was also decided to test the switch for all the loads that could be applied to a branch circuit. Therefore, all AC switches are tested on resistance, tungsten lamp and inductive loads to 100% of switch rating.

Underwriters' Laboratories and Canadian Standards Association Test requirements for AC General Use Switches

In order to be listed by Underwriters' Laboratories, Inc. and certified by CSA International, all 15, 20 and 30 amperes 120/277V AC switches must perform, without failure, the following sequence of tests.

1. An overload test of 100 cycles at 4.8 times rated current and 40-50% power factor and rated voltage. This overload test is performed at 144 amps, 277 volts for 30 ampere switches at 6-10 cycles per minute.
2. 10,000 cycles on a plain resistance load at full rating of 15, 20 or 30 amperes, at 277 volts at 18-24 cycles per minute.
3. 10,000 cycles on an inductive load of either 15, 20 or 30 amperes at 277 volts, 80% power factor at 24 cycles per minute.
4. 10,000 cycles at 15, 20 or 30 amperes, 120 volts on a tungsten filament lamp load at 6-10 cycles per minute.
5. Temperature rise at test-rated load. In this test, temperature rise must not exceed 30 degrees Celsius.
6. A switch shall withstand, without breakdown, 1500 volts for 1 minute between live parts of opposite polarity and between live parts and dead metal parts, with the switch at the maximum operating temperature reached in intended use.

Explanation of "Horsepower" Ratings

Manual motor controllers marked with Horsepower Ratings are suitable for controlling the Motor Loads of the HP ratings shown on the manual motor controllers for that operating voltage as well as for lower HP ratings.

To qualify for an HP rating, a manual motor controllers is tested at (6) six times the full load Motor Current corresponding to the HP rating marked on the switch. (For DC Motor Controllers, the test is made at 10 times the full load Motor Current corresponding to the DC HP rating marked on the switch). The test consists of 50 on-off operations at this load and the test is conducted on (3) three samples. For $\frac{3}{4}$ HP 120 - 240 volts AC rating, (2) two sets of (3) three samples each are tested in addition to the regular overload, endurance, temp. rise and dielectric tests. The test circuit characteristics are:

	For $\frac{3}{4}$ HP 120V AC	For $\frac{3}{4}$ HP 240V AC
Closed Circuit Volts	120 volts AC	240 volts AC
Current	82.8 amps	41.4 amps
Power Factor	0.40-0.50	0.40-0.50

Note: Current at 240V AC is $\frac{1}{2}$ that at 120V AC

All manual motor controllers must be in good operating condition after the tests have been completed. There must be no excessive arcing, welding or burning of the contacts nor arc-over to the ground (the manual motor controller frames are grounded during the stalled rotor test).

General Technical Data

Wiring Device Standards and Testing

Wiring Device Standards

There are many different marketing terms in the electrical industry to describe the various electrical receptacles available from different manufacturers. Some of these terms include: Spec-Grade, Commercial, Heavy Duty, Industrial, Hard-Use, etc. There are no clear or universal definitions for these terms. There is no criteria established to differentiate one term from the next. Reliance solely upon these terms is not a reliable measure of performance or durability in a given application.

Underwriters Laboratories (UL) recognized a need to categorize receptacles based on application and expectations of performance. As a result, UL verifies performance to the following designations. Here are brief descriptions of each:



General Use - UL 498 – All duplex receptacles are required to meet these general requirements. Devices bearing the UL mark for general use have been tested to insure they can safely provide power in typical everyday usage (vacuum, lamps, electronics, etc.).



Fed. Spec.

Fed. Spec. - W-C-596 – The Federal Government wanted some way to determine that a receptacle performed better than average and would withstand the tougher demands of institutional use (post offices, military installations, prisons, etc.). Fed. Spec. listing identifies receptacles as having construction features, marking specifications and performance requirement (i.e., plug retention, increased cycle testing) beyond the requirements of the general use listing.



• Hospital Grade

Hospital Grade – In addition to compliance with general use requirements, Hospital Grade receptacles must meet performance criteria designed to test: ground reliability, assembly integrity, overall strength and reliability. Hospital Grade devices are marked with a green dot on their face.



Fed. Spec.

• Hospital Grade

Hospital Grade Fed. Spec. – Receptacles meeting this designation meet requirements and have completed test programs for both Fed. Spec. and Hospital Grade receptacles. All Hubbell Hospital Grade devices are UL listed to this designation.

These UL designations are a better determinant of performance than marketing descriptions, for performance and durability.

General Technical Data

Wiring Device Standards and Testing

Testing for Hospital Grade and Fed. Spec. Listing of Hubbell Receptacles, Plugs and Connectors

All Hubbell Hospital Grade products are tested quarterly in our factories with Underwriters Laboratories.

Receptacles

Fed. Spec. Test: Ground Pin Retention Test - The grounding contact of the receptacle is conditioned by twenty insertions with a 0.204 inch oversized diameter pin. After conditioning, a 0.184 inch diameter pin is inserted in the grounding contact must be capable of supporting a weight of at least 4 ounces for one minute.

Fed. Spec. Test: Power Blade Retention Test - A test plug with a single oversized blade measuring 0.075 inch thick is inserted into each current carrying contact for twenty conditioning cycles. When the conditioning cycles are completed, each contact must be capable of supporting, for one minute, 1.5 pounds secured to a single 0.055 inch thick solid steel blade without holes.

HG Test: Abrupt Removal of Plug Test - A steel bodied test plug with blades made of brass is inserted into the receptacle. A 10 pound weight dropped from at least 24 inches, pulls the plug out of the receptacle abruptly. This test is done eight times with the receptacle rotated in different positions to create the greatest stress to the face and contacts. Then, with the receptacle facing down, the grounding contact must retain a 4 ounce grounding pin with a 0.184 inch diameter for one minute. After this test there shall be no breakage of the receptacle that interferes with the receptacle function or to the integrity of the enclosure.

Fed. Spec. Test: Assembly Security Test - A force of 100 pounds is applied through the slots of the receptacle into the base while the bridge is supported at its screw mounting positions. Each receptacle is then examined for damage.

Plugs and Connectors

HG Test: Impact Test - A plug or connector wired with the minimum size flexible cord is subjected to an impact from a 10 pound cylindrical weight having a flat face with a 2 inch diameter dropped from a height of 18 inches. After the test, there shall be no breakage or other damage that may effect the function of the device.

HG Test: Mechanical Drop Test - The cord connector is wired to #18 AWG flexible cord and suspended horizontally. It is released so it impacts a hardwood surface 45 inches below the point of suspension. This is repeated for 1,300 cycles. After the test, there shall be no breakage, deformation or other effect that may interfere with the function of the device.

HG Test: 500 Pound Crush Test - A wired plug or connector is placed between two hardwood slabs while subjected to a force which is progressively increased to 500 pounds. After the test, there shall be no breakage, deformation or other effect that may interfere with the function of the device.

HG Test: Strain Relief Test - While assembled to a plug or connector but not wired to the terminals; the cord must remain securely fastened after a straight pull of 30 pounds and a rotary motion within 3 inch circles with a 10 pound force applied for two consecutive hours. Displacement of conductors, insulation and outer jacket of the flexible cord shall not exceed 0.031 inch. There shall be no cuts, rips or tears in the insulation of the cord.

General Technical Data

RoHS, WR, TR and LED Power Descriptions



RoHS - Restriction of Hazardous Substances

This EU Directive, 2002/95/EC, prohibits the use of mercury, cadmium, lead, chromium VI, PBB (polybrominated biphenyls) and PBDE (polybrominated diphenyl ethers) in certain electrical products. The regulatory maximums for these items are 0.01%, by weight, for cadmium and 0.1%, by weight, for the other five items in each "homogenous unit" contained within that product. There are certain exemptions available from the RoHS requirements.



Weather Resistant Receptacles

Per National Electrical Code (NEC®) Section 406.9; all 125 and 250 volt, 15 and 20 amp non-locking receptacles for use in damp or wet locations shall be a listed weather resistant type. Listed devices are required to have a WR marking on the face visible when installed.



Tamper-Resistant Receptacles

Per National Electrical Code (NEC®) Section 406.12 now addresses all 15 and 20 ampere, 125 and 250 volt nonlocking-type receptacles in the areas specified in 406.12(1) through (7) shall be listed tamper-resistant receptacles. New occupancies have been added to the receptacle tamper-resistant requirements: Dwelling units, guest rooms and guest suites of hotels and motels, child care facilities, preschools and elementary education facilities, business offices, corridors, waiting rooms and in clinics, medical and dental offices and outpatient facilities, places of waiting transportation, gymnasiums, skating rinks, auditoriums and dormitories.



LED Power Indicators

Most popularly used to identify emergency circuits in hospitals, the LED power indicators are bright enough to be visible in low light as well as bright daylight conditions.

Tamper-Resistant SG Series Duplex Receptacle, Hospital Grade. How the SG Tamper-Resistant Receptacle Works.

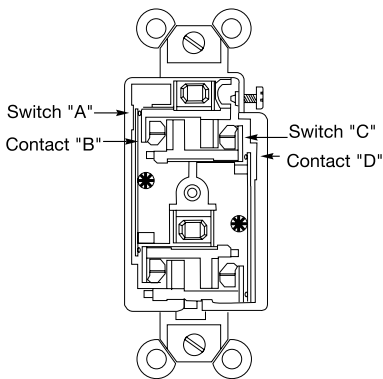

Figure 1

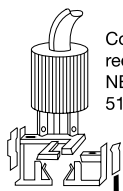

Figure 2

Complies with requirements of NEC Section 517-18(c).

As shown in Figure 1, Switch "A" energizes the left hand Contact "B" and Switch "C" energizes the right hand Contact "D". The same arrangement applies to the lower portion of the outlet.

If, for example, a metallic object is inserted into the left power Contact "B" only, the object is not energized because it requires the additional insertion of a similar object in the opposite Contact "D" to move the slider to close Switch "A".

Similarly, if an object is inserted into the right hand slot only, it cannot become energized unless an additional object is inserted in the opposite slot to close Switch "C".

In other words it requires the presence of an object in both right and left hand contacts to energize the device. This condition is in practice fulfilled only by the insertion of the proper electrical plug as shown in Figure 2.

Remember, this receptacle can be used with either a 2 or 3 wire plug. No other tamper-resistant receptacle on the market can provide you with greater reliability and durability than the Hubbell hospital grade tamper resistant receptacle.

Complies with requirements of NEC Section 517-18(c).

General Technical Data

NEMA and IEC Classifications

Comparison Between NEMA Enclosure Type Numbers and IEC Enclosure Classification Designations

IEC Publication 60529 Classification of Degrees of Protection Provided by Enclosures provides a system for specifying the enclosures of electrical equipment on the basis of the degree of protection provided by the enclosure. IEC 60529 does not specify degrees of protection against mechanical damage of equipment, risk of explosions, or conditions such as moisture (produced for example by condensation), corrosive vapors, fungus, or vermin. NEMA Standards Publication 250 does test for environmental condition such as corrosion, rust, icing, oil, and coolants. For this reason, and because the tests and evaluations for other characteristics are not identical, the IEC Enclosure Classification Designations cannot be exactly equated with NEMA Enclosure Type Numbers. The IEC designation consists of the letters IP followed by two numerals. The first characteristic numeral indicates the degree of protection provided by the enclosure with respect to persons and solid foreign objects entering the enclosure. The second characteristic numeral indicates the degree of protection provided by the enclosure with respect to the harmful ingress of water.

The table below provides an equivalent conversion from NEMA Enclosure Type Numbers to IEC Enclosure Classification Designations. The NEMA Types meet or exceed the test requirements for the associated IEC Classifications; for this reason the table cannot be used to convert from IEC Classifications to NEMA Types.

Conversion of NEMA Type Numbers to IEC Classification Designations

(Cannot be used to convert IEC classification designations to NEMA type numbers)

NEMA Enclosure Type Number	IEC Enclosure Classification Designation	Basic Description
1	IP10	General Purpose
2	IP11	Drip-proof - Indoor
3	IP54	Dust-tight, Raintight and Sleet (Ice) Resistant - Outdoor
3R	IP14	Rainproof and Sleet (Ice) Resistant - Outdoor
3S	IP44, IP54	Dust-tight, Raintight and Sleet (Ice) Proof - Outdoor
4	IP56	Watertight and Dust-tight - Indoor and Outdoor
4X	IP56	Watertight, Dust-tight and Corrosion-Resistant - Indoor and Outdoor
5	IP52	Superseded by Type 12 for Control Apparatus
6	IP67	Submersible, Watertight, Dust-tight and Sleet (Ice) Resistant - Indoor and Outdoor
12	IP52	Industrial Use, Dust-tight and Driptight - Indoor
12K	IP52	Industrial Use, Dust-tight and Driptight with Knockouts - Indoor
13	IP54	Oiltight and Dust-tight - Indoor

Elements of the IP Code and Their Meanings - In Accordance with Standard IEC 60529

IP Suitability Ratings are a system for classifying the degree of ingress protection provided by enclosures of electrical equipment. Generally, the higher the number, the greater the degree of protection; they apply ONLY to properly installed equipment.

Example: IP67 = Ingress Protection/Dust-Tight/Temporary Immersion

Meaning for the Protection of Equipment

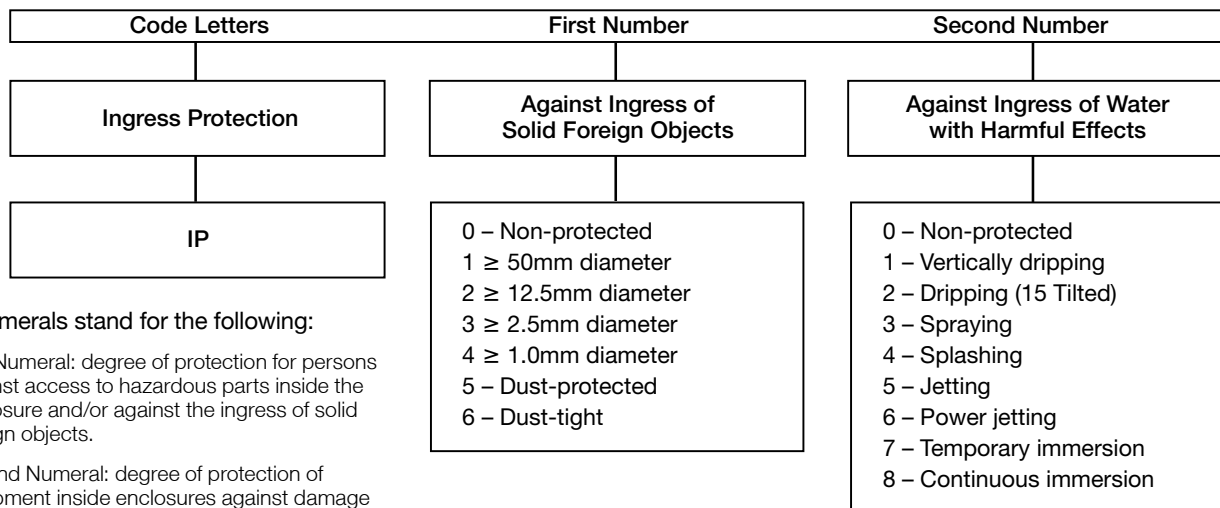

The numerals stand for the following:

1. First Numeral: degree of protection for persons against access to hazardous parts inside the enclosure and/or against the ingress of solid foreign objects.
2. Second Numeral: degree of protection of equipment inside enclosures against damage from the ingress of water.

General Technical Data

Enclosure Types for Self-Certified Non-Hazardous (Unclassified) Locations

	NEMA Standards Publication No. 250 Enclosures for Electrical Equipment (1000 Volts maximum)	UL50E Standard for Enclosures for Electrical Equipment Environmental Considerations	CAN/CSA C22.2 No. 94.2 Special Purpose Enclosures
Designation	Intended Use and Description	Intended Use and Description	Intended Use and Description
Definition	An enclosure is a surrounding case constructed to provide a degree of protection to personnel against incidental contact with the enclosed equipment and to provide a degree of protection to the enclosed equipment against specified environmental conditions.	Enclosure - A surrounding case constructed to provide a degree of protection against incidental contact with the enclosed equipment and to provide a degree of protection to the enclosed equipment against specified environmental conditions.	Enclosures...provide a degree of protection against accidental contact with the enclosed equipment, and to the enclosed equipment, against specified environmental conditions.
Type 1	Enclosures constructed for indoor use to provide a degree of protection to personnel against incidental contact with the enclosed equipment and to provide a degree of protection against falling dirt.	Indoor use primarily to provide a degree of protection against limited amounts of falling dirt.	No CSA equivalent.
Type 2	Enclosures constructed for indoor use to provide a degree of protection to personnel against incidental contact with the enclosed equipment, to provide a degree of protection against falling dirt, and to provide a degree of protection against dripping and light splashing of non-corrosive liquids.	Indoor use primarily to provide a degree of protection against limited amounts of falling water and dirt.	An enclosure for indoor use, constructed so as to provide a degree of protection against dripping and light splashing of non-corrosive liquids, and falling dirt.
Type 3	Enclosures constructed for either indoor or outdoor use to provide a degree of protection to personnel against incidental contact with the enclosed equipment; to provide a degree of protection against falling dirt, rain, sleet, snow, and windblown dust; and that will be undamaged by the external formation of ice on the enclosure.	Outdoor use primarily to provide a degree of protection against rain, sleet, windblown dust and damage from external ice formation.	An enclosure for either indoor or outdoor use, constructed so as to provide a degree of protection against rain, snow, and wind blown dust; undamaged by the external formation of ice on the enclosure.
Type 3X	Same as above and corrosion resistant.	Same as above and corrosion resistant.	Same as above and corrosion resistant.
Type 3R	Enclosures constructed for either indoor or outdoor use to provide a degree of protection to personnel against incidental contact with the enclosed equipment; to provide a degree of protection against falling dirt, rain, sleet, and snow; and that will be undamaged by the external formation of ice on the enclosure.	Outdoor use primarily to provide a degree of protection against rain, sleet, and damage from external ice formation.	An enclosure for either indoor or outdoor use, constructed so as to provide a degree of protection against rain and snow, undamaged by the external formation of ice on the enclosure.
Type 3RX	Same as above and corrosion resistant.	Same as above and corrosion resistant.	Same as above and corrosion resistant.
Type 3S	Enclosures constructed for either indoor or outdoor use to provide a degree of protection to personnel against incidental contact with the enclosed equipment; to provide a degree of protection against falling dirt, rain, sleet, snow, and windblown dust; and in which the external mechanism(s) remain operable when ice laden.	Outdoor use primarily to provide a degree of protection against rain, sleet, windblown dust, and to provide for operation of external mechanisms when ice laden.	An enclosure for either indoor or outdoor use, constructed so as to provide a degree of protection against rain, snow, and windblown dust, the external mechanism(s) remain operable while ice covered.
Type 3SX	Same as above and corrosion resistant.	Same as above and corrosion resistant.	Same as above and corrosion resistant.
Type 4	Enclosures constructed for either indoor or outdoor use to provide a degree of protection to personnel against incidental contact with the enclosed equipment; to provide a degree of protection against falling dirt, rain, sleet, snow, windblown dust, splashing water, and hose-directed water, and that will be undamaged by the external formation of ice on the enclosure.	Indoor or outdoor use primarily to provide a degree of protection against windblown dust and rain, splashing water, hose-directed water, and damage from external ice formation.	An enclosure for either indoor or outdoor use, constructed so as to provide a degree of protection against rain, snow, windblown dust, splashing and hose-directed water; undamaged by the external formation of ice on the enclosure.
Type 4X	Enclosures constructed for either indoor or outdoor use to provide a degree of protection to personnel against incidental contact with the enclosed equipment; to provide a degree of protection against falling dirt, rain, sleet, snow, windblown dust, splashing water, hose-directed water, and corrosion; and that will be undamaged by the external formation of ice on the enclosure.	Indoor or outdoor use primarily to provide a degree of protection against corrosion, windblown dust and rain, splashing water, hose-directed water and damage from external ice formation.	An enclosure for either indoor or outdoor use, constructed so as to provide a degree of protection against rain, snow, windblown dust, splashing and hose-directed water, undamaged by the external formation of ice on the enclosure; resists corrosion.

General Technical Data

Enclosure Types for Self-Certified Non-Hazardous (Unclassified) Locations

	NEMA Standards Publication No. 250 Enclosures for Electrical Equipment (1000 Volts maximum)	UL50E Standard for Enclosures for Electrical Equipment Environmental Considerations	CAN/CSA C22.2 No. 94.2 Special Purpose Enclosures
Designation	Intended Use and Description	Intended Use and Description	Intended Use and Description
Type 5	Enclosures constructed for indoor use to provide a degree of protection to personnel against incidental contact with the enclosed equipment; to provide a degree of protection against falling dirt; against settling airborne dust, lint, fibers, and flyings; and to provide a degree of protection against dripping and light splashing of liquids.	Indoor use primarily to provide a degree of protection against settling airborne dust, falling dirt, and dripping non-corrosive liquids.	An enclosure for indoor use, constructed so as to provide a degree of protection against dripping and light splashing of non-corrosive liquids and settling dust, lint, fibers, and flyings.
Type 6	Enclosures constructed for either indoor or outdoor use to provide a degree of protection to personnel against incidental contact with the enclosed equipment; to provide a degree of protection against falling dirt; against hose directed water and the entry of water during occasional temporary submersion at a limited depth; and that will be undamaged by the external formation of ice on the enclosure.	Indoor or outdoor use primarily to provide a degree of protection against hose-directed water, the entry of water during occasional temporary submersion at a limited depth, and damage from external ice formation.	An enclosure for either indoor or outdoor use, constructed so as to provide a degree of protection against the entry of water during occasional temporary submersion at a limited depth; undamaged by the external formation of ice on the enclosure.
Type 6P	Enclosures constructed for either indoor or outdoor use to provide a degree of protection to personnel against incidental contact with the enclosed equipment; to provide a degree of protection against falling dirt; against hose-directed water and the entry of water during prolonged submersion at a limited depth; and that will be undamaged by the external formation of ice on the enclosure.	Indoor or outdoor use primarily to provide a degree of protection against hose-directed water, the entry of water during prolonged submersion at a limited depth, and damage from external ice formation.	An enclosure for either indoor or outdoor use, constructed so as to provide a degree of protection against the entry of water during prolonged submersion at a limited depth; undamaged by the external formation of ice on the enclosure; resists extended corrosion.
Type 12	Enclosures constructed (without knockouts) for indoor use to provide a degree of protection to personnel against incidental contact with the enclosed equipment; to provide a degree of protection against falling dirt; against circulating dust, lint, fibers, and flyings; and against dripping and light splashing of liquids.	Indoor use primarily to provide a degree of protection against circulating dust, falling dirt, and dripping non-corrosive liquids.	An enclosure for indoor use, constructed so as to provide a degree of protection against circulating dust, lint fibers, and flyings; dripping and light splashing of non-corrosive liquids; and provided with knockouts.
Type 12K	Enclosures constructed (with knockouts) for indoor use to provide a degree of protection to personnel against incidental contact with the enclosed equipment; to provide a degree of protection against falling dirt; against circulating dust, lint, fibers, and flyings; and against dripping and light splashing of liquids.	Indoor use primarily to provide a degree of protection against circulating dust, falling dirt, and dripping non-corrosive liquids.	An enclosure for indoor use, constructed so as to provide a degree of protection against circulating dust, lint fibers, and flyings; dripping and light splashing of non-corrosive liquids; and provided with knockouts.
Type 13	Enclosures constructed for indoor use to provide a degree of protection to personnel against incidental contact with the enclosed equipment; to provide a degree of protection against falling dirt; against circulating dust, lint, fibers, and flyings; and against the spraying, splashing, and seepage of water, oil, and non-corrosive coolants.	Indoor use primarily to provide a degree of protection against dust, spraying of water, oil, and non-corrosive coolant.	An enclosure for indoor use, constructed so as to provide a degree of protection against circulating dust, lint, fibers, and flyings; seepage and spraying of non-corrosive liquids including oils and coolants.

General Technical Data

Circuit Wiring Diagrams

Wiring Diagrams for NEMA Configurations

(Configurations shown are for female devices)

125V – 2P, 2W

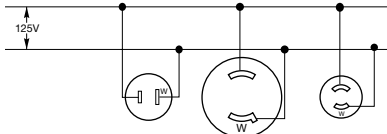

ANSI/NEMA WD-6 1-15R L1-15R ML1-R

250V – 2P, 2W

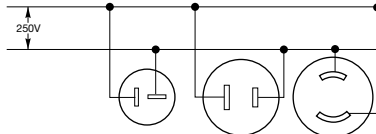

ANSI/NEMA WD-6 2-20R 2-30R L2-20R

208V AC Line-to-Line* – 2P, 2W

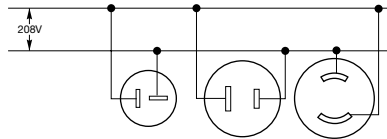

ANSI/NEMA WD-6 2-20R 2-30R L2-20R

125V – 2P, 3W – Grounding

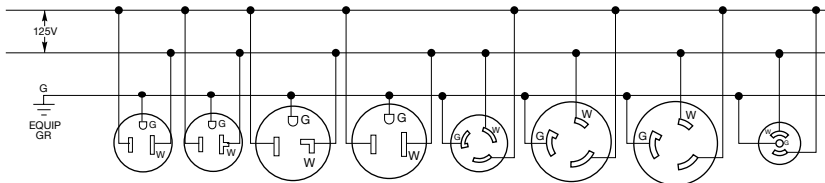

ANSI/NEMA WD-6 5-15R 5-20R 5-30R 5-50R L5-15R L5-20R L5-30R ML2-R

250V – 2P, 3W – Grounding

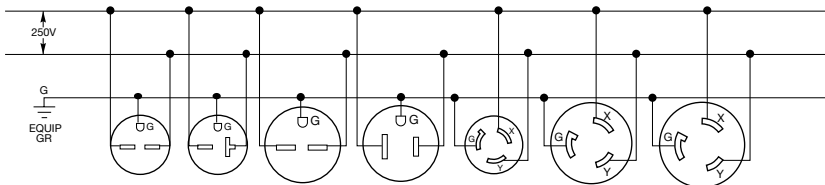

ANSI/NEMA WD-6 6-15R 6-20R 6-30R 6-50R L6-15R L6-20R L6-30R

208V AC Line-to-Line* – 2P, 3W – Grounding

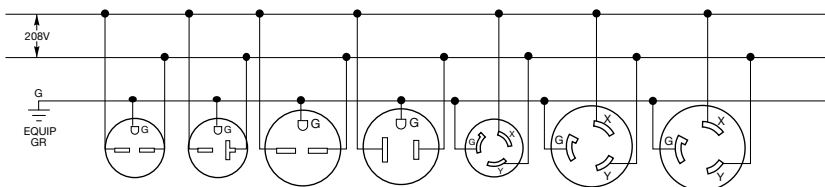

ANSI/NEMA WD-6 6-15R 6-20R 6-30R 6-50R L6-15R L6-20R L6-30R

Note: *Does NOT encompass 208V AC Line-to-Neutral.

The above diagrams are intended to show device terminal identification only.

General Technical Data

Circuit Wiring Diagrams

Wiring Diagrams for NEMA Configurations

(Configurations shown are for female devices)

277V AC – 2P, 3W – Grounding

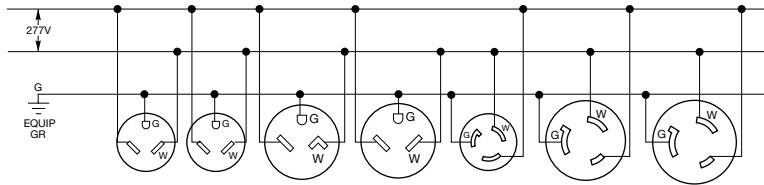

ANSI/NEMA WD-6 7-15R 7-20R 7-30R 7-50R L7-15R L7-20R L7-30R

347V AC – 2P, 3W – Grounding

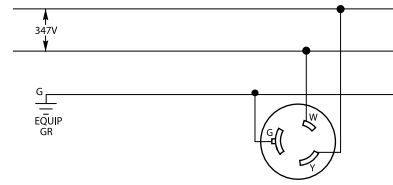

ANSINEMA WD-6 L24-20R

480V AC – 2P, 3W – Grounding

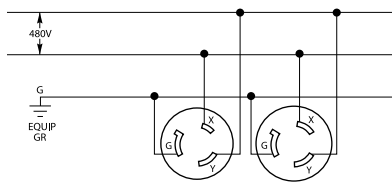

ANSINEMA WD-6 L8-20R L8-30R

600V AC – 2P, 3W – Grounding

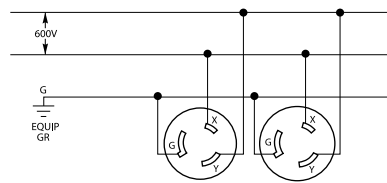

ANSINEMA WD-6 L9-20R L9-30R

125/250V – 3P, 3W

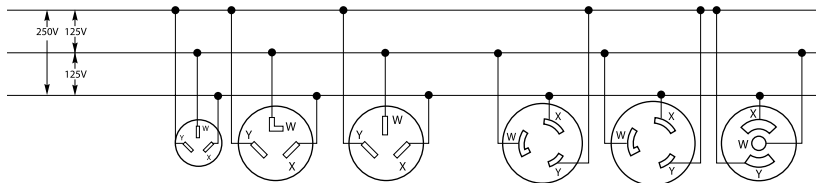

ANSI/NEMA WD-6 10-20R 10-30R 10-50R L10-20R L10-30R ML3-R

1Ø 120/208YV AC – 3P, 3W

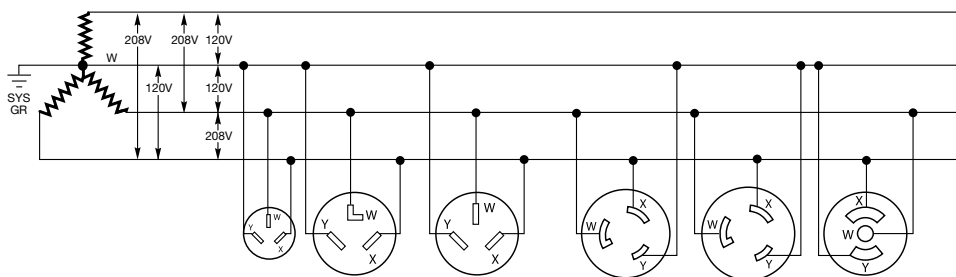

ANSI/NEMA WD-6 10-20R 10-30R 10-50R L10-20R L10-30R ML3-R

Note: The above diagrams are intended to show device terminal identification only.

General Technical Data

Circuit Wiring Diagrams

Wiring Diagrams for NEMA Configurations

(Configurations shown are for female devices)

3Ø 250V AC – 3P, 3W

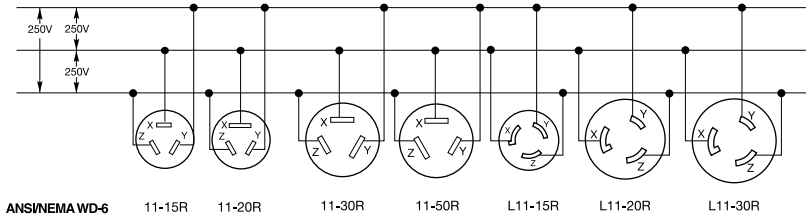

ANSI/NEMA WD-6 11-15R 11-20R 11-30R 11-50R L11-15R L11-20R L11-30R

3Ø 480V AC – 3P, 3W

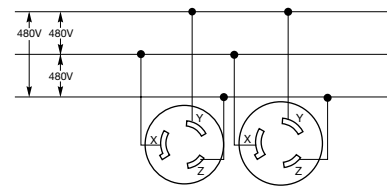

ANSI/NEMA WD-6 L12-20R L12-30R

3Ø 600V AC – 3P, 3W

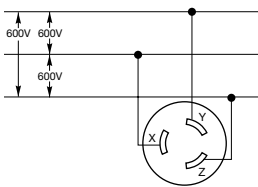

ANSI/NEMA WD-6 L13-30R

125/250V – 3P, 4W

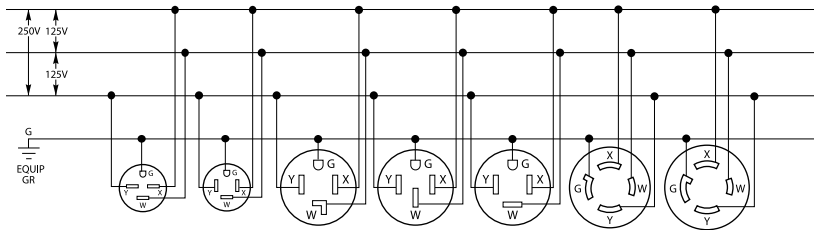

ANSI/NEMA WD-6 14-15R 14-20R 14-30R 14-50R 14-60R L14-20R L14-30R

1Ø 120/208YV AC – 3P, 4W – Grounding

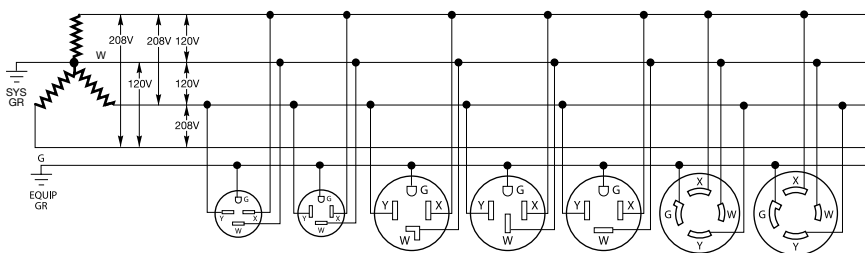

ANSI/NEMA WD-6 14-15R 14-20R 14-30R 14-50R 14-60R L14-20R L14-30R

Note: The above diagrams are intended to show device terminal identification only.

General Technical Data

Circuit Wiring Diagrams

Wiring Diagrams for NEMA Configurations

(Configurations shown are for female devices)

3Ø 250V – 3P, 4W – Grounding

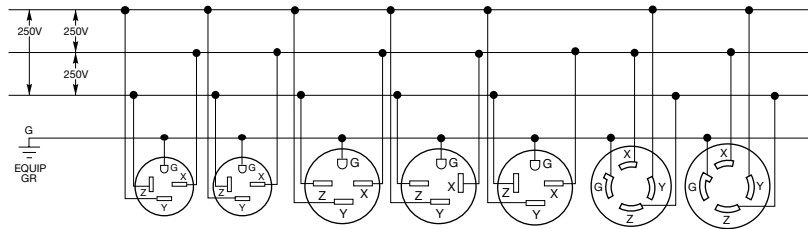

ANSI/NEMA WD-6 15-15R 15-20R 15-30R 15-50R 15-60R L15-20R L15-30R

3ØY 277/480V AC – 4P, 4W

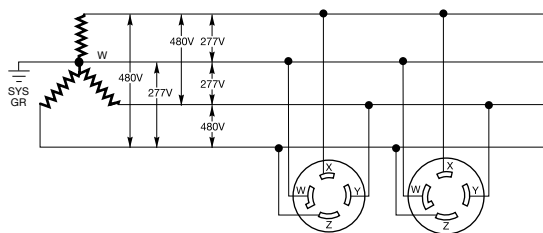

ANSI/NEMA WD-6 L19-20R L19-30R

3ØY 347/600V AC – 4P, 4W

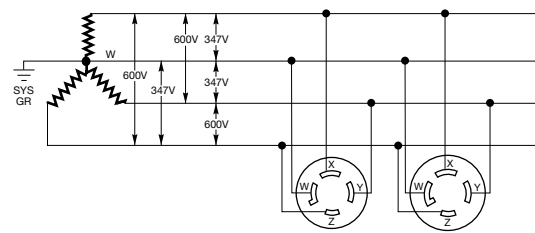

ANSI/NEMA WD-6 L20-20R L20-30R

3Ø 480V AC – 3P, 4W – Grounding

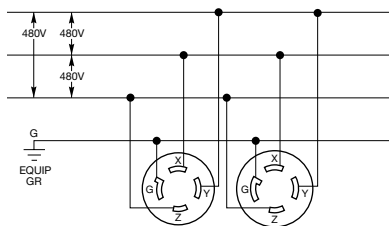

ANSI/NEMA WD-6 L16-20R L16-30R

3Ø 600V AC – 3P, 4W – Grounding

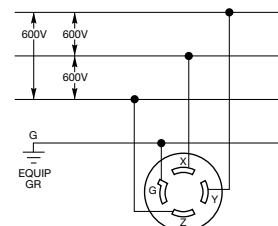

ANSI/NEMA WD-6 L17-30R

3ØY 120/208V AC – 4P, 4W

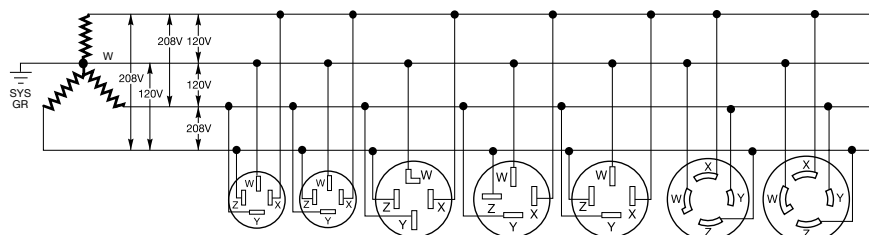

ANSI/NEMA WD-6 18-15R 18-20R 18-30R 18-50R 18-60R L18-20R L18-30R

Note: The above diagrams are intended to show device terminal identification only.

General Technical Data

Circuit Wiring Diagrams

Wiring Diagrams for NEMA Configurations

(Configurations shown are for female devices)

3ØY 120/208V AC – 4P, 5W – Grounding

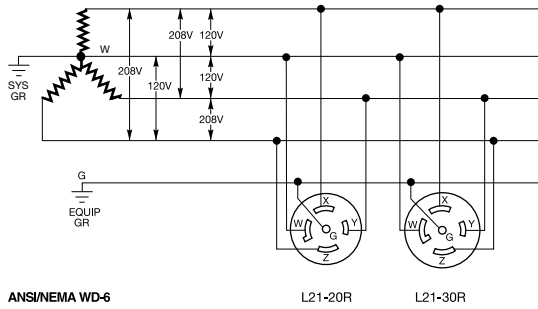

3ØY 277/480V AC – 4P, 5W – Grounding

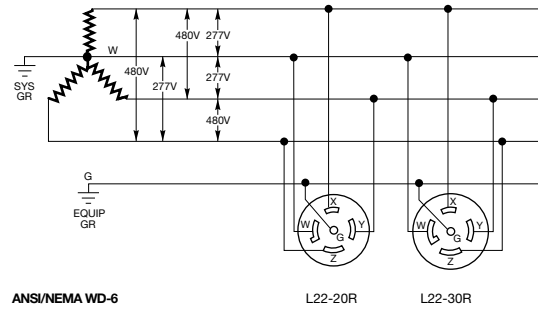

3ØY 347/600V AC – 4P, 5W – Grounding

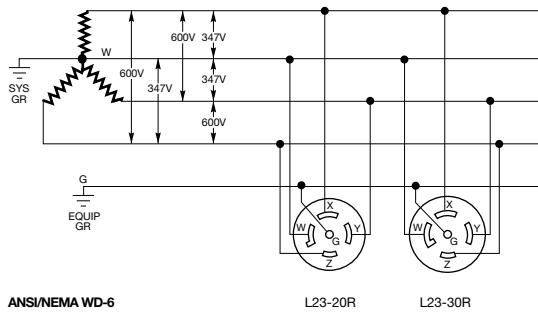

3ØY 220/380V AC – 4P, 5W – Grounding

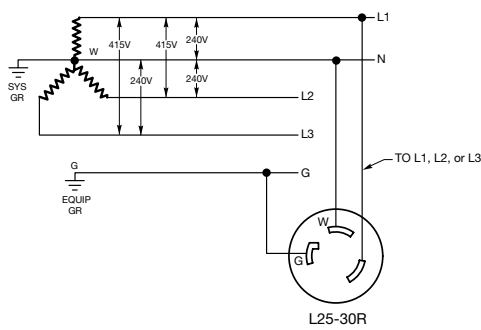

3ØY 240/415V AC – 4P, 5W – Grounding

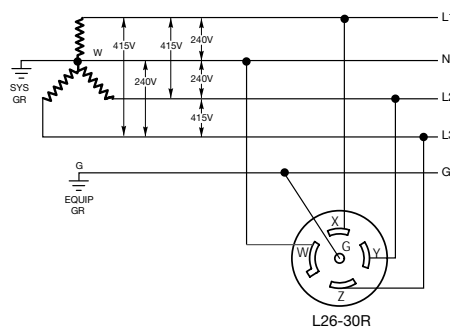

Note: The above diagrams are intended to show device terminal identification only.

General Technical Data

Horsepower Ratings and UL 508A Table SB4.1

Horsepower Ratings for NEMA Configurations – Plugs and Receptacles Only

Straight Blade				Locking			
NEMA Configuration	AC HP Rating ¹	NEMA Configuration	AC HP Rating ¹	NEMA Configuration	AC HP Rating ¹	NEMA Configuration	AC HP Rating ¹
1-15	0.5	11-15	2	L1-15	0.5	L11-15	2
2-15	1.5*	11-20	3	L2-20	2*	L11-20	3
2-20	2*	11-30	3	L5-15	0.5	L11-30	3
2-30	2*	11-50	7.5	L5-20	1		
5-15	0.5	14-15	1.5 L-L*	L5-30	2	L12-20	5
5-20	1		0.5 L-N	L6-15	1.5*	L12-30	10
5-30	2	14-20	2 L-L*	L6-20	2*	L14-20	2 L-L*
5-50	2		1 L-N	L6-30	2*	L14-30	1 L-N
6-15	1.5*	14-30	2 L-L*	L7-15	2		2 L-L*
6-20	2*		2 L-N	L7-20	2		2 L-N
6-30	2*	14-50	3 L-L*	L7-30	3	L15-20	3
6-50	3*		2 L-N			L15-30	3
7-15	2	14-60	3 L-L*	L8-20	3	L16-20	5
7-20	2		2 L-N	L8-30	5	L16-30	10
7-30	3					L18-20	2
7-50	5	15-15	2			L18-30	3
		15-20	3	L10-20	2 L-L*	L19-20	5
10-20	2 L-L*	15-30	3		1 L-N	L19-30	10
	1 L-N	15-50	7.5			L21-20	2
10-30	2 L-L*	15-60	10	L10-30	2 L-L*	L21-30	3
	2 L-N	18-15	2		2 L-N	L22-20	5
10-50	3 L-L*	18-20	2			L22-30	10
	2 L-N	18-30	3			L25-30	2
		18-50	7.5			L26-30	7.5
		18-60	7.5				

Note: ¹The phase to phase horsepower ratings are noted "L-L". The phase to neutral ratings are identified "L-N".
 *Also suitable for 208V Line-to-Line, not 208V Line-to-Neutral.

UL 231 Table 2.1, UL 508A Table SB4.1, UL 891 Table 16 - Assumed Maximum Short Circuit Current Rating for Unmarked Components When Used in UL 231 Power Outlets, UL 508A Industrial Control Panels, and UL 891 Switchboards

Component	Short Circuit Current Rating, kA
Bus bars	10
Circuit breaker (including GFCI type)	5
Current meters	a
Current shunt	10
Fuseholder	10
Industrial control equipment:	
a. Auxiliary devices (overload relay)	5
b. Switches (other than mercury tube type)	5
c. Mercury tube switches	
- Rated over 60 amperes or over 250 volts	5
- Rated 250 volts or less, 60 amperes or less, and over 2 kVA	3.5
- Rated 250 volts or less and 2 kVA or less	1
Motor controller, rated in horsepower (kW)	
a. 0 – 50 (0 – 37.3)	5c
b. 51 – 200 (38 – 149)	10c
c. 201 – 400 (150 – 298)	18c
d. 401 – 600 (299 – 447)	30c
e. 601 – 900 (448 – 671)	42c
f. 901 – 1500 (672 – 1193)	85c
Meter socket base	10
Miniature or miscellaneous fuse	10b
Receptacle (GFCI type)	2
Receptacle (other than GFCI type)	10
Supplementary protector	0.2
Switch unit	5
Terminal block or power distribution block	10

Note: a A short circuit current rating is not required when connected via a current transformer or current shunt.
 A directly connected current meter shall have a marked short circuit current rating.
 b The use of a miniature fuse is limited to 125-volt circuits.
 c Standard fault current rating for motor controller rated within specified horsepower range.

General Technical Data

Isolated Ground Story

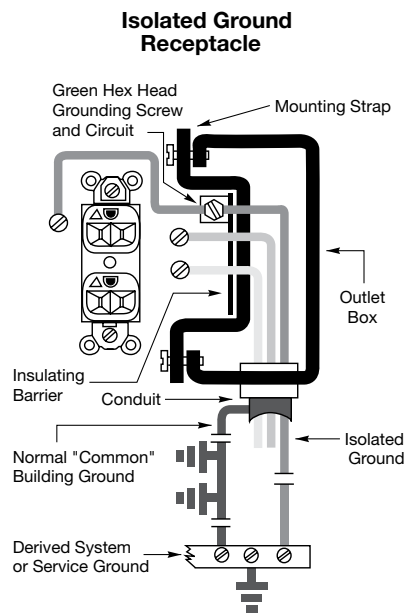
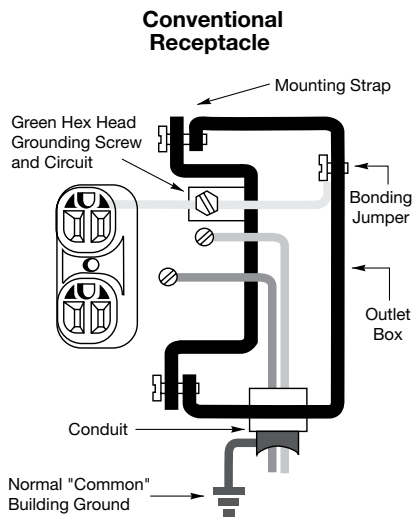

Hubbell Isolated Ground Receptacles

Why do you need an isolated ground device?

When mounting a conventional receptacle in a steel box, the ground is commonly established through the existing electrical system. This is done by using either the grounding clip on the receptacle's mounting strap, or by running a ground wire (which is part of the "normal" existing system) to the green grounding screw.

In a conventional receptacle the grounding contacts are connected to the mounting strap and the green grounding screw. Thus, even when a separate green wire is brought to the receptacle, it is still tied into the normal ground. This occurs since the mounting strap is in contact with the box grounding system, therefore, a "pure" isolated path to the ground is not established.

The Problem

The conventional grounding receptacle provides safety for personnel and equipment. However, the ground network also serves as a giant antenna and conductor of electrical noise. This electrical noise is electromagnetic interference and is caused by numerous transient ground currents. This can produce random transient electrical signals on the grounding system.

As a result, sensitive electronic equipment such as point of purchase terminals, accounting machines, computers and highly sensitive medical and communications equipment, can pick up these transient signals. This can interfere with the proper operation of the equipment.

The Solution

The isolated ground receptacle is similar to a conventional receptacle except for one important change. Insulating barrier construction, first patented by Hubbell, isolates the ground contacts from the mounting strap. The green grounding screw is connected directly to the grounding contacts. The isolated equipment grounding circuit is completed by running an isolated ground wire to the green grounding screw. This ground wire passes through intermediate panel boards without being connected to their grounding terminal and terminates directly at an equipment grounding conductor terminal of the derived system or service, in accordance with NEC® requirements.

The Result

This "isolated ground" can be kept relatively free of electrical noise. This is achieved since the grounding network has less branches, fewer sources of noise, and is connected to the ground at a single point.

NEC® is a registered trademark of the National Fire Protection Association (NFPA).

General Technical Data

Decimal Equivalents Table

Decimal Equivalents Table

Inches	Inches	Millimeters	Inches	Inches	Millimeters
$\frac{1}{64}$.015625	.3969	$\frac{33}{64}$.515625	13.0969
$\frac{1}{32}$.03125	.7938	$\frac{17}{32}$.53125	13.4938
$\frac{3}{64}$.046875	1.1906	$\frac{35}{64}$.546875	13.8906
$\frac{1}{16}$.0625	1.5875	$\frac{9}{16}$.5625	14.2875
$\frac{5}{64}$.078125	1.9844	$\frac{37}{64}$.578125	14.6844
$\frac{3}{32}$.09375	2.3813	$\frac{19}{32}$.59375	15.0813
$\frac{7}{64}$.109375	2.7781	$\frac{39}{64}$.609375	15.4781
$\frac{1}{8}$.1250	3.1750	$\frac{5}{8}$.6250	15.8750
$\frac{9}{64}$.140625	3.5719	$\frac{41}{64}$.640625	16.2719
$\frac{5}{32}$.15625	3.9688	$\frac{21}{32}$.65625	16.6688
$\frac{11}{64}$.171875	4.3656	$\frac{43}{64}$.671875	17.0656
$\frac{3}{16}$.1875	4.7625	$\frac{11}{16}$.6875	17.4625
$\frac{13}{64}$.203125	5.1594	$\frac{45}{64}$.703125	17.8594
$\frac{7}{32}$.21875	5.5563	$\frac{23}{32}$.71875	18.2563
$\frac{15}{64}$.234375	5.9531	$\frac{47}{64}$.734375	18.6531
$\frac{1}{4}$.2500	6.3500	$\frac{3}{4}$.7500	19.0500
$\frac{17}{64}$.265625	6.7469	$\frac{49}{64}$.765625	19.4469
$\frac{9}{32}$.28125	7.1438	$\frac{25}{32}$.78125	19.8438
$\frac{19}{64}$.296875	7.5406	$\frac{51}{64}$.796875	20.2406
$\frac{5}{16}$.3125	7.9375	$\frac{13}{16}$.8125	20.6375
$\frac{21}{64}$.328125	8.3344	$\frac{53}{64}$.828125	21.0344
$\frac{11}{32}$.34375	8.7313	$\frac{27}{32}$.84375	21.4313
$\frac{23}{64}$.359375	9.1281	$\frac{55}{64}$.859375	21.8281
$\frac{3}{8}$.3750	9.5250	$\frac{7}{8}$.8750	22.2250
$\frac{25}{64}$.390625	9.9219	$\frac{57}{64}$.890625	22.6219
$\frac{13}{32}$.40625	10.3188	$\frac{29}{32}$.90625	23.0188
$\frac{27}{64}$.421875	10.7156	$\frac{59}{64}$.921875	23.4156
$\frac{7}{16}$.4375	11.1125	$\frac{15}{16}$.9375	23.8125
$\frac{29}{64}$.453125	11.5094	$\frac{61}{64}$.953125	24.2094
$\frac{15}{32}$.46875	11.9063	$\frac{31}{32}$.96875	24.6063
$\frac{31}{64}$.484375	12.3031	$\frac{63}{64}$.984375	25.0031
$\frac{1}{2}$.5000	12.7000	1	1.0000	25.4000

General Technical Data

Electrical Symbols and Abbreviations

Electrical Symbols and Abbreviations

General Outlets

Ceiling Wall

○ - ○	Lighting Outlet
Ⓟ - Ⓟ	Blanked outlet
Ⓣ	Deep cord
ⓔ - ⓔ	Electrical outlet: for use only when circle used alone might be confused with columns, plumbing symbols, etc.
ⓕ - ⓕ	Fan outlet
Ⓝ - Ⓝ	Junction box
Ⓛ - Ⓛ	Lamp holder
Ⓛ _s - Ⓛ _s	Lamp holder with pull switch
Ⓢ - Ⓢ	Pull switch
Ⓥ - Ⓥ	Outlet for vapor discharge lamp
Ⓧ - Ⓧ	Exit light outlet
Ⓒ - Ⓒ	Clock outlet (specify voltage)

Convenience Outlets

Ⓧ	Duplex convenience outlet
Ⓧ ₃	Convenience outlet other than duplex 1-single, 3-triplex, etc.
Ⓧ _{wp}	Weatherproof convenience outlet
Ⓧ ₄	Range outlet
Ⓧ ₁	Switch and convenience outlet
Ⓧ _R	Radio and convenience outlet
Ⓧ _{sp}	Special purpose outlet (Des. in Spec.)
Ⓧ _f	Floor outlet

Switch Outlets

S	Single pole switch
S ₂	Double pole switch
S ₃	Three way switch
S ₄	Four way switch
S _D	Automatic door switch
S _E	Electroliner switch
S _K	Key operated switch
S _P	Switch and pilot lamp
S _{CB}	Circuit breaker switch
S _{WCB}	Weatherproof circuit breaker
S _{MC}	Momentary contact switch
S _{RC}	Remote control switch
S _{WP}	Weatherproof switch
S _F	Fused switch
S _{WF}	Weatherproof fused switch

Special Outlets

Any standard symbol as given above with the addition of a lower case subscript letter may be used to designate some special variation of standard equipment of particular interest in a specific set of architectural plans.

○ _{a,b,c,etc}	When used they must be listed in the Key of Symbols on each drawing and if necessary further described in the specifications.
Ⓧ _{a,b,c,etc}	

Panels, Circuits and Miscellaneous

■	Lighting panel
▨	Power panel
—	Branch circuit; concealed in ceiling or wall
- - -	Branch circuit; concealed in floor
.....	Branch circuit; exposed
→	Home run to panel board. Indicated number of circuits by number of arrows.

Note: Any circuit without further designation indicates a two-wire circuit.
 Note: For double or single systems eliminate one or two lines. This symbol is equally adaptable to auxiliary system layouts.
 For a greater number of wires indicate as follows: #/ (3 wires)
 ## (4 wires), etc.

Feeders

Note: Use heavy lines and designate by number of corresponding to listing in feeder schedule.

Ⓛ	Underfloor duct and junction box. Triple system
ⓐ	Generator
Ⓜ	Motor
Ⓡ	Instrument
Ⓣ	Power transformer (or draw to scale)
Ⓧ	Controller
Ⓛ	Isolating switch

Auxiliary Systems

■	Push Button	□	Buzzer
□	Bell	◇	Annunciator
◀	Outside telephone		
↔	Interconnecting telephone		
Ⓛ	Telephone switchboard		
Ⓡ	Bell ringing transformer		
Ⓛ	Electric door opener		
Ⓛ _P	Fire alarm bell	Ⓛ _F	Fire alarm station
Ⓛ	City fire alarm station		
Ⓛ _{FA}	Fire alarm central station		
Ⓛ _{FS}	Automatic fire alarm device		
Ⓛ _W	Watchman's station		
Ⓛ _{WJ}	Watchman's central station		
Ⓛ _H	Horn		
Ⓛ _N	Nurse's signal plug	Ⓛ _M	Maid's signal plug
Ⓛ _R	Radio outlet		
Ⓛ _{SC}	Signal central section		
□	Interconnection box		Battery
- - - - -	Auxiliary system circuits.		

Note: Any line without further designation indicates a 2-wire system. For a greater number of wires designate with numerals in manner similar to - - - 12-No. 18 W-3'4"C, or designate by number corresponding to listing in schedule.

Special auxiliary outlets

Subscript letters refer to notes on plans or detailed description in specifications.

General Technical Data

Diameter Ranges of Jacketed Cord and Wire Charts

Diameter Ranges of Jacketed Cord Chart - In Accordance with Standard UL62

Acceptable range in inches (mm) of the average overall diameter of round, jacketed heater cords and non-retractile vacuum cleaner and service cords.

Type of Cord	AWG Size	2 Conductor	3 Conductor	4 Conductor	5 Conductor
SV, SVE, SVEO, SVOO	18	.22"- .26" (5.6-6.6)	.23"- .27" (5.8-6.9)	—	—
SVO, SVT, SVTOO, SVTO	16	.25"- .28" (6.2-7.1)	.26"- .30" (6.6-7.5)	—	—
SJ, SJE, SJOO, SJO, SJEO, SJEOSJT, SJTO, SJTOO, SJEW, SJOOW, SJOW, SJEOW, SJEOW, SJTW, SJTOW, SJTOOW	18	.28"- .32" (7.1-8.1)	.30"- .34" (7.6-8.6)	.33"- .37" (8.4-9.4)	—
	16	.31"- .34" (7.9-8.6)	.33"- .36" (8.4-9.1)	.35"- .40" (8.9-10.2)	—
	14	.34"- .38" (8.6-9.7)	.36"- .40" (9.1-10.2)	.39"- .44" (9.9-11.2)	—
	12	.41"- .46" (10.4-11.7)	.43"- .48" (10.9-12.2)	.47"- .52" (11.9-13.2)	—
	10	.54"- .61" (13.7-15.5)	.57"- .64" (14.5-16.3)	.63"- .70" (16.0-17.8)	—
S, SE, SOO, SEO, SEOO, ST STOO, STO, SEW, SOOW, SOW, SEOW, SEOW, STW, STOOW, STOW	18	.34"- .39" (8.6-9.9)	.36"- .40" (9.1-10.2)	.39"- .43" (9.9-10.9)	.46"- .51" (11.7-13.0)
	16	.37"- .41" (9.4-10.4)	.39"- .43" (9.9-10.9)	.41"- .46" (10.4-11.7)	.49"- .55" (12.4-14.0)
	14	.50"- .55" (12.7-14.0)	.52"- .58" (13.2-14.7)	.56"- .62" (14.2-15.7)	.63"- .71" (16.0-18.0)
	12	.57"- .63" (14.5-16.0)	.59"- .66" (15.0-16.8)	.64"- .71" (16.3-18.0)	.70"- .77" (17.8-19.6)
	10	.62"- .69" (15.7-17.5)	.65"- .72" (16.5-18.3)	.70"- .78" (17.8-19.8)	.76"- .84" (19.3-21.3)
	8	.78"- .88" (19.8-22.4)	.83"- .93" (21.1-23.6)	.93"- 1.05" (23.6-26.7)	1.00"- 1.15" (25.4-29.2)
	6	.92"- 1.05" (23.4-26.7)	.97"- 1.10" (24.6-27.9)	1.05"- 1.20" (26.7-30.5)	1.18"- 1.33" (30.0-33.8)
	4	1.06"- 1.21" (26.9-30.7)	1.13"- 1.28" (28.7-32.5)	1.25"- 1.45" (31.8-36.8)	—
	2	1.21"- 1.40" (30.7-35.6)	1.30"- 1.50" (33.0-38.1)	1.45"- 1.65" (36.8-41.9)	—

Nominal Diameters of Round Portable Power Cable - In Accordance with Standard CSA-C22.2 No. 96

Type of Cord	AWG Size	2 Conductor	3 Conductor	4 Conductor	5 Conductor
W, G, G-GC, G-BGC, PPC	6	0.945" (24.0)	0.984" (25.0)	1.102" (28.0)	1.220" (31.0)
	4	1.063" (27.0)	1.142" (29.0)	1.260" (32.0)	1.417" (36.0)
	3	1.181" (30.0)	1.220" (31.0)	1.339" (34.0)	1.496" (38.0)
	2	1.260" (32.0)	1.339" (34.0)	1.496" (38.0)	1.614" (41.0)
	1	1.339" (34.0)	1.496" (38.0)	1.654" (42.0)	1.890" (48.0)
	1/0	1.417" (36.0)	1.614" (41.0)	1.772" (45.0)	1.929" (49.0)
	2/0	1.535" (39.0)	1.732" (44.0)	1.929" (49.0)	2.047" (52.0)
	3/0	1.654" (42.0)	1.890" (48.0)	2.047" (52.0)	2.244" (57.0)
	4/0	1.772" (45.0)	2.008" (51.0)	2.244" (57.0)	2.441" (62.0)

Wire Types Approximate Diameter in Inches (mm)*

Size (AWG or kcmil)	THHN, THWN, THWN-2 Inches (mm)	TW, THHW, THW, THW-2 Inches (mm)	XHHW, ZW, XHHW-2, XHH Inches (mm)
12	0.130 (3.302)	0.152 (3.861)	0.152 (3.861)
10	0.164 (4.166)	0.176 (4.470)	0.176 (4.470)
8	0.216 (5.486)	0.236 (5.994)	0.236 (5.994)
6	0.254 (6.452)	0.304 (7.722)	0.274 (6.960)
4	0.324 (8.230)	0.352 (8.941)	0.322 (8.179)
3	0.352 (8.941)	0.380 (9.652)	0.350 (8.890)
2	0.384 (9.754)	0.412 (10.46)	0.382 (9.703)
1	0.446 (11.23)	0.492 (12.50)	0.442 (11.23)
1/0	0.486 (12.34)	0.532 (13.51)	0.482 (12.34)
2/0	0.532 (13.51)	0.578 (14.68)	0.528 (13.41)
3/0	0.584 (14.83)	0.630 (16.00)	0.580 (14.73)
4/0	0.642 (16.31)	0.688 (17.48)	0.638 (16.21)
250	0.711 (18.06)	0.765 (19.43)	0.705 (17.91)
300	0.766 (19.46)	0.820 (20.83)	0.760 (19.30)
350	0.817 (20.75)	0.871 (22.12)	0.811 (20.60)
400	0.864 (21.95)	0.918 (23.32)	0.858 (21.79)
500	0.949 (24.10)	1.003 (25.48)	0.943 (23.95)
600	1.051 (26.70)	1.113 (28.27)	1.053 (26.75)
700	1.122 (28.50)	1.184 (30.07)	1.124 (28.55)
750	1.156 (29.36)	1.218 (30.94)	1.158 (29.41)
800	1.188 (30.18)	1.250 (31.75)	1.190 (30.23)
900	1.252 (31.80)	1.314 (33.38)	1.254 (31.85)
1000	1.310 (33.27)	1.372 (34.85)	1.312 (33.32)

Note: *Information Sourced from the National Electrical Code.

General Technical Data

IEC Pin and Sleeve Terminal Identification

IEC Pin and Sleeve Terminal Identification – Rear View

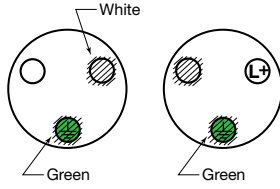
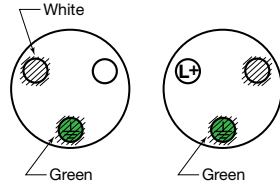
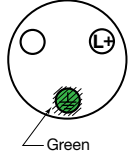
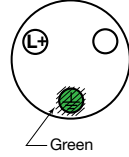
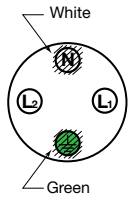
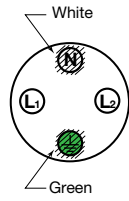
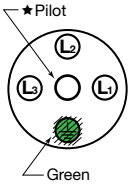
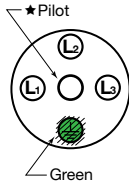
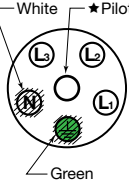
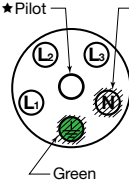
Description	Rating		Terminal Marking Pattern*			
	Domestic	International	Receptacle and Connector		Plug and Inlet	
			Domestic	International	Domestic	International
3 Wire	125V AC 277V AC	100-130V				
3 Wire	250V AC 480V AC 600V AC	200-250V 380-415V AC				
4 Wire	125/250V AC 1ØY 120/208V	—				
4 Wire	(3Ø Δ) 250V AC 480V AC 600V AC	380-415V AC				
5 Wire	(3ØY) 120/208V AC 277/480V AC 347/600V AC	220/380V 50Hz 250/440V 60Hz 200/346V to 240/415V 50 and 60Hz				

Note: *Location of grounding contact position will change as clock positions assigned to specific voltages change.

*Pilot contacts supplied on 4 and 5 wire, 63 and 125 Amp international rated devices.

General Technical Data

Horsepower Ratings

Horsepower Ratings for Hubbell IEC Pin and Sleeve Devices*

Single Phase

Amps	Wire Count	Voltage	Clock	Catalog Number	New HP Rating
20	3	125V	4	HBL320x4W	1
20	3	250V	6	HBL320x6W	2
20	3	480V	7	HBL320x7W	5
20	4	125/250 (208L-L)	12	HBL420x12W	2
20	4	125/250 (250L-L)	12	HBL420x12W	2
20	4	125/250 (125L-N)	12	HBL420x12W	1
30	3	125V	4	HBL330x4W	2
30	3	250V	6	HBL330x6W	3
30	3	480V	7	HBL330x7W	7.5
30	3	550VDC	8	HBL330X8	N/A
30	4	125/250 (208L-L)	12	HBL430x12W	3
30	4	125/250 (250L-L)	12	HBL430x12W	3
30	4	125/250 (125L-N)	12	HBL430x12W	2
60	3	125V	4	HBL360x4W	2
60	3	250V	6	HBL360x6W	3
60	3	480V	7	HBL360x7W	7.5
60	3	250VDC	3	HBL360x3W	N/A
60	3	550VDC	8	HBL360x8W	N/A
60	4	125/250 (208L-L)	12	HBL460x12W	3
60	4	125/250 (250L-L)	12	HBL460x12W	3
60	4	125/250 (125L-N)	12	HBL460x12W	2
100	3	125V	4	HBL3100x4W	5
100	3	250V	6	HBL3100x6W	15
100	3	480V	7	HBL3100x7W	30
100	3	250VDC	3	HBL3100x3W	N/A
100	3	550VDC	8	HBL3100x8W	N/A
100	4	125/250 (208L-L)	12	HBL4100x12W	10
100	4	125/250 (250L-L)	12	HBL4100x12W	15
100	4	125/250 (125L-N)	12	HBL4100x12W	5

3-Phase

Amps	Wire Count	Voltage	Clock	Catalog Number	Present HP Rating	New HP Rating
20	4	3Ø 250V	9	HBL420x9W	2	5
20	4	3Ø 480V	7	HBL420x7W	5	10
20	4	3Ø 600V	5	HBL420x5W	7.5	10
20	4	3Ø 380-415V	6	HBL420x6W	-	7.5
20	5	3ØY 120/208V	9	HBL520x9W	0.5	3
20	5	3ØY 277/480V	7	HBL520x7W	5	10
20	5	3ØY 347/600V	5	HBL520x5W	7.5	10
20	5	3Ø 240/415V	6	HBL520x6W	-	5
30	4	3Ø 250V	9	HBL430x9W	3	7.5
30	4	3Ø 480V	7	HBL430x7W	7.5	15
30	4	3Ø 600V	5	HBL430x5W	10	20
30	5	3ØY 120/208V	9	HBL530x9W	2	5
30	5	3ØY 277/480V	7	HBL530x7W	7.5	15
30	5	3ØY 347/600V	5	HBL530x5W	10	20
30	4	3Ø 380/415V	6	HBL430x6W	-	10
30	5	3Ø 200/346-240/415	6	HBL530x6W	-	10
60	4	3Ø 250V	9	HBL460x9W	5	7.5
60	4	3Ø 480V	7	HBL460x7W	10	20
60	4	3Ø 600V	5	HBL460x5W	15	25
60	4	3Ø 380-415VAC	6	HBL460x6W	-	10
60	5	3ØY 120/208V	9	HBL560x9W	3	7.5
60	5	3ØY 277/480V	7	HBL560x7W	10	20
60	5	3ØY 347/600V	5	HBL560x5W	15	25
60	5	3Ø 200/346-240/415	6	HBL560x6W	-	10
100	4	3Ø 250V	9	HBL4100x9W	10	15
100	4	3Ø 480V	7	HBL4100x7W	30	40
100	4	3Ø 600V	5	HBL4100x5W	30	50
100	4	3Ø 380-415V	6	HBL4100x6W	-	30
100	5	3ØY 200/346-240/415V	6	HBL5100x6W	-	30
100	5	400VDC	8	HBL5100x8W	-	N/A
100	5	3ØY 120/208V	9	HBL5100x9W	10	15
100	5	3ØY 277/480V	7	HBL5100x7W	30	40
100	5	3ØY 347/600V	5	HBL5100x5W	30	50

Note: *Horsepower Ratings are NOT standardized amongst different Pin and Sleeve manufacturers.

General Technical Data

Network Cabling Requirements

Supported Media - International

Designation	ANSI/TIA-568-C	ISO/IEC 11801 Amend 2: 2010	CENELEC EN-50173-1: 2002
Category 3 (16 MHz)	Supported	Supported: Class C	Supported: Class C
Category 5e (100 MHz)	Supported	Supported: Class D	Supported: Class D
Category 6 (250 MHz)	Supported	Supported: Class E	Supported: Class E
Category 6A (500 MHz)	Supported	Supported: Class EA	Supported: Class EA
Category 7 (600 MHz)	Not Recognized	Supported: Class F	Supported: Class F
Category 7A (1,000 MHz)	Not Recognized	Supported: Class FA*	Supported: Class FA*
Category 8 (2,000 MHz)	Not Recognized	Supported: Class FA*	Supported: Class FA*
50/125 - 62.5/125 Multimode	Supported	Supported	Supported
Singlemode Fiber	Supported	Supported	Supported
Singlemode Fiber to the Work Area	Not Supported	Supported	Supported
Work Area Outlet Configuration	4 Pairs T568A or B	4 Pairs T568A Only	4 Pairs T568A Only
Stranded Patch Cord Attenuation	120% of Horiz. Cable	150% of Horiz. Cable	150% of Horiz. Cable

Note: *Category 8 proposed in TIA 568-C.2-1 for 40 GBASE-T. ISO/IEC and cenelec to be determined. ISO/IEC and cenelec considering expanding Class FA frequency in addition to a considering new Class.

- Strip back only as much cable jacket as is required for termination and maintain pair twists as close as possible to the point of mechanical termination
- At a minimum, never allow untwisting of pairs as specified:
Category 5e and 6/6A: 0.5 inch max.

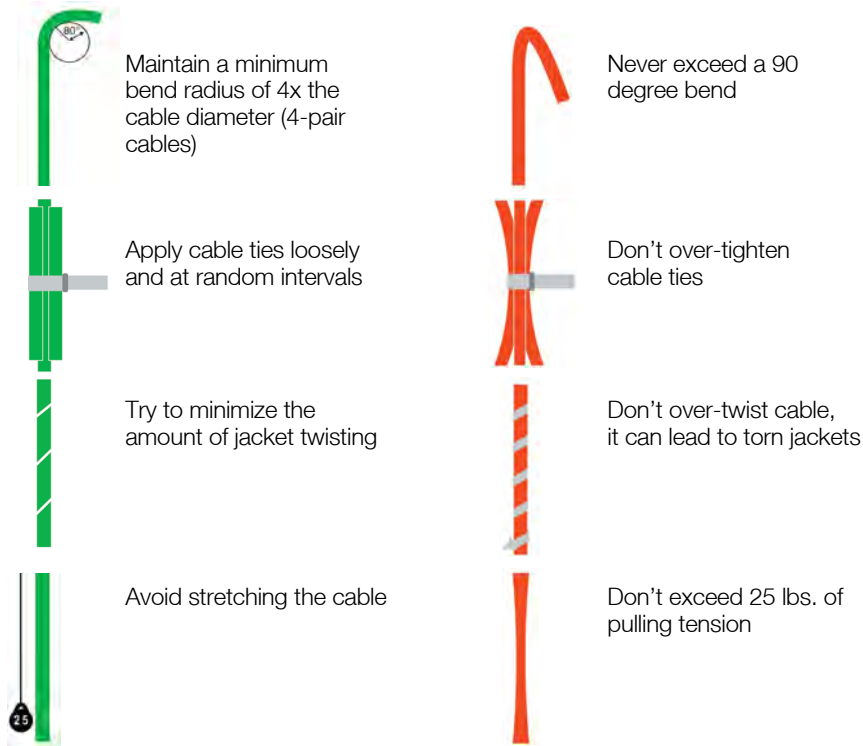

Use appropriate methods for dressing and securing cables:

- Cable ties
- Cable support bar
- Wire management panels
- Releasable straps

Don't use a staple gun to position cable

NEMA Straight Blade Devices

Rating		15 Ampere		20 Ampere		30 Ampere		50 Ampere		60 Ampere		
		Receptacle / Conn. Body	Plug / Inlet	Receptacle / Conn. Body	Plug / Inlet	Receptacle	Plug	Receptacle	Plug	Receptacle	Plug	
2 Pole / 2 Wire	125V	1	A-37 	A-37 								
	250V	2			A-37 	A-37 						
2 Pole / 3 Wire Grounding	125V	5	A-8 to A-10 A-12 to A-28 A-32 A-34 	A-35 to A-40 A-46 C-6 AA-35 A-32 A-40 AA-35 	A-8 to A-10 A-12 to A-28 A-32 A-34 	A-35 to A-40 A-46 C-6 AA-37 A-32 A-40 AA-37 	A-41 	A-41 	A-43 	A-43 		
	250V	6	A-9 A-11 A-23 A-32 A-36 C-6 	A-32 A-36 C-6 	A-9 A-11 A-23 A-32 A-36 C-6 	A-32 A-36 C-6 	A-41 	A-41 	A-43 	A-43 		
	277V AC	7	A-37 	A-37 			A-41 	A-41 	A-43 	A-43 		
3 Pole / 3 Wire	125/250V AC	10			A-38 	A-38 	A-41 	A-41 	A-43 	A-43 		
	3Ø 250V AC	11										
3 Pole / 4 Wire Grounding	125/250V AC	14			A-38 	A-38 	A-42 	A-42 	A-44 	A-44 	A-45 	A-45
	3Ø 250V AC	15										
4P / 4W	3ØY 120/208V AC	18										

HOW TO USE THIS CHART:

For quick reference, this chart shows the configuration, primary catalog section and page number where the devices are shown.

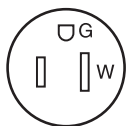

Open Slots indicates Receptacle / Connector Body configurations (female).



Closed Slots indicates Plug / Inlet configurations (male).

NEMA Configuration

A-3
A-7
A-16
C-6
AA-35

5-15R

Catalog Section and Page Number

IMPORTANT NOTICE:

The catalog pages referenced in **BLUE** are Insulgrip®, Valise®, Safety-Shroud® and Watertight Safety-Shroud® devices, in **RED** are Watertight devices, and in **ORANGE** are Marine corrosion resistant devices

	Rating Color Coded by Voltage	15 Ampere		20 Ampere		30 Ampere	
		Receptacle / Conn. Body	Plug / Inlet	Receptacle / Conn. Body	Plug / Inlet	Receptacle / Conn. Body	Plug / Inlet
2 Pole / 2 Wire	125V	L1 B-11 L1-15R	B-11 L1-15P				
	250V	L2		B-19 L2-20R	B-19 L2-20P		
2 Pole / 3 Wire Grounding	125V	L5 B-13 C-7 AA-34 L5-15R	B-12 C-7 AA-34 L5-15P	B-21 C-7 AA-36 L5-20R	B-20 C-7 AA-36 L5-20P	B-29 C-8 L5-30R	B-28 C-8 L5-30P
	250V	L6 B-13 C-7 L6-15R	B-12 C-7 L6-15P	B-21 C-7 L6-20R	B-20 C-7 L6-20P	B-29 C-8 L6-30R	B-28 C-8 L6-30P
	277V AC	L7 B-13 C-7 L7-15R	B-12 C-7 L7-15P	B-21 C-7 L7-20R	B-20 C-7 L7-20P	B-29 C-8 L7-30R	B-28 C-8 L7-30P
	480V AC	L8		B-24 L8-20R	B-24 L8-20P	B-37 L8-30R	B-37 L8-30P
	600V AC	L9		B-24 L9-20R	B-24 L9-20P	B-37 L9-30R	B-37 L9-30P
3 Pole / 3 Wire	125/250V AC	L10		B-24 L10-20R	B-24 L10-20P	B-31 L10-30R	B-30 L10-30P
	125/250V AC	L14		B-23 C-8 L14-20R	B-22 C-8 L14-20P	B-31 C-9 L14-30R	B-30 C-9 L14-30P
	3Ø 250V AC	L15		B-23 C-8 L15-20R	B-22 C-8 L15-20P	B-33 C-9 L15-30R	B-32 C-9 L15-30P
3 Pole / 4 Wire Grounding	3Ø 480V AC	L16		B-23 C-8 L16-20R	B-22 C-8 L16-20P	B-33 C-9 L16-30R	B-32 C-9 L16-30P
	3Ø 600V AC	L17				B-33 C-9 L17-30R	B-32 C-9 L17-30P
	3ØY 120/208V AC	L18		B-25 L18-20R	B-25 L18-20P	B-36 C-9 L18-30R	B-36 C-9 L18-30P
4 Pole / 4 Wire	3ØY 277/480V AC	L19		B-25 L19-20R	B-25 L19-20P	B-36 L19-30R	B-36 L19-30P
	3ØY 347/600V AC	L20		B-25 L20-20R	B-25 L20-20P	B-36 L20-30R	B-36 L20-30P
	3ØY 120/208V AC	L21		B-27 L21-20R	B-26 L21-20P	B-35 L21-30R	B-34 L21-30P
4 Pole / 5 Wire Grounding	3ØY 277/480V AC	L22		B-27 L22-20R	B-26 L22-20P	B-35 L22-30R	B-34 L22-30P
	3ØY 347/600V AC	L23		B-27 L23-20R	B-26 L23-20P	B-35 L23-30R	B-34 L23-30P
	347V AC	L24		B-24 L24-20R	B-24 L24-20P		
2P / 3W	240V AC	L25				B-37 L25-30R	B-37 L25-30P
	3ØY 240/415V AC	L26				B-35 L26-30R	B-34 L26-30P

MIDGET TWIST-LOCK® DEVICES		
Rating	Receptacle	Plug
2P / 2W 15A 125V	B-7 ML-1R	B-6 ML-1P
2P / 3W Gr 15A 125V	B-7 ML-2R	B-6 ML-2P
3P / 3W 15A 125/250V AC	B-7 ML-3R	B-6 ML-3P

50A TWIST-LOCK® DEVICES		
Rating	Receptacle	Plug
2 Pole / 3 Wire Grounding	50A 125V Corrosion Resistant ANSI C73-110 / NEMA SS1-50 Marine Products	AA-14 AA-15 AA-15
	50A 125V	B-56 B-56
	50A 250V	B-56 B-56
3 Pole / 4 Wire Grounding	50A 480V AC	B-56 B-56
	50A 125/250V Corrosion Resistant ANSI C73-111 / NEMA SS2-50 Marine Products	AA-16 AA-17 AA-17
	50A 125/250V AC	B-57 B-57
	50A 3Ø 250V AC	B-57 B-57
	50A 3Ø 480V AC	B-57 B-57

NON-NEMA TWIST-LOCK® DEVICES		
Rating	Receptacle	Plug
3 Pole / 3 Wire	20A 125/250V	B-45 C-8 C-8
	30A 125/250V	B-48 C-9 C-9
4 Pole / 4 Wire	20A 3ØY 120/208V AC	B-45 B-44
	30A 3ØY 120/208V AC	B-48 C-9 C-9
4P/5W Gr	20A 250V 10A 600V AC	B-46 B-46

Catalog Number Index

Catalog Number	Page	Catalog Number	Page	Catalog Number	Page	Catalog Number	Page
00322001LPK50	W-86, W-74	02201024	W-20	02203006	W-21	02211002	W-29
00322002LPK50	W-86, W-74	02201037	W-22	02203007	W-21	02211003	W-29
00322003LPK50	W-86, W-74	02201038	W-22	02203008	W-21	02211006	W-29
00322004LPK50	W-86, W-74	02201039	W-22	02203009	W-21	02211007	W-29
00322005LPK50	W-86, W-74	02201041	W-22	02203010	W-21	02211009	W-29
01301008	W-15	02201042	W-22	02203011	W-21	02211010	W-29
01301013	W-15	02201043	W-22	02203012	W-21	02211012	W-29
01304009	W-15	02201044	W-22	02203013	W-20	02211013	W-29
01304010	W-15	02201045	W-22	02203014	W-20	02211017	W-29
01304011	W-15	02201046	W-22	02203015	W-20	02211018	W-29
01304013	W-15	02201047	W-22	02203017	W-20	02211019	W-29
01304015	W-15	02201048	W-22	02203018	W-20	02211022	W-29
01304017	W-15	02201050	W-23	02203019	W-20	02211023	W-29
01304029	W-15	02201051	W-23	02203020	W-20	02211024	W-29
01304037	W-15	02201052	W-23	02203021	W-20	02211025	W-29
01304054	W-15	02201053	W-23	02203022	W-20	02211026	W-29
01304055	W-15	02201054	W-23	02203023	W-20	02211033	W-29
01304064	W-15	02201055	W-23	02203024	W-20	02211034	W-29
013041234	W-15	02201056	W-23	02203037	W-22	02211040	W-29
013041330	W-15	02201057	W-23	02203038	W-22	02211041	W-29
013041333	W-15	02201058	W-23	02203039	W-22	02211042	W-29
014021113	W-46	02202001	W-21	02203041	W-22	02211043	W-29
014021120	W-46	02202002	W-21	02203042	W-22	02211061	W-29
014021138	W-45	02202003	W-21	02203043	W-22	02211062	W-29
014021139	W-45	02202005	W-21	02203044	W-22	02211063	W-29
014021140	W-45	02202006	W-21	02203045	W-22	02211072	W-29
014021142	W-45	02202007	W-21	02203046	W-22	02211073	W-29
014021156	W-46	02202008	W-21	02203047	W-22	02211100	W-29
014021157	W-46	02202009	W-21	02203048	W-22	02211101	W-29
014021185	W-46	02202010	W-21	02203064	W-23	02211106	W-29
014021186	W-46	02202011	W-21	02203065	W-23	02211107	W-29
014021208	W-46	02202012	W-21	02203066	W-23	02212003	W-30
014021216	W-46	02202013	W-20	02203068	W-23	02212007	W-30
014021223	W-45	02202014	W-20	02203069	W-23	02212010	W-30
014021224	W-45	02202015	W-20	02203070	W-23	02212012	W-30
014021230	W-45	02202017	W-20	02203071	W-23	02212013	W-30
014021279	W-45	02202018	W-20	02203072	W-23	02212017	W-30
014021285	W-45	02202019	W-20, W-34	02203073	W-23	02212018	W-30
014021301	W-46	02202020	W-20	02203074	W-23	02212023	W-30
014021304	W-45	02202021	W-20	02206001	W-25	02212024	W-30
014021308	W-45	02202022	W-20	02206002	W-25	02212025	W-30
014021314	W-46	02202023	W-20	02206003	W-25	02212026	W-30
014021366	W-46	02202024	W-20	02206004	W-25	02212033	W-30
014021453	W-45	02202037	W-22	02206005	W-25	02212034	W-30
014021524	W-45	02202038	W-22	02206006	W-25	02212040	W-30
014021527	W-45	02202039	W-22	02206007	W-25	02212041	W-30
014021593	W-45	02202041	W-22	02206008	W-25	02212042	W-30
02201001	W-21	02202042	W-22	02206009	W-25	02212043	W-30
02201002	W-21	02202043	W-22	02206010	W-24	02212061	W-30
02201003	W-21	02202044	W-22	02206011	W-24	02212073	W-30
02201005	W-21	02202045	W-22	02206012	W-24	02213003	W-31
02201006	W-21	02202046	W-22	02206013	W-24	02213007	W-31
02201007	W-21	02202047	W-22	02207001	W-25	02213009	W-31
02201008	W-21	02202048	W-22	02207002	W-25	02213012	W-31
02201009	W-21	02202050	W-23	02207003	W-25	02213013	W-31
02201010	W-21	02202051	W-23	02207004	W-25	02213017	W-31
02201011	W-21	02202052	W-23	02207005	W-25	02213018	W-31
02201012	W-21	02202054	W-23	02207006	W-25	02213023	W-31
02201013	W-20	02202055	W-23	02207007	W-25	02213024	W-31
02201014	W-20	02202056	W-23	02207008	W-25	02213025	W-31
02201015	W-20	02202057	W-23	02207009	W-25	02213026	W-31
02201017	W-20	02202058	W-23	02207010	W-24	02213033	W-31
02201018	W-20	02202059	W-23	02207011	W-24	02213041	W-31
02201019	W-20	02202061	W-23	02207012	W-24	02213042	W-31
02201020	W-20	02203001	W-21	02207013	W-24	02216001	W-26
02201021	W-20	02203002	W-21	02208009	W-25	02216002	W-26
02201022	W-20	02203003	W-21	02209009	W-25	02216003	W-26
02201023	W-20	02203005	W-21	02211001	W-29	02216004	W-26

Catalog Number Index

Catalog Number	Page	Catalog Number	Page	Catalog Number	Page	Catalog Number	Page
02216005	W-26	022291021	W-42	02403010	W-21	02417005	W-26
02216006	W-26	022291022	W-42	02403011	W-21	02417006	W-26
02216007	W-26	02401001	W-21	02403013	W-20	02417007	W-26
02216008	W-26	02401002	W-21	02403014	W-20	02417008	W-26
02216009	W-26	02401003	W-21	02403015	W-20	02417009	W-26
02216010	W-26	02401005	W-21	02403017	W-20	02417012	W-26
02216011	W-26	02401006	W-21	02403018	W-20	02417013	W-26
02216012	W-26	02401007	W-21	02403019	W-20	02417014	W-26
02216013	W-26	02401008	W-21	02403020	W-20	02417015	W-26
02216014	W-26	02401009	W-21	02403021	W-20	02601001	W-24
02216015	W-26	02401010	W-21	02403022	W-20	02601002	W-24
02216016	W-27	02401011	W-21	02403023	W-20	02601003	W-24
02216017	W-27	02401012	W-21	02403037	W-22	02601004	W-24
02216018	W-27	02401013	W-20	02403038	W-22	02601005	W-24
02216019	W-27	02401014	W-20	02403039	W-22	02601006	W-24
02216020	W-27	02401015	W-20	02403041	W-22	03301001	W-9
02216021	W-27	02401017	W-20	02403042	W-22	03301002	W-9
02216022	W-27	02401018	W-20	02403043	W-22	03301011	W-9
02216023	W-27	02401019	W-20	02403044	W-22	03301012	W-9
02216024	W-27	02401020	W-20	02403045	W-22	03301013	W-9
02216025	W-27	02401021	W-20	02403047	W-22	03301014	W-9
02216026	W-27	02401022	W-20	02403065	W-23	03301016	W-9
02216027	W-27	02401023	W-20	02403066	W-23	03301017	W-9
02216028	W-27	02401037	W-22	02403068	W-23	03301018	W-9
02216029	W-27	02401038	W-22	02403069	W-23	03301019	W-9
02216030	W-27	02401039	W-22	02403070	W-23	03301020	W-9
02217001	W-26	02401041	W-22	02406001	W-25	03301021	W-9
02217002	W-26	02401042	W-22	02406002	W-25	03301024	W-9
02217003	W-26	02401043	W-22	02406003	W-25	03301025	W-9
02217004	W-26	02401044	W-22	02406004	W-25	03301026	W-9
02217005	W-26	02401045	W-22	02406005	W-25	03301027	W-9, W-34
02217006	W-26	02401051	W-23	02406006	W-25	03301028	W-9
02217007	W-26	02401052	W-23	02406007	W-25	03301029	W-9
02217008	W-26	02401053	W-23	02406010	W-24	03301030	W-9
02217009	W-26	02401054	W-23	02406011	W-24	03301031	W-9
02217010	W-26	02401055	W-23	02406012	W-24	03301039	W-9
02217011	W-26	02402002	W-21	02406013	W-24	03301045	W-9
02217012	W-26	02402003	W-21	02407001	W-25	03301047	W-9
02217013	W-26	02402005	W-21	02407002	W-25	033011017	W-9
02217014	W-26	02402006	W-21	02407003	W-25	03302016	W-8
02217015	W-26	02402007	W-21	02407004	W-25	03302018	W-8
02217016	W-27	02402008	W-21	02407005	W-25	03302020	W-8
02217017	W-27	02402009	W-21	02407006	W-25	03302022	W-8
02217018	W-27	02402013	W-20	02407007	W-25	03302024	W-8
02217019	W-27	02402014	W-20	02407008	W-25	03302026	W-8
02217020	W-27	02402015	W-20	02407009	W-25	03302028	W-8
02217021	W-27	02402017	W-20	02407010	W-24	03302044	W-8
02217022	W-27	02402018	W-20	02407011	W-24	03302046	W-8
02217023	W-27	02402019	W-20	02407012	W-24	03302048	W-8
02217024	W-27	02402020	W-20	02407013	W-24	03302050	W-8
02217025	W-27	02402021	W-20	02416001	W-26	03302052	W-8
02217026	W-27	02402022	W-20	02416002	W-26	03302054	W-8
02217027	W-27	02402023	W-20	02416003	W-26	03302056	W-8
02217028	W-27	02402024	W-20	02416004	W-26	03302066	W-8
02217029	W-27	02402038	W-22	02416005	W-26	03302097	W-8
02217030	W-27	02402042	W-22	02416006	W-26	033021030	W-8
022291000	W-42	02402044	W-22	02416007	W-26	033021031	W-8
022291001	W-42	02402045	W-22	02416008	W-26	033021078	W-8
022291002	W-42	02402046	W-22	02416009	W-26	033021079	W-8
022291003	W-42	02402047	W-22	02416010	W-26	033021080	W-8
022291004	W-42, W-44	02402051	W-23	02416011	W-26	033021081	W-8
022291005	W-42	02403002	W-21	02416013	W-26	03303001	W-13
022291006	W-42	02403003	W-21	02416014	W-26	03303002	W-13
022291016	W-42	02403005	W-21	02416015	W-26	03303003	W-13
022291017	W-42	02403006	W-21	02417001	W-26	03303004	W-13
022291018	W-42	02403007	W-21	02417002	W-26	03303005	W-13
022291019	W-42	02403008	W-21	02417003	W-26	03303006	W-13
022291020	W-42	02403009	W-21	02417004	W-26	03303007	W-13

Catalog Number Index

Catalog Number	Page	Catalog Number	Page	Catalog Number	Page	Catalog Number	Page
03303008	W-13	033271039	W-7	07401001	W-49	074011178	W-49
03303010	W-13	033271040	W-7	07401002	W-49	074011186	W-49
03303011	W-13	033271041	W-7	07401003	W-49	074011187	W-49
03303012	W-13	033271042	W-7	07401004	W-49	074011188	W-49
03303013	W-13	033291000	W-40	07401006	W-49	074011189	W-49
03303015	W-13	033291001	W-40	07401008	W-49	074011195	W-49
03303016	W-13	033291002	W-40	07401010	W-49	074011199	W-50
03303017	W-13	033291003	W-40	07401011	W-49	074011229	W-50
03303018	W-13	033291004	W-40	07401013	W-49	074011230	W-50
03303019	W-13	033291005	W-40	07401015	W-49	074011233	W-50
03303029	W-13	033291008	W-40	07401017	W-49	074011234	W-50
033041082	W-10	033291009	W-40	07401018	W-49	074011236	W-50
033041083	W-10	033291010	W-40	07401019	W-49	074011237	W-50
033041084	W-10	033291011	W-40	07401021	W-49	074011239	W-50
033041085	W-10	033291012	W-40	07401023	W-49, F-30	074011244	W-50
033041086	W-10	033291015	W-41	07401025	W-49, F-30	074011245	W-50
033041087	W-10	033291016	W-41	07401026	W-49	074011246	W-50
033041088	W-10	033291017	W-41	07401027	W-49	074011247	W-49
033041089	W-10	033291018	W-41	07401028	W-49	074011248	W-49
033041090	W-10	033291193	W-41	07401029	W-49	074011249	W-49
033041091	W-10	033291194	W-41	07401030	W-49	074011250	W-49
033041092	W-10	033291195	W-41	07401031	W-49	074011251	W-49
033041093	W-10	033291196	W-44, W-41	07401032	W-49	074011252	W-49
033041094	W-10	033291197	W-41	07401033	W-49	074011253	W-49
033041095	W-10	033291198	W-41	07401034	W-49	074011254	W-49
033041096	W-10	033291199	W-41	07401035	W-49	074011255	W-49
033041097	W-10	03628001	W-11	07401043	W-50	074011256	W-49
03305001	W-13	03628002	W-11	07401045	W-50	074011257	W-49
03305002	W-13	03628003	W-11	07401052	W-50	074011258	W-49
03305003	W-13	03628004	W-11	07401053	W-50	074011259	W-49
03305004	W-13	03628005	W-11	07401071	W-50	074011260	W-49
03305005	W-13	03628006	W-11	07401072	W-50	074011261	W-49
03305006	W-13	073031200	W-54	07401073	W-50	074011262	W-49
03305011	W-13	073031201	W-54	07401074	W-50	074011263	W-49
033051114	W-13	073031202	W-54	07401076	W-50	074011264	W-49
03308003	W-12	073031203A	W-54	07401078	W-50	074011265	W-49
03308004	W-12	073031204	W-54	07401080	W-50	074011266	W-49
03308005	W-12	073031205	W-54	07401081	W-50	074011275	W-50
03308006	W-12	073031206	W-54	07401083	W-50	074011331	W-51
03308007	W-12	073031207	W-54	07401084	W-50	074011332	W-51
03308008	W-12	073031208	W-54	07401085	W-50	074011333	W-51
03308009	W-12	073031209A	W-54	07401087	W-50	074011334	W-51
03308010	W-12	073031210	W-54	07401089	W-50	074011335	H-15, W-51, C-12
03308011	W-12	073031211	W-54	07401091	W-50	074011336	H-15, W-51, C-12
03310001	W-12	073031212	W-54	074011021	W-50	074011337	H-15, W-51, C-12
03310002	W-12	073031213	W-54	074011028	W-49	074011338	W-51
03310003	W-12	073031214	W-54	074011029	W-49	074011341	W-51, C-11
03310004	W-12	073031215	W-54	074011030	W-49	074011342	W-51, C-11
03310005	W-12	073041276	W-28	074011031	W-49	074011343	W-51, C-11
03310006	W-12	073041277	W-28	074011032	W-49	074011344	W-51
03310007	W-12	073041278	W-28	074011033	W-49	074011346	W-51
03310008	W-12	073041279	W-28	074011034	W-49	074011347	W-51
03310009	W-12	073041280	W-28	074011036	W-49	074011348	W-51
03310010	W-12	073041281	W-28	074011037	W-49	074011349	W-51
03310011	W-12	073041282	W-28	074011038	W-49	074011350	W-51
03316001	W-14	073041284	W-28	074011039	W-49	074011351	W-51
03316002	W-14	073041285	W-28	074011042	W-50	07401137	W-50
03316003	W-14	073041286	W-28	074011043	W-50	07406079	W-58
03316004	W-14	073041287	W-28	074011045	W-50	07406080	W-58
03316006	W-14	073041288	W-28	074011046	W-50	07406081	W-58
03317001	W-14	073041289	W-28	074011047	W-50	07406082	W-58
03317002	W-14	07310001	W-55	074011049	W-50	07406083	W-58
03317003	W-14	07310002	W-55	074011051	W-50	074093401	W-66, W-57
03317004	W-14	07310003	W-55	074011055	W-50	074093402	W-57, W-66, G-29, G-42
03317005	W-14	07310004	W-55	074011057	W-50	074093403	W-57, W-66, G-29, G-42
03317006	W-14	07310005	W-55	074011059	W-50	074093404	W-57, W-66, G-29, G-42
033271037	W-7	07310006	W-55	074011060	W-50	074093405	W-57, W-66, G-29, G-42
033271038	W-7	073PG291204	W-54	07401108	W-50	074093406	W-57, W-66, G-29, G-42

Catalog Number Index

Catalog Number	Page	Catalog Number	Page	Catalog Number	Page	Catalog Number	Page
074093408	W-66, W-57	091041007	W-56	1222W	D-6	2172LA	A-27, L-9
074093410	W-57	091041008	W-56	1223B	D-6	2172LAL	A-27, L-9
074093412	W-57	091041009	W-56	1223BK	D-6	2172LALTRA	A-27, L-9
074093421	W-66, W-57	091041010	W-56	1223GY	D-6	2172LATRA	A-27, L-9
074093422	W-66, W-57	091041011	W-56	1223I	D-6	2172LTRA	A-27, L-9
074093423	W-66, W-57	091041012	W-56	1223LA	D-6	2172RED	A-27, L-9
074093424	W-66, W-57	091041013	W-56	1223PWB	D-6	2172REDL	A-27, L-9
074093425	W-66, W-57	091041014	W-56	1223PWBK	D-6	2172REDLTRA	A-27, L-9
074093426	W-66, W-57	091041015	W-56	1223PWGY	D-6	2172REDTRA	A-27, L-9
074093428	W-66, W-57	091041016	W-56	1223PWI	D-6	2172TRA	A-27, L-9
074093441	W-66	091041017	W-56	1223PWLA	D-6	2172W	A-27, L-9
074093442	W-66	091041019	W-56	1223PWR	D-6	2172WL	A-27, L-9
074093443	W-66	091061043	W-7	1223PWW	D-6	2172WLTRA	A-27, L-9
074093444	W-66	091061044	W-7	1223R	D-6	2172WTRA	A-27, L-9
074093445	W-66	091061045	W-7	1223W	D-6	2182	A-27, L-9
074093446	W-66	091061046	W-7	1224B	D-6	2182BK	A-27, L-9
074093448	W-66	091061047	W-7	1224BK	D-6	2182BKL	A-27, L-9
074093511	W-66, W-57	091061048	W-7	1224GY	D-6	2182BKLTRA	A-27, L-9
074093512	W-66, W-57	102	T-14, T-13	1224I	D-6	2182BKTRA	A-27, L-9
074093513	W-66, W-57	10GAFBCVRALU	O-51	1224LA	D-6	2182GY	A-27, L-9
074093514	W-66, W-57	10GAFBCVRALUC	O-51	1224PWB	D-6	2182GYL	A-27, L-9
074093515	W-66, W-57	10GAFBCVRBK	O-51	1224PWBK	D-6	2182GYLTRA	A-27, L-9
074093516	W-66, W-57	10GAFBCVRBKC	O-51	1224PWGY	D-6	2182GYTRA	A-27, L-9
074093518	W-66, W-57	10GAFBCVRBRS	O-51	1224PWI	D-6	2182IV	A-27, L-9
074093520	W-66, W-57	10GAFBCVRBRSC	O-51	1224PWLA	D-6	2182IVL	A-27, L-9
074093522	W-66, W-57	10GAFBCVRBRZ	O-51	1224PWR	D-6	2182IVLTRA	A-61, A-27, L-9
074093526	W-66, W-57	10GAFBCVRBRZC	O-51	1224PWW	D-6	2182IVTRA	A-27, L-9
074093541	W-66, W-57	10GAFBCVRNK	O-51	1224R	D-6	2182L	A-27, L-9
074093542	W-66, W-57	10GAFBCVRNKC	O-51	1224W	D-6	2182LA	A-27, L-9
074093543	W-66, W-57	1201B	D-6	14S10	Y-14	2182LAL	A-27, L-9
074093544	W-66, W-57	1201BK	D-6	15GC10	Y-6	2182LALTRA	A-27, L-9
074093545	W-66, W-57	1201GY	D-6	15ST10	Y-6	2182LATRA	A-27, L-9
074093546	W-66, W-57	1201I	D-6	20302001	W-28	2182LTRA	A-27, L-9
074093548	W-66, W-57	1201LA	D-6	20302002	W-28	2182RED	A-27, L-9
074093550	W-66, W-57	1201W	D-6	20308001A	W-16	2182REDL	A-27, L-9
074093552	W-66, W-57	1203B	D-6	20308002A	W-16	2182REDLTRA	A-27, L-9
074093556	W-66, W-58	1203BK	D-6	20308003A	W-16	2182REDTRA	A-27, L-9
074093562	W-66, W-58	1203GY	D-6	20308004A	W-16	2182TRA	A-27, L-9
074093563	W-66, W-58	1203I	D-6	20308005A	W-16	2182W	A-27, L-9
074093564	W-66, W-58	1203LA	D-6	20320047	W-16	2182WL	A-27, L-9
074093565	W-66, W-58	1203W	D-6	20320048	W-16	2182WLTRA	A-27, L-9
074093566	W-66, W-58	1221B	D-6	20320050	W-16	2182WTRA	A-27, L-9
074093568	W-66, W-58	1221BK	D-6	20320051	W-16	24GCCVRALU	O-7, O-6, O-8
074M20010	W-53	1221GY	D-6	20320052	W-16	24GCCVRALUC	O-7, O-6, O-8
074M25017	W-53	1221I	D-6	20320053	W-16	24GCCVRBK	O-7, O-6, O-8
074M251247	W-53	1221LA	D-6	20320054	W-16	24GCCVRBKC	O-7, O-6, O-8
074M251248	W-53	1221PWB	D-6	20509001	W-86, W-74	24GCCVRBRS	O-7, O-6, O-8
074M32021	W-53	1221PWBK	D-6	20509002	W-86, W-74	24GCCVRBRSC	O-7, O-6, O-8
074M32023	W-53	1221PWGY	D-6	20509003	W-86, W-74	24GCCVRBRZ	O-7, O-6, O-8
074M32025	W-53	1221PWI	D-6	20509004	W-86, W-74	24GCCVRBRZC	O-7, O-6, O-8
074M321028	W-53	1221PWLA	D-6	20509005	W-86, W-74	24GCCVRNK	O-7, O-6, O-8
074M321250	W-53	1221PWR	D-6	20509006	W-86, W-74	24GCCVRNKC	O-7, O-6, O-8
074PG16010	W-53	1221PWW	D-6	20509007	W-86, W-74	24GCCFFCVRALU	O-7, O-6, O-8
074PG21010	W-53	1221R	D-6	20509008	W-86, W-74	24GCCFFCVRBK	O-7, O-6, O-8
074PG211247	W-53	1221W	D-6	2172	A-27, L-9	24GCCFFCVRBRS	O-7, O-6, O-8
074PG211248	W-53	1222B	D-6	2172BK	A-27, L-9	24GCCFFCVRBRZ	O-7, O-6, O-8
074PG29021	W-53	1222BK	D-6	2172BKL	A-27, L-9	24GCCFFCVRNK	O-7, O-6, O-8
074PG29023	W-53	1222GY	D-6	2172BKLTRA	A-27, L-9	24GEXTENDCAP2PK	O-10
074PG29025	W-53	1222I	D-6	2172BKTRA	A-27, L-9	24GTCVRALU	O-7, O-6, O-8
074PG291028	W-53	1222LA	D-6	2172GY	A-27, L-9	24GTCVRALUC	O-7, O-6, O-8
074PG36028	W-53	1222PWB	D-6	2172GYL	A-27, L-9	24GTCVRBK	O-7, O-6, O-8
091041000	W-56	1222PWBK	D-6	2172GYLTRA	A-27, L-9	24GTCVRBKC	O-7, O-6, O-8
091041001	W-56	1222PWGY	D-6	2172GYTRA	A-27, L-9	24GTCVRBRS	O-7, O-6, O-8
091041002	W-56	1222PWI	D-6	2172IV	A-27, L-9	24GTCVRBRSC	O-7, O-6, O-8
091041003	W-56	1222PWLA	D-6	2172IVL	A-27, L-9	24GTCVRBRZ	O-7, O-6, O-8
091041004	W-56	1222PWR	D-6	2172IVLTRA	A-27, L-9	24GTCVRBRZC	O-7, O-6, O-8
091041005	W-56	1222PWW	D-6	2172IVTRA	A-27, L-9	24GTCVRNK	O-7, O-6, O-8
091041006	W-56	1222R	D-6	2172L	A-27, L-9	24GTCVRNKC	O-7, O-6, O-8

Catalog Number Index

Catalog Number	Page	Catalog Number	Page	Catalog Number	Page	Catalog Number	Page
24GTEMPCVR	O-10	4GAFBCVRBRS	O-49	5262STI	A-21	5362R	A-28
24GTFFCVRALU	O-7, O-6, O-8	4GAFBCVRBRSC	O-49	5262STITR	A-21	5362ST	A-21
24GTFFCVRBK	O-7, O-6, O-8	4GAFBCVRBRZ	O-49	5262STIWR	A-22	5362STBK	A-21
24GTFFCVRBRS	O-7, O-6, O-8	4GAFBCVRBRZC	O-49	5262STLA	A-21	5362STBKTR	A-21
24GTFFCVRBRZ	O-7, O-6, O-8	4GAFBCVRNK	O-49	5262STLATR	A-21	5362STBKWR	A-22
24GTFFCVRNK	O-7, O-6, O-8	4GAFBCVRNK	O-49	5262STLAWR	A-22	5362STBL	A-21
2GAFBCVRALU	O-48	5252AB	A-28, O-33, A-63	5262STO	A-21	5362STBLTR	A-21
2GAFBCVRALUC	O-48	5252ABLK	A-28	5262STOTR	A-21	5362STBLWR	A-22
2GAFBCVRBK	O-48	5252AG	A-28	5262STOWR	A-22	5362STGN	A-21
2GAFBCVRBKC	O-48	5252AI	A-28	5262STR	A-21	5362STGNTR	A-21
2GAFBCVRBRS	O-48	5252ALA	A-28	5262STRTR	A-21	5362STGNWR	A-22
2GAFBCVRBRSC	O-48	5252AR	A-28	5262STRWR	A-22	5362STGY	A-21
2GAFBCVRBRZ	O-48	5252AW	A-28	5262STTR	A-21	5362STGYTR	A-21
2GAFBCVRBRZC	O-48	5252B	A-28	5262STW	A-21	5362STGYWR	A-22
2GAFBCVRNK	O-48	5252BK	A-28	5262STWR	A-22	5362STI	A-21
2GAFBCVRNK	O-48	5252BLKTR	A-28	5262STWTR	A-21	5362STITR	A-21
2GAFBFFCVRALU	O-48	5252BTR	A-28	5262STWWR	A-22	5362STIWR	A-22
2GAFBFFCVRBK	O-48	5252G	A-28	5262W	A-28	5362STLA	A-21
2GAFBFFCVRBRS	O-48	5252GTR	A-28	5262WR	A-28	5362STLATR	A-21
2GAFBFFCVRBRZ	O-48	5252I	A-28	5262WWR	A-28	5362STLAWR	A-22
2GAFBFFCVRNK	O-48	5252ITR	A-28	5352AB	A-28, O-33	5362STO	A-21
31518101BPK100	W-74	5252LA	A-28	5352ABLK	A-28	5362STOTR	A-21
31518102BPK100	W-74	5252LATR	A-28	5352AG	A-28	5362STOWR	A-22
31518103BPK100	W-74	5252R	A-28	5352AI	A-28	5362STR	A-21
31518104BPK100	W-74	5252RTR	A-28	5352ALA	A-28	5362STRTR	A-21
31518105BPK100	W-74	5252ST	A-20	5352AR	A-28	5362STRWR	A-22
31518106BPK100	W-74	5252STBK	A-20	5352AW	A-28	5362STTR	A-21
31518110BPK100	W-74	5252STBL	A-20	5352B	A-28	5362STW	A-21
31518111BPK100	W-74	5252STGN	A-20	5352BK	A-28	5362STWR	A-22
31518112BPK100	W-74	5252STGY	A-20	5352BLKTR	A-28	5362STWTR	A-21
31518113BPK100	W-74	5252STI	A-20	5352BTR	A-28	5362STWWR	A-22
31518116BPK100	W-74	5252STLA	A-20	5352G	A-28	5362W	A-28
31518117BPK100	W-74	5252STO	A-20	5352GTR	A-28	5362WR	A-28
31518118BPK100	W-74	5252STR	A-20	5352I	A-28	5362WWR	A-28
31518119BPK100	W-74	5252STW	A-20	5352ITR	A-28	5462B	A-28
31518123BPK100	W-74	5252W	A-28	5352LA	A-28	5462BK	A-28
31518124BPK100	W-74	5252WTR	A-28	5352LATR	A-28	5462BL	A-28
31518125BPK100	W-74	5262AB	A-28	5352R	A-28	5462GN	A-28
31518126BPK100	W-74	5262ABL	A-28	5352RTR	A-28	5462GY	A-28
31518127BPK100	W-74	5262ABLK	A-28	5352ST	A-20	5462IV	A-28
31605010GPK100	W-74	5262AG	A-28	5352STBK	A-20	5462LA	A-28
31605015GPK100	W-74	5262AI	A-28	5352STBL	A-20	5462R	A-28
31622001LPK50	W-74	5262ALA	A-28	5352STGN	A-20	5462WHI	A-28
31622002LPK50	W-73, W-74	5262AR	A-28	5352STGY	A-20	5662B	A-28
31622003LPK50	W-73, W-74	5262AW	A-28	5352STI	A-20	5662BK	A-28
31622007LPK50	W-73, W-74	5262B	A-28, O-33, A-63	5352STLA	A-20	5662BL	A-28
31622008LPK50	W-73, W-74	5262BKWR	A-28	5352STO	A-20	5662GN	A-28
31648035GPK100	W-74	5262BL	A-28	5352STR	A-20	5662GY	A-28
31648036GPK100	W-74	5262BLK	A-28	5352STW	A-20	5662IV	A-28
31648037GPK100	W-74	5262G	A-28	5352W	A-28	5662LA	A-28
31648038GPK100	W-74	5262GYWR	A-28	5352WTR	A-28	5662R	A-28
31648039GPK100	W-74	5262I	A-28	5362AB	A-28	5662WHI	A-28
31648042GPK100	W-74	5262IWR	A-28	5362ABL	A-28	610GCCVRALU	O-11, O-9, O-12
31648043GPK100	W-74	5262LA	A-28	5362ABLK	A-28	610GCCVRALUC	O-11, O-9, O-12
31648044GPK100	W-74	5262R	A-28	5362AG	A-28	610GCCVRBK	O-11, O-9, O-12
31648045GPK100	W-74	5262ST	A-21	5362AI	A-28	610GCCVRBKC	O-11, O-9, O-12
31648046GPK100	W-74	5262STBK	A-21	5362ALA	A-28	610GCCVRBRS	O-11, O-9, O-12
31648047GPK100	W-74	5262STBKTR	A-21	5362AR	A-28	610GCCVRBRSC	O-11, O-9, O-12
31648048GPK100	W-74	5262STBKWR	A-22	5362AW	A-28	610GCCVRBRZ	O-11, O-9, O-12
31648050GPK100	W-74	5262STBL	A-21	5362B	A-28, O-33	610GCCVRBRZC	O-11, O-9, O-12
31648051GPK100	W-74	5262STBLTR	A-21	5362BKWR	A-28	610GCCVRNK	O-11, O-9, O-12
31648052GPK100	W-74	5262STBLWR	A-22	5362BL	A-28	610GCCVRNK	O-11, O-9, O-12
31648053GPK100	W-74	5262STGN	A-21	5362BLK	A-28	610GFFCVRALU	O-9, O-12
31648054GPK100	W-74	5262STGNTR	A-21	5362G	A-28, I-4	610GFFCVRBK	O-9, O-12
4GAFBCVRALU	O-49	5262STGNWR	A-22	5362GYWR	A-28	610GFFCVRBRS	O-9, O-12
4GAFBCVRALUC	O-49	5262STGY	A-21	5362I	A-28	610GFFCVRBRZ	O-9, O-12
4GAFBCVRBK	O-49	5262STGYTR	A-21	5362IWR	A-28	610GFFCVRNK	O-9, O-12
4GAFBCVRBKC	O-49	5262STGYWR	A-22	5362LA	A-28	610GEXTENDCAP2PK	O-10, O-13

Catalog Number Index

Catalog Number	Page	Catalog Number	Page	Catalog Number	Page	Catalog Number	Page
610GTCVRLALU	O-11, O-9, O-12	8300BKLTRA	L-8, A-27	ACFSNC	G-26, F-17, G-47	AFBS1R4GRY	O-53
610GTCVRLALUC	O-11, O-9, O-12	8300BKTR	L-8, A-27	ACFSNO	G-26, F-17, G-47	AFBS1R4NKL	O-53
610GTCVRBK	O-11, O-9, O-12	8300C1IV	A-27	ACIPE	E-11	AFBS1R6BASE	O-54
610GTCVRBK	O-11, O-9, O-12	8300C1LA	A-27	AD2000H1	E-5	AFBS1R6DIV	O-54
610GTCVRBRS	O-11, O-9, O-12	8300C1RED	A-27	AD2000H1N	E-5	AFBS1R6FFALU	O-54
610GTCVRBRSC	O-11, O-9, O-12	8300C1WHI	A-27	AD2000I22	E-5	AFBS1R6FFBLK	O-54
610GTCVRBRZ	O-11, O-9, O-12	8300C2IV	A-27	AD2000LA1	E-5	AFBS1R6FFBRS	O-54
610GTCVRBRZC	O-11, O-9, O-12	8300C2LA	A-27	AD2000LA1N	E-5	AFBS1R6FFBRZ	O-54
610GTCVRNK	O-11, O-9, O-12	8300C2RED	A-27	AD2000LA22	E-5	AFBS1R6FFCVRALU	O-54
610GTCVRNKC	O-11, O-9, O-12	8300C2WHI	A-27	AD2000W1	E-5	AFBS1R6FFCVRBLK	O-54
610GTEMPCVR	O-10, O-13	8300GY	L-8, A-27	AD2000W1N	E-5	AFBS1R6FFCVRBRS	O-54
610GTFFCVRLALU	O-9, O-12	8300GYL	L-8, A-27	AD2000W22	E-5	AFBS1R6FFCVRBRZ	O-54
610GTFFCVRBK	O-9, O-12	8300GYLTRA	L-8, A-27	AD2000W22N	E-5	AFBS1R6FFCVRGRY	O-54
610GTFFCVRBRS	O-9, O-12	8300GYTRA	L-8, A-27	AD2001I1	E-5	AFBS1R6FFCVRNKL	O-54
610GTFFCVRBRZ	O-9, O-12	8300IV	L-8, A-27	AD2001I22	E-5	AFBS1R6FFGRY	O-54
610GTFFCVRNK	O-9, O-12	8300IVL	L-8, A-27	AD2001LA1	E-5	AFBS1R6FFNKL	O-54
7452	N-20	8300IVLTRA	L-8, A-27	AD2001W1	E-5	AFBS1R6GATE	O-54
8200	L-8, A-27	8300IVTRA	L-8, A-27	AD2001W22	E-5	AFBS1R6GROM	O-54
8200BK	L-8, A-27	8300L	L-8, A-27	AD2240I1	E-6	AFGF15TR	K-11
8200BKL	L-8, A-27	8300LA	L-8, A-27	AD2240I2	E-6	AFGF15TRBK	K-11
8200BKLTRA	L-8, A-27	8300LALM	L-8, A-27	AD2240LA1	E-6	AFGF15TRGY	K-11
8200BKTR	L-8, A-27	8300LALTRA	L-8, A-27	AD2240LA2	E-6	AFGF15TRI	K-11
8200GY	L-8, A-27	8300LATRA	L-8, A-27	AD2240W1	E-6	AFGF15TRLA	K-11
8200GYL	L-8, A-27	8300LTRA	L-8, A-27	AD2240W2	E-6	AFGF15TRW	K-11
8200GYLTRA	L-8, A-27	8300RED	L-8, A-27	AD2241I1	E-6	AFGF20TR	K-11
8200GYTRA	L-8, A-27	8300REDL	L-8, A-27	AD2241I2	E-6	AFGF20TRBK	K-11
8200IV	L-8, A-27	8300REDLTRA	L-8, A-27	AD2241LA1	E-6	AFGF20TRGY	K-11
8200IVL	L-8, A-27	8300REDTRA	L-8, A-27	AD2241LA2	E-6	AFGF20TRI	K-11
8200IVLTRA	L-8, A-27	8300ST	A-20	AD2241W1	E-6	AFGF20TRLA	K-11
8200IVTRA	L-8, A-27	8300STBK	A-20	AD2241W2	E-6	AFGF20TRW	K-11
8200L	L-8, A-27	8300STBKTR	A-20	ADD2000I1	E-9	AFR15TR	K-10
8200LAL	L-8, A-27	8300STBL	A-20	ADD2000LA1	E-9	AFR15TRBK	K-10
8200LALTRA	L-8, A-27	8300STBLTR	A-20	ADD2000W1	E-9	AFR15TRGY	K-10
8200LATRA	L-8, A-27	8300STGN	A-20	ADD2001I1	E-9	AFR15TRI	K-10
8200LTRA	L-8, A-27	8300STGNTR	A-20	ADD2001LA1	E-9	AFR15TRLA	K-10
8200LTRA	L-8, A-27	8300STGY	A-20	ADD2001W1	E-9	AFR15TRW	K-10
8200RED	L-8, A-27	8300STGYTR	A-20	ADN2000I1	E-5	AFR20BFI	K-10
8200REDL	L-8, A-27	8300STI	A-20	ADN2000I2	E-5	AFR20BFW	K-10
8200REDLTRA	A-61, L-8, A-27	8300STITR	A-20	ADN2000W1	E-5	AFR20TR	K-10
8200REDTRA	L-8, A-27	8300STLA	A-20	ADN2000W2	E-5	AFR20TRBK	K-10
8200ST	A-20	8300STLATR	A-20	AFB10G55	O-51, O-46	AFR20TRGY	K-10
8200STBK	A-20	8300STO	A-20	AFB10G55CHI	O-51, O-46	AFR20TRI	K-10
8200STBKTR	A-20	8300STOTR	A-20	AFB2G25	O-46, O-48	AFR20TRLA	K-10
8200STBL	A-20	8300STR	A-20	AFB2G25CHI	O-46, O-48	AFR20TRW	K-10
8200STBLTR	A-20	8300STRTR	A-20	AFB2G25PW	O-44	AHP1500CRP	E-11, E-16
8200STGN	A-20	8300STRTR	A-20	AFB2G50	O-46, O-48	AHP1600WRP	E-11, E-17
8200STGNTR	A-20	8300STTR	A-20	AFB2G50CHI	O-46, O-48	AP2000I1	E-5
8200STGY	A-20	8300STW	A-20	AFB2G50PW	O-44	AP2000I22	E-5
8200STGYTR	A-20	8300STWTR	A-20	AFB4G25	O-49, O-46	AP2000LA1	E-5
8200STI	A-20	8300TRA	L-8, A-27	AFB4G25CHI	O-49, O-46	AP2000LA22	E-5
8200STITR	A-20	8300WHI	L-8, A-27	AFB4G25PW	O-44	AP2000W1	E-5
8200STLA	A-20	8300WL	L-8, A-27	AFB4G50	O-49, O-46	AP2000W22	E-5
8200STLATR	A-20	8300WLTRA	L-8, A-27	AFB4G50CHI	O-49, O-46	AP2001I1	E-5
8200STO	A-20	8300WTRA	L-8, A-27	AFB4G50PW	O-44	AP2001I22	E-5
8200STOTR	A-20	9053A	BB-4	AFB4GDIVKIT	O-49	AP2001LA1	E-5
8200STR	A-20	9054A	BB-4	AFBS1R4ALU	O-53	AP2001LA22	E-5
8200STRTR	A-20	A460P9	G-32, G-31	AFBS1R4BASE	O-53	AP2001W1	E-5
8200STRTR	A-20	A460R9	G-32, G-31	AFBS1R4BLK	O-53	AP2001W22	E-5
8200STTR	A-20	A460R9KIT	G-31	AFBS1R4BOTTOM	O-53	AP22	P-35
8200STW	A-20	A5100P9	G-32, G-31	AFBS1R4BRS	O-53	AP2GY	P-35
8200STWTR	A-20	A560P9	G-31	AFBS1R4BRZ	O-53	AP2I	P-35
8200TRA	L-8, A-27	AA20045	G-41, G-42, G-44, G-40	AFBS1R4CVRALU	O-53	AP42	P-35
8200WHI	L-8, A-27	AA203055	G-35, B-54, C-4, G-28	AFBS1R4CVRBLK	O-53	APD2000I1	E-9
8200WL	L-8, A-27	AA2030PS	B-54, C-4, G-28	AFBS1R4CVRBRS	O-53	APD2000LA1	E-9
8200WLTRA	L-8, A-27	AA6010015	G-28	AFBS1R4CVRBRZ	O-53	APD2000W1	E-9
8200WTRA	L-8, A-27	AA6010055	G-35, G-28	AFBS1R4CVRGRY	O-53	APD2001I1	E-9
8300	L-8, A-27	AAR	E-9	AFBS1R4CVRNKL	O-53	APD2001LA1	E-9
8300BK	L-8, A-27	AAR20P	E-13, E-11, E-9	AFBS1R4DIV	O-53	APD2001W1	E-9
8300BKL	L-8, A-27	AB203055	G-35, B-54, C-4, G-28				

Catalog Number Index

Catalog Number	Page	Catalog Number	Page	Catalog Number	Page	Catalog Number	Page
APN20001	E-5	BB201WSS	G-28	BR15WRTR	AA-43, A-30	BR20C1GRY	A-24
APN2000W1	E-5	BB2030N	G-6, G-35, B-54, G-28, C-4, G-7, G-10	BR15LA	A-30, A-64	BR20C1GRYTR	A-24
AR101	D-21	BB301W	G-35, B-54, G-28, C-4, AA-24, G-10	BR15LATR	A-30	BR20C1I	A-24
AR103	D-21	BB301WSS	G-28	BR15LAWR	A-30	BR20C1ITR	A-24
AR1BE	D-21	BB601W	G-35, G-11, G-28, H-13, AA-24	BR15LAWRTR	AA-43, A-30	BR20C1LA	A-24
AR1W	D-21	BB601WSS	G-28	BR15R	A-30	BR20C1LATR	A-24
AR201	D-21	BB602W	G-35, G-11, G-28	BR15RTR	A-30	BR20C1R	A-24
AR2BE	D-21	BB60N	G-6, G-35, G-28, G-11, G-7	BR15ST	A-21	BR20C1RTR	A-24
AR2W	D-21	BR106B	Y-10	BR15STBK	A-21	BR20C1TR	A-24
AS103	D-21	BR106C	Y-10, S-63	BR15STBKTR	A-21	BR20C1WHI	A-24
AS1I	D-21	BR106E	Y-10, S-45	BR15STBKWR	A-22	BR20C1WHITR	A-24
AS1W	D-21	BR106G	Y-10, S-45	BR15STBKWTR	A-22	BR20C2	A-24
AS203	D-21	BR106W	Y-10	BR15STBL	A-21	BR20C2BL	A-24
AS2I	D-21	BR15	A-30	BR15STBLTR	A-21	BR20C2BLK	A-24
AS2W	D-21	BR15BL	A-30	BR15STBLWR	A-22	BR20C2BLKTR	A-24
ATB	R-4	BR15BLK	A-30	BR15STBLWRTR	A-22	BR20C2BLTR	A-24
ATD1000C	E-16	BR15BLKTR	A-30	BR15STGN	A-21	BR20C2GN	A-24
ATD1000CL	E-8	BR15BLKWR	A-30	BR15STGNTR	A-21	BR20C2GNTR	A-24
ATD1000CRP	E-8	BR15BLKWTR	AA-43, A-30	BR15STGNWR	A-22	BR20C2GRY	A-24
ATD1600W	E-17	BR15BLTR	A-30	BR15STGNWRTR	A-22	BR20C2GRYTR	A-24
ATD1600WRP	E-8	BR15C1	A-24	BR15STGY	A-21	BR20C2I	A-24
ATD2000C	E-16, E-8	BR15C1BL	A-24	BR15STGYTR	A-21	BR20C2ITR	A-24
ATD2000CL	E-8	BR15C1BLK	A-24	BR15STGYWR	A-22	BR20C2LA	A-24
ATD2000CRP	E-8	BR15C1BLKTR	A-24	BR15STGYWRTR	A-22	BR20C2LATR	A-24
ATP120HB	E-17	BR15C1BLTR	A-24	BR15STI	A-21	BR20C2R	A-24
ATP120HBRP	E-8	BR15C1GN	A-24	BR15STITR	A-21	BR20C2RTR	A-24
ATP1500C	E-16, E-8	BR15C1GNTR	A-24	BR15STIWR	A-22	BR20C2TR	A-24
ATP1500CL	E-8	BR15C1GRY	A-24	BR15STIWRTR	A-22	BR20C2WHI	A-24
ATP1500CRP	E-8	BR15C1GRYTR	A-24	BR15STLA	A-21	BR20C2WHITR	A-24
ATP1600W	E-17	BR15C1I	A-24	BR15STLATR	A-21	BR20GN	A-30
ATP1600WRP	E-8	BR15C1ITR	A-24	BR15STLAWR	A-22	BR20GNTR	A-30
ATP600C	E-16	BR15C1LA	A-24	BR15STLAWRTR	A-22	BR20GRY	A-30
ATU1000C	E-16	BR15C1LATR	A-24	BR15STO	A-21	BR20GRYTR	A-30
ATU2000C	E-16	BR15C1R	A-24	BR15STOTR	A-21	BR20GRYWR	A-30
ATU500C	E-16	BR15C1RTR	A-24	BR15STOWR	A-22	BR20GRYWRTR	A-30
AVCE1H	Y-19, X-5	BR15C1TR	A-24	BR15STOWRTR	A-22	BR20I	A-30
AVPS15BK	Y-11	BR15C1WHI	A-24	BR15STR	A-21	BR20ITR	A-30
AVPS15GY	Y-11	BR15C1WHITR	A-24	BR15STRTR	A-21	BR20IWR	A-30
AVPS15I	Y-11	BR15C2	A-24	BR15STRWR	A-22	BR20IWRTR	A-30
AVPS15LA	Y-11	BR15C2BL	A-24	BR15STRWRTR	A-22	BR20LA	A-30
AVPS15W	Y-11	BR15C2BLK	A-24	BR15STTR	A-21	BR20LATR	A-30
B2025	W-88	BR15C2BLKTR	A-24	BR15STW	A-21	BR20LAWR	A-30
B2038	W-88	BR15C2BLTR	A-24	BR15STWR	A-22	BR20LAWRTR	A-30
B2038R1200	W-88	BR15C2GN	A-24	BR15STWRTR	A-22	BR20R	A-30
B2050	W-88	BR15C2GNTR	A-24	BR15STWTR	A-21	BR20RTR	A-30
B2050R1000	W-88	BR15C2GRY	A-24	BR15STWWR	A-22	BR20ST	A-21
B2075	W-88	BR15C2GRYTR	A-24	BR15STWWRTR	A-22	BR20STBK	A-21
B2075R800	W-88	BR15C2I	A-24	BR15STR	A-30	BR20STBKTR	A-21
B2100	W-88	BR15C2ITR	A-24	BR15WHI	A-30	BR20STBKWR	A-22
B2100R500	W-88	BR15C2LA	A-24	BR15WHITR	A-30	BR20STBKWRTR	A-22
B2125	W-88	BR15C2LATR	A-24	BR15WHIWR	A-30	BR20STBL	A-21
B2150	W-88	BR15C2R	A-24	BR15WHIWRTR	AA-43, A-30	BR20STBLTR	A-21
B2200	W-88	BR15C2RTR	A-24	BR15WR	A-30	BR20STBLWR	A-22
B2481	O-32	BR15C2TR	A-24	BR15WRTR	AA-43, A-30	BR20STBLWRTR	A-22
B2482	O-32	BR15C2WHI	A-24	BR20	A-30	BR20STGN	A-21
B2483	O-32	BR15C2WHITR	A-24	BR20BL	A-30	BR20STGNTR	A-21
B2588	O-32	BR15GN	A-30	BR20BLK	A-30	BR20STGNWR	A-22
B2588275	O-32	BR15GNTR	A-30	BR20BLKTR	A-30	BR20STGNWRTR	A-22
BB1001W	G-12, G-35, G-11, G-28, AA-20, AA-21	BR15GRY	A-30	BR20BLKWTR	A-30	BR20STGY	A-21
BB1001WSS	G-28	BR15GRYTR	A-30	BR20BLKWTRTR	A-30	BR20STGYTR	A-21
BB1002W	G-12, G-35, G-11, G-28, AA-20, AA-21	BR15GRYWR	A-30	BR20BLTR	A-30	BR20STGYWR	A-22
BB1002WSS	G-28	BR15GRYWRTR	AA-43, A-30	BR20C1	A-24	BR20STGYWRTR	A-22
BB100N	G-12, G-35, G-28, G-11, AA-20, AA-21, G-7	BR15I	A-30	BR20C1BL	A-24	BR20STI	A-21
BB201W	G-35, B-54, G-28, C-4, AA-24, G-10	BR15ITR	A-30	BR20C1BLK	A-24	BR20STITR	A-21
		BR15IWR	A-30	BR20C1BLKTR	A-24	BR20STIWR	A-22
				BR20C1BLTR	A-24	BR20STIWRTR	A-22
				BR20C1GN	A-24	BR20STLA	A-21
				BR20C1GNTR	A-24	BR20STLATR	A-21

Catalog Number Index

Catalog Number	Page	Catalog Number	Page	Catalog Number	Page	Catalog Number	Page
BR20STLAWR	A-22	C320C7SA	G-19	C360P6SA	G-19	C420P9SA	G-19
BR20STLAWRTR	A-22	C320C7WA	G-17	C360P6WA	G-17	C420P9WA	G-17
BR20STO	A-21	C320P4SA	G-19	C360P7SA	G-19	C420R5SA	G-19
BR20STOTR	A-21	C320P4WA	G-17	C360P7WA	G-17	C420R5WA	G-17
BR20STOWR	A-22	C320P6SA	G-19	C360R4SA	G-19	C420R6SA	G-19
BR20STOWRTR	A-22	C320P6WA	G-17	C360R4WA	G-17	C420R6WA	G-17
BR20STR	A-21	C320P7SA	G-19	C360R6SA	G-19	C420R7SA	G-19
BR20STRTR	A-21	C320P7WA	G-17	C360R6WA	G-17	C420R7WA	G-17
BR20STRWR	A-22	C320R4SA	G-19	C360R7SA	G-19	C420R9SA	G-19
BR20STRWRTR	A-22	C320R4WA	G-17	C360R7WA	G-17	C420R9WA	G-17
BR20STTR	A-21	C320R6SA	G-19	C363B6SA	G-20	C430B5SA	G-19
BR20STW	A-21	C320R6WA	G-17	C363B6WA	G-18	C430B5WA	G-17
BR20STWR	A-22	C320R7SA	G-19	C363C6SA	G-20	C430B6SA	G-19
BR20STWRTR	A-22	C320R7WA	G-17	C363C6WA	G-18	C430B6WA	G-17
BR20STWTR	A-21	C330B4SA	G-19	C363P6SA	G-20	C430B7SA	G-19
BR20STWWR	A-22	C330B4WA	G-17	C363P6WA	G-18	C430B7WA	G-17
BR20STWWRTR	A-22	C330B6SA	G-19	C363R6SA	G-20	C430B9SA	G-19
BR20TR	A-30	C330B6WA	G-17	C363R6WA	G-18	C430B9WA	G-17
BR20WHI	A-30	C330B7SA	G-19	C4100B5WA	G-18	C430C5SA	G-19
BR20WHITR	A-30	C330B7WA	G-17	C4100B6WA	G-18	C430C5WA	G-17
BR20WHIWR	A-30	C330C4SA	G-19	C4100B7WA	G-18	C430C6SA	G-19
BR20WHIWRTR	A-30	C330C4WA	G-17	C4100B9WA	G-18	C430C6WA	G-17
BR20WR	A-30	C330C6SA	G-19	C4100C5WA	G-18	C430C7SA	G-19
BR20WRTR	A-30	C330C6WA	G-17	C4100C6WA	G-18	C430C7WA	G-17
BRMCCMB19X35X4	Y-16	C330C7SA	G-19	C4100C7WA	G-18	C430C9SA	G-19
BRMCCMB19X35X8	Y-16	C330C7WA	G-17	C4100C9WA	G-18	C430C9WA	G-17
BRMCCMB19X7X4	Y-16	C330P4SA	G-19	C4100P5WA	G-18	C430P5SA	G-19
BRMCCMB19X7X8	Y-16	C330P4WA	G-17	C4100P6WA	G-18	C430P5WA	G-17
BRS2RCA	O-24, P-32	C330P6SA	G-19	C4100P7WA	G-18	C430P6SA	G-19
BTPB3TF	S-60	C330P6WA	G-17	C4100P9WA	G-18	C430P6WA	G-17
C3100B6WA	G-18	C330P7SA	G-19	C4100R5WA	G-18	C430P7SA	G-19
C3100B7WA	G-18	C330P7WA	G-17	C4100R6WA	G-18	C430P7WA	G-17
C3100C6WA	G-18	C330R4SA	G-19	C4100R7WA	G-18	C430P9SA	G-19
C3100C7WA	G-18	C330R4WA	G-17	C4100R9WA	G-18	C430P9WA	G-17
C3100P6WA	G-18	C330R6SA	G-19	C4125B6WA	G-18	C430R5SA	G-19
C3100P7WA	G-18	C330R6WA	G-17	C4125C6WA	G-18	C430R5WA	G-17
C3100R6WA	G-18	C330R7SA	G-19	C4125P6WA	G-18	C430R6SA	G-19
C3100R7WA	G-18	C330R7WA	G-17	C4125R6WA	G-18	C430R6WA	G-17
C3125B6WA	G-18	C332B4SA	G-20	C416B6SA	G-20	C430R7SA	G-19
C3125C6WA	G-18	C332B4WA	G-18	C416B6WA	G-18	C430R7WA	G-17
C3125P6WA	G-18	C332B6SA	G-20	C416C6SA	G-20	C430R9SA	G-19
C3125R6WA	G-18	C332B6WA	G-18	C416C6WA	G-18	C430R9WA	G-17
C316B4SA	G-20	C332C4SA	G-20	C416P6SA	G-20	C432B3SA	G-20
C316B4WA	G-18	C332C4WA	G-18	C416P6WA	G-18	C432B3WA	G-18
C316B6SA	G-20	C332C6SA	G-20	C416R6SA	G-20	C432B6SA	G-20
C316B6WA	G-18	C332C6WA	G-18	C416R6WA	G-18	C432B6WA	G-18
C316C4SA	G-20	C332P4SA	G-20	C420B5SA	G-19	C432C3SA	G-20
C316C4WA	G-18	C332P4WA	G-18	C420B5WA	G-17	C432C3WA	G-18
C316C6SA	G-20	C332P6SA	G-20	C420B6SA	G-19	C432C6SA	G-20
C316C6WA	G-18	C332P6WA	G-18	C420B6WA	G-17	C432C6WA	G-18
C316P4SA	G-20	C332R4SA	G-20	C420B7SA	G-19	C432P3SA	G-20
C316P4WA	G-18	C332R4WA	G-18	C420B7WA	G-17	C432P3WA	G-18
C316P6SA	G-20	C332R6SA	G-20	C420B9SA	G-19	C432P6SA	G-20
C316P6WA	G-18	C332R6WA	G-18	C420B9WA	G-17	C432P6WA	G-18
C316R4SA	G-20	C360B4SA	G-19	C420C5SA	G-19	C432R3SA	G-20
C316R4WA	G-18	C360B4WA	G-17	C420C5WA	G-17	C432R3WA	G-18
C316R6SA	G-20	C360B6SA	G-19	C420C6SA	G-19	C432R6SA	G-20
C316R6WA	G-18	C360B6WA	G-17	C420C6WA	G-17	C432R6WA	G-18
C320B4SA	G-19	C360B7SA	G-19	C420C7SA	G-19	C460B5SA	G-19
C320B4WA	G-17	C360B7WA	G-17	C420C7WA	G-17	C460B5WA	G-17
C320B6SA	G-19	C360C4SA	G-19	C420C9SA	G-19	C460B6SA	G-19
C320B6WA	G-17	C360C4WA	G-17	C420C9WA	G-17	C460B6WA	G-17
C320B7SA	G-19	C360C6SA	G-19	C420P5SA	G-19	C460B7SA	G-19
C320B7WA	G-17	C360C6WA	G-17	C420P5WA	G-17	C460B7WA	G-17
C320C4SA	G-19	C360C7SA	G-19	C420P6SA	G-19	C460B9SA	G-19
C320C4WA	G-17	C360C7WA	G-17	C420P6WA	G-17	C460B9WA	G-17
C320C6SA	G-19	C360P4SA	G-19	C420P7SA	G-19	C460C5SA	G-19
C320C6WA	G-17	C360P4WA	G-17	C420P7WA	G-17	C460C5WA	G-17

Catalog Number Index

Catalog Number	Page	Catalog Number	Page	Catalog Number	Page	Catalog Number	Page
C460C6SA	G-19	C520C6SA	G-19	C530R9SA	G-19	CC3430	G-29, G-42
C460C6WA	G-17	C520C6WA	G-17	C530R9WA	G-17	CC420	G-29
C460C7SA	G-19	C520C7SA	G-19	C532B6SA	G-20	CC520	G-29
C460C7WA	G-17	C520C7WA	G-17	C532B6WA	G-18	CC530	G-29
C460C9SA	G-19	C520C9SA	G-19	C532C6SA	G-20	CC60	G-29, G-42
C460C9WA	G-17	C520C9WA	G-17	C532C6WA	G-18	CCF1C	I-3
C460P5SA	G-19	C520P5SA	G-19	C532P6SA	G-20	CCFAC	I-3
C460P5WA	G-17	C520P5WA	G-17	C532P6WA	G-18	CCFBC	I-3, I-2
C460P6SA	G-19	C520P6SA	G-19	C532R6SA	G-20	CCFCC	I-3
C460P6WA	G-17	C520P6WA	G-17	C532R6WA	G-18	CCM1C	I-3
C460P7SA	G-19	C520P7SA	G-19	C560B5SA	G-19	CCMAC	I-3
C460P7WA	G-17	C520P7WA	G-17	C560B5WA	G-17	CCMBC	I-3, I-2
C460P9SA	G-19	C520P9SA	G-19	C560B6SA	G-19	CCMCC	I-3
C460P9WA	G-17	C520P9WA	G-17	C560B6WA	G-17	CCPS1	W-39
C460R5SA	G-19	C520R5SA	G-19	C560B7SA	G-19	CCPS2	W-39
C460R5WA	G-17	C520R5WA	G-17	C560B7WA	G-17	CCPS3	W-39
C460R6SA	G-19	C520R6SA	G-19	C560B9SA	G-19	CEXT111FWL01	O-43
C460R6WA	G-17	C520R6WA	G-17	C560B9WA	G-17	CEXT111FWL01XP	O-43
C460R7SA	G-19	C520R7SA	G-19	C560C5SA	G-19	CEXT111MFL01	O-43
C460R7WA	G-17	C520R7WA	G-17	C560C5WA	G-17	CEXT111MFL05	O-43
C460R9SA	G-19	C520R9SA	G-19	C560C6SA	G-19	CEXT111MFL10	O-43
C460R9WA	G-17	C520R9WA	G-17	C560C6WA	G-17	CEXT111MFL15	O-43
C463B6SA	G-20	C530B5SA	G-19	C560C7SA	G-19	CEXT111MFL20	O-43
C463B6WA	G-18	C530B5WA	G-17	C560C7WA	G-17	CEXT111MFL25	O-43
C463C6SA	G-20	C530B6SA	G-19	C560C9SA	G-19	CEXT111MFL30	O-43
C463C6WA	G-18	C530B6WA	G-17	C560C9WA	G-17	CEXT111MFWL01	O-43
C463P6SA	G-20	C530B7SA	G-19	C560P5SA	G-19	CEXT111MFWL01XP	O-43
C463P6WA	G-18	C530B7WA	G-17	C560P5WA	G-17	CEXT111MFWL05	O-43
C463R6SA	G-20	C530B9SA	G-19	C560P6SA	G-19	CEXT111MFWL15	O-43
C463R6WA	G-18	C530B9WA	G-17	C560P6WA	G-17	CEXT332FWL01	O-43
C5100B5WA	G-18	C530C5SA	G-19	C560P7SA	G-19	CEXT332FWL01XP	O-43
C5100B6WA	G-18	C530C5SLT12	G-20	C560P7WA	G-17	CEXT332MFL01	O-43
C5100B7WA	G-18	C530C5SLT34	G-20	C560P9SA	G-19	CEXT332MFL05	O-43
C5100B9WA	G-18	C530C5WA	G-17	C560P9WA	G-17	CEXT332MFL10	O-43
C5100C5WA	G-18	C530C5WLT12	G-20	C560R5SA	G-19	CEXT332MFL15	O-43
C5100C6WA	G-18	C530C5WLT34	G-20	C560R5WA	G-17	CEXT332MFL20	O-43
C5100C7WA	G-18	C530C6SA	G-19	C560R6SA	G-19	CEXT332MFL25	O-43
C5100C9WA	G-18	C530C6SLT12	G-20	C560R6WA	G-17	CEXT332MFL30	O-43
C5100P5WA	G-18	C530C6SLT34	G-20	C560R7SA	G-19	CEXT332MFWL01	O-43
C5100P6WA	G-18	C530C6WA	G-17	C560R7WA	G-17	CEXT332MFWL01XP	O-43
C5100P7WA	G-18	C530C6WLT12	G-20	C560R9SA	G-19	CEXT332MFWL05	O-43
C5100P9WA	G-18	C530C6WLT34	G-20	C560R9WA	G-17	CEXT332MFWL15	O-43
C5100R5WA	G-18	C530C7SA	G-19	C563B6SA	G-20	CEXT422FWL01	O-43
C5100R6WA	G-18	C530C7SLT12	G-20	C563B6WA	G-18	CEXT422FWL01XP	O-43
C5100R7WA	G-18	C530C7SLT34	G-20	C563C6SA	G-20	CEXT422MFL01	O-43
C5100R9WA	G-18	C530C7WA	G-17	C563C6WA	G-18	CEXT422MFL05	O-43
C5125B6WA	G-18	C530C7WLT12	G-20	C563P6SA	G-20	CEXT422MFL10	O-43
C5125C6WA	G-18	C530C7WLT34	G-20	C563P6WA	G-18	CEXT422MFL15	O-43
C5125P6WA	G-18	C530C9SA	G-19	C563R6SA	G-20	CEXT422MFL20	O-43
C5125R6WA	G-18	C530C9SLT12	G-20	C563R6WA	G-18	CEXT422MFL25	O-43
C516B6SA	G-20	C530C9SLT34	G-20	CA100	AA-21, G-29, AA-20	CEXT422MFL30	O-43
C516B6WA	G-18	C530C9WA	G-17	CA100MI	G-23	CEXT422MFWL01	O-43
C516C6SA	G-20	C530C9WLT12	G-20	CA320	G-29	CEXT422MFWL01XP	O-43
C516C6WA	G-18	C530C9WLT34	G-20	CA3430	G-29	CEXT422MFWL05	O-43
C516P6SA	G-20	C530P5SA	G-19	CA3430MI	G-26, G-23	CEXT422MFWL15	O-43
C516P6WA	G-18	C530P5WA	G-17	CA420	G-29	CFB10G55	O-13
C516R6SA	G-20	C530P6SA	G-19	CA420MI	G-23	CFB10G55CRE	O-13, O-12
C516R6WA	G-18	C530P6WA	G-17	CA520	G-29	CFB10G55E	O-13, O-12
C520B5SA	G-19	C530P7SA	G-19	CA530	G-29	CFB10G55RCRE	O-13, O-12
C520B5WA	G-17	C530P7WA	G-17	CA530MI	G-26, G-23	CFB10G55RE	O-13, O-12
C520B6SA	G-19	C530P9SA	G-19	CA60	G-29	CFB11CVRALU	O-37
C520B6WA	G-17	C530P9WA	G-17	CA60MI	G-26, G-23	CFB11CVRBLK	O-37
C520B7SA	G-19	C530R5SA	G-19	CAP100	G-28	CFB11CVRBRS	O-37
C520B7WA	G-17	C530R5WA	G-17	CAP2030	G-28	CFB11CVRBLK	O-37
C520B9SA	G-19	C530R6SA	G-19	CAP60	G-28	CFB11CVRCSS	O-37
C520B9WA	G-17	C530R6WA	G-19	CC100	AA-21, G-29, G-42, AA-20	CFB11G4	O-37
C520C5SA	G-19	C530R7SA	G-17	CC201	G-42	CFB11G6	O-36, O-37
C520C5WA	G-17	C530R7WA	G-17	CC320	G-29	CFB11G6FRK	O-36

Catalog Number Index

Catalog Number	Page	Catalog Number	Page	Catalog Number	Page	Catalog Number	Page
CFB11TALU	O-37	CFB7TBRS	O-37	CFBS1R8FFCVRNKL	O-7, O-8,	CR15TRP1	A-29
CFB11TBRS	O-37	CFB8CVRALU1	O-38	O-12, O-9		CR15TRP2	A-29
CFB2G25	O-6	CFB8CVRALU2	O-38	CG304NM	W-52	CR15WHI	AA-43, A-29
CFB2G25CR	O-6	CFB8FC1	O-38	CG305NM	W-52	CR15WHIP1	A-29
CFB2G25CRE	O-6	CFB8FC2	O-38	CG306NM	W-52	CR15WHIP2	A-29
CFB2G25E	O-6	CFB8JBC1	O-38	CG404NM	W-52	CR15WHITR	AA-43, A-29
CFB2G25R	O-6	CFB8JBC2	O-38	CG404SST	W-52	CR15WHITRP1	A-29
CFB2G25RCR	O-6	CFB8RCVRR075	O-10, O-13	CG40690NM	W-52	CR15WHITRP2	A-29
CFB2G25RCRE	O-6	CFB8RCVRR1	O-10, O-13	CG406NM	W-52	CR16277	AA-14
CFB2G25RE	O-6	CFB8RCVRR2	O-10, O-13	CG406SST	W-52	CR16279	AA-16
CFB2G30	O-6	CFB8RCVRR3	O-10, O-13	CG40890NM	W-52	CR16914	AA-32
CFB2G30CR	O-6	CFBADAPT125	O-17	CG408NM	W-52	CR20	A-29
CFB2G30CRE	O-6	CFBADAPT200	O-17	CG408SST	W-52	CR20BLK	A-29
CFB2G30E	O-6	CFBHUB125PVC	O-10, O-13	CG410SST	W-52	CR20BLKP1	A-29
CFB2G30R	O-6	CFBHUB2	O-10, O-13, O-17	CG60890NM	W-52	CR20BLKP2	A-29
CFB2G30RCR	O-6	CFBHUB200PVC	O-10, O-13	CG608NM	W-52	CR20BLKTR	A-29
CFB2G30RCRE	O-6	CFBKOPLATE	O-10, O-13	CG608SST	W-52	CR20BLKTRP1	A-29
CFB2G30RE	O-6	CFBKOPLATECR	O-10, O-13	CG61090NM	W-52	CR20BLKTRP2	A-29
CFB2GS1R6ADAPTE	O-10	CFBOGPAN4	O-37, O-38	CG610NM	W-52	CR20GRY	A-29
CFB4510GS1R8ADAPTE	O-13	CFBS1R4CFB	O-16	CG610SST	W-52	CR20GRYP1	A-29
CFB45G55CRE	O-11	CFBS1R4COVER	O-17	CG61290NM	W-52	CR20GRYP2	A-29
CFB45G55E	O-11	CFBS1R4CUP	O-14, O-16	CG612NM	W-52	CR20GRYTR	A-29
CFB45G55RCRE	O-11	CFBS1R4CVRALU	O-17	CG612SST	W-52	CR20GRYTRP1	A-29
CFB45G55RE	O-11	CFBS1R4CVRBLK	O-17	CG614SST	W-52	CR20GRYTRP2	A-29
CFB4G25	O-7, O-8	CFBS1R4CVRBRS	O-17	CG810NM	W-52, C-11	CR20I	A-29
CFB4G25CR	O-7, O-8	CFBS1R4CVRBRZ	O-17	CG810SST	W-52	CR20IP1	A-29
CFB4G25CRE	O-7	CFBS1R4CVRGRY	O-17	CG81290NM	W-52	CR20IP2	A-29
CFB4G25E	O-7	CFBS1R4CVRNKL	O-17	CG812NM	W-52	CR20ITR	A-29
CFB4G25R	O-7, O-8	CFBS1R4DIV	O-17	CG812SST	W-52	CR20ITRP1	A-29
CFB4G25RCR	O-7, O-8	CFBS1R4FFCUP	O-16	CG81490NM	W-52	CR20ITRP2	A-29
CFB4G25RCRE	O-7	CFBS1R4GND	O-17	CG814NM	W-52	CR20LA	A-29
CFB4G25RE	O-7	CFBS1R4PFB	O-17, O-16	CG814SST	W-52	CR20LAP1	A-29
CFB4G30	O-7, O-8	CFBS1R4SFB	O-17, O-16	CG816NM	W-52	CR20LAP2	A-29
CFB4G30CI	O-8	CFBS1R4SFCR	O-17, O-16	CG816SST	W-52	CR20LATR	A-29
CFB4G30CR	O-7, O-8	CFBS1R6CVRALU	O-6	CL60	A-24, A-23	CR20LATRP1	A-29
CFB4G30CRE	O-7	CFBS1R6CVRBLK	O-6	CMBR	Y-16	CR20LATRP2	A-29
CFB4G30E	O-7	CFBS1R6CVRBRS	O-6	CPB20	F-29	CR20P1	A-29
CFB4G30PFB	O-8	CFBS1R6CVRBRZ	O-6	CPB21	F-29	CR20P2	A-29
CFB4G30PFBRE	O-8	CFBS1R6CVRGRY	O-6	CPB21BK	F-29	CR20TR	A-29, A-64
CFB4G30R	O-7, O-8	CFBS1R6CVRNKL	O-6	CPB22	F-29	CR20TRP1	A-29
CFB4G30RCI	O-8	CFBS1R6FFCVRALU	O-6	CR15	AA-43, A-29	CR20TRP2	A-29
CFB4G30RCR	O-7, O-8	CFBS1R6FFCVRBLK	O-6	CR15BLK	AA-43, A-29	CR20WHI	A-29
CFB4G30RCRE	O-7	CFBS1R6FFCVRBRS	O-6	CR15BLKP1	A-29	CR20WHIP1	A-29
CFB4G30RE	O-7	CFBS1R6FFCVRBRZ	O-6	CR15BLKP2	A-29	CR20WHIP2	A-29
CFB4GS1R8ADAPTE	O-10	CFBS1R6FFCVRGRY	O-6	CR15BLKTR	AA-43, A-29	CR20WHITR	A-29
CFB6G30	O-9	CFBS1R6FFCVRNKL	O-6	CR15BLKTRP1	A-29	CR20WHITRP1	A-29
CFB6G30CR	O-9	CFBS1R8CVRALU	O-50, O-11, O-7,	CR15BLKTRP2	A-29	CR20WHITRP2	A-29
CFB6G30CRE	O-9	O-9, O-8, O-12		CR15GRY	AA-43, A-29	CR5252IG	A-28, O-33, M-17
CFB6G30E	O-9	CFBS1R8CVRBLK	O-50, O-11, O-7,	CR15GRYP1	A-29	CR5252IGBK	A-28, M-17
CFB6G30R	O-9	O-9, O-8, O-12		CR15GRYP2	A-29	CR5252IGGY	A-28, M-17
CFB6G30RCR	O-9	CFBS1R8CVRBRZO-50, O-11, O-7,		CR15GRYTR	AA-43, A-29	CR5252IGI	A-28, M-17
CFB6G30RCRE	O-9	O-9, O-8, O-12		CR15GRYTRP1	A-29	CR5252IGOW	M-17
CFB6G30RE	O-9	CFBS1R8CVRBRZO-50, O-11, O-7,		CR15GRYTRP2	A-29	CR5252IGW	A-28, M-17
CFB6GEDIVKIT	O-10	O-9, O-8, O-12		CR15I	AA-43, A-29	CR5352IG	A-28, O-33, M-17
CFB6GS1R8ADAPTE	O-10	CFBS1R8CVRGRYO-50, O-11, O-7,		CR15IP1	A-29	CR5352IGBK	A-28, M-17
CFB6RCVRR075	O-10	O-9, O-8, O-12		CR15IP2	A-29	CR5352IGBL	A-28, M-17
CFB6RCVRR1	O-10	CFBS1R8CVRNKL	O-50, O-11, O-7,	CR15ITR	AA-43, A-29	CR5352IGGY	M-17, A-28, I-4
CFB6RCVRR2	O-10	O-9, O-8, O-12		CR15ITRP1	A-29	CR5352IGI	A-28, M-17
CFB6RCVRR3	O-10	CFBS1R8FFCVRALU	O-7, O-8,	CR15ITRP2	A-29	CR5352IGOW	M-17
CFB7CVRALU	O-37	O-12, O-9		CR15LA	AA-43, A-29	CR5352IGW	A-28, M-17
CFB7CVRBLK	O-37	CFBS1R8FFCVRBLK	O-7, O-8,	CR15LAP1	A-29	CRF15	A-29
CFB7CVRBRS	O-37	O-12, O-9		CR15LAP2	A-29	CRF15GRY	A-29
CFB7CVRCLBK	O-37	CFBS1R8FFCVRBRS	O-7, O-8,	CR15LATR	AA-43, A-29	CRF15I	A-29, A-64
CFB7CVRCSS	O-37	O-12, O-9		CR15LATRP1	A-29	CRF15LA	A-29
CFB7G4	O-37	CFBS1R8FFCVRBRZ	O-7, O-8,	CR15LATRP2	A-29	CRF15WHI	A-29
CFB7G6	O-36, O-37	O-12, O-9		CR15P1	A-29	CRF20	A-29
CFB7G6FRK	O-36	CFBS1R8FFCVRGRY	O-7, O-8,	CR15P2	A-29	CRF20BLK	A-29
CFB7TALU	O-37	O-12, O-9		CR15TR	AA-43, A-29	CRF20GRY	A-29

Catalog Number Index

Catalog Number	Page	Catalog Number	Page	Catalog Number	Page	Catalog Number	Page
CRF20I	A-29	CSB115GY	D-14	CSB320IF	D-14	CSL320W	D-15
CRF20LA	A-29	CSB115I	D-14	CSB320ILV	D-17	CSL415	D-15
CRF20WHI	A-29	CSB115LA	D-14	CSB320LA	D-14	CSL415BK	D-15
CS1004	AA-19, AA-5	CSB115ST	D-11	CSB320LAF	D-14	CSL415GY	D-15
CS100IT4	AA-19, AA-5	CSB115STBK	D-11	CSB320LALV	D-17	CSL415I	D-15
CS100IT5	AA-19, AA-5	CSB115STGY	D-11	CSB320RLV	D-17	CSL415LA	D-15
CS115	D-14, AA-44	CSB115STI	D-11	CSB320R	D-14	CSL415W	D-15
CS115BK	D-14, AA-44	CSB115STLA	D-11	CSB320RLV	D-17	CSL420	D-15
CS115GY	D-14, AA-44	CSB115STR	D-11	CSB320ST	D-12	CSL420BK	D-15
CS115I	D-14, AA-44	CSB115STW	D-11	CSB320STBK	D-12	CSL420GY	D-15
CS115LA	D-14, AA-44	CSB115W	D-14	CSB320STGY	D-12	CSL420I	D-15
CS115W	D-14, AA-44	CSB120	D-14	CSB320STI	D-12	CSL420LA	D-15
CS120	D-14	CSB120BK	D-14	CSB320STLA	D-12	CSL420R	D-15
CS120BK	D-14	CSB120BKL	D-17	CSB320STR	D-12	CSL420W	D-15
CS120GY	D-14	CSB120BKL	D-17	CSB320STW	D-12	CU300A	E-9
CS120I	D-14	CSB120BRLV	D-17	CSB320WF	D-14	CU300ELC	E-9
CS120LA	D-14	CSB120GY	D-14	CSB320WHLV	D-17	CU300HD	E-13, E-11, E-9
CS120W	D-14	CSB120GYLV	D-17	CSB415	D-14	CU300M	E-9
CS315	D-14, AA-44	CSB120I	D-14	CSB415BK	D-14	CW100IT4	AA-19, AA-5
CS315BK	D-14, AA-44	CSB120IF	D-14	CSB415GY	D-14	CW100IT4W	AA-19
CS315GY	D-14, AA-44	CSB120ILV	D-17	CSB415I	D-14	CW100IT5	AA-19, AA-5
CS315I	D-14, AA-44	CSB120LA	D-14	CSB415LA	D-14	CW125IT4	AA-19, AA-5
CS315LA	D-14, AA-44	CSB120LAF	D-14	CSB415W	D-14	CW125IT5	AA-19, AA-5
CS315W	D-14, AA-44	CSB120LALV	D-17	CSB420	D-14	CW754	AA-19, AA-5
CS320	D-14	CSB120R	D-14	CSB420BK	D-14	CWP26CR	AA-49, AA-42
CS320BK	D-14	CSB120RLV	D-17	CSB420GY	D-14	CWP26CRW	AA-49, AA-42
CS320GY	D-14	CSB120ST	D-12	CSB420I	D-14	CWP8CR	AA-49
CS320I	D-14	CSB120STBK	D-12	CSB420LA	D-14	DD100NLIV	Z-4
CS320LA	D-14	CSB120STGY	D-12	CSB420R	D-14	DD100NLLA	Z-4
CS320W	D-14	CSB120STI	D-12	CSB420W	D-14	DD100NLWH	Z-4
CS50CA05	B-60	CSB120STLA	D-12	CSL115	D-15	DR15	AA-43, A-31
CS50CA10	B-60	CSB120STR	D-12	CSL115BK	D-15	DR15BLK	AA-43, A-31
CS50CA34	B-60	CSB120STW	D-12	CSL115GY	D-15	DR15BLKP1	A-31
CS50EXT4	AA-19, AA-5	CSB120W	D-14	CSL115I	D-15	DR15BLKP2	A-31
CS50EXT5	AA-19, AA-5	CSB120WF	D-14	CSL115LA	D-15	DR15BLKTR	AA-43, A-31
CS6360C	B-56	CSB120WHLV	D-17	CSL115W	D-15	DR15BLKTRP1	A-31
CS6361C	B-56	CSB215	D-14	CSL120	D-15	DR15BLKTRP2	A-31
CS6364C	B-57	CSB215BK	D-14	CSL120BK	D-15	DR15BLKWRTR	AA-43, A-31
CS6365C	B-57	CSB215GY	D-14	CSL120GY	D-15	DR15C1	A-24
CS6369	B-57, H-13	CSB215I	D-14	CSL120I	D-15	DR15C1BL	A-24
CS6370	B-56	CSB215LA	D-14	CSL120LA	D-15	DR15C1BLK	A-24
CS6375	B-57	CSB215W	D-14	CSL120R	D-15	DR15C1BLKTR	A-24
CS6375M2	B-57	CSB220	D-14	CSL120W	D-15	DR15C1BLTR	A-24
CS6377	B-56	CSB220BK	D-14	CSL215	D-15	DR15C1GN	A-24
CS754	AA-19, AA-5	CSB220GY	D-14	CSL215BK	D-15	DR15C1GNTR	A-24
CS75IT4	AA-19	CSB220I	D-14	CSL215GY	D-15	DR15C1GRY	A-24
CS75IT5	AA-19, AA-5	CSB220LA	D-14	CSL215I	D-15	DR15C1GRYTR	A-24
CS8164C	B-57	CSB220R	D-14	CSL215LA	D-15	DR15C1I	A-24
CS8165C	B-57	CSB220W	D-14	CSL215W	D-15	DR15C1ITR	A-24
CS8169	B-57	CSB315	D-14	CSL220	D-15	DR15C1LA	A-24
CS8175	B-57	CSB315BK	D-14	CSL220BK	D-15	DR15C1LATR	A-24
CS8264C	B-56	CSB315GY	D-14	CSL220GY	D-15	DR15C1R	A-24
CS8265C	B-56	CSB315I	D-14	CSL220I	D-15	DR15C1RTR	A-24
CS8269	B-56	CSB315LA	D-14	CSL220LA	D-15	DR15C1TR	A-24
CS8275	B-56	CSB315ST	D-11	CSL220R	D-15	DR15C1WHI	A-24
CS8364C	B-57	CSB315STBK	D-11	CSL220W	D-15	DR15C1WHITR	A-24
CS8364CA05	B-57	CSB315STGY	D-11	CSL315	D-15	DR15C2	A-24
CS8364CA10	B-57	CSB315STI	D-11	CSL315BK	D-15	DR15C2BL	A-24
CS8364CA34	B-57	CSB315STLA	D-11	CSL315GY	D-15	DR15C2BLK	A-24
CS8365C	B-57	CSB315STR	D-11	CSL315I	D-15	DR15C2BLKTR	A-24
CS8369	B-57	CSB315STW	D-11	CSL315LA	D-15	DR15C2BLTR	A-24
CS8375	B-57	CSB315W	D-14	CSL315W	D-15	DR15C2GN	A-24
CS8464C	B-56	CSB320	D-14	CSL320	D-15	DR15C2GNTR	A-24
CS8465C	B-56	CSB320BK	D-14	CSL320BK	D-15	DR15C2GRY	A-24
CS8469	B-56	CSB320BKL	D-17	CSL320GY	D-15	DR15C2GRYTR	A-24
CS8475	B-56	CSB320BRLV	D-17	CSL320I	D-15	DR15C2I	A-24
CSB115	D-14	CSB320GY	D-14	CSL320LA	D-15	DR15C2ITR	A-24
CSB115BK	D-14	CSB320GYLV	D-17	CSL320R	D-15	DR15C2LA	A-24
		CSB320I	D-14				

Catalog Number Index

Catalog Number	Page	Catalog Number	Page	Catalog Number	Page	Catalog Number	Page
DR15C2LATR	A-24	DR15STTR	A-21	DR20GRYTRP1	A-31	DR20WHITRP2	A-31
DR15C2R	A-24	DR15STW	A-21	DR20GRYTRP2	A-31	DR20WHIWRTR	A-31
DR15C2RTR	A-24	DR15STWR	A-22	DR20GRYWRTR	A-31	DR20WRTR	A-31
DR15C2TR	A-24	DR15STWRTR	A-22	DR20I	A-31, A-64	DRUB1221AC	I-13
DR15C2WHI	A-24	DR15STWTR	A-21	DR20IP1	A-31	DRUB15	I-13
DR15C2WHITR	A-24	DR15STWWR	A-22	DR20IP2	A-31	DRUB15CB5	I-13
DR15GN	A-31	DR15STWWRTR	A-22	DR20ITR	A-31	DRUB15H	I-13
DR15GNTR	A-31	DR15TR	AA-43, A-31	DR20ITRP1	A-31	DRUB15HCB5	I-13
DR15GRY	AA-43, A-31	DR15TRP1	A-31	DR20ITRP2	A-31	DRUB20	I-13
DR15GRYP1	A-31	DR15TRP2	A-31	DR20IWRTR	A-31	DRUB20AC	I-13
DR15GRYP2	A-31	DR15WHI	AA-43, A-31	DR20LA	A-31	DRUB20ACCB5	I-13
DR15GRYTR	AA-43, A-31	DR15WHIP1	A-31	DR20LAP1	A-31	DRUB5462	I-13
DR15GRYTRP1	A-31	DR15WHIP2	A-31	DR20LAP2	A-31	DRUB6404	I-13
DR15GRYTRP2	A-31	DR15WHITR	AA-43, A-31	DR20LATR	A-31	DRUBGF15	I-13
DR15GRYWRTR	AA-43, A-31	DR15WHITRP1	A-31	DR20LATRP1	A-31	DRUBGF15AC	I-13
DR15I	AA-43, A-31	DR15WHITRP2	A-31	DR20LATRP2	A-31	DRUBGF15CB5	I-13
DR15IP1	A-31	DR15WHIWRTR	AA-43, A-31	DR20LAWRTR	A-31	DRUBGF15H	I-13
DR15IP2	A-31	DR15WRTR	AA-43, A-31	DR20P1	A-31	DRUBGF15HCB5	I-13
DR15ITR	AA-43, A-31	DR20	A-31	DR20P2	A-31	DRUBGF120	I-13
DR15ITRP1	A-31	DR20BLK	A-31	DR20R	A-31	DRUBGF120AC	I-13
DR15ITRP2	A-31	DR20BLKP1	A-31	DR20ST	A-21	DRUBGF120BFAC	I-13
DR15IWRTR	AA-43, A-31	DR20BLKP2	A-31	DR20STBK	A-21	DRUBIG15	I-13
DR15LA	AA-43, A-31	DR20BLKTR	A-31	DR20STBKTR	A-21	DRUBKIT	I-13
DR15LAP1	A-31	DR20BLKTRP1	A-31	DR20STBKWR	A-22	DRUBKITAC	I-13
DR15LAP2	A-31	DR20BLKTRP2	A-31	DR20STBKWRTR	A-22	DRUBKITACCB5	I-13
DR15LATR	AA-43, A-31	DR20BLKWRTR	A-31	DR20STBL	A-21	DRUBKITCB5	I-13
DR15LATRP1	A-31	DR20C1	A-24	DR20STBLTR	A-21	DRUBTVSS15	I-13
DR15LATRP2	A-31	DR20C1BL	A-24	DR20STBLWR	A-22	DRUBTVSS15AC	I-13
DR15LAWRTR	AA-43, A-31	DR20C1BLK	A-24	DR20STBLWRTR	A-22	DS115	D-15
DR15NLIV	Z-5, A-31	DR20C1BLKTR	A-24	DR20STGN	A-21	DS115BK	D-15
DR15NLLA	Z-5, A-31	DR20C1BLTR	A-24	DR20STGNTR	A-21	DS115BY	D-15
DR15NLWH	Z-5, A-31	DR20C1GN	A-24	DR20STGNWR	A-22	DS115I	D-15
DR15P1	A-31	DR20C1GNTR	A-24	DR20STGNWRTR	A-22	DS115LA	D-15
DR15P2	A-31	DR20C1GRY	A-24	DR20STGY	A-21	DS115ST	D-12
DR15R	A-31	DR20C1GRYTR	A-24	DR20STGYTR	A-21	DS115STBK	D-12
DR15ST	A-21	DR20C1I	A-24	DR20STGYWR	A-22	DS115STGY	D-12
DR15STBK	A-21	DR20C1ITR	A-24	DR20STGYWRTR	A-22	DS115STI	D-12
DR15STBKTR	A-21	DR20C1LA	A-24	DR20STI	A-21	DS115STLA	D-12
DR15STBKWR	A-22	DR20C1LATR	A-24	DR20STITR	A-21	DS115STR	D-12
DR15STBKWRTR	A-22	DR20C1R	A-24	DR20STIWR	A-22	DS115STW	D-12
DR15STBL	A-21	DR20C1RTR	A-24	DR20STIWRTR	A-22	DS115W	D-15
DR15STBLTR	A-21	DR20C1TR	A-24	DR20STLA	A-21	DS120	D-15
DR15STBLWR	A-22	DR20C1WHI	A-24	DR20STLATR	A-21	DS120BK	D-15
DR15STBLWRTR	A-22	DR20C1WHITR	A-24	DR20STLAWR	A-22	DS120BKLV	D-17
DR15STGN	A-21	DR20C2	A-24	DR20STLAWRTR	A-22	DS120GY	D-15
DR15STGNTR	A-21	DR20C2BL	A-24	DR20STO	A-21	DS120GYLV	D-17
DR15STGNWR	A-22	DR20C2BLK	A-24	DR20STOTR	A-21	DS120I	D-15
DR15STGNWRTR	A-22	DR20C2BLKTR	A-24	DR20STOWR	A-22	DS120IL	D-16
DR15STGY	A-21	DR20C2BLTR	A-24	DR20STOWRTR	A-22	DS120ILBK	D-16
DR15STGYTR	A-21	DR20C2GN	A-24	DR20STR	A-21	DS120ILLA	D-16
DR15STGYWR	A-22	DR20C2GNTR	A-24	DR20STRTR	A-21	DS120ILR	D-16
DR15STGYWRTR	A-22	DR20C2GRY	A-24	DR20STRWR	A-22	DS120ILV	D-17
DR15STI	A-21	DR20C2GRYTR	A-24	DR20STRWRTR	A-22	DS120ILW	D-16
DR15STITR	A-21	DR20C2I	A-24	DR20STTR	A-21	DS120LA	D-15
DR15STIWR	A-22	DR20C2ITR	A-24	DR20STW	A-21	DS120LALV	D-17
DR15STIWRTR	A-22	DR20C2LA	A-24	DR20STWR	A-22	DS120LV	D-17
DR15STLA	A-21	DR20C2LATR	A-24	DR20STWRTR	A-22	DS120NLBK	D-16, Z-3
DR15STLATR	A-21	DR20C2R	A-24	DR20STWTR	A-21	DS120NLBR	D-16, Z-3
DR15STLAWR	A-22	DR20C2RTR	A-24	DR20STWWR	A-22	DS120NLGY	D-16, Z-3
DR15STLAWRTR	A-22	DR20C2TR	A-24	DR20STWWRTR	A-22	DS120NLIV	D-16, Z-3
DR15STO	A-21	DR20C2WHI	A-24	DR20TR	A-31	DS120NLLA	D-16, Z-3
DR15STOTR	A-21	DR20C2WHITR	A-24	DR20TRP1	A-31	DS120NLWH	D-16, Z-3
DR15STOWR	A-22	DR20GN	A-31	DR20TRP2	A-31	DS120PLBK	D-16
DR15STOWRTR	A-22	DR20GNTR	A-31	DR20WHI	A-31	DS120PLI	D-16
DR15STR	A-21	DR20GRY	A-31	DR20WHIP1	A-31	DS120PLW	D-16
DR15STRTR	A-21	DR20GRYP1	A-31	DR20WHIP2	A-31	DS120R	D-15
DR15STRWR	A-22	DR20GRYP2	A-31	DR20WHITR	A-31	DS120RLV	D-17
DR15STRWRTR	A-22	DR20GRYTR	A-31	DR20WHITRP1	A-31	DS120ST	D-12

Catalog Number Index

Catalog Number	Page	Catalog Number	Page	Catalog Number	Page	Catalog Number	Page
DS120STBK	D-12	DS420GY	D-15	DT5030W	Z-20, E-6	FDS30	F-17, F-18, F-19
DS120STGY	D-12	DS420I	D-15	DT5060I	Z-20, E-6	FDS60	F-17, F-18, F-19
DS120STI	D-12	DS420LA	D-15	DT5060LA	Z-20, E-6	FF2BK	P-33
DS120STIL	D-12	DS420R	D-15	DT5060W	Z-20, E-6	FF2BRS	P-33
DS120STILBK	D-12	DS420W	D-15	EXT13	P-35	FF2GY	P-33
DS120STILGY	D-12	DSC010GY	E-9	F1340	O-34	FF3GY	P-35
DS120STILI	D-12	DSC010I	E-9	F2025	W-89	FF3I	P-35
DS120STILLA	D-12	DSC010LA	E-9	F3185	O-34	FHC1022	W-72
DS120STILR	D-12	DSC010W	E-9	FASTSCDCS6	S-63	FHC1023	W-72
DS120STILW	D-12	DSL010GY	E-9	FB10MP2A	O-51, O-13	FHC1033	W-72
DS120STLA	D-12	DSL010I	E-9	FB10MP2B	O-51, O-13	FHC1034	W-72
DS120STR	D-12	DSL010LA	E-9	FB10MP2E	O-51, O-13	FHC1042	W-72
DS120STW	D-12	DSL010W	E-9	FB10MP3GAPP	O-51, O-13	FHC1043	W-72
DS120W	D-15	DSL115	D-15	FB10MPAAP	O-51, O-13	FLOCK1	Y-24
DS120WLV	D-17	DSL115BK	D-15	FB10MPBKN	O-51, O-13	FR280ALA	P-34
DS220B	D-15	DSL115GY	D-15	FB10MPDUP	O-51, O-13	FR280BKA	P-34
DS220BK	D-15	DSL115I	D-15	FB10MPFT	O-51, O-13	FR280GYA	P-34
DS220GY	D-15	DSL115LA	D-15	FB10MPKEY	O-51, O-13	FR480	P-46
DS220I	D-15	DSL115W	D-15	FB10MPMAAP	O-51, O-13	FR480BKA	P-34
DS220LA	D-15	DSL120	D-15	FB10MPNEMA2XG	O-51, O-13	FR480GYA	P-34
DS220R	D-15	DSL120BK	D-15	FB10MPNEMA4G	O-51, O-13	FR680BKA	P-34
DS220W	D-15	DSL120GY	D-15	FB10MPREC	O-51, O-13	FR680GYA	P-34
DS315	D-15	DSL120I	D-15	FB10MPTRAC	O-51, O-13	FR80AL	P-35, P-46
DS315BK	D-15	DSL120LA	D-15	FB10MPX	O-13	FRBR1	P-35
DS315GY	D-15	DSL120W	D-15	FB10TLA	O-51, O-13	FRF1BK	P-33
DS315I	D-15	DSL220	D-15	FB10TLB	O-51, O-13	FRF1BRS	P-33
DS315LA	D-15	DSL220BK	D-15	FB10TLC	O-51, O-13	FRF1GY	P-33
DS315ST	D-12	DSL220GY	D-15	FB10TLX	O-51, O-13	FRF3BK	P-33
DS315STBK	D-12	DSL220I	D-15	FB10TLY	O-51, O-13	FRF3GY	P-33
DS315STGY	D-12	DSL220LA	D-15	FB10TLZ	O-51, O-13	FRF3I	P-33
DS315STI	D-12	DSL220W	D-15	FB2421	O-30, O-31	FRFBLA	P-32
DS315STLA	D-12	DSL30I1	E-8	FB2422	O-30, O-31	FRFBRA	P-32
DS315STR	D-12	DSL30LA1	E-8	FB2423	O-30, O-31	FRFBRS2A	P-32
DS315STW	D-12	DSL30W1	E-8	FB2431	O-30, O-31	FRFGYA	P-32
DS315W	D-15	DSL315	D-15	FB2432	O-30, O-31	FRFIA	P-32
DS320	D-15	DSL315BK	D-15	FB2433	O-30, O-31	FRG625	Y-6
DS320BK	D-15	DSL315GY	D-15	FB2527	O-25	FRP250	P-31
DS320BKLV	D-17	DSL315I	D-15	FB2529	O-25	FS2	BB-4
DS320GY	D-15	DSL315LA	D-15	FB2536	O-25	FS25	BB-4
DS320GYLV	D-17	DSL315W	D-15	FB2537	O-25	FS4	BB-4
DS320I	D-15	DSL320	D-15	FB2546	O-25	FS5	BB-4
DS320IL	D-16	DSL320BK	D-15	FB4114	O-28, O-29	FSPFP6X	Y-24
DS320ILBK	D-16	DSL320GY	D-15	FB4133	O-28, O-29	FSPHD6X	Y-24
DS320ILV	D-17	DSL320I	D-15	FB4214	O-28, O-29	FT10BK3	V-6
DS320ILW	D-16	DSL320LA	D-15	FB4233	O-28, O-29	FT10BK5	V-6
DS320LA	D-15	DSL320W	D-15	FB4314	O-28, O-29	FT10Y3	V-6
DS320LALV	D-17	DSL420	D-15	FB4333	O-28, O-29	FT10Y5	V-6
DS320LV	D-17	DSL420BK	D-15	FBC2100	O-35	FT202W	G-35, B-54, G-28, C-4, AA-24
DS320R	D-15	DSL420GY	D-15	FBC2200	O-35	FT2BG10	V-6
DS320RLV	D-17	DSL420I	D-15	FBC2300	O-35	FT2BK10	V-6
DS320ST	D-12	DSL420LA	D-15	FBC2500	O-35	FT2BR10	V-6
DS320STBK	D-12	DSL420W	D-15	FBC4100	O-35	FT2GY10	V-6
DS320STGY	D-12	DSM010GY	E-9	FBC4200	O-35	FT2GY10	V-6
DS320STI	D-12	DSM010I	E-9	FBC4300	O-35	FT2Y10	V-6
DS320STIL	D-12	DSM010LA	E-9	FBMP139	O-10, O-49, O-48	FT302W	G-35, B-54, C-4, G-28
DS320STILBK	D-12	DSM010W	E-9	FBMP156	O-10, O-49, O-48	FT3BG25	V-6
DS320STILGY	D-12	DSM30I1	E-8	FBMP15IM	O-10, O-49, O-48	FT3BG5	V-6
DS320STILGY	D-12	DSM30I2	E-8	FBMP2IM	O-10, O-49, O-48	FT3BK25	V-6
DS320STILI	D-12	DSM30LA1	E-8	FBMP6DJ	O-10	FT3BK5	V-6
DS320STILLA	D-12	DSM30LA2	E-8	FBMP6KS	O-10, O-49, O-48	FT3BR25	V-6
DS320STILR	D-12	DSM30W1	E-8	FBMPAAP	O-10, O-49, O-48	FT3BR5	V-6
DS320STILW	D-12	DSM30W2	E-8	FBMPBKN	O-10, O-49, O-48	FT3GY25	V-6
DS320STLA	D-12	DT2000W	Z-20, E-6	FBMPDUP	O-10, O-49, O-48	FT3GY5	V-6
DS320STR	D-12	DT5012I	Z-20, E-6	FBMPFT	O-10, O-49, O-48	FT3Y25	V-6
DS320STW	D-12	DT5012LA	Z-20, E-6	FBMPMAAP	O-10, O-49, O-48	FT3Y5	V-6
DS320W	D-15	DT5012W	Z-20, E-6	FBMPREC	O-10, O-49, O-48	FT4BK25	V-6
DS320WLV	D-17	DT5030I	Z-20, E-6	FBMPSIEMONCT	O-10	FT4BK5	V-6
DS420	D-15	DT5030LA	Z-20, E-6	FBMPTRAC	O-10, O-49, O-48	FT4GY25	V-6
DS420BK	D-15						

Catalog Number Index

Catalog Number	Page	Catalog Number	Page	Catalog Number	Page	Catalog Number	Page
FT4Y25	V-6	GFP302501P	K-21	GFR15GRY	K-5	GFRST20	O-33
FT4Y5	V-6	GFP302501P25	K-21	GFR15I	K-5	GFRST20B	K-5
FTT1	V-6	GFP315A	AA-42	GFR15LA	K-5	GFRST20BKB	K-5
FTT2	V-6	GFP3305	K-19	GFR15R	K-5	GFRST20BKNL	K-5
FW60100	G-35, G-28, H-13, AA-24, AA-20, AA-21	GFP3315	K-19	GFR15W	K-5	GFRST20BKU	K-5
FW6010055	G-35, G-28	GFP5305	K-19	GFR20	K-5	GFRST20GY	I-4
G1038	W-88	GFP5315	K-19	GFR20BLK	K-5	GFRST20GYB	K-5
G1038R1200	W-88	GFP6C15M	AA-42	GFR20GRY	K-5	GFRST20GYNL	K-5
G1050	W-88	GFP8305	K-19	GFR20I	K-5	GFRST20GYU	K-5
G1050R1000	W-88	GFP8315	K-19	GFR20LA	K-5	GFRST20I3	K-5
G1075	W-88	GFPILST15125A	K-16	GFR20R	K-5	GFRST20IB	K-5
G1075R500	W-88	GFPILST15125M	K-16	GFR20W	K-5	GFRST20IINL	K-5
G1100	W-88	GFPILST15125TRIA	K-16	GFR82	L-15, K-6	GFRST20IU	K-5
G1100R500	W-88	GFPILST15125TRIM	K-16	GFR82BLK	L-15, K-6	GFRST20LA3	K-5
G1125	W-88	GFPILST20125LKA	K-16	GFR82GRY	L-15, K-6	GFRST20LAB	K-5
G1150	W-88	GFPILST20125LKM	K-16	GFR82I	L-15, K-6	GFRST20LANL	K-5
G1200	W-88	GFPILST20250LKA	K-16	GFR82LA	L-15, K-6	GFRST20LAU	K-5
GFBFHP20	K-8	GFPILST20250LKM	K-16	GFR82R	L-15, K-6	GFRST20NL	K-5
GFBFHP20BK	K-8	GFPILST30125LKA	K-19	GFR82W	L-15, K-6	GFRST20RB	K-5
GFBFHP20GY	K-8	GFPILST30125LKM	K-19	GFR83	L-15, K-6	GFRST20RNL	K-5
GFBFHP20I	K-8	GFPILST30250LKA	K-19	GFR83BLK	L-15, K-6	GFRST20RU	K-5
GFBFHP20LA	K-8	GFPILST30250LKM	K-19	GFR83GRY	L-15, K-6	GFRST20SNAP	A-18
GFBFHP20R	K-8	GFPST100C15WWM	K-15	GFR83I	L-15, K-6	GFRST20SNAPBK	A-18
GFBFHP20W	K-8	GFPST1301	K-19	GFR83LA	L-15, K-6	GFRST20SNAPBKNA	K-5
GFBFST20	K-5	GFPST1302	K-19	GFR83R	L-15, K-6	GFRST20SNAPGY	A-18
GFBFST20BK	K-5	GFPST1303	K-19	GFR83W	L-15, K-6	GFRST20SNAPGYNA	K-5
GFBFST20GY	K-5	GFPST1305	K-19	GFRST15	O-33	GFRST20SNAPI	A-18
GFBFST20I	K-5	GFPST1311	K-19	GFRST15B	K-5	GFRST20SNAPINA	K-5
GFBFST20LA	K-5	GFPST1312	K-19	GFRST15BKB	K-5	GFRST20SNAPLA	A-18
GFBFST20R	K-5	GFPST1313	K-19	GFRST15BKNL	K-5	GFRST20SNAPLANA	K-5
GFBFST20W	K-5	GFPST1315	K-19	GFRST15BKU	K-5	GFRST20SNAPNA	K-5
GFHW13005	K-18	GFPST15LA	K-16	GFRST15GYB	K-5	GFRST20SNAPR	A-18
GFHW13015	K-18	GFPST15LM	K-16	GFRST15GYNL	K-5	GFRST20SNAPRNA	K-5
GFHW13105	K-18	GFPST1C	K-13	GFRST15GYU	K-5	GFRST20SNAPW	A-18, X-15
GFHW13115	K-18	GFPST2301	K-19	GFRST15I	AA-42	GFRST20SNAPWNA	K-5
GFHW23005	K-18	GFPST2302	K-19	GFRST15I3	K-5	GFRST20U	K-5
GFHW23015	K-18	GFPST2311	K-19	GFRST15IB	K-5	GFRST20W3	K-5
GFHW23105	K-18	GFPST2312	K-19	GFRST15INL	K-5	GFRST20WB	K-5
GFHW23115	K-18	GFPST25C15A	K-15	GFRST15IU	K-5	GFRST20WNL	K-5
GFHW33015	K-18	GFPST25C15M	K-15	GFRST15LA	AA-42	GFRST20WU	K-5
GFHW33115	K-18	GFPST25CA	K-16	GFRST15LA3	K-5	GFRST52MI	AA-42
GFHW430	K-18	GFPST25CM	K-16	GFRST15LAB	K-5	GFRST52MLA	AA-42
GFHW431	K-18	GFPST25TTA	K-16	GFRST15LANL	K-5	GFRST52MW	AA-42
GFHW530	K-18	GFPST25TTM	K-16	GFRST15LAU	K-5	GFRST82B	L-15, K-6
GFHW531	K-18	GFPST2CA	K-16	GFRST15NL	K-5	GFRST82BKB	L-15, K-6
GFHW83105	K-18	GFPST2CM	K-16	GFRST15RB	K-5	GFRST82BKNL	L-15, K-6
GFHW86108	K-21	GFPST2TTA	K-16	GFRST15RNL	K-5	GFRST82BKU	L-15, K-6
GFMST20	K-17, H-13	GFPST2TTM	K-16	GFRST15RU	K-5	GFRST82GYB	L-15, K-6
GFMST20A	K-17	GFPST35LA	K-16	GFRST15SNAP	A-18	GFRST82GYNL	L-15, K-6
GFP15M	K-17, AA-42	GFPST35LM	K-16	GFRST15SNAPBK	A-18	GFRST82GYU	L-15, K-6
GFP201251P	K-21	GFPST3C15MTL	K-15	GFRST15SNAPBKNA	K-5	GFRST82IB	L-15, K-6
GFP201251P25	K-21	GFPST3C20M	K-15	GFRST15SNAPGY	A-18	GFRST82INL	L-15, K-6
GFP202081P	K-21	GFPST3C20MTL	K-15	GFRST15SNAPGYNA	K-5	GFRST82IU	L-15, K-6
GFP202081P25	K-21	GFPST4305	K-19	GFRST15SNAPI	A-18	GFRST82LAB	L-15, K-6
GFP202501P	K-21	GFPST4315	K-19	GFRST15SNAPINA	K-5	GFRST82LANL	L-15, K-6
GFP202501P25	K-21	GFPST4C15A	K-15	GFRST15SNAPLA	A-18	GFRST82LAU	L-15, K-6
GFP20FWM	K-16	GFPST4C15M	K-15	GFRST15SNAPLANA	K-5	GFRST82NL	L-15, K-6
GFP20M	K-17	GFPST50C15WWM	K-15	GFRST15SNAPNA	K-5	GFRST82RB	L-15, K-6
GFP25C15M	AA-42	GFPST515A	K-13	GFRST15SNAPNA	A-18	GFRST82RNL	L-15, K-6
GFP301251P	K-21	GFPST515M	K-13	GFRST15SNAPRNA	K-5	GFRST82RU	L-15, K-6
GFP301251P25	K-21	GFPST5266C	K-13	GFRST15SNAPRNA	A-18, X-15	GFRST82U	L-15, K-6
GFP302081P	K-21	GFPST5266CY	K-13	GFRST15SNAPWNA	K-5	GFRST82WB	L-15, K-6
GFP302081P25	K-21	GFPST6C15A	K-15	GFRST15U	K-5	GFRST82WNL	L-15, K-6
GFP302083P	K-21	GFPST6C15M	K-15	GFRST15W	AA-42	GFRST82WU	L-15, K-6
GFP302083P25	K-21	GFPSTOEMA	K-15	GFRST15W3	K-5	GFRST83B	L-15, K-6
GFP302403P	K-21	GFPSTOEMM	K-15	GFRST15WB	K-5	GFRST83BKB	L-15, K-6
GFP302403P25	K-21	GFR15	K-5	GFRST15WNL	K-5	GFRST83BKNL	L-15, K-6
		GFR15BLK	K-5	GFRST15WU	K-5	GFRST83BKU	L-15, K-6

Catalog Number Index

Catalog Number	Page	Catalog Number	Page	Catalog Number	Page	Catalog Number	Page
GFRST83GY	I-4	GFRWR20GRY	K-8	GFRST20BK	Z-8	GFTWRST15RIG	Z-8, K-7
GFRST83GYB	L-15, K-6	GFRWR20I	K-8	GFRST20BKB	K-4, Z-8	GFTWRST15RU	K-7
GFRST83GYNL	L-15, K-6	GFRWR20LA	K-8	GFRST20BKNL	K-4, Z-8	GFTWRST15SNAP	A-18
GFRST83GYU	L-15, K-6	GFRWR20R	K-8	GFRST20GY	Z-8	GFTWRST15SNAPBK	A-18
GFRST83IB	L-15, K-6	GFRWR20W	K-8	GFRST20GYB	K-4, Z-8	GFTWRST15SNAPGY	A-18
GFRST83INL	L-15, K-6	GFSG5262	K-3	GFRST20GYNL	K-4, Z-8	GFTWRST15SNAPI	A-18
GFRST83IU	L-15, K-6	GFSG5262BLK	K-3	GFRST20I	Z-8	GFTWRST15SNAPLA	A-18
GFRST83LAB	L-15, K-6	GFSG5262GRY	K-3	GFRST20I3	K-4	GFTWRST15SNAPR	A-18
GFRST83LANL	L-15, K-6	GFSG5262I	K-3, AA-42	GFRST20IB	K-4, Z-8	GFTWRST15SNAPW	A-18, X-15
GFRST83LAU	L-15, K-6	GFSG5262R	K-3	GFRST20INL	K-4, Z-8	GFTWRST15U	K-7
GFRST83NL	L-15, K-6	GFSG5262W	K-3, AA-42	GFRST20LA	Z-8	GFTWRST15W	Z-8
GFRST83RB	L-15, K-6	GFSG5362	K-3	GFRST20LA3	K-4	GFTWRST15WIG	Z-8, K-7
GFRST83RNL	L-15, K-6	GFSG5362BLK	K-3	GFRST20LAB	K-4, Z-8	GFTWRST15WU	K-7
GFRST83RU	L-15, K-6	GFSG5362GRY	K-3	GFRST20LANL	K-4, Z-8	GFTWRST20	Z-8
GFRST83U	L-15, K-6	GFSG5362I	K-3	GFRST20NL	K-4, Z-8	GFTWRST20AL	Z-8
GFRST83WB	L-15, K-6	GFSG5362R	K-3	GFRST20R	Z-8	GFTWRST20ALIG	Z-8
GFRST83WNL	L-15, K-6	GFSG5362W	K-3	GFRST20RB	K-4, Z-8	GFTWRST20BK	Z-8
GFRST83WU	L-15, K-6	GFSG8200	L-12, K-3	GFRST20RNL	K-4, Z-8	GFTWRST20BKIG	Z-8, K-7
GFRTR15	K-4	GFSG8200BLK	L-12, K-3	GFRST20W	Z-8	GFTWRST20BKU	K-7
GFRTR15BLK	K-4	GFSG8200GRY	L-12, K-3	GFRST20W3	K-4	GFTWRST20GY	Z-8
GFRTR15GRY	K-4	GFSG8200I	L-12, K-3	GFRST20WB	K-4, Z-8	GFTWRST20GYIG	Z-8, K-7
GFRTR15I	K-4	GFSG8200R	L-12, K-3	GFRST20WNL	K-4, Z-8	GFTWRST20GYU	K-7
GFRTR15LA	K-4	GFSG8200W	L-12, K-3	GFRST82B	K-4, L-13	GFTWRST20I	Z-8
GFRTR15R	K-4	GFSG8300	L-12, K-3	GFRST82BKB	K-4, L-13	GFTWRST20IG	Z-8, K-7
GFRTR15W	K-4	GFSG8300BLK	L-12, K-3	GFRST82BKNL	K-4, L-13	GFTWRST20IIG	Z-8, K-7
GFRTR20	K-4	GFSG8300GRY	L-12, K-3	GFRST82GYB	K-4, L-13	GFTWRST20IU	K-7
GFRTR20BLK	K-4	GFSG8300I	L-12, K-3	GFRST82GYNL	K-4, L-13	GFTWRST20LA	Z-8
GFRTR20GRY	K-4	GFSG8300R	L-12, K-3	GFRST82IB	K-4, L-13	GFTWRST20LAIG	Z-8, K-7
GFRTR20I	K-4	GFSG8300W	L-12, K-3	GFRST82INL	K-4, L-13	GFTWRST20LAU	K-7
GFRTR20LA	K-4	GFSMCB120240203P	K-12	GFRST82LAB	K-4, L-13	GFTWRST20ORIG	K-7
GFRTR20R	K-4	GFSMCB120401P	K-12	GFRST82LANL	K-4, L-13	GFTWRST20R	Z-8
GFRTR20W	K-4	GFSMST120A	K-12	GFRST82NL	K-4, L-13	GFTWRST20ORIG	Z-8, K-7
GFRTW15	K-7	GFSPST15I	K-4, Z-8	GFRST82RB	K-4, L-13	GFTWRST20RU	K-7
GFRTW15BLK	K-7	GFSPST15LA	K-4, Z-8	GFRST82RNL	K-4, L-13	GFTWRST20SNAP	A-18
GFRTW15GRY	K-7	GFSPST15W	K-4, Z-8	GFRST82WB	K-4, L-13	GFTWRST20SNAPBK	A-18
GFRTW15I	K-7	GFT2G	K-17, AA-40, BB-3	GFRST82WNL	K-4, L-13	GFTWRST20SNAPGY	A-18
GFRTW15LA	K-7	GFRST15	Z-8	GFRST83B	K-4, L-13	GFTWRST20SNAPI	A-18
GFRTW15R	K-7	GFRST15AL	Z-8	GFRST83BKB	K-4, L-13	GFTWRST20SNAPLA	A-18
GFRTW15W	K-7	GFRST15ALB	Z-8	GFRST83BKNL	K-4, L-13	GFTWRST20SNAPR	A-18
GFRTW20	K-7	GFRST15ALNL	Z-8	GFRST83GYB	K-4, L-13	GFTWRST20SNAPW	A-18, X-15
GFRTW20BLK	K-7	GFRST15B	K-4, Z-8	GFRST83GYNL	K-4, L-13	GFTWRST20U	K-7
GFRTW20I	K-7	GFRST15BK	Z-8	GFRST83IB	K-4, L-13	GFTWRST20W	Z-8
GFRTW20LA	K-7	GFRST15BKB	K-4, Z-8	GFRST83INL	K-4, L-13	GFTWRST20WIG	Z-8, K-7
GFRTW20R	K-7	GFRST15BKNL	K-4, Z-8	GFRST83LAB	K-4, L-13	GFTWRST20WU	K-7
GFRTW20W	K-7	GFRST15GY	Z-8	GFRST83LANL	K-4, L-13	GFTWRST82BKIG	L-14, K-7
GFRTW82	L-14, K-7	GFRST15GYB	K-4, Z-8	GFRST83NL	K-4, L-13	GFTWRST82BKU	L-14, K-7
GFRTW82BLK	L-14, K-7	GFRST15GYNL	K-4, Z-8	GFRST83RNL	K-4, L-13	GFTWRST82GYIG	L-14, K-7
GFRTW82GRY	L-14, K-7	GFRST15I	Z-8	GFRST83RNL	K-4, L-13	GFTWRST82GYU	L-14, K-7
GFRTW82I	L-14, K-7	GFRST15I3	K-4	GFRST83WB	K-4, L-13	GFTWRST82IG	L-14, K-7
GFRTW82LA	L-14, K-7	GFRST15IB	K-4, Z-8	GFRST83WNL	K-4, L-13	GFTWRST82IIG	L-14, K-7
GFRTW82R	L-14, K-7	GFRST15INL	K-4, Z-8	GFTWRST15	Z-8	GFTWRST82IU	L-14, K-7
GFRTW82W	L-14, K-7	GFRST15LA	Z-8	GFTWRST15AL	Z-8	GFTWRST82LAIG	L-14, K-7
GFRTW83	L-14, K-7	GFRST15LA3	K-4	GFTWRST15ALIG	Z-8	GFTWRST82LAU	L-14, K-7
GFRTW83BLK	L-14, K-7	GFRST15LAB	K-4, Z-8	GFTWRST15BK	Z-8	GFTWRST82ORIG	L-14, K-7
GFRTW83GRY	L-14, K-7	GFRST15LANL	K-4, Z-8	GFTWRST15BKIG	Z-8, K-7	GFTWRST82RIG	L-14, K-7
GFRTW83I	L-14, K-7	GFRST15NL	K-4, Z-8	GFTWRST15BKU	K-7	GFTWRST82RU	L-14, K-7
GFRTW83LA	L-14, K-7	GFRST15R	Z-8	GFTWRST15GY	Z-8	GFTWRST82U	L-14, K-7
GFRTW83R	L-14, K-7	GFRST15RB	K-4, Z-8	GFTWRST15GYIG	Z-8, K-7	GFTWRST82WIG	L-14, K-7
GFRTW83W	L-14, K-7	GFRST15RNL	K-4, Z-8	GFTWRST15GYU	K-7	GFTWRST82WU	L-14, K-7
GFRWR15	K-8	GFRST15W	Z-8	GFTWRST15I	Z-8	GFTWRST83BKIG	L-14, K-7
GFRWR15BLK	K-8	GFRST15W3	K-4	GFTWRST15IG	Z-8, K-7	GFTWRST83BKU	L-14, K-7
GFRWR15GRY	K-8	GFRST15WB	K-4, Z-8	GFTWRST15IIG	Z-8, K-7	GFTWRST83GYIG	L-14, K-7
GFRWR15I	K-8	GFRST15WNL	K-4, Z-8	GFTWRST15IU	K-7	GFTWRST83GYU	L-14, K-7
GFRWR15LA	K-8	GFRST20	Z-8	GFTWRST15LA	Z-8	GFTWRST83IG	L-14, K-7
GFRWR15R	K-8	GFRST20AL	Z-8	GFTWRST15LAIG	Z-8, K-7	GFTWRST83IIG	L-14, K-7
GFRWR15W	K-8	GFRST20ALB	Z-8	GFTWRST15LAU	K-7	GFTWRST83IU	L-14, K-7
GFRWR20	K-8	GFRST20ALNL	Z-8	GFTWRST15ORIG	K-7	GFTWRST83LAIG	L-14, K-7
GFRWR20BLK	K-8	GFRST20B	K-4, Z-8	GFTWRST15R	Z-8	GFTWRST83LAU	L-14, K-7

Catalog Number Index

Catalog Number	Page	Catalog Number	Page	Catalog Number	Page	Catalog Number	Page
GFTWRST83ORIG	L-14, K-7	H3009	W-90	HBL1201LG	D-3	HBL1221GY	D-3
GFTWRST83RIG	L-14, K-7	H30091	W-90	HBL1201LI	D-3	HBL1221I	D-3
GFTWRST83RU	L-14, K-7	H320B	A-44, A-68	HBL1201LW	D-3	HBL1221IHCS	D-6
GFTWRST83U	L-14, K-7	H320BL	A-44	HBL1201PL	D-4	HBL1221IL	AA-44, D-4
GFTWRST83WIG	L-14, K-7	H320C	A-44, A-68	HBL1201R	D-3	HBL1221ILC	D-4
GFTWRST83WU	L-14, K-7	H320P	A-44, A-68	HBL1201ST	D-11	HBL1221ILR	D-4
H038	W-90	H320R	A-44, A-68	HBL1201STBK	D-11	HBL1221L	D-3
H0381	W-90	H320RRT	A-44	HBL1201STGY	D-11	HBL1221LA	D-3
H0384	W-90	H350	W-90	HBL1201STI	D-11	HBL1221LG	D-3
H03841	W-90	H3501	W-90	HBL1201STIL	D-11	HBL1221LI	D-3
H0389	W-90	H400	W-90	HBL1201STILBK	D-11	HBL1221LW	D-3
H03891	W-90	H4001	W-90	HBL1201STILC	D-11	HBL1221PL	AA-44, I-4, D-4
H0389CNK	W-59, W-67	H4009	W-90	HBL1201STILGY	D-11	HBL1221PLC	D-4
H038CNK	W-59, W-67	H40091	W-90	HBL1201STILI	D-11	HBL1221PLG	D-4
H050	W-90	H660A	B-68	HBL1201STILLA	D-11	HBL1221R	D-3
H0501	W-90	H661A	B-68	HBL1201STILR	D-11	HBL1221RKL	D-3
H0504	W-90	H662A	B-68	HBL1201STILW	D-11	HBL1221ST	D-11
H05041	W-90	HBL100AITSS	AA-31	HBL1201STILA	D-11	HBL1221STBK	D-11
H0509	W-90	HBL100AITSSB	AA-31	HBL1201STR	D-11	HBL1221STGY	D-11
H05091	W-90	HBL100AITW	AA-31	HBL1201STW	D-11	HBL1221STI	D-11
H0509CNK	W-59, W-67	HBL100RNB	F-5, G-23, F-11	HBL1201W	D-3	HBL1221STIL	D-11
H050CNK	W-59, W-67	HBL100SPF	H-18	HBL1202	D-3	HBL1221STILBK	D-11
H075	W-90	HBL100SPFR	H-18	HBL1202I	D-3	HBL1221STILC	D-11
H0751	W-90	HBL100SPFRRT	H-18	HBL1202L	D-3	HBL1221STILGY	D-11
H0754	W-90	HBL100SPM	H-18	HBL1202LG	D-3	HBL1221STILI	D-11
H07541	W-90	HBL100SPMR	H-18	HBL1202LI	D-3	HBL1221STILLA	D-11
H0759	W-90	HBL100SPMRRT	H-18	HBL1202LW	D-3	HBL1221STILR	D-11
H07591	W-90	HBL105GF	AA-29, AA-28	HBL1203	D-3	HBL1221STILW	D-11
H0759CNK	W-59, W-67	HBL106SPF	H-18	HBL1203BK	D-3	HBL1221STILA	D-11
H075CNK	W-59, W-67	HBL106SPFR	H-18	HBL1203GY	D-3	HBL1221STR	D-11
H100	W-90	HBL106SPFRRT	H-18	HBL1203I	D-3	HBL1221STW	D-11
H1001	W-90	HBL106SPM	H-18	HBL1203IL	D-4	HBL1221W	D-3
H1004	W-90	HBL106SPMR	H-18	HBL1203L	D-3	HBL1221WHCS	D-6
H10041	W-90	HBL106SPMRRT	H-18	HBL1203LG	D-3	HBL1222	D-3
H1009	W-90	HBL10CM22S	AA-51	HBL1203LI	D-3	HBL1222BK	D-3
H10091	W-90	HBL10CM23S	AA-51	HBL1203LW	D-3	HBL1222GY	D-3
H1009CNK	W-59, W-67	HBL10CM35S	AA-51	HBL1203PL	D-4	HBL1222I	D-3
H100CNK	W-59, W-67	HBL10CM36S	AA-51	HBL1203ST	D-11	HBL1222L	D-3
H125	W-90	HBL10CM37S	AA-51	HBL1203STBK	D-11	HBL1222LA	D-3
H1251	W-90	HBL10CM41S	AA-51	HBL1203STGY	D-11	HBL1222LG	D-3
H1254	W-90	HBL10P120C	M-5	HBL1203STI	D-11	HBL1222LI	D-3
H12541	W-90	HBL10P120CM	M-5	HBL1203STIL	D-11	HBL1222LW	D-3
H1259	W-90	HBL10P160B	M-22, M-4	HBL1203STILBK	D-11	HBL1222PL	D-4
H12591	W-90	HBL10P160DB	M-4	HBL1203STILC	D-11	HBL1222R	D-3
H1259CNK	W-59, W-67	HBL10P320B	M-22, M-4	HBL1203STILGY	D-11	HBL1222RKL	D-3
H125CNK	W-59, W-67	HBL10P320DB	M-4	HBL1203STILI	D-11	HBL1222W	D-3
H150	W-90	HBL10SA40	M-7, M-22	HBL1203STILLA	D-11	HBL1223	D-3
H1501	W-90	HBL10W100C	M-22, M-6	HBL1203STILR	D-11	HBL1223BK	D-3
H1504	W-90	HBL11	D-23	HBL1203STILW	D-11	HBL1223GY	D-3
H15041	W-90	HBL112	BB-5	HBL1203STILA	D-11	HBL1223I	D-3
H1509	W-90	HBL118	D-23	HBL1203STR	D-11	HBL1223IL	AA-44, D-4
H15091	W-90	HBL11M	D-23	HBL1203STW	D-11	HBL1223ILC	D-4
H1509CNK	W-59, W-67	HBL11P160B	M-22, M-4	HBL1203W	D-3	HBL1223L	D-3
H150CNK	W-59, W-67	HBL11P320B	M-22	HBL1204	D-3	HBL1223LA	D-3
H200	W-90	HBL11PBWL	D-24	HBL1204BK	D-3	HBL1223LG	D-3
H2001	W-90	HBL11SA40	M-7, M-22	HBL1204GY	D-3	HBL1223LI	D-3
H2004	W-90	HBL11SP	D-23	HBL1204I	D-3	HBL1223LW	D-3
H20041	W-90	HBL11SPM	D-23	HBL1204L	D-3	HBL1223PL	AA-44, D-4
H2009	W-90	HBL11W100C	M-22, M-6	HBL1204LG	D-3	HBL1223PLC	D-4
H20091	W-90	HBL11WL	D-23	HBL1204LI	D-3	HBL1223R	D-3
H2009CNK	W-59, W-67	HBL12	D-23	HBL1204LW	D-3	HBL1223RKL	D-3
H200CNK	W-59, W-67	HBL1201	D-3	HBL1204W	D-3	HBL1223ST	D-11
H250	W-90	HBL1201BK	D-3	HBL1209	D-5, D-3, D-4	HBL1223STBK	D-11
H2501	W-90	HBL1201GY	D-3	HBL1209RKL	D-3	HBL1223STGY	D-11
H2509	W-90	HBL1201I	D-3	HBL1220RJ	D-18	HBL1223STI	D-11
H25091	W-90	HBL1201IL	D-4	HBL1221	D-3	HBL1223STIL	D-11
H300	W-90	HBL1201L	D-3	HBL1221BK	D-3	HBL1223STILBK	D-11
H3001	W-90	HBL1201LA	D-3	HBL1221GHCS	D-6	HBL1223STILC	D-11

Catalog Number Index

Catalog Number	Page	Catalog Number	Page	Catalog Number	Page	Catalog Number	Page
HBL1223STILGY	D-11	HBL13R22	F-26, F-19, F-25	HBL15FBW	H-4	HBL15NCC	H-3
HBL1223STILI	D-11	HBL13R23	F-26, F-19, F-25	HBL15FCAPBK	H-3	HBL15NCGN	H-3
HBL1223STILLA	D-11	HBL13R89	F-26, F-19, F-25	HBL15FCAPBL	H-3	HBL15NCO	H-3
HBL1223STILR	D-11	HBL13R90	F-25	HBL15FCAPGN	H-3	HBL15NCR	H-3
HBL1223STILW	D-11	HBL13R92	F-26, F-19, F-25	HBL15FCAPR	H-3	HBL15NCW	H-3
HBL1223STILA	D-11	HBL13S33D	F-28, F-26, F-19	HBL15FCAPW	H-3	HBL15NCY	H-3
HBL1223STR	D-11	HBL13X33D	F-28, F-26, F-19	HBL15FGN	H-3	HBL15PK	H-4
HBL1223STW	D-11	HBL142SJ100PS	H-16	HBL15FGY	H-3	HBL15PTBK	H-4
HBL1223W	D-3	HBL1433	A-38	HBL15FO	H-3	HBL15PTBL	H-4
HBL1224	D-3	HBL143SJ100PS	H-16	HBL15FR	H-3	HBL15PTGN	H-4
HBL1224BK	D-3	HBL1447	A-38	HBL15FRBK	H-3	HBL15PTR	H-4
HBL1224GY	D-3	HBL14W33	A-38	HBL15FRBL	H-3	HBL15PTW	H-4
HBL1224I	D-3	HBL14W33A	A-38, C-6	HBL15FRBN	H-3	HBL15RCF	H-4
HBL1224L	D-3	HBL14W33AWC	C-6	HBL15FRGN	H-3	HBL15RCM	H-4
HBL1224LA	D-3	HBL14W47	A-38	HBL15FRGY	H-3	HBL15RS	H-4
HBL1224LG	D-3	HBL14W47A	A-38, C-6	HBL15FRO	H-3	HBL15TBK	H-4
HBL1224LI	D-3	HBL14W47AWC	C-6	HBL15FRR	H-3	HBL15TBL	H-4
HBL1224LW	D-3	HBL14W47BK	C-6	HBL15FRSBK	H-3	HBL15TGN	H-4
HBL1224R	D-3	HBL14W47IN	C-8	HBL15FRSBL	H-3	HBL15TR	H-4
HBL1224RKL	D-3	HBL14W48	C-6	HBL15FRSBN	H-3	HBL15TS25	H-4
HBL1224W	D-3	HBL14W49	C-6	HBL15FRSGN	H-3	HBL15TS375	H-4
HBL123	D-23	HBL1533	A-39	HBL15FRSO	H-3	HBL15TW	H-4
HBL123MM	D-23	HBL1547	A-39	HBL15FRSR	H-3	HBL15W33	A-39
HBL123SJ100PS	H-16	HBL1556	D-4	HBL15FRSW	H-3	HBL15W33A	C-6, A-39
HBL123SJ100PT	H-16	HBL1556GY	D-4	HBL15FRSY	H-3	HBL15W33AWC	C-6
HBL123SP	D-23	HBL1556I	D-4	HBL15FRW	H-3	HBL15W47	A-39
HBL123SPMM	D-23	HBL1556L	D-4	HBL15FRY	H-3	HBL15W47A	C-6, A-39
HBL1259I	D-5	HBL1556LA	D-4	HBL15FW	H-3	HBL15W47AWC	C-6
HBL1281	D-5, AA-44	HBL1556LG	D-4	HBL15FY	H-3	HBL15W47BK	C-6
HBL1281I	D-5, AA-44	HBL1556LI	D-4	HBL15M	H-4	HBL15W47IN	C-8
HBL1281MC	D-5	HBL1556LW	D-4	HBL15MBBK	H-4	HBL15W48	C-6
HBL1281MO	D-5	HBL1556R	D-4	HBL15MBBL	H-4	HBL15W49	C-6
HBL1282	D-5	HBL1556W	D-4	HBL15MBGN	H-4	HBL160M120B	M-4
HBL1282I	D-5	HBL1557	D-4	HBL15MBK	H-3	HBL160M347B	M-4
HBL1283	D-5, AA-44	HBL1557	D-4	HBL15MBL	H-3	HBL160M480B	M-4
HBL1283I	D-5, AA-44	HBL1557GY	D-4	HBL15MBN	H-3	HBL16INR	J-6
HBL1284	D-5	HBL1557GYLV	D-17	HBL15MBR	H-4	HBL16LEDR	J-6
HBL1284I	D-5	HBL1557I	D-4	HBL15MBW	H-4	HBL16PB	J-5
HBL1287I	D-5	HBL1557ILV	D-17	HBL15MCAPBK	H-3	HBL16R90	F-25
HBL1288I	D-5	HBL1557L	D-4	HBL15MCAPBL	H-3	HBL16R92D	F-27, F-19, F-25
HBL1297	D-5	HBL1557LA	D-4	HBL15MCAPGN	H-3	HBL16R93D	F-27, F-19, F-25
HBL1298	D-5	HBL1557LG	D-4	HBL15MCAPR	H-3	HBL16S63D	F-28, F-27, F-19
HBL1298I	D-5	HBL1557LG	D-4	HBL15MCAPW	H-3	HBL16X63D	F-28, F-27, F-19
HBL12SP	D-23	HBL1557LI	D-4	HBL15MGN	H-3	HBL1750	N-22, D-18
HBL1370	F-24	HBL1557LV	D-17	HBL15MGY	H-3	HBL1785	N-22, D-18
HBL1372	F-26, F-24, F-19	HBL1557RLV	D-17	HBL15MO	H-3	HBL1795	N-22, AA-44, D-18
HBL1379	F-26, F-24, F-19	HBL1557W	D-4	HBL15MR	H-3	HBL17CM50	N-22, AA-44, D-18
HBL1379D	F-24	HBL1557WLV	D-17	HBL15MRBK	H-3	HBL17CM85	N-22, D-18
HBL1381	D-4	HBL15BW	H-4	HBL15MRBL	H-3	HBL18201CN	D-5
HBL1381I	D-4	HBL15CF	H-4	HBL15MRBN	H-3	HBL18201ICN	D-5
HBL1382	D-4	HBL15DFBK	H-4	HBL15MRGN	H-3	HBL18201LCN	D-5
HBL1382I	D-4	HBL15DFBL	H-4	HBL15MRGY	H-3	HBL18201WCN	D-5
HBL1385	D-4	HBL15DFGN	H-4	HBL15MRO	H-3	HBL18203CN	D-5
HBL1385I	D-4	HBL15DFR	H-4	HBL15MRR	H-3	HBL18203ICN	D-5
HBL1385W	D-4	HBL15DFW	H-4	HBL15MRSBK	H-3	HBL18203LCN	D-5
HBL1386	D-4	HBL15DMBK	H-4	HBL15MRSBL	H-3	HBL18203WCN	D-5
HBL1386I	D-4	HBL15DMBL	H-4	HBL15MRSBN	H-3	HBL18204ICN	D-5
HBL1386L	D-4	HBL15DMGN	H-4	HBL15MRSGN	H-3	HBL18221CN	D-5
HBL1388	D-4	HBL15DMR	H-4	HBL15MRSO	H-3	HBL18221ICN	D-5
HBL1388I	D-4	HBL15DMW	H-4	HBL15MRSR	H-3	HBL18221WCN	D-5
HBL1389	F-26, F-24, F-19	HBL15F2	H-4	HBL15MRSW	H-3	HBL18223CN	D-5
HBL1389D	F-12, F-24	HBL15F4	H-4	HBL15MRSY	H-3	HBL18223ICN	D-5
HBL1389MQ5	I-8, F-13, F-19	HBL15FBBK	H-4	HBL15MRW	H-3	HBL18223WCN	D-5
HBL1389MQR	I-8, F-13, F-19	HBL15FBBL	H-4	HBL15MRY	H-3	HBL182S100LED	H-16
HBL1389MQR2	I-8, F-13, F-19	HBL15FBGN	H-4	HBL15MW	H-3	HBL182S20LED	H-16
HBL1390	F-24	HBL15FBK	H-3	HBL15MY	H-3	HBL182S20LEDH	H-16
HBL1392	F-26, F-24, F-19	HBL15FBL	H-3	HBL15NCBK	H-3	HBL182S50LED	H-16
HBL13R12	F-26, F-19, F-25	HBL15FBN	H-3	HBL15NCBL	H-3	HBL182S50LEDH	H-16
HBL13R13	F-26, F-19, F-25	HBL15FBR	H-4	HBL15NCBN	H-3		

Catalog Number Index

Catalog Number	Page	Catalog Number	Page	Catalog Number	Page	Catalog Number	Page
HBL18300FBK	H-10	HBL2006IV	S-12, S-11, S-48	HBL20GBA512GY	S-12, S-51	HBL2162STITR	A-20
HBL18300FBL	H-10	HBL2009GC	S-11, S-48	HBL20GBA512IV	S-12, S-51	HBL2162STLA	A-20
HBL18300FBN	H-10	HBL200HDL	F-15	HBL20GBA609GY	S-12, S-51	HBL2162STLATR	A-20
HBL18300FGN	H-10	HBL2010A2GY	S-12, S-11, S-48	HBL20GBA609IV	S-12, S-51	HBL2162STO	A-20
HBL18300FO	H-10	HBL2010A2IV	S-12, S-11, S-48	HBL20GBA612GY	S-12, S-51	HBL2162STOTR	A-20
HBL18300FR	H-10	HBL2010A3GY	S-12, S-11, S-48	HBL20GBA612IV	S-12, S-51	HBL2162STR	A-20
HBL18300FW	H-10	HBL2010A3IV	S-12, S-11, S-48	HBL20GBA618GY	S-12, S-51	HBL2162STRTR	A-20
HBL18300FY	H-10	HBL2010BGY	S-12, S-11, S-48	HBL20GBA618IV	S-12, S-51	HBL2162STTR	A-20
HBL18300MBK	H-10	HBL2010BIV	S-12, S-11, S-48	HBL20IG306GY	S-12, S-51	HBL2162STW	A-20
HBL18300MBL	H-10	HBL2011BRGY	S-12, S-10, S-48	HBL20IG306IV	S-12, S-51	HBL2162STWTR	A-20
HBL18300MBN	H-10	HBL2011BRIV	S-12, S-10, S-48	HBL20IG512GY	S-12, S-51	HBL2162WA	A-11
HBL18300MGN	H-10	HBL2011GY	S-48	HBL20IG512IV	S-12, S-51	HBL2172	A-59, L-4, A-9
HBL18300MO	H-10	HBL2011IV	S-48	HBL20IG606GY	S-12, S-51	HBL2172GY	L-4, A-9
HBL18300MR	H-10	HBL2015BRGY	S-12, S-10, S-48	HBL20IG606IV	S-12, S-51	HBL2172I	L-4, A-9
HBL18300MW	H-10	HBL2015BRIV	S-12, S-10, S-48	HBL20SPF	H-18	HBL2172LC2W	E-22
HBL18300MY	H-10	HBL2015GY	S-48	HBL20SPFC	H-18	HBL2172R	L-4, A-9
HBL18400FBK	H-10	HBL2015IV	S-48	HBL20SPFOEM	H-18	HBL2172ST	A-19
HBL18400FBL	H-10	HBL2017BRGY	S-10, S-48	HBL20SPFR	H-18	HBL2172STBK	A-19
HBL18400FBN	H-10	HBL2017BRIV	S-10, S-48	HBL20SPM	H-18	HBL2172STBKTR	A-19
HBL18400FGN	H-10	HBL2017TC	S-12, S-48	HBL20SPMC	H-18	HBL2172STBL	A-19
HBL18400FO	H-10	HBL2018BRGY	S-12, S-10, S-48	HBL20SPMOEM	H-18	HBL2172STBLTR	A-19
HBL18400FR	H-10	HBL2018BRIV	S-12, S-10, S-48	HBL20SPMR	H-18	HBL2172STGN	A-19
HBL18400FW	H-10	HBL2018CGY	S-48	HBL21	D-24	HBL2172STGNTR	A-19
HBL18400FY	H-10	HBL2018CIV	S-48	HBL2128	BB-4	HBL2172STGY	A-19
HBL18400MBK	H-10	HBL2030AP	B-54, C-4, G-28	HBL2129	BB-4	HBL2172STGYTR	A-19
HBL18400MBL	H-10	HBL20403	B-65	HBL21414B	B-65	HBL2172STI	A-19
HBL18400MBN	H-10	HBL20405	B-68, N-20, B-65, N-18	HBL21415B	B-64	HBL2172STITR	A-19
HBL18400MGN	H-10	HBL20406	N-20	HBL21420	B-65	HBL2172STLA	A-19
HBL18400MO	H-10	HBL20418	B-64	HBL21447	B-64	HBL2172STLATR	A-19
HBL18400MR	H-10	HBL20424B	B-68	HBL2152	A-59, O-33, A-11	HBL2172STO	A-19
HBL18400MW	H-10	HBL20425B	B-68	HBL2152BK	A-11	HBL2172STOTR	A-19
HBL18400MY	H-10	HBL20443	B-65	HBL2152GY	A-11	HBL2172STR	A-19
HBL189F	X-9	HBL20444B	B-65	HBL2152I	A-11	HBL2172STRTR	A-19
HBL189SM	X-9	HBL20445B	B-64	HBL2152ST	A-20	HBL2172STTR	A-19
HBL18FBBK	H-10	HBL20446	B-68, N-20, B-65, N-18	HBL2152STBK	A-20	HBL2172STW	A-19
HBL18FBBL	H-10	HBL20482GY	S-12, S-10, S-48	HBL2152STBKTR	A-20	HBL2172STWTR	A-19
HBL18FBBN	H-10	HBL20482IV	S-12, S-10, S-49	HBL2152STBL	A-20	HBL2172WA	L-4, A-9
HBL18FBGN	H-10	HBL2048GY	S-12, S-10, S-48	HBL2152STBLTR	A-20	HBL2182	L-4, A-9
HBL18FBO	H-10	HBL2048IV	S-12, S-10, S-49	HBL2152STGN	A-20	HBL2182GY	L-4, A-9
HBL18FBR	H-10	HBL2051HGY	S-11, S-48	HBL2152STGNTR	A-20	HBL2182I	L-4, A-9
HBL18FBW	H-10	HBL2051HIV	S-49, S-11	HBL2152STGY	A-20	HBL2182R	L-4, A-9
HBL18FBY	H-10	HBL2089EIV	S-49, S-11	HBL2152STGYTR	A-20	HBL2182ST	A-19
HBL18MBBK	H-10	HBL2089IV	S-49, S-11	HBL2152STI	A-20	HBL2182STBK	A-19
HBL18MBBL	H-10	HBL20C215GY	S-12, S-51	HBL2152STITR	A-20	HBL2182STBKTR	A-19
HBL18MBBN	H-10	HBL20C215IV	S-12, S-51	HBL2152STLA	A-20	HBL2182STBL	A-19
HBL18MBGN	H-10	HBL20C215UIV	Q-5, S-12	HBL2152STLATR	A-20	HBL2182STBLTR	A-19
HBL18MBO	H-10	HBL20C315GY	S-12, S-51	HBL2152STO	A-20	HBL2182STGN	A-19
HBL18MBR	H-10	HBL20C315IV	S-12, S-51	HBL2152STOTR	A-20	HBL2182STGNTR	A-19
HBL18MBW	H-10	HBL20GB306GY	S-12, S-51	HBL2152STR	A-20	HBL2182STGY	A-19
HBL18MBY	H-10	HBL20GB306GYTR	S-12	HBL2152STRTR	A-20	HBL2182STGYTR	A-19
HBL196	X-9	HBL20GB306IV	S-12, S-51	HBL2152STTR	A-20	HBL2182STI	A-19
HBL2000B5GY	S-10, S-48	HBL20GB306IVTR	S-12	HBL2152STW	A-20	HBL2182STITR	A-19
HBL2000B5IV	S-10, S-48	HBL20GB312UIV	Q-5, S-12	HBL2152STWTR	A-20	HBL2182STLA	A-19
HBL2000BCAGY	S-10, S-48	HBL20GB506GY	S-12, S-51	HBL2152WA	A-11	HBL2182STLATR	A-19
HBL2000BCAIV	S-10, S-48	HBL20GB506IV	S-12, S-51	HBL2162	O-33, A-11	HBL2182STO	A-19
HBL2000BCGY	S-10, S-48	HBL20GB512GY	S-12, S-51	HBL2162BK	A-11	HBL2182STOTR	A-19
HBL2000BCIV	S-10, S-48	HBL20GB512GYTR	S-12	HBL2162GY	A-11	HBL2182STR	A-19
HBL2000CAGY	S-10, S-48	HBL20GB512IV	S-12, S-51	HBL2162I	A-11	HBL2182STRTR	A-19
HBL2000CAIV	S-10, S-48	HBL20GB512IVTR	S-12	HBL2162ST	A-20	HBL2182STTR	A-19
HBL2000CGY	S-10, S-48	HBL20GB606GY	S-12, S-51	HBL2162STBK	A-20	HBL2182STW	A-19
HBL2000CIV	S-10, S-48	HBL20GB606IV	S-12, S-51	HBL2162STBKTR	A-20	HBL2182STWTR	A-19
HBL2000TFGY	S-11, S-48	HBL20GB609GY	S-12, S-51	HBL2162STBL	A-20	HBL2182WA	L-4, A-9
HBL2000TFIV	S-11, S-48	HBL20GB609IV	S-12, S-51	HBL2162STBLTR	A-20	HBL21CM28	AA-29, AA-28
HBL2000WC	S-11, S-48	HBL20GB612GY	S-12, S-51	HBL2162STGN	A-20	HBL21CM29	AA-29, AA-28
HBL2000WCA	S-11, S-48	HBL20GB612IV	S-12, S-51	HBL2162STGNTR	A-20	HBL21CM414B	B-65
HBL2001C	S-12, S-11, S-48	HBL20GB612UIV	Q-5, S-12	HBL2162STGY	A-20	HBL21CM415B	B-64
HBL2003SC	S-12, S-11, S-48	HBL20GB618GY	S-12, S-51	HBL2162STGYTR	A-20	HBL21SP	D-24
HBL2006GY	S-12, S-11, S-48	HBL20GB618IV	S-12, S-51	HBL2162STI	A-20	HBL22	D-24

Catalog Number Index

Catalog Number	Page	Catalog Number	Page	Catalog Number	Page	Catalog Number	Page
HBL223	D-24	HBL2321SW	B-41, C-3, B-20	HBL2400B10IV	S-49, S-14	HBL2425	N-19, B-22
HBL223MM	D-24	HBL2321VBK	B-20	HBL2400BCIV	S-49, S-14	HBL2425ST	B-22
HBL223SP	D-24	HBL2321VY	B-20	HBL2400BDIV	S-49, S-14	HBL2425SW	C-3, B-22
HBL223SPMM	D-24	HBL2323	B-21	HBL2400BIV	S-49, S-14	HBL2426	N-19, B-23
HBL2270	BB-4	HBL2323BK	B-21	HBL2400CIV	S-49, S-14	HBL2426IV	S-49, S-16
HBL2271	BB-4	HBL2323EBK	B-21	HBL2400DTFIV	S-49, S-15	HBL2426ST	B-23
HBL2274	BB-4	HBL2323ST	B-21	HBL2400TFIV	S-49, S-15	HBL2430	N-18, B-23
HBL22CM427	B-65	HBL2323STBK	B-21	HBL2400WC	S-49, S-15	HBL24300RKD	L-17
HBL22CM428	B-64	HBL2323SW	C-3, B-21	HBL2401C	S-49, S-15	HBL24300RKS	L-17
HBL22SP	D-24	HBL2323VBK	B-21	HBL2401DC	S-49, S-15	HBL2430AR	B-23
HBL23000G	B-63	HBL2323VY	B-21	HBL2406IV	S-49, S-15	HBL2430SR	B-23
HBL23000HG	L-17, N-18	HBL2325	N-19, B-20	HBL2409GC	S-49, S-15	HBL2430SR2	B-23
HBL23001HGB	L-17	HBL2325ST	B-20	HBL2410	N-18, O-33, B-23	HBL2430ST B-33, B-23, B-27, B-31, B-35	
HBL23002GB	B-63	HBL2325SW	C-3, B-20	HBL24106DRK	S-49, S-16	HBL2430SW	B-41, C-3, B-23
HBL23004HG	L-17	HBL2325SWR	B-20	HBL24106RRK	S-49, S-16	HBL2431	B-42, B-22
HBL23005GB	B-63	HBL2326	N-19, B-21	HBL2410AIV	S-49, S-15	HBL24312	L-17
HBL23007	B-63, B-62	HBL2326ST	B-21	HBL2410AR	B-23	HBL2431S	B-22
HBL23014HGB	L-17	HBL232MS	X-9	HBL2410BDIV	S-49, S-15	HBL2431ST	B-22
HBL23030	B-62, N-18	HBL232MSCM	X-9	HBL2410BIV	S-49, S-15	HBL2431STSW	B-41, C-3, B-22
HBL23032B	B-62, K-19	HBL232S	X-9	HBL2410CIV	S-49, S-15	HBL2433	B-23
HBL23035B	B-62, K-19	HBL232SCM	X-9	HBL2410DFOIV	S-49, S-15	HBL2433ST	B-23
HBL2310	O-33, B-21, N-18	HBL232SM	X-9	HBL2410FCIV	S-49, S-15	HBL2433SW	C-3, B-23
HBL2310AR	B-21	HBL2330	B-21, N-18	HBL2410RT	B-23	HBL2435	N-19, B-22
HBL2310M7	B-21	HBL2330AR	B-21	HBL2410SR	B-23	HBL2435ST	B-22
HBL2310RT	B-21	HBL2330SR	B-21, C-12	HBL2410SR2	B-23	HBL2435SW	C-3, B-22
HBL2310SR	B-21, C-12	HBL2330SR2	B-21	HBL2410ST B-33, B-23, B-27, B-31, B-35		HBL2436	N-19, B-23
HBL2310SR2	B-21	HBL2330SW	B-41, C-3, B-21	HBL2410SW	B-41, C-3, B-23	HBL2436ST	B-23
HBL2310ST B-35, B-33, B-27, B-31, B-21, B-23		HBL2331	B-42, B-20	HBL2411	B-42, B-22	HBL2440	B-25, N-18
HBL2310SW	B-41, C-3, H-13, B-21	HBL2331S	B-20	HBL2411BK	B-22	HBL2441	B-25
HBL2311	B-42, B-20	HBL2331ST	B-20	HBL2411DFOIV	S-49, S-14	HBL2443	B-25
HBL2311BK	B-20	HBL2331SW	B-41, C-3, B-20	HBL2411DIV	S-49, S-14	HBL24442IV	S-49, S-14
HBL2311EBK	B-20	HBL2331VBK	B-20	HBL2411S	B-22	HBL2444D2AIV	S-49, S-14
HBL2311VY	B-20	HBL2331VY	B-20	HBL2411ST	B-22	HBL2444DIVA	S-49, S-14
HBL2311S	B-20	HBL2333	B-21	HBL2411STBK	B-22	HBL2444IVA	S-49, S-14
HBL2311ST	B-20	HBL2333ST	B-21	HBL2411SW	B-41, C-3, B-22	HBL2445	B-25, N-19
HBL2311STBK	B-20	HBL2333SW	C-3, B-21	HBL2413	B-23	HBL2446	B-25, N-19
HBL2311SW	B-41, C-3, B-20	HBL2333VBK	B-21	HBL2413BK	B-23	HBL2447	B-12
HBL2311VBK	B-20	HBL2335	N-19, B-20	HBL2413ST	B-23	HBL24482IV	S-49, S-14
HBL2311VY	B-20	HBL2335ST	B-20	HBL2413STBK	B-23	HBL2448IVA	S-49, S-14
HBL2313	B-21	HBL2335SW	C-3, B-20	HBL2413SW	C-3, B-23	HBL244MSCM	X-9
HBL2313BK	B-21	HBL2336	N-19, B-21	HBL2415	N-19, B-22	HBL2450	B-25, N-18
HBL2313EBK	B-21	HBL2340	B-24, N-18	HBL2415DFOIV	S-49, S-14	HBL2451	B-25
HBL2313ST	B-21	HBL2340SW	B-24	HBL2415IV	S-49, S-14	HBL2451HIV	S-49, S-15
HBL2313STBK	B-21	HBL2341	B-42, B-24	HBL2415ST	B-22	HBL2453	B-25
HBL2313SW	C-3, B-21	HBL2341ST	B-24	HBL2415SW	C-3, B-22	HBL2455	B-25, N-19
HBL2313VBK	B-21	HBL2343	B-24	HBL2416	N-19, B-23	HBL2456	B-25, N-19
HBL2313VY	B-21	HBL2343ST	B-24	HBL2416ST	B-23	HBL2460	B-25, N-18
HBL2315	N-19, B-20	HBL2345	N-19, B-24	HBL2417DFOIV	S-49, S-14	HBL2461	B-25
HBL2315ST	B-20	HBL2345ST	B-24	HBL2417IV	S-49, S-14	HBL2463	B-25
HBL2315SW	C-3, B-20	HBL2346	N-19, B-24	HBL2418DFOIV	S-49, S-14	HBL2465	B-25, N-19
HBL2316	N-19, B-21	HBL2350	B-24	HBL2418IV	S-49, S-14	HBL2466	B-25, N-19
HBL2316ST	B-21	HBL2351	B-42, B-24	HBL2420	N-18, O-33, B-23	HBL2475DBRIV	S-49, S-15
HBL232	X-9	HBL2355	B-24	HBL2420AR	B-23	HBL2489IV	S-49, S-15
HBL2320	O-33, B-21, N-18	HBL2356	N-19, B-24	HBL2420REDIV	S-49, S-15	HBL248S	X-9
HBL2320AR	B-21	HBL2360	B-24	HBL2420RT	B-23	HBL242CM11	B-22
HBL2320M4	B-21	HBL2361	B-24	HBL2420SR	B-23	HBL242CM13	B-23
HBL2320RT	B-21	HBL2363	B-24	HBL2420SR2	B-23	HBL242CM21	B-22
HBL2320SR	B-21, C-12	HBL2365	B-24	HBL2420ST B-33, B-23, B-27, B-31, B-35		HBL242CM23	B-23
HBL2320SR2	B-21	HBL2366	B-24	HBL2420SW	B-41, C-3, B-23	HBL242CM31	B-22
HBL2320ST B-35, B-33, B-27, B-31, B-21, B-23		HBL23901HG	L-17	HBL2421	B-42, B-22	HBL242CM33	B-23
HBL2320SW	B-41, C-3, B-21	HBL23909HG	L-17	HBL2421S	B-22	HBL242DRK	S-49
HBL2321	B-42, B-20	HBL23CM10	AA-38, B-21, N-18	HBL2421ST	B-22	HBL24GB306GY	S-12, S-51
HBL2321BK	B-20	HBL23CM11	B-20, AA-38	HBL2421SW	B-41, C-3, B-22	HBL24GB306GYTR	S-12
HBL2321EBK	B-20	HBL23CM11V	B-20, AA-38	HBL2423	B-23	HBL24GB306IV	S-12, S-51
HBL2321S	B-20	HBL23CM13	AA-38, B-21	HBL2423ST	B-23	HBL24GB506GY	S-12, S-51
HBL2321ST	B-20	HBL23CM21	B-20	HBL2423SW	C-3, B-23	HBL24GB506IV	S-12, S-51
HBL2321STBK	B-20	HBL23CM23	B-21				

Catalog Number Index

Catalog Number	Page	Catalog Number	Page	Catalog Number	Page	Catalog Number	Page
HBL24GB512GY	S-12, S-51	HBL2531	B-26, B-42	HBL2616F	B-29	HBL2663	B-31
HBL24GB512GYTR	S-12	HBL2533	B-27	HBL2616ST	B-29	HBL2665	B-30
HBL24GB512IV	S-12, S-51	HBL2535	B-26, N-19	HBL2620	B-29, O-33, N-18	HBL26CM10	AA-5, B-29, AA-11, N-18
HBL24GB512IVTR	S-12	HBL2536	N-19, B-27	HBL2620AR	B-29	HBL26CM11	AA-11, B-28, AA-5
HBL24GB606GY	S-12, S-51	HBL25403	B-65	HBL2620M6	B-29	HBL26CM11V	B-28, AA-12
HBL24GB606IV	S-12, S-51	HBL25414B	B-65	HBL2620RT	B-29	HBL26CM11VB	AA-12
HBL24GB612GY	S-12, S-51	HBL25415B	B-64	HBL2620SR	B-29, C-12	HBL26CM13	AA-4, B-29, AA-11
HBL24GB612IV	S-12, S-51	HBL2547	B-13	HBL2620SR2	B-29	HBL26CM13V	B-29, AA-12
HBL24GB618GY	S-12, S-51	HBL254S	X-8	HBL2620ST	B-29, B-35, B-33, B-27, B-31, B-23	HBL26CM20	B-29
HBL24GB618IV	S-12, S-51	HBL254SCM	X-8	HBL2620SW	B-41, B-29, C-3, H-13	HBL26CM21	B-28
HBL24GBA512GY	S-12, S-51	HBL25503	L-18	HBL2621	B-28, B-42, K-19	HBL26CM23	B-29
HBL24GBA512IV	S-12, S-51	HBL25505	L-18	HBL2621BK	B-28	HBL26W08	C-7
HBL24GBA612GY	S-12, S-51	HBL25509	L-18	HBL2621EBK	B-28	HBL26W09	C-7
HBL24GBA612IV	S-12, S-51	HBL25515	L-18	HBL2621F	B-28	HBL26W47	C-7
HBL24GBA618GY	S-12, S-51	HBL25525	L-18	HBL2621S	B-28	HBL26W47BK	C-7
HBL24GBA618IV	S-12, S-51	HBL25603	L-18	HBL2621ST	B-28	HBL26W47WC	C-7
HBL24SRK	S-49	HBL25605	L-18	HBL2621STBK	B-28	HBL26W48	C-7
HBL24W34	C-6	HBL25615	L-18	HBL2621SW	B-28, C-3, B-41, K-19	HBL26W48BK	C-7
HBL24W34BK	C-6	HBL25625	L-18	HBL2621VBK	B-28	HBL26W49	C-7
HBL24W47	B-12	HBL257	X-8	HBL2621VBK	B-28	HBL26W74	C-7
HBL24W47A	C-6, C-7	HBL25CM11	B-26	HBL2621VY	B-28	HBL26W75	C-7
HBL24W47AWC	C-6	HBL25CM13	B-27	HBL2623	B-29, K-19	HBL26W75BK	C-7
HBL24W47BK	C-6	HBL25W34	C-6	HBL2623BK	B-29	HBL26W75IN	C-8
HBL24W47IN	C-8	HBL25W34BK	C-6	HBL2623EBK	B-29	HBL26W76	C-7
HBL24W49	C-6	HBL25W47	B-13	HBL2623F	B-29	HBL26W76BK	C-7
HBL2510	B-27, O-33, N-18	HBL25W47A	C-6, C-7	HBL2623ST	B-29	HBL26W76IN	C-8
HBL2510AR	B-27	HBL25W47AWC	C-6	HBL2623SW	B-29, C-3, K-19	HBL26W81	C-7
HBL2510SR	B-27	HBL25W47BK	C-6	HBL2623VBK	B-29	HBL26W81BK	C-7
HBL2510SR2	B-27	HBL25W49	C-6	HBL2623VY	B-29	HBL26W82	C-7
HBL2510ST	B-33, B-23, B-27, B-31, B-35	HBL260	X-13	HBL2625	B-28, N-19	HBL26W83	C-7
HBL2510SW	B-41, C-3, B-27	HBL2600	B-37	HBL2625F	B-28	HBL2710	B-31, O-33, N-18
HBL2511	B-26, B-42	HBL2601	B-37	HBL2625ST	B-28	HBL2710AR	B-31
HBL2511BK	B-26	HBL2603	B-37	HBL2625SW	B-28, C-3	HBL2710RT	B-31
HBL2511FC	B-26	HBL2605	B-37	HBL2626	B-29, N-19	HBL2710SR	B-31
HBL2511S	B-26	HBL260H	X-13	HBL2626F	B-29	HBL2710SR2	B-31
HBL2511ST	B-26	HBL2610	B-29, O-33, N-18	HBL2626ST	B-29	HBL2710ST	B-33, B-23, B-27, B-31, B-35
HBL2511STBK	B-26	HBL2610AR	B-29	HBL263	X-13	HBL2710SW	B-41, C-3, B-31
HBL2511SW	B-41, B-26, C-3	HBL2610M6	B-29	HBL2630	B-29, N-18	HBL2711	B-30, B-42
HBL2513	B-27	HBL2610RT	B-29	HBL2631	B-28, B-42	HBL2711BK	B-30
HBL2513BK	B-27	HBL2610SR	B-29, C-12	HBL2633	B-29	HBL2711S	B-30
HBL2513FC	B-27	HBL2610SR2	B-29	HBL2635	B-28, N-19	HBL2711ST	B-30
HBL2513ST	B-27	HBL2610ST	B-29, B-35, B-33, B-27, B-31, B-23	HBL2636	B-29, N-19	HBL2711STBK	B-30
HBL2513STBK	B-27	HBL2610ST	B-29, B-35, B-33, B-27, B-31, B-23	HBL2640	B-37, N-18	HBL2711SW	B-41, B-30, C-3
HBL2513SW	C-3, B-27	HBL2610SW	B-41, B-29, C-3	HBL26401	B-68, B-67	HBL2713	B-31
HBL2515	B-26, N-19	HBL2611	B-28, B-42	HBL26402	B-68, B-67	HBL2713BK	B-31
HBL2515ST	B-26	HBL2611BK	B-28	HBL26404	B-68, B-67	HBL2713SR	B-41, B-31, H-13
HBL2515SW	B-26, C-3	HBL2611F	B-28	HBL2641	B-42, B-37	HBL2713ST	B-31
HBL2516	N-19, B-27	HBL2611S	B-28	HBL26410	B-67	HBL2713STBK	B-31
HBL2516ST	B-27	HBL2611ST	B-28	HBL26418	B-67	HBL2713SW	C-3, B-31
HBL2516STBK	B-27	HBL2611STBK	B-28	HBL26419	B-66	HBL2715	B-30, N-19
HBL2520	B-27, N-18	HBL2611SW	B-28, C-3, B-41	HBL26420	B-67	HBL2715M3	B-30
HBL2520ST	B-33, B-23, B-27, B-31, B-35	HBL2611VBK	B-28	HBL26421	B-67	HBL2715ST	B-30
HBL2521	B-26, B-42	HBL2611VY	B-28	HBL26422	B-66	HBL2715SW	B-30, C-3
HBL2521ST	B-26	HBL2613	B-29	HBL2643	B-37	HBL2715SWR	B-41, B-30, H-13
HBL2523	B-27	HBL2613BK	B-29	HBL2645	N-19, B-37	HBL2716	N-19, B-31
HBL2523ST	B-27	HBL2613F	B-29	HBL2646	N-19, B-37	HBL2720	B-31, O-33, N-18
HBL2525	B-26, N-19	HBL2613SR	B-41, B-29	HBL2650	B-37, N-18	HBL2720AR	B-31
HBL25250	B-65	HBL2613ST	B-29	HBL2651	B-42, B-37	HBL2720RT	B-31
HBL2525ST	B-26	HBL2613SW	B-29, C-3	HBL26516	B-67	HBL2720SR	B-31
HBL2526	N-19, B-27	HBL2613VBK	B-29	HBL26519	B-66	HBL2720SR2	B-31
HBL2526ST	B-27	HBL2613VY	B-29	HBL26520	B-67	HBL2720ST	B-35, B-33, B-31, B-23
HBL252MS	X-8	HBL2615	B-28, N-19	HBL26521	B-67	HBL2720SW	B-41, C-3, B-31
HBL252MSCM	X-8	HBL2615F	B-28	HBL26522	B-66	HBL2721	B-30, B-42, B-39
HBL252S	X-8	HBL2615M3	B-28	HBL2653	B-37	HBL2721S	B-30
HBL252SCM	X-8	HBL2615ST	B-28	HBL2655	N-19, B-37	HBL2721ST	B-30
HBL2530	B-27, O-33, N-18	HBL2615SW	B-28, C-3	HBL2656	N-19, B-37	HBL2721SW	B-41, B-30, C-3
		HBL2615SWR	B-28, B-41	HBL2660	B-31		
		HBL2616	B-29, N-19	HBL2661	B-30		

Catalog Number Index

Catalog Number	Page	Catalog Number	Page	Catalog Number	Page	Catalog Number	Page
HBL2723	B-31	HBL27W47IN	C-8	HBL28CM11	B-34	HBL300MBL	H-6
HBL2723SR	B-41	HBL27W47WC	C-7	HBL28CM13	B-35	HBL300MBN	H-6
HBL2723ST	B-31	HBL27W48	C-7	HBL28W08	C-7	HBL300MGN	H-6
HBL2723SW	C-3, B-31	HBL27W48BK	C-7	HBL28W09	C-7	HBL300MO	H-6
HBL2725	B-30, N-19	HBL27W49	C-7	HBL28W47	C-7	HBL300MR	H-6
HBL2725ST	B-30	HBL27W74	C-7	HBL28W47BK	C-7	HBL300MW	H-6
HBL2725SW	B-30, C-3	HBL27W75	C-7	HBL28W48	C-7	HBL300MY	H-6
HBL2725SWR	B-41	HBL27W75BK	C-7	HBL28W49	C-7	HBL300RCF	H-8
HBL2726	N-19, B-31	HBL27W76	C-7	HBL28W74	C-7	HBL300RCM	H-8
HBL2730	B-33, N-18	HBL27W76BK	C-7	HBL28W75	C-7	HBL3010AEGY	S-19, S-49
HBL2730AR	B-33	HBL27W76IN	C-8	HBL28W75BK	C-7	HBL3010AEIV	S-19, S-49
HBL2730SR	B-33	HBL27W81	C-7	HBL28W75IN	C-8	HBL3010BGY	S-19, S-49
HBL2730SR2	B-33	HBL27W81BK	C-7	HBL28W76	C-7	HBL3010BIV	S-19, S-49
HBL2730ST	B-33, B-23, B-27, B-31, B-35	HBL27W82	C-7	HBL28W76BK	C-7	HBL3010CGY	S-19, S-49
HBL2730SW	B-41, B-33, C-3	HBL27W83	C-7	HBL28W76IN	C-8	HBL3010CIV	S-19, S-49
HBL2731	B-42, B-39, B-32	HBL2800	B-35	HBL28W77	C-7	HBL3011EGY	S-49
HBL2731S	B-32	HBL2801	B-34	HBL28W78	C-7	HBL3011EIV	S-49
HBL2731ST	B-32	HBL2803	B-35	HBL28W81	C-7	HBL3014CGY	S-19, S-49
HBL2731SW	B-41, C-3, B-32	HBL2805	B-34	HBL28W81BK	C-7	HBL3014CIV	S-19, S-49
HBL2733	B-33	HBL2810	N-18, O-33, B-35	HBL28W82	C-7	HBL3015EGY	S-49
HBL2733ST	B-33	HBL2810AR	B-35	HBL28W83	C-7	HBL3015EIV	S-49
HBL2733SW	B-33, C-3	HBL2810RT	B-35	HBL29W08	C-7	HBL3017TCEGY	S-18, S-49
HBL2735	N-19, B-32	HBL2810SR	B-35	HBL29W09	C-7	HBL3017TCEIV	S-18, S-49
HBL2735ST	B-32	HBL2810SR2	B-35	HBL29W47	C-7	HBL3018AEGY	S-18, S-49
HBL2735SW	C-3, B-32	HBL2810ST	B-33, B-23, B-27, B-31, B-35	HBL29W47BK	C-7	HBL3018AEIV	S-18, S-49
HBL2736	N-19, B-33	HBL2810SW	B-41, C-3, B-35	HBL29W48	C-7	HBL3027AEGY	S-49, S-20
HBL2736ST	B-33	HBL2811	B-34, B-42	HBL29W49	C-7	HBL3027AEIV	S-49, S-20
HBL2740	B-33, O-33, N-18	HBL2811BK	B-34	HBL29W74	C-7	HBL3028GY	S-18, S-49
HBL2740AR	B-33	HBL2811FC	B-34	HBL29W75	C-7	HBL3028IV	S-18, S-49
HBL2740SR	B-33	HBL2811S	B-34	HBL29W75BK	C-7	HBL3031	D-3
HBL2740SR2	B-33	HBL2811ST	B-34	HBL29W75IN	C-8	HBL3031I	D-3
HBL2740SW	B-41, B-33, C-3	HBL2811STBK	B-34	HBL29W76	C-7	HBL3031PL	D-4
HBL2741	B-42, B-32	HBL2811STBK	B-34	HBL29W76BK	C-7	HBL3032	D-3
HBL2741S	B-32	HBL2811SW	B-34, C-3, B-41	HBL29W76IN	C-8	HBL3032I	D-3
HBL2741SW	B-41, C-3, B-32	HBL2813	B-35	HBL29W77	C-7	HBL3032PL	D-4
HBL2743	B-33	HBL2813BK	B-35	HBL29W78	C-7	HBL3032W	D-3
HBL2743SW	B-33, C-3	HBL2813FC	B-35	HBL29W81	C-7	HBL3033	D-3
HBL2745	N-19, B-32	HBL2813ST	B-35	HBL29W81BK	C-7	HBL3033I	D-3
HBL2745SW	C-3, B-32	HBL2813STBK	B-35	HBL29W82	C-7	HBL3033JEGY	S-49, S-20
HBL2746	N-19, B-33	HBL2813SW	C-3, B-35	HBL29W83	C-7	HBL3033JEIV	S-49, S-20
HBL2750	B-36, N-18	HBL2815	B-34, N-19	HBL3000	S-67, S-49, C-11	HBL3033HEGY	S-49, S-20
HBL2751	B-36	HBL2815ST	B-34	HBL3000BGY	S-18, S-49	HBL3036HEIV	S-49, S-20
HBL2753	B-36	HBL2815SW	B-34, C-3	HBL3000BIV	S-18, S-49	HBL3036INT	AA-10
HBL2755	B-36, N-19	HBL2816	N-19, B-35	HBL3000C075GY	S-49	HBL303NM	AA-4, AA-10
HBL2756	B-36, N-19	HBL2816ST	B-35	HBL3000C075IV	S-49	HBL303NMELCI	AA-7
HBL2760	B-36, N-18	HBL2816STBK	B-35	HBL3000C195GY	S-49	HBL303NMELCIS	AA-7
HBL2761	B-36	HBL2820	N-18, B-35	HBL3000C195IV	S-49	HBL303SS	AA-4, AA-10
HBL2763	B-36	HBL2820ST	B-33, B-23, B-27, B-31, B-35	HBL3000CEGY	S-18, S-49	HBL303SSELCI	AA-7
HBL2765	B-36, N-19	HBL2820SW	B-41	HBL3000CEIV	S-18, S-49	HBL303SSELICIS	AA-7
HBL2766	B-36, N-19	HBL2821	B-34, B-42	HBL3000TFGY	S-19, S-49	HBL303SSO	AA-10
HBL2770	B-36, N-18	HBL2821ST	B-34	HBL3000TFIV	S-19, S-49	HBL3040CEGY	S-49, S-20
HBL2771	B-36	HBL2821SW	B-34, B-41	HBL3000WCGY	S-19, S-49	HBL3040CEIV	S-49, S-20
HBL2773	B-36	HBL2823	B-35	HBL3001AGY	S-19, S-49	HBL3043BEGY	S-49, S-20
HBL2775	B-36, N-19	HBL2823ST	B-35	HBL3001GY	S-19, S-49	HBL3043BEIV	S-49, S-20
HBL2776	B-36, N-19	HBL2823SW	B-35	HBL3003GY	S-19, S-49	HBL30442GY	S-18, S-49
HBL27CM11	B-30	HBL2825	B-34, N-19	HBL3003IV	S-19, S-49	HBL30442IV	S-18, S-49
HBL27CM13	B-31	HBL2825ST	B-34	HBL3006EGY	S-19, S-49	HBL3046BEGY	S-49, S-20
HBL27CM21	B-30	HBL2826	N-19, B-35	HBL3006EIV	S-19, S-49	HBL3046BEIV	S-49, S-20
HBL27CM23	B-31	HBL2826ST	B-35	HBL3007CGY	S-49, S-20	HBL3046H2GY	S-19, S-49
HBL27CM31	B-32	HBL2830	N-18, O-33, B-35	HBL300FBK	H-6	HBL3046H2IV	S-19, S-49
HBL27CM33	B-33	HBL2830SW	B-41	HBL300FBL	H-6	HBL3048RGY	S-49, S-20
HBL27CM41	B-32	HBL2831	B-34, B-42	HBL300FBN	H-6	HBL3048RIV	S-49, S-20
HBL27CM43	B-33	HBL2831SW	B-34, B-41	HBL300FGN	H-6	HBL3051	C-11
HBL27W08	C-7	HBL2833	B-35	HBL300FO	H-6	HBL3051LEGY	S-49, S-20
HBL27W09	C-7	HBL2835	B-34, N-19	HBL300FR	H-6	HBL3051LEIV	S-49, S-20
HBL27W47	C-7	HBL2836	N-19, B-35	HBL300FW	H-6	HBL3052	C-11
HBL27W47BK	C-7	HBL2899	B-52	HBL300FY	H-6	HBL3054	C-11
				HBL300MBK	H-6	HBL3055	C-11

Catalog Number Index

Catalog Number	Page	Catalog Number	Page	Catalog Number	Page	Catalog Number	Page
HBL3056	C-11	HBL320C6W	AA-24, G-10	HBL3430G	N-18, B-48	HBL3W100C	M-22, M-6
HBL3057	C-11	HBL320C7W	G-10	HBL3431C	B-47	HBL3W50	M-7, M-22
HBL3058	C-11	HBL320P4W	G-10	HBL3431GCB	B-47	HBL3WAA	B-53
HBL3060	C-11	HBL320P6W	AA-24, G-10	HBL3433C	B-48	HBL400FBK	H-6
HBL3061	C-11	HBL320P7W	G-10	HBL3433GCB	B-48	HBL400FBL	H-6
HBL3080	C-11	HBL320R4W	G-10	HBL3435CM2	B-48	HBL400FBN	H-6
HBL3080BK	C-11	HBL320R6W	AA-24, G-10	HBL3520	N-18, B-46	HBL400FGN	H-6
HBL3080F	C-11	HBL320R7W	G-10	HBL3521C	B-46	HBL400FGY	H-6
HBL3080FBK	C-11	HBL3226	B-19	HBL3523C	B-46	HBL400FO	H-6
HBL3082GY	S-19, S-49	HBL328DCC	AA-34	HBL3524C	B-46	HBL400FR	H-6
HBL3086GY	S-19, S-49	HBL328DCP	AA-34	HBL3525C	B-46	HBL400FW	H-6
HBL3086IV	S-19, S-49	HBL328DCPW	AA-34	HBL360B4W	G-11, G-6	HBL400FY	H-6
HBL3090F	C-11	HBL328DCR	AA-34	HBL360B6W	AA-24, G-11, G-6	HBL400MBK	H-6
HBL3099	C-11	HBL328DCRW	AA-34	HBL360B7W	G-11, G-6	HBL400MBL	H-6
HBL30MIFRS	G-26, F-17, G-47	HBL32AITSS	AA-31	HBL360C4W	G-11	HBL400MBN	H-6
HBL30MIRS	G-23	HBL32AITSSB	AA-31	HBL360C6W	AA-24, G-11	HBL400MGN	H-6
HBL30MISRS	G-47	HBL32AITW	AA-31	HBL360C7W	G-11	HBL400MGY	H-6
HBL30RGB	B-41, F-5, G-23, F-11	HBL330B4W	G-6, G-10	HBL360C8V0DC	G-13	HBL400MO	H-6
HBL30RNB	B-41, F-5, G-23, F-11	HBL330B6W	AA-24, G-6, G-10	HBL360CS1W	G-40	HBL400MR	H-6
HBL3100B4W	G-11	HBL330B7W	G-6, G-10	HBL360CS1WR	G-41	HBL400MW	H-6
HBL3100B6W	G-11	HBL330C4W	G-10	HBL360CS2W	G-40	HBL400MY	H-6
HBL3100B7W	G-11	HBL330C6W	AA-24, K-19, G-10	HBL360CS2WR	G-41	HBL400RCF	H-8
HBL3100C4W	G-11	HBL330C7W	G-10	HBL360MI4W	G-24, G-22	HBL400RCM	H-8
HBL3100C6W	G-11	HBL330C8V0DC	G-13	HBL360MI6W	G-24, G-22	HBL4100B12W	G-7
HBL3100C7W	G-11	HBL330CS1W	G-40	HBL360MI7W	G-24, G-22	HBL4100B5W	G-11, G-7
HBL3100C8V0DC	G-13	HBL330CS1WR	G-41	HBL360P4W	G-24, G-11, G-6, G-22	HBL4100B6W	G-11, G-7
HBL3100CS1W	G-40	HBL330CS2W	K-19, G-40	HBL360P6WG-6	G-11, G-22, G-24, AA-24	HBL4100B7W	G-11, G-7
HBL3100CS1WR	G-41	HBL330CS2WR	G-41	HBL360P7W	G-24, G-11, G-6, G-22	HBL4100B9W	G-11, G-7
HBL3100CS2W	G-40	HBL330MI4W	G-24, G-22	HBL360P8V0DC	G-13	HBL4100C5W	G-11
HBL3100CS2WR	G-41	HBL330MI6W	G-24, G-22	HBL360PS1W	G-40	HBL4100C6W	G-11
HBL3100MI6W	G-24, G-22	HBL330MI7W	G-24, G-22	HBL360PS1WR	G-41	HBL4100C7W	G-11
HBL3100P4W	G-11	HBL330P4W	G-24, G-22, G-6, G-10	HBL360PS2W	G-50, G-40, F-21	HBL4100C9W	G-11
HBL3100P6W	G-24, G-11, G-22	HBL330P6W	G-6, G-22, G-24, AA-24, K-19, G-10	HBL360PS2WR	G-41	HBL4100CS1W	G-40
HBL3100P7W	G-11	HBL330P7W	G-24, G-22, G-6, G-10	HBL360R4W	G-11	HBL4100CS1WR	G-41
HBL3100P8V0DC	G-13	HBL330P8V0DC	G-13	HBL360R6W	AA-24, G-11	HBL4100CS2W	G-40
HBL3100PS1W	G-40	HBL330PS1W	G-40	HBL360R7W	G-11	HBL4100CS2WR	G-41
HBL3100PS1WR	G-41	HBL330PS1WR	G-41	HBL360R8WDC	G-13	HBL4100MI12W	G-24, G-22
HBL3100PS2W	G-40	HBL330PS2W	G-50, G-40, K-19, F-21	HBL360RS1W	G-40	HBL4100MI2WR	G-22
HBL3100PS2WR	G-41	HBL330PS2WR	G-41	HBL360RS1WR	G-41	HBL4100MI5W	G-24, G-22
HBL3100R4W	G-11	HBL330R4W	G-10	HBL360RS2W	G-40	HBL4100MI5WR	G-22
HBL3100R6W	G-11	HBL330R6W	AA-24, G-10	HBL360RS2WR	G-41	HBL4100MI7W	G-24, G-22
HBL3100R7W	G-11	HBL330R7W	G-10	HBL363CRC	AA-25	HBL4100MI7WR	G-22
HBL3100R8WDC	G-13	HBL330R8WDC	G-13	HBL363CRP	AA-25	HBL4100MI9WR	G-22
HBL3100RS1W	G-40	HBL330RS1W	G-40	HBL363CRR	AA-25	HBL4100P12W	G-24, G-7, G-22
HBL3100RS1WR	G-41	HBL330RS1WR	G-41	HBL363SSX	AA-25	HBL4100P12WR	G-22
HBL3100RS2W	G-40	HBL330RS2W	G-40	HBL3720	B-24	HBL4100P5W	G-24, G-11, G-7, G-22
HBL3100RS2WR	G-41	HBL330RS2WR	G-41	HBL3721	B-24	HBL4100P9W	G-24, G-11, G-7, G-22
HBL316B4W	G-10	HBL3325C	B-44, N-19	HBL3723	B-24	HBL4100P5WR	G-22
HBL316C4W	G-10	HBL3326C	N-19, B-45	HBL3725	B-24	HBL4100P6W	G-11, G-7
HBL316CRCX	AA-25	HBL332B4W	G-6, G-10	HBL3726	B-24	HBL4100P7W	G-24, G-11, G-7, G-22
HBL316NM	AA-25	HBL332C4W	G-10	HBL3762C	B-58	HBL4100P7WR	G-22
HBL316P4W	G-10	HBL332CRCX	AA-25	HBL3763C	B-58	HBL4100P9W	G-24, G-11, G-7, G-22
HBL316R4W	G-10	HBL332NM	AA-25	HBL3764C	B-59	HBL4100P9WR	G-22
HBL316SSX	AA-25	HBL332P4W	G-6	HBL3765C	B-59	HBL4100P9WR	G-22
HBL31CM28	AA-29, AA-28	HBL332SSX	AA-25	HBL3767	B-58	HBL4100PS1W	G-40
HBL31CM29	AA-29, BB-4, AA-28	HBL3330	N-18, B-48	HBL3768	B-59	HBL4100PS1WR	G-41
HBL3200CS2W	G-40	HBL3330G	N-18, B-48	HBL3769	B-59	HBL4100PS2W	G-40
HBL3200CS2WR	G-41	HBL3331C	B-47	HBL3771	B-58	HBL4100PS2WR	G-41
HBL3200PS2W	G-40	HBL3331GC	B-47	HBL3775	B-59	HBL4100PS2WR	G-41
HBL3200PS2WR	G-41	HBL3333C	B-48	HBL3777	B-58	HBL4100R5W	G-11
HBL3200REDGY	S-19, S-49	HBL3333GC	B-48	HBL3P120C	M-5	HBL4100R6W	G-11
HBL3200REDIV	S-19, S-49	HBL3334C	N-19, B-47	HBL3P160B	M-22, M-4	HBL4100R7W	G-11
HBL3200RS2W	G-40	HBL3335C	N-19, B-48	HBL3P160DB	M-4	HBL4100R9W	G-11
HBL3200RS2WR	G-41	HBL3393	N-21, N-18	HBL3P320B	M-22	HBL4100RS1W	G-40
HBL320B4W	G-10	HBL3394	N-21, N-18	HBL3P320DB	M-4	HBL4100RS1WR	G-41
HBL320B6W	AA-24, G-10	HBL3430	N-18, B-48	HBL3PT2511	B-26, B-52, BB-3	HBL4100RS2W	G-40
HBL320B7W	G-10			HBL3PT2811	B-34, BB-3, B-52	HBL4100RS2WR	G-41
HBL320C4W	G-10						

Catalog Number Index

Catalog Number	Page	Catalog Number	Page	Catalog Number	Page	Catalog Number	Page
HBL415	A-33	HBL430C5W	G-10	HBL4560ST	B-13	HBL460PS1WR	G-41
HBL415BK	A-33	HBL430C6V02	G-13	HBL4563	B-13	HBL460PS2W	G-50, G-40, G-47, F-21
HBL415GY	A-33	HBL430C6W	G-10	HBL4563ST	B-13	HBL460PS2WR	G-41
HBL415H	A-33, L-10	HBL430C7W	G-10	HBL4570C	B-12	HBL460R12W	G-11
HBL415HI	A-33, L-10	HBL430C9W	G-10	HBL4570CA	B-12	HBL460R5W	G-11
HBL415HR	A-33, L-10	HBL430CS1W	G-40	HBL4570CST	B-12	HBL460R6V02	G-13
HBL415HW	A-33, L-10	HBL430CS1WR	G-41	HBL4573VBK	B-12	HBL460R6W	G-11
HBL415I	A-33, A-65	HBL430CS2W	G-40	HBL4573VY	B-12	HBL460R7W	G-11
HBL415IS	A-33, M-13	HBL430CS2WR	G-41	HBL4579C	B-13	HBL460R9W	G-11
HBL415S	A-33, M-13	HBL430MI12W	G-24, G-22	HBL4579CST	B-13	HBL460RS1W	G-40
HBL415W	A-33	HBL430MI5W	G-24, G-22	HBL4579VBK	B-13	HBL460RS1WR	G-41
HBL420	A-33	HBL430MI5WR	G-22	HBL4579VY	B-13	HBL460RS2W	G-40
HBL4200CS1W	G-40	HBL430MI7W	G-24, G-22	HBL4585	B-13	HBL460RS2WR	G-41
HBL4200CS1WR	G-41	HBL430MI7WR	G-22	HBL4585C	B-13, N-19	HBL4700	B-13, O-33, I-4
HBL4200CS2W	G-40	HBL430MI9W	G-24, G-22	HBL4586	B-12	HBL4700I	B-13
HBL4200CS2WR	G-41	HBL430MI9WR	G-22	HBL4586C	B-12, N-19	HBL4700ORT	B-13
HBL4200PS1W	G-40	HBL430MIF12W	G-27, G-26	HBL45905	N-18, B-49	HBL4700ST	B-13
HBL4200PS1WR	G-41	HBL430MIF5W	G-27, G-26	HBL45915	B-49	HBL4710	B-13, O-33, N-18
HBL4200PS2W	G-40	HBL430MIF7W	G-27, G-26	HBL45935	B-49	HBL4710BGY	S-50, S-24
HBL4200PS2WR	G-41	HBL430MIF9W	G-27, G-26	HBL45985CL	B-49	HBL4710BIV	S-50, S-24
HBL4200RS1W	G-40	HBL430MIFS2W	G-47	HBL45CM70C	B-12	HBL4710DFOGY	S-50, S-24
HBL4200RS1WR	G-41	HBL430MIS2W	G-47	HBL45CM79C	B-13	HBL4710DFOIV	S-50, S-24
HBL4200RS2W	G-40	HBL430P12W	G-27, G-6, G-22, G-24, G-26	HBL45WAA	B-53	HBL4710GY	S-50, S-24
HBL4200RS2WR	G-41	HBL430P5WG-27, G-6, G-22, G-24, G-26, G-10		HBL460B12W	G-11, G-6	HBL4710IV	S-50, S-24
HBL420B12W	G-10	HBL430P5WR	G-22	HBL460B5W	G-11, G-6	HBL4710ORT	B-13
HBL420B5W	G-10	HBL430P6V02	G-13	HBL460B6V02	G-13	HBL4710ST	B-13
HBL420B6W	G-10	HBL430P6W	G-6, G-10	HBL460B6W	G-11, G-6	HBL4711	B-13
HBL420B7W	G-10	HBL430P7WG-27, G-6, G-22, G-24, G-26, G-10		HBL460B7W	G-11, G-6	HBL4711DFOGY	S-50, S-23
HBL420B9W	G-10	HBL430P7WR	G-22	HBL460B9W	G-11, G-6	HBL4711DFOIV	S-50, S-23
HBL420BK	A-33	HBL430P9WR	G-22	HBL460C12W	G-11	HBL4711GY	S-50, S-23
HBL420C12W	G-10	HBL430PS1W	G-40	HBL460C5W	G-11	HBL4711IV	S-50, S-23
HBL420C5W	G-10	HBL430PS1WR	G-41	HBL460C6V02	G-13	HBL4712TXGY	S-50, S-23
HBL420C6W	G-10	HBL430PS2W	G-50, G-40, G-47, F-21	HBL460C6W	G-11	HBL4712TXIV	S-50, S-23
HBL420C7W	G-10	HBL430PS2WR	G-41	HBL460C7W	G-11	HBL4713	B-13
HBL420C9W	G-10	HBL430R5W	G-10	HBL460C9W	G-11	HBL4713ST	B-13
HBL420GY	A-33	HBL430R6V02	G-13	HBL460CS1W	G-40	HBL4714AGY	S-50, S-24
HBL420H	A-33, L-10	HBL430R6W	G-10	HBL460CS1WR	G-41	HBL4714AIV	S-50, S-24
HBL420HGY	A-33, L-10	HBL430R7W	G-10	HBL460CS2W	G-40	HBL4715	B-13
HBL420HI	A-33, L-10	HBL430R9W	G-10	HBL460CS2WR	G-41	HBL4715C	B-13, N-19
HBL420HIS	L-16, A-33, L-10, M-13	HBL430RS1W	G-40	HBL460MI12W	G-24, G-22	HBL4715DFOGY	S-50, S-23
HBL420HR	A-33, L-10	HBL430RS1WR	G-41	HBL460MI12WR	G-22	HBL4715DFOIV	S-50, S-23
HBL420HRS	L-16, A-33, L-10, M-13	HBL430RS2W	G-40	HBL460MI5W	G-24, G-22	HBL4715GY	S-23
HBL420HS	L-16, A-33, L-10, M-13	HBL430RS2WR	G-41	HBL460MI5WR	G-22	HBL4715IV	S-50, S-23
HBL420HW	A-33, L-10	HBL432B3W	G-6, G-10	HBL460MI7W	G-24, G-22	HBL4716	B-12
HBL420I	A-33	HBL432C3W	G-10	HBL460MI7WR	G-22	HBL4716C	B-12, N-19
HBL420IS	A-33, M-13	HBL432MI3W	G-24, G-22	HBL460MI9W	G-24, G-22	HBL4717DFOGY	S-50, S-23
HBL420MI12W	G-24, G-22	HBL432P3W	G-24, G-22, G-6, G-10	HBL460MI9WR	G-22	HBL4717DFOIV	S-50, S-23
HBL420MI5W	G-24, G-22	HBL432R3W	G-10	HBL460MIF12W	G-27, G-26	HBL4717GY	S-50, S-23
HBL420MI7W	G-24, G-22	HBL45105	N-18, B-49	HBL460MIF5W	G-27, G-26	HBL4717NGY	S-50, S-23
HBL420MI9W	G-24, G-22	HBL45115	B-49	HBL460MIF7W	G-27, G-26	HBL4717NIV	S-50, S-23
HBL420P12W	G-24, G-22	HBL45135	B-49	HBL460MIF9W	G-27, G-26	HBL4717TCAGY	S-50, S-22
HBL420P5W	G-24, G-22, G-10	HBL45205	N-18, B-49	HBL460MIFS2W	G-47	HBL4718DFOGY	S-50, S-23
HBL420P6W	G-10	HBL45215	B-49	HBL460P12W	G-27, G-6, G-11, G-22, G-24, G-26	HBL4718DFOIV	S-50, S-23
HBL420P7W	G-24, G-22, G-10	HBL45235	B-49	HBL460P12WR	G-22	HBL4718GY	S-23
HBL420P9W	G-24, G-22, G-10	HBL45305	N-18, B-49	HBL460P5WG-27, G-6, G-11, G-22, G-24, G-26		HBL4718IV	S-50, S-23
HBL420R5W	G-10	HBL45315	B-49	HBL460P5WR	G-22	HBL4720C	B-12
HBL420R6W	G-10	HBL45335	B-49	HBL460P6V02	G-13	HBL4720CA	B-12
HBL420R7W	G-10	HBL4550	B-13, O-33	HBL460P6W	G-11, G-6	HBL4720CBK	B-12
HBL420R9W	G-10	HBL4550RT	B-13	HBL460P7WG-27, G-6, G-11, G-22, G-24, G-26		HBL4720CST	B-12
HBL420S	A-33, M-13	HBL4550ST	B-13	HBL460P7WR	G-22	HBL4723VBK	B-12
HBL420W	A-33	HBL4560	B-13, O-33, N-18	HBL460P9WG-27, G-6, G-11, G-22, G-24, G-26		HBL4723VY	B-12
HBL430B12W	G-6, G-10	HBL4560RT	B-13	HBL460PS1W	G-40	HBL4724REDIV	S-49, S-15, S-24
HBL430B5W	G-6, G-10					HBL4729C	B-13
HBL430B6V02	G-13					HBL4729CA	B-13
HBL430B6W	G-6, G-10					HBL4729CBK	B-13
HBL430B7W	G-6, G-10					HBL4729CST	B-13
HBL430B9W	G-6, G-10						
HBL430C12W	G-10						

Catalog Number Index

Catalog Number	Page	Catalog Number	Page	Catalog Number	Page	Catalog Number	Page
HBL4729VBK	B-13	HBL4751DA	S-50, S-22	HBL500TFIV	S-7, S-48	HBL518W	S-6
HBL4729VY	B-13	HBL4756AGY	S-50, S-24	HBL501032W	J-5	HBL5200	AA-40, BB-3
HBL4746H2GY	S-50, S-24	HBL4756AIV	S-50, S-24	HBL501032WWM1	J-5	HBL5200CS1W	G-40
HBL4746H2IV	S-50, S-24	HBL4760	B-13, O-33, N-18	HBL501042W	J-5	HBL5200CS1WR	G-41
HBL47472BBBBGY	S-50, S-26	HBL4760C	B-13	HBL501232W	J-5	HBL5200PS1W	G-40
HBL47472BBBBIV	S-50, S-26	HBL4760ST	B-13	HBL501232WWM1	J-5	HBL5200PS1WR	G-41
HBL47472BBFFGY	S-50, S-26	HBL4761	B-13	HBL501242W	J-5	HBL5200RS1W	G-40
HBL47472BBFFIV	S-26	HBL4763	B-13	HBL501431W	J-5	HBL5200RS1WR	G-41
HBL47472BBRRGY	S-26	HBL4770C	B-12	HBL502B	S-7, S-48	HBL5201	N-23, AA-49
HBL47472BBRRIV	S-26	HBL4770CA	B-12	HBL503NM	AA-4, AA-14	HBL5205WO	N-23, B-50, A-52
HBL47472BBSSGY	S-50, S-26	HBL4770CST	B-12	HBL503SS	AA-4, AA-14	HBL5206WO	N-23, B-50, A-52
HBL47472BBSSIV	S-50, S-26	HBL4773VBK	B-12	HBL504IV	S-7, S-48	HBL520B5W	G-10
HBL47472BBTTGY	S-50, S-26	HBL4773VY	B-12	HBL504NM	AA-4, AA-16	HBL520B6W	G-10
HBL47472BBTTIV	S-50, S-26	HBL4774AGY	S-50, S-24	HBL504SS	AA-4, AA-16	HBL520B7W	G-10
HBL47472BBXXGY	S-50, S-26	HBL4774AIV	S-50, S-24	HBL504SSELCI	AA-7	HBL520B9W	G-10
HBL47472BBXXIV	S-50, S-26	HBL4775DKITGY	S-24	HBL504SSELCIH	AA-7	HBL520C5W	G-10
HBL47472RRXXGY	S-50, S-26	HBL4775DKITIV	S-24	HBL504W	S-7	HBL520C6W	G-10
HBL47472RRXXIV	S-50, S-26	HBL4779C	B-13	HBL506IV	S-7, S-48	HBL520C7W	G-10
HBL4747AXGY	S-50, S-25	HBL4779CST	B-13	HBL506W	S-7	HBL520C9W	G-10
HBL4747AXIV	S-50, S-25	HBL4779VBK	B-13	HBL50AITSS	AA-31	HBL520P5W	G-10
HBL4747BBGY	S-50	HBL4779VY	B-13	HBL50AITSSB	AA-31	HBL520P6W	G-10
HBL4747BBIV	S-50	HBL4785	B-13	HBL50AITW	AA-31	HBL520P7W	G-10
HBL4747BFGY	S-50, S-25	HBL4785C	B-13, N-19	HBL50SC	N-20, B-60	HBL520P9W	G-10
HBL4747BFIV	S-50, S-25	HBL4786	B-12	HBL50SD	J-8	HBL520R5W	G-10
HBL4747BRGY	S-50, S-25	HBL4786AGY	S-50, S-24	HBL50SDN	J-8	HBL520R6W	G-10
HBL4747BRIV	S-50, S-25	HBL4786AIV	S-50, S-24	HBL50W50	C-8	HBL520R7W	G-10
HBL4747BSGY	S-50, S-25	HBL4786C	B-12, N-19	HBL50W50BK	C-8	HBL520R9W	G-10
HBL4747BSIV	S-50, S-25	HBL4792	O-33, A-51	HBL50W52	C-8	HBL5221 N-23, AA-49, A-52, AA-36,	
HBL4747BTGY	S-50, S-25	HBL4794	O-33, A-51	HBL50W52BK	C-8	C-12, AA-37, B-50, AA-39	
HBL4747BTIV	S-50, S-25	HBL4795	O-33, A-51	HBL50W54	C-8	HBL5222 N-23, AA-49, A-52, AA-36,	
HBL4747BXYG	S-49, S-25	HBL47CM00	B-13, AA-36	HBL50W54BK	C-8	AA-37, B-50, AA-39	
HBL4747BXIV	S-50, S-25	HBL47CM15	B-13, AA-36	HBL50YSD	J-8	HBL5226	N-23, AA-49
HBL4747C1GY	S-49, S-25	HBL47CM16	B-12, AA-36	HBL5100B5W	G-11, G-7	HBL5226H	AA-49
HBL4747C1IV	S-50, S-25	HBL47CM20C	B-12, AA-36	HBL5100B6W	G-11, G-7	HBL5235	A-51
HBL4747C2GY	S-50, S-25	HBL47CM29C	B-13, AA-36	HBL5100B7W	G-11, G-7	HBL5236	A-51
HBL4747C2IV	S-50, S-25	HBL47CM70C	B-12	HBL5100B9W	G-11, G-7	HBL5236M2	A-51
HBL4747CVM2GY	S-50, S-25	HBL47CM79C	B-13	HBL5100C5W	G-11	HBL5236PLUG	A-51
HBL4747CVM2IV	S-50, S-25	HBL4889	B-8	HBL5100C6W	G-11	HBL5240	A-40
HBL4747CVMGY	S-50, S-25	HBL4890	B-8	HBL5100C7W	G-11	HBL5242	A-11
HBL4747CVMIV	S-50, S-25	HBL4892	B-60	HBL5100C8V0DC	G-13	HBL5242GY	A-11
HBL4747JXGY	S-50, S-25	HBL4AP	A-33, L-10	HBL5100C9W	G-11	HBL5242I	A-11
HBL4747JXIV	S-50, S-25	HBL4APBL	L-16, A-33, L-10, M-13	HBL5100CS1W	G-40	HBL5242RT	A-11
HBL4747RFVY	S-49, S-25	HBL4APGY	A-33, L-10	HBL5100CS1WR	G-41	HBL5242W	A-11
HBL4747RFIV	S-49, S-25	HBL4API	L-16, A-33, L-10, M-13	HBL5100MI9W	G-24, G-22	HBL5251	AA-43, O-33, A-11, N-18
HBL4747RXGY	S-49, S-25	HBL4APO	A-33, L-10	HBL5100P5W	G-11, G-7	HBL5251I	AA-43, A-11
HBL4747RXIV	S-49, S-25	HBL4APR	L-16, A-33, L-10, M-13	HBL5100P6W	G-11, G-7	HBL5252	A-58, O-33, A-11
HBL4750	S-49, B-13, S-67, O-33	HBL4APW	A-33, L-10	HBL5100P7W	G-11, G-7	HBL5252BK	A-11
HBL4750B10GY	S-22, S-49	HBL4MG15	M-8	HBL5100P8V0DC	G-13	HBL5252GY	A-11
HBL4750B10IV	S-50, S-22	HBL4MG1520	M-8	HBL5100P9W	G-24, G-11, G-7, G-22	HBL5252I	A-11
HBL4750BP	S-50, S-22	HBL4MG6	M-8	HBL5100P9WSH	G-34	HBL5252R	A-11
HBL4750C075GY	S-22, S-49	HBL4MG620	M-8	HBL5100PS1W	G-40	HBL5252W	A-11
HBL4750C075IV	S-50, S-22	HBL4MGRPT15	M-8	HBL5100PS1WR	G-41	HBL5253	A-11
HBL4750C135GY	S-50, S-22	HBL4MGRPT1520	M-8	HBL5100R5W	G-11	HBL5256	A-40
HBL4750C135IV	S-50, S-22	HBL4MGRPT6	M-8	HBL5100R6W	G-11	HBL5258	A-11
HBL4750C195GY	S-22, S-49	HBL4MGRPT620	M-8	HBL5100R7W	G-11	HBL5260ISA	M-13
HBL4750C195IV	S-50, S-22	HBL4P120C	M-5	HBL5100R8WDC	G-13	HBL5260OWSA	M-13
HBL4750C315GY	S-50, S-22	HBL4P160B	M-22, M-4	HBL5100R9W	G-11, G-31	HBL5260OSA	M-13, O-33
HBL4750C315IV	S-50, S-22	HBL4P160DB	M-4	HBL5100RS1W	G-40	HBL5260WSA	M-13
HBL4750CGY	S-50, S-22	HBL4P320B	M-22, M-4	HBL5100RS1WR	G-41	HBL5261	A-10, O-33, N-18
HBL4750CIV	S-50, S-22	HBL4P320DB	M-4	HBL5111W	S-6, S-48	HBL5261BK	A-10
HBL4750DGY	S-50, S-22	HBL4PB	A-33, L-10	HBL511W	S-6	HBL5261I	A-10
HBL4750GY	S-50, S-25, S-45	HBL4PBBK	A-33, L-10	HBL512IV	S-6, S-48	HBL5261WR	A-10
HBL4750IV	S-49, S-25, S-45	HBL4PBI	L-16, A-33, L-10, M-13	HBL515CVO	A-39	HBL5261RT	A-10
HBL4750ST	B-13	HBL4PS1050USBA	M-9	HBL515PVO	A-38	HBL5261WR	A-10
HBL4750TFVY	S-50, S-24	HBL4SA40	M-7, M-22	HBL517IV	S-6, S-48	HBL5261WRT	A-10
HBL4750TFIV	S-50, S-24	HBL4W100C	M-22, M-6	HBL517W	S-6	HBL5261YRT	A-10
HBL4750WCGY	S-50, S-22	HBL50010IV	S-48, S-4	HBL518IV	S-6, S-48	HBL5262	A-10, A-57, O-33
HBL4751AC	S-22, S-49	HBL50010W	S-4				

Catalog Number Index

Catalog Number	Page	Catalog Number	Page	Catalog Number	Page	Catalog Number	Page
HBL5262BK	A-10	HBL5262STGN	A-19	HBL52CM80C	A-38, AA-37	HBL5362C1BLTR	A-24
HBL5262BKTR	A-11	HBL5262STGNTR	A-19	HBL5302	A-42, O-33	HBL5362C1GRYTR	A-24
HBL5262BKWR	A-10	HBL5262STGNWR	A-22	HBL530B5W	G-6, G-10	HBL5362C1ITR	A-24
HBL5262BLTR	A-11	HBL5262STGY	A-19	HBL530B6V02	G-13	HBL5362C1LATR	A-24
HBL5262C1BLKTR	A-24	HBL5262STGYTR	A-19	HBL530B6W	G-6, G-10	HBL5362C1RTR	A-24
HBL5262C1BLTR	A-24	HBL5262STGYWR	A-22	HBL530B7W	G-6, G-10	HBL5362C1TR	A-24
HBL5262C1GRYTR	A-24	HBL5262STI	A-19	HBL530B9W	G-6, G-10	HBL5362C1WHITR	A-24
HBL5262C1ITR	A-24	HBL5262STITR	A-19	HBL530C5W	G-10	HBL5362C2BLKTR	A-24
HBL5262C1LATR	A-24	HBL5262STIWR	A-22	HBL530C6V02	G-13	HBL5362C2BLTR	A-24
HBL5262C1RTR	A-24	HBL5262STLA	A-19	HBL530C6W	G-10	HBL5362C2ITR	A-24
HBL5262C1TR	A-24	HBL5262STLATR	A-19	HBL530C7W	G-10	HBL5362C2LATR	A-24
HBL5262C1WHITR	A-24	HBL5262STLAWR	A-22	HBL530C9W	G-10	HBL5362C2RTR	A-24
HBL5262C2BLKTR	A-24	HBL5262STO	A-19	HBL530CS1W	G-40	HBL5362C2TR	A-24
HBL5262C2BLTR	A-24	HBL5262STOTR	A-19	HBL530CS1WR	G-41	HBL5362C2WHITR	A-24
HBL5262C2ITR	A-24	HBL5262STOWR	A-22	HBL530MI5W	G-24, G-22	HBL5362GY	A-10
HBL5262C2LATR	A-24	HBL5262STR	A-19	HBL530MI7W	G-24, G-22	HBL5362GYSA	M-13, I-4
HBL5262C2RTR	A-24	HBL5262STRTR	A-19	HBL530MI9W	G-24, G-22	HBL5362GYTR	A-11
HBL5262C2TR	A-24	HBL5262STRWR	A-22	HBL530MIF7W	G-27, G-26	HBL5362GYWR	A-10
HBL5262C2WHITR	A-24	HBL5262STTR	A-19	HBL530P5W	G-24, G-22, G-6, G-10	HBL5362I	A-10
HBL5262GY	A-10	HBL5262STW	A-19	HBL530P6V02	G-13	HBL5362ISA	M-13
HBL5262GYSA	M-13	HBL5262STWR	A-22	HBL530P6W	G-6, G-10	HBL5362ITR	A-11
HBL5262GYTR	A-11	HBL5262STWTR	A-19	HBL530P7WG-27, G-6, G-22, G-24, G-26, G-10		HBL5362IWR	A-10
HBL5262GYWR	A-10	HBL5262STWWR	A-22	HBL530P9W	G-24, G-22, G-6, G-10	HBL5362LATR	A-11
HBL5262I	A-10	HBL5262TR	A-11	HBL530PS1W	G-40	HBL5362LC1	A-25, E-13
HBL5262ISA	M-13	HBL5262W	A-10	HBL530PS1WR	G-41	HBL5362LC1BK	A-25, E-13
HBL5262ITR	A-11	HBL5262WR	A-10	HBL530RS1WR	G-10	HBL5362LC1GN	A-25, E-13
HBL5262IWR	A-10	HBL5262WSA	M-13	HBL530R5W	G-10	HBL5362LC1GY	A-25, E-13
HBL5262LATR	A-11	HBL5262WTR	A-11	HBL530R6V02	G-13	HBL5362LC1I	A-25, E-13
HBL5262LC1	A-25, E-13	HBL5262WWR	A-10	HBL530R6W	G-10	HBL5362LC1LA	A-25, E-13
HBL5262LC1BK	A-25, E-13	HBL5266C	A-38, K-19, A-66	HBL530R7W	G-10	HBL5362LC1W	A-25, E-13
HBL5262LC1GN	A-25, E-13	HBL5266CA	A-38	HBL530R9W	G-10	HBL5362LC2	A-25, E-13
HBL5262LC1GY	A-25, E-13	HBL5266CAT	A-38	HBL530RS1W	G-40	HBL5362LC2BK	A-25, E-13
HBL5262LC1I	A-25, E-13	HBL5266CBKST	A-38	HBL530RS1WR	G-41	HBL5362LC2GN	A-25, E-13
HBL5262LC1LA	A-25, E-13	HBL5266CBL	A-38	HBL5324	A-42	HBL5362LC2GY	A-25, E-13
HBL5262LC1W	A-25, E-13	HBL5266CST	A-38	HBL5342	A-11	HBL5362LC2I	A-25, E-13
HBL5262LC2	A-25, E-13	HBL5266EBK	A-38	HBL5342GY	A-11	HBL5362LC2LA	A-25, E-13
HBL5262LC2BK	A-25, E-13	HBL5269C	K-19, A-39, A-66	HBL5342I	A-11	HBL5362LC2W	A-25, E-22, E-13
HBL5262LC2GN	A-25, E-13	HBL5269CBKST	A-39	HBL5342RT	A-11	HBL5362M4	A-10
HBL5262LC2GY	A-25, E-13	HBL5269CBL	A-39	HBL5342W	A-11	HBL5362OWSA	M-13
HBL5262LC2I	A-25, E-13	HBL5269CST	A-39	HBL5352	O-33, A-11	HBL5362R	A-10
HBL5262LC2LA	A-25, E-13	HBL5269EBK	A-39	HBL5352BK	A-11	HBL5362RFC1	A-25, E-13
HBL5262LC2W	A-25, E-13	HBL5273L	AA-29, BB-4	HBL5352BL	A-11	HBL5362RFC1BK	A-25, E-13
HBL5262OWSA	M-13	HBL5278C	A-40, N-19	HBL5352GY	A-11	HBL5362RFC1GN	A-25, E-13
HBL5262R	A-10	HBL5279	A-40	HBL5352I	A-11	HBL5362RFC1GY	A-25, E-13
HBL5262RFC1	A-25, E-13	HBL5279C	A-40, N-19	HBL5352R	A-11	HBL5362RFC1I	A-25, E-13
HBL5262RFC1BK	A-25, E-13	HBL5280C	A-38	HBL5352W	A-11	HBL5362RFC1LA	A-25, E-13
HBL5262RFC1GN	A-25, E-13	HBL5282	A-10	HBL5357	A-10	HBL5362RFC1W	A-25, E-13
HBL5262RFC1GY	A-25, E-13	HBL5284	A-10	HBL5358	A-11	HBL5362RFC2	A-25, E-13
HBL5262RFC1I	A-25, E-13	HBL5289	BB-4	HBL5360ISA	M-13	HBL5362RFC2BK	A-25, E-13
HBL5262RFC1LA	A-25, E-13	HBL5292	A-51	HBL5360OWSA	M-13	HBL5362RFC2GN	A-25, E-13
HBL5262RFC1W	A-25, E-13	HBL5292I	A-51	HBL5360SA	M-13, O-33	HBL5362RFC2GY	A-25, E-13
HBL5262RFC2	A-25, E-13	HBL5299	A-38	HBL5360WSA	M-13	HBL5362RFC2I	A-25, E-13
HBL5262RFC2BK	A-25, E-13	HBL52CM21	N-23, AA-49, A-52, AA-36, C-12, AA-37, B-50, AA-39	HBL5361	AA-43, A-10, O-33, N-18	HBL5362RFC2LA	A-25, E-13
HBL5262RFC2GN	A-25, E-13	HBL52CM21W	N-23, AA-49, AA-36, B-50, AA-39	HBL5361BK	A-10	HBL5362RFC2W	A-25, E-13
HBL5262RFC2I	A-25, E-13	HBL52CM22	N-23, AA-49, A-52, AA-36, AA-37, B-50, AA-39	HBL5361GRY	A-10	HBL5362RTR	A-11
HBL5262RFC2LA	A-25, E-13	HBL52CM26	AA-49	HBL5361GRYWR	A-10	HBL5362RWR	A-10
HBL5262RFC2W	A-25, E-13	HBL52CM26H	AA-49	HBL5361I	AA-43, A-10	HBL5362SA	M-13, O-33
HBL5262RTR	A-11	HBL52CM61	A-10, AA-37, N-18	HBL5361IWR	A-10	HBL5362ST	A-19
HBL5262RWR	A-10	HBL52CM62	AA-43, A-10, AA-37	HBL5361RT	A-10	HBL5362STBK	A-19
HBL5262SA	M-13, O-33	HBL52CM62I	AA-43, A-10, AA-37	HBL5361W	A-10	HBL5362STBKTR	A-19
HBL5262ST	A-19	HBL52CM66C	A-38, AA-37	HBL5361WR	A-10	HBL5362STBKWR	A-22
HBL5262STBK	A-19	HBL52CM66CST	A-38	HBL5362	A-10, O-33	HBL5362STBL	A-19
HBL5262STBKTR	A-19	HBL52CM66V	AA-39, AA-37	HBL5362BK	A-10	HBL5362STBLTR	A-19
HBL5262STBKWR	A-22	HBL52CM69C	A-39, AA-37	HBL5362BKTR	A-11	HBL5362STBLWR	A-22
HBL5262STBL	A-19	HBL52CM69V	AA-39, AA-37	HBL5362BKW	A-10	HBL5362STGN	A-19
HBL5262STBLTR	A-19			HBL5362BL	A-10	HBL5362STGNTR	A-19
HBL5262STBLWR	A-22			HBL5362BLTR	A-11	HBL5362STGNWR	A-22
				HBL5362C1BLKTR	A-24	HBL5362STGY	A-19

Catalog Number Index

Catalog Number	Page	Catalog Number	Page	Catalog Number	Page	Catalog Number	Page
HBL5362STGYTR	A-19	HBL54CM66C	A-41	HBL5711BRIVA	S-6, S-48	HBL5752IVA	S-48, S-5
HBL5362STGYWR	A-22	HBL54CM66CST	A-41	HBL5711LHIVA	S-6, S-48	HBL5752RA	S-48, S-5
HBL5362STI	A-19	HBL5552B	A-42, N-18	HBL5711LHWA	S-6	HBL5753IVA	S-48, S-5
HBL5362STITR	A-19	HBL5607B	H-20	HBL5711RHIVA	S-6, S-48	HBL5753RA	S-48, S-5
HBL5362STIWR	A-22	HBL5607C	H-20	HBL5711RHWA	S-6	HBL5760IVA	S-48, S-4
HBL5362STLA	A-19	HBL5607P	H-20	HBL5715BRIVA	S-6, S-48	HBL5780	S-8, S-48
HBL5362STLATR	A-19	HBL5607R	H-20	HBL5715IVA	S-6, S-48	HBL5781	S-8, S-48
HBL5362STLAWR	A-22	HBL560B5W	G-11, G-6	HBL5715WA	S-6	HBL5781A	S-8, S-48
HBL5362STO	A-19	HBL560B6V02	G-13	HBL5717BRIVA	S-6, S-48	HBL5782A	S-8, S-48
HBL5362STOTR	A-19	HBL560B6W	G-11, G-6	HBL5718BRIVA	S-6, S-48	HBL5782C	S-8, S-48
HBL5362STOWR	A-22	HBL560B7W	G-11, G-6	HBL5719IVA	S-7, S-48	HBL5783IVA	S-7, S-48
HBL5362STR	A-19	HBL560B9R	H-13	HBL5719WA	S-7	HBL5784IVA	S-7, S-48
HBL5362STRTR	A-19	HBL560B9W	G-11, G-6	HBL57242IVA	S-48, S-5	HBL5785AIVA	S-7
HBL5362STRWR	A-22	HBL560C5W	G-11	HBL57242WA	S-5	HBL5785AWA	S-7
HBL5362STTR	A-19	HBL560C6V02	G-13	HBL5731IV	S-48, S-5	HBL5786AIVA	S-7, S-48
HBL5362STW	A-19	HBL560C6W	G-11	HBL5733IVA	S-48, S-5	HBL5786AWA	S-7
HBL5362STWR	A-22	HBL560C7W	G-11	HBL5735IVA	S-48, S-5	HBL5786IVA	S-7, S-48
HBL5362STWTR	A-19	HBL560C9W	G-11	HBL5736IV	S-48, S-5	HBL5786WA	S-7
HBL5362STWWW	A-22	HBL560CS1W	G-40	HBL5736W	S-5	HBL5790B	S-8, S-48
HBL5362TR	A-11	HBL560CS1WR	G-41	HBL5737AIVA	S-48, S-5	HBL5791	S-8, S-48
HBL5362W	A-10	HBL560MI5W	G-24, G-22	HBL5737AWA	S-5	HBL5865VY	A-42
HBL5362WR	A-10	HBL560MI7W	G-24, G-22	HBL5737IVA	S-48, S-5	HBL5866VY	A-42
HBL5362WSA	M-13	HBL560MI9W	G-24, G-22	HBL5737WA	S-5	HBL5867VBLK	A-42
HBL5362WTR	A-11	HBL560MIF9W	G-27, G-26	HBL5738AFIVA	S-48, S-5	HBL5869VY	A-42
HBL5362WWW	A-10	HBL560P5W	G-24, G-11, G-6, G-22	HBL5738AFWA	S-5	HBL5921	A-38
HBL5364VBK	A-38	HBL560P6V02	G-13	HBL5738AIVA	S-48, S-5	HBL5929	A-42
HBL5364VY	A-38	HBL560P6W	G-11, G-6	HBL5738AWA	S-5	HBL5963VBK	A-39
HBL5366C	A-38	HBL560P7W	G-24, G-11, G-6, G-22	HBL5738IVA	S-48, S-5	HBL5963VY	A-39
HBL5366CA	A-38	HBL560P9W	G-27, G-6, G-11, H-13, G-22, G-24, G-26	HBL5738WA	S-5	HBL5965VBLK	A-38
HBL5366CBKST	A-38	HBL560P9WR	H-13	HBL5739AABIVA	S-5	HBL5965VGY	A-38
HBL5366CST	A-38	HBL560PS1W	G-40	HBL5739AABWA	S-5	HBL5965VY	A-38, A-67
HBL5366EBK	A-38	HBL560PS1WR	G-41	HBL5739AIVA	S-48, S-5	HBL5966VBLK	A-38
HBL5369C	A-39	HBL560R5W	G-11	HBL5739AWA	S-48, S-5	HBL5966VY	A-38
HBL5369CBKST	A-39	HBL560R6V02	G-13	HBL5739WA	S-5	HBL5969VBLK	A-39
HBL5369CST	A-39	HBL560R6W	G-11	HBL57442IVA	S-48, S-4	HBL5969VGY	A-39
HBL5369EBK	A-39	HBL560R7W	G-11	HBL57442WA	S-4	HBL5969VY	A-67, A-39
HBL5369VY	A-39	HBL560R9W	G-11, H-13, G-31	HBL57443IVA	S-48, S-4	HBL5P160B	M-22
HBL5378C	A-40, N-19	HBL560RS1W	G-40	HBL5744IVA	S-48, S-4	HBL5P320B	M-22
HBL5379C	A-40, N-19	HBL560RS1WR	G-41	HBL5744S2IVA	S-48, S-4	HBL5SA40	M-7, M-22
HBL5392	O-33, A-51	HBL5652	O-33, A-12	HBL5744S2WA	S-4	HBL5W100C	M-22
HBL53CM61	A-10, AA-39, N-18	HBL5652I	A-12	HBL5744S3IVA	S-48, S-4	HBL600B	S-8, S-48
HBL53CM62	A-10, AA-39, I-4	HBL5656	A-41	HBL5744SIVA	S-48, S-4	HBL60100RGB	F-5, G-23, F-11
HBL53CM66C	A-38, AA-39	HBL5658	A-12	HBL5744SWA	S-4	HBL6017	A-53
HBL53CM66CST	A-38	HBL5661	N-18, O-33, A-12	HBL5744WA	S-4	HBL6018	A-53
HBL53CM69C	AA-39, A-39	HBL5661I	A-12	HBL5745IVA	S-48, S-5	HBL6019	A-53
HBL53R61	H-13	HBL5661R	A-12	HBL5745WA	S-5	HBL6023	B-51
HBL5461	N-18, O-33, A-12	HBL5662	O-33, A-12	HBL57472IVA	S-48, S-4	HBL6023ST	B-51
HBL5461GY	A-12	HBL5662I	A-12	HBL57472WA	S-4	HBL6024	B-51
HBL5461I	A-12	HBL5666C	A-41	HBL57473IVA	S-48, S-4	HBL6024ST	B-51
HBL5461R	A-12	HBL5666CA	A-41	HBL5747IVA	S-48, S-4	HBL6027	B-49
HBL5461W	A-12	HBL5666CST	A-41	HBL5747WA	S-4	HBL6028	B-49
HBL5462	O-33, A-12	HBL5666CST	A-41	HBL57482IVA	S-48, S-4	HBL6031	B-53
HBL5462BK	A-12	HBL5666VY	A-41	HBL57482WA	S-4	HBL6032	B-53
HBL5462GY	A-12	HBL5669C	A-41	HBL57483IVA	S-48, S-4	HBL6035	B-53
HBL5462I	A-12	HBL5669CST	A-41	HBL57483WA	S-4	HBL6036	B-53
HBL5462R	A-12	HBL5669VY	A-41	HBL57484IVA	S-48, S-4	HBL6055	C-9, AA-50
HBL5464VY	A-41	HBL5678C	N-19, A-41	HBL57485IVA	S-48, S-4	HBL605CUT	S-8, S-48
HBL5466C	A-41	HBL5679C	N-19, A-41	HBL57486IVA	S-48, S-4	HBL605K	S-8, S-48
HBL5466CA	A-41	HBL5684	A-12	HBL5748IVA	S-48, S-4	HBL6079	AA-44
HBL5466CST	A-41	HBL56CM66C	A-41	HBL5748SIVA	S-5	HBL607CUT	S-8, S-48
HBL5469C	A-41	HBL56CM66CST	A-41	HBL5748SWA	S-5	HBL607K	S-8, S-48
HBL5469CST	A-41	HBL5700FIVA	S-6, S-48	HBL5748WA	S-4	HBL6081	AA-50
HBL5469VY	A-41	HBL5700FWA	S-6	HBL57512IVA	S-48, S-4	HBL6082	AA-50
HBL5478C	N-19, A-41	HBL5701C	S-8, S-48	HBL57513IVA	S-48, S-4	HBL6083	C-9, AA-50, AA-34
HBL5479C	N-19, A-41	HBL5703IV	S-6, S-48	HBL5751AIVA	S-48, S-4	HBL6083AK	C-9, AA-50
HBL5492	A-51	HBL5703W	S-6	HBL5751AWA	S-4	HBL6084	C-9, AA-50
HBL5492I	A-51	HBL5709	S-8, S-48	HBL5751IVA	S-48, S-4	HBL6084AK	C-9, AA-50
		HBL5709GC	S-8, S-48	HBL5751WA	S-4	HBL6085	AA-51

Catalog Number Index

Catalog Number	Page	Catalog Number	Page	Catalog Number	Page	Catalog Number	Page
HBL6087	AA-50	HBL61CM42LED	AA-17, AA-5	HBL6711GY	S-50, S-29	HBL6750C195GY	S-50, S-28
HBL60CM17	AA-39, A-53, AA-37	HBL61CM42W	AA-17, AA-5	HBL6711IV	S-29, S-51	HBL6750C195IV	S-50, S-28
HBL60CM18	AA-39, A-53, AA-37	HBL61CM42WLED	AA-17, AA-5	HBL6712TXGY	S-50, S-29	HBL6750C315GY	S-50, S-28
HBL60CM19	AA-39, A-53, AA-37	HBL61CM43	AA-15, AA-5	HBL6712TXIV	S-29, S-51	HBL6750C315IV	S-50, S-28
HBL60CM23	B-51, AA-36	HBL61CM43LED	AA-15, AA-5	HBL6714AGY	S-50, S-30	HBL6750CGY	S-50, S-28
HBL60CM23ST	B-51	HBL61CM52	AA-17, AA-5	HBL6714AIV	S-30, S-51	HBL6750CIV	S-28, S-51
HBL60CM24	B-51, AA-36	HBL61CM52LED	AA-17, AA-5	HBL6715DFOGY	S-29, S-51	HBL6750DAGY	S-50, S-28
HBL60CM24ST	B-51	HBL61CM52W	AA-17, AA-5	HBL6715DFOIV	S-29, S-51	HBL6750GY	S-31, S-50, S-45
HBL60CM31	AA-11, B-53, AA-38, AA-5	HBL61CM52WLED	AA-17, AA-5	HBL6715GY	S-29, S-51	HBL6750IV	S-31, S-51, S-45
HBL60CM31V	B-53, AA-12, AA-38	HBL61CM53	AA-15, AA-5	HBL6715IV	S-29, S-51	HBL6750TFGY	S-30, S-51
HBL60CM31W	AA-11, AA-38, AA-5	HBL61CM53LED	AA-15, AA-5	HBL6717DFOGY	S-50, S-29	HBL6750TFIV	S-30, S-51
HBL60CM32	AA-11, B-53, AA-38	HBL61CM54	AA-29, AA-28	HBL6717DFOIV	S-29	HBL6750WCGY	S-50, S-28
HBL60CM32V	B-53, AA-12, AA-38	HBL61CM55	AA-29, AA-28	HBL6717GY	S-50, S-29	HBL6751A	S-50, S-28
HBL60CM33	AA-4, AA-25, AA-11	HBL61CM56	AA-29, AA-28	HBL6717IV	S-29	HBL6751DAGY	S-50, S-28
HBL60CM33V	AA-12	HBL61CM64	A-40, AA-37	HBL6717NGY	S-29, S-51	HBL6756AGY	S-50, S-30
HBL60CM33W	AA-4, AA-25, AA-11	HBL61CM64BK	A-40, AA-37	HBL6717NIV	S-29, S-51	HBL6756AIV	S-30, S-51
HBL60CM35	B-53	HBL61CM65	A-40, AA-39	HBL6717TCAGY	S-28, S-51	HBL6774AGY	S-50, S-30
HBL60CM36	B-53	HBL61CM71	AA-29, AA-28	HBL6718DFOGY	S-50, S-29	HBL6774AIV	S-30, S-51
HBL60CM55	C-9, AA-50	HBL61CM72	AA-29, AA-28	HBL6718DFOIV	S-29, S-51	HBL6786GY	S-50, S-30
HBL60CM55W	C-9, AA-50	HBL620BCK	S-11, S-48	HBL6718GY	S-50, S-29	HBL6786IV	S-30, S-51
HBL60CM75	AA-10	HBL620C	S-11, S-48	HBL6718IV	S-29	HBL67W08	C-7
HBL60CM83A	C-9, AA-50, AA-34	HBL6236	A-51	HBL6746HHHGY	S-50, S-30	HBL67W09	C-7
HBL60CM83AK	C-9, AA-50	HBL624BCK	S-49, S-16	HBL6746HHHIV	S-30, S-51	HBL67W47	C-7
HBL60CM83WA	C-9, AA-50, AA-34	HBL624CUT	S-49, S-16	HBL67473BBBBBBGY	S-50, S-32	HBL67W48	C-7
HBL60CM83WAK	C-9, AA-50	HBL630B	S-49, S-20	HBL67473BBBBBBIV	S-32	HBL67W48BK	C-7
HBL60CM84	C-9, AA-50	HBL630BDK	S-49, S-20	HBL67473BBBBBFFGY	S-50, S-32	HBL67W49	C-7
HBL60CM84AK	C-9, AA-50	HBL630C	S-49, S-20	HBL67473BBBBBFFIV	S-32, S-51	HBL67W74	C-7
HBL60CM84WA	C-9, AA-50	HBL630CDK	S-49, S-20	HBL67473BBBBSSGY	S-50, S-32	HBL67W75	C-7
HBL60CM84WAK	C-9, AA-50	HBL6375S	B-57, H-13	HBL67473BBBBSSIV	S-32, S-51	HBL67W75BK	C-7
HBL60CM88	C-9, AA-50	HBL63AITSS	AA-31	HBL67473BBBBTTGY	S-50, S-32	HBL67W76	C-7
HBL60CM88W	C-9, AA-50	HBL63AITSSB	AA-31	HBL67473BBBBTTIV	S-32, S-51	HBL67W76BK	C-7
HBL60MIFRS	G-26, F-17, G-47	HBL63AITW	AA-31	HBL67473BBBBXXGY	S-50, S-32, S-51	HBL67W81	C-7
HBL60MISRS	G-47	HBL63CM60	AA-4, AA-14	HBL67473BBBBXXIV	S-32, S-51	HBL67W82	C-7
HBL60RNB	F-5, G-23, F-11	HBL63CM61	AA-15, AA-5	HBL67473BBBRRRGY	S-32	HBL67W83	C-7
HBL60SPF	H-18	HBL63CM64	AA-4, AA-16	HBL67473BBBRRRIV	S-32	HBL6800	C-8
HBL60SPFR	H-18	HBL63CM65	AA-17, AA-5	HBL67473BBBRRRXXGY	S-50, S-32	HBL6800BK	C-8
HBL60SPFRRT	H-18	HBL63CM69	AA-17, AA-5	HBL67473BBBRRXXIV	S-32, S-51	HBL6810	A-43, N-18
HBL60SPM	H-18	HBL63CM70	AA-15, AA-5	HBL67473BBBXXGY	S-31, S-50	HBL69W08	C-7
HBL60SPMR	H-18	HBL640B	S-26, S-49	HBL6747AXXGY	S-31, S-50	HBL69W47	C-7
HBL60SPMRRT	H-18	HBL640BDK	S-50, S-26	HBL6747AXXIV	S-31, S-51	HBL69W48	C-7
HBL60W33	C-6	HBL640C	S-26, S-49	HBL6747BBBGY	S-31, S-50	HBL69W48BK	C-7
HBL60W33D	C-6	HBL640CDK	S-50, S-26	HBL6747BBBIV	S-31, S-51	HBL69W49	C-7
HBL60W47	C-6	HBL64CM54	AA-29, AA-28	HBL6747BBBFGY	S-31, S-50	HBL69W74	C-7
HBL60W47BK	C-6	HBL64CM55	AA-29, AA-28	HBL6747BBFIV	S-31, S-51	HBL69W75	C-7
HBL60W47D	C-6	HBL64CM56	AA-29, AA-28	HBL6747BBSGY	S-31, S-50	HBL69W75BK	C-7
HBL60W48	C-6	HBL64CM57	AA-29, AA-28	HBL6747BBSIV	S-31, S-51	HBL69W76	C-7
HBL60W48D	C-6	HBL6500	C-8	HBL6747BBTGY	S-31, S-50	HBL69W76BK	C-7
HBL60W49	C-6	HBL6500BK	C-8	HBL6747BBTIV	S-31, S-51	HBL69W77	C-7
HBL60W49D	C-6	HBL65W34	C-6	HBL6747BRRGY	S-31	HBL69W81	C-7
HBL6187	N-18	HBL65W34D	C-6	HBL6747BRRIV	S-31	HBL69W82	C-7
HBL61CM03	AA-9, AA-5	HBL65W47	C-6	HBL6747BXXGY	S-31, S-50	HBL69W83	C-7
HBL61CM03LED	AA-9, AA-5	HBL65W47D	C-6	HBL6747BXXIV	S-31, S-51	HBL6HG15	L-16, M-9
HBL61CM03W	AA-9	HBL65W49	C-6	HBL6747C1GY	S-31, S-50	HBL6HG1520	L-16, M-9
HBL61CM03WLED	AA-9	HBL65W49D	C-6	HBL6747C1IV	S-31, S-51	HBL6HG6	L-16, M-9
HBL61CM05	AA-9, AA-5	HBL660B	S-50, S-32	HBL6747C2GY	S-31, S-50	HBL6HG620	L-16, M-8
HBL61CM05LED	AA-9, AA-5	HBL660BDK	S-50, S-32	HBL6747C2IV	S-31, S-51	HBL6HGUIB6	L-16, M-9
HBL61CM05W	AA-9	HBL660C	S-50, S-32	HBL6747JXXGY	S-31, S-50	HBL6MG15	L-16, M-8
HBL61CM05WLED	AA-9	HBL660CDK	S-50, S-32	HBL6747JXXIV	S-31, S-51	HBL6MG1520	L-16, M-8
HBL61CM08	AA-9, AA-5	HBL6700	C-8	HBL6747RRFGY	S-31, S-50	HBL6MG6	L-16, M-8
HBL61CM08LED	AA-9, AA-5	HBL6700BK	C-8	HBL6747RRFIV	S-31, S-51	HBL6MG620	L-16, M-8
HBL61CM08W	AA-9, AA-5	HBL6710BGY	S-50, S-30	HBL6747RRRXXGY	S-31, S-50	HBL6MGRPT15	L-16, M-8
HBL61CM08WLED	AA-9, AA-5	HBL6710BIV	S-30, S-51	HBL6747RXXIV	S-31, S-51	HBL6MGRPT1520	L-16, M-8
HBL61CM100	AA-29, AA-28	HBL6710DFOGY	S-30, S-51	HBL6750B10GY	S-50, S-28	HBL6MGRPT6	L-16, M-8
HBL61CM22	AA-29, AA-28	HBL6710DFOIV	S-30, S-51	HBL6750B10IV	S-28, S-51	HBL6MGRPT620	L-16, M-8
HBL61CM22W	AA-29, AA-28	HBL6710GY	S-30	HBL6750C075GY	S-50, S-28	HBL6MPS	M-9
HBL61CM25	AA-29, AA-28	HBL6710IV	S-30	HBL6750C075IV	S-50, S-28	HBL6MPS1050	M-9
HBL61CM42	AA-17, AA-5	HBL6711DFOGY	S-50, S-29	HBL6750C135GY	S-50, S-28	HBL6MPS105015	M-9
		HBL6711DFOIV	S-29, S-51	HBL6750C135IV	S-50, S-28	HBL6MPS15	M-9

Catalog Number Index

Catalog Number	Page	Catalog Number	Page	Catalog Number	Page	Catalog Number	Page
HBL6P160B	M-22	HBL7410B	N-18, B-45	HBL7529A	B-51	HBL7843	F-23
HBL6P320B	M-22	HBL7410BG	N-18, B-45	HBL7535	B-11, N-18	HBL7843D	F-27, F-23
HBL6PPS	M-9	HBL7411C	B-44	HBL7540	B-11	HBL7852D	F-23
HBL6PS1050MA	M-9	HBL7411GCB	B-44	HBL7545C	B-11	HBL7853D	F-23
HBL6PS35015A	M-9	HBL7413C	B-45	HBL7551	B-6	HBL7862D	F-27, F-23
HBL6PS350A	M-9	HBL7413GCB	B-45	HBL7555	B-43	HBL7862FWD	F-27, F-23
HBL6PS350YL	M-9	HBL7417B	B-45	HBL7555G	B-43	HBL7863D	F-27, F-23
HBL6RPT15	M-10	HBL7420	D-18, A-52, N-18, N-21, B-52, N-22, B-50	HBL7556	B-43	HBL7863FWD	F-27, F-23
HBL6RPT1520	M-10	HBL7423WO	AA-49, A-52, C-12, N-18, N-21, B-63, B-62, AA-37, B-50, AA-39	HBL7556G	B-43	HBL7882D	F-27, F-23
HBL6RPT1520BK	M-10	HBL7424WO	N-21, AA-49, AA-11, N-18	HBL7557	B-43	HBL7883D	F-27, F-23
HBL6RPT15BK	M-10	HBL7425WOA	AA-49, AA-38, N-18, N-21, AA-11, C-12, B-52, AA-34	HBL7557G	B-43	HBL792	X-13
HBL6RPT6	M-10	HBL7428WOG	B-68, N-20, B-65, N-21	HBL7565C	B-43	HBL793	X-13
HBL6RPT620	M-10	HBL7428WOR	B-68, N-20, B-65, N-21	HBL7565CY	B-43	HBL794	X-13
HBL6RPT620BK	M-10	HBL7428WOY	B-68, N-20, B-65, N-21	HBL7567C	B-43	HBL7940	A-48
HBL6RPT6BK	M-10	HBL7432	B-6	HBL7567CY	B-43	HBL7958	B-59
HBL6SS15	M-9	HBL7433	B-7	HBL7570	B-6	HBL7962	A-48, N-18
HBL6SS1520	M-9	HBL7440V	B-8	HBL7571	B-7	HBL7968	B-59
HBL6SS6	M-9	HBL7445V	B-8	HBL7580	B-43	HBL7977	A-48
HBL6SS620	M-9	HBL7464V	B-7	HBL7580G	B-43	HBL7DBBK	H-8
HBL6W100C	M-22	HBL7465V	B-6	HBL7582	B-43, N-18	HBL7DBBL	H-8
HBL7002B	S-7	HBL7466	B-6	HBL7582G	B-43	HBL7DBBN	H-8
HBL7004IV	S-7	HBL7467	B-6	HBL7593	B-7	HBL7DBGN	H-8
HBL7004W	S-7	HBL7468	B-7	HBL7593V	B-7	HBL7DBO	H-8
HBL7006IV	S-7	HBL7484	B-7	HBL7594	B-6	HBL7DBR	H-8
HBL7006W	S-7	HBL7484V	B-7	HBL7594V	B-6	HBL7DBW	H-8
HBL700CUT	S-8	HBL7485	B-6	HBL7595	B-6	HBL7DBY	H-8
HBL700IV	S-4	HBL7485V	B-6	HBL7595N	B-6	HBL7PS105015A	M-9
HBL700K	S-8	HBL7486	B-6	HBL7596	B-7	HBL7PS1050A	M-9
HBL700TFIV	S-7	HBL7486N	B-6	HBL7596N	B-7	HBL7PS1050MA	M-9
HBL700W	S-4	HBL7487	B-7	HBL7598	B-7	HBL8013V	L-11, A-37
HBL701F	X-10	HBL7487N	B-7	HBL768	X-10	HBL808C	X-10
HBL701R	X-10	HBL7489	B-7	HBL768AMR	X-10	HBL809C	X-10
HBL702F	X-10	HBL7490V	B-8	HBL768B	X-10	HBL8115V	L-11, A-37
HBL702R	X-10	HBL7495V	B-8	HBL768H	X-10	HBL8119V	L-11, A-37
HBL7101C	B-19	HBL7498	B-11	HBL769	X-10	HBL818	X-13, X-10
HBL7102C	B-19	HBL74CM23WO	AA-49, A-52, C-12, N-18, N-21, B-63, B-62, AA-37, B-50, AA-39	HBL769AMR	X-10	HBL819	X-13, X-10
HBL711IVA	S-6, S-48	HBL74CM24WO	N-21, AA-49, AA-11, N-18	HBL769B	X-10	HBL820	X-13, X-10
HBL711WA	S-6	HBL74CM25WOA	AA-49, AA-38, N-18, N-21, C-12, AA-11, B-52, AA-34, AA-5	HBL769H	X-10	HBL8200	L-4, A-9
HBL712IV	S-48	HBL74CM25WOAW	AA-49, AA-38, N-21, AA-11, AA-34, AA-5	HBL7716C	B-60	HBL8200BK	L-4, A-9
HBL712IVA	S-6	HBL75010V	S-48, S-4	HBL7717C	B-60	HBL8200GY	L-4, A-56, A-9
HBL717IVA	S-6, S-48	HBL75010W	S-4	HBL775	X-10	HBL8200H	L-4, A-9
HBL717WA	S-6	HBL7502B	S-7, S-48	HBL7764C	B-59	HBL8200HG	L-4, A-9
HBL718IVA	S-6, S-48	HBL7504IV	S-7, S-48	HBL7765C	B-59	HBL8200HI	L-4, A-9
HBL718WA	S-6	HBL7504W	S-7	HBL7770	N-20, B-60, N-18	HBL8200HLA	L-4, A-9
HBL7210B	B-19, N-18	HBL7505IV	S-4	HBL7774WO	AA-15, AA-49, B-60, N-18, N-20, AA-17	HBL8200HRED	L-4, A-9
HBL7217B	B-19	HBL7506C	B-11	HBL7777A	A-55, N-20	HBL8200HW	L-4, A-9
HBL7250	A-43, N-18	HBL7506IV	S-7, S-48	HBL7780	N-19	HBL8200I	L-4, A-9
HBL7251C	A-43	HBL7506W	S-7	HBL77CM15	AA-4, AA-16, AA-25, AA-14	HBL8200ILGY	L-4, A-9
HBL7301A	A-50, N-18	HBL750TFIV	S-7, S-48	HBL77CM15W	AA-4, AA-16, AA-25, AA-14	HBL8200ILI	AA-43, L-4, A-9
HBL7302C	A-50	HBL7513C	A-48	HBL77CM16	AA-25, AA-15, AA-17, AA-5	HBL8200ILR	L-4, A-9
HBL7303C	A-50	HBL7515C	A-48	HBL77CM16W	AA-25, AA-15, AA-17, AA-5	HBL8200ILW	L-4, A-9
HBL7310B	N-18, B-45	HBL7524C	N-19, B-11	HBL77CM17	AA-14, AA-16	HBL8200IMRI	L-4, A-9
HBL7310BG	N-18, B-45	HBL7526	B-11	HBL77CM67	AA-14, AA-16	HBL8200IOLA	L-4, A-9
HBL7314C	B-45	HBL7526C	N-19, B-11	HBL77CM74WO	AA-15, AA-49, B-60, H-13, N-18, N-20, AA-5, AA-17	HBL8200LAMRI	L-4, A-9
HBL7314GCB	B-45			HBL77CM77A	A-55, N-20	HBL8200LAMRI	L-4, A-9
HBL7320	N-21, N-18			HBL781	X-10	HBL8200RED	L-4, A-9
HBL7341	N-29			HBL7810	F-23, F-26	HBL8200RMRI	L-4, A-9
HBL7341SS	N-16			HBL7810S	F-23, F-26	HBL8200SGA	L-4, A-9
HBL7342RKRL	N-16			HBL7832	F-23, F-26	HBL8200SGG YA	L-4, A-9
HBL7349	N-20			HBL7832S	F-23, F-26	HBL8200SGIA	L-4, A-9
HBL7371	A-51			HBL7842D	F-27, F-23	HBL8200SGRA	L-4, A-9
HBL7372RKRL	N-16					HBL8200SGWA	L-4, A-9
HBL7379	B-59					HBL8200ST	A-19
HBL7382	B-60					HBL8200STBK	A-19
HBL7383	B-60					HBL8200STBL	A-19
HBL73CM14C	B-45					HBL8200STGN	A-19
HBL7408C	B-44, N-19					HBL8200STGY	A-19
HBL7409C	N-19, B-45					HBL8200STI	A-19
						HBL8200STLA	A-19

Catalog Number Index

Catalog Number	Page	Catalog Number	Page	Catalog Number	Page	Catalog Number	Page
HBL8200STO	A-19	HBL8310W	L-4, A-9	HBL9333	A-46	HBLALU2018	S-36, S-34, S-51
HBL8200STR	A-19	HBL8315C	L-11, A-37	HBL9337C	A-46	HBLALU2038	S-36, S-34, S-51
HBL8200STW	A-19	HBL8315CAT	L-11, A-37	HBL9350	A-46, N-18	HBLALU2040A	S-36, S-35, S-51
HBL8200W	L-4, A-9	HBL8315CST	A-37	HBL9360	A-48, N-18	HBLALU2043	S-51
HBL8200WMRI	L-4, A-9	HBL8315CT	L-11, A-37	HBL9361	A-48	HBLALU2044	S-36, S-34, S-51
HBL8210	N-18, L-4, A-9	HBL8315CTST	A-37	HBL9365	A-48, N-18	HBLALU20442	S-36, S-34, S-51
HBL8210GY	L-4, A-9	HBL8319C	L-11, A-37	HBL9367	A-48, N-18	HBLALU2047	S-36, S-34, S-51
HBL8210I	L-4, A-9	HBL8319CST	A-37	HBL9368	A-48	HBLALU20472	S-36, S-34, S-51
HBL8210R	L-4, A-9	HBL8319CT	L-11, A-37	HBL9379	A-48	HBLALU2051H	S-35, S-51
HBL8210W	L-4, A-9	HBL8319CTST	A-37	HBL9395	A-48, A-46	HBLALU20GB306	S-36, S-51
HBL8215C	L-11, A-37	HBL8330A	A-47, N-18	HBL9419	N-20, N-18	HBLALU20GB306TR	S-36
HBL8215CAT	L-11, A-37	HBL8331C	A-47	HBL9420	A-54, N-20, N-18	HBLALU20GB312U	Q-5, S-36
HBL8215CST	A-37	HBL8350A	N-18, A-49	HBL9425	A-54, N-18	HBLALU20GB506	S-36, S-51
HBL8215CT	L-11, A-37	HBL8352C	A-49	HBL9430A	A-47, N-18, A-69	HBLALU20GB512	S-36, S-51
HBL8215CTST	A-37	HBL8362GYSA	L-16, M-13, I-4	HBL9431C	A-47, A-69	HBLALU20GB512TR	S-36
HBL8219C	L-11, A-37	HBL8362ISA	L-16, M-13	HBL9432C	A-47	HBLALU20GB606	S-36, S-51
HBL8219CST	A-37	HBL8362RSA	L-16, M-13	HBL9450A	N-18, A-49	HBLALU20GB612	S-36, S-51
HBL8219CT	L-11, A-37	HBL8362SA	L-16, M-13	HBL9451C	A-49	HBLALU20GB612U	Q-5, S-36
HBL8219CTST	A-37	HBL8362WSA	L-16, M-13	HBL9452C	A-49	HBLALU20GB618	S-36, S-51
HBL8262GYSA	L-16, M-13	HBL8364V	L-11, A-37	HBL9460A	A-50, N-18	HBLALU20GBA606	S-36, S-51
HBL8262ISA	L-16, M-13	HBL8384I	L-4, A-9	HBL9461C	A-50	HBLALU20GBA612	S-36, S-51
HBL8262RSA	L-16, M-13	HBL840	X-13, X-10	HBL9462C	A-50	HBLALU20GBA618	S-36, S-51
HBL8262SA	L-16, M-13	HBL8400	A-10, L-4	HBL96061	N-22, D-18	HBLALU20IG306	S-36, S-51
HBL8262WSA	L-16, M-13	HBL8400I	A-10, L-4	HBL96061DCH	N-22, D-18	HBLALU20IG506	S-36, S-51
HBL8284	L-4, A-9	HBL841	X-10	HBL96062	N-22, D-18	HBLALU20IG606	S-36, S-51
HBL8284I	L-4, A-9	HBL8410	A-43, O-33, N-18	HBL96067	N-18	HBLALU24GB306	S-36, S-51
HBL8300	L-4, A-9	HBL8411C	A-43	HBL9758VY	A-42	HBLALU24GB306TR	S-36
HBL8300BL	L-4, A-9	HBL842	X-10	HBL981	X-13	HBLALU24GB506	S-36, S-51
HBL8300GY	L-4, I-4, A-9	HBL8420	A-43, O-33, N-18	HBL981AVD	X-13	HBLALU24GB512	S-36, S-51
HBL8300H	L-4, A-9	HBL8421C	A-43	HBL985	Z-9, X-12, Y-13	HBLALU24GB512TR	S-36
HBL8300HG	L-4, A-9	HBL843	X-10	HBL986	Z-9, X-12, Y-13	HBLALU24GB606	S-36, S-52
HBL8300HGN	L-4, A-9	HBL8430A	A-47, N-18	HBL987	X-12	HBLALU24GB612	S-36, S-52
HBL8300HI	L-4, A-9	HBL8431C	A-47	HBL988	X-12	HBLALU24GB618	S-36, S-52
HBL8300HLA	L-4, A-9	HBL8432C	A-47	HBL989	Z-9, X-12, Y-13	HBLALU24GBA606	S-36, S-52
HBL8300HRED	L-4, A-9	HBL8450A	N-18, A-49	HBL989AVD	Z-9, X-12, Y-13	HBLALU24GBA612	S-36, S-52
HBL8300HW	L-4, A-9	HBL8451C	A-49	HBL989ST	X-11	HBLALU24GBA618	S-36, S-52
HBL8300I	L-4, A-9	HBL8452C	A-49	HBL9965C	B-44	HBLALU24IG306	S-36, S-51
HBL8300ILGY	L-4, A-9	HBL8460A	A-50, N-18	HBL9965GCB	B-44	HBLALU24IG506	S-36, S-52
HBL8300ILI	L-4, A-9	HBL8461C	A-50	HBL9977C	A-43	HBLALU24IG606	S-36, S-52
HBL8300ILR	L-4, A-9	HBL8462C	A-50	HBL999	X-10	HBLALU34DRBM	S-40
HBL8300ILW	L-4, P-22, A-9	HBL8464V	L-11, A-37	HBL99CM65C	B-44	HBLALU34EBM	S-40
HBL8300IMRI	L-4, A-9	HBL8469V	L-11, A-37	HBL9P160B	M-22	HBLALU34FBM	S-40
HBL8300LA	L-4, A-9	HBL8600	A-10, L-4	HBL9P320B	M-22	HBLALU34GBM	S-40
HBL8300LAMRI	L-4, A-9	HBL8600I	A-10, L-4	HBL9SA40	M-7, M-22	HBLALU34JBM	S-40
HBL8300RED	L-4, A-9	HBL8666V	L-11, A-37	HBL9W100C	M-22, M-6	HBLALU34NBM	S-40
HBL8300RMRI	L-4, A-9	HBL868AMR	X-10	HBLAC1	B-41, F-11, F-5, G-23, F-7, B-39	HBLALU3800B10	S-38, S-52
HBL8300SGA	L-4, A-9	HBL869AMR	X-10	HBLAC2	B-41, F-11, F-5, G-23, F-7, B-39	HBLALU3806	S-38, S-52
HBL8300SGGYA	L-4, A-9	HBL8809C	N-19, B-19	HBLAC200	F-15	HBLALU3810B	S-38, S-52
HBL8300SGIA	L-4, A-9	HBL8815C	N-19, B-19	HBLACFSNC	G-26, F-17, G-47	HBLALU3811	S-38, S-52
HBL8300SGLA	L-4, A-9	HBL8P120C	M-5	HBLACFSNO	G-26, F-17, G-47	HBLALU3815	S-38, S-52
HBL8300SGRA	L-4, A-9	HBL8P160B	M-22	HBLALU01	S-38, S-39, S-52	HBLALU3817	S-38, S-52
HBL8300SGWA	L-4, A-9	HBL8P320B	M-22, M-4	HBLALU09	S-38, S-39, S-52	HBLALU3817N	S-38, S-52
HBL8300ST	A-19	HBL8PS2100MA	M-9	HBLALU17A	S-38, S-39, S-52	HBLALU3818	S-38, S-52
HBL8300STBK	A-19	HBL8PS350YL	M-9	HBLALU2000B10	S-34, S-51	HBLALU4800B10	S-39, S-52
HBL8300STBL	A-19	HBL8SA40	M-22	HBLALU2000B5	S-34, S-51	HBLALU4806	S-39, S-52
HBL8300STGN	A-19	HBL8W100C	M-22, M-6	HBLALU2000C5	S-34, S-51	HBLALU4810B	S-39, S-52
HBL8300STGY	A-19	HBL9009	X-10	HBLALU2000WC	S-35, S-51	HBLALU4810B2	S-39, S-52
HBL8300STI	A-19	HBL9010	X-10	HBLALU2001	S-36, S-35, S-51	HBLALU4811	S-39, S-52
HBL8300STLA	A-19	HBL9020R	X-10	HBLALU2003	S-36, S-35, S-51	HBLALU4815	S-39, S-52
HBL8300STO	A-19	HBL902C	X-10	HBLALU2006	S-36, S-35, S-51	HBLALU4817	S-39, S-52
HBL8300STR	A-19	HBL907C	X-10	HBLALU2009	S-35, S-51	HBLALU4817N	S-39, S-52
HBL8300STW	A-19	HBL9308	A-46, N-18	HBLALU2010A	S-36, S-35, S-51	HBLALU4818	S-39, S-52
HBL8300W	L-4, A-9	HBL9309	A-46	HBLALU2010B	S-36, S-35, S-51	HBLALU5000B10	S-42
HBL8300WMRI	L-4, A-9	HBL9315	A-46, N-18	HBLALU2011	S-36, S-34, S-51	HBLALU5006	S-42
HBL8310	N-18, L-4, A-9	HBL9319	A-46	HBLALU2015	S-36, S-34, S-51	HBLALU5010B	S-42
HBL8310GY	L-4, A-9	HBL9330	A-46, N-18	HBLALU2017	S-36, S-34, S-51	HBLALU5010B2	S-42
HBL8310I	L-4, A-9	HBL9331	A-46			HBLALU5011	S-42
HBL8310R	L-4, A-9						

Catalog Number Index

Catalog Number	Page	Catalog Number	Page	Catalog Number	Page	Catalog Number	Page
HBLALU5015	S-42	HBLBGSH	J-10	HBLDS100T	F-5	HBLDS3AC	F-11, F-19
HBLALU5017	S-42	HBLBH02	J-9	HBLDS100TAC	F-5	HBLDS3ACJ	F-11
HBLALU5017N	S-42	HBLBH03	J-9	HBLDS100TJ	F-5	HBLDS3ACNK	F-11, F-19
HBLALU5018	S-42	HBLBH05	J-9	HBLDS100TP	F-5	HBLDS3J	F-11, F-19
HBLALU5701	S-43, S-42	HBLBH09	J-9	HBLDS100TPAC	F-5	HBLDS3MQ5	I-8, F-19
HBLALU5709	S-43, S-42	HBLBH100	J-9	HBLDS100TPJ	F-5	HBLDS3MQR	I-8, F-13, F-19
HBLALU5717A	S-43, S-42	HBLBH120	J-9	HBLDS100TVFD	F-5	HBLDS3MQR2	I-8, F-19
HBLALU57ABRT	S-44	HBLBH140	J-9	HBLDS100VFD	F-5	HBLDS3NK	F-11, F-19
HBLALU57BL	S-44	HBLBH15	J-9	HBLDS10AC	F-11, F-19	HBLDS3P	F-11, F-19
HBLALU57DR	S-44	HBLBH22	J-9	HBLDS10J	F-11	HBLDS3PAC	F-11
HBLALU57DRBM	S-44	HBLBH30	J-9	HBLDS10P	F-11	HBLDS3PJ	F-11
HBLALU57E	S-44	HBLBH40	J-9	HBLDS10PAC	F-11	HBLDS3RS	B-41, F-5, G-23, F-11
HBLALU57EBM	S-44	HBLBH50	J-9	HBLDS10PJ	F-11	HBLDS3SS	F-7, F-19
HBLALU57F	S-44	HBLBH60	J-9	HBLDS10SS	F-7, F-19	HBLDS3SSAC	F-7, F-19
HBLALU57FBM	S-44	HBLBH70	J-9	HBLDS10SSAC	F-7, F-19	HBLDS3SSJ	F-7
HBLALU57G	S-44	HBLBH85	J-9	HBLDS10SSJ	F-7	HBLDS3SSMQ5	I-8, F-13, F-19
HBLALU57GBM	S-44	HBLBW	H-10, H-8	HBLDS10SSP	F-7	HBLDS3SSMQR	I-8, F-13, F-19
HBLALU57LPB	S-44	HBLC20143C	J-7	HBLDS10SSPJ	F-7	HBLDS3SSMQR2	F-13
HBLALU57N	S-44	HBLC25143IN	J-6	HBLDS10SSR	F-7, F-19	HBLDS3SSP	F-7
HBLALU57NBM	S-44	HBLC25163	J-7	HBLDS10SSRAC	F-7, F-19	HBLDS3SSR	F-7, F-19
HBLALU57WC	S-43, S-42	HBLC25163AIN	J-6	HBLDS10SSRC	F-8	HBLDS3SSR2K	F-7, F-19
HBLALU7606	S-43	HBLC25163C	J-7	HBLDS10SSRCJ	F-8	HBLDS3SSRAC	F-7, F-19
HBLALU7610B	S-43	HBLC30163TT	J-7	HBLDS10SSRCP	F-8	HBLDS3SSRC	F-8
HBLALU7610B2	S-43	HBLC40123	J-7	HBLDS10SSRCPJ	F-8	HBLDS3SSRCJ	F-8
HBLALU7611	S-43	HBLC40123TT	J-7	HBLDS10SSRJ	F-7	HBLDS3SSRCP	F-8
HBLALU7615	S-43	HBLC40182LED	J-6	HBLDS10SSRP	F-7	HBLDS3SSRJ	F-7
HBLALU7617	S-43	HBLCBINM	AA-10	HBLDS10SSRPAC	F-7	HBLDS3SSRMQ5	I-8, F-13, F-19
HBLALU7617N	S-43	HBLCBISS	AA-10	HBLDS10SSRPJ	F-7	HBLDS3SSRMQR	I-8, F-13, F-19
HBLALU7618	S-43	HBLCF	H-10, H-8	HBLDS10SSRRC	F-8	HBLDS3SSRMQR2	F-13, F-19
HBLALU7620B10	S-43	HBLCGFM20	H-14	HBLDS10SSRRCJ	F-8	HBLDS3SSRP	F-7
HBLALUABRT	S-40, S-52	HBLCORDCLAMPBL	A-41, A-39	HBLDS10SSRRCJ	F-8	HBLDS3SSRPJ	F-7
HBLALUBL	S-40, S-52	HBLCORDCLAMPGN	A-41, A-39	HBLDS10SSRRCJ	F-8	HBLDS3SSRRC	F-8
HBLALUC5	S-38, S-39, S-52	HBLCORDCLAMPOR	A-41, A-39	HBLDS10SSRRCJ	F-8	HBLDS3SSRRCJ	F-8
HBLALUC57	S-43, S-42	HBLCORDCLAMP	A-41, A-39	HBLDS10SSRRCJ	F-8	HBLDS3SSRRCJ	F-8
HBLALUDR	S-40, S-52	HBLCORDCLAMP	A-41, A-39	HBLDS10SSRRCJ	F-8	HBLDS3SSRRCJ	F-8
HBLALUE	S-40, S-52	HBLCORDCLAMPY	A-41, A-39	HBLDS10SSVFD	F-7	HBLDS3SSRRCJ	F-8
HBLALUF	S-40, S-52	HBLCPIBL	B-4	HBLDS10VFD	F-11	HBLDS3SSRVFD	F-19
HBLALUG	S-40, S-52	HBLCPOGY	B-4	HBLDS20	F-15, F-19	HBLDS3SSVFD	F-7, F-19
HBLALUJ	S-40, S-52	HBLCSCK	B-60	HBLDS20RS	F-15	HBLDS3VFD	F-11
HBLALULPB	S-40, S-52	HBLCSF1	J-10	HBLDS20SS	F-15, F-19	HBLDS3VFDJ	F-11
HBLALULPBA	S-40	HBLCSF2	J-10	HBLDS3	F-12, F-11, F-19	HBLDS6	F-11, F-19
HBLALUN	S-40, S-52	HBLCSF3	J-10	HBLDS30	F-5	HBLDS60	F-5
HBLALUWC	S-38, S-39, S-52	HBLDFBK	H-8	HBLDS30AC	F-5	HBLDS60100RS	F-5, G-23, F-11
HBLAUX	F-28, F-27	HBLDFBL	H-8	HBLDS30ACJ	F-5	HBLDS60AC	F-5
HBLB7AC2	F-21	HBLDFBN	H-8	HBLDS30J	F-5	HBLDS60J	F-5
HBLB7NFD13A	F-21	HBLDFGN	H-8	HBLDS30MQ5	F-13	HBLDS60P	F-5
HBLB7NFD13AA	F-21	HBLDFO	H-8	HBLDS30MQR	F-13	HBLDS60PAC	F-5
HBLB7NFD21A	F-21	HBLDFR	H-8	HBLDS30MQR2	F-13	HBLDS60PJ	F-5
HBLB7NFD21AA	F-21	HBLDFW	H-8	HBLDS30NK	F-5	HBLDS60RC	F-8
HBLB7NFD26A	F-21	HBLDFY	H-8	HBLDS30P	F-5	HBLDS60RCJ	F-8
HBLB7NFD26AA	F-21	HBLDMBK	H-8	HBLDS30PAC	F-5	HBLDS60RCP	F-8
HBLBD01	J-9	HBLDMBL	H-8	HBLDS30PJ	F-5	HBLDS60RCPJ	F-8
HBLBD03	J-9	HBLDMBN	H-8	HBLDS30RC	F-8	HBLDS60T	F-5
HBLBD05	J-9	HBLDMGN	H-8	HBLDS30RCJ	F-8	HBLDS60TAC	F-5
HBLBG03	J-9	HBLDMO	H-8	HBLDS30RCP	F-8	HBLDS60TJ	F-5
HBLBG03L	J-9	HBLDMR	H-8	HBLDS30RCPJ	F-8	HBLDS60TP	F-5
HBLBG07	J-9	HBLDMW	H-8	HBLDS30T	F-5	HBLDS60TPAC	F-5
HBLBG07L	J-9	HBLDMY	H-8	HBLDS30TAC	F-5	HBLDS60TPJ	F-5
HBLBG10	J-9	HBLDS10	F-11, F-19	HBLDS30TACJ	F-5	HBLDS60TVFD	F-5
HBLBG10L	J-9	HBLDS100	F-5	HBLDS30TJ	F-5	HBLDS60VFD	F-5
HBLBG15	J-9	HBLDS100AC	F-5	HBLDS30TNK	F-5	HBLDS6AC	F-11, F-19
HBLBG15L	J-9	HBLDS100J	F-5	HBLDS30TP	F-5	HBLDS6J	F-11
HBLBG20	J-9	HBLDS100P	F-5	HBLDS30TPAC	F-5	HBLDS6P	F-11
HBLBG20L	J-9	HBLDS100PAC	F-5	HBLDS30TPJ	F-5	HBLDS6PAC	F-11
HBLBG20LSH	J-9	HBLDS100PJ	F-5	HBLDS30TVFD	F-5	HBLDS6PJ	F-11
HBLBG20SH	J-9	HBLDS100RC	F-8	HBLDS30TVFDJ	F-5	HBLDS6SS	F-7, F-19
HBLBG25	J-9	HBLDS100RCJ	F-8	HBLDS30VFD	F-5	HBLDS6SSAC	F-7, F-19
HBLBG25L	J-9	HBLDS100RCP	F-8	HBLDS30VFDJ	F-5	HBLDS6SSJ	F-7
				HBLDS33ACNK	F-5, F-19, F-11	HBLDS6SSP	F-7
				HBLDS33ACRS	F-5, F-11	HBLDS6SSPAC	F-7

Catalog Number Index

Catalog Number	Page	Catalog Number	Page	Catalog Number	Page	Catalog Number	Page
HBLDS6SSPJ	F-7	HBLFMR1A	S-70	HBLFRBBL	H-7	HBLI25164	J-2
HBLDS6SSR	F-7, F-19	HBLFMR1DG	S-70	HBLFRBBN	H-7	HBLI25164Y	J-2
HBLDS6SSRAC	F-7, F-19	HBLFMR3A	S-70	HBLFRBGN	H-7	HBLI340PB	J-4, J-3
HBLDS6SSRC	F-8	HBLFMR3DG	S-70	HBLFRBK	H-6	HBLI35103	J-2
HBLDS6SSRCJ	F-8	HBLFMR6A	S-70	HBLFRBL	H-6	HBLI35103Y	J-2
HBLDS6SSRCP	F-8	HBLFMR6DG	S-70	HBLFRBN	H-6	HBLI35104	J-2
HBLDS6SSRCPJ	F-8	HBLFMRFE	S-70	HBLFRBO	H-7	HBLI35104Y	J-2
HBLDS6SSRJ	F-7	HBLFMSPL	S-70	HBLFRBR	H-7	HBLI35123	J-2
HBLDS6SSRP	F-7	HBLFMTA	S-70	HBLFRBW	H-7	HBLI35123Y	J-2
HBLDS6SSRPAC	F-7	HBLFMTDG	S-70	HBLFRBY	H-7	HBLI35124	J-2
HBLDS6SSRPJ	F-7	HBLFMWCF	S-70	HBLFRGN	H-6	HBLI35124Y	J-2
HBLDS6SSRRC	F-8	HBLFMWHA	S-70	HBLFRGY	H-6	HBLI35143	J-2
HBLDS6SSRRCJ	F-8	HBLFMWHDG	S-70	HBLFRO	H-6	HBLI35143Y	J-2
HBLDS6SSRRCP	F-8	HBLFMWLA	S-70	HBLFRR	H-6	HBLI35144	J-2
HBLDS6SSRRCPJ	F-8	HBLFMWLDG	S-70	HBLFRSBK	H-6	HBLI35144Y	J-2
HBLDS6SSRVFD	F-19	HBLFMWPB	S-70	HBLFRSBL	H-6	HBLI35163	J-2
HBLDS6SSVFD	F-7	HBLFMWPF	S-70	HBLFRSBN	H-6	HBLI35163Y	J-2
HBLDS6VFD	F-11	HBLFMWRA	S-70	HBLFRSCBK	H-6	HBLI35164	J-2
HBLDSSRNK3	F-7	HBLFMWRDG	S-70	HBLFRSCBL	H-6	HBLI35164Y	J-2
HBLDSSRNK6	F-7	HBLFOABK	H-7	HBLFRSCBN	H-6	HBLI40104	J-2
HBLF3MBK	H-8	HBLFOABL	H-7	HBLFRSCEBK	H-6	HBLI40104Y	J-2
HBLF3MBL	H-8	HBLFOABN	H-7	HBLFRSCEBL	H-6	HBLI45103	J-2
HBLF3MBN	H-8	HBLFOAGN	H-7	HBLFRSCEBN	H-6	HBLI45103Y	J-2
HBLF3MGN	H-8	HBLFOAO	H-7	HBLFRSCEGN	H-6	HBLI45123	J-2
HBLF3MO	H-8	HBLFOAR	H-7	HBLFRSCEO	H-6	HBLI45123BLK	J-2
HBLF3MR	H-8	HBLFOAW	H-7	HBLFRSCER	H-6	HBLI45123C20	J-3
HBLF3MSGN	H-8	HBLFOAY	H-7	HBLFRSCEW	H-6	HBLI45123GF20	J-3
HBLF3MW	H-8	HBLFOSBK	H-7	HBLFRSCEY	H-6	HBLI45123GF220	J-3
HBLF3MY	H-8	HBLFOSBL	H-7	HBLFRSCGN	H-6	HBLI45123GF220M1	J-3
HBLFBBK	H-8	HBLFOSBN	H-7	HBLFRSCO	H-6	HBLI45123GFTT	J-3
HBLFBBL	H-8	HBLFOSGN	H-7	HBLFRSCR	H-6	HBLI45123R20	J-3
HBLFBBN	H-8	HBLFOSO	H-7	HBLFRSCW	H-6	HBLI45123R20M1	J-3
HBLFBGN	H-8	HBLFOSR	H-7	HBLFRSCY	H-6	HBLI45123R220	J-3
HBLFBO	H-8	HBLFOSW	H-7	HBLFRSGN	H-6	HBLI45123R220M1	J-3
HBLFBR	H-8	HBLFOSY	H-7	HBLFRSO	H-6	HBLI45123TL20	J-3
HBLFBW	H-8	HBLFRABK	H-7	HBLFRSR	H-6	HBLI45123Y	J-2
HBLFBY	H-8	HBLFRABBL	H-7	HBLFRSW	H-6	HBLI45124	J-2
HBLFCAPBK	H-7	HBLFRABBN	H-7	HBLFRSY	H-6	HBLI45124Y	J-2
HBLFCAPBL	H-7	HBLFRABGN	H-7	HBLFRW	H-6	HBLI45143	J-2
HBLFCAPBN	H-7	HBLFRABK	H-6	HBLFRY	H-6	HBLI45143C15	J-3
HBLFCAPGN	H-7	HBLFRABL	H-6	HBLGWEP	S-20, S-52, S-11, S-32, S-26	HBLI45143GF15	J-3
HBLFCAPO	H-7	HBLFRABN	H-6	HBLHCOAMB	M-8	HBLI45143GF215	J-3
HBLFCAPR	H-7	HBLFRABO	H-7	HBLHR2535	J-8	HBLI45143GF215M1	J-3
HBLFCAPW	H-7	HBLFRABR	H-7	HBLHR2550	J-8	HBLI45143R15	J-3
HBLFCAPY	H-7	HBLFRABW	H-7	HBLHR3825	J-8	HBLI45143R15M1	J-3
HBLFG30	F-28, F-27, F-23	HBLFRABY	H-7	HBLHR3850	J-8	HBLI45143R215	J-3
HBLFMC45A	S-70	HBLFRAGN	H-6	HBLHR3870	J-8	HBLI45143R215M1	J-3
HBLFMC45DG	S-70	HBLFRAO	H-6	HBLHR5035	J-8	HBLI45143Y	J-2
HBLFMC90A	S-70	HBLFRAR	H-6	HBLHR5050	J-8	HBLI45144	J-2
HBLFMC90DG	S-70	HBLFRASBK	H-6	HBLI10BS	J-4, J-3	HBLI45144Y	J-2
HBLFMD1D1K	S-70	HBLFRASBL	H-6	HBLI12BS	J-4, J-3	HBLI45163	J-2
HBLFMD1P1D	S-70	HBLFRASBN	H-6	HBLI14BS	J-4, J-3	HBLI45163IN	J-6
HBLFMD1P2D	S-70	HBLFRASGN	H-6	HBLI16BS	J-4, J-3, J-6	HBLI45163LED	J-6
HBLFMD2D	S-70	HBLFRASO	H-6	HBLI25103	J-2	HBLI45163Y	J-2
HBLFMD2P	S-70	HBLFRASR	H-6	HBLI25103Y	J-2	HBLI45164	J-2
HBLFMD2P1D	S-70	HBLFRASW	H-6	HBLI25104	J-2	HBLI45164Y	J-2
HBLFMES	S-70	HBLFRASY	H-6	HBLI25104Y	J-2	HBLI50CAT6	J-6
HBLFMEX	S-70	HBLFRAW	H-6	HBLI25123	J-2	HBLI50CAT6W	J-6
HBLFMPDD10A	S-70	HBLFRAY	H-6	HBLI25123Y	J-2	HBLI70123	J-2
HBLFMPDD10DG	S-70	HBLFRB2BK	H-7	HBLI25124	J-2	HBLI80103	J-2
HBLFMPDD15A	S-70	HBLFRB2BL	H-7	HBLI25124Y	J-2	HBLI80104	J-2
HBLFMPDD15DG	S-70	HBLFRB2BN	H-7	HBLI25143	J-2	HBLI80124	J-2
HBLFMPUD10A	S-70	HBLFRB2GN	H-7	HBLI25143Y	J-2	HBLI90123	J-2
HBLFMPUD10DG	S-70	HBLFRB2O	H-7	HBLI25144	J-2	HBLIACOMB	J-4, J-3
HBLFMPUD15A	S-70	HBLFRB2R	H-7	HBLI25144Y	J-2	HBLIACOMBJ	J-4, J-3
HBLFMPUD15DG	S-70	HBLFRB2W	H-7	HBLI25163	J-2	HBLIMB	J-4, J-3
HBLFMR123A	S-70	HBLFRB2Y	H-7	HBLI25163Y	J-2	HBLIMBJ	J-4, J-3
HBLFMR123DG	S-70	HBLFRBBK	H-7			HBLIMFBK	Y-13

Catalog Number Index

Catalog Number	Page	Catalog Number	Page	Catalog Number	Page	Catalog Number	Page
HBLIMFGY	Y-13	HBLMRASBK	H-6	HBLNCBL	H-7	HBLPP12GFI	R-4
HBLIMFI	Y-13	HBLMRASBL	H-6	HBLNCBN	H-7	HBLPP12GFOV	R-4
HBLIMFWA	Y-13	HBLMRASBN	H-6	HBLNCC	H-7	HBLPP12GFW	R-4
HBLIPRBOX	J-3	HBLMRASGN	H-6	HBLNCGN	H-7	HBLPP12OW	R-4
HBLIWC45123	J-2	HBLMRASO	H-6	HBLNCO	H-7	HBLPP12W	R-4
HBLIWC45123C20HG	J-6	HBLMRASR	H-6	HBLNCR	H-7	HBLPP15A	R-4
HBLIWC45123GF220HG	J-6	HBLMRASW	H-6	HBLNCW	H-7	HBLPP15AAL	R-4
HBLIWC45123R220HG	J-6	HBLMRASY	H-6	HBLNCY	H-7	HBLPP15AI	R-4
HBLIWEP	S-8, S-20, S-52, S-11, S-32, S-26, S-16	HBLMRAW	H-6	HBLOC03	J-10	HBLPP15BK	R-4
HBLM3FBK	H-8	HBLMRAY	H-6	HBLOC05	J-10	HBLPP15GF	R-4
HBLM3FBL	H-8	HBLMRB2BK	H-7	HBLOC10	J-10	HBLPP15GFAL	R-4
HBLM3FBN	H-8	HBLMRB2BL	H-7	HBLOC15	J-10	HBLPP15GFBK	R-4
HBLM3FGN	H-8	HBLMRB2BN	H-7	HBLP14FS	H-15, C-9, AA-50, C-12	HBLPP15GFI	R-4
HBLM3FO	H-8	HBLMRB2GN	H-7	HBLP14FSL	H-15, C-12	HBLPP15GFOV	R-4
HBLM3FR	H-8	HBLMRB2O	H-7	HBLP26FS	H-15, C-12	HBLPP15GFW	R-4
HBLM3FSBK	H-8	HBLMRB2R	H-7	HBLP26FSL	H-15, C-12	HBLPP15OW	R-4
HBLM3FW	H-8	HBLMRB2W	H-7	HBLP720FS	H-15, C-12	HBLPP15W	R-4
HBLM3FY	H-8	HBLMRB2Y	H-7	HBLP7FS	H-15, C-12	HBLPPO12A	R-4
HBLMBBK	H-8	HBLMRBBK	H-7	HBLP8FS	H-15, C-12	HBLPPO12AAL	R-4
HBLMBBL	H-8	HBLMRBBL	H-7	HBLP8FSL	H-15, C-12	HBLPPO12AI	R-4
HBLMBBN	H-8	HBLMRBBN	H-7	HBLP8FSY	H-15, C-12	HBLPPO12BK	R-4
HBLMBGN	H-8	HBLMRBGN	H-7	HBLPHTVNM	AA-4, AA-32	HBLPPO12OW	R-4
HBLMBO	H-8	HBLMRBK	H-6	HBLPHTVSS	AA-4, AA-32	HBLPPO12W	R-4
HBLMBR	H-8	HBLMRBL	H-6	HBLPK	H-8	HBLPPO15A	R-4
HBLMBW	H-8	HBLMRBN	H-6	HBLPKL520	B-51	HBLPPO15AAL	R-4
HBLMBY	H-8	HBLMRBO	H-7	HBLPMIBL	B-4	HBLPPO15AI	R-4
HBLMCAPBK	H-7	HBLMRBR	H-7	HBLPMIDBL	B-4	HBLPPO15BK	R-4
HBLMCAPBL	H-7	HBLMRBW	H-7	HBLPMODGY	B-4	HBLPPO15OW	R-4
HBLMCAPBN	H-7	HBLMRBY	H-7	HBLPMOGY	B-4	HBLPPO15W	R-4
HBLMCAPGN	H-7	HBLMRGN	H-6	HBLPMRP	B-4	HBLPPOA	R-4
HBLMCAPO	H-7	HBLMRGY	H-6	HBLPMSC	B-4	HBLPPOAAL	R-4
HBLMCAPR	H-7	HBLMRO	H-6	HBLPOB1	H-15, C-12	HBLPPOAI	R-4
HBLMCAPW	H-7	HBLMRR	H-6	HBLPOB1BK	H-15, C-12	HBLPPOBK	R-4
HBLMCAPY	H-7	HBLMRSBK	H-6	HBLPOB1D	H-15, C-12	HBLPPOOW	R-4
HBLMITL	B-41, B-30, B-20, C-3, B-34, B-26, B-22, B-32	HBLMRSBL	H-6	HBLPOB1DL	H-15, C-12	HBLPPOW	R-4
HBLML2825L	H-16	HBLMRSBN	H-6	HBLPOB1DY	H-15, C-12	HBLPTBK	H-8
HBLMOABK	H-7	HBLMRSCBK	H-6	HBLPOB1L	H-15, C-12	HBLPTBL	H-8
HBLMOABL	H-7	HBLMRSCBL	H-6	HBLPP10A	R-4	HBLPTBN	H-8
HBLMOABN	H-7	HBLMRSCBN	H-6	HBLPP10AAL	R-4	HBLPTGN	H-8
HBLMOAGN	H-7	HBLMRSCBK	H-6	HBLPP10AI	R-4	HBLPTO	H-8
HBLMOAO	H-7	HBLMRSCBL	H-6	HBLPP10BK	R-4	HBLPTR	H-8
HBLMOAR	H-7	HBLMRSCBN	H-6	HBLPP10GF	R-4	HBLPTW	H-8
HBLMOAW	H-7	HBLMRSCBN	H-6	HBLPP10GFAL	R-4	HBLPTY	H-8
HBLMOAY	H-7	HBLMRSCGN	H-6	HBLPP10GFBK	R-4	HBLRFT1	B-41, I-6, F-11, F-5, B-39, I-5
HBLMOSBK	H-7	HBLMRSCO	H-6	HBLPP10GFI	R-4	HBLRFT2	F-11, G-26, F-5, G-23, F-17, G-47
HBLMOSBL	H-7	HBLMRSCO	H-6	HBLPP10IGA	R-4	HBLRRELCI	AA-7
HBLMOSBN	H-7	HBLMRSCO	H-6	HBLPP10IGAI	R-4	HBLRS	H-8
HBLMOSGN	H-7	HBLMRSCR	H-6	HBLPP10IGAL	R-4	HBS330C4W	G-6
HBLMOSO	H-7	HBLMRSCW	H-6	HBLPP10IGBK	R-4	HBS330C6W	G-6
HBLMOSR	H-7	HBLMRSCY	H-6	HBLPP10IGOW	R-4	HBS330C7W	G-6
HBLMOSW	H-7	HBLMRSGN	H-6	HBLPP10IGW	R-4	HBS330R4W	G-6
HBLMOSY	H-7	HBLMRSO	H-6	HBLPP10OW	R-4	HBS330R6W	G-6
HBLMRABBK	H-7	HBLMRSR	H-6	HBLPP10SA	R-4	HBS330R7W	G-6
HBLMRABBL	H-7	HBLMRSW	H-6	HBLPP10SAI	R-4	HBS332C4W	G-6
HBLMRABBN	H-7	HBLMRSY	H-6	HBLPP10SAL	R-4	HBS332R4W	G-6
HBLMRABGN	H-7	HBLMRW	H-6	HBLPP10SBK	R-4	HBS360C4W	G-6
HBLMRABK	H-6	HBLMRX	H-6	HBLPP10SOW	R-4	HBS360C6W	G-6
HBLMRABL	H-6	HBLNCABK	H-7	HBLPP10SW	R-4	HBS360C7W	G-6
HBLMRABN	H-6	HBLNCABL	H-7	HBLPP10W	R-4	HBS360R4W	G-6
HBLMRABO	H-7	HBLNCABN	H-7	HBLPP12A	R-4	HBS360R6W	G-6
HBLMRABR	H-7	HBLNCAGN	H-7	HBLPP12AAL	R-4	HBS360R7W	G-6
HBLMRABW	H-7	HBLNCAO	H-7	HBLPP12AI	R-4	HBS4100C12W	G-7
HBLMRABY	H-7	HBLNCAR	H-7	HBLPP12BK	R-4	HBS4100C5W	G-7
HBLMRAGN	H-6	HBLNCAW	H-7	HBLPP12GF	R-4	HBS4100C6W	G-7
HBLMRAO	H-6	HBLNCAY	H-7	HBLPP12GFAL	R-4	HBS4100C7W	G-7
HBLMRAR	H-6	HBLNCBK	H-7	HBLPP12GFBK	R-4	HBS4100C9W	G-7

Catalog Number Index

Catalog Number	Page	Catalog Number	Page	Catalog Number	Page	Catalog Number	Page
HBSL4100R12W	G-7	HBLSCBL	H-8	HBLTT5B	V-4	HBLW75104W	J-4
HBSL4100R5W	G-7	HBLSCBN	H-8	HBLTT5ECB	V-4	HBLW75124W	J-4
HBSL4100R6W	G-7	HBLSCCBK	H-8	HBLTVSS	AA-4, AA-32	HBLW80123W	J-4
HBSL4100R7W	G-7	HBLSCCBL	H-8	HBLTW	H-8	HBLWGB030560	J-10
HBSL4100R9W	G-7	HBLSCCBN	H-8	HBLTY	H-8	HBLWKB030560	J-10
HBSL430C12W	G-6	HBLSCCGN	H-8	HBLVCGBK	A-53	HBLWL25LED	H-16
HBSL430C5W	G-6	HBLSCCO	H-8	HBLVP3385	G-50, F-21	HBLWL25LEDT	H-16
HBSL430C5WC	G-7	HBLSCCR	H-8	HBLVP3485	G-50, F-21	HBLWLC	N-22
HBSL430C6W	G-6	HBLSCCUBPD	O-41	HBLVP6385	G-50, F-21	HBLWMAN05C	J-10
HBSL430C7W	G-6	HBLSCCUBPDSS	O-41	HBLVP6485	G-50, F-21	HBLWBP505A	J-10
HBSL430C7WC	G-7	HBLSCCUBPDW	O-41	HBLVSQ3023	G-50, F-21	HBLWPBS	J-5
HBSL430C9W	G-6	HBLSCCUBPDWSS	O-41	HBLVSQ3034	G-50, F-21	HBLWS50BTL	J-10
HBSL430R12W	G-6	HBLSCCUBW	O-41	HBLVSQ6023	G-50, F-21	HBLWS50BTS	J-10
HBSL430R5W	G-6	HBLSCCUBWSS	O-41	HBLVSQ6034	G-50, F-21	HBLWBT1	C-8
HBSL430R5WC	G-7	HBLSCCW	H-8	HBLW25103	J-4	HBLWBT2	C-8
HBSL430R6W	G-6	HBLSCCY	H-8	HBLW25103W	J-4	HBLWBT3	C-8
HBSL430R7W	G-6	HBLSCF0808RC	X-11	HBLW25104	J-4	HBLWTCS1	C-8
HBSL430R7WC	G-7	HBLSCF1212RC	X-11	HBLW25104W	J-4	HBLWTCS2	C-8
HBSL430R9W	G-6	HBLSCGN	H-8	HBLW25123	J-4	HBLWTCS3	C-8
HBSL432C3W	G-6	HBLSCO	H-8	HBLW25123W	J-4	HBLWTGF120	C-10, K-20
HBSL432R3W	G-6	HBLSCR	H-8	HBLW25124	J-4	HBLWTGF240	C-10, K-20
HBSL460C12W	G-6	HBLSCW	H-8	HBLW25124W	J-4	HBLWWEP	S-8
HBSL460C5W	G-6	HBLSCY	H-8	HBLW25143	J-4	HBRLXT180	E-11
HBSL460C5WC	G-7	HBLSDSA36	M-7, M-22	HBLW25143W	J-4	HBRLXT360	E-11
HBSL460C6W	G-6	HBLSS263R	N-27, AA-48	HBLW25144	J-4	HBRLXTA	E-11
HBSL460C7W	G-6	HBLSS264X	N-27, AA-48	HBLW25144W	J-4	HBRLXTEA	E-11
HBSL460C7WC	G-7	HBLSS26WIS	N-27	HBLW25163	J-4	HBSXT13	E-11
HBSL460C9W	G-6	HBLSS3	B-42	HBLW25163W	J-4	HBSXT14D	E-11
HBSL460R12W	G-6	HBLSS45	B-42	HBLW25164	J-4	HBSXT14DSM	E-11
HBSL460R5W	G-6	HBLSS83R	N-27, AA-48	HBLW25164W	J-4	HBSXT23	E-11
HBSL460R6W	G-6	HBLSS84X	N-27, AA-48	HBLW35103	J-4	HBSXT24	E-11
HBSL460R7W	G-6	HBLSTMC	H-16	HBLW35103W	J-4	HBSXT24D	E-11
HBSL460R9W	G-6	HBLSTMG	H-16	HBLW35104	J-4	HBSXT24DSM	E-11
HBSL5100C5W	G-7	HBLSTPG	H-16	HBLW35104W	J-4	HBSXT28	E-11
HBSL5100C6W	G-7	HBLSTRB	B-52	HBLW35123	J-4	HBSXT48	E-11
HBSL5100C7W	G-7	HBLT2311	BB-3, B-52	HBLW35123W	J-4	HBT0204	U-3
HBSL5100C9W	G-7	HBLT2321	BB-3, B-52	HBLW35124	J-4	HBT0204BK	U-3
HBSL5100R5W	G-7	HBLT2331	BB-3, B-52	HBLW35124W	J-4	HBT0204S	U-5
HBSL5100R6W	G-7	HBLT2411	BB-3, B-52	HBLW35143	J-4	HBT0204S04	U-6
HBSL5100R7W	G-7	HBLT2611	BB-3, B-52	HBLW35143W	J-4	HBT0204S16	U-6
HBSL5100R9W	G-7	HBLT2621	BB-3, B-52	HBLW35144	J-4	HBT0204SBK	U-5
HBSL530C5W	G-6	HBLT26CM11	AA-40, B-52, BB-3	HBLW35144W	J-4	HBT0204ZP	U-4
HBSL530C6W	G-6	HBLT2711	BB-3, B-52	HBLW35163	J-4	HBT0206	U-3
HBSL530C7W	G-6	HBLT3521	BB-3, B-52	HBLW35163W	J-4	HBT0206BK	U-3
HBSL530C9W	G-6	HBLT3721	BB-3, B-52	HBLW35164	J-4	HBT0206S	U-5
HBSL530R5W	G-6	HBLTBK	H-8	HBLW35164W	J-4	HBT0206S04	U-6
HBSL530R6W	G-6	HBLTBL	H-8	HBLW40103	J-4	HBT0206S16	U-6
HBSL530R7W	G-6	HBLTBN	H-8	HBLW40103W	J-4	HBT0206SBK	U-5
HBSL530R9W	G-6	HBLTGN	H-8	HBLW40124	J-4	HBT0206ZP	U-4
HBSL560C5W	G-6	HBLTO	H-8	HBLW40124W	J-4	HBT0208	U-3
HBSL560C6W	G-6	HBLTQ1507	J-9	HBLW45123	J-4	HBT0208BK	U-3
HBSL560C7W	G-6	HBLTQ1510	J-9	HBLW45123W	J-4	HBT0208S	U-5
HBSL560C9W	G-6	HBLTQ1515	J-9	HBLW45128W	J-4	HBT0208S04	U-6
HBSL560R5W	G-6	HBLTR	H-8	HBLW45142W	J-4	HBT0208S16	U-6
HBSL560R6W	G-6	HBLTRED5B	V-5	HBLW45143	J-4	HBT0208SBK	U-5
HBSL560R7W	G-6	HBLTRED5ECB	V-5	HBLW45143W	J-4	HBT0208ZP	U-4
HBSL560R9W	G-6	HBLTRED5ECFB	V-5	HBLW45144	J-4	HBT0212	U-3
HBSLBDPCC	O-41	HBLTRED5XB	V-5	HBLW45144W	J-4	HBT0212BK	U-3
HBLSC080803NKSTRC	X-11	HBLTRED5YB	V-5	HBLW45163	J-4	HBT0212S	U-5
HBLSC080803STRC	X-11	HBLTS	H-8	HBLW45163W	J-4	HBT0212S04	U-6
HBLSC121204NKSTRC	X-11	HBLTSR	H-8	HBLW45164	J-4	HBT0212S16	U-6
HBLSC121204STRC	X-11	HBLTT2B	V-4	HBLW45164W	J-4	HBT0212SBK	U-5
HBLSCBD1	J-10	HBLTT30P	A-46	HBLW4563W	J-4	HBT0212ZP	U-4
HBLSCBG1	J-10	HBLTT30R	A-46	HBLW4564W	J-4	HBT0216	U-3
HBLSCBG2	J-10	HBLTT3B	V-4	HBLW4583W	J-4	HBT0216BK	U-3
HBLSCBG3	J-10	HBLTT3ECB	V-4	HBLW4584W	J-4	HBT0216S	U-5
HBLSCBH3	J-10	HBLTT545LB	V-4	HBLW6083W	J-4	HBT0216S04	U-6
HBLSCBK	H-8	HBLTT545RB	V-4	HBLW75103W	J-4	HBT0216S16	U-6

Catalog Number Index

Catalog Number	Page	Catalog Number	Page	Catalog Number	Page	Catalog Number	Page
HBT0216SBK	U-5	HBT0406S04	U-6	HBT0612BK	U-3	HBT0818ZP	U-4
HBT0216ZP	U-4	HBT0406S16	U-6	HBT0612S	U-5	HBT0820	U-3
HBT0218	U-3	HBT0406SBK	U-5	HBT0612S04	U-6	HBT0820BK	U-3
HBT0218BK	U-3	HBT0406ZP	U-4	HBT0612S16	U-6	HBT0820S	U-5
HBT0218S	U-5	HBT0408	U-3	HBT0612SBK	U-5	HBT0820S04	U-6
HBT0218S04	U-6	HBT0408BK	U-3	HBT0612ZP	U-4	HBT0820S16	U-6
HBT0218S16	U-6	HBT0408S	U-5	HBT0616	U-3	HBT0820SBK	U-5
HBT0218SBK	U-5	HBT0408S04	U-6	HBT0616BK	U-3	HBT0820ZP	U-4
HBT0218ZP	U-4	HBT0408S16	U-6	HBT0616S	U-5	HBT300204	U-9
HBT0220	U-3	HBT0408SBK	U-5	HBT0616S04	U-6	HBT300206	U-9
HBT0220BK	U-3	HBT0408ZP	U-4	HBT0616S16	U-6	HBT300208	U-9
HBT0220S	U-5	HBT0412	U-3	HBT0616SBK	U-5	HBT300212	U-9
HBT0220S04	U-6	HBT0412BK	U-3	HBT0616ZP	U-4	HBT300216	U-9
HBT0220S16	U-6	HBT0412S	U-5	HBT0618	U-3	HBT300218	U-9
HBT0220SBK	U-5	HBT0412S04	U-6	HBT0618BK	U-3	HBT300220	U-9
HBT0220ZP	U-4	HBT0412S16	U-6	HBT0618S	U-5	HBT300224	U-9
HBT0222	U-3	HBT0412SBK	U-5	HBT0618S04	U-6	HBT300404	U-9
HBT0222BK	U-3	HBT0412ZP	U-4	HBT0618S16	U-6	HBT300406	U-9
HBT0222S	U-5	HBT0416	U-3	HBT0618SBK	U-5	HBT300408	U-9
HBT0222S04	U-6	HBT0416BK	U-3	HBT0618ZP	U-4	HBT300412	U-9
HBT0222S16	U-6	HBT0416S	U-5	HBT0620	U-3	HBT300416	U-9
HBT0222SBK	U-5	HBT0416S04	U-6	HBT0620BK	U-3	HBT300418	U-9
HBT0222ZP	U-4	HBT0416S16	U-6	HBT0620S	U-5	HBT300420	U-9
HBT0224	U-3	HBT0416SBK	U-5	HBT0620S04	U-6	HBT300424	U-9
HBT0224BK	U-3	HBT0416ZP	U-4	HBT0620S16	U-6	HBT300608	U-9
HBT0224S	U-5	HBT0418	U-3	HBT0620SBK	U-5	HBT300612	U-9
HBT0224S04	U-6	HBT0418BK	U-3	HBT0620ZP	U-4	HBT300616	U-9
HBT0224S16	U-6	HBT0418S	U-5	HBT0622	U-3	HBT300618	U-9
HBT0224SBK	U-5	HBT0418S04	U-6	HBT0622BK	U-3	HBT300620	U-9
HBT0224ZP	U-4	HBT0418S16	U-6	HBT0622S	U-5	HBT300624	U-9
HBT0226	U-3	HBT0418SBK	U-5	HBT0622S04	U-6	HBT450204	U-9
HBT0226BK	U-3	HBT0418ZP	U-4	HBT0622S16	U-6	HBT450206	U-9
HBT0226S	U-5	HBT0420	U-3	HBT0622SBK	U-5	HBT450208	U-9
HBT0226S04	U-6	HBT0420BK	U-3	HBT0622ZP	U-4	HBT450212	U-9
HBT0226S16	U-6	HBT0420S	U-5	HBT0624	U-3	HBT450216	U-9
HBT0226SBK	U-5	HBT0420S04	U-6	HBT0624BK	U-3	HBT450218	U-9
HBT0226ZP	U-4	HBT0420S16	U-6	HBT0624S	U-5	HBT450220	U-9
HBT0228	U-3	HBT0420SBK	U-5	HBT0624S04	U-6	HBT450224	U-9
HBT0228BK	U-3	HBT0420ZP	U-4	HBT0624S16	U-6	HBT450404	U-9
HBT0228S	U-5	HBT0422	U-3	HBT0624SBK	U-5	HBT450406	U-9
HBT0228S04	U-6	HBT0422BK	U-3	HBT0624ZP	U-4	HBT450408	U-9
HBT0228S16	U-6	HBT0422S	U-5	HBT0808	U-3	HBT450412	U-9
HBT0228SBK	U-5	HBT0422S04	U-6	HBT0808BK	U-3	HBT450416	U-9
HBT0228ZP	U-4	HBT0422S16	U-6	HBT0808S	U-5	HBT450418	U-9
HBT0230	U-3	HBT0422SBK	U-5	HBT0808S04	U-6	HBT450420	U-9
HBT0230BK	U-3	HBT0422ZP	U-4	HBT0808S16	U-6	HBT450424	U-9
HBT0230S	U-5	HBT0424	U-3	HBT0808SBK	U-5	HBT450608	U-9
HBT0230S04	U-6	HBT0424BK	U-3	HBT0808ZP	U-4	HBT450612	U-9
HBT0230S16	U-6	HBT0424S	U-5	HBT0812	U-3	HBT450616	U-9
HBT0230SBK	U-5	HBT0424S04	U-6	HBT0812BK	U-3	HBT450618	U-9
HBT0230ZP	U-4	HBT0424S16	U-6	HBT0812S	U-5	HBT450620	U-9
HBT0232	U-3	HBT0424SBK	U-5	HBT0812S04	U-6	HBT450624	U-9
HBT0232BK	U-3	HBT0424ZP	U-4	HBT0812S16	U-6	HBTBS	U-12
HBT0232S	U-5	HBT0428	U-3	HBT0812SBK	U-5	HBTBSBK	U-12
HBT0232S04	U-6	HBT0428BK	U-3	HBT0812ZP	U-4	HBTBSSS	U-12
HBT0232S16	U-6	HBT0428S	U-5	HBT0816	U-3	HBTCA3	U-12
HBT0232SBK	U-5	HBT0428S04	U-6	HBT0816BK	U-3	HBTCA3BK	U-12
HBT0232ZP	U-4	HBT0428S16	U-6	HBT0816S	U-5	HBTCB12	U-10
HBT0404	U-3	HBT0428SBK	U-5	HBT0816S04	U-6	HBTCB12BK	U-10
HBT0404BK	U-3	HBT0428ZP	U-4	HBT0816S16	U-6	HBTCB18	U-10
HBT0404S	U-5	HBT0608	U-3	HBT0816SBK	U-5	HBTCB18BK	U-10
HBT0404S04	U-6	HBT0608BK	U-3	HBT0816ZP	U-4	HBTCB4	U-10
HBT0404S16	U-6	HBT0608S	U-5	HBT0818	U-3	HBTCB4BK	U-10
HBT0404SBK	U-5	HBT0608S04	U-6	HBT0818BK	U-3	HBTCB8	U-10
HBT0404ZP	U-4	HBT0608S16	U-6	HBT0818S	U-5	HBTCB8BK	U-10
HBT0406	U-3	HBT0608SBK	U-5	HBT0818S04	U-6	HBTCD4X4BK	U-12
HBT0406BK	U-3	HBT0608ZP	U-4	HBT0818S16	U-6	HBTCDG	U-12
HBT0406S	U-5	HBT0612	U-3	HBT0818SBK	U-5	HBTCSB	U-12

Catalog Number Index

Catalog Number	Page	Catalog Number	Page	Catalog Number	Page	Catalog Number	Page
HBTCCLGS12	U-10	HBTFRMINS0224BK	U-11	HBTINSNM24WHT	U-11	HBTS8BK	U-10
HBTCCLGS12BK	U-10	HBTFRMINS0404BK	U-11	HBTLB12	U-10	HBSTRUTCLIP	U-12
HBTCCLGS16	U-10	HBTFRMINS0406BK	U-11	HBTLB12BK	U-10	HBTT0204	U-9
HBTCCLGS16BK	U-10	HBTFRMINS0408BK	U-11	HBTLB16	U-10	HBTT0206	U-9
HBTCCLGS18	U-10	HBTFRMINS0412BK	U-11	HBTLB16BK	U-10	HBTT0208	U-9
HBTCCLGS18BK	U-10	HBTFRMINS0416BK	U-11	HBTLB18	U-10	HBTT0212	U-9
HBTCCLGS20	U-10	HBTFRMINS0418BK	U-11	HBTLB18BK	U-10	HBTT0216	U-9
HBTCCLGS20BK	U-10	HBTFRMINS0420BK	U-11	HBTLB20	U-10	HBTT0218	U-9
HBTCCLGS24	U-10	HBTFRMINS0424BK	U-11	HBTLB20BK	U-10	HBTT0220	U-9
HBTCCLGS24BK	U-10	HBTFRMINS0608BK	U-11	HBTLB24	U-10	HBTT0224	U-9
HBTCSS	U-12, U-13	HBTFRMINS0612BK	U-11	HBTLB24BK	U-10	HBTT0404	U-9
HBTCSSBK	U-12	HBTFRMINS0616BK	U-11	HBTLB4	U-10	HBTT0406	U-9
HBTCSSS	U-12, U-6	HBTFRMINS0618BK	U-11	HBTLB4BK	U-10	HBTT0408	U-9
HBTCSTRS12	U-10	HBTFRMINS0620BK	U-11	HBTLB6	U-10	HBTT0412	U-9
HBTCSTRS12BK	U-10	HBTFRMINS0624BK	U-11	HBTLB6BK	U-10	HBTT0416	U-9
HBTCSTRS16	U-10	HBTI0204	U-9	HBTLB8	U-10	HBTT0418	U-9
HBTCSTRS16BK	U-10	HBTI0206	U-9	HBTLB8BK	U-10	HBTT0420	U-9
HBTCSTRS18	U-10	HBTI0208	U-9	HBTLB	U-12	HBTT0424	U-9
HBTCSTRS18BK	U-10	HBTI0212	U-9	HBTNB	U-12	HBTT0608	U-9
HBTCSTRS20	U-10	HBTI0216	U-9	HBTNBSS	U-12, U-6	HBTT0612	U-9
HBTCSTRS20BK	U-10	HBTI0218	U-9	HBTR0204	U-9	HBTT0616	U-9
HBTCSTRS24	U-10	HBTI0220	U-9	HBTR0206	U-9	HBTT0618	U-9
HBTCSTRS24BK	U-10	HBTI0224	U-9	HBTR0208	U-9	HBTT0620	U-9
HBTCSTRS4	U-10	HBTI0404	U-9	HBTR0212	U-9	HBTT0624	U-9
HBTCSTRS4BK	U-10	HBTI0406	U-9	HBTR0216	U-9	HBTT8	U-10
HBTCSTRS6	U-10	HBTI0408	U-9	HBTR0218	U-9	HBTT812	U-11
HBTCSTRS6BK	U-10	HBTI0412	U-9	HBTR0220	U-9	HBTT812BK	U-11
HBTCSTRS8	U-10	HBTI0416	U-9	HBTR0224	U-9	HBTT816	U-11
HBTCSTRS8BK	U-10	HBTI0418	U-9	HBTR0404	U-9	HBTT816BK	U-11
HBTCUTTOOL	U-13	HBTI0420	U-9	HBTR0406	U-9	HBTT818	U-11
HBTCVR12	U-11	HBTI0424	U-9	HBTR0408	U-9	HBTT818BK	U-11
HBTCVR12BK	U-11	HBTI0608	U-9	HBTR0412	U-9	HBTT820	U-11
HBTCVR16	U-11	HBTI0612	U-9	HBTR0416	U-9	HBTT820BK	U-11
HBTCVR16BK	U-11	HBTI0616	U-9	HBTR0418	U-9	HBTT824	U-11
HBTCVR18	U-11	HBTI0618	U-9	HBTR0420	U-9	HBTT824BK	U-11
HBTCVR18BK	U-11	HBTI0620	U-9	HBTR0424	U-9	HBTT86	U-11
HBTCVR20	U-11	HBTI0624	U-9	HBTR0608	U-9	HBTT86BK	U-11
HBTCVR20BK	U-11	HBTINSM04	U-11	HBTR0612	U-9	HBTT88	U-11
HBTCVR24	U-11	HBTINSM04BK	U-11	HBTR0616	U-9	HBTT88BK	U-11
HBTCVR24BK	U-11	HBTINSM06	U-11	HBTR0618	U-9	HBTT8BK	U-10
HBTCVR4	U-11	HBTINSM06BK	U-11	HBTR0620	U-9	HBTTUCB12	U-7
HBTCVR4BK	U-11	HBTINSM08	U-11	HBTR0624	U-9	HBTTUCB6	U-7
HBTCVR6	U-11	HBTINSM08BK	U-11	HBTRA	U-12	HBTTUFI	U-7
HBTCVR6BK	U-11	HBTINSM12	U-11	HBTRABK	U-12	HBTTUGS	U-7, U-12
HBTCVR8	U-11	HBTINSM12BK	U-11	HBTRD12BK	U-12	HBTTUPC	U-7
HBTCVR8BK	U-11	HBTINSM16	U-11	HBTRD4BK	U-12	HBTTUPK	U-7
HBTDIV2	U-11	HBTINSM16BK	U-11	HBTRD6BK	U-12	HBTTUSUPP10	U-7
HBTDIV2BK	U-11	HBTINSM18	U-11	HBTSC	U-12	HBTTUSUPP12	U-7
HBTDIV4	U-11	HBTINSM18BK	U-11	HBTSCBK	U-12	HBTTUSUPP14	U-7
HBTDIV4BK	U-11	HBTINSM20	U-11	HBTSK	U-12, U-13, U-14	HBTTUSUPP16	U-7
HBTDIV6	U-11	HBTINSM20BK	U-11	HBTSKBK	U-12	HBTTUSUPP18	U-7
HBTDIV6BK	U-11	HBTINSM24	U-11	HBTSKSS	U-12, U-6	HBTTUSUPP20	U-7
HBTDIV8	U-11	HBTINSM24BK	U-11	HBTSPPLITBOLTPK10	U-12	HBTTUSUPP22	U-7
HBTDIV8BK	U-11	HBTINSNM04	U-11	HBTS812	U-10	HBTTUSUPP24	U-7
HBTEB	U-12	HBTINSNM04WHT	U-11	HBTS812BK	U-10	HBTTUSUPP26	U-7
HBTEBBL	U-12	HBTINSNM06	U-11	HBTS816	U-10	HBTTUSUPP28	U-7
HBTEXTRDBK	U-12	HBTINSNM06WHT	U-11	HBTS816BK	U-10	HBTTUSUPP30	U-7
HBTF2	U-12	HBTINSNM08	U-11	HBTS818	U-10	HBTTUSUPP4	U-7
HBTF2BK	U-12	HBTINSNM08WHT	U-11	HBTS818BK	U-10	HBTTUSUPP6	U-7
HBTF46	U-12	HBTINSNM12	U-11	HBTS820	U-10	HBTTUSUPP8	U-7
HBTF46BK	U-12	HBTINSNM12WHT	U-11	HBTS820BK	U-10	HBTTUVU	U-7
HBTFRMINS0204BK	U-11	HBTINSNM16	U-11	HBTS824	U-10	HBTTVD	U-12
HBTFRMINS0206BK	U-11	HBTINSNM16WHT	U-11	HBTS824BK	U-10	HBTTVDBK	U-12
HBTFRMINS0208BK	U-11	HBTINSNM18	U-11	HBTS84	U-10	HBTTWS	U-12
HBTFRMINS0212BK	U-11	HBTINSNM18WHT	U-11	HBTS84BK	U-10	HBTTWSBK	U-12
HBTFRMINS0216BK	U-11	HBTINSNM20	U-11	HBTS86	U-10	HBTTWSS	U-12, U-6
HBTFRMINS0218BK	U-11	HBTINSNM20WHT	U-11	HBTS86BK	U-10	HCT101141	U-10
HBTFRMINS0220BK	U-11	HBTINSNM24	U-11	HBTS88	U-10	HCT10114K	U-10

Catalog Number Index

Catalog Number	Page	Catalog Number	Page	Catalog Number	Page	Catalog Number	Page
HCT102191	I-10	HJ1012GPK25	W-76	HLO0690G	U-36	HRCB12PWHT	X-5
HCT10219K	I-10	HJ1013BPK25	W-76	HLO1290B	U-36	HRCB12WHT	X-5
HCT161191	I-10	HJ1013GPK25	W-76	HLO1290G	U-36	HRCB22FAN	X-5
HCT16119K	I-10	HJ1014BPK25	W-76	HLO1890B	U-36	HRCB22HCFK	X-5
HCT161341	I-10	HJ1014GPK25	W-76	HLO1890G	U-36	HRCB22PWHT	X-5
HCT16134K	I-10	HJ1015BPK25	W-76	HLO2490B	U-36	HRCB22WHT	X-5
HCT162191	I-10	HJ1015GPK25	W-76	HLO2490G	U-36	HRCBMNT1	X-5
HCT16219K	I-10	HJ1038BPK25	W-76	HLP06B	U-37	HRCBTHRD	X-5
HCT162341	I-10	HJ1038GPK25	W-76	HLP06G	U-37	HRWB25BE075	X-6
HCT16234K	I-10	HJ1039BPK25	W-76	HLP08B	U-37	HRWB25BLK	X-6
HCT163341	I-10	HJ1039GPK25	W-76	HLP08G	U-37	HRWB25BLKRC	X-6
HCT16334K	I-10	HJ1040BPK25	W-76	HLP10B	U-37	HRWB25WHT	X-6
HCT164341	I-10	HJ1040GPK25	W-76	HLP10G	U-37	HRWB25WHTRC	X-6
HCT16434K	I-10	HJ1041BPK25	W-76	HLRF	U-37	HS1001BPK25	W-76
HCT251341	I-10	HJ1041GPK25	W-76	HLS0606B	U-36	HS1001GPK25	W-76
HCT25134K	I-10	HJ1042BPK25	W-76	HLS0606G	U-36	HS1002BPK25	W-76
HCT252341	I-10	HJ1042GPK25	W-76	HLS0612B	U-36	HS1002GPK25	W-76
HCT25234K	I-10	HJ1043BPK25	W-76	HLS0612G	U-36	HS1003BPK25	W-76
HCT252471	I-10	HJ1043GPK25	W-76	HLS0618B	U-36	HS1003GPK25	W-76
HCT25247K	I-10	HJ1044BPK25	W-76	HLS0618G	U-36	HS1004BPK25	W-76
HCT253471	I-10	HJ1044GPK25	W-76	HLS0624B	U-36	HS1004GPK25	W-76
HCT25347K	I-10	HJ1055BPK25	W-76	HLS0624G	U-36	HSB12BK	Y-15
HCTBK101	I-11	HJ1055GPK25	W-76	HLS1006B	U-36	HSB12EI	Y-15
HCTBK102	I-11	HJ1056BPK25	W-76	HLS1006G	U-36	HSB12GY	Y-15
HCTBK161	I-11	HJ1056GPK25	W-76	HLS1012B	U-36	HSB12OW	Y-15
HCTBK162	I-11	HJ1057BPK25	W-76	HLS1012G	U-36	HSB12W	Y-15
HCTBK163	I-11	HJ1057GPK25	W-76	HLS1018B	U-36	HSB1BK	Y-27, Y-15
HCTBK164	I-11	HJ1058BPK25	W-76	HLS1018G	U-36	HSB1EI	Y-27, Y-15
HCTBK251	I-11	HJ1058GPK25	W-76	HLS1024B	U-36	HSB1GY	Y-27, Y-15
HCTBK252	I-11	HJ1059BPK25	W-76	HLS1024G	U-36	HSB1GYP	Y-15
HCTBK253	I-11	HJ1059GPK25	W-76	HLSSK	U-37	HSB1OW	Y-27, Y-15
HCTSP16PK12	I-11	HJ1060BPK25	W-76	HLTK	U-37	HSB1OWP	Y-15
HCTSP25PK12	I-11	HJ1060GPK25	W-76	HLTSB06B	U-37	HSB1W	Y-27, Y-15
HDH10BK	Y-19, Y-5	HKLD	BB-5	HLTSB06G	U-37	HSB1WP	Y-15
HDH15BK	Y-19, Y-5	HLBSK	U-37	HLTSB12B	U-37	HSB2BK	Y-27, Y-15
HDH20BK	Y-19, Y-5	HLCD06	U-37	HLTSB12G	U-37	HSB2EI	Y-27, Y-15
HDH25BK	Y-19, Y-5	HLCD12	U-37	HLTSB18B	U-37	HSB2GY	Y-27, Y-15
HDH30BK	Y-19, Y-5	HLCD18	U-37	HLTSB18G	U-37	HSB2OW	Y-27, Y-15
HDMIC14	Y-5	HLCDS	U-37	HLTSB24B	U-37	HSB2W	Y-27, Y-15
HDMIT14	Y-5	HLCF	U-37	HLTSB24G	U-37	HSB4BK	Y-15
HDPC03BK	Y-19, Y-5	HLCMK	U-37	HLVWBK	U-37	HSB4EI	Y-15
HDPC06BK	Y-19, Y-5	HLD	BB-5, B-51, B-53, A-53	HLWRK	U-37	HSB4GY	Y-15
HI6	I-16	HLD2	A-55, A-54, B-53, BB-5	HLX0612	U-37	HSB4OW	Y-15
HI6C	I-16	HLDKIT	BB-5	HLX0612G	U-37	HSB6BK	Y-15
HIC	I-16	HLDMP	BB-5, B-51, A-53	HLX1518	U-37	HSB6EI	Y-15
HICH	I-16	HLECPK2	U-37	HLX1518G	U-37	HSB6GY	Y-15
HIDRUBCKIT	I-13	HLEK23	U-37	HLX24	U-37	HSB6OW	Y-15
HISF11	I-16	HLEK46	U-37	HLX24G	U-37	HSLDPK2	BB-5, D-18
HISF12	I-16	HLF0690B	U-36	HP5E12	Y-16	HUB125SS	F-7
HISF22	I-16	HLF0690G	U-36	HP5E24	Y-16	HUB75SS	F-7
HISF24	I-16	HLF1290B	U-36	HP5E48	Y-16	HWAPLGY	Y-13
HJ1001BPK25	W-76	HLF1290G	U-36	HP5E96	Y-16	HWAPLOW	Y-13
HJ1001GPK25	W-76	HLF1890B	U-36	HP612	Y-16	HWAPLW	Y-13
HJ1002BPK25	W-76	HLF1890G	U-36	HP624	Y-16	HWM2KKBK10	Y-13
HJ1002GPK25	W-76	HLF2490B	U-36	HP648	Y-16	HWM2KGY10	Y-13
HJ1003BPK25	W-76	HLF2490G	U-36	HP696	Y-16	HWM2KI10	Y-13
HJ1003GPK25	W-76	HLO690B	U-36	HPJ1289	Y-16	HWM2KW10	Y-13
HJ1004BPK25	W-76	HLO690G	U-36	HPRCMB	Y-16	HXJ5EB	Y-4
HJ1004GPK25	W-76	HLI1290B	U-36	HPWWB1U4	Y-16	HXJ5EB25	Y-4
HJ1005BPK25	W-76	HLI1290G	U-36	HPWWB2U4	Y-16	HXJ5EBK	Y-4
HJ1005GPK25	W-76	HLI1890B	U-36	HPWWB2U8	Y-16	HXJ5EBK25	Y-4
HJ1006BPK25	W-76	HLI1890G	U-36	HPWWB4U4	Y-16	HXJ5EEI	S-46, Y-4
HJ1006GPK25	W-76	HLI2490B	U-36	HPWWB4U8	Y-16	HXJ5EEI25	Y-4
HJ1010BPK25	W-76	HLI2490G	U-36	HPWWB6U18	Y-16	HXJ5EGL25	Y-4
HJ1010GPK25	W-76	HLJB	U-37	HPWWB6U4	Y-16	HXJ5EGN	Y-4
HJ1011BPK25	W-76	HLMPK19	U-37	HPWWB6U8	Y-16	HXJ5EGN25	Y-4
HJ1011GPK25	W-76	HLMPK19D	U-37	HRCB12FAN	X-5	HXJ5EGY	S-46, Y-4
HJ1012BPK25	W-76	HLO0690B	U-36	HRCB12HCFK	X-5	HXJ5EGY25	Y-4

Catalog Number Index

Catalog Number	Page	Catalog Number	Page	Catalog Number	Page	Catalog Number	Page
HXJ5EOR	Y-4	IFP12OW	Y-9, S-64, S-63	IG2340	M-20, B-24	IG5362W	A-10, M-17
HXJ5EOR25	Y-4	IFP12W	Y-9	IG2410	M-20, O-33, B-23	IG5362WR	A-10, M-17
HXJ5EOW	Y-4, S-63	IFP13BK	Y-9	IG2420	M-20, O-33, B-23	IG5362WSA	M-13
HXJ5EOW25	Y-4	IFP13EI	Y-9, S-45	IG2420ST	B-23	IG5362WWR	A-10, M-17
HXJ5EP25	Y-4	IFP13GY	Y-9, S-45	IG2510	M-20, B-27, O-33	IG5461	O-33, M-18, A-12
HXJ5ER	Y-4	IFP13LA	Y-9	IG2610	B-29, M-20, O-33	IG5462	O-33, M-18, A-12
HXJ5ER25	Y-4	IFP13OW	Y-9, S-63	IG2610ST	B-29	IG5661	O-33, M-18, A-12
HXJ5EW	Y-4	IFP13W	Y-9	IG2620	B-29, M-20, O-33	IG5662	O-33, M-18, A-12
HXJ5EW25	Y-4	IFP14BK	Y-9	IG2620ST	B-29	IG8200	L-4, M-17, A-9
HXJ5EY	Y-4	IFP14EI	Y-9, S-45	IG2710	M-20, B-31, O-33	IG8200R	L-4, M-17, A-9
HXJ5EY25	Y-4	IFP14GY	Y-9, S-45	IG2710ST	B-31	IG8210	L-4, M-17, A-9
HXJ6B	Y-4	IFP14LA	Y-9	IG2720	M-20, B-31, O-33	IG8262GYSA	L-16, M-13
HXJ6B25	Y-4	IFP14OW	Y-9, S-63	IG2720ST	B-31	IG8262ISA	L-16, M-13
HXJ6BK	Y-4	IFP14W	Y-9	IG2810	M-20, O-33, B-35	IG8262OSA	L-16, M-13
HXJ6BK25	Y-4	IFP16BK	Y-9	IG415	A-33, M-17	IG8262RSA	L-16, M-13
HXJ6EI	S-46, Y-4	IFP16EI	Y-9, S-45	IG420	A-33, M-17	IG8262SA	L-16, M-13
HXJ6EI25	Y-4	IFP16GY	Y-9, S-45	IG4550A	B-13, M-20, O-33	IG8262WSA	L-16, M-13
HXJ6GL25	Y-4	IFP16LA	Y-9	IG4560	B-13, M-20, O-33	IG8300	L-4, M-17, A-9
HXJ6GN	Y-4	IFP16OW	Y-9, S-63	IG4700A	B-13, M-20, O-33, I-4	IG8300R	L-4, M-17, A-9
HXJ6GN25	Y-4	IFP16W	X-6, Y-9	IG4700AST	B-13	IG8310	L-4, M-17, A-9
HXJ6GY	S-46, Y-4	IFP18OW	Y-9, S-63, S-64, S-45	IG4710	B-13, M-20, O-33	IG8362GYSA	L-16, M-13
HXJ6GY25	Y-4	IFP212BK	Y-9	IG4710ST	B-13	IG8362ISA	L-16, M-13
HXJ6OR	Y-4	IFP212EI	Y-9	IG5252	A-28, M-18	IG8362OSA	L-16, M-13
HXJ6OR25	Y-4	IFP212GY	Y-9	IG5252GY	A-28, M-18	IG8362RSA	L-16, M-13
HXJ6OW	Y-4, S-63	IFP212LA	Y-9	IG5252I	A-28, M-18	IG8362SA	L-16, M-13
HXJ6OW25	Y-4	IFP212OW	Y-9, S-63	IG5252ITR	A-28, M-18	IG8362WSA	L-16, M-13
HXJ6P25	Y-4	IFP212W	Y-9	IG5252LA	A-28, M-18	IG9308	M-18, A-46
HXJ6R	Y-4	IFP26BK	Y-9	IG5252TR	A-28, M-18	IG9330	M-18, A-46
HXJ6R25	Y-4	IFP26EI	Y-9	IG5252W	A-28, M-18	IGN100	Y-4
HXJ6W	X-6, Y-4	IFP26GY	Y-9	IG5252WTR	A-28, M-18	IGN100C	Y-4
HXJ6W25	Y-4	IFP26LA	Y-9	IG5261	A-10, O-33, M-17	IGN100T	Y-4
HXJ6Y	Y-4	IFP26OW	Y-9, S-63	IG5261WR	A-10, M-17	IGY100	Y-4
HXJ6Y25	Y-4	IFP26W	Y-9	IG5262	A-10, O-33, M-17	IGY100C	Y-4
HXJDC25	Y-4	IFP29BK	Y-9	IG5262GY	A-10, M-17	IGY100T	Y-4
HXJUB	Y-4	IFP29EI	Y-9	IG5262GYSA	M-13	ILR1	G-42
HXJUBK	Y-4	IFP29GY	Y-9	IG5262GYWR	A-10, M-17	ILR2	G-42
HXJUEI	S-46, Y-4	IFP29LA	Y-9	IG5262I	A-10, M-17	ILR3	G-42
HXJUGN	Y-4	IFP29OW	Y-9, S-64, S-63	IG5262ISA	M-13	ILR4	G-42
HXJUGY	S-46, Y-4	IFP29W	Y-9	IG5262IWR	A-10, M-17	ILR5	G-42
HXJUOR	Y-4	IG15CR	A-30, M-18	IG5262OSA	M-13	IM15311015BK	Y-11
HXJUOW	Y-4, S-63	IG15CRGRY	A-30, M-18	IG5262OWSA	M-13	IM15311015EI	Y-11
HXJUR	Y-4	IG15CRI	A-30, M-18	IG5262R	A-10, M-17	IM15311015GY	Y-11
HXJUW	Y-4	IG15CRLA	A-30, M-18	IG5262RWR	A-10, M-17	IM15311015OW	Y-11
HXJUW	Y-4	IG15CRWHI	A-30, M-18	IG5262SA	M-13	IM15311015W	Y-11
IB100	Y-4	IG15DR	A-30, M-18	IG5262WR	A-10, M-17	IM1IA15BK	Y-14
IB100C	Y-4	IG15DRGRY	A-30, M-18	IG5262WSA	M-13	IM1IA15EI	S-46, Y-14
IB100T	Y-4	IG15DRI	A-30, M-18	IG5352	A-28, M-18	IM1IA15GY	S-46, Y-14
IBK100	Y-4	IG15DRLA	A-30, M-18	IG5352GY	A-28, M-18	IM1IA15OW	Y-14
IBK100C	Y-4	IG15DRWHI	M-18	IG5352I	A-28, M-18	IM1IA15W	Y-14
IBK100T	Y-4	IG20CR	A-30, M-18	IG5352ITR	A-28, M-18	IM1K1BK	Y-14
IBN100	Y-4	IG20CRGRY	A-30, M-18	IG5352LA	A-28, M-18	IM1K1EI	S-46, Y-14
IBN100C	Y-4	IG20CRI	A-30, M-18	IG5352TR	A-28, M-18	IM1K1GY	S-46, Y-14
IBN100T	Y-4	IG20CRLA	A-30, M-18	IG5352W	A-28, M-18	IM1K1OW	Y-14
IEI100	Y-4	IG20CRWHI	A-30, M-18	IG5352WTR	A-28, M-18	IM1K1W	Y-14
IEI100C	Y-4	IG20DR	A-30, M-18	IG5361	A-10, O-33, M-17	IM1KA15BK	Y-14
IEI100T	Y-4	IG20DRGRY	A-30, M-18	IG5361WR	A-10, M-17	IM1KA15EI	S-46, Y-14
IFP11BK	Y-9	IG20DRI	A-30, M-18	IG5362	A-10, O-33, M-17	IM1KA15GY	S-46, Y-14
IFP11EI	Y-9	IG20DRLA	A-30, M-18	IG5362GY	A-10, M-17	IM1KA15OW	Y-14
IFP11GY	Y-9	IG20DRWHI	A-30, M-18	IG5362GYSA	M-13	IM1KA15W	Y-14
IFP11LA	Y-9	IG2152	M-17, O-33, A-11	IG5362GYWR	A-10, M-17	IM1SCA15BK	Y-14
IFP11OW	Y-9	IG2162	M-17, O-33, A-11	IG5362I	A-10, M-17	IM1SCA15EI	S-46, Y-14
IFP11W	Y-9	IG2162GY	M-17, A-11	IG5362ISA	M-13	IM1SCA15GY	S-46, Y-14
IFP126GY	S-45	IG2182	L-4, M-17, A-9	IG5362IWR	A-10, M-17	IM1SCA15OW	Y-14
IFP126OW	Y-9, S-63, S-64, S-45	IG2182I	L-4, M-17, A-9	IG5362OSA	M-13	IM1SCA15W	Y-14
IFP12BK	Y-9	IG2182WA	L-4, M-17, A-9	IG5362OWSA	M-13	IM2IA15BK	Y-14
IFP12EI	Y-9, S-45	IG2310	M-20, O-33, B-21	IG5362R	A-10, M-17	IM2IA15EI	S-46, Y-14
IFP12GY	Y-9, S-45	IG2310ST	B-21	IG5362RWR	A-10, M-17	IM2IA15GY	S-46, Y-14
IFP12LA	Y-9	IG2320	M-20, O-33, B-21	IG5362SA	M-13	IM2IA15OW	Y-14

Catalog Number Index

Catalog Number	Page	Catalog Number	Page	Catalog Number	Page	Catalog Number	Page
IM2IA15W	Y-14	IMBDS1GY	Y-14	IMF4OW	Y-13	IN320AM	G-10
IM2K1BK	Y-14	IMBDS1OW	Y-14	IMF4W	Y-13	IN320BF	G-10
IM2K1EI	S-46, Y-14	IMBDS1W	Y-14	IMFP1D1BK	Y-13	IN320BM	G-10
IM2K1GY	S-46, Y-14	IMBDSA15BK	Y-14	IMFP1D1EI	Y-13	IN330AF	G-10
IM2K1OW	Y-14	IMBDSA15EI	Y-14	IMFP1D1GY	Y-13	IN330AM	G-10
IM2K1W	Y-14	IMBDSA15GY	Y-14	IMFP1D1OW	Y-13	IN330BF	G-10
IM2KA15BK	Y-14	IMBDSA15OW	Y-14	IMFP1D1W	Y-13	IN330BM	G-10
IM2KA15EI	S-46, Y-14	IMBDSA15W	Y-14	IMFP1D2BK	Y-13	IN330FS1	G-41, G-40
IM2KA15GY	S-46, Y-14	IMBDVI1015BK	Y-14	IMFP1D2EI	Y-13	IN330FS2	G-41, G-40
IM2KA15OW	Y-14	IMBDVI1015EI	Y-14	IMFP1D2GY	Y-13	IN330MS1	G-41, G-40
IM2KA15W	Y-14	IMBDVI1015GY	Y-14	IMFP1D2OW	Y-13	IN330MS2	G-41, G-40
IM2SCA2BK	Y-14	IMBDVI1015LA	Y-14	IMFP1D2W	Y-13	IN360AF	G-11
IM2SCA2EI	S-46, Y-14	IMBDVI1015OW	Y-14	IMFP1D3BK	Y-13	IN360AM	G-11
IM2SCA2GY	S-46, Y-14	IMBDVI1015W	Y-14	IMFP1D3EI	Y-13	IN360BF	G-11
IM2SCA2OW	Y-14	IMBDVI15BK	Y-14	IMFP1D3GY	Y-13	IN360BM	G-11
IM2SCA2W	Y-14	IMBDVI15EI	Y-14	IMFP1D3OW	Y-13	IN360FS1	G-41, G-40
IM35AR1BK	Y-12	IMBDVI15GY	Y-14	IMFP1D3W	Y-13	IN360FS2	G-41, G-40
IM35AR1EI	Y-12	IMBDVI15LA	Y-14	IMFP2BK	Y-13	IN360MS1	G-41, G-40
IM35AR1GY	Y-12	IMBDVI15OW	Y-14	IMFP2D2BK	Y-13	IN360MS2	G-41, G-40
IM35AR1OW	Y-12	IMBDVI15W	Y-14	IMFP2D2EI	Y-13	IN4100CF	G-11
IM35AR1W	Y-12	IMC3511015BK	Y-11	IMFP2D2GY	Y-13	IN4100CM	G-11
IM3RF1BK	Y-12	IMC3511015EI	Y-11	IMFP2D2OW	Y-13	IN4100DF	G-11
IM3RF1EI	Y-12	IMC3511015GY	Y-11	IMFP2D2W	Y-13	IN4100DFS	G-11
IM3RF1GY	Y-12	IMC3511015OW	Y-11	IMFP2EI	Y-13	IN4100DM	G-11
IM3RF1OW	Y-12	IMC3511015W	Y-11	IMFP2GY	Y-13	IN4100DMS	G-11
IM3RF1W	Y-12	IMCAR11015BK	Y-11	IMFP2OW	Y-13	IN4100FS1	G-41, G-40
IM3RS1BK	Y-12	IMCAR11015EI	Y-11	IMFP2W	Y-13	IN4100FS2	G-41, G-40
IM3RS1EI	Y-12	IMCAR11015GY	Y-11	IMH110ST2BK	Y-11	IN4100MS1	G-41, G-40
IM3RS1GY	Y-12	IMCAR11015OW	Y-11	IMH110ST2EI	Y-11	IN4100MS2	G-41, G-40
IM3RS1OW	Y-12	IMCAR11015W	Y-11	IMH110ST2GY	Y-11	IN4200FS1	G-41, G-40
IM3RS1W	Y-12	IMCR1101BK	Y-11	IMH110ST2OW	Y-11	IN4200FS2	G-41, G-40
IMAR1101BK	Y-11	IMCR1101EI	Y-11	IMH110ST2W	Y-11	IN4200MS1	G-41, G-40
IMAR1101EI	Y-11	IMCR1101GY	Y-11	IMR1101BK	Y-11	IN4200MS2	G-41, G-40
IMAR1101GY	Y-11	IMCR1101OW	Y-11	IMR1101EI	Y-11	IN420CF	G-10
IMAR1101OW	Y-11	IMCR1101W	Y-11	IMR1101GY	Y-11	IN420CM	G-10
IMAR1101W	Y-11	IMCRF1BK	Y-12	IMR1101OW	Y-11	IN420DF	G-10
IMAVB15BK	Y-14	IMCRF1EI	Y-12	IMR1101W	Y-11	IN420DM	G-10
IMAVB15EI	Y-14	IMCRF1GY	Y-12	IMRSJ1BK	Y-12	IN430CF	G-10
IMAVB15GY	Y-14	IMCRF1OW	Y-12	IMRSJ1EI	Y-12	IN430CM	G-10
IMAVB15OW	Y-14	IMCRF1W	Y-12	IMRSJ1GY	Y-12	IN430DF	G-10
IMAVB15W	Y-14	IMCRS15BK	Y-12	IMRSJ1OW	Y-12	IN430DM	G-10
IMB05BK	Y-14	IMCRS15EI	Y-12	IMRSJ1W	Y-12	IN430FS1	G-41, G-40
IMB05EI	S-46, Y-14	IMCRS15GY	Y-12	IMSP1BK	Y-12	IN430FS2	G-41, G-40
IMB05GY	S-46, Y-14	IMCRS15OW	Y-12	IMSP1EI	Y-12	IN430MS1	G-41, G-40
IMB05OW	Y-14	IMCRS15W	Y-12	IMSP1GY	Y-12	IN430MS2	G-41, G-40
IMB05W	Y-14	IMCRS1BK	Y-12	IMSP1OW	Y-12	IN460CF	G-11
IMB15315BK	Y-14	IMCRS1EI	Y-12	IMSS1	Y-13	IN460CM	G-11
IMB15315EI	Y-14	IMCRS1GY	Y-12	IMSS2	Y-13	IN460DF	G-11
IMB15315GY	Y-14	IMCRS1OW	Y-12	IMSS3	Y-13	IN460DFS	G-11
IMB15315OW	Y-14	IMCRS1W	Y-12	IMSS4	Y-13	IN460DM	G-11
IMB15315W	Y-14	IMF1BK	Y-13	IMU11015BK	Y-11	IN460DMS	G-11
IMB153X2BK	Y-14	IMF1EI	S-46, Y-13	IMU11015EI	Y-11	IN460FS1	G-41, G-40
IMB153X2EI	Y-14	IMF1GY	S-46, Y-13	IMU11015GY	Y-11	IN460FS2	G-41, G-40
IMB153X2GY	Y-14	IMF1OW	S-64, Y-13, S-63	IMU11015OW	Y-11	IN460MS1	G-41, G-40
IMB153X2OW	Y-14	IMF1W	X-6, Y-13, Y-18	IMU11015W	Y-11	IN460MS2	G-41, G-40
IMB153X2W	Y-14	IMF2BK	Y-13	IN16494	L-18	IN5100EF	G-11
IMB15BK	Y-14	IMF2EI	S-46, Y-13	IN3100AF	G-11	IN5100EFS	G-11
IMB15EI	S-46, Y-14	IMF2GY	S-46, Y-13	IN3100AM	G-11	IN5100EM	G-11
IMB15GY	S-46, Y-14	IMF2OW	S-64, Y-13, S-63	IN3100BF	G-11	IN5100EMS	G-11
IMB15OW	Y-14	IMF2W	Y-13	IN3100BM	G-11	IN5100FS1	G-41, G-40
IMB15W	Y-14	IMF3BK	Y-13	IN3100FS1	G-41, G-40	IN5100MS1	G-41, G-40
IMB1BK	Y-14	IMF3EI	Y-13	IN3100FS2	G-41, G-40	IN5200FS1	G-41, G-40
IMB1EI	S-46, Y-14	IMF3GY	Y-13	IN3100MS1	G-41, G-40	IN5200MS1	G-41, G-40
IMB1GY	S-46, Y-14	IMF3OW	Y-13	IN3200FS2	G-41, G-40	IN520EF	G-10
IMB1OW	Y-14	IMF3W	Y-13	IN3200MS2	G-41, G-40	IN520EM	G-10
IMB1W	Y-14	IMF4BK	Y-13	IN3200MS2	G-41, G-40	IN530EF	G-10
IMBDS1BK	Y-14	IMF4EI	Y-13	IN320AF	G-10	IN530EM	G-10
IMBDS1EI	Y-14	IMF4GY	Y-13			IN530FS1	G-41, G-40

Catalog Number Index

Catalog Number	Page	Catalog Number	Page	Catalog Number	Page	Catalog Number	Page
IN530MS1	G-41, G-40	KP212GY	S-45	LACC0618	U-32	LACRR3609	U-32
IN560EF	G-11	KP212W	S-63	LACC0624	U-32	LACRR3612	U-32
IN560EFS	G-11	KP2140	S-63	LACC0630	U-32	LACRR3618	U-32
IN560EM	G-11	KP2140BK	S-63	LACC0636	U-32	LACRR3624	U-32
IN560EMS	G-11	KP2140GY	S-45	LACF09	U-28	LACRR3630	U-32
IN560FS1	G-41, G-40	KP2140W	S-63	LACF18	U-28	LACT060612	U-30
IN560MS1	G-41, G-40	KP2162	S-63	LACF36	U-28	LACT060624	U-30
IOR100	Y-4	KP2162BK	S-63	LACJ09	U-30	LACT060636	U-30
IOR100C	Y-4	KP2162GY	S-45	LACJ18	U-30	LACT090612	U-31
IOR100T	Y-4	KP2162W	S-63	LACJ36	U-30	LACT090624	U-31
IP100	Y-4	KP2163	S-63	LACRC0906	U-32	LACT090636	U-31
IP100C	Y-4	KP2163BK	S-63	LACRC1206	U-32	LACT090912	U-30
IP100T	Y-4	KP2163GY	S-45	LACRC1209	U-32	LACT090924	U-30
IR100	Y-4	KP2163W	S-63	LACRC1806	U-32	LACT090936	U-30
IR100C	Y-4	KP24	S-63	LACRC1809	U-32	LACT120612	U-31
IR100T	Y-4	KP24BK	S-63	LACRC1812	U-32	LACT120624	U-31
ISF2BK	P-29, O-22	KP24W	S-63	LACRC2406	U-32	LACT120636	U-31
ISF2EI	S-45	KP26	S-63	LACRC2409	U-32	LACT120912	U-31
ISF2GY	S-45	KP262	S-63	LACRC2412	U-32	LACT120924	U-31
ISF2OW	S-63	KP262BK	S-63	LACRC2418	U-32	LACT120936	U-31
ISF3EI	S-45	KP262W	S-63	LACRC3006	U-32	LACT121212	U-30
ISF3GY	S-45	KP26BK	S-63	LACRC3009	U-32	LACT121224	U-30
ISF3OW	S-63	KP26GY	I-13, S-45	LACRC3012	U-32	LACT121236	U-30
ISF4BK	P-29, O-22	KP26W	S-63	LACRC3018	U-32	LACT180612	U-31
ISF4EI	S-45	KP2BK	S-63	LACRC3024	U-32	LACT180624	U-31
ISF4GY	S-45	KP2W	S-63	LACRC3606	U-32	LACT180636	U-31
ISF4OW	S-63	KP7	S-63	LACRC3609	U-32	LACT180912	U-31
ISF6BK	P-29, O-22	KP720	S-63	LACRC3612	U-32	LACT180924	U-31
ISF6EI	S-45	KP720BK	S-63	LACRC3618	U-32	LACT180936	U-31
ISF6GY	S-45	KP720GY	I-13, S-45	LACRC3624	U-32	LACT181212	U-31
ISF6OW	S-63	KP720W	S-63	LACRC3630	U-32	LACT181224	U-31
ISFB15BK	Y-10	KP7BK	S-63	LACRL0906	U-32	LACT181236	U-31
ISFB15EI	Y-10	KP7GY	I-13, S-45	LACRL1206	U-32	LACT181812	U-30
ISFB15GY	Y-10	KP7W	S-63	LACRL1209	U-32	LACT181824	U-30
ISFB15OW	Y-10	KP8	S-64, S-63	LACRL1806	U-32	LACT181836	U-30
ISFB15W	Y-10	KP82	S-64, S-63	LACRL1809	U-32	LACT240612	U-31
ISFB215BK	Y-10	KP82BK	S-63	LACRL1812	U-32	LACT240624	U-31
ISFB215EI	Y-10	KP82W	S-63	LACRL2406	U-32	LACT240636	U-31
ISFB215GY	Y-10	KP8BK	S-63	LACRL2409	U-32	LACT240912	U-31
ISFB215OW	Y-10	KP8GY	I-13, S-45	LACRL2412	U-32	LACT240924	U-31
ISFB215W	Y-10	KP8W	S-63	LACRL2418	U-32	LACT240936	U-31
ISFBR15BK	Y-10	KPIMBZBK	S-63	LACRL3006	U-32	LACT241212	U-31
ISFBR15EI	Y-10	KPIMBZGY	Y-13, S-45	LACRL3009	U-32	LACT241224	U-31
ISFBR15GY	Y-10	KPIMBZOW	Y-13, S-63	LACRL3012	U-32	LACT241236	U-31
ISFBR15OW	Y-10	KPIMBZW	S-63	LACRL3018	U-32	LACT241812	U-31
ISFBR15W	Y-10	KPORTBK	S-63	LACRL3024	U-32	LACT241824	U-31
ISFH110BK	Y-11	KPORTGY	S-45	LACRL3606	U-32	LACT241836	U-31
ISFH110EI	Y-11	KPORTOW	S-63	LACRL3609	U-32	LACT242412	U-30
ISFH110GY	Y-11	KPORTW	S-63	LACRL3612	U-32	LACT242424	U-30
ISFH110OW	Y-11	KPPANBK	S-63	LACRL3618	U-32	LACT242436	U-30
ISFH110W	Y-11	KPPANGY	S-45	LACRL3624	U-32	LACT300612	U-31
IW100	Y-4	KPPANOW	S-63	LACRL3630	U-32	LACT300624	U-31
IW100C	Y-4	KPPANW	S-63	LACRR0906	U-32	LACT300636	U-31
IW100T	Y-4	L420R9	G-32, G-31	LACRR1206	U-32	LACT300912	U-31
IY100	Y-4	L430P12	G-32, G-31	LACRR1209	U-32	LACT300924	U-31
IY100C	Y-4	L430P9	G-31	LACRR1806	U-32	LACT300936	U-31
IY100T	Y-4	L430R12	G-32, G-31	LACRR1809	U-32	LACT301212	U-31
KP1	S-63	L430R9	G-31	LACRR1812	U-32	LACT301224	U-31
KP14	S-63	LACC0406	U-32	LACRR2406	U-32	LACT301236	U-31
KP14BK	S-63	LACC0409	U-32	LACRR2409	U-32	LACT301812	U-31
KP14GY	S-45	LACC0412	U-32	LACRR2412	U-32	LACT301824	U-31
KP14W	S-63	LACC0418	U-32	LACRR2418	U-32	LACT301836	U-31
KP1BK	S-63	LACC0424	U-32	LACRR3006	U-32	LACT302412	U-31
KP1GY	I-13, S-45	LACC0430	U-32	LACRR3009	U-32	LACT302424	U-31
KP1W	S-63	LACC0436	U-32	LACRR3012	U-32	LACT302436	U-31
KP2	S-63	LACC0606	U-32	LACRR3018	U-32	LACT303012	U-30
KP212	S-63	LACC0609	U-32	LACRR3024	U-32	LACT303024	U-30
KP212BK	S-63	LACC0612	U-32	LACRR3606	U-32	LACT303036	U-30

Catalog Number Index

Catalog Number	Page	Catalog Number	Page	Catalog Number	Page	Catalog Number	Page
LACT360612	U-31	LACVI600936	U-28	LACVO3061824	U-29	LACVO6043024	U-29
LACT360624	U-31	LACVI601212	U-28	LACVO3061836	U-29	LACVO6043036	U-29
LACT360636	U-31	LACVI601224	U-28	LACVO3062412	U-29	LACVO6043612	U-29
LACT360912	U-31	LACVI601236	U-28	LACVO3062424	U-29	LACVO6043624	U-29
LACT360924	U-31	LACVI601812	U-28	LACVO3062436	U-29	LACVO6043636	U-29
LACT360936	U-31	LACVI601824	U-28	LACVO3063012	U-29	LACVO6060612	U-29
LACT361212	U-31	LACVI601836	U-28	LACVO3063024	U-29	LACVO6060624	U-29
LACT361224	U-31	LACVI602412	U-28	LACVO3063036	U-29	LACVO6060636	U-29
LACT361236	U-31	LACVI602424	U-28	LACVO3063612	U-29	LACVO6060912	U-29
LACT361812	U-31	LACVI602436	U-28	LACVO3063624	U-29	LACVO6060924	U-29
LACT361824	U-31	LACVI603012	U-28	LACVO3063636	U-29	LACVO6060936	U-29
LACT361836	U-31	LACVI603024	U-28	LACVO4540612	U-29	LACVO6061212	U-29
LACT362412	U-31	LACVI603036	U-28	LACVO4540624	U-29	LACVO6061224	U-29
LACT362424	U-31	LACVI603612	U-28	LACVO4540636	U-29	LACVO6061236	U-29
LACT362436	U-31	LACVI603624	U-28	LACVO4540912	U-29	LACVO6061812	U-29
LACT363012	U-31	LACVI603636	U-28	LACVO4540924	U-29	LACVO6061824	U-29
LACT363024	U-31	LACVI900612	U-28	LACVO4540936	U-29	LACVO6061836	U-29
LACT363036	U-31	LACVI900624	U-28	LACVO4541212	U-29	LACVO6062412	U-29
LACT363612	U-30	LACVI900636	U-28	LACVO4541224	U-29	LACVO6062424	U-29
LACT363624	U-30	LACVI900912	U-28	LACVO4541236	U-29	LACVO6062436	U-29
LACT363636	U-30	LACVI900924	U-28	LACVO4541812	U-29	LACVO6063012	U-29
LACVI300612	U-28	LACVI900936	U-28	LACVO4541824	U-29	LACVO6063024	U-29
LACVI300624	U-28	LACVI901212	U-28	LACVO4542412	U-29	LACVO6063036	U-29
LACVI300636	U-28	LACVI901224	U-28	LACVO4542424	U-29	LACVO6063612	U-29
LACVI300912	U-28	LACVI901236	U-28	LACVO4542436	U-29	LACVO6063624	U-29
LACVI300924	U-28	LACVI901812	U-28	LACVO4543012	U-29	LACVO6063636	U-29
LACVI300936	U-28	LACVI901824	U-28	LACVO4543024	U-29	LACVO9040612	U-29
LACVI301212	U-28	LACVI901836	U-28	LACVO4543036	U-29	LACVO9040624	U-29
LACVI301224	U-28	LACVI902412	U-28	LACVO4543612	U-29	LACVO9040636	U-29
LACVI301236	U-28	LACVI902424	U-28	LACVO4543624	U-29	LACVO9040912	U-29
LACVI301812	U-28	LACVI902436	U-28	LACVO4543636	U-29	LACVO9040924	U-29
LACVI301824	U-28	LACVI903012	U-28	LACVO4560612	U-29	LACVO9040936	U-29
LACVI301836	U-28	LACVI903024	U-28	LACVO4560624	U-29	LACVO9041212	U-29
LACVI302412	U-28	LACVI903036	U-28	LACVO4560636	U-29	LACVO9041224	U-29
LACVI302424	U-28	LACVI903612	U-28	LACVO4560912	U-29	LACVO9041236	U-29
LACVI302436	U-28	LACVI903624	U-28	LACVO4560924	U-29	LACVO9041812	U-29
LACVI303012	U-28	LACVI903636	U-28	LACVO4560936	U-29	LACVO9041824	U-29
LACVI303024	U-28	LACVO3040612	U-29	LACVO4561212	U-29	LACVO9041836	U-29
LACVI303036	U-28	LACVO3040624	U-29	LACVO4561224	U-29	LACVO9042412	U-29
LACVI303612	U-28	LACVO3040636	U-29	LACVO4561236	U-29	LACVO9042424	U-29
LACVI303624	U-28	LACVO3040912	U-29	LACVO4561812	U-29	LACVO9042436	U-29
LACVI303636	U-28	LACVO3040924	U-29	LACVO4561824	U-29	LACVO9043012	U-29
LACVI450612	U-28	LACVO3040936	U-29	LACVO4561836	U-29	LACVO9043024	U-29
LACVI450624	U-28	LACVO3041212	U-29	LACVO4562412	U-29	LACVO9043036	U-29
LACVI450636	U-28	LACVO3041224	U-29	LACVO4562424	U-29	LACVO9043612	U-29
LACVI450912	U-28	LACVO3041236	U-29	LACVO4562436	U-29	LACVO9043624	U-29
LACVI450924	U-28	LACVO3041812	U-29	LACVO4563012	U-29	LACVO9043636	U-29
LACVI450936	U-28	LACVO3041824	U-29	LACVO4563024	U-29	LACVO9060612	U-29
LACVI451212	U-28	LACVO3041836	U-29	LACVO4563036	U-29	LACVO9060624	U-29
LACVI451224	U-28	LACVO3042412	U-29	LACVO4563612	U-29	LACVO9060636	U-29
LACVI451236	U-28	LACVO3042424	U-29	LACVO4563624	U-29	LACVO9060912	U-29
LACVI451812	U-28	LACVO3042436	U-29	LACVO4563636	U-29	LACVO9060924	U-29
LACVI451824	U-28	LACVO3043012	U-29	LACVO6040612	U-29	LACVO9060936	U-29
LACVI451836	U-28	LACVO3043024	U-29	LACVO6040624	U-29	LACVO9061212	U-29
LACVI452412	U-28	LACVO3043036	U-29	LACVO6040636	U-29	LACVO9061224	U-29
LACVI452424	U-28	LACVO3043612	U-29	LACVO6040912	U-29	LACVO9061236	U-29
LACVI452436	U-28	LACVO3043624	U-29	LACVO6040924	U-29	LACVO9061812	U-29
LACVI453012	U-28	LACVO3043636	U-29	LACVO6040936	U-29	LACVO9061824	U-29
LACVI453024	U-28	LACVO3060612	U-29	LACVO6041212	U-29	LACVO9061836	U-29
LACVI453036	U-28	LACVO3060624	U-29	LACVO6041224	U-29	LACVO9062412	U-29
LACVI453612	U-28	LACVO3060636	U-29	LACVO6041236	U-29	LACVO9062424	U-29
LACVI453624	U-28	LACVO3060912	U-29	LACVO6041812	U-29	LACVO9062436	U-29
LACVI453636	U-28	LACVO3060924	U-29	LACVO6041824	U-29	LACVO9063012	U-29
LACVI600612	U-28	LACVO3060936	U-29	LACVO6041836	U-29	LACVO9063024	U-29
LACVI600624	U-28	LACVO3061212	U-29	LACVO6042412	U-29	LACVO9063036	U-29
LACVI600636	U-28	LACVO3061224	U-29	LACVO6042424	U-29	LACVO9063612	U-29
LACVI600912	U-28	LACVO3061236	U-29	LACVO6042436	U-29	LACVO9063624	U-29
LACVI600924	U-28	LACVO3061812	U-29	LACVO6043012	U-29	LACVO9063636	U-29

Catalog Number Index

Catalog Number	Page	Catalog Number	Page	Catalog Number	Page	Catalog Number	Page
LACX060612	U-30	LACX361212	U-30	LDF46	U-27	LFRC43618	U-21
LACX060624	U-30	LACX361224	U-30	LDF66	U-27	LFRC43624	U-21
LACX060636	U-30	LACX361236	U-30	LDS5	U-27	LFRC43630	U-21
LACX090612	U-30	LACX361812	U-30	LDVI30412	U-27	LFRC60906	U-21
LACX090624	U-30	LACX361824	U-30	LDVI30424	U-27	LFRC61206	U-21
LACX090636	U-30	LACX361836	U-30	LDVI30436	U-27	LFRC61209	U-21
LACX090912	U-30	LACX362412	U-30	LDVI30612	U-27	LFRC61806	U-21
LACX090924	U-30	LACX362424	U-30	LDVI30624	U-27	LFRC61809	U-21
LACX090936	U-30	LACX362436	U-30	LDVI30636	U-27	LFRC61812	U-21
LACX120612	U-30	LACX363012	U-30	LDVI45412	U-27	LFRC62406	U-21
LACX120624	U-30	LACX363024	U-30	LDVI45424	U-27	LFRC62412	U-21
LACX120636	U-30	LACX363036	U-30	LDVI45436	U-27	LFRC62418	U-21
LACX120912	U-30	LACX363612	U-30	LDVI45612	U-27	LFRC63006	U-21
LACX120924	U-30	LACX363624	U-30	LDVI45624	U-27	LFRC63009	U-21
LACX120936	U-30	LACX363636	U-30	LDVI45636	U-27	LFRC63012	U-21
LACX121212	U-30	LBC406	U-34	LDVI60412	U-27	LFRC63018	U-21
LACX121224	U-30	LBC409	U-34	LDVI60424	U-27	LFRC63024	U-21
LACX121236	U-30	LBC412	U-34	LDVI60436	U-27	LFRC63606	U-21
LACX180612	U-30	LBC418	U-34	LDVI60612	U-27	LFRC63609	U-21
LACX180624	U-30	LBC424	U-34	LDVI60624	U-27	LFRC63612	U-21
LACX180636	U-30	LBC430	U-34	LDVI60636	U-27	LFRC63618	U-21
LACX180912	U-30	LBC436	U-34	LDVI90412	U-27	LFRC63624	U-21
LACX180924	U-30	LBC606	U-34	LDVI90424	U-27	LFRC63630	U-21
LACX180936	U-30	LBC609	U-34	LDVI90436	U-27	LFRL40906	U-21
LACX181212	U-30	LBC612	U-34	LDVI90612	U-27	LFRL41206	U-21
LACX181224	U-30	LBC618	U-34	LDVI90624	U-27	LFRL41209	U-21
LACX181236	U-30	LBC624	U-34	LDVI90636	U-27	LFRL41806	U-21
LACX181812	U-30	LBC630	U-34	LDVO30412	U-27	LFRL41809	U-21
LACX181836	U-30	LBC636	U-34	LDVO30424	U-27	LFRL41812	U-21
LACX240612	U-30	LBP406	U-34	LDVO30436	U-27	LFRL42406	U-21
LACX240624	U-30	LBP409	U-34	LDVO30612	U-27	LFRL42409	U-21
LACX240636	U-30	LBP412	U-34	LDVO30624	U-27	LFRL42412	U-21
LACX240912	U-30	LBP418	U-34	LDVO30636	U-27	LFRL42418	U-21
LACX240924	U-30	LBP424	U-34	LDVO45412	U-27	LFRL43006	U-21
LACX240936	U-30	LBP430	U-34	LDVO45424	U-27	LFRL43009	U-21
LACX241212	U-30	LBP609	U-34	LDVO45436	U-27	LFRL43012	U-21
LACX241224	U-30	LBP612	U-34	LDVO45612	U-27	LFRL43018	U-21
LACX241236	U-30	LBP618	U-34	LDVO45624	U-27	LFRL43024	U-21
LACX241812	U-30	LBP624	U-34	LDVO45636	U-27	LFRL43606	U-21
LACX241824	U-30	LBP636	U-34	LDVO60412	U-27	LFRL43609	U-21
LACX241836	U-30	LBRL360	E-20	LDVO60424	U-27	LFRL43612	U-21
LACX242412	U-30	LBRLXT180	E-11	LDVO60436	U-27	LFRL43618	U-21
LACX242424	U-30	LBRLXT360	E-11	LDVO60612	U-27	LFRL43624	U-21
LACX242436	U-30	LBRLXTA	E-11	LDVO60624	U-27	LFRL43630	U-21
LACX300612	U-30	LBRLXTEA	E-11	LDVO60636	U-27	LFRL60906	U-21
LACX300624	U-30	LCD0108DI	Z-19	LDVO90412	U-27	LFRL61206	U-21
LACX300636	U-30	LCD0108DLA	Z-19	LDVO90424	U-27	LFRL61209	U-21
LACX300912	U-30	LCD0108DW	Z-19	LDVO90436	U-27	LFRL61806	U-21
LACX300924	U-30	LCD0108SI	Z-19	LDVO90612	U-27	LFRL61809	U-21
LACX300936	U-30	LCD0108SLA	Z-19	LDVO90624	U-27	LFRL61812	U-21
LACX301212	U-30	LCD0108SW	Z-19	LDVO90636	U-27	LFRL62406	U-21
LACX301224	U-30	LCD150DI	Z-19	LFRC40906	U-21	LFRL62409	U-21
LACX301236	U-30	LCD150DLA	Z-19	LFRC41206	U-21	LFRL62412	U-21
LACX301812	U-30	LCD150DW	Z-19	LFRC41209	U-21	LFRL62418	U-21
LACX301824	U-30	LCD150SI	Z-19	LFRC41806	U-21	LFRL63006	U-21
LACX301836	U-30	LCD150SLA	Z-19	LFRC41809	U-21	LFRL63009	U-21
LACX302412	U-30	LCD150SW	Z-19	LFRC41812	U-21	LFRL63012	U-21
LACX302424	U-30	LCD150TI	Z-19	LFRC42406	U-21	LFRL63018	U-21
LACX302436	U-30	LCD150TLA	Z-19	LFRC42412	U-21	LFRL63024	U-21
LACX303012	U-30	LCD150TW	Z-19	LFRC42418	U-21	LFRL63606	U-21
LACX303024	U-30	LCD300DI	Z-19	LFRC43006	U-21	LFRL63609	U-21
LACX303036	U-30	LCD300DLA	Z-19	LFRC43009	U-21	LFRL63612	U-21
LACX360612	U-30	LCD300DW	Z-19	LFRC43012	U-21	LFRL63618	U-21
LACX360624	U-30	LCN4	U-34	LFRC43018	U-21	LFRL63624	U-21
LACX360636	U-30	LCN6	U-34	LFRC43024	U-21	LFRL63630	U-21
LACX360912	U-30	LCR64	U-34	LFRC43606	U-21	LFRR40906	U-21
LACX360924	U-30	LD412	U-27	LFRC43609	U-21	LFRR41206	U-21
LACX360936	U-30	LD612	U-27	LFRC43612	U-21	LFRR41209	U-21

Catalog Number Index

Catalog Number	Page	Catalog Number	Page	Catalog Number	Page	Catalog Number	Page
LFRR41806	U-21	LFT4093636	U-23	LFT4300924	U-24	LFT6092412	U-23
LFRR41809	U-21	LFT4120612	U-24	LFT4300936	U-24	LFT6092424	U-23
LFRR41812	U-21	LFT4120624	U-24	LFT4301212	U-24	LFT6092436	U-23
LFRR42406	U-21	LFT4120636	U-24	LFT4301224	U-24	LFT6093012	U-23
LFRR42409	U-21	LFT4120912	U-24	LFT4301236	U-24	LFT6093024	U-23
LFRR42412	U-21	LFT4120924	U-24	LFT4301824	U-24	LFT6093036	U-23
LFRR42418	U-21	LFT4120936	U-24	LFT4301836	U-24	LFT6093612	U-23
LFRR43006	U-21	LFT4121212	U-22	LFT4302412	U-24	LFT6093624	U-23
LFRR43009	U-21	LFT4121224	U-22	LFT4302424	U-24	LFT6093636	U-23
LFRR43012	U-21	LFT4121236	U-22	LFT4302436	U-24	LFT6120612	U-24
LFRR43018	U-21	LFT4121812	U-23	LFT4303012	U-22	LFT6120624	U-24
LFRR43024	U-21	LFT4121824	U-23	LFT4303036	U-22	LFT6120636	U-24
LFRR60906	U-21	LFT4121836	U-23	LFT4303612	U-23	LFT6120912	U-24
LFRR61206	U-21	LFT4122412	U-23	LFT4303624	U-23	LFT6120924	U-24
LFRR61209	U-21	LFT4122424	U-23	LFT4303636	U-23	LFT6120936	U-24
LFRR61806	U-21	LFT4122436	U-23	LFT4360612	U-24	LFT6121212	U-22
LFRR61809	U-21	LFT4123012	U-23	LFT4360624	U-24	LFT6121224	U-22
LFRR61812	U-21	LFT4123024	U-23	LFT4360636	U-24	LFT6121236	U-22
LFRR62406	U-21	LFT4123036	U-23	LFT4360912	U-24	LFT6121812	U-23
LFRR62409	U-21	LFT4123612	U-23	LFT4360924	U-24	LFT6121824	U-23
LFRR62412	U-21	LFT4123624	U-23	LFT4360936	U-24	LFT6121836	U-23
LFRR62418	U-21	LFT4123636	U-23	LFT4361212	U-24	LFT6122412	U-23
LFRR63006	U-21	LFT4180612	U-24	LFT4361224	U-24	LFT6122424	U-23
LFRR63009	U-21	LFT4180624	U-24	LFT4361236	U-24	LFT6122436	U-23
LFRR63012	U-21	LFT4180636	U-24	LFT4361812	U-24	LFT6123012	U-23
LFRR63018	U-21	LFT4180912	U-24	LFT4361824	U-24	LFT6123024	U-23
LFRR63024	U-21	LFT4180924	U-24	LFT4361836	U-24	LFT6123036	U-23
LFT4060612	U-22	LFT4180936	U-24	LFT4362412	U-24	LFT6123612	U-23
LFT4060624	U-22	LFT4181212	U-24	LFT4362424	U-24	LFT6123624	U-23
LFT4060636	U-22	LFT4181224	U-24	LFT4362436	U-24	LFT6123636	U-23
LFT4060912	U-23	LFT4181236	U-24	LFT4363012	U-24	LFT6180612	U-24
LFT4060924	U-23	LFT4181812	U-22	LFT4363024	U-24	LFT6180624	U-24
LFT4060936	U-23	LFT4181824	U-22	LFT4363036	U-24	LFT6180636	U-24
LFT4061212	U-23	LFT4181836	U-22	LFT4363612	U-22	LFT6180912	U-24
LFT4061224	U-23	LFT4182412	U-23	LFT4363636	U-22	LFT6180924	U-24
LFT4061236	U-23	LFT4182424	U-23	LFT6060612	U-22	LFT6180936	U-24
LFT4061812	U-23	LFT4182436	U-23	LFT6060624	U-22	LFT6181212	U-24
LFT4061824	U-23	LFT4183012	U-23	LFT6060636	U-22	LFT6181224	U-24
LFT4061836	U-23	LFT4183024	U-23	LFT6060912	U-23	LFT6181236	U-24
LFT4062412	U-23	LFT4183036	U-23	LFT6060924	U-23	LFT6181812	U-22
LFT4062424	U-23	LFT4183612	U-23	LFT6060936	U-23	LFT6181824	U-22
LFT4062436	U-23	LFT4183624	U-23	LFT6061212	U-23	LFT6181836	U-22
LFT4063012	U-23	LFT4183636	U-23	LFT6061224	U-23	LFT6182412	U-23
LFT4063024	U-23	LFT4240612	U-24	LFT6061236	U-23	LFT6182424	U-23
LFT4063036	U-23	LFT4240624	U-24	LFT6061812	U-23	LFT6182436	U-23
LFT4063612	U-23	LFT4240636	U-24	LFT6061824	U-23	LFT6183012	U-23
LFT4063624	U-23	LFT4240912	U-24	LFT6061836	U-23	LFT6183024	U-23
LFT4063636	U-23	LFT4240924	U-24	LFT6062412	U-23	LFT6183036	U-23
LFT4090612	U-24	LFT4240936	U-24	LFT6062424	U-23	LFT6183612	U-23
LFT4090624	U-24	LFT4241212	U-24	LFT6062436	U-23	LFT6183624	U-23
LFT4090636	U-24	LFT4241224	U-24	LFT6063012	U-23	LFT6183636	U-23
LFT4090912	U-22	LFT4241236	U-24	LFT6063024	U-23	LFT6240612	U-24
LFT4090924	U-22	LFT4241812	U-24	LFT6063036	U-23	LFT6240624	U-24
LFT4090936	U-22	LFT4241824	U-24	LFT6063612	U-23	LFT6240636	U-24
LFT4091212	U-23	LFT4241836	U-24	LFT6063624	U-23	LFT6240912	U-24
LFT4091224	U-23	LFT4242412	U-22	LFT6063636	U-23	LFT6240924	U-24
LFT4091236	U-23	LFT4242424	U-22	LFT6090612	U-24	LFT6240936	U-24
LFT4091812	U-23	LFT4242436	U-22	LFT6090624	U-24	LFT6241212	U-24
LFT4091824	U-23	LFT4243012	U-23	LFT6090636	U-24	LFT6241224	U-24
LFT4091836	U-23	LFT4243024	U-23	LFT6090912	U-22	LFT6241236	U-24
LFT4092412	U-23	LFT4243036	U-23	LFT6090924	U-22	LFT6241812	U-24
LFT4092424	U-23	LFT4243612	U-23	LFT6090936	U-22	LFT6241824	U-24
LFT4092436	U-23	LFT4243624	U-23	LFT6091212	U-23	LFT6241836	U-24
LFT4093012	U-23	LFT4243636	U-23	LFT6091224	U-23	LFT6242412	U-22
LFT4093024	U-23	LFT4300612	U-24	LFT6091236	U-23	LFT6242424	U-22
LFT4093036	U-23	LFT4300624	U-24	LFT6091812	U-23	LFT6242436	U-22
LFT4093612	U-23	LFT4300636	U-24	LFT6091824	U-23	LFT6243012	U-23
LFT4093624	U-23	LFT4300912	U-24	LFT6091836	U-23	LFT6243024	U-23

Catalog Number Index

Catalog Number	Page	Catalog Number	Page	Catalog Number	Page	Catalog Number	Page
LFT6243036	U-23	LFVI6060624	U-19	LFVO3041212	U-20	LFVO4561836	U-20
LFT6243612	U-23	LFVI6060636	U-19	LFVO3041224	U-20	LFVO4562412	U-20
LFT6243624	U-23	LFVI6060912	U-19	LFVO3041236	U-20	LFVO4562424	U-20
LFT6243636	U-23	LFVI6060924	U-19	LFVO3041812	U-20	LFVO4562436	U-20
LFT6300612	U-24	LFVI6060936	U-19	LFVO3041824	U-20	LFVO4563012	U-20
LFT6300624	U-24	LFVI6061212	U-19	LFVO3041836	U-20	LFVO4563024	U-20
LFT6300636	U-24	LFVI6061224	U-19	LFVO3042412	U-20	LFVO4563036	U-20
LFT6300912	U-24	LFVI6061236	U-19	LFVO3042424	U-20	LFVO4563612	U-20
LFT6300924	U-24	LFVI6061812	U-19	LFVO3042436	U-20	LFVO4563624	U-20
LFT6300936	U-24	LFVI6061824	U-19	LFVO3043012	U-20	LFVO4563636	U-20
LFT6301212	U-24	LFVI6061836	U-19	LFVO3043024	U-20	LFVO6040612	U-20
LFT6301224	U-24	LFVI6062412	U-19	LFVO3043036	U-20	LFVO6040624	U-20
LFT6301236	U-24	LFVI6062424	U-19	LFVO3043612	U-20	LFVO6040636	U-20
LFT6301812	U-24	LFVI6062436	U-19	LFVO3043624	U-20	LFVO6040912	U-20
LFT6301824	U-24	LFVI6063012	U-19	LFVO3043636	U-20	LFVO6040924	U-20
LFT6301836	U-24	LFVI6063024	U-19	LFVO3060612	U-20	LFVO6040936	U-20
LFT6302412	U-24	LFVI6063036	U-19	LFVO3060624	U-20	LFVO6041212	U-20
LFT6302424	U-24	LFVI6063612	U-19	LFVO3060636	U-20	LFVO6041224	U-20
LFT6302436	U-24	LFVI6063624	U-19	LFVO3060912	U-20	LFVO6041236	U-20
LFT6303012	U-22	LFVI6063636	U-19	LFVO3060924	U-20	LFVO6041812	U-20
LFT6303024	U-22	LFVI9040612	U-19	LFVO3060936	U-20	LFVO6041824	U-20
LFT6303036	U-22	LFVI9040624	U-19	LFVO3061212	U-20	LFVO6041836	U-20
LFT6303612	U-23	LFVI9040636	U-19	LFVO3061224	U-20	LFVO6042412	U-20
LFT6303624	U-23	LFVI9040912	U-19	LFVO3061236	U-20	LFVO6042424	U-20
LFT6303636	U-23	LFVI9040924	U-19	LFVO3061812	U-20	LFVO6042436	U-20
LFT6360612	U-24	LFVI9040936	U-19	LFVO3061824	U-20	LFVO6043012	U-20
LFT6360624	U-24	LFVI9041212	U-19	LFVO3061836	U-20	LFVO6043024	U-20
LFT6360636	U-24	LFVI9041224	U-19	LFVO3062412	U-20	LFVO6043036	U-20
LFT6360912	U-24	LFVI9041236	U-19	LFVO3062424	U-20	LFVO6043612	U-20
LFT6360924	U-24	LFVI9041812	U-19	LFVO3062436	U-20	LFVO6043624	U-20
LFT6360936	U-24	LFVI9041824	U-19	LFVO3063012	U-20	LFVO6043636	U-20
LFT6361212	U-24	LFVI9041836	U-19	LFVO3063024	U-20	LFVO6060612	U-20
LFT6361224	U-24	LFVI9042412	U-19	LFVO3063036	U-20	LFVO6060624	U-20
LFT6361236	U-24	LFVI9042424	U-19	LFVO3063612	U-20	LFVO6060636	U-20
LFT6361812	U-24	LFVI9042436	U-19	LFVO3063624	U-20	LFVO6060912	U-20
LFT6361824	U-24	LFVI9043012	U-19	LFVO3063636	U-20	LFVO6060924	U-20
LFT6361836	U-24	LFVI9043024	U-19	LFVO4540612	U-20	LFVO6060936	U-20
LFT6362412	U-24	LFVI9043036	U-19	LFVO4540624	U-20	LFVO6061212	U-20
LFT6362424	U-24	LFVI9043612	U-19	LFVO4540636	U-20	LFVO6061224	U-20
LFT6362436	U-24	LFVI9043624	U-19	LFVO4540912	U-20	LFVO6061236	U-20
LFT6363012	U-24	LFVI9043636	U-19	LFVO4540924	U-20	LFVO6061812	U-20
LFT6363024	U-24	LFVI9060612	U-19	LFVO4540936	U-20	LFVO6061824	U-20
LFT6363036	U-24	LFVI9060624	U-19	LFVO4541212	U-20	LFVO6061836	U-20
LFT6363612	U-22	LFVI9060636	U-19	LFVO4541224	U-20	LFVO6062412	U-20
LFT6363624	U-22	LFVI9060912	U-19	LFVO4541236	U-20	LFVO6062424	U-20
LFT6363636	U-22	LFVI9060924	U-19	LFVO4541812	U-20	LFVO6062436	U-20
LFVI4542424	U-19	LFVI9060936	U-19	LFVO4541824	U-20	LFVO6063012	U-20
LFVI4561212	U-19	LFVI9061212	U-19	LFVO4541836	U-20	LFVO6063024	U-20
LFVI4562412	U-19	LFVI9061224	U-19	LFVO4542412	U-20	LFVO6063036	U-20
LFVI4563612	U-19	LFVI9061236	U-19	LFVO4542424	U-20	LFVO6063612	U-20
LFVI6040924	U-19	LFVI9061812	U-19	LFVO4542436	U-20	LFVO6063624	U-20
LFVI6040936	U-19	LFVI9061824	U-19	LFVO4543012	U-20	LFVO6063636	U-20
LFVI6041212	U-19	LFVI9061836	U-19	LFVO4543024	U-20	LFVO9040612	U-20
LFVI6041224	U-19	LFVI9062412	U-19	LFVO4543036	U-20	LFVO9040624	U-20
LFVI6041236	U-19	LFVI9062424	U-19	LFVO4543612	U-20	LFVO9040636	U-20
LFVI6041812	U-19	LFVI9062436	U-19	LFVO4543624	U-20	LFVO9040912	U-20
LFVI6041824	U-19	LFVI9063012	U-19	LFVO4543636	U-20	LFVO9040924	U-20
LFVI6041836	U-19	LFVI9063024	U-19	LFVO4560612	U-20	LFVO9040936	U-20
LFVI6042412	U-19	LFVI9063036	U-19	LFVO4560624	U-20	LFVO9041212	U-20
LFVI6042424	U-19	LFVI9063612	U-19	LFVO4560636	U-20	LFVO9041224	U-20
LFVI6042436	U-19	LFVI9063624	U-19	LFVO4560912	U-20	LFVO9041236	U-20
LFVI6043012	U-19	LFVI9063636	U-19	LFVO4560924	U-20	LFVO9041812	U-20
LFVI6043024	U-19	LFVO3040612	U-20	LFVO4560936	U-20	LFVO9041824	U-20
LFVI6043036	U-19	LFVO3040624	U-20	LFVO4561212	U-20	LFVO9041836	U-20
LFVI6043612	U-19	LFVO3040636	U-20	LFVO4561224	U-20	LFVO9042412	U-20
LFVI6043624	U-19	LFVO3040912	U-20	LFVO4561236	U-20	LFVO9042424	U-20
LFVI6043636	U-19	LFVO3040924	U-20	LFVO4561812	U-20	LFVO9042436	U-20
LFVI6060612	U-19	LFVO3040936	U-20	LFVO4561824	U-20	LFVO9043012	U-20

Catalog Number Index

Catalog Number	Page	Catalog Number	Page	Catalog Number	Page	Catalog Number	Page
LFVO9043024	U-20	LFX4242412	U-25	LFX6181812	U-25	LNM25BPK100	W-86, W-73
LFVO9043036	U-20	LFX4242424	U-25	LFX6181824	U-25	LNM32BPK100	W-86, W-73
LFVO9043612	U-20	LFX4242436	U-25	LFX6181836	U-25	LNM40BPK100	W-86, W-73
LFVO9043624	U-20	LFX4300612	U-26	LFX6240612	U-26	LNP11BPK100	W-86, W-73
LFVO9043636	U-20	LFX4300624	U-26	LFX6240624	U-26	LNP13BPK100	W-86, W-73
LFVO9060612	U-20	LFX4300636	U-26	LFX6240636	U-26	LNP16BPK100	W-86, W-73
LFVO9060624	U-20	LFX4300912	U-26	LFX6240912	U-26	LNP21BPK100	W-86, W-73
LFVO9060636	U-20	LFX4300924	U-26	LFX6240924	U-26	LNP29BPK25	W-86, W-73
LFVO9060912	U-20	LFX4300936	U-26	LFX6240936	U-26	LNP36BPK25	W-86, W-73
LFVO9060924	U-20	LFX4301212	U-26	LFX6241212	U-26	LNP7BPK100	W-86, W-73
LFVO9060936	U-20	LFX4301224	U-26	LFX6241224	U-26	LNP9BPK100	W-86, W-73
LFVO9061212	U-20	LFX4301236	U-26	LFX6241236	U-26	LR100	AA-21, G-29, AA-20
LFVO9061224	U-20	LFX4301812	U-26	LFX6241812	U-26	LR320	G-29
LFVO9061236	U-20	LFX4301824	U-26	LFX6241824	U-26	LR3430	G-29
LFVO9061812	U-20	LFX4301836	U-26	LFX6241836	U-26	LR420	G-29
LFVO9061824	U-20	LFX4302412	U-26	LFX6242412	U-25	LR520	G-29
LFVO9061836	U-20	LFX4302424	U-26	LFX6242424	U-25	LR530	G-29
LFVO9062412	U-20	LFX4302436	U-26	LFX6242436	U-25	LR60	G-29
LFVO9062424	U-20	LFX4303012	U-25	LFX6300612	U-26	LSC06	U-33
LFVO9062436	U-20	LFX4303024	U-25	LFX6300624	U-26	LSC09	U-33
LFVO9063012	U-20	LFX4303036	U-25	LFX6300636	U-26	LSC12	U-33
LFVO9063024	U-20	LFX4360612	U-26	LFX6300912	U-26	LSC18	U-33
LFVO9063036	U-20	LFX4360624	U-26	LFX6300924	U-26	LSC24	U-33
LFVO9063612	U-20	LFX4360636	U-26	LFX6300936	U-26	LSC30	U-33
LFVO9063624	U-20	LFX4360912	U-26	LFX6301212	U-26	LSC36	U-33
LFVO9063636	U-20	LFX4360924	U-26	LFX6301224	U-26	LSE06	U-33
LFX4060612	U-25	LFX4360936	U-26	LFX6301236	U-26	LSE09	U-33
LFX4060624	U-25	LFX4361212	U-26	LFX6301812	U-26	LSE12	U-33
LFX4060636	U-25	LFX4361224	U-26	LFX6301824	U-26	LSE18	U-33
LFX4090612	U-26	LFX4361236	U-26	LFX6301836	U-26	LSE24	U-33
LFX4090624	U-26	LFX4361812	U-26	LFX6302412	U-26	LSH06	U-33
LFX4090636	U-26	LFX4361824	U-26	LFX6302424	U-26	LSH09	U-33
LFX4090912	U-25	LFX4361836	U-26	LFX6302436	U-26	LSH12	U-33
LFX4090924	U-25	LFX4362412	U-26	LFX6303012	U-25	LSH18	U-33
LFX4090936	U-25	LFX4362424	U-26	LFX6303024	U-25	LSH24	U-33
LFX4120612	U-26	LFX4362436	U-26	LFX6303036	U-25	LSH30	U-33
LFX4120624	U-26	LFX4363012	U-26	LFX6360612	U-26	LSW06	U-33
LFX4120636	U-26	LFX4363024	U-26	LFX6360624	U-26	LSW09	U-33
LFX4120912	U-26	LFX4363036	U-26	LFX6360636	U-26	LSW12	U-33
LFX4120924	U-26	LFX4363624	U-25	LFX6360912	U-26	LSW18	U-33
LFX4120936	U-26	LFX4363636	U-25	LFX6360924	U-26	LTB409	U-17
LFX4121212	U-25	LFX6060612	U-25	LFX6360936	U-26	LTB412	U-17
LFX4121224	U-25	LFX6060624	U-25	LFX6361212	U-26	LTB418	U-17
LFX4121236	U-25	LFX6060636	U-25	LFX6361224	U-26	LTB424	U-17
LFX4180612	U-26	LFX6090612	U-26	LFX6361236	U-26	LTB609	U-17
LFX4180624	U-26	LFX6090624	U-26	LFX6361812	U-26	LTB612	U-17
LFX4180636	U-26	LFX6090636	U-26	LFX6361824	U-26	LTB618	U-17
LFX4180912	U-26	LFX6090912	U-25	LFX6361836	U-26	LTB624	U-17
LFX4180924	U-26	LFX6090924	U-25	LFX6362412	U-26	LTB636	U-17
LFX4180936	U-26	LFX6090936	U-25	LFX6362424	U-26	LTC406	U-17
LFX4181212	U-26	LFX6120612	U-26	LFX6362436	U-26	LTC409	U-17
LFX4181224	U-26	LFX6120624	U-26	LFX6363012	U-26	LTC412	U-17
LFX4181236	U-26	LFX6120636	U-26	LFX6363024	U-26	LTC418	U-17
LFX4181812	U-25	LFX6120912	U-26	LFX6363036	U-26	LTC424	U-17
LFX4181824	U-25	LFX6120924	U-26	LFX6363612	U-25	LTC430	U-17
LFX4181836	U-25	LFX6120936	U-26	LFX6363624	U-25	LTC436	U-17
LFX4240612	U-26	LFX6121212	U-25	LFX6363636	U-25	LTC606	U-17
LFX4240624	U-26	LFX6121224	U-25	LGJ16	U-34	LTC609	U-17
LFX4240636	U-26	LFX6121236	U-25	LGWAL	U-34	LTC612	U-17
LFX4240912	U-26	LFX6180612	U-26	LHC12	U-33	LTC618	U-17
LFX4240924	U-26	LFX6180624	U-26	LHC38	U-33	LTC624	U-17
LFX4240936	U-26	LFX6180636	U-26	LHDC	U-34	LTC630	U-17
LFX4241212	U-26	LFX6180912	U-26	LHT12	U-33	LTC636	U-17
LFX4241224	U-26	LFX6180924	U-26	LHT38	U-33	LWS406	U-34
LFX4241236	U-26	LFX6180936	U-26	LHWB	U-33	LWS409	U-34
LFX4241812	U-26	LFX6181212	U-26	LNM12BPK100	W-86, W-73	LWS430	U-34
LFX4241824	U-26	LFX6181224	U-26	LNM16BPK100	W-86, W-73	LWS606	U-34
LFX4241836	U-26	LFX6181236	U-26	LNM20BPK100	W-86, W-73	LWS609	U-34

Catalog Number Index

Catalog Number	Page	Catalog Number	Page	Catalog Number	Page	Catalog Number	Page
LWS636	U-34	MCWF2050	I-6	NHC1023CR	W-71	NP226W	Z-13
M111LRGSP	AA-35	MCWF2060	I-6	NHC1023ZP	I-6	NP26	Z-12
M111LRSP	AA-35	MCWF2070	I-6	NHC1024	W-71	NP262	Z-12
M111LTR	AA-35	MCWF2080	I-6	NHC1024CR	W-71	NP262BK	Z-12
M111MSP	AA-35	MCWF2090	I-6	NHC1024ZP	W-71	NP262GY	Z-12
M111SP	AA-35	MCWF2100	I-6	NHC1035	W-71	NP262I	Z-12
M123LTR	AA-35	MCWF2110	I-6	NHC1035CR	W-71	NP262LA	Z-12
M123MMSP	AA-35	MCWF2120	I-6	NHC1035ZP	W-71	NP262W	Z-12
M123MSP	AA-35	MCWF2130	I-6	NHC1036	W-71	NP263	Z-12
M123SP	AA-35	MD30	F-14	NHC1036CR	W-71	NP263BK	Z-12
M21SP	AA-35	MD30XL	F-14	NHC1036ZP	W-71	NP263GY	Z-12
M223JSP	AA-35	MD4P	F-14	NHC1037	W-71	NP263I	Z-12
M223MMSP	AA-35	MD60	F-14	NHC1037CR	W-71	NP263LA	Z-12
M223SP	AA-35	MD60GB	F-14	NHC1037ZP	W-71	NP263W	Z-12
M3R002SG000	I-5	MD60NB	F-14	NHC1038	W-71	NP264	Z-12
M3R002SG00P	I-5	MDAC2	F-14	NHC1038CR	W-71	NP264BK	Z-12
M3R002SGGF0	I-5	MDAC2NO	F-14	NHC1038ZP	W-71	NP264GY	Z-12
M3R002SGGFP	I-5	MDGB	F-14	NHC1040	W-71	NP264I	Z-12
M3RSL1SG000	I-5	MDNB	F-14	NHC1041	W-71	NP264LA	Z-12
M3RSL1SG00P	I-5	MFBRFBL1	O-31, O-29	NHC1041CR	W-71	NP264W	Z-12
M3RSL1SGGF0	I-5	MFBRFBR1	O-31, O-29	NHC1041ZP	W-71	NP265	Z-12
M3RSL1SGGFP	I-5	MFBRFBR2	O-31, O-29	NHC1042	W-71	NP265BK	Z-12
M4100B12R	AA-4, G-12, AA-20	MFBRFBR3	O-31, O-29	NHC1042CR	W-71	NP265GY	Z-12
M4100C12	G-12, AA-20, AA-5	MFBRFBGY1	O-31, O-29	NHC1043	W-71	NP265I	Z-12
M4100C12R	AA-4, G-12, AA-20	MFBRFBGY2	O-31, O-29	NHC1043CR	W-71	NP265LA	Z-12
M4100P12	G-12, AA-20, AA-5	MFBRFBGY3	O-31, O-29	NHC1044	W-71	NP265W	Z-12
M4100R12	G-12, AA-20, AA-5	MFBRFI1	O-31, O-29	NHC1051	W-71	NP266	Z-12
M4L2003PB0	I-6	MFBRFI2	O-31, O-29	NHC1052	W-71	NP266BK	Z-12
M4L2003PBP	I-6	MFBRFI3	O-31, O-29	NHC1053	W-71	NP266GY	Z-12
M5100B7R	AA-4, AA-21, G-12	MH11	AA-35	NHC1054	W-71	NP266I	Z-12
M5100B9R	AA-4, AA-21, G-12	MHB11	AA-35	NHC1057	W-71	NP266LA	Z-12
M5100C7	AA-21, G-12, AA-5	MHC1022	W-74	NHC1059	W-71	NP266W	Z-12
M5100C7R	AA-4, AA-21, G-12	MHC1022CR	W-74	NHC1066	W-71	NP26BK	Z-12
M5100C9	AA-21, G-12, AA-5	MHC1032	W-74	NHC1067	W-71	NP26GY	Z-12
M5100C9R	AA-4, AA-21, G-12	MHC1032CR	W-74	NHC2022CR	W-71	NP26I	Z-12
M5100P7	AA-21, G-12, AA-5	MHC2022CR	W-74	NHC2023CR	W-71	NP26LA	Z-12
M5100P9	AA-21, G-12, AA-5	MHC2032CR	W-74	NHC2024CR	W-71	NP26W	Z-12, Y-18
M5100R7	AA-21, G-12, AA-5	MICPK30	G-26, F-17, G-47, G-23	NHC2041CR	W-71	NP326	Z-13
M5100R9	AA-21, G-12, AA-5	MICPK60	G-26, F-17, G-47, G-23	NHC2042CR	W-71	NP326BK	Z-13
M5200BS1R	AA-4, G-41, AA-23	MLWF2010	I-6	NP126	Z-13	NP326GY	Z-13
M5200CS1	AA-23, G-40, AA-5	MLWF201P	I-6	NP1262	Z-13	NP326I	Z-13
M5200CS1R	AA-4, G-41, AA-23	MLWF2020	I-6	NP1262BK	Z-13	NP326LA	Z-13
M5200PS1	AA-23, G-40, AA-5	MLWF202P	I-6	NP1262GY	Z-13	NP326W	Z-13
M5200RS1	AA-23, G-40, AA-5	MR11LRSP	AA-35	NP1262I	Z-13	NP826	Z-13
MB2003WAA-23, G-44, G-40, G-42, G-41		MR11MSP	AA-35	NP1262LA	Z-13	NP826BK	Z-13
MB2004WAA-23, G-44, G-40, G-42, G-41		MR11SP	AA-35	NP1262W	Z-13	NP826GY	Z-13
MB301W	G-44, G-42	MR123LRSP	AA-35	NP126BK	Z-13	NP826I	Z-13
MB302W	G-44, G-42	MR123MMSP	AA-35	NP126GY	Z-13	NP826LA	Z-13
MB303W	G-44, G-42	MR123MSP	AA-35	NP126I	Z-13	NP826W	Z-13
MB304W	G-44, G-42	MR123SP	AA-35	NP126LA	Z-13	NPJ126	Z-13
MB601002W	G-44, G-42	MR21SP	AA-35	NP126W	Z-13	NPJ126BK	Z-13
MB601003W	G-44, G-42	MR223MMSP	AA-35	NP1326	Z-13	NPJ126GY	Z-13
MB601004W	G-44, G-42	MR223SP	AA-35	NP1326BK	Z-13	NPJ126I	Z-13
MB601006W	G-44, G-42	MS2	F-30	NP1326GY	Z-13	NPJ126LA	Z-13
MB601007W	G-44, G-42	MS5	F-30	NP1326I	Z-13	NPJ126W	Z-13
MB601008W	G-44, G-42	MSB1	AA-35	NP1326LA	Z-13	NPJ1326	Z-13
MB601W	G-44, G-42	NHC1010	W-71	NP1326W	Z-13	NPJ1326I	Z-13
MB602W	G-44, G-42	NHC1011	W-71	NP226	Z-13	NPJ1326LA	Z-13
MB603W	G-44, G-42	NHC1012	W-71	NP2262	Z-13	NPJ1326W	Z-13
MB604W	G-44, G-42	NHC1020	W-71	NP2262BK	Z-13	NPJ226	Z-13
MB605W	G-44, G-42	NHC1020CR	W-71	NP2262GY	Z-13	NPJ226BK	Z-13
MB606W	G-44, G-42	NHC1021	W-71	NP2262I	Z-13	NPJ226GY	Z-13
MCWF2010	I-6	NHC1021CR	W-71	NP2262LA	Z-13	NPJ226I	Z-13
MCWF2020	I-6	NHC1021ZP	W-71	NP2262W	Z-13	NPJ226LA	Z-13
MCWF2030	I-6	NHC1022	W-71	NP226BK	Z-13	NPJ226W	Z-13
MCWF2040	I-6	NHC1022CR	W-71	NP226GY	Z-13	NPJ26	Z-12
		NHC1022ZP	W-71	NP226I	Z-13	NPJ262	Z-12
		NHC1023	W-71	NP226LA	Z-13	NPJ262BK	Z-12

Catalog Number Index

Catalog Number	Page	Catalog Number	Page	Catalog Number	Page	Catalog Number	Page
NPJ262GY	Z-12	NS611I	Z-10, Y-10	NS760W	Y-27	NSC5EBK10	Y-17
NPJ262I	Z-12	NS611LA	Z-10, Y-10	NS770	Z-11, Y-25	NSC5EBK15	Y-17
NPJ262LA	Z-12	NS611W	Z-10, Y-10	NS770BK	Z-11, Y-25	NSC5EGY01	Y-17
NPJ262W	Z-12	NS612BK	Z-10, Y-10, AA-46	NS770GY	Z-11, Y-25	NSC5EGY03	Y-17
NPJ263	Z-12	NS612GY	Z-10, Y-10, AA-46	NS770I	Z-11, Y-25	NSC5EGY05	Y-17
NPJ263BK	Z-12	NS612I	Z-10, Y-10, AA-46	NS770LA	Z-11, Y-25	NSC5EGY07	Y-17
NPJ263GY	Z-12	NS612LA	Z-10, Y-10	NS770W	Z-11, Y-25	NSC5EGY10	Y-17
NPJ263I	Z-12	NS612W	Z-10, Y-10, AA-46	NS771	Z-11, Y-25	NSC5EGY15	Y-17
NPJ263LA	Z-12	NS613BK	Z-10, Y-10, AA-46	NS771I	Z-11, Y-25	NSC5EW01	Y-17
NPJ263W	Z-12	NS613GY	Z-10, Y-10, AA-46	NS771LA	Z-11, Y-25	NSC5EW03	Y-17
NPJ264	Z-12	NS613I	Z-10, Y-10, AA-46	NS771W	Z-11, Y-25	NSC5EW05	Y-17
NPJ264BK	Z-12	NS613LA	Z-10, Y-10	NS772I	Z-11, Y-25	NSC5EW07	Y-17
NPJ264GY	Z-12	NS613W	Z-10, Y-10, AA-46	NS772LA	Z-11, Y-25	NSC5EW10	Y-17
NPJ264I	Z-12	NS614BK	Z-10, Y-10	NS772W	Z-11, Y-25	NSC5EW15	Y-17
NPJ264LA	Z-12	NS614GY	Z-10, Y-10	NS780I	Z-11	NSC6B01	Y-17
NPJ264W	Z-12	NS614I	Z-10, Y-10	NS780LA	Z-11, Y-25	NSC6B03	Y-17
NPJ26BK	Z-12	NS614LA	Z-10, Y-10	NS780W	Z-11, Y-25	NSC6B05	Y-17
NPJ26GY	Z-12	NS614W	Z-10, Y-10	NS783I	Z-11	NSC6B07	Y-17
NPJ26I	Z-12	NS616BK	Z-10, Y-10	NS783LA	Z-11, Y-25	NSC6B10	Y-17
NPJ26LA	Z-12	NS616GY	Z-10, Y-10	NS783W	Z-11, Y-25, AA-46	NSC6B15	Y-17
NPJ26W	Z-12	NS616I	Z-10, Y-10	NS784	Z-11, Y-25	NSC6BK01	Y-17
NPJ826	Z-13	NS616LA	Z-10, Y-10	NS784BK	Z-11, Y-25	NSC6BK03	Y-17
NPJ826BK	Z-13	NS616W	Z-10, Y-10	NS784GY	Z-11, Y-25	NSC6BK05	Y-17
NPJ826GY	Z-13	NS620BK	Z-10, N-29, O-22, Y-10, P-29	NS784I	Z-11, Y-25	NSC6BK07	Y-17
NPJ826I	Z-13	NS620GY	Z-10, N-29, Y-10	NS784LA	Z-11, Y-25	NSC6BK10	Y-17
NPJ826LA	Z-13	NS620I	Z-10, N-29, Y-10	NS784W	Z-11, Y-25	NSC6BK15	Y-17
NPJ826W	Z-13	NS620LA	Z-10, N-29, Y-10	NS785	Z-11, Y-25	NSC6GY01	Y-17
NPJJ13I	N-9	NS620W	Z-10, N-29, Y-10	NS785BK	Z-11, Y-25	NSC6GY03	Y-17
NPJJ13LA	N-9	NS621I	Z-10, N-29	NS785GY	Z-11, Y-25	NSC6GY05	Y-17
NPJJ13W	N-9	NS621LA	Z-10, N-29	NS785I	Z-11	NSC6GY07	Y-17
NPJJ1I	N-6	NS621W	Z-10, N-29	NS785LA	Z-11, Y-25	NSC6GY10	Y-17
NPJJ1LA	N-6	NS722I	Y-27	NS785W	Z-11, Y-25	NSC6GY15	Y-17
NPJJ1W	N-6	NS722W	Y-27	NS790	Y-26	NSC6W01	Y-17
NPJJ26I	N-5	NS726SS	Y-27	NS790BK	Y-26	NSC6W03	Y-17
NPJJ26LA	N-5	NS730	Y-26	NS790GY	Y-26	NSC6W05	Y-17
NPJJ26W	N-5	NS730I	Y-26	NS790I	Y-26	NSC6W07	Y-17
NPJJ2I	N-6	NS730LA	Y-26	NS790LA	Y-26	NSC6W10	Y-17
NPJJ2LA	N-6	NS730W	Y-26	NS790W	Y-26	NSC6W15	Y-17
NPJJ2W	N-6	NS732	Y-26	NS801BK	Y-19, Y-5	NSF70BK	Y-6, Z-10
NPJJ8I	N-7	NS732I	Y-26	NS801GY	Y-19, Y-5	NSF70GY	Y-6, Z-10
NPJJ8LA	N-7	NS732LA	Y-26	NS801I	Y-19, Y-5	NSF70I	Y-6, Z-10
NPJJ8W	N-7	NS732W	Y-26	NS801LA	Y-19, Y-5	NSF70LA	Y-6, Z-10
NPS1I	D-19, Z-12, N-4	NS732I	Y-26	NS801W	Y-19, Y-5, X-7, Y-18	NSF70W	Y-6, Z-10, Y-18
NPS1LA	D-19, Z-12, N-4	NS735I	Y-26	NS802BK	Y-19, Y-5	NSJ5EB	Z-10, Y-4
NPS1W	D-19, Z-12, N-4	NS735LA	Y-26	NS802GY	Y-19, Y-5	NSJ5EB25	Z-10, Y-4
NPS262I	D-19, Z-12, N-4	NS735W	Y-26	NS802I	Y-19, Y-5	NSJ5EBK	Z-10, AA-46, Y-4
NPS262LA	D-19, Z-12, N-4	NS744I	Y-26	NS802LA	Y-19, Y-5	NSJ5EBK25	Z-10, Y-4
NPS262W	D-19, Z-12, N-4	NS744W	Y-26	NS802W	Y-19, Y-5, Y-18	NSJ5EGN	Z-10, Y-4
NPS263I	Z-12, N-4	NS745I	Y-26	NSAV124M	X-7, Y-18	NSJ5EGN25	Z-10, Y-4
NPS263LA	Z-12, N-4	NS745W	Y-26	NSAV12C	X-7, Y-18	NSJ5EGY	Z-10, AA-46, Y-4
NPS263W	Z-12, N-4	NS747I	Y-26	NSAV1I	Z-9	NSJ5EGY25	Z-10, Y-4
NPS264I	Z-12, N-4	NS747LA	Y-26	NSAV1W	Z-9	NSJ5EI	Z-10, AA-46, Y-4
NPS264LA	Z-12, N-4	NS747W	Y-26	NSAV2I	Z-9	NSJ5EI25	Z-10, Y-4
NPS264W	Z-12, N-4	NS748I	Y-26	NSAV2W	Z-9	NSJ5ELA	Z-10, Y-4
NPS26I	D-19, Z-12, N-4	NS748LA	Y-26	NSAV62M	X-7, Y-18	NSJ5ELA25	Z-10, Y-4
NPS26LA	D-19, Z-12, N-4	NS748W	Y-26	NSAV6BW	Y-18	NSJ5EOR	Z-10, Y-4
NPS26W	D-19, Z-12, N-4	NS750I	Y-26	NSAV6C	X-7, Y-18	NSJ5EOR25	Z-10, Y-4
NPS2I	D-19, Z-12, N-4	NS750LA	Y-26	NSAV6NW	Y-18	NSJ5ER	Z-10, Y-4
NPS2LA	D-19, Z-12, N-4	NS750W	Y-26	NSC5EB01	Y-17	NSJ5ER25	Z-10, Y-4
NPS2W	D-19, Z-12, N-4	NS751I	Y-26	NSC5EB03	Y-17	NSJ5EW	Z-10, AA-46, Y-4
NPS3I	Z-12, N-4	NS751LA	Y-26	NSC5EB05	Y-17	NSJ5EW25	Z-10, Y-4
NPS3LA	Z-12, N-4	NS751W	Y-26	NSC5EB07	Y-17	NSJ5EY	Z-10, Y-4
NPS3W	Z-12, N-4	NS752I	Y-26	NSC5EB10	Y-17	NSJ5EY25	Z-10, Y-4
NPS8I	Z-12, N-4	NS752W	Y-26	NSC5EB15	Y-17	NSJ6B	Z-10, Y-4
NPS8LA	Z-12, N-4	NS755I	Y-26	NSC5EBK01	Y-17	NSJ6B25	Z-10, Y-4
NPS8W	Z-12, N-4	NS755LA	Y-26	NSC5EBK03	Y-17	NSJ6BK	Z-10, AA-46, Y-4
NS611BK	Z-10, Y-10	NS755W	Y-26	NSC5EBK05	Y-17	NSJ6BK25	Z-10, Y-4
NS611GY	Z-10, Y-10	NS760I	Y-27	NSC5EBK07	Y-17	NSJ6GN	Z-10, Y-4

Catalog Number Index

Catalog Number	Page	Catalog Number	Page	Catalog Number	Page	Catalog Number	Page
NSJ6GN25	Z-10, Y-4	NSP13GY	Y-9	P13I	AA-45, N-9	P264	N-5
NSJ6GY	Z-10, AA-46, Y-4	NSP13I	Y-9	P13LA	N-9	P264BK	N-5
NSJ6GY25	Z-10, Y-4	NSP13LA	Y-9	P13W	AA-45, N-9	P264GY	N-5
NSJ6I	Z-10, AA-46, Y-4	NSP13W	Y-9	P14	N-9	P264I	N-5
NSJ6I25	Z-10, Y-4	NSP14BK	Y-9	P14BK	N-9	P264LA	N-5
NSJ6LA	Z-10, Y-4	NSP14GY	Y-9	P14GY	N-9	P264W	N-5
NSJ6LA25	Z-10, Y-4	NSP14I	Y-9	P14I	N-9	P265GY	N-5
NSJ6OR	Z-10, Y-4	NSP14LA	Y-9	P14R	N-9	P265I	N-5
NSJ6OR25	Z-10, Y-4	NSP14W	Y-9, Y-18	P14W	X-7, N-9, Y-18	P265LA	N-5
NSJ6R	Z-10, Y-4	NSP16BK	Y-9	P150NBK	W-89	P265W	N-5
NSJ6R25	Z-10, Y-4	NSP16GY	Y-9	P150NGY	W-89	P266	N-5
NSJ6W	Z-10, AA-46, Y-4, X-7, Y-18	NSP16I	Y-9	P155E	I-15	P266BK	N-5
NSJ6W25	Z-10, Y-4	NSP16LA	Y-9	P155E2	I-15	P266GY	N-5
NSJ6Y	Z-10, Y-4	NSP16W	Y-9	P155EB	I-15	P266I	N-5
NSJ6Y25	Z-10, Y-4	NSPJ24	Y-16	P15DB9MFC10	I-15	P266LA	N-5
NSJUB	Z-10, Y-4	NSPJ48	Y-16	P15DH485C10	I-15	P266W	N-5
NSJUBK	Z-10, AA-46, Y-4	NVA15GHGA	AA-51	P15ML8F8MC10	I-15	P26BK	A-52, N-5, AA-45
NSJUGN	Z-10, Y-4	NVBA	AA-51	P18	AA-45, N-10	P26GY	D-19, A-52, N-5, AA-45, M-13
NSJUGY	Z-10, AA-46, Y-4	NVGA	AA-51	P18GY	AA-45, N-10	P26I	D-19, A-52, N-5, AA-45, M-13
NSJUI	Z-10, AA-46, Y-4	NVX15GHGA	AA-51	P18I	AA-45, N-10	P26LA	D-19, A-52, N-5
NSJULA	Z-10, Y-4	P0389NBK	W-89	P18LA	N-10	P26OIG	M-13
NSJUOR	Z-10, Y-4	P0389NGY	W-89	P18W	X-15, AA-45, N-10	P26R	M-13, A-52, N-5
NSJUR	Z-10, Y-4	P038NBKA	W-89	P1BK	AA-45, N-6	P26W D-19, A-52, N-5, AA-45, X-15, M-13, X-7, Y-18	
NSJUW	Z-10, AA-46, Y-4	P038NGYA	W-89	P1GY	D-19, AA-45, N-6	P28	N-11
NSJUY	Z-10, Y-4	P0509NBK	W-89	P1I	D-19, AA-45, N-6	P28G	N-11
NSOAM8	Y-23	P0509NGY	W-89	P1LA	D-19, N-6	P28I	N-11
NSOBM2	Y-23	P050NBKA	W-89	P1R	N-6	P28LA	N-11
NSOBXP14	Y-21	P050NGYA	W-89	P1W	D-19, X-15, AA-45, N-6	P28W	N-11
NSOBXP14B	Y-21	P0759NBK	W-89	P200NBK	W-89	P2BK	AA-45, N-6
NSOBXP14D	Y-21	P0759NGY	W-89	P200NGY	W-89	P2GY	D-19, AA-45, N-6
NSOBXP28	Y-21	P075NBKA	W-89	P205EDB9	I-15	P2I	D-19, AA-45, N-6
NSOBXP28B	Y-21	P075NGYA	W-89	P20DH5E	I-15	P2LA	D-19, N-6
NSOBXP28D	Y-21	P1009NBK	W-89	P226	N-11	P2R	N-6
NSOBXP42	Y-21	P1009NGY	W-89	P2262I	N-12	P2W	D-19, X-15, AA-45, N-6
NSOBXP42B	Y-21	P100NBKA	W-89	P2262LA	N-12	P326	N-12
NSOBXP42D	Y-21	P100NGYA	W-89	P2262W	N-12	P326BK	N-12
NSODK6	Y-22	P113GY	N-10	P226BK	N-11	P326GY	N-12
NSODM8	Y-22	P113I	N-10	P226GY	N-11	P326I	N-12
NSODM8C6	Y-22	P113LA	N-10	P226I	N-11	P326LA	N-12
NSOETM8	Y-22	P113W	N-10	P226LA	N-11	P326W	N-12
NSOF8B	Y-24	P11I	N-13	P226W	N-11	P33I	N-9
NSOKPS	X-6, Y-24, X-7, Y-18	P11LA	N-13	P23	N-9	P33W	N-9
NSOKPTR	X-6, Y-24, X-7, Y-18	P11W	N-13	P23BK	N-9	P3BK	N-6
NSOMTM12	Y-22	P1259NBK	W-89	P23GY	N-9	P3GY	N-6
NSOMTM24	Y-22	P1259NGY	W-89	P23I	N-9	P3I	N-6
NSOPTM8	Y-22	P125NBK	W-89	P23LA	N-9	P3LA	N-6
NSORAVC	Y-24	P125NGY	W-89	P23W	N-9	P3W	N-6
NSOSAVC	Y-24	P126	AA-45, N-10	P24	N-9	P43I	N-9
NSOTVDM6	Y-22	P1262I	N-11	P24BK	N-9	P43W	N-9
NSOTVM6	Y-22	P1262LA	N-11	P24GY	N-9	P4BK	N-6
NSOVAMP	Y-23	P1262W	N-11	P24I	N-9	P4GY	N-6
NSOVM4	Y-23	P126BK	AA-45, N-10	P24R	N-9	P4I	N-6
NSOVM42G	Y-23	P126GY	AA-45, N-10	P24W	N-9	P4LA	N-6
NSOVM6	Y-23	P126I	AA-45, N-10	P26	A-52, N-5, AA-45	P4W	N-6
NSOVM62G	Y-23	P126LA	N-10	P262	AA-45, N-5	P4X155E	I-15
NSOVM8	Y-23	P126W	X-15, AA-45, N-10	P262BK	AA-45, N-5	P4X155EB	I-15
NSOVM82G	Y-23	P13	AA-45, N-9	P262GY	D-19, AA-45, N-5	P4X5E	I-15
NSP11BK	Y-9	P1326BK	N-10	P262I	D-19, AA-45, N-5	P4XUSBA2C3	I-15
NSP11GY	Y-9	P1326GY	N-10	P262LA	D-19, N-5	P5E	I-15
NSP11I	Y-9	P1326I	N-10	P262R	N-5	P5GY	N-6
NSP11LA	Y-9	P1326LA	N-10	P262W	D-19, AA-45, N-5, X-15	P5I	N-6
NSP11W	Y-9	P1326W	N-10	P263	N-5	P5LA	N-6
NSP12BK	Y-9	P138GY	N-11	P263BK	N-5	P5W	N-6
NSP12GY	Y-9	P138I	N-11	P263GY	N-5	P6GY	N-6
NSP12I	Y-9	P138LA	N-11	P263I	N-5	P6I	N-6
NSP12LA	Y-9	P138W	N-11	P263LA	N-5	P6LA	N-6
NSP12W	Y-9	P13BK	AA-45, N-9	P263R	N-5		
NSP13BK	Y-9	P13GY	AA-45, N-9	P263W	N-5		

Catalog Number Index

Catalog Number	Page	Catalog Number	Page	Catalog Number	Page	Catalog Number	Page
P6W	N-8	PB3FCIB3G	S-60	PFBFRFGY3	O-26	PJ23LA	N-9
P703	N-18	PB3FE	S-60	PFBRF1	O-26	PJ23W	N-9
P703BK	A-54, N-8	PB3FEBCA	S-59, S-60	PFBRF2	O-26	PJ26	AA-45, N-5
P703I	N-8	PB3IE	S-60	PFBRF3	O-26	PJ262	AA-45, N-5
P703W	N-8	PB3IEBCA	S-59, S-60	PFBRFRA	O-26	PJ262BK	AA-45, N-5
P720	N-8, N-18	PB3IND	S-60	PFBRG1	O-26, O-27	PJ262GY	AA-45, N-5
P720BK	B-52, N-8	PB3IND2G	S-60	PFBRG2	O-26, O-27	PJ262I	AA-45, N-5
P720GY	N-8	PB3REDA	S-59, S-60	PFBRG3	O-26, O-27	PJ262LA	N-5
P720I	N-8	PB3SC	S-59, S-60	PFBRC	O-26	PJ262R	N-5
P720OIG	N-15	PB3SPCA	S-59, S-60	PFBSTANDGY	O-21, O-17, Z-21	PJ262W	AA-45, N-5, X-15
P720R	N-8	PB3SS	S-59, S-60	PFBT1A	O-24	PJ263	N-5
P720W	N-8	PB3TCBCA	S-59, S-60	PFBYA1	O-24	PJ263BK	N-5
P724	N-18	PB3TRBC	S-59, S-60	PG2	F-30	PJ263GY	N-5
P724BK	A-54, N-8	PB3WC	S-60	PG6	F-30	PJ263I	N-5
P724I	N-8	PBS2	F-29	PH2030C	I-8, F-13	PJ263LA	N-5
P724W	N-8	PBS22	F-29	PH6595	AA-33	PJ263W	N-5
P737I	N-13	PBS4	F-29	PH6596	AA-33, AA-5	PJ264I	N-5
P737W	N-13	PBS42	F-29	PH6597	AA-33	PJ264LA	N-5
P78I	N-10	PBS6	F-29	PH6597TV	AA-33, AA-5	PJ264W	N-5
P78W	N-10	PBS62	F-29	PH6598	AA-32, AA-5	PJ26BK	AA-45, N-5
P7BK	N-7, A-52, AA-45	PBS8	F-29	PH6598W	AA-32	PJ26BL	M-13, N-5
P7GY	N-7, A-52, AA-45	PBS82	F-29	PH6599	AA-32, AA-5	PJ26C	M-13
P7I	B-50, A-52, N-7, AA-45	PBSBC	F-30	PH6599W	AA-32	PJ26GY	M-13, AA-45, N-5
P7LA	N-7, A-52	PBSPL	F-30	PH6624	AA-4, AA-32	PJ26I	M-13, AA-45, N-5
P7OIG	N-15	PBSPL1	F-30	PH6625	AA-32, AA-5	PJ26LA	N-5
P7R	N-7, A-52	PC100	G-12, G-29, G-11, AA-20, AA-21, G-7	PH7440	AA-4, AA-32, AA-5	PJ26R	M-13, N-5
P7W	N-7, A-52, AA-45	PC320	AA-24, G-29, G-10	PH7499	AA-32	PJ26W	M-13, AA-45, N-5, X-15
P82	N-7, AA-45	PC3430	G-29, AA-24, G-6, G-10	PJ1	AA-45, N-6	PJ28I	N-11
P826	N-10	PC420	G-29, G-10	PJ113	N-10	PJ28LA	N-11
P826BK	N-10	PC520	G-29, G-10	PJ113I	N-10	PJ28W	N-11
P826GY	N-10	PC530	G-29, G-7, G-6, G-10	PJ113W	N-10	PJ2BK	AA-45
P826I	N-10	PC60	G-29, G-6, G-11, AA-24, G-7	PJ11I	N-13	PJ2GY	AA-45, N-6
P826LA	N-10	PDB12D	S-56, S-62, S-58, S-55	PJ11LA	N-13	PJ2I	AA-45, N-6
P826W	X-15, N-10	PDB12LF	S-56, S-62, S-58, S-55	PJ11W	N-13	PJ2LA	N-6
P82BK	N-7, AA-45	PDB12LP	S-56, S-62, S-58, S-55	PJ126	AA-45, N-10	PJ2W	X-15, AA-45, N-6
P82GY	N-7, AA-45	PDB12S	S-56, S-62, S-58, S-55	PJ126BK	AA-45	PJ3GY	N-6
P82I	N-7, AA-45	PDB12TGD	S-56, S-62, S-58, S-55	PJ126GY	AA-45, N-10	PJ3I	N-6
P82LA	N-7	PDB12TGLV	S-56, S-62, S-58, S-55	PJ126I	AA-45, N-10	PJ3LA	N-6
P82OR	N-7	PDB12TGLV	S-56, S-62, S-58, S-55	PJ126LA	N-10	PJ3R	N-6
P82R	N-7	PDB1DIV	S-58	PJ126W	X-15, AA-45, N-10	PJ3W	N-6
P82W	N-7, AA-45, X-15	PDB2DIV	S-58	PJ13	AA-45, N-9	PJ4I	N-6
P83I	N-7	PDB9	I-15	PJ1326I	N-10	PJ4LA	N-6
P83W	N-7	PDB9MF	I-15	PJ1326LA	N-10	PJ4W	N-6
P8BK	N-7, A-52, AA-45	PDH5E	I-15	PJ1326W	N-10	PJ7	AA-45
P8GY	N-7, A-52, AA-45	PFB1	O-24	PJ13BK	AA-45, N-9	PJ703BK	N-8
P8I	B-50, A-52, N-7, AA-45	PFB1A	O-24	PJ13GY	AA-45, N-9	PJ703I	N-8
P8LA	N-7, A-52	PFBCLA	O-24	PJ13I	AA-45, N-9	PJ703W	N-8
P8OIG	N-15	PFBCBRA	O-24	PJ13LA	N-9	PJ724BK	N-8
P8OR	N-7, A-52	PFBGGA	O-24	PJ13W	AA-45, N-9	PJ724I	N-8
P8R	N-7, A-52	PFBGIA	O-24	PJ18	AA-45	PJ724W	N-8
P8W	AA-45, N-7, A-52, X-15	PFBP1	O-24	PJ18BK	AA-45	PJ7BK	AA-45
PB2B10	S-59	PFBP1	O-24	PJ18GY	AA-45, N-10	PJ7GY	AA-45
PB2B5	S-59	PFBP1	O-24	PJ18I	AA-45, N-10	PJ7I	N-7, AA-45
PB2C10	S-59	PFBP1	O-24	PJ18LA	N-10	PJ7LA	N-7
PB2C5	S-59	PFBP1	O-24	PJ18W	X-15, AA-45, N-10	PJ7W	N-7, AA-45
PB2CACF	S-59	PFBP1	O-24	PJ1BK	AA-45, N-6	PJ8	N-7, AA-45
PB2IND2G	S-59	PFBP1	O-24	PJ1GY	AA-45, N-6	PJ82	AA-45
PB2SPL10	S-59	PFBP1	O-24	PJ1I	AA-45, N-6	PJ826	N-10
PB2SPL5	S-59	PFBP1	O-24	PJ1LA	N-6	PJ826BK	N-10
PB2WC	S-59	PFBP1	O-24	PJ1R	N-6	PJ826GY	N-10
PB3BC10	S-60	PFBP1	O-24	PJ1RME	N-15	PJ826I	N-10
PB3BC5	S-60	PFBP1	O-24	PJ1W	X-15, AA-45, N-6	PJ826LA	N-10
PB3CACF	S-60	PFBP1	O-24	PJ2	AA-45, N-6	PJ826W	X-15, N-10
PB3ECA	S-59, S-60	PFBP1	O-24	PJ226I	N-11	PJ82BK	N-7, AA-45
PB3EE	S-60	PFBP1	O-24	PJ226LA	N-11	PJ82GY	N-7, AA-45
PB3EEBCA	S-59, S-60	PFBP1	O-24	PJ226W	N-11	PJ82I	N-7, AA-45
PB3FCIB	S-60	PFBP1	O-24	PJ23	N-9	PJ82LA	N-7
PB3FCIB2G	S-60	PFBP1	O-24	PJ23I	N-9	PJ82R	N-7

Catalog Number Index

Catalog Number	Page	Catalog Number	Page	Catalog Number	Page	Catalog Number	Page
PJ82W	N-7, AA-45, X-15	PS3EE	S-61	PT205112	S-62	PT2X2SFGY	P-31
PJ8BK	N-7, AA-45	PS3EEBC	S-61	PT205112BK	S-62	PT71SD	P-33
PJ8BL	N-7	PS3FCIB	S-61	PT205112P	S-62	PT73FFSDBK	P-33
PJ8GY	N-7, AA-45	PS3FCIB2G	S-61	PT205112PBK	S-62	PT73FFSDGY	P-33
PJ8I	N-7, AA-45	PS3FCIB3G	S-61	PT205112PW	S-62	PT73FFSDI	P-33
PJ8LA	N-7	PS3FE	S-61	PT205112TR	S-62	PT73SD	P-33, P-32
PJ8R	N-7	PS3FEBC	S-61	PT205112TRBK	S-62	PT7FFSDGY	P-33
PJ8RMEV	N-15	PS3IE	S-61	PT205112TRW	S-62	PT7FFSDI	P-33
PJ8W	N-7, AA-45, X-15	PS3IEBC	S-61	PT205112W	S-62	PT7FSD	P-32
PL1ABC5	S-56	PS3IND	S-61	PT205115	S-62	PT7FSDBLA	P-32
PL1ABC7	S-56	PS3RED	S-61	PT205115BK	S-62	PT7FSDBRA	P-32
PL1BC5	S-56	PS3SC	S-61	PT205115W	S-62	PT7FSDBRS2A	P-32
PL1BC7	S-56	PS3SPC	S-61	PT205130	S-62	PT7FSDBRS3A	P-32
PL1EC	S-62, S-56	PS3SS	S-61	PT205130BK	S-62	PT7FSDGYA	P-32
PL1EE	S-62, S-56	PS3TCBC	S-61	PT205130W	S-62	PT7FSDIA	P-32
PL1EEBC	S-62, S-56	PS3WC	S-61	PT205212	S-62	PT7IGFSDBRSA	P-32
PL1FE	S-62, S-56	PT12CA	S-62, S-54	PT205212BK	S-62	PT7IGFSDGYA	P-32
PL1FEBC	S-62, S-56	PT12DBA	S-54	PT205212W	S-62	PT7IGFSDIA	P-32
PL1IE	S-62, S-56	PT12LFB	S-54	PT205215	S-62	PT7XC	P-45, P-34, P-35, P-46
PL1IEBC	S-62, S-56	PT12LPB	S-54	PT205215BK	S-62	PW1ABC5	S-57
PL1MC	S-62	PT12SBA	S-54	PT205215W	S-62	PW1ABC7	S-57
PL1SC	S-62, S-56	PT12TGB	S-54	PT206108	S-62	PW1BC5	S-57
PL1SS	S-62, S-56	PT153112UP	Q-5, S-62	PT206108BK	S-62	PW1BC7	S-57
PL1TC	S-62, S-56	PT153112UPBK	S-62	PT206108W	S-62	PW1CA	S-57
PL1TCBC	S-62, S-56	PT153112UPW	S-62	PT206112	S-62	PW1DBA	S-57
PLP1CACF	S-56, S-62, S-55	PT155112	S-62	PT206112BK	S-62	PW1EC	S-57
PP1ABC5	S-55	PT155112BK	S-62	PT206112W	S-62	PW1EE	S-57
PP1ABC7	S-55	PT155112P	S-62	PT206118	S-62	PW1FE	S-57
PP1BC5	S-55	PT155112PBK	S-62	PT206118BK	S-62	PW1IE	S-57
PP1BC7	S-55	PT155112PW	S-62	PT206118W	S-62	PW1LFB	S-57
PP1EC	S-55	PT155112TR	S-62	PT206124	S-62	PW1LPB	S-57
PP1EE	S-55	PT155112TRBK	S-62	PT206124BK	S-62	PW1SBA	S-57
PP1EEBC	S-55	PT155112TRW	S-62	PT206124W	S-62	PW1SC	S-57
PP1FE	S-55	PT155112W	S-62	PT206136	S-62	PW1TC	S-57
PP1FEBC	S-55	PT155115	S-62	PT206136BK	S-62	PW1TGB	S-57
PP1IE	S-55	PT155115BK	S-62	PT206136W	S-62	PW2ABC5	S-58
PP1IEBC	S-55	PT155115W	S-62	PT206208	S-62	PW2ABC7	S-58
PP1SC	S-55	PT155130	S-62	PT206208BK	S-62	PW2BC5	S-58
PP1SS	S-55	PT155130BK	S-62	PT206208W	S-62	PW2BC7	S-58
PP1TC	S-55	PT155130W	S-62	PT206212	S-62	PW2CACF	S-58
PP1TCBC	S-55	PT155212	S-62	PT206212BK	S-62	PW2EC	S-58
PPTRIM1	R-4	PT155212BK	S-62	PT206212W	S-62	PW2EE	S-58
PR20	I-15	PT155212W	S-62	PT206218	S-62	PW2EEBC	S-58
PR205E	I-15	PT156112	S-62	PT206218BK	S-62	PW2FE	S-58
PR205EB	I-15	PT156112BK	S-62	PT206218W	S-62	PW2FEBC	S-58
PR205EDB9B	I-15	PT156112U	Q-5, S-62	PT206224	S-62	PW2IE	S-58
PR205EDB9MFB	I-15	PT156112UBK	S-62	PT206224BK	S-62	PW2IEBC	S-58
PR205EUSBA	I-15	PT156112UW	S-62	PT206224W	S-62	PW2RED	S-58
PR205EUSBA2	I-15	PT156112W	S-62	PT27A	P-45, P-34, P-46	PW2SC	S-58
PR205EUSBA2VGA	I-15	PT156118	S-62	PT2FIT	P-44, P-33	PW2SS	S-58
PR4X205E	I-15	PT156118BK	S-62	PT2X2ALU3	P-31	PW2TC	S-58
PR4X205E2DB92B	I-15	PT156118W	S-62	PT2X2BL	P-31	PW2TCBC	S-58
PR4X205EB	I-15	PT156124	S-62	PT2X2BRS	P-31	PWFB10MPCR20GRY	O-13
PR4X205EDB9B	I-15	PT156124BK	S-62	PT2X2BRS3	P-31	PWFB10MPDR20GRYTR	O-13
PS0389NBK	W-89	PT156124W	S-62	PT2X2CBL	P-31	PWFB10MPDR20GRY	O-13
PS0389NGY	W-89	PT1ABC5	S-54	PT2X2CBRS	P-31	PWFB10MPDR20GRYTR	O-13
PS0509NBK	W-89	PT1ABC7	S-54	PT2X2CGY	P-31	PWFBMP2R	O-10
PS0509NGY	W-89	PT1BC5	S-54	PT2X2FIT	P-31	PWFBMP2RC	O-10
PS05GYKIT	W-89	PT1BC7	S-54	PT2X2GY	P-31	PWFBMP3R	O-10
PS0759NBK	W-89	PT1EC	S-54	PT2X2IGALU3	P-31	PWFBMP3RC	O-10
PS0759NGY	W-89	PT1EE	S-54	PT2X2IGBL	P-31	PWFBMPPCR20GRY	O-10
PS07GYKIT	W-89	PT1FE	S-54	PT2X2IGBRS	P-31	PWFBMPPCR20GRYTR	O-10
PS1009NBK	W-89	PT1IE	S-54	PT2X2IGBRS3	P-31	PWFBMPDR20GRY	O-10
PS1009NGY	W-89	PT1SC	S-54	PT2X2IGGY	P-31	PWFBMPDR20GRYTR	O-10
PS3BC10	S-61	PT1TC	S-54	PT2X2SFALU3	P-31	Q106B	Y-10
PS3BC5	S-61	PT203112P	S-62	PT2X2SFB	P-31	Q106E	Y-10, S-45
PS3CACF	S-61	PT203112PBK	S-62	PT2X2SFBRS	P-31	Q106G	Y-10, S-45
PS3EC	S-61	PT203112PW	S-62	PT2X2SFBRS3	P-31	Q106O	Y-10, S-63

Catalog Number Index

Catalog Number	Page	Catalog Number	Page	Catalog Number	Page	Catalog Number	Page
Q106W	Y-10	RC308I	Z-15	RCT221BK	Z-25	RF515NI	Z-22
R28032401	Z-19	RC308ITR	Z-15	RCT221BR	Z-25	RF515SS	Z-22
R28032406	Z-19	RC308LATR	Z-15	RCT221BZE	Z-25	RF6500BR	Z-23
RA12BKPK100	N-29	RC308TR	Z-15	RCT221CH	Z-25	RFSQ2FDK	Z-19
RA12GYPK100	N-29	RC308W	Z-15	RCT221NI	Z-25	RJ45PB50	Y-4
RA12IPK100	N-29	RC308WTR	Z-15	RCT221W	Z-25	RJ600	Z-27, Z-18
RA12LAPK100	N-29	RC309	Z-15	RCT600ALU	Q-6, Z-25	RJ620BKTR	Z-27, Z-18, Z-21
RA12PK100	N-29	RC309I	Z-15	RCT600BK	Q-6, Z-25	RJ620GYTR	Z-27, Z-18, Z-21
RA12WPK100	N-29	RC309W	Z-15	RCT600BR	Q-6, Z-25	RJ620ITR	Z-27, Z-18, Z-21
RA38BKPK100	N-29	RCD101BK	Z-4	RCT600BZE	Q-6, Z-25	RJ620LATR	Z-27, Z-18, Z-21
RA38GYPK100	N-29	RCD101GY	Z-4	RCT600CH	Q-6, Z-25	RJ620WTR	Z-27, Z-18, Z-21
RA38IPK100	N-29	RCD101I	Z-4	RCT600NI	Q-6, Z-25	RJ62BKTR	Z-27, Z-18, Z-21
RA38LAPK100	N-29	RCD101LA	Z-4	RCT600W	Q-6, Z-25	RJ62GYTR	Z-27, Z-18, Z-21
RA38PK100	N-29	RCD101W	Z-4	RCT620ALU	Q-6, Z-25	RJ62ITR	Z-27, Z-18, Z-21
RA38SSPK100	N-29	RCD103BK	Z-4	RCT620BK	Q-6, Z-25	RJ62LATR	Z-27, Z-18, Z-21
RA38WPK100	N-29	RCD103GY	Z-4	RCT620BR	Q-6, Z-25	RJ62WTR	Z-27, Z-18, Z-21
RA40	N-29	RCD103I	Z-4	RCT620BZE	Q-6, Z-25	RJ650BKTR	Z-27, Z-18, Z-22, Z-21
RA58SSPK100	N-29	RCD103LA	Z-4	RCT620CH	Q-6, Z-25	RJ650GYTR	Z-27, Z-18, Z-21
RA756	N-29	RCD103W	Z-4	RCT620NI	Q-6, Z-25	RJ650ITR	Z-27, Z-18, Z-21
RA756I	N-29	RCD108BK	Z-4	RCT620W	Q-6, Z-25	RJ650LATR	Z-27, Z-18, Z-21
RA756W	N-29	RCD108BKTR	Z-4	RDVFSQFI	Z-19	RJ650WTR	Z-27, Z-18, Z-21
RA88IPK100	N-29	RCD108GY	Z-4	RDVFSQFLA	Z-19	RJ65BKTR	Z-27, Z-18, Z-21
RA88SSPK100	N-29	RCD108GYTR	Z-4	RDVFSQFW	Z-19	RJ65GYTR	Z-27, Z-18, Z-21
RA88WPK100	N-29	RCD108I	Z-4	RF151DTR	Z-23	RJ65ITR	Z-27, Z-18, Z-21
RAFB4ALU	O-50	RCD108ITR	Z-4	RF151R	Z-23	RJ65LATR	Z-27, Z-18, Z-21
RAFB4BASE	O-46, O-50	RCD108LA	Z-4	RF151TR	Z-23	RJ65WTR	Z-27, Z-18, Z-21
RAFB4BLK	O-50	RCD108LATR	Z-4	RF201R	Z-23	RL100	BB-6
RAFB4BRS	O-50	RCD108W	Z-4	RF3004PA001	I-8, F-13	RL101	BB-6
RAFB4BRZ	O-50	RCD108WTR	Z-4	RF400	Z-21	RL102	BB-6
RAFB4GRY	O-50	RCD109I	Z-4	RF406AL	Z-21	RL105	BB-6
RAFB4NKL	O-50	RCD109LA	Z-4	RF406ALU	Z-21	RL106	BB-6
RAFB4SP2AAP	O-50	RCD109W	Z-4	RF406BK	Z-21	RL120	BB-9
RAFB4SP3MAAP	O-50	RCD111I	Z-4	RF406BN	Z-21	RL121	BB-9
RAFB4SP3UIS	O-50	RCD111LA	Z-4	RF406BP	Z-21	RL122	BB-9
RAFB4SPBLANK	O-50	RCD111W	Z-4	RF406BR	Z-21	RL124	BB-9
RAFB4SPDECO	O-50	RCD303BK	Z-4	RF406GY	Z-21	RL124H	BB-9
RAFB4SPDUPLX	O-50	RCD303I	Z-4	RF407AL	Z-21	RL125	BB-9
RAFB4SPORT	O-50	RCD303LA	Z-4	RF407BK	Z-21	RL150	BB-9
RAFB4SPTL14	O-50	RCD303W	Z-4	RF407BR	Z-21	RL152	BB-8
RAFB4SPTL16	O-50	RCD308BKTR	Z-4	RF408	Z-21	RL153	BB-8
RAYFSQFI	Z-19	RCD308GYTR	Z-4	RF409BR	Z-21	RL154	BB-9
RAYFSQFLA	Z-19	RCD308ITR	Z-4	RF500	Z-22	RL156	BB-8
RAYFSQFW	Z-19	RCD308LATR	Z-4	RF506AL	Z-22	RL157	BB-8
RC101	Z-15	RCD308WTR	Z-4	RF506BK	Z-22	RL158	BB-8
RC101I	Z-15	RCD309I	Z-4	RF506BN	Z-22	RL159	BB-8
RC101LA	Z-15	RCD309LA	Z-4	RF506BP	Z-22	RL160	BB-8
RC101W	Z-15	RCD309W	Z-4	RF506BR	Z-22	RL161	BB-8
RC103	Z-15	RCT200ALU	Z-25	RF506CH	Z-22	RL162	BB-8
RC103I	Z-15	RCT200BK	Z-25	RF506CU	Z-22	RL163	BB-8
RC103LA	Z-15	RCT200BR	Z-25	RF506NI	Z-22	RL164	BB-8
RC103W	Z-15	RCT200BZE	Z-25	RF506SS	Z-22	RL200	BB-9
RC108	Z-15	RCT200CH	Z-25	RF507AL	Z-22	RL201	BB-9
RC108I	Z-15	RCT200NI	Z-25	RF507BK	Z-22	RL202	BB-9
RC108ITR	Z-15	RCT200W	Z-25	RF507BN	Z-22	RL305	BB-7
RC108LA	Z-15	RCT201ALU	Z-25	RF507BP	Z-22	RL306	BB-7
RC108LATR	Z-15	RCT201BR	Z-25	RF507BR	Z-22	RL307	BB-7
RC108TR	Z-15	RCT201BZE	Z-25	RF507CH	Z-22	RL308	BB-7
RC108W	Z-15	RCT201CH	Z-25	RF507CU	Z-22	RL310	BB-7
RC108WTR	Z-15	RCT201NI	Z-25	RF507NI	Z-22	RL311	BB-7
RC109	Z-15	RCT201W	Z-25	RF507SS	Z-22	RL320	BB-7
RC109I	Z-15	RCT220ALU	Z-25	RF509BR	Z-22	RL325	BB-7
RC109LA	Z-15	RCT220BK	Z-25	RF515AL	Z-22	RL325B	BB-7
RC109W	Z-15	RCT220BR	Z-25	RF515BK	Z-22	RL356	BB-7
RC303	Z-15	RCT220BZE	Z-25	RF515BN	Z-22	RL357	BB-7
RC303I	Z-15	RCT220CH	Z-25	RF515BP	Z-22	RL3742	BB-8
RC303LA	Z-15	RCT220NI	Z-25	RF515BR	Z-22	RL413HSI	BB-7
RC303W	Z-15	RCT220W	Z-25	RF515CH	Z-22	RL413HSM	BB-7
RC308	Z-15	RCT221ALU	Z-25	RF515CU	Z-22	RL4221	BB-8

Catalog Number Index

Catalog Number	Page	Catalog Number	Page	Catalog Number	Page	Catalog Number	Page
RL426G24	BB-7	RR155LAWR	Z-17	RR430F	Z-17	RS315ILC	Z-14
RL42G11C	BB-7	RR155W	Z-17	RR430FW	Z-17	RS315ILI	Z-14
RL42G11H9	BB-7	RR155WR	Z-17	RR430PM	Z-17	RS315ILLA	Z-14
RL42G11HSM	BB-7	RR155WWR	Z-17	RR430WIPCN	Z-17	RS315ILW	Z-14
RL479HSM	BB-7	RR15BK	Z-16	RR435P	Z-17	RS315LA	Z-14
RL5221	BB-8	RR15I	Z-16	RR450	Z-17	RS315W	Z-14
RL8504	BB-6	RR15LA	Z-16	RR450F	Z-17	RS415	Z-14
RL8506	BB-6	RR15QITR	Z-16	RR450FW	Z-17	RS415I	Z-14
RL8512	BB-6	RR15QLATR	Z-16	RR450PM	Z-17	RS415LA	Z-14
RL8516	BB-6	RR15QW	Z-16	RRD15	Z-5	RS415W	Z-14
RL8804	BB-6	RR15QWTR	Z-16	RRD151BKTR	Z-5	RSD115	Z-3
RL8806	BB-6	RR15SBKTR	Z-16	RRD151GYTR	Z-5	RSD115BK	Z-3
RL8812	BB-6	RR15SBKWRTR	Z-16	RRD151ITR	Z-5	RSD115GY	Z-3
RL8816	BB-6	RR15SGYWRTR	Z-16	RRD151LATR	Z-5	RSD115I	Z-3
RL8822	BB-6	RR15SITR	Z-16	RRD151TR	Z-5	RSD115ILI	Z-3
RM3004PA001	I-8, F-13	RR15SITRX	Z-16	RRD151W	Z-5	RSD115ILLA	Z-3
ROCMGS	M-8	RR15SIWRTR	Z-16	RRD151WTR	Z-5	RSD115ILW	Z-3
RP101BK	BB-10	RR15SLATR	Z-16	RRD155	Z-5	RSD115IM	Z-3
RP101W	BB-10	RR15SLATRFX	Z-16	RRD155BK	Z-5	RSD115LA	Z-3
RP102BK	BB-10	RR15SLAWRTR	Z-16	RRD155GY	Z-5	RSD115LAM	Z-3
RP102W	BB-10	RR15STR	Z-16	RRD155I	Z-5	RSD115PLI	Z-3
RP123I	BB-10	RR15SWRTR	Z-16	RRD155LA	Z-5	RSD115PLLA	Z-3
RP123W	BB-10	RR15SWTR	Z-16	RRD155W	Z-5	RSD115PLW	Z-3
RP646	BB-10	RR15SWTRX	Z-16	RRD15BK	Z-5	RSD115W	Z-28, Z-3
RP648	BB-10	RR15SWWRTR	Z-16	RRD15GY	Z-5	RSD115WM	Z-3
RP649	BB-10	RR15W	Z-16	RRD15I	Z-5	RSD120WPGY	D-16, Z-3
RPL30P	AA-12, AA-9	RR201	Z-17	RRD15LA	Z-5	RSD120WPLA	D-16, Z-3
RR15	Z-16	RR201BK	Z-17	RRD15SBKTR	Z-5	RSD120WPW	D-16, Z-3
RR1500	Z-9	RR201BKTR	Z-17	RRD15SBKWRTR	Z-5	RSD215	Z-3
RR151	Z-17	RR201BKWRTR	Z-17	RRD15SGYTR	Z-5	RSD215BK	Z-3
RR1510I	Z-9, Z-18	RR201CHBSTR	Z-18	RRD15SGYWRTR	Z-5	RSD215GY	Z-3
RR1510LA	Z-9, Z-18	RR201CHITR	Z-18	RRD15SITR	Z-5	RSD215I	Z-3
RR1510W	Z-9, Z-18	RR201CHSSTR	Z-18	RRD15SIWRTR	Z-5	RSD215LA	Z-3
RR1512I	Z-9	RR201CHWTR	Z-18	RRD15SLATR	Z-5	RSD215W	Z-3
RR1512LA	Z-9	RR201GY	Z-17	RRD15SLAWRTR	Z-5	RSD315	Z-3
RR1512W	Z-9	RR201GYTR	Z-17	RRD15STR	Z-5	RSD315BK	Z-3
RR1514I	Z-9	RR201GYWRTR	Z-17	RRD15SW	Z-5	RSD315GY	Z-3
RR1514LA	Z-9	RR201I	Z-17	RRD15SWRTR	Z-5	RSD315I	Z-3
RR1514W	Z-9	RR201ITR	Z-17	RRD15SWTR	Z-5	RSD315ILI	Z-3
RR151BK	Z-17	RR201IWRTR	Z-17	RRD15SWWRTR	Z-5	RSD315ILLA	Z-3
RR151BKTR	Z-17	RR201LA	Z-17	RRD15W	Z-5	RSD315ILW	Z-3
RR151BKWRTR	Z-17	RR201LATR	Z-17	RRD201BKTR	Z-5	RSD315LA	Z-3
RR151CHBSTR	Z-18	RR201LAWRTR	Z-17	RRD201GYTR	Z-5	RSD315W	Z-3
RR151CHITR	Z-18	RR201TR	Z-17	RRD201ITR	Z-5	RSD415	Z-3
RR151CHSSTR	Z-18	RR201W	Z-17	RRD201LATR	Z-5	RSD415BK	Z-3
RR151CHWTR	Z-18	RR201WRTR	Z-17	RRD201TR	Z-5	RSD415GY	Z-3
RR151GY	Z-17	RR201WTR	Z-17	RRD201WTR	Z-5	RSD415I	Z-3
RR151GYTR	Z-17	RR201WWRTR	Z-17	RRD205	Z-5	RSD415LA	Z-3
RR151GYWRTR	Z-17	RR205	Z-17	RRD205BK	Z-5	RSD415W	Z-3
RR151I	Z-17	RR205BK	Z-17	RRD205GY	Z-5	RSFSQFI	Z-19
RR151ITR	Z-17	RR205BKWR	Z-17	RRD205I	Z-5	RSFSQFLA	Z-19
RR151WRTR	Z-17	RR205GY	Z-17	RRD205LA	Z-5	RSFSQFW	Z-19
RR151LA	Z-17	RR205GYWR	Z-17	RRD205W	Z-5	RSKI	Z-19
RR151LATR	Z-17	RR205I	Z-17	RS100W	Z-18	RSKLA	Z-19
RR151LAWRTR	Z-17	RR205IWR	Z-17	RS101I	Z-18	RSKW	Z-19
RR151TR	Z-17	RR205LA	Z-17	RS101W	Z-18	RT100W	BB-10
RR151W	Z-17	RR205LAWR	Z-17	RS115	Z-14	RT200	BB-10
RR151WRTR	Z-17	RR205W	Z-17	RS115BK	Z-14	RT300I	BB-10
RR151WTR	Z-17	RR205WR	Z-17	RS115I	Z-14	RT300W	BB-10
RR151WWRTR	Z-17	RR205WWR	Z-17	RS115ILC	Z-14	RT303	BB-10
RR155	Z-17	RR330	Z-17	RS115ILI	Z-14	RT600I	BB-10
RR155BK	Z-17	RR330F	Z-17	RS115ILLA	Z-14	RT600W	BB-10
RR155BKWR	Z-17	RR335P	Z-17	RS115ILW	Z-14	RTPB10W	E-9
RR155GY	Z-17	RR350	Z-17, W-31	RS115LA	Z-14	RU100SS	Z-26
RR155GYWR	Z-17	RR350F	Z-17	RS115W	Z-14	RU100W	Z-26
RR155I	Z-17	RR374	BB-9	RS315	Z-14	RU170W	Z-26
RR155IWR	Z-17	RR374W	BB-9	RS315BK	Z-14	RU200SS	Z-26
RR155LA	Z-17	RR430	Z-17	RS315I	Z-14	RU200W	Z-26

Catalog Number Index

Catalog Number	Page	Catalog Number	Page	Catalog Number	Page	Catalog Number	Page
RU270W	Z-26	S1PT4X4FIT	O-23, P-28, P-30	S1R10FFCVRALU	P-7	S1R4PTBRS	P-21
RW15300BR	Z-5, Z-18, N-25	S1PT4X4FITJ	P-28	S1R10FFCVRBLK	P-7	S1R4PTBRZ	P-21
RW15300GY	Z-5, Z-18, N-25	S1PT4X4GY	P-27	S1R10FFCVRBRS	P-7	S1R4PTFFALU	P-24
RW15300W	Z-5, Z-18, N-25	S1PT4X4GYJ	P-27	S1R10FFCVRBRZ	P-7	S1R4PTFFALUJ	P-24
RW15400BR	Z-5, Z-18, N-25	S1PTAL	P-27	S1R10FFCVRGRY	P-7	S1R4PTFFBLK	P-24
RW15400GY	Z-5, Z-18, N-25	S1PTALJ	P-27	S1R10FFCVRNKL	P-7	S1R4PTFFBLKJ	P-24
RW15400W	Z-5, Z-18, N-25	S1PTAVFIT	O-23, P-28, P-30	S1R10FFFDIV	P-10	S1R4PTFFBRS	P-24
RW51020	N-28	S1PTAVFITJ	P-28	S1R10INTUMDIV	P-10	S1R4PTFFBRSJ	P-24
RW51040	N-28	S1PTBL	P-27	S1R10PBF050	P-8	S1R4PTFFBRZ	P-24
RW51320	N-28	S1PTBLJ	P-27	S1R10PBF075	P-8	S1R4PTFFBRZJ	P-24
RW51330	N-28	S1PTBRS	P-27	S1R10PBF100	P-8	S1R4PTFFGRY	P-24
RW51380	N-28	S1PTBRSJ	P-27	S1R10PBF125	P-8	S1R4PTFFGRYJ	P-24
RW51450	N-28	S1PTFFAL	P-27	S1R10PBFBLANK	P-8	S1R4PTFFNKL	P-24
RW51470	N-28	S1PTFFALJ	P-27	S1R10PBFPT	P-8	S1R4PTFFNKLJ	P-24
RW51520	N-28	S1PTFFBL	P-27	S1R10PERIMDIV	P-10	S1R4PTFIT	P-21
RW51550	N-28	S1PTFFBLJ	P-27	S1R10PPT	P-11, P-10	S1R4PTFITCHI	P-21
RW51810	N-28	S1PTFFBRS	P-27	S1R10PSPA	P-8	S1R4PTGRY	P-21
RW5420CG	N-26	S1PTFFBRSJ	P-27	S1R10PSPB	P-8	S1R4PTTNKL	P-21
RW5420CW	N-26	S1PTFFGY	P-27	S1R10PSPC	P-8	S1R4PTQUAD	P-21
RW5420CZ	N-26	S1PTFFGYJ	P-27	S1R10PSPD	P-8	S1R4PTQUADALU	P-21
RW57300	AA-47, N-25	S1PTFIT	O-23, P-28, P-30	S1R10PSPF	P-8	S1R4PTQUADBLK	P-21
RW57350	AA-47, N-25	S1PTFITJ	P-28	S1R10PSPG	P-8	S1R4PTQUADBRS	P-21
RW57750	AA-47, N-25	S1PTGY	P-27	S1R10PSPH	P-8	S1R4PTQUADBRSJ	P-21
RW58300	AA-47, N-25	S1PTGYJ	P-27	S1R10PSPJ	P-8	S1R4PTQUADGRY	P-21
RW58350	AA-47, N-25	S1R10ADMTBK	P-10	S1R10PSPK	P-8	S1R4PTQUADNKL	P-21
RW58750	AA-47, N-25	S1R10CBF050	P-8	S1R10PSPQ	P-8	S1R4SP2X2DUPLEX	O-53, O-17, P-22
S1AP4BL	O-21, P-28	S1R10CBF075	P-8	S1R10PSPR	P-8, P-10	S1R4SP2X2DUPLX	O-53, O-17, P-22
S1AP4GY	O-21, P-28	S1R10CBF100	P-8	S1R10PSPS	P-8	S1R4SP2X2DUPLXTJ	O-53, O-17, P-22
S1AVHUB15	O-21	S1R10CBF125	P-8	S1R10PSPV	P-8	S1R4SP2X2STYLEO-53, O-17, P-22	
S1CFB	O-23, O-21, P-30	S1R10CBF150	P-8	S1R10PSPZ	P-8	S1R4SP2X2STYLETJ	O-53, O-17, P-22
S1CFCAL	O-21, P-28	S1R10CBF200	P-8	S1R10PSPZ25	P-8	S1R4SPDUPLX	O-53, O-17, P-22
S1CFCBL	O-21, P-28	S1R10CBF250	P-8	S1R10PSPZ5C	P-8	S1R4SPQUAD	O-53, O-17, P-22
S1CFCBRS	O-21, P-28	S1R10CBFBLANK	P-8	S1R10PSPZC	P-8	S1R4SPSIMPLEX	O-53, O-17, P-22
S1CFCGY	O-21, P-28	S1R10CBFPT	P-8	S1R10PSPZTR	P-8	S1R4SPSTYLE	O-53, O-17, P-22
S1CFCI	O-21, P-28	S1R10CENTERDIV	P-10	S1R10PTALU	P-7	S1R4SPSTWIST	O-53, O-17, P-22
S1DFMAX	P-29, O-22	S1R10CSP2B	P-9	S1R10PTBLK	P-7	S1R6ADMTBK	P-18
S1DFTRAC	P-29, O-22	S1R10CSP2H	P-9	S1R10PTBRS	P-7	S1R6CVRALU	P-18
S1DIV1	O-21	S1R10CSP2X	P-9	S1R10PTBRZ	P-7	S1R6CVRBLK	P-18
S1FBCLIP5PK	O-21	S1R10CSPB	P-9	S1R10PTFIT	P-7	S1R6CVRBRS	P-18
S1FP15AL	P-29, O-22	S1R10CSPC	P-9	S1R10PTGRY	P-7	S1R6CVRBRZ	P-18
S1FP15BL	P-29, O-22	S1R10CSPD	P-9	S1R10PTNKL	P-7	S1R6CVRGRY	P-18
S1FP15BRS	P-29, O-22	S1R10CSPF	P-9	S1R10PTZALU	P-7	S1R6CVRNKL	P-18
S1FP15GY	P-29, O-22	S1R10CSPG	P-9	S1R10PTZBLK	P-7	S1R6DIV	P-18
S1FP34AL	P-29, O-22	S1R10CSPH	P-9	S1R10PTZBRS	P-7	S1R6FFCVRALU	P-18
S1FP34BL	P-29, O-22	S1R10CSPJ	P-9	S1R10PTZBRZ	P-7	S1R6FFCVRBRS	P-18
S1FP34BRS	P-29, O-22	S1R10CSPK	P-9	S1R10PTZGRY	P-7	S1R6FFCVRGRY	P-18
S1FP34GY	P-29, O-22	S1R10CSPJ	P-9	S1R10PTZTNKL	P-7	S1R6FFCVRNKL	P-18
S1FRP4BL	P-28	S1R10CSPM	P-9	S1R10TUNNEL	P-10	S1R6PPT	P-11, P-18
S1FRP4GY	P-28	S1R10CSPN	P-9	S1R4CFBADMTBK	O-17	S1R6PTACEHALU	P-17
S1FRPTJB	P-14, P-28, P-10, P-18	S1R10CSPQ	P-9	S1R4CVRALU	P-21	S1R6PTACEHBLK	P-17
S1FRPTJB2	P-18	S1R10CSPR	P-9	S1R4CVRBLK	P-21	S1R6PTACEHBRZ	P-17
S1PFB	O-23, O-21, P-30	S1R10CSPS	P-9	S1R4CVRBRS	P-21	S1R6PTACEHGRY	P-17
S1PT3IMAL	P-27	S1R10CSPV	P-9	S1R4CVRBRZ	P-21	S1R6PTACEHNKL	P-17
S1PT3IMALJ	P-27	S1R10CSPW	P-9	S1R4CVRGRY	P-21	S1R6PTALU	P-17
S1PT3IMBL	P-27	S1R10CSPX	P-9	S1R4CVRNKL	P-21	S1R6PTBLK	P-17
S1PT3IMBLJ	P-27	S1R10CVRALU	P-7	S1R4DIV	P-22	S1R6PTBRS	P-17
S1PT3IMBRS	P-27	S1R10CVRBLK	P-7	S1R4FFADMTBK	P-24	S1R6PTBRZ	P-17
S1PT3IMBRSJ	P-27	S1R10CVRBRS	P-7	S1R4FFCVRALU	P-24, O-17	S1R6PTDEHALU	P-17
S1PT3IMGY	P-27	S1R10CVRBRUSH	P-10	S1R4FFCVRBLK	P-24, O-17	S1R6PTDEHBLK	P-17
S1PT3IMGYJ	P-27	S1R10CVRBRZ	P-7	S1R4FFCVRBRS	P-24, O-17	S1R6PTDEHBRZ	P-17
S1PT4X4AL	P-27	S1R10CVRGRY	P-7	S1R4FFCVRGRY	P-24, O-17	S1R6PTDEHGRY	P-17
S1PT4X4ALJ	P-27	S1R10CVRNKL	P-7	S1R4FFCVRNKL	P-24, O-17	S1R6PTDEHNKL	P-17
S1PT4X4BL	P-27	S1R10CVRTRALU	P-7	S1R4FRPTADMTBK	P-22	S1R6PTDEHGRY	P-17
S1PT4X4BLJ	P-27	S1R10CVRTRBLK	P-7	S1R4PPT	P-24, P-11, P-28, P-22	S1R6PTDEHBLK	P-17
S1PT4X4BRS	P-27	S1R10CVRTRBRS	P-7	S1R4PTALU	P-21	S1R6PTDEHBRZ	P-17
S1PT4X4BRS3	P-27	S1R10CVRTRBRZ	P-7	S1R4PTAVFIT	P-24	S1R6PTDEHGRY	P-17
S1PT4X4BRS3J	P-27	S1R10CVRTRGRY	P-7	S1R4PTAVFITJ	P-24	S1R6PTDEHNKL	P-17
S1PT4X4BRSJ	P-27	S1R10CVRTRNKL	P-7	S1R4PTBLK	P-21		

Catalog Number Index

Catalog Number	Page	Catalog Number	Page	Catalog Number	Page	Catalog Number	Page
S1R6PTFFALU	P-17	S1R8CVRNKL	P-14	S1R8PTZZ1GRY	P-13	S1SPFFTAL	P-29, O-22
S1R6PTFFBLK	P-17	S1R8DIV	P-14	S1R8PTZZ1NKL	P-13	S1SPFFTBL	P-29, O-22
S1R6PTFFBRS	P-17	S1R8FFCVRALU	P-14	S1R8PTZZ2ALU	P-13	S1SPFFTBRS	P-29, O-22
S1R6PTFFBRZ	P-17	S1R8FFCVRBLK	P-14	S1R8PTZZ2BLK	P-13	S1SPFFTGY	P-29, O-22
S1R6PTFFGRY	P-17	S1R8FFCVRBRS	P-14	S1R8PTZZ2BRS	P-13	S1SPMAX	O-23, P-29, P-30, O-22
S1R6PTFFNKL	P-17	S1R8FFCVRBRZ	P-14	S1R8PTZZ2BRZ	P-13	S1SPMAXC	O-23, P-29, P-30, O-22
S1R6PTFIT	P-18	S1R8FFCVRGRY	P-14	S1R8PTZZ2GRY	P-13	S1SPORT	O-23, P-29, P-30, O-22
S1R6PTFITCHI	P-18	S1R8FFCVRNKL	P-14	S1R8PTZZ2NKL	P-13	S1SPORTC	O-23, P-29, P-30, O-22
S1R6PTGRY	P-17	S1R8JNC1	P-14	S1R8PTZZ3ALU	P-13	S1SPSL2IM	O-23, P-29, P-30, O-22
S1R6PTNKL	P-17	S1R8JNC10	P-14	S1R8PTZZ3BLK	P-13	S1SPTL	O-23, P-29, P-30
S1R6PTWZALU	P-17	S1R8JNC11	P-14	S1R8PTZZ3BRS	P-13	S1SPTRAC	O-23, P-29, P-30, O-22
S1R6PTWZBLK	P-17	S1R8JNC12	P-14	S1R8PTZZ3BRZ	P-13	S1SPTRACCO	O-23, P-29, P-30, O-22
S1R6PTWZBRS	P-17	S1R8JNC13	P-14	S1R8PTZZ3GRY	P-13	S1TFCAL	O-21, P-28
S1R6PTWZBRZ	P-17	S1R8JNC2	P-14	S1R8PTZZ3NKL	P-13	S1TFCBL	O-21, P-28
S1R6PTWZGRY	P-17	S1R8JNC3	P-14	S1RFFFIT2	P-18	S1TFCBRS	O-21, P-28
S1R6PTWZNKL	P-17	S1R8JNC4	P-14	S1RPLUG075ALU	P-18	S1TFCGY	O-21, P-28
S1R6SP3RTR	P-19	S1R8JNC5	P-14	S1RPLUG075BLK	P-18	S1TFCI	O-21, P-28
S1R6SP6DJ	P-19	S1R8JNC6	P-14	S1RPLUG075BRS	P-18	S2425	O-27, O-28, O-32, T-16, O-30
S1R6SPA	P-19	S1R8JNC7	P-14	S1RPLUG075BRZ	P-18	S2525	O-32, O-24, O-25
S1R6SPB	P-19	S1R8JNC8	P-14	S1RPLUG075NKL	P-18	S2625	O-27, O-28, O-32, T-16, O-30
S1R6SPC	P-19	S1R8JNC9	P-14	S1RPLUG100ALU	P-14	S2725	O-32, O-24, O-25
S1R6SPD	P-19	S1R8PPT	P-14, P-11	S1RPLUG100BLK	P-14	S2825	O-27, O-33, O-28, O-32, T-16, O-30
S1R6SPE	P-19	S1R8PSPU	P-15	S1RPLUG100BRS	P-14	S2925	O-32, O-24, O-25
S1R6SPEXT	P-18	S1R8PSPV	P-15	S1RPLUG100BRZ	P-14	S3061	O-34
S1R6SPF	P-19	S1R8PSPW	P-15	S1RPLUG100GRY	P-14	S3079	O-35
S1R6SPG	P-19	S1R8PSPX	P-15	S1RPLUG100NKL	P-14	S3082	O-32, O-24, O-25
S1R6SPH	P-19	S1R8PSPY	P-15	S1RPLUG2ALU	P-18	S3083	O-35
S1R6SPH25	P-19	S1R8PSPZ	P-15	S1RPLUG2BLK	P-18	S3084	O-35
S1R6SPHC2	P-19	S1R8PSPZ25	P-15	S1RPLUG2BRS	P-18	S3085	O-35
S1R6SPHC4	P-19	S1R8PSPZC	P-15	S1RPLUG2BRZ	P-18	S3182	O-32, O-25
S1R6SPI	P-19	S1R8PSPZTR	P-15	S1RPLUG2NKL	P-18	S3325	O-32, O-33, O-24, O-25
S1R6SPJ	P-19	S1R8PT1ALU	P-13	S1RTR10BIT	P-10	S3425	O-27, O-33, O-28, T-16, O-30
S1R6SPK	P-19	S1R8PT1BLK	P-13	S1SFB	O-23, O-21, P-30	S3525	O-32, O-33, O-24, O-25
S1R6SPL	P-19	S1R8PT1BRS	P-13	S1SFBV	O-23, O-21, P-30	S3625	O-27, O-28, O-32, T-16, O-30
S1R6SPM	P-19	S1R8PT1BRZ	P-13	S1SFBVCR	O-23, O-21, P-30	S3625TR	O-30, O-28, O-32, O-27
S1R6SPN	P-19	S1R8PT1GRY	P-13	S1SFCR	O-23, O-21, P-30	S3725	O-32, O-24, O-25
S1R6SPT	P-19	S1R8PT1NKL	P-13	S1SP	O-23, P-29, P-30, O-22	S3813	O-27, O-28, O-32, T-16, O-30
S1R6SPU	P-19	S1R8PT2ALU	P-13	S1SP3IM	O-23, P-29, P-30, O-22	S3825	O-27, O-28, O-32, T-16, O-30
S1R6SPV	P-19	S1R8PT2BLK	P-13	S1SP3IMC	P-29, O-22	S3826	O-27, O-28, O-32, T-16, O-30
S1R6SPW	P-19	S1R8PT2BRS	P-13	S1SP4IM	O-23, P-29, P-30, O-22	S3913	O-24, O-25
S1R6SPX	P-19	S1R8PT2BRZ	P-13	S1SP4X4	O-23, P-29, P-30, O-22	S3925	O-32, O-24, O-25
S1R6SPY	P-19	S1R8PT2GRY	P-13	S1SP4X415	P-29, O-22	S5002	O-35
S1R6SPZ	P-19	S1R8PT2NKL	P-13	S1SP4X430	P-29, O-22	S5003	O-35
S1R6SPZ25	P-19	S1R8PT3ALU	P-13	S1SP4X4C	O-23, P-29, P-30, O-22	S5007	O-35
S1R6SPZC	P-19	S1R8PT3BLK	P-13	S1SP4X4PA	O-23, P-29, P-30, O-22	S5010	O-35
S1R8ADMTBK	P-14	S1R8PT3BRS	P-13	S1SP4X4PAC	O-23, P-29, P-30, O-22	S5012	O-35
S1R8CSP4DJ	P-15	S1R8PT3BRZ	P-13	S1SP4X4SYS	O-23, P-29, P-30, O-22	S5013	O-35
S1R8CSP6DJ	P-15	S1R8PT3GRY	P-13	S1SP4X4SYSC	O-23, P-29, P-30, O-22	S5016	O-24, O-25
S1R8CSPA	P-15	S1R8PT3NKL	P-13	S1SPAMM200	O-23, P-29, P-30, O-22	S5016PG	O-35
S1R8CSPB	P-15	S1R8PTFFALU	P-13	S1SPAMM20C	O-23, P-29, P-30, O-22	S5017GR	O-30, O-28, O-27
S1R8CSPC	P-15	S1R8PTFFBLK	P-13	S1SPAMM20C	O-23, P-29, P-30, O-22	S5020	O-35
S1R8CSPD	P-15	S1R8PTFFBRS	P-13	S1SPAMM20C	O-23, P-29, P-30, O-22	S5025	O-35
S1R8CSPE	P-15	S1R8PTFFBRZ	P-13	S1SPAMM20C	O-23, P-29, P-30, O-22	S5030	O-35
S1R8CSPEXT	P-15	S1R8PTFFCOMPKIT	P-14	S1SPDU	O-23, P-29, P-30, O-22	SA1	D-19, N-6
S1R8CSPEXT3	P-15	S1R8PTFFGRY	P-13	S1SPDU2IM	O-23, P-29, P-30, O-22	SA13A	N-9
S1R8CSPEXT32	P-15	S1R8PTFFNKL	P-13	S1SPDUSL	O-23, P-29, P-30, O-22	SA2	D-19, N-6
S1R8CSPG	P-15	S1R8PTFIT	P-14	S1SPEXT1	O-23, P-29, P-30, O-22	SA23	N-9
S1R8CSPI	P-15	S1R8PTFIT1	P-14	S1SPEXT1C	O-23, P-29, P-30, O-22	SA2425	O-27, O-33, O-28, O-32, T-16, O-30
S1R8CSPJ	P-15	S1R8PTFIT13	P-14	S1SPEXT2	O-23, P-29, P-30, O-22	SA2525	O-32, O-33, O-24, O-25
S1R8CSPK	P-15	S1R8PTFIT1CHI	P-14	S1SPEXT2C	O-23, P-29, P-30, O-22	SA2625	O-27, O-33, O-28, O-32, T-16, O-30
S1R8CSPM	P-15	S1R8PTFIT2	P-14	S1SPEXT3	O-23, P-29, P-30, O-22	SA2725	O-32, O-33, O-24, O-25
S1R8CSPN	P-15	S1R8PTFIT2CHI	P-14	S1SPEXT4	O-23, P-29, P-30, O-22	SA2925	O-32, O-33, O-24, O-25
S1R8CVRALU	P-14	S1R8PTFIT3	P-14	S1SPEXT4C	O-23, P-29, P-30, O-22	SA3082	O-32, O-24, O-25
S1R8CVRBLK	P-14	S1R8PTFIT3CHI	P-14	S1SPFFAL	P-29, O-22	SA3083	O-35
S1R8CVRBRS	P-14	S1R8PTZZ1ALU	P-13	S1SPFFBL	P-29, O-22	SA3083W	O-30, O-28, O-32, O-27
S1R8CVRBRZ	P-14	S1R8PTZZ1BLK	P-13	S1SPFFBRS	P-29, O-22		
S1R8CVRGRY	P-14	S1R8PTZZ1BRS	P-13	S1SPFFGY	P-29, O-22		
		S1R8PTZZ1BRZ	P-13				

Catalog Number Index

Catalog Number	Page	Catalog Number	Page	Catalog Number	Page	Catalog Number	Page
SA3083WB	O-30, O-28, O-27	SB3084WB	O-30, O-28, O-27	SECM12G	W-73	SFBE10	Y-6, S-46
SA3084	O-35	SB3085	O-35	SECM16B	W-73	SFBEI	Y-8
SA3084W	O-30, O-28, O-32, O-27	SB3085W	O-30, O-28, O-32, O-27	SECM16G	W-73	SFBG10	Y-6, S-46
SA3084WB	O-30, O-28, O-27	SB3085WB	O-30, O-28, O-27	SECM20B	W-73	SFBGBK	Y-8
SA3085	O-35	SB4	N-6	SECM20G	W-73	SFBGEI	Y-8
SA3085W	O-30, O-28, O-32, O-27	SB5	N-6	SECM25B	W-73	SFBGGY	Y-8
SA3085WB	O-30, O-28, O-27	SB6	N-6	SECM25G	W-73	SFBGLA	Y-8
SA3182	O-32, O-25	SB7	B-50, A-52, N-7, AA-45	SECM32B	W-73	SFBGOW	Y-8
SA3625	O-27, O-28, O-32, T-16, O-30	SB701	A-55	SECM32G	W-73	SFBGW	Y-8
SA3625TR	O-27, O-33, O-28, O-32, O-30	SB720	B-52, N-8	SECM40B	W-73	SFBGY	Y-8
SA3725	O-32, O-33, O-24, O-25	SB8	B-50, A-52, N-7, AA-45	SECM40G	W-73	SFBLA	Y-8
SA3813	O-27, O-28, O-32, T-16, O-30	SB82	N-7, AA-45	SECP11BA	W-73	SFBOW	Y-8
SA3825	O-27, O-33, O-28, O-32, T-16, O-30	SB826	Z-13, N-10	SECP11GA	W-73	SFBW	Y-8
SA3826	O-27, O-33, O-28, O-32, T-16, O-30	SBP1	N-6	SECP13BA	W-73	SFBW10	Y-6
SA3913	O-24, O-25	SBP126	Z-13	SECP13GA	W-73	SFC5EBK	Y-5
SA3925	O-32, O-33, O-24, O-25	SBP2	N-6	SECP16BA	W-73	SFC5EW	Y-5
SA5007	O-35	SBP26	M-13, Z-12, N-5	SECP16GA	W-73	SFC6BK	Y-5
SA5010	O-35	SBP262	Z-12, N-5	SECP21BA	W-73	SFC6W	Y-5
SA5012	O-35	SBP263	Z-12, N-5	SECP21GA	W-73	SFF3GBK	Y-6
SA5013	O-35	SBP3	D-19	SECP29BA	W-73	SFF3GEI	Y-6
SA5016	O-24, O-25	SBP7	N-7	SECP29GA	W-73	SFF3GGY	Y-6
SA5017GR	O-30, O-28, O-27	SBP8	N-7	SECP36BA	W-73	SFF3GOW	Y-6
SA5020	O-35	SBP82	N-7	SECP36GA	W-73	SFF3GW	Y-6
SA5025	O-35	SBSB1A	H-12	SECP7BA	W-73	SFFBX	Y-6
SA6685G	O-39	SBSB2	H-12	SECP7GA	W-73	SFFEX	Y-6, S-46
SA6686G	O-39	SBTL1A	H-12	SECP9BA	W-73	SFFGBK	Y-6, Z-10, AA-46
SA6687G	O-39	SBTL2	H-12	SECP9GA	W-73	SFFGEI	Y-6, S-46, Z-10, AA-46
SA6688G	O-39	SC10	Y-14	SEHBL3	B-68, B-64, B-39	SFFGGY	Y-6, S-46, Z-10, AA-46
SA7	B-50, A-52, N-7	SC3098A	O-39	SETL3	B-39	SFFGLA	Z-10
SA720	N-8	SC3099A	O-39	SF14SJBK	Y-8	SFFGOW	Y-6
SA723	A-54	SCB100	H-13	SF14SJEI	Y-8	SFFGW	Y-6, Z-10, AA-46
SA8	B-50, A-52, N-7	SCB50	H-13	SF14SJGY	Y-8	SFFGX	Y-6, S-46
SA82	N-7	SCBC	H-13	SF14SJOW	Y-8	SFFWX	Y-6
SAA12	G-29	SCH1	N-6	SF14SJW	Y-8	SFFX	Y-6, S-63
SAA34	G-29	SCH13	N-9	SF15ST	Y-6	SFGRFBK	Y-6, Z-10
SAB100	G-29, G-42	SCH18	N-10	SF2525	O-32, O-24, O-25	SFGRFEI	Y-6, Z-10
SAB12	B-68, G-29, G-42	SCH2	N-6	SF2725	O-32, O-24, O-25	SFGRFGY	Y-6, Z-10
SAB34	B-68, G-29, G-42	SCH23	N-9	SF2925	O-32, O-24, O-25	SFGRFLA	Z-10
SAC100	G-29, G-42	SCH26	M-13, Z-12, N-5	SF35110BK	Y-6	SFGRFOW	Y-6
SAC100NM	G-29	SCH262	Z-12, N-5	SF35FFBK	Y-8	SFGRFW	Y-6, Z-10
SAC12	G-29	SCH3	N-6	SF35FFEI	Y-8	SFHC14BK	Z-10, Y-5
SAC125	G-29, G-42	SCH7	N-7	SF35FFGY	Y-8	SFHC14W	Z-10, X-6, Y-5, X-7, Y-18
SAC12NM	G-29	SCH723	N-8	SF35FFOW	Y-8	SFRC110B	Y-6
SAC34	G-29	SCH8	N-7	SF35FFW	Y-8	SFRC110GN	Y-6
SAC34NM	G-29	SCH82	N-7	SF35GFFBK	Y-8	SFRC110R	Y-6, S-46, S-63
SAD125	G-29, G-42	SCSB0	H-12	SF35GFFEI	Y-8	SFRC110W	Y-6, S-46
SAD150	G-29, G-42	SCSB0M2	H-12	SF35GFFGY	Y-8	SFRC110Y	Y-6, S-46
SB1	D-19, AA-45, N-6	SCTL0	H-12	SF35GFFOW	Y-8	SFRCBBK	Y-7
SB126	AA-45, Z-13, N-10	SCTLOM2	H-12	SF35GFFW	Y-8	SFRCBEI	Y-7
SB13	AA-45, N-9	SDB1A	H-12	SF35SJ	Y-8	SFRCBFFBK	Z-10, Y-7
SB14	N-9	SE2720A	B-39	SF35SJBK	Y-8	SFRCBFFEI	Z-10, Y-7
SB18	AA-45, N-10	SE2730A	B-39	SF35SJEI	Y-8	SFRCBFFGY	Z-10, Y-7
SB2	D-19, AA-45, N-6	SEC100BA	W-73, C-11	SF35SJGY	Y-8	SFRCBFFLA	Z-10
SB23	N-9	SEC100BSMH9	W-73	SF35SJW	Y-8	SFRCBFFOW	Y-7
SB26	D-19, Z-12, A-52, N-5, AA-45, M-13	SEC100GA	W-73, C-11	SF35STBK	Y-8	SFRCBFFW	Z-10, Y-7
SB262	D-19, Z-12, AA-45, N-5	SEC125BSMH13	W-73	SF35STEI	Y-8	SFRCBGY	Y-7
SB3	N-6	SEC38BA	W-73	SF35STGY	Y-8	SFRCBKBK	Y-7
SB3083	O-35	SEC38GA	W-73	SF35STOW	Y-8	SFRCBKEI	Y-7
SB3083W	O-30, O-28, O-32, O-27	SEC50B252	W-73	SF35STW	Y-8	SFRCBKFF	Y-7
SB3083WB	O-30, O-28, O-27	SEC50B356	W-73	SF3925	O-32, O-24	SFRCBKFFBK	Y-7
SB3084	O-35	SEC50BA	W-73	SF39253A	O-24	SFRCBKFFEI	Y-7
SB3084W	O-30, O-28, O-32, O-27	SEC50GA	W-73	SF5ECOY	Y-5	SFRCBKFFGY	Y-7
		SEC75B352	W-73	SFA3925	O-32, O-24	SFRCBKFFW	Y-7
		SEC75B452	W-73	SFA3926	O-32, O-24, O-25	SFRCBKGY	Y-7
		SEC75BA	W-73	SFB10	Y-6, S-63	SFRCBKRBK	Y-7
		SEC75GA	W-73	SFB3926	O-32, O-24, O-25	SFRCBKREI	Y-7
		SEC75RGA	W-73	SFBB10	Y-6	SFRCBKRGY	Y-7
		SECM12B	W-73	SFBBK	Y-8	SFRCBKROW	Y-7

Catalog Number Index

Catalog Number	Page	Catalog Number	Page	Catalog Number	Page	Catalog Number	Page
SFRCBKRW	Y-7	SFRCWGY	Y-7	SHC1006CR	W-69	SHC1037CR	.W-69, I-8, F-13, C-12
SFRCBKW	Y-7	SFRCWRBK	Z-10, Y-7	SHC1007	W-69	SHC1037SS	W-69
SFRCBOW	Y-7	SFRCWREI	Z-10, Y-7	SHC1008	W-69	SHC1037ZP	W-69
SFRCBRBK	Z-10, Y-7	SFRCWRGY	Z-10, Y-7	SHC1008CR	W-69	SHC1038	W-69
SFRCBREI	Z-10, Y-7	SFRCWRLA	Z-10	SHC1008ZP	W-69	SHC1038CR	W-69
SFRCBRGY	Z-10, Y-7	SFRCWROW	Y-7	SHC1009	W-69	SHC1038SS	W-69
SFRCBRLA	Z-10	SFRCWRW	Z-10, Y-7	SHC1009CR	W-69	SHC1038ZP	W-69
SFRCBROW	Y-7	SFRCWW	Y-7	SHC1009SS	W-69	SHC1039	W-69
SFRCBRW	Z-10, Y-7	SFRCY	Y-7	SHC1010	W-69	SHC1039CR	W-69, C-11
SFRCBW	Y-7	SFRCYBK	Y-7	SHC1010CR	W-69	SHC1040	W-69
SFRCGNBK	Y-7	SFRCYEI	Y-7	SHC1010ZP	W-69	SHC1040CR	W-69, C-11
SFRCGNEI	Y-7	SFRCYFF	Y-7	SHC1011	W-69	SHC1041	W-69
SFRCGNFFBK	Z-10, Y-7	SFRCYFFBK	Z-10, Y-7	SHC1011CR	W-69	SHC1041CR	W-69, C-11
SFRCGNFFEI	Z-10, Y-7	SFRCYFFEI	S-46, Z-10, Y-7	SHC1011SS	W-69	SHC1041SS	W-69
SFRCGNFFGY	Z-10, Y-7	SFRCYFFGY	S-46, Z-10, Y-7	SHC1012	W-69	SHC1042	W-69
SFRCGNFFLA	Z-10	SFRCYFFLA	Z-10	SHC1012CR	W-69	SHC1042CR	W-69, C-11
SFRCGNFFOW	Y-7	SFRCYFFW	Z-10, Y-7	SHC1012SS	W-69	SHC1042SS	W-69
SFRCGNFFW	Z-10, Y-7	SFRCYGY	Y-7	SHC1012ZP	W-69	SHC1043	W-69
SFRCGNGY	Y-7	SFRCYRBK	Z-10, Y-7	SHC1015	W-69	SHC1043CR	W-69, C-11
SFRCGNOW	Y-7	SFRCYREI	Z-10, Y-7	SHC1016	W-69	SHC1043SS	W-69
SFRCGNRBK	Z-10, Y-7	SFRCYRGY	Z-10, Y-7	SHC1017	W-69	SHC1043ZP	W-69
SFRCGNREI	Z-10, Y-7	SFRCYRLA	Z-10	SHC1018	W-69	SHC1044	W-69
SFRCGNRGY	Z-10, Y-7	SFRCYROW	Y-7	SHC1019	W-69	SHC1044CR	W-69
SFRCGNRLA	Z-10	SFRCYRW	Z-10, Y-7	SHC1019CR	W-69	SHC1044SS	W-69
SFRCGNROW	Y-7	SFRCYW	Y-7	SHC1020	W-69	SHC1046	W-70
SFRCGNRW	Z-10, Y-7	SFRFGBK	Y-6	SHC1020CR	W-69	SHC1047	W-70
SFRCGNW	Y-7	SFRFGEI	Y-6	SHC1020SS	W-69	SHC1048	AA-31, W-70
SFRCORBK	Y-7	SFRFGGY	Y-6	SHC1020ZP	W-69	SHC1049	W-70
SFRCOREI	Y-7	SFRFGOW	Y-6	SHC1021	W-69	SHC1050	W-70
SFRCORFFBK	Y-7	SFRFGW	Y-6	SHC1021CR	W-69	SHC1051	W-70
SFRCORFFEI	Y-7	SFSBBK10	Y-6, Z-10	SHC1021SS	W-69	SHC1052	W-70
SFRCORFFGY	Y-7	SFSBEI10	Y-6, Z-10	SHC1021ZP	W-69	SHC1052ZP	W-70
SFRCORFFOW	Y-7	SFSBGY10	Y-6, Z-10	SHC1022	W-69	SHC1053	W-70
SFRCORFFW	Y-7	SFSBLA10	Y-6, Z-10	SHC1022CR	W-69	SHC1053ZP	W-70
SFRCORGY	Y-7	SFSBW10	Y-6, Z-10	SHC1022SS	W-69	SHC1054	W-70
SFRCOROW	Y-7	SFSC6	Y-5	SHC1022ZP	W-69	SHC1054ZP	W-70
SFRCORRBK	Y-7	SFSPGBK	S-46, Y-8	SHC1023	W-69	SHC1055	W-70
SFRCORREI	Y-7	SFSPGBKBK	Y-8	SHC1023CR	W-69	SHC1056	W-70
SFRCORRGY	Y-7	SFSPGBKKEI	Y-8	SHC1023SS	W-69	SHC1057	W-70
SFRCORROW	Y-7	SFSPGBKGY	Y-8	SHC1023ZP	W-69	SHC1057ZP	W-70
SFRCORRW	Y-7	SFSPGBKW	Y-8	SHC1024	W-69	SHC1058	W-70
SFRCORW	Y-7	SFSPGR	S-46, Y-8	SHC1024CR	W-69	SHC1058ZP	W-70
SFRCR	Y-7	SFSPGRBK	Y-8	SHC1024SS	W-69	SHC1059	AA-31, W-70
SFRCRBK	Y-7	SFSPGREI	Y-8	SHC1024ZP	W-69	SHC1059ZP	W-70
SFRCREI	Y-7	SFSPGRGY	Y-8	SHC1025	W-69	SHC1061	AA-31, W-70
SFRCRFF	Y-7	SFSPGRW	Y-8	SHC1026	W-69	SHC1062	W-70
SFRCRFFBK	Z-10, Y-7	SFSTSOW	S-63	SHC1027	W-69	SHC1063	W-70
SFRCRFFEI	S-46, Z-10, Y-7	SFSV110BK	Y-6, S-46, S-63	SHC1027ZP	W-69	SHC1064	W-70
SFRCRFFGY	S-46, Z-10, Y-7	SFSVBK	S-46	SHC1028	W-69	SHC1065	W-70
SFRCRFFLA	Z-10	SFUSBAA3BK	Y-5	SHC1028ZP	W-69	SHC1066	W-70
SFRCRFFW	Z-10, Y-7	SFUSBAAB	Y-5	SHC1029	W-69	SHC1067	W-70
SFRCRGY	Y-7	SFUSBAAOW	Y-5	SHC1030	W-69	SHC1068	W-70
SFRCRRBK	Z-10, Y-7	SFUSBAAW	Y-5	SHC1030ZP	W-69	SHC1069	W-70
SFRCRREI	Z-10, Y-7	SFUSBAB3BK	Y-5	SHC1031	W-69	SHC1070	W-70
SFRCRRGY	Z-10, Y-7	SFUSBABB	Y-5	SHC1031ZP	W-69	SHC1071	W-70
SFRCRRLA	Z-10	SFUSBABOW	Y-5	SHC1032	W-69	SHC1072	W-70
SFRCRRW	Y-7	SFUSBABW	Y-5, Y-18	SHC1032ZP	W-69	SHC1073	W-70
SFRCRRW	Z-10, Y-7	SHC1001CR	W-69	SHC1033	W-69	SHC1074	W-70
SFRCRW	Y-7	SHC1002	W-69	SHC1033ZP	W-69	SHC1076	W-70
SFRCW	Y-7	SHC1002CR	W-69	SHC1034	W-69	SHC1077	W-70
SFRCWBK	Y-7	SHC1003	W-69	SHC1034ZP	W-69	SHC1078	W-70
SFRCWEI	Y-7	SHC1003CR	W-69	SHC1035CR	W-69, C-12	SHC1079	W-70
SFRCWFF	Y-7	SHC1003SS	W-69	SHC1035SS	W-69	SHC1080	W-70
SFRCWFFBK	Z-10, Y-7	SHC1004	W-69	SHC1035ZP	W-69	SHC1081	W-70
SFRCWFFEI	S-46, Z-10, Y-7	SHC1004CR	W-69	SHC1036	W-69	SHC1086	W-70
SFRCWFFGY	S-46, Z-10, Y-7	SHC1004SS	W-69	SHC1036CR	W-69, C-12	SHC1088	W-70
SFRCWFFLA	Z-10	SHC1005	W-69	SHC1036SS	W-69	SHC1089	W-70
SFRCWFFW	Z-10, Y-7	SHC1005CR	W-69	SHC1037	W-69	SHC1090	W-70

Catalog Number Index

Catalog Number	Page	Catalog Number	Page	Catalog Number	Page	Catalog Number	Page
SHC1091	W-70	SNAP1221ILINA	D-8	SNAP2121ILBKNA	D-9	SNAP2152GYTRA	A-16
SHC1092	W-70	SNAP1221ILRNA	D-8	SNAP2121ILINA	D-9	SNAP2152IA	A-16
SHC1093	W-70	SNAP1221ILWNA	D-8, X-15	SNAP2121ILRNA	D-9	SNAP2152IGL	M-15, A-16
SHC1094	W-70	SNAP1221INA	D-8	SNAP2121ILWNA	D-9, X-15	SNAP2152IGLTRA	M-15, A-16
SHC1095	W-70	SNAP1221LANA	D-8	SNAP2121INA	D-9	SNAP2152IGTRA	M-15, A-16
SHC1097ZP	W-69	SNAP1221PLBKNA	D-8	SNAP2121LANA	D-9	SNAP2152IL	A-16
SHC1098ZP	W-69	SNAP1221PLINA	D-8	SNAP2121PLBKNA	D-9	SNAP2152ILTRA	A-16
SHC1099ZP	W-69	SNAP1221PLRNA	D-8	SNAP2121PLINA	D-9	SNAP2152INA	A-16
SHC2005CR	W-69	SNAP1221PLWNA	D-8, X-15	SNAP2121PLRNA	D-9	SNAP2152ISCTRA	A-16
SHC2008CR	W-69	SNAP1221RNA	D-8	SNAP2121PLWNA	D-9, X-15	SNAP2152ITRA	A-16
SHC2010CR	W-69	SNAP1221WNA	D-8, X-15	SNAP2121RNA	D-9	SNAP2152L	A-16
SHC2011CR	W-69	SNAP1223BKNA	D-8	SNAP2121WNA	D-9, X-15	SNAP2152LAA	A-16
SHC2012CR	W-69	SNAP1223BRNA	D-8	SNAP2123BKNA	D-9	SNAP2152LAL	A-16
SHC2021CR	W-69	SNAP1223GYNA	D-8	SNAP2123BRNA	D-9	SNAP2152LALTRA	A-16
SHC2022CR	W-69	SNAP1223ILBKNA	D-8	SNAP2123GYNA	D-9	SNAP2152LANA	A-16
SHC2023CR	W-69	SNAP1223ILINA	D-8	SNAP2123ILBKNA	D-9	SNAP2152LASCTRA	A-16
SHC2024CR	W-69	SNAP1223ILRNA	D-8	SNAP2123ILINA	D-9	SNAP2152LATRA	A-16
SHC2035CR	W-69	SNAP1223ILWNA	D-8, X-15	SNAP2123ILRNA	D-9	SNAP2152LTRA	A-16
SHC2036CR	W-69	SNAP1223INA	D-8	SNAP2123ILWNA	D-9, X-15	SNAP2152NA	A-16
SHC2037CR	W-69	SNAP1223LANA	D-8	SNAP2123INA	D-9	SNAP2152RA	A-16
SHC2038CR	W-69	SNAP1223RNA	D-8	SNAP2123LANA	D-9	SNAP2152RL	A-16
SHC2040CR	W-69, C-11	SNAP1223WNA	D-8, X-15	SNAP2123RNA	D-9	SNAP2152RLTRA	A-16
SHC2041CR	W-69, C-11	SNAP15UAC	Q-5	SNAP2123WNA	D-9, X-15	SNAP2152RNA	A-16
SHC2042CR	W-69, C-11	SNAP15UACBK	Q-5	SNAP2152A	A-16	SNAP2152RSCTRA	A-16
SHC2043CR	W-69, C-11	SNAP15UACGY	Q-5	SNAP2152BKA	A-16	SNAP2152RTRA	A-16
SHC2044CR	W-69	SNAP15UACI	Q-5	SNAP2152BKL	A-16	SNAP2152SCTRA	A-16
SHCM161011	W-72	SNAP15UACLA	Q-5, A-18	SNAP2152BKLTRA	A-16	SNAP2152TRA	A-16
SHCM201017	W-72	SNAP15UACW	Q-5, X-15	SNAP2152BKNA	A-16	SNAP2152WA	A-16
SHCM201022	W-72	SNAP1RA	L-14, A-14, L-5, M-15, A-23	SNAP2152BKSCCTRA	A-16	SNAP2152WL	X-14, A-16
SHCM201023	W-72			SNAP2152BKTRA	A-16	SNAP2152WLTRA	X-14, A-16
SHCM201024	W-72	SNAP1RAM2	L-5	SNAP2152BLL	A-16	SNAP2152WNA	X-14, A-16
SHCM251033	W-72	SNAP1RNA	Q-5, L-5, X-14	SNAP2152BLLTRA	A-16	SNAP2152WSCCTRA	X-14, A-16
SHCM251034	W-72	SNAP1RNAM2	L-5, X-14	SNAP2152BLSCTRA	A-16	SNAP2152WTRA	X-14, A-16
SHCM301037	W-72	SNAP20UAC	Q-5	SNAP2152BLTRA	A-16	SNAP2162A	A-16
SK2	B-53	SNAP20UACBK	Q-5	SNAP2152C1	A-23	SNAP2162BKA	A-16
SK3	B-53	SNAP20UACGY	Q-5	SNAP2152C1BK	A-23	SNAP2162BKL	A-16
SLK	H-13	SNAP20UACI	Q-5	SNAP2152C1BL	A-23	SNAP2162BKLTRA	A-16
SLKG	H-13	SNAP20UACLA	Q-5	SNAP2152C1GN	A-23	SNAP2162BKNA	A-16
SNAP1201BKNA	D-8	SNAP20UACW	Q-5, X-15	SNAP2152C1GY	A-23	SNAP2162BKSCCTRA	A-16
SNAP1201BRNA	D-8	SNAP2101BKNA	D-9	SNAP2152C1I	A-23	SNAP2162BKTRA	A-16
SNAP1201GYNA	D-8	SNAP2101BRNA	D-9	SNAP2152C1ITRA	A-23	SNAP2162BLL	A-16
SNAP1201ILBKNA	D-8	SNAP2101GYNA	D-9	SNAP2152C1LA	A-23	SNAP2162BLTRA	A-16
SNAP1201ILINA	D-8	SNAP2101ILBKNA	D-9	SNAP2152C1LATRA	A-23	SNAP2162BLSCTRA	A-16
SNAP1201ILRNA	D-8	SNAP2101ILINA	D-9	SNAP2152C1R	A-23	SNAP2162BLTRA	A-16
SNAP1201ILWNA	D-8, X-15	SNAP2101ILRNA	D-9	SNAP2152C1TRA	A-23	SNAP2162C1	A-23
SNAP1201INA	D-8	SNAP2101ILWNA	D-9, X-15	SNAP2152C1W	A-23, X-15	SNAP2162C1BK	A-23
SNAP1201LANA	D-8	SNAP2101INA	D-9	SNAP2152C1WTRA	A-23, X-15	SNAP2162C1BL	A-23
SNAP1201PLBKNA	D-8	SNAP2101LANA	D-9	SNAP2152C2	A-23	SNAP2162C1GN	A-23
SNAP1201PLINA	D-8	SNAP2101PLBKNA	D-9	SNAP2152C2BK	A-23	SNAP2162C1GY	A-23
SNAP1201PLRNA	D-8	SNAP2101PLINA	D-9	SNAP2152C2BKTRA	A-23	SNAP2162C1I	A-23
SNAP1201PLWNA	D-8, X-15	SNAP2101PLRNA	D-9	SNAP2152C2BL	A-23	SNAP2162C1ITRA	A-23
SNAP1201RNA	D-8	SNAP2101PLWNA	D-9, X-15	SNAP2152C2GN	A-23	SNAP2162C1LA	A-23
SNAP1201WNA	D-8, X-15	SNAP2101RNA	D-9	SNAP2152C2GNTRA	A-23	SNAP2162C1LATRA	A-23
SNAP1203BKNA	D-8	SNAP2101WNA	D-9, X-15	SNAP2152C2GY	A-23	SNAP2162C1R	A-23
SNAP1203BRNA	D-8	SNAP2103BKNA	D-9	SNAP2152C2GYTRA	A-23	SNAP2162C1TRA	A-23
SNAP1203GYNA	D-8	SNAP2103BRNA	D-9	SNAP2152C2I	A-23	SNAP2162C1W	A-23, X-15
SNAP1203ILBKNA	D-8	SNAP2103GYNA	D-9	SNAP2152C2ITRA	A-23	SNAP2162C1WTRA	A-23, X-15
SNAP1203ILINA	D-8	SNAP2103ILBKNA	D-9	SNAP2152C2LA	A-23	SNAP2162C2	A-23
SNAP1203ILRNA	D-8	SNAP2103ILINA	D-9	SNAP2152C2LATRA	A-23	SNAP2162C2BK	A-23
SNAP1203ILWNA	D-8, X-15	SNAP2103ILRNA	D-9	SNAP2152C2R	A-23	SNAP2162C2BKTRA	A-23
SNAP1203INA	D-8	SNAP2103ILWNA	D-9, X-15	SNAP2152C2TRA	A-23	SNAP2162C2BL	A-23
SNAP1203LANA	D-8	SNAP2103INA	D-9	SNAP2152C2W	A-23, X-15	SNAP2162C2GN	A-23
SNAP1203RNA	D-8	SNAP2103LANA	D-9	SNAP2152C2WTRA	A-23, X-15	SNAP2162C2GY	A-23
SNAP1203WNA	D-8, X-15	SNAP2103RNA	D-9	SNAP2152GYA	A-16	SNAP2162C2GYTRA	A-23
SNAP1221BKNA	D-8	SNAP2103WNA	D-9, X-15	SNAP2152GYL	A-16	SNAP2162C2I	A-23
SNAP1221BRNA	D-8	SNAP2121BKNA	D-9	SNAP2152GYLTRA	A-16	SNAP2162C2ITRA	A-23
SNAP1221GYNA	D-8	SNAP2121BRNA	D-9	SNAP2152GYN	A-16	SNAP2162C2LA	A-23
SNAP1221ILBKNA	D-8	SNAP2121GYNA	D-9	SNAP2152GYSCTRA	A-16		

Catalog Number Index

Catalog Number	Page	Catalog Number	Page	Catalog Number	Page	Catalog Number	Page
SNAP2162C2LATRA	A-23	SNAP2172LALTRA	A-14, L-7	SNAP2182WL	A-14, X-14, L-7	SNAP5262IA	A-15
SNAP2162C2R	A-23	SNAP2172LANA	A-14, L-7	SNAP2182WLTRA	A-14, X-14, L-7	SNAP5262IGL	A-15, M-15
SNAP2162C2TRA	A-23	SNAP2172LASCTRA	A-14, L-7	SNAP2182WNA	A-14, X-14, L-7	SNAP5262IGLTRA	A-15, M-15
SNAP2162C2W	A-23, X-15	SNAP2172LATRA	A-14, L-7	SNAP2182WSCTRA	A-14, X-14, L-7	SNAP5262IGTRA	A-15, M-15
SNAP2162C2WTRA	A-23, X-15	SNAP2172LTRA	A-14, L-7	SNAP2182WTRA	A-14, X-14, L-7	SNAP5262IL	A-15
SNAP2162GYA	A-16	SNAP2172NA	A-14, L-7	SNAP2RA	L-5, M-15, A-23	SNAP5262ILTTRA	A-15
SNAP2162GYL	A-16	SNAP2172RA	A-14, L-7	SNAP2RAM2	L-5	SNAP5262INA	A-15
SNAP2162GYLTRA	A-16	SNAP2172RIGL	A-14, M-15, L-7	SNAP2RNA	Q-5, L-5, X-14	SNAP5262IS	M-15, A-18
SNAP2162GYNA	A-16	SNAP2172RIGLTRAA	A-14, M-15, L-7	SNAP2RNAM2	L-5, X-14	SNAP5262ISCTRA	A-15
SNAP2162GYSCTRA	A-16	SNAP2172RIGTRA	A-14, M-15, L-7	SNAP3W1NA	D-9, D-8, X-15	SNAP5262ITRA	A-15
SNAP2162GYTRA	A-16	SNAP2172RL	A-14, L-7	SNAP3W1NAM2	X-15	SNAP5262L	A-15
SNAP2162IA	A-16	SNAP2172RLTRA	A-14, L-7	SNAP3W2NA	D-9, D-8, X-15	SNAP5262LAA	A-15
SNAP2162IGL	M-15, A-16	SNAP2172RNA	A-14, L-7	SNAP3W2NAM2	X-15	SNAP5262LAL	A-15
SNAP2162IGLTRA	M-15, A-16	SNAP2172RSCTRA	A-14, L-7	SNAP3WJUMP	D-9, D-8, X-15	SNAP5262LALTRA	A-15
SNAP2162IGTRA	M-15, A-16	SNAP2172RTRA	A-14, L-7	SNAP5261	A-15	SNAP5262LANA	A-15
SNAP2162IL	A-16	SNAP2172SCTRA	A-14, L-7	SNAP5261BK	A-15	SNAP5262LAS	M-15, A-18
SNAP2162ILTRA	A-16	SNAP2172TRA	A-14, L-7	SNAP5261BL	A-15	SNAP5262LASCTRA	A-15
SNAP2162INA	A-16	SNAP2172WA	A-14, L-7	SNAP5261GY	A-15	SNAP5262LATRA	A-15
SNAP2162ISCTRA	A-16	SNAP2172WL	A-14, X-14, L-7	SNAP5261I	A-15	SNAP5262LTRA	A-15
SNAP2162ITTRA	A-16	SNAP2172WLTRA	A-14, X-14, L-7	SNAP5261LA	A-15	SNAP5262NA	A-15
SNAP2162L	A-16	SNAP2172WNA	A-14, X-14, L-7	SNAP5261R	A-15	SNAP5262RA	A-15
SNAP2162LAA	A-16	SNAP2172WSCTRA	A-14, X-14, L-7	SNAP5261W	A-15	SNAP5262RL	A-15
SNAP2162LAL	A-16	SNAP2172WTRA	A-14, X-14, L-7	SNAP5262A	A-15	SNAP5262RLTRA	A-15
SNAP2162LALTRA	A-16	SNAP2182A	L-7, A-14, A-60	SNAP5262BKA	A-15	SNAP5262RNA	A-15
SNAP2162LANA	A-16	SNAP2182BKA	A-14, L-7	SNAP5262BKL	A-15	SNAP5262RSCTRA	A-15
SNAP2162LASCTRA	A-16	SNAP2182BKL	A-14, L-7	SNAP5262BKLTRA	A-15	SNAP5262RTRA	A-15
SNAP2162LATRA	A-16	SNAP2182BKLTRA	A-14, L-7	SNAP5262BKNA	A-15	SNAP5262S	M-15, A-18
SNAP2162LTRA	A-16	SNAP2182BKNA	A-14, L-7	SNAP5262BKSCCTRA	A-15	SNAP5262SCTRA	A-15
SNAP2162NA	A-16	SNAP2182BKSCCTRA	A-14, L-7	SNAP5262BKTRA	A-15	SNAP5262TRA	A-15
SNAP2162RA	A-16	SNAP2182BKTRA	A-14, L-7	SNAP5262BLL	A-15	SNAP5262WNA	A-15, X-14, X-15
SNAP2162RL	A-16	SNAP2182GYA	A-14, L-7	SNAP5262BLLTRA	A-15	SNAP5262WL	A-15, X-14
SNAP2162RLTRA	A-16	SNAP2182GYL	A-14, L-7	SNAP5262BLSCTRA	A-15	SNAP5262WLTRA	A-15, X-14
SNAP2162RNA	A-16	SNAP2182GYLTR	L-7	SNAP5262BLTRA	A-15	SNAP5262WNA	A-15, X-14
SNAP2162RSCTRA	A-16	SNAP2182GYLTRA	A-14, L-7	SNAP5262C1	A-23	SNAP5262WS	M-15, A-18
SNAP2162RTRA	A-16	SNAP2182GYNA	A-14, L-7	SNAP5262C1BK	A-23	SNAP5262WSCTRA	A-15, X-14
SNAP2162SCTRA	A-16	SNAP2182GYSCTRA	A-14, L-7	SNAP5262C1BL	A-23	SNAP5262WTRA	A-15, X-14
SNAP2162TRA	A-16	SNAP2182GYTRA	A-14, L-7	SNAP5262C1GN	A-23	SNAP5361	A-15
SNAP2162WA	A-16	SNAP2182IA	A-14, L-7	SNAP5262C1GY	A-23	SNAP5361BK	A-15
SNAP2162WL	X-14, A-16	SNAP2182IGL	A-14, M-15, L-7	SNAP5262C1I	A-23	SNAP5361BKTR	A-15
SNAP2162WLTRA	X-14, A-16	SNAP2182IGLTRA	A-14, M-15, L-7	SNAP5262C1ITTRA	A-23	SNAP5361BL	A-15
SNAP2162WNA	X-14, A-16	SNAP2182IGTRA	A-14, M-15, L-7	SNAP5262C1LA	A-23	SNAP5361BLTR	A-15
SNAP2162WSCTRA	X-14, A-16	SNAP2182IL	A-14, L-7	SNAP5262C1R	A-23	SNAP5361GY	A-15
SNAP2162WTRA	X-14, A-16	SNAP2182ILTRA	A-14, L-7	SNAP5262C1TRA	A-23	SNAP5361GYTR	A-15
SNAP2172A	A-14, L-7	SNAP2182INA	A-14, L-7	SNAP5262C1W	A-23, X-15	SNAP5361I	A-15
SNAP2172BKA	A-14, L-7	SNAP2182ISCTRA	A-14, L-7	SNAP5262C1WTRA	A-23, X-15	SNAP5361ITR	A-15
SNAP2172BKL	A-14, L-7	SNAP2182ITR	L-7	SNAP5262C2	A-23	SNAP5361LA	A-15
SNAP2172BKLTRA	A-14, L-7	SNAP2182ITTRA	A-14, L-7	SNAP5262C2BK	A-23	SNAP5361LATR	A-15
SNAP2172BKNA	A-14, L-7	SNAP2182L	A-14, L-7	SNAP5262C2BKTRA	A-23	SNAP5361R	A-15
SNAP2172BKSCCTRA	A-14, L-7	SNAP2182LAA	A-14, L-7	SNAP5262C2BL	A-23	SNAP5361RTR	A-15
SNAP2172BKTRA	A-14, L-7	SNAP2182LAL	A-14, L-7	SNAP5262C2GN	A-23	SNAP5361TR	A-15
SNAP2172GYA	A-14, L-7	SNAP2182LALTRA	A-14, L-7	SNAP5262C2GNTRA	A-23	SNAP5361W	A-15
SNAP2172GYL	A-14, L-7	SNAP2182LANA	A-14, L-7	SNAP5262C2GY	A-23	SNAP5361WTR	A-15
SNAP2172GYLTRA	A-14, L-7	SNAP2182LASCTRA	A-14, L-7	SNAP5262C2GYTRA	A-23	SNAP5362A	A-15
SNAP2172GYNA	A-14, L-7	SNAP2182LATRA	A-14, L-7	SNAP5262C2I	A-23	SNAP5362BKA	A-15
SNAP2172GYSCTRA	A-14, L-7	SNAP2182LTRA	A-14, L-7	SNAP5262C2ITTRA	A-23	SNAP5362BKL	A-15
SNAP2172GYTRA	A-14, L-7	SNAP2182NA	A-14, L-7	SNAP5262C2LA	A-23	SNAP5362BKLTRA	A-15
SNAP2172IA	A-14, L-7	SNAP2182RA	A-14, L-7	SNAP5262C2LATRA	A-23	SNAP5362BKNA	A-15
SNAP2172IGL	A-14, M-15, L-7	SNAP2182RIGL	A-14, M-15, L-7	SNAP5262C2R	A-23	SNAP5362BKSCCTRA	A-15
SNAP2172IGLTRA	A-14, M-15, L-7	SNAP2182RIGLTRAA	A-14, M-15, L-7	SNAP5262C2TRA	A-23	SNAP5362BKTRA	A-15
SNAP2172IGTRA	A-14, M-15, L-7	SNAP2182RIGTRA	A-14, M-15, L-7	SNAP5262C2W	A-23, X-15	SNAP5362BLL	A-15
SNAP2172IL	A-14, L-7	SNAP2182RL	A-14, L-7	SNAP5262C2WTRA	A-23, X-15	SNAP5362BLLTRA	A-15
SNAP2172ILTRA	A-14, L-7	SNAP2182RLTRA	A-14, L-7	SNAP5262GYA	A-15	SNAP5362BLSCTRA	A-15
SNAP2172INA	A-14, L-7	SNAP2182RNA	A-14, L-7	SNAP5262GYL	A-15	SNAP5362BLTRA	A-15
SNAP2172ISCTRA	A-14, L-7	SNAP2182RSCTRA	A-14, L-7	SNAP5262GYLTRA	A-15	SNAP5362C1	A-23
SNAP2172ITTRA	A-14, L-7	SNAP2182RTRA	A-14, L-7	SNAP5262GYNA	A-15	SNAP5362C1BK	A-23
SNAP2172L	A-14, L-7	SNAP2182SCTRA	A-14, L-7	SNAP5262GYS	M-15, A-18	SNAP5362C1BL	A-23
SNAP2172LAA	A-14, L-7	SNAP2182TRA	A-14, L-7	SNAP5262GYSCTRA	A-15	SNAP5362C1GN	A-23
SNAP2172LAL	A-14, L-7	SNAP2182WA	A-14, L-7	SNAP5262GYTRA	A-15	SNAP5362C1GY	A-23

Catalog Number Index

Catalog Number	Page	Catalog Number	Page	Catalog Number	Page	Catalog Number	Page
SNAP5362C1I	A-23	SNAP5461GYTR	A-16	SNAP8200WTRA	L-6, A-13, X-14	SNAP8300UACLA	Q-5, L-5
SNAP5362C1ITRA	A-23	SNAP5461ITR	A-16	SNAP8210	L-6, A-13	SNAP8300UACR	Q-5, L-5
SNAP5362C1LA	A-23	SNAP5461LATR	A-16	SNAP8210BK	L-6, A-13	SNAP8300UACW	Q-5, L-5, X-15
SNAP5362C1R	A-23	SNAP5461WTR	A-16	SNAP8210BL	L-6, A-13	SNAP8300WA	L-6, A-13, X-14
SNAP5362C1TRA	A-23	SNAP5661BKTR	A-16	SNAP8210GY	L-6, A-13	SNAP8300WL	L-6, A-13, X-14
SNAP5362C1W	A-23, X-15	SNAP5661BTR	A-16	SNAP8210I	L-6, A-13	SNAP8300WLTR	A-13
SNAP5362C1WTRA	A-23, X-15	SNAP5661GYTR	A-16	SNAP8210LA	L-6, A-13	SNAP8300WLTRA	L-6, A-13, X-14
SNAP5362C2	A-23	SNAP5661ITR	A-16	SNAP8210R	L-6, A-13	SNAP8300WNA	L-6, A-13, X-14
SNAP5362C2BK	A-23	SNAP5661LATR	A-16	SNAP8210W	L-6, A-13	SNAP8300WSCTRA	L-6, A-13, X-14
SNAP5362C2BKTRA	A-23	SNAP5661WTR	A-16	SNAP8262GYS	L-16, L-5, M-15, A-17	SNAP8300WTRA	L-6, A-13, X-14
SNAP5362C2BL	A-23	SNAP8200A	L-6, A-13	SNAP8262IS	L-16, L-5, M-15, A-17	SNAP8310BKTR	L-6, A-13
SNAP5362C2GN	A-23	SNAP8200BKA	L-6, A-13	SNAP8262LAS	L-16, L-5, M-15, A-17	SNAP8310BLTR	L-6, A-13
SNAP5362C2GNTRA	A-23	SNAP8200BKL	L-6, A-13	SNAP8262RS	L-16, L-5, M-15, A-17	SNAP8310GY	L-6, A-13
SNAP5362C2GY	A-23	SNAP8200BKLTR	L-6, A-13	SNAP8262S	L-16, L-5, M-15, A-17	SNAP8310GYTR	L-6, A-13
SNAP5362C2GYTRA	A-23	SNAP8200BKNA	L-6, A-13	SNAP8262WS	L-16, L-5, M-15, A-17, X-15	SNAP8310ITR	L-6, A-13
SNAP5362C2I	A-23	SNAP8200BKSCTRA	L-6, A-13	SNAP8300A	L-6, A-13	SNAP8310LATR	L-6, A-13
SNAP5362C2ITRA	A-23	SNAP8200GYA	L-6, A-13	SNAP8300BKA	L-6, A-13	SNAP8310ORTR	L-6, A-13
SNAP5362C2LA	A-23	SNAP8200GYL	L-6, A-13	SNAP8300BKL	L-6, A-13	SNAP8310TR	L-6, A-13
SNAP5362C2LATRA	A-23	SNAP8200GYLTR	L-6, A-13	SNAP8300BKLTRA	L-6, A-13	SNAP8310WTR	L-6, A-13
SNAP5362C2R	A-23	SNAP8200GYLTRA	L-6, A-13	SNAP8300BKNA	L-6, A-13	SNAP8362GYS	L-16, L-5, M-15, A-17
SNAP5362C2TRA	A-23	SNAP8200GYN	L-6, A-13	SNAP8300BKSCTRA	L-6, A-13	SNAP8362IS	L-16, L-5, M-15, A-17
SNAP5362C2W	A-23, X-15	SNAP8200GYSCTRA	L-6, A-13	SNAP8300BKTR	L-6, A-13	SNAP8362LAS	L-16, L-5, M-15, A-17
SNAP5362C2WTRA	A-23, X-15	SNAP8200GYTRA	L-6, A-13	SNAP8300BKNA	L-6, A-13	SNAP8362RS	L-16, L-5, M-15, A-17
SNAP5362GYA	A-15	SNAP8200IA	L-6, A-13	SNAP8300BKLTRA	L-6, A-13	SNAP8362S	L-16, L-5, M-15, A-17
SNAP5362GYL	A-15	SNAP8200IGL	L-6, M-15, A-13	SNAP8300GKTR	L-6, A-13	SNAP8362WS	L-16, L-5, M-15, A-17, X-15
SNAP5362GYLTRA	A-15	SNAP8200IGLTRA	L-6, M-15, A-13	SNAP8300GYA	L-6, A-13	SNAPACTG	L-7, BB-3, A-18, X-15
SNAP5362GYNA	A-15	SNAP8200IGTRA	L-6, M-15, A-13	SNAP8300GYL	L-6, A-13	SNAPGF15GRY	K-5
SNAP5362GYS	M-15, A-18	SNAP8200IL	L-6, A-13	SNAP8300GYLTR	A-13	SNAPGF15I	K-5
SNAP5362GYSCTRA	A-15	SNAP8200ILTR	A-13	SNAP8300GYNA	L-6, A-13	SNAPGF15LA	K-5
SNAP5362GYTRA	A-15	SNAP8200ILTRA	L-6, A-13	SNAP8300GYSTR	L-6, A-13	SNAPGF15W	K-5
SNAP5362IA	A-15, A-60	SNAP8200INA	L-6, A-13	SNAP8300IA	L-6, A-13	SNAPGF20	K-5
SNAP5362IGL	A-15, M-15	SNAP8200ISCTRA	L-6, A-13	SNAP8300IGL	L-6, M-15, A-13	SNAPGF20BLK	K-5
SNAP5362IGLTRA	A-15, M-15	SNAP8200ITRA	L-6, A-13	SNAP8300IGLTRA	L-6, M-15, A-13	SNAPGF20GRY	K-5
SNAP5362IGTRA	A-15, M-15	SNAP8200L	L-6, A-13	SNAP8300IGTRA	L-6, M-15, A-13	SNAPGF20I	K-5
SNAP5362IL	A-15	SNAP8200LAA	L-6, A-13	SNAP8300IL	L-6, A-13	SNAPGF20LA	K-5
SNAP5362ILTRA	A-15	SNAP8200LAL	L-6, A-13	SNAP8300ILTRA	L-6, A-13	SNAPGF20R	K-5
SNAP5362INA	A-15	SNAP8200LALTRA	L-6, A-13	SNAP8300INA	L-6, A-13	SNAPGF20W	K-5
SNAP5362IS	M-15, A-18	SNAP8200LANA	L-6, A-13	SNAP8300ISCTRA	L-6, A-13	SNAPGF82I	L-5, L-15, K-6, A-17
SNAP5362ISCTRA	A-15	SNAP8200LASCTRA	L-6, A-13	SNAP8300ITRA	L-6, A-13	SNAPGF82LA	L-5, L-15, K-6, A-17
SNAP5362ITRA	A-15	SNAP8200LATRA	L-6, A-13	SNAP8300L	L-6, A-13	SNAPGF82R	L-5, L-15, K-6, A-17
SNAP5362L	A-15	SNAP8200LTRA	L-6, A-13	SNAP8300LAA	L-6, A-13	SNAPGF82W	K-6, L-5, L-15, A-17, X-15
SNAP5362LAA	A-15	SNAP8200LAL	L-6, A-13	SNAP8300LAL	L-6, A-13	SNAPGF83	L-5, L-15, K-6, A-17
SNAP5362LAL	A-15	SNAP8200LALTRA	L-6, A-13	SNAP8300LALTRA	L-6, A-13	SNAPGF83BLK	L-5, L-15, K-6, A-17
SNAP5362LALTRA	A-15	SNAP8200LANA	L-6, A-13	SNAP8300LALTRA	L-6, A-13	SNAPGF83GRY	L-5, L-15, K-6, A-17
SNAP5362LANA	A-15	SNAP8200LASCTRA	L-6, A-13	SNAP8300LATR	L-6, A-13	SNAPGF83I	L-5, L-15, K-6, A-17
SNAP5362LAS	M-15, A-18	SNAP8200LATRA	L-6, A-13	SNAP8300LATRA	L-6, A-13	SNAPGF83LA	L-5, L-15, K-6, A-17
SNAP5362LASCTRA	A-15	SNAP8200LTRA	L-6, A-13	SNAP8300LTRA	L-6, A-13	SNAPGF83R	L-5, L-15, K-6, A-17
SNAP5362LATRA	A-15	SNAP8200LA	L-6, A-13	SNAP8300NA	L-6, A-13	SNAPGF83W	K-6, L-5, L-15, A-17, X-15
SNAP5362LTRA	A-15	SNAP8200LAL	L-6, A-13	SNAP8300OR	L-6, A-13	SNAPGFTW15	K-7
SNAP5362NA	A-15	SNAP8200LALTRA	L-6, A-13	SNAP8300ORIGL	L-6, M-15, A-13	SNAPGFTW15BLK	K-7
SNAP5362RA	A-15	SNAP8200LANA	L-6, A-13	SNAP8300ORIGTRA	L-6, M-15, A-13	SNAPGFTW15I	K-7
SNAP5362RL	A-15	SNAP8200LASCTRA	L-6, A-13	SNAP8300ORL	L-6, A-13	SNAPGFTW15W	K-7
SNAP5362RLTRA	A-15	SNAP8200LATRA	L-6, A-13	SNAP8300ORLTR	L-6, A-13	SNAPGFTW20	K-7
SNAP5362RSCTRA	A-15	SNAP8200LTRA	L-6, A-13	SNAP8300ORLA	L-6, A-13	SNAPGFTW20BLK	K-7
SNAP5362RTRA	A-15	SNAP8200LAL	L-6, A-13	SNAP8300ORLTRA	L-6, A-13	SNAPGFTW20GRY	K-7
SNAP5362S	M-15, A-18	SNAP8200LALTRA	L-6, A-13	SNAP8300ORTRA	L-6, A-13	SNAPGFTW20I	K-7
SNAP5362SCTRA	A-15	SNAP8200LANA	L-6, A-13	SNAP8300ORW	L-6, A-13	SNAPGFTW20LA	K-7
SNAP5362TRA	A-15	SNAP8200LASCTRA	L-6, A-13	SNAP8300ORWNA	L-6, A-13, X-14, A-60	SNAPGFTW20R	K-7
SNAP5362WA	A-15, X-14	SNAP8200LATRA	L-6, A-13	SNAP8300ORWTRA	L-6, A-13, X-14	SNAPGFTW20W	K-7
SNAP5362WL	A-15, X-14	SNAP8200LTRA	L-6, A-13	SNAP8300UACB	Q-5, L-5	SNAPGFTW82GRY	L-5, K-7, L-14, A-17
SNAP5362WLTRA	A-15, X-14	SNAP8200LA	L-6, A-13	SNAP8300UACG	Q-5, L-5	SNAPGFTW82I	L-5, K-7, L-14, A-17
SNAP5362WNA	A-15, X-14	SNAP8200LAL	L-6, A-13	SNAP8300UACI	Q-5, L-5	SNAPGFTW82LA	L-5, K-7, L-14, A-17
SNAP5362WS	M-15, A-18, X-15	SNAP8200LALTRA	L-6, A-13				
SNAP5362WSCTRA	A-15, X-14	SNAP8200LANA	L-6, A-13				
SNAP5362WTRA	A-15, X-14	SNAP8200LASCTRA	L-6, A-13				
SNAP5461BKTR	A-16	SNAP8200LATRA	L-6, A-13				
SNAP5461BTR	A-16	SNAP8200LTRA	L-6, A-13				

Catalog Number Index

Catalog Number	Page	Catalog Number	Page	Catalog Number	Page	Catalog Number	Page
A-17		SS2309BALA	P-34	SS7L	B-63, B-50, B-62, N-7	TPF1BK	Y-10
SNAPGFTW82RL-5, K-7, L-14, A-17		SS2309BBKA	P-34	SS8	O-39, N-7, A-52, AA-45, B-50	TPF1GY	Y-10
SNAPGFTW82W	L-14, L-5, K-7, A-17, X-15	SS2309BGYA	P-34	SS82	N-7, O-39, AA-45	TPF1OW	Y-10
SNAPGFTW83	L-5, K-7, L-14, A-17	SS2309DBKA	P-34	SS826	Z-13, N-10	TPF1W	Y-10
SNAPGFTW83BLK	L-5, K-7, L-14, A-17	SS2309DGYA	P-34	SS82L	N-7	TTBDS1AL	X-3
SNAPGFTW83GRY	L-5, K-7, L-14, A-17	SS2309F1BKA	P-34	SS82MEV	N-15	TTBDS1BK	X-3
SNAPGFTW83I	L-5, K-7, L-14, A-17	SS2309F1GYA	P-34	SS83	N-7	TTBDS1BR	X-3
SNAPGFTW83LA	L-5, K-7, L-14, A-17	SS2309FALA	P-34	SS84	N-7	TTBDS2AL	X-3
SNAPGFTW83RL-5, K-7, L-14, A-17		SS2309FBKA	P-34	SS8720	N-10	TTBDS2BK	X-3
SNAPGFTW83W	L-14, L-5, K-7, A-17, X-15	SS2309FGYA	P-34	SS8L	B-50, N-7	TTBDS2BR	X-3
SNAPSP1NA	D-9, D-8, X-15	SS2309SBKA	P-34	SS8MEV	N-15	TTBKSAL	X-3
SNAPSP1NAM2	X-15	SS2309SGYA	P-34	SSB1	D-24	TTBKSBK	X-3
SNAPSP2NA	D-9, D-8, X-15	SS2309SLBKA	P-34	SSF11	Y-9	TTBKSBR	X-3
SNAPSP2NAM2	X-15	SS2309SLGYA	P-34	SSF12	Y-9	TTBXLRAL	X-3
SNAPSPP1NA	D-9, D-8, X-15	SS2309TBKA	P-34	SSF13	Y-9	TTBXLRBK	X-3
SNAPSPP1NAM2	X-15	SS2309TGYA	P-34	SSF14	Y-9	TTBXLRBR	X-3
SNAPSPP2NA	X-15	SS23L	N-9	SSF16	Y-9	TV97	AA-33, AA-5
SNAPSPP2NAM2	X-15	SS24	N-9	SSF204	Y-9	TV98	AA-33, AA-5
SNAPSWJUMP	D-9, D-8	SS26	D-19, O-39, Z-12, A-52, N-5, AA-45, M-13	SSF206	Y-9	TV98W	AA-33, AA-5
SP15USB1	Q-3	SS262D-19, O-39, Z-12, AA-45, N-5		SSF209	Y-9	TV99	AA-33, AA-5
SP15USB1B	Q-3	SS262L	D-19, Z-12, N-5	SSF212	Y-9	TV99W	AA-33, AA-5
SP15USB2	Q-3	SS263	D-19, Z-12, N-5	SSFL11	Y-9	TWPF1GY	Y-10
SP15USB2B	Q-3	SS264	Z-12, N-5	SSFL12	Y-9	TX0304000304T00	I-3
SP15USB3	Q-3	SS265	Z-12, N-5	SSFL13	Y-9	TX1002001002T00	I-3
SP15USB3B	Q-3	SS266	Z-12, N-5	SSFL14	Y-9	TX1003001003T00	I-3
SP15USB4	Q-3	SS26L	D-19, Z-12, N-5	SSFL16	Y-9	TX1004001004T00	I-3
SP15USB4B	Q-3	SS2L	D-19, N-6	SSJ1	N-14	TX1005001005T00	I-3
SP31	O-43	SS3	D-19, N-6	SSJ11	N-14	TX1006001006T00	I-3
SP5EF	Y-9	SS309B	O-39, P-35, T-16	SSJ126	N-14	TX2002002002T00	S-68, I-2
SP5ER	Y-9	SS309BF	O-39, P-35, T-16	SSJ13	N-14	TX2003002003T00	S-68, I-2
SP6F	Y-9	SS309D	O-39, P-35, T-16	SSJ18	N-14	TX2004002004T00	S-68, I-2
SP6R	Y-9	SS309DS	O-39, P-35, T-16	SSJ2	N-14	TX2005002005T00	S-68, I-2
SP83	O-43	SS309S	O-39, P-35, T-16	SSJ23	N-14	TX2304002304T00	S-68, I-2
SP84	O-43	SS309SF	O-39, P-35, T-16	SSJ26	M-13, N-14	TX2306002304A00	S-68, I-2
SPPBK10	Y-12, Y-8	SS309T	O-39, P-35, T-16	SSJ262	N-14	TX2306002304B00	S-68, I-2
SPPR10	Y-12, Y-8	SS320	N-8	SSJ7	N-14	TX2306002304C00	S-68, I-2
SPUR	Y-9	SS326	N-12, Z-13	SSJ723	N-14	TX2306002306T00	S-68, I-2
SR3050	AA-14, AA-16, AA-10	SS33	N-9	SSJ8	N-14	TX3004003004T00	S-68, I-2
SR50	H-13	SS34	N-9	SSJ82	N-14	UFC0001	W-72
SS1	D-19, AA-45, N-6	SS3L	D-19, N-6	SSK	H-13	UFC0001CR	W-72
SS11	N-13	SS4	N-6	SSK60	H-13	UFC001ZP	W-72
SS113	N-10	SS43	N-9	SWB1	A-45	UFC0002	W-72
SS114	N-10	SS5	N-6	SWB2	A-45	UFC0003	W-72
SS12	N-13	SS6	N-6	SWB4	A-45	UFC003CR	W-72
SS126	AA-45, Z-13, N-10	SS607	N-6	SWB5	A-45	UFC2001CR	W-72
SS126L	Z-13	SS608	N-6	SWP1	N-17	UFC2003CR	W-72
SS12RKL	N-16	SS7	N-7, O-39, A-52, AA-45, N-18, B-63, B-62, B-50	SWP12	N-17	UGP15231	A-45
SS12RKLM	N-16	SS701	A-55, O-39, N-8, N-18	SWP126	N-17	UGP20231	A-45
SS13	O-39, AA-45, N-9	SS702	N-8	SWP13	N-17	UGRA20231	A-45
SS138	N-11	SS703	A-54, O-39, N-8, N-18	SWP18	N-17	UGRO20231	A-45
SS13L	N-9	SS703L	N-8	SWP2	N-17	USB10	Y-14
SS14	N-9	SS716	N-8	SWP23	N-17	USB102	Q-5, A-32, Z-7
SS1426	Z-13, N-10	SS72	N-7, O-39, N-18	SWP26	N-17	USB102BK	Q-5, A-32, Z-7
SS148	N-11	SS7200-39, N-8, N-18, AA-11, B-52		SWP262	N-17	USB102GY	Q-5, A-32, Z-7
SS18	AA-45, N-10	SS723	A-54, N-8, N-18	SWP263	N-17	USB102I	Q-5, A-32, Z-7
SS1L	D-19, N-6	SS725	AA-11, N-18, N-8, B-49	SWP28	N-17	USB102LA	Q-5, A-32, Z-7
SS1ME	N-15	SS737	B-68, B-65, N-8	SWP3	N-17	USB102W	Q-5, A-32, Z-7
SS2	D-19, AA-45, N-6	SS738	N-13	SWP4	N-17	USB1518	Z-7
SS226	N-11, Z-13	SS739	N-13	SWP8	N-17	USB1528AC	Z-7
SS22RKL	N-16	SS740	N-6	SWP812	N-17	USB15AC5BKWR	Q-4, A-32, Z-7
SS22RKLM	N-16	SS747	N-7	SWP813	N-17	USB15AC5GYWR	Q-4, A-32, Z-7
SS22RKLM	N-16	SS748	N-7	SWP82	N-17	USB15AC5IWR	Q-4, AA-41, A-32, Z-7
SS23	O-39, N-9	SS749	N-8	TB2	F-30	Z-7	
		SS750	AA-15, N-20, B-60, AA-17	TB5	F-30	USB15AC5LAWR.Q-4, AA-41, A-32, Z-7	
		SS771	N-13	TPC100	H-14	Z-7	
		SS78	N-10	TPC50	H-14	USB15AC5WR	Q-4, A-32, Z-7
				TPDL	H-14	USB15AC5WWR	Q-4, AA-41, A-32, Z-7
				TPDS	H-14	Z-7	

Catalog Number Index

Catalog Number	Page	Catalog Number	Page	Catalog Number	Page	Catalog Number	Page
USB15ACPD	Q-4, A-32, Z-7	USB8300ACPD	Q-4, L-10	WS1024I	Z-20, E-6	ZB332C3W2TC	O-43
USB15ACPDBK	Q-4, A-32, Z-7	USB8300ACPDBK	Q-4, L-10	WS1024LA	Z-20, E-6	ZB332C3W4TC	O-43
USB15ACPDGY	Q-4, A-32, Z-7	USB8300ACPDGY	Q-4, L-10	WS1024NI	Z-20, E-6	ZB332C6W2P	O-43
USB15ACPDI Q-4, AA-41, A-32, Z-7		USB8300ACPDI	Q-4, L-10	WS1024NLA	Z-20, E-6	ZB332C6W2TM	O-43
USB15ACPDLA	Q-4, AA-41, A-32, Z-7	USB8300ACPDLA	Q-4, L-10	WS1024NW	Z-20, E-6	ZB422S2C16W4P	O-43
USB15ACPDW	A-62, Z-7, AA-41, Q-4, A-32, Z-6	USB8300ACPD	Q-4, L-10, A-32	WS1024W	Z-20, E-6	ZB422S2C16W4TM	O-43
USB15CPD	Q-4, A-32, Z-7	USB8300CPD	Q-4, L-10, A-32	WS1025I	Z-20, E-6	ZB422S2C4W1PIN	O-43
USB15CPDBK	Q-4, A-32, Z-7	USB8300CPDBK	Q-4, L-10, A-32	WS1025LA	Z-20, E-6	ZB422S2C4W1POUT	O-43
USB15CPDGY	Q-4, A-32, Z-7	USB8300CPDGY	Q-4, L-10, A-32	WS1025NI	Z-20, E-6	ZB422S2C4W2TC	O-43
USB15CPDI	Q-4, AA-41, A-32, Z-7	USB8300CPDI	Q-4, L-10, A-32	WS1025NLA	Z-20, E-6	ZB422S2C4W4TC	O-43
USB15CPDLA	Q-4, AA-41, A-32, Z-7	USB8300CPDLA	Q-4, L-10, A-32	WS1025NW	Z-20, E-6	ZB422S2C8W2P	O-43
USB15CPDW	Q-4, A-32, Z-7	USB8300CPDR	Q-4, L-10, A-32	WS1025W	Z-20, E-6	ZB422S2C8W2TM	O-43
USB2028AC	Z-7	VCGP100	AA-51	WS2000GY	Z-20, E-6	ZB422S3C16W4P	O-43
USB20AC5BKWR	Q-4, A-32, Z-7	VHC1021	W-71	WS2000I	Z-20, E-6	ZB422S3C16W4TM	O-43
USB20AC5GYWR	Q-4, A-32, Z-7	VHC1022	W-71	WS2000LA	Z-20, E-6	ZB422S3C4W1PIN	O-43
USB20AC5IWR	Q-4, AA-41, A-32, Z-7	VHC1022ZP	W-71	WS2000NGY	Z-20, E-6	ZB422S3C4W1POUT	O-43
USB20AC5LAWR	Q-4, AA-41, A-32, Z-7	VHC1023	W-71	WS2000NI	Z-20, E-6	ZB422S3C4W2TC	O-43
USB20AC5WR	Q-4, A-32, Z-7	VHC1023ZP	W-71	WS2000NLA	Z-20, E-6	ZB422S3C4W4TC	O-43
USB20AC5WWR	Q-4, AA-41, A-32, Z-7	VHC1024	W-71	WS2000NW	Z-20, E-6	ZB422S3C8W2P	O-43
USB20ACPD	Q-4, A-32, Z-7	VHC1024ZP	W-71	WS2000W	Z-20, E-6	ZB422S3C8W2TM	O-43
USB20ACPDBK	Q-4, A-32, Z-7	VHC1035	W-71	WS2004I	Z-20, E-6		
USB20ACPDGY	Q-4, A-32, Z-7	VHC1036	W-71	WS2004NI	Z-20, E-6		
USB20ACPDI	Q-4, A-32, Z-7	VHC1037	W-71	WS2004NW	Z-20, E-6		
USB20ACPDLA	Q-4, A-32, Z-7	VHC1041	W-71	WS2004W	Z-20, E-6		
USB20ACPDW	Q-4, A-32, Z-7	VHC1042	W-71	WSBF22BK	X-4		
USB20CPD	Q-4, A-32, Z-7	VHC1052	W-71	WSBF22SV	X-4		
USB20CPDBK	Q-4, A-32, Z-7	VHC1053	W-71	WSBFGROMBAL	X-4		
USB20CPDGY	Q-4, A-32, Z-7	WC310280	AA-9, AA-5	WSBFGROMBK	X-4		
USB20CPDI	Q-4, A-32, Z-7	WCSS4	N-31	WSBFGROMBSS	X-4		
USB20CPDLA	Q-4, A-32, Z-7	WP1	N-19, B-50, A-53	WSBFGROMSV	X-4		
USB20CPDW	Q-4, A-32, Z-7	WP2	N-19, B-52	WSBG43UBAL	X-4		
USB4	Z-7	WP262E	N-24	WSBG43UBA	X-4		
USB4AC	Q-5, A-32, Z-7	WP26E	N-24	WSBG43UBK	X-4		
USB4ACBK	Q-5, A-32, Z-7	WP26EH	N-24	WSBG43USV	X-4		
USB4ACGY	Q-5, A-32, Z-7	WP26H	N-23	WSBPLATE1	X-4		
USB4ACI	Q-5, A-32, Z-7	WP26V	N-23	WSBUSB2X2AC5ALU	Q-5, X-2		
USB4ACLA	Q-5, A-32, Z-7	WP4600	N-26	WSBUSB2X2AC5BLK	Q-5, X-2		
USB4ACW	Q-5, Z-6, A-32, Z-7	WP8H	N-23	WSBUSB2X2AC5WHT	Q-5, X-2		
USB4BK	Z-7	WP8V	N-23	WSTA120	E-6		
USB4C	Z-7	WS1000I	Z-20, E-6	WTSS234	B-42		
USB4CBK	Z-7	WS1000LA	Z-20, E-6	WTSS234SS	B-42		
USB4CGY	Z-7	WS1000NI	Z-20, E-6	WTSS310	B-42		
USB4CI	Z-7	WS1000NLA	Z-20, E-6	WTSS310SS	B-42		
USB4CLA	Z-7	WS1000NW	Z-20, E-6	XLR10	Y-14		
USB4CW	Z-7	WS1000W	Z-20, E-6	XLRST10	Y-14		
USB4GY	Z-7	WS1001	Z-20, E-6	YC306250	AA-15		
USB4I	Z-7	WS1001LA	Z-20, E-6	YC310250	AA-9, AA-5		
USB4LA	Z-7	WS1001NI	Z-20, E-6	YC406250	AA-17		
USB4W	Q-5, A-32, Z-7	WS1001NLA	Z-20, E-6	YQ100PLUS	AA-26		
USB8200ACPD	Q-4, L-10, A-32	WS1001NW	Z-20, E-6	YQ230	AA-26		
USB8200ACPDBK	Q-4, L-10, A-32	WS1001W	Z-20, E-6	ZB111C1W1PIN	O-43		
USB8200ACPDGY	Q-4, L-10, A-32	WS1020GY	Z-20, E-6	ZB111C1W1POUT	O-43		
USB8200ACPDI	Q-4, L-10, A-32	WS1020I	Z-20, E-6	ZB111C1W2TC	O-43		
USB8200ACPDLA	Q-4, L-10, A-32	WS1020LA	Z-20, E-6	ZB111C1W4TC	O-43		
USB8200ACPDR	Q-4, L-10, A-32	WS1020NGY	Z-20, E-6	ZB111C1W6TC	O-43		
USB8200ACPDW	Q-4, L-10, A-32	WS1020NI	Z-20, E-6	ZB111C1W8TC	O-43		
USB8200CPD	Q-4, L-10, A-32	WS1020NLA	Z-20, E-6	ZB111C2W2P	O-43		
USB8200CPDBK	Q-4, L-10, A-32	WS1020NW	Z-20, E-6	ZB111C2W2TM	O-43		
USB8200CPDGY	Q-4, L-10, A-32	WS1020W	Z-20, E-6	ZB111C4W4P	O-43		
USB8200CPDI	Q-4, L-10, A-32	WS1021GY	Z-20, E-6	ZB111C4W4TM	O-43		
USB8200CPDLA	Q-4, L-10, A-32	WS1021I	Z-20, E-6	ZB111C6W6P	O-43		
USB8200CPDR	Q-4, L-10, A-32	WS1021LA	Z-20, E-6	ZB111C6W6TM	O-43		
USB8200CPDW	Q-4, L-10, A-32	WS1021NGY	Z-20, E-6	ZB111C8W8P	O-43		
		WS1021NI	Z-20, E-6	ZB111C8W8TM	O-43		
		WS1021NLA	Z-20, E-6	ZB332C12W4P	O-43		
		WS1021NW	Z-20, E-6	ZB332C12W4TM	O-43		
		WS1021W	Z-20, E-6	ZB332C3W1PIN	O-43		
				ZB332C3W1POUT	O-43		

Hubbell Wiring Device-Kellems

General Information

Industrial and Commercial Wiring Devices and Systems

Kellems Wire Management Products

Residential Products

Marine Products



National Electrical Manufacturers Association

NEMA promotes the competitiveness of its member companies by providing a forum for the development of technical standards that are in the best interests of the industry and the users of its products.



National Association of Electrical Distributors

Since 1908, NAED has served as the trade association for the electrical distribution industry.

To be an NAED associate member, your company must be a manufacturer or value-added reseller.



Restriction of Hazardous Substances

The RoHS Directive stands for "the restriction of the use of certain hazardous substances in electrical and electronic equipment".



U.S. Green Building Council Member

Hubbell is a US Green Building Council (USGBC) member dedicated to advancing buildings that are environmentally responsible in the way they are designed, built and operated.



ISO 9001

International Organization for Standardization

ISO (International Organization for Standardization) is the world's largest developer and publisher of International Standards.

Precautions have been taken to assure accuracy of the information in this catalog. Typographical or pictorial errors which are brought to our attention will be corrected in subsequent issues.

Product dimensions in this catalog are nominal and are provided for the convenience of our customers. Hubbell reserves the right to make product changes from time to time, without prior notification, which may change the dimensions shown. We, therefore, recommend they be checked before using for customer projects or product development and specification.

The designs and dimensions of the products listed in this catalog, were correct at the date of publication and are subject to change without notice.

All configuration diagrams shown in the various sections of the catalog are female devices (receptacles, connector bodies, etc.) unless otherwise indicated.

No material will be accepted for return unless permission is granted in writing by this Company. All orders received for special items and engraved plates are accepted as firm orders and are non-cancelable by the customer.

Claims for freight charges or allowances of any kind will not be considered after 30 days from receipt of goods and our responsibility ceases when we have delivered such shipments to the carriers and hold their receipts.

The following trademarks of Hubbell Incorporated, are your assurance of the highest quality wiring devices and wiring management products in the industry.

- | | | | | |
|-----------------|--------------------|-----------------------|-------------------|---------------------|
| • 4-PLEX® | • HBL® | • Micro-Quick® | • PremiseTrak® | • Super Twist-Lock® |
| • AccessTrak® | • Handi-Screw® | • Mini-Quick® | • PresSwitch® | • SWITCHOUT® |
| • Advantage™ | • Hubbell® | • MotorQuick® | • ProTrak™ | • SwivelLok® |
| • ADD-A-SHROUD® | • Hubbell Juniors® | • Nano-Quick® | • RACO® | • tradeSELECT® |
| • AUTOGUARD® | • Hubbellok® | • netSELECT® | • Rough-in Ready® | • TredTrak® |
| • BaseTrak® | • Hubbellnet® | • NEXTSPEED® | • Safety-Shroud® | • TrukTrak® |
| • CableTrak® | • inSIGHT™ | • NOT Plug Resistant™ | • ScrubShield® | • Twist-Lock® |
| • CircuitGuard® | • Insul-Lock™ | • OPTIMYZER® | • Seal-Tite® | • Valise® |
| • Circuit-Lock® | • Insulgrip® | • OPTISOK® | • Signal-Quick® | • Variload® |
| • CircuitPro® | • JLOAD® | • PANEL-SAFE® | • SNAPConnect® | • VARI-SIZE® |
| • DUA-PULL® | • Kellems® | • PLUG-CHECK® | • SPEEDGAIN® | • WallTrak® |
| • Elastogrip® | • LANTrak® | • PLUGOUT® | • Spider® | • XCLAMP™ |
| • FloorTrak® | • LINKOSITY® | • PlugTrak® | • SpikeShield® | |
| • GOTCHA® | • Load:Logic® | • PolyTrak® | • Style Line® | |
| • Gripulator® | • MAXX™ | • PolyTuff® | • Super BaseTrak® | |

UPC Vendor Code No. 783585 - Hubbell Wiring Device-Kellems

CAGE No. 74545

© 2020 Hubbell Incorporated

Hubbell Incorporated Worldwide Locations

US Offices

HUBBELL INCORPORATED (Delaware)

40 Waterview Drive
Shelton, Connecticut 06484
Tel: (475) 882-4000
www.hubbell.com

HUBBELL PREMISE WIRING

23 Clara Drive, Suite 103
Mystic, Connecticut 06355
Tel: (800) 626-0005
www.hubbell-premise.com



Northeast Regional Office

103 S. High Street
West Chester, PA 19382
Phone: (610) 436-9652
(610) 436-9653

Central Regional Office

801 Warrenville Road
Suite 245
Lisle, IL 60532-3601
Phone: (630) 810-4901

Southern Regional Office

1511 Johnson Ferry Rd
Suite 100
Marietta, GA 30062
Phone: (770) 565-2183

Western Regional Office

4960 Robert J Mathews Pkwy
Suite A
El Dorado Hills, CA 95762-5721
Phone: (916) 673-1980

Hubbell Wiring Global Sales Locations

CANADA

Hubbell Canada LP
870 Brock Road South
Pickering, Ontario L1W 1Z8
Canada
Tel: 905-839-1138
Fax: 905-839-9108

MEXICO

Hubbell Products México, S. de R.L. de C.V.
Calle Cinco Sur # 104
Col. Parque Industrial Toluca 2000
C.P. 50200 Toluca, México
Tel: (722) 265 44 00

EUROPE REGION HQ

Hubbell Wiring Systems, Europe
Brunel Drive
Stretton Park
Burton Upon Trent
Staffordshire DE13-OBZ
England
Tel: 44-1283-500500
Fax: 44-1283-500400

MIDDLE EAST, AFRICA, INDIA

Hubbell Premise Wiring
Building 6EB, Office 432
Dubai Airport Free Zone (DAFZ)
P.O. Box 23529
Dubai, United Arab Emirates
Tel: 971-4-609-1222
Fax: 971-4-609-1225

INDIA and SAARC

Hubbell Wiring Systems
Unit Number 4B, 1st Floor, Zenith Building
Ascendas IT Park, CSIR Road
Taramani Chennai – 600113
Tel: +91-94088 1554
Tel: +91-44 4930 4052

DOMINICAN REPUBLIC

COLOMBO-INTER
Av. Hispanoamericano
Zona Franca Industrial
Caribbean Industrial Park
Modulo B-4c
Matanza, Santiago, Dominican Republic
Tel: (809) 626-5993
Mobile: (809) 445-3111

LATIN AMERICA REGION HQ

Hubbell Wiring Systems
12973 SW 112 ST, #390
Miami, FL 33186
Tel: 305-408-4501
Fax: 305-408-8201

CENTRAL AMERICA

Hubbell Wiring Systems, Central America
Frente al Banco Nacional de Costa Rica
Barva, Heredia
Costa Rica
Tel: 506-8328-4283
Fax: 506-2260-1616

COLOMBIA, ECUADOR, PERU and VENEZUELA

Hubbell Premise Wiring
Calle Luxemburgo y Av. Portugal
#N-34-340
Quito, Ecuador
Tel: 593-9-9339-6400 (Ecuador)

COLOMBIA

Vistalev
Carrera 11 #93A-53
Bogotá D.C. - Colombia
Tel: 571-634-7623
Mobil: 571-310-209-0076

ARGENTINA, CHILE, URUGUAY and PARAGUAY

Hubbell Wiring Systems
1406 Primera Junta 2361
Buenos Aires, Argentina
Tel: 54-911-6268-0441

CARIBBEAN

Hubbell Wiring Systems
P. O. Box 4138
Road 686, Km. 17.3
Vega Baja, Puerto Rico 00694-4138
Tel: 787-674-2727

TRINIDAD

Single Source Solutions
18 Vallot Street
Boissiere No. 1, Maraval
Port of Spain
Trinidad, West Indies
Tel: +1-305-407-8092

PHILIPPINES

HUBBELL-TAIAN CO. LTD.
Philippine Representative Office
Raffles Corporate Center Unit 1409, 14th Floor
Emerald Ave., Ortigas Business District
Brgy. San Antonio, Pasig City 1605
Philippines
Telefax: (632) 655-6893 / 655-2938 / 655-9959

ASIA PACIFIC REGION HQ/ HONG KONG

Hubbell Wiring Systems
15/F, Radio City
511 Hennessy Road
Causeway Bay, Hong Kong
Tel: 852-2836-7131
Fax: 852-2836-7132

CHINA

Hubbell Commercial & Trading
(Shanghai) Co., Ltd
Room H/I, 18F
Shanghai International Ocean and Finance Building
No. 720 Pudong Avenue
Shanghai 200120, P. R. China
Tel: 8621-3392-6550 ext 218
Fax: 8621-3392-6551

KOREA

Hubbell International, Inc.
Korea Branch
512 Hyosung Intellian
426 Kangseo-Rd., Kangseo-Ku
Seoul 157-930, Korea
Postal Code: 07582
Tel: 82-2-2607-1363
Fax: 82-2-2603-7386

TAIWAN

Hubbell-Taian Co., Ltd.
7F, No. 19-8, Sanchong Road,
Nangang Dist. 11501 Taipei, Taiwan
Tel: 02-2655-1028
Fax: 02-2655-1029



HUBBELL Your Complete Online Resource

An all inclusive product search will supply end users with a spec sheet, corresponding literature, diagrams and more.

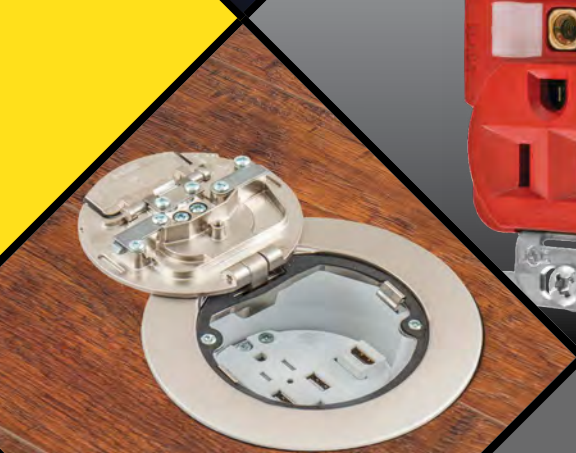
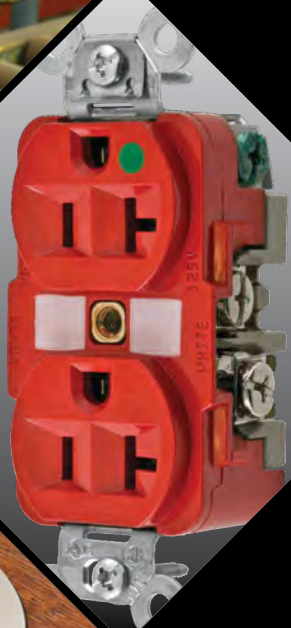

HUBBELL[®]
Wiring Device-Kellems

www.hubbell.com/wiringdevice-kellems/en



Hubbell Wiring Device-Kellems
Hubbell Incorporated (Delaware)
40 Waterview Drive, Shelton CT 06484
Tel: (800) 288-6000
Fax: (800) 255-1031
www.hubbell-wiring.com

Hubbell Canada LP
870 Brock Road South
Pickering, Ontario L1W 1Z8
Tel: (800) 263-4622
(905) 839-1138
Fax: (905) 839-9108
www.hubbell-canada.com

Hubbell Products México, S. de R.L. de C.V.
Calle Cinco Sur # 104
Col. Parque Industrial Toluca 2000
C.P. 50200 Toluca, México
Tel.: (722) 265 44 00
www.hubbell.com.mx