

Hubbell® Mobile X-Ray Devices

IP30
SUITABILITY

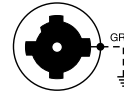

50A 250V AC

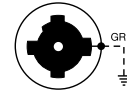

60A 250V AC



HBL25515

Mobile X-Ray Plugs

Description	Catalog Number	
Plug, with epoxy kit, less cord clamp.	HBL25515	HBL25615
Plug, with cord clamp, less epoxy kit.	HBL25525	HBL25625

*Note: Cord clamp range of plugs with cord clamps .830" to 1.3" (21.1 to 33.0).
50A plugs fit 50A or 60A receptacles.*



HBL25615

Mobile X-Ray Receptacles

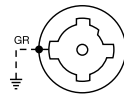

50A 250V AC

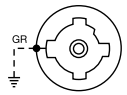

60A 250V AC

Description	Catalog Number	
Receptacle with stainless steel plate assembly.	HBL25505	HBL25605
Receptacle with cast aluminum plate assembly.	HBL25503	HBL25603
Replacement receptacle interior.	—	IN16494

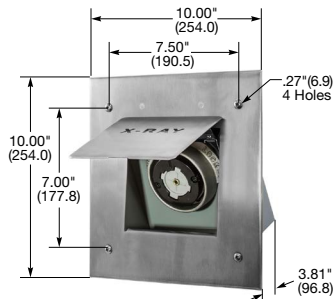

HBL25605

Accessory

Description	Catalog Number
Box stamped steel 8" x 8" x 4" (203.2 x 203.2 x 101.6), accommodates 50A and 60A mobile X-ray receptacles. Knockout sizes 1/4", 1/2" and 2".	HBL25509

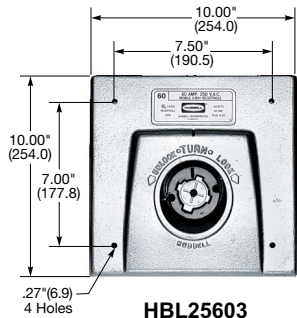

HBL25603

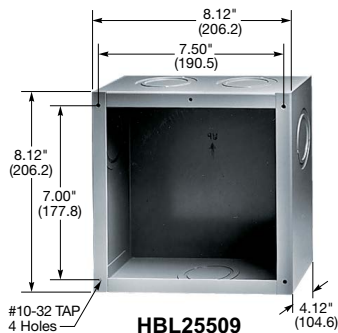

HBL25509

Dimensions in Inches (mm)