



## IMPORTANT SAFEGUARDS

### READ AND FOLLOW ALL SAFETY INSTRUCTIONS

**CAUTION:** The battery in this unit may not be fully charged. After electricity is connected to unit, let battery charge for at least 24 hours, then normal operation of this unit should take effect. To check, press the TEST button. The lamps on the unit should turn on.

**IMPORTANT SAFEGUARDS:** When using electrical equipment, basic safety precautions should always be followed, including the following:

1. Consult local building code for approved wiring and installation.
2. Disconnect AC power before servicing and installation.
3. Do not mount near gas or electric heaters.
4. Do not use outdoors.
5. Do not use this equipment for anything other than its intended use.
6. The use of accessory equipment not recommended by the manufacturer will Void product listing and warranty and may cause an unsafe condition.
7. Any service on this equipment should be performed by qualified personnel only.
8. Equipment should be mounted in locations and at heights where it will not be subject to tampering by unauthorized personnel.
9. Use caution when servicing batteries.
10. Cap unused wires with enclosed wire nuts or other approved method.
11. Make sure wire terminations are secure and leads are properly tucked in appropriate wire channels.

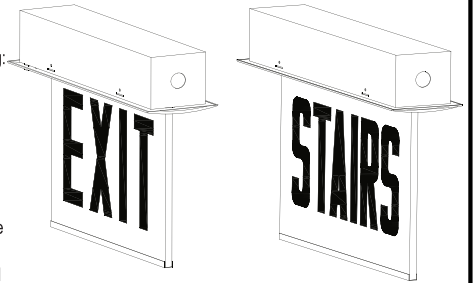

## INSTALLATION

1. Prior to installation, refer to Figure 1 for part identifications.
2. Slide the screw holders into the holes on the unit's housing as shown in Figure 2.
3. Secure the screw holders with the small screws (provided) as shown in Figures 3 and 4a.
4. Position the metal brackets beneath the screw holders and insert the long screws (provided) as shown in Figure 4b. Tighten the screw until the head reaches the screw holder as shown in Figure 4.

**CAUTION: DO NOT TIGHTEN THE SCREWS TO THE POINT WHERE THE BRACKETS START TO EXPAND OUTWARD.**

5. Cut a hole in the ceiling or wall using the template provided. Slide the housing through the ceiling or wall.
6. Once the housing is inside the ceiling or wall, start tightening the long screws and the brackets start to bow out as shown in Figure 5.
7. Connect building supply wires to power supply wires in the metal housing as shown in Figures 6 and 7. For 120V supply connect line wire to the black lead and for 277V supply connect the line wire to the orange/red lead. Connect neutral wire to the white lead. The ground wire (green lead) must be connected in accordance with local codes.

**CAUTION: The unused black or orange/red wire must be capped OFF with wire nut or other approved insulator. Failure to do so may cause an unsafe condition.**

8. Snap together the quick-connector harness, that's between the trim plate assembly and recessed box, to connect the LED board to the transformer (as shown in Figure 8).
9. Connect the battery (EM models) after continuous AC power can be provided to the unit.
10. Secure the trim plate assembly to the recessed box using remaining screws (provided) as shown in Figure 9.

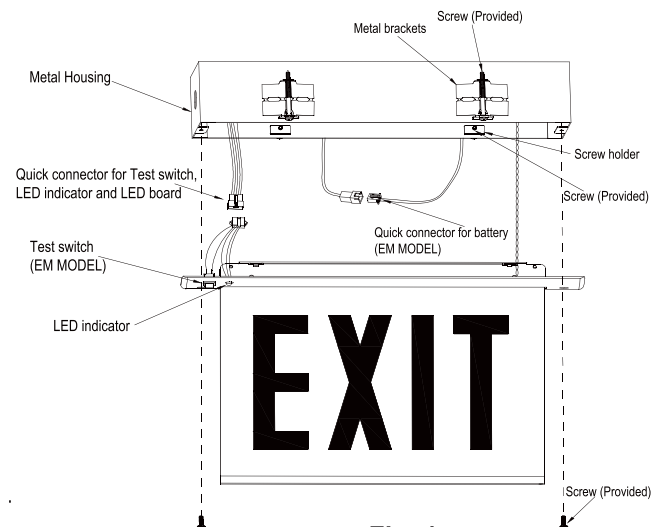

Fig. 1

**TESTING:**

National Electric Code (NEC) and NFPA life safety code regulations require that routine tests need to be performed as listed below: Once every month, the unit needs to be tested for duration of 30 seconds. Push in and hold the test switch to perform this test. Once every 12 months, a full 90 minute (per UL requirements) test needs to be performed on the unit. Disconnect power to the unit and leave it in the emergency mode. The lamps should stay ON for at least 90 minutes.

**TROUBLE - SHOOTING:**

**Condition - The emergency lights do not operate**

1. If the charge indicator light is off: Check that the circuit breaker for AC supply is ON.
2. If the charge indicator light is ON: Check that battery is properly connected. If problem persists, Replace battery.  
If remote lamps are connected to the equipment, then turn OFF the AC supply and disconnect the remote circuit wires from the equipment. Turn ON the AC supply and depress the test switch. If the local lamps (mounted on the equipment itself) come ON, then check the remote circuit for short or overload condition and correct as required. Reconnect the circuit wires and restore AC power.

If the local lamps don't turn ON after disconnecting the remote circuit wires, then replace battery.

**Condition - Emergency lights are dim**

1. Battery not fully charged. Allow battery to recharge for 24 hours and then retest. If lights are still dim, replace battery.

**OPERATION:**

1. Apply AC power to the unit. The LED Indicator should turn RED.
2. After the battery has been left to charge for 2 hours, test the unit by pushing the switch. The LED indicator turns OFF and the lamps on the unit turn ON.
3. When the switch is released, the lamps turn OFF and the LED indicator turns back to RED.

**MAINTENANCE:**

Caution: Always turn off AC power to the equipment before servicing. Servicing should be performed only by a qualified service technician. Use only MANUFACTURER supplied replacement parts.

1. BATTERY: The battery supplied in this equipment requires no maintenance. However, it should be tested periodically (see TESTING) and replaced when it no longer operates the connected fixtures for the duration of a 30-second or 90-minute test. The battery supplied in this equipment has a life expectancy of 5-7 years when used in a normal ambient temperature of 72°F.
2. OTHER: Clean lenses and replace lamps, as and when required.

**WIRING DIAGRAMS:**

NOTE: Unused input lead must be properly insulated with wire nut or other approved method.

**BATTERY BACKUP WIRING DIAGRAM**

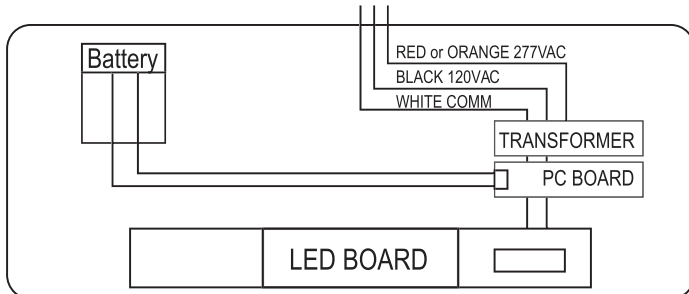

**AC ONLY WIRING DIAGRAM**

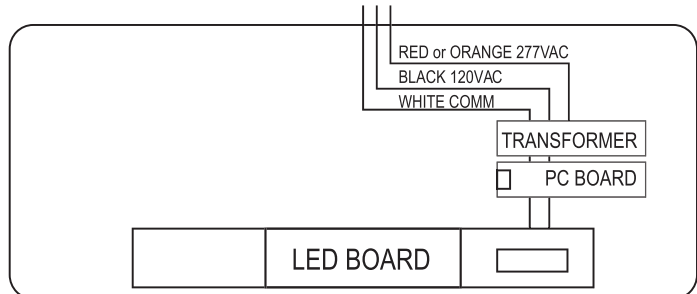

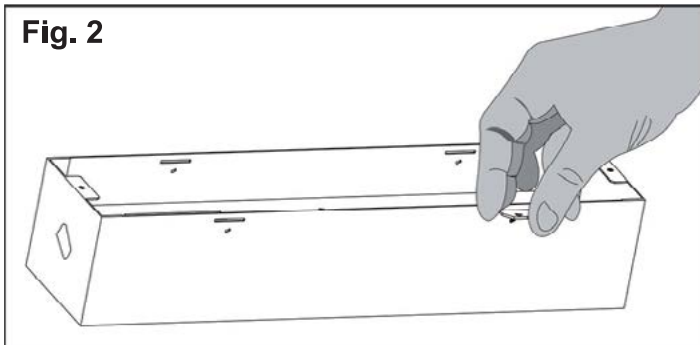

Fig. 2

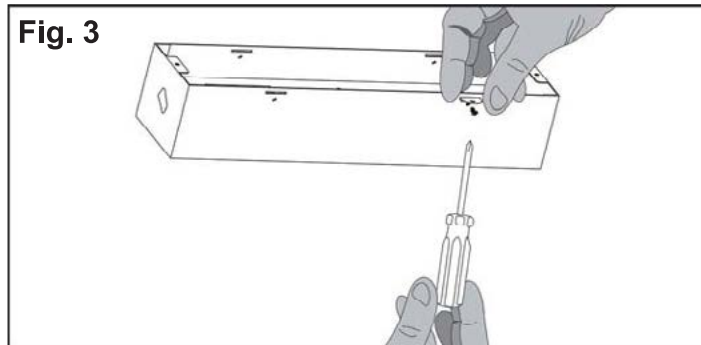

Fig. 3

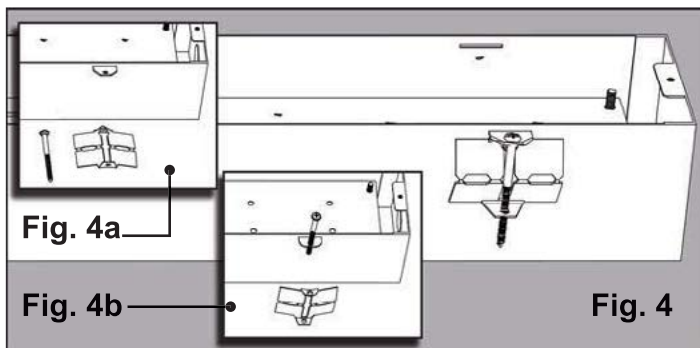

Fig. 4a

Fig. 4b

Fig. 4

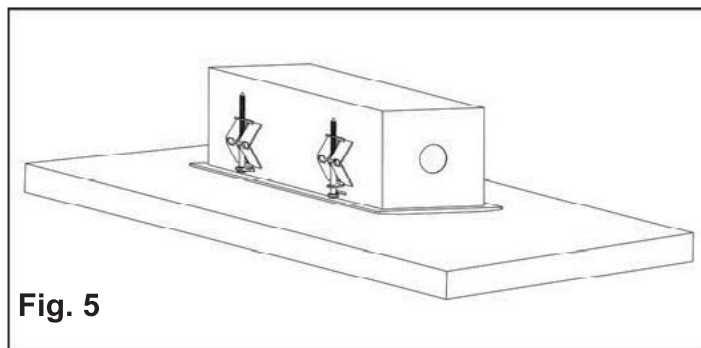

Fig. 5

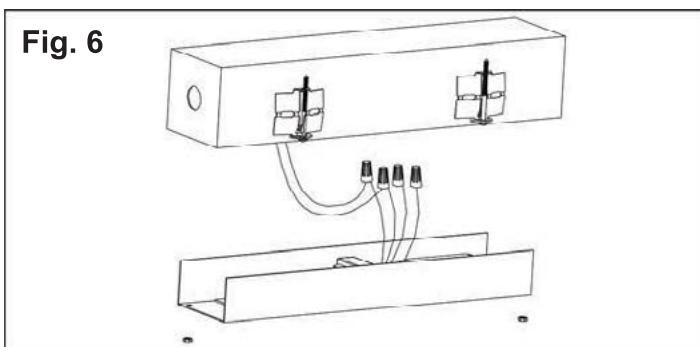

Fig. 6

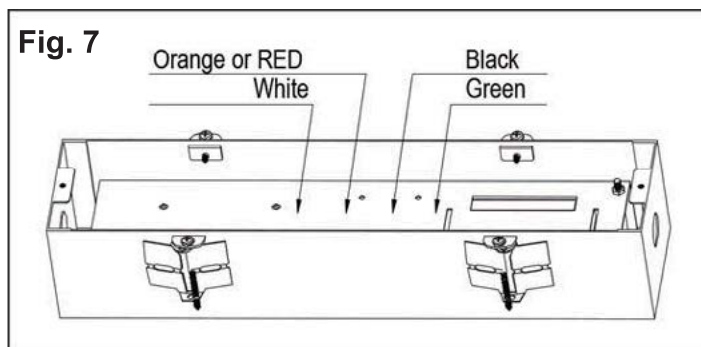

Fig. 7

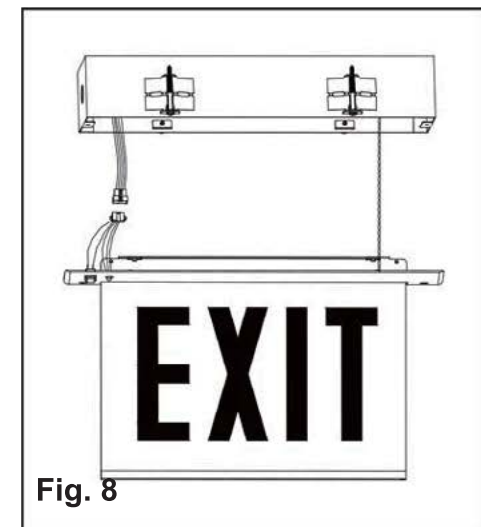

Fig. 8

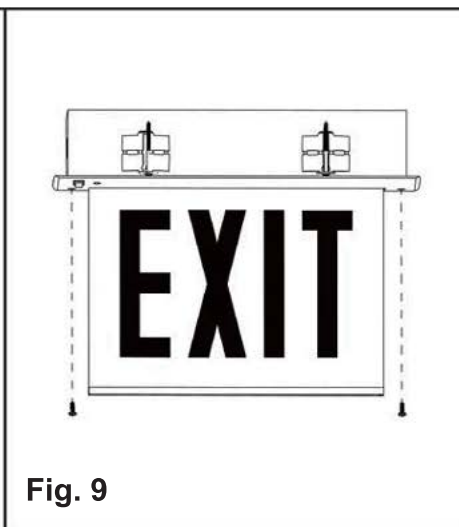

Fig. 9

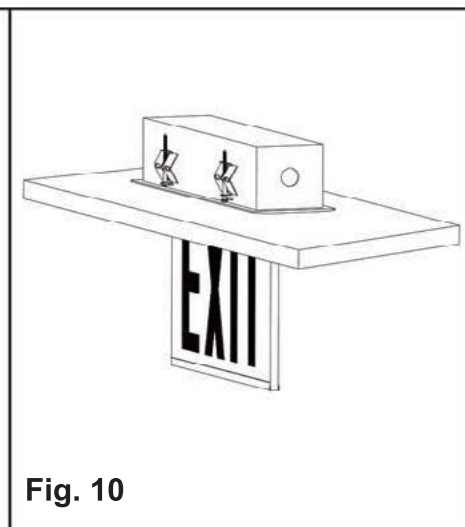



Fig. 10

  
**RECYCLING INFORMATION**  
 All steel, aluminum and thermoplastic parts are recyclable.  
 All cartons contain recycled materials.  
 Please recycle responsibly.

