



CC/CCS17A
CC/CCS21A



CC/CCS17P
CC/CCS21P

CC/CCS Curvilinear Cutoff LED with TIR Strike Optics Installation Instructions

⚠ WARNING: Fixtures must be grounded in accordance with local codes or the National Electrical Code. Failure to do so may result in serious personal injury.

MAINTENANCE: A regularly scheduled maintenance program should be followed to retain optimum light output and reduce heat retention.

CAUTION: All wiring must be done by a qualified electrician. DO NOT operate luminaire with missing or damaged lens.

KEEP THIS SHEET FOR FUTURE REFERENCE.

ARM MOUNT - FIXTURE ATTACHMENT TO POLE:

⚠ Make certain electrical supply is **OFF** before starting installation.

⚠ CAUTION: When fixtures are mounted on round poles, a $\pm 4^\circ$ alignment tolerance can be expected. Before raising pole, be sure fixtures are properly aligned with anchor base and other fixture.

Plan View

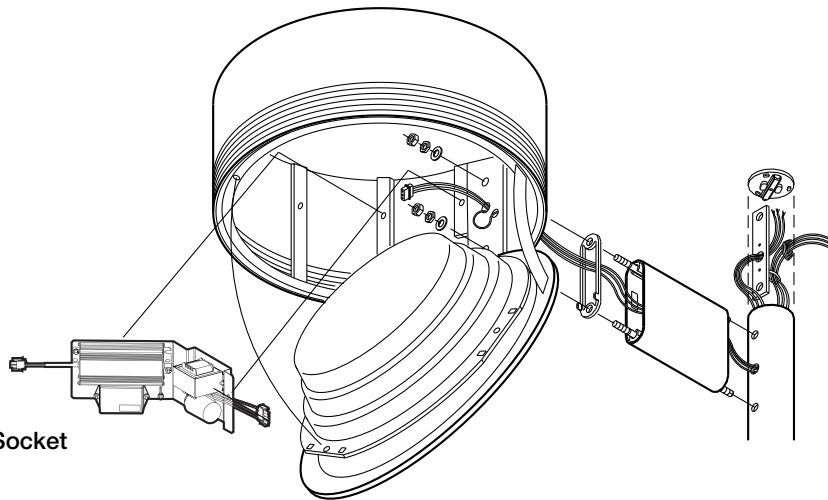
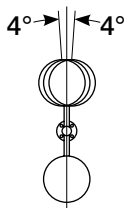

Tools Required:

- Flat Blade Screwdriver
- Torque Wrench
- Ratchet and 2" Extension
- 9/16" 6 or 12 Point Deep Socket



1. Open lens frame by loosening self-retaining 1/4-20 screws; swing lens frame open until the stop arm prevents further movement.

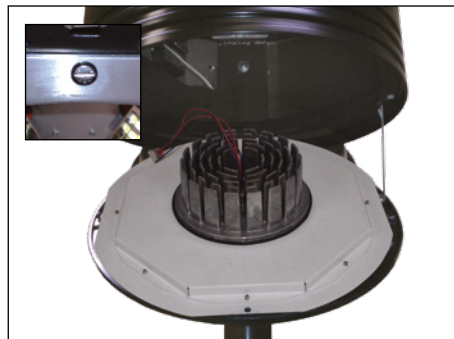

2. Unlatch 1/4-turn faster on bezel assembly. Swing the bezel assembly open. Disconnect all wiring connecting bezel assembly to driver assembly and remove bezel assembly from hinge hanger.

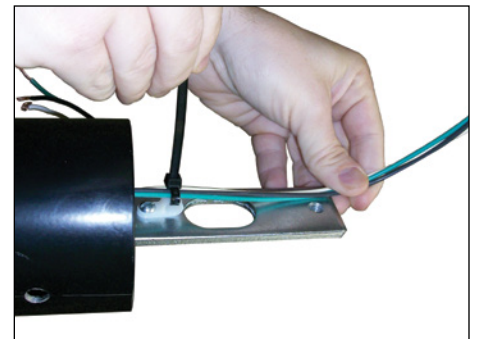

3. Lay pole horizontal on padded supports to protect finish. Pull field wires through pole and out the top. Tie-wrap wires to pole backing plate. Tie field wires in a knot or back loop through tie-wrap. Wire leads need to extend 12" beyond the pole top.

CC/CCS Curvilinear Cutoff LED with TIR Strike Optics Installation Instructions

ARM MOUNT - FIXTURE ATTACHMENT TO POLE Continued:

 Make certain electrical supply is OFF before starting installation.



4. Insert pole-backing plate through top of pole. Align three holes in pole with matching holes in backing plate. Insert both draw bolts into pole holes and thread draw bolts into the backing plate.

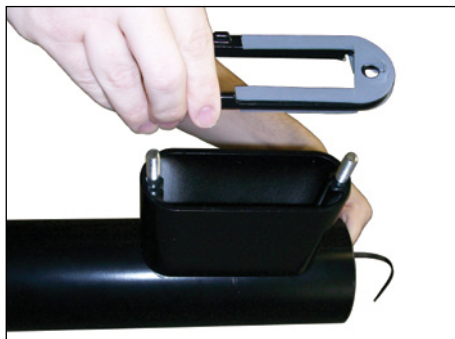

5. Slide support arm, arm spacer, and gasket over draw bolts. NOTE: Arm will have a circular end to fit a round pole.

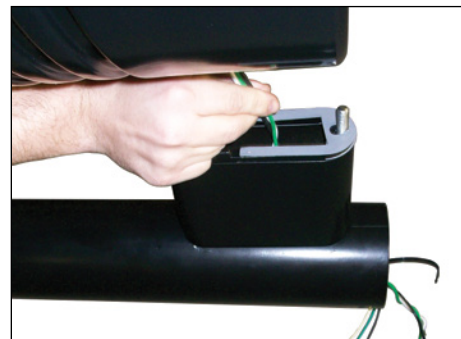

6. Insert fixture wire leads through wire-way hole while lowering and attaching fixture onto support arm. Pull fixture wire leads out of pole top.

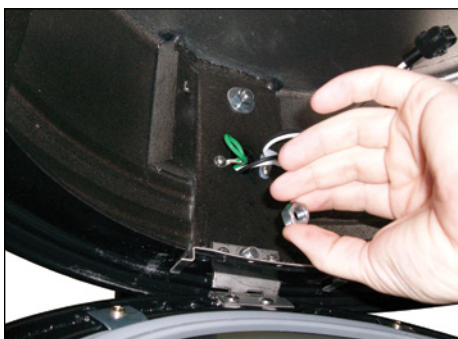

7. Fit one washer and jam nut onto each draw bolt, but do not tighten. Square the fixture carefully to the pole; tighten jam nuts. Attach securing nuts with a minimum of 15-20 ft lbs torque to all nuts. If fixture is not level after pole is erected, loosen all four nuts. Re-tighten nuts after final leveling using the above procedure.



8. Connect field wire leads to fixture leads observing polarity, i.e., green-to-ground, white-to-common, and black-to-voltage.

POST TOP TENON MOUNT - FIXTURE ATTACHMENT TO POLE:

 Make certain electrical supply is OFF before starting installation.

Tools Required:

- Flat Blade Screwdriver
- Torque Wrench
- Ratchet and 2" Extension
- 9/16" 6 or 12 Point Deep Socket
- 3/16" Hex Wrench
- Drill with 3/16" Drill Bit
(for slipfitter and direct mount)

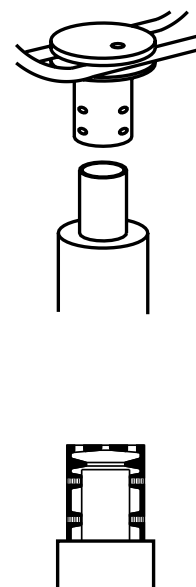
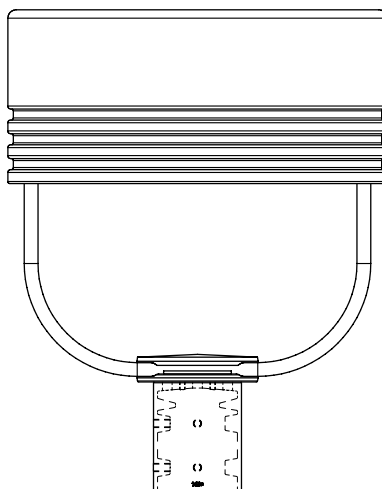

CC/CCS Curvilinear Cutoff LED with TIR Strike Optics Installation Instructions

FLUSH MOUNT - FIXTURE ATTACHMENT TO POLE Continued:

 Make certain electrical supply is OFF before starting installation.

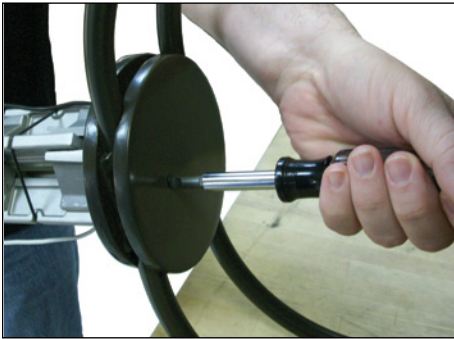

1. A wiring chamber is included at the center of the lens frame. Remove the splice cover by loosening the self-retaining screw; pull the fixture wires out into the clear area.

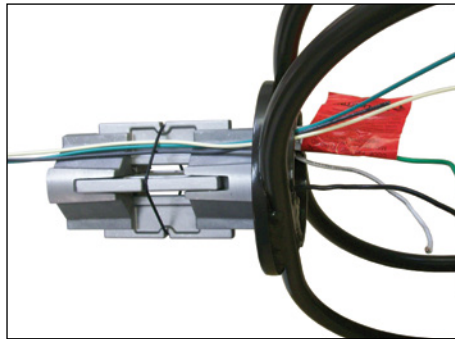

2. Feed pole wire leads going inside the spreader retainer springs and up through the holes into the wire chamber and out the chamber mouth. Connect field wire leads to fixture leads observing polarity, i.e., ground-to-green, white-to-common, and black-to-voltage.

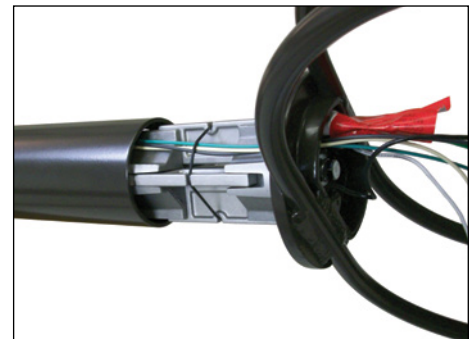

3. Lay pole horizontal on padded supports to protect finish. Fish the attached drop leads to the pole hand-hole keeping tension so they aren't caught or pinched. Pick up the fixture and slide the spreader assembly into the pole top. Block the fixture into place. Orient fixture according to light pattern label in reflector. Make sure fixture is square with pole.



4. Tighten the center bolt to 25 foot-pounds torque. When tight, push the connected wire ends back into the chamber and replace the splice cover.

CC/CCS Curvilinear Cutoff LED with TIR Strike Optics Installation Instructions

0-10V Dimming

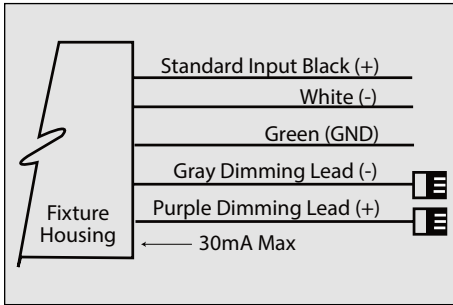

Driver has a 0-10V dimming interface with a dimming range of 10-100%. Is compatible with most control systems including Hubbell Building Automation wiHUBB™. Approved dimmers include Lutron Diva AVTV, Lutron Nova NFTV and NTFTV. Note: Not compatible with current sourcing dimmers. Controls compatible via Gray and Purple dimming lead.

LUMINAIRE MAINTENANCE:

 Make certain electrical supply is **OFF** before starting installation.

Luminaire, Finish, and Mounting:

A regularly scheduled maintenance program should be established to insure paint coating is intact, corrosion or structural damage has not occurred, and all mounting arms, rods, nuts, and bolts are tight. Failure to do so could lead to damage or serious personal injury.

EmitterDeck and Lens Cleaning:

A regularly scheduled maintenance program should be established to retain optimum light output and reduce heat retention. Dusting with a dry, soft, cloth is normally sufficient for the reflectors. Any accumulation of dust or dirt should be removed regularly from both sides of the housing and lens using ammonia water. **DO NOT use alkaline or acid cleaners.**

UPGRADE KIT WARRANTY
See [HLI Standard Warranty](#) for additional information