



**KIM LIGHTING**

16555 East Gale Avenue  
City of Industry, CA 91745-1788  
626/968-5666 • FAX 626/968-5716



**BNB1 LED**



**HUBBELL**  
Lighting

## BNB1-LED Bounce Bollard LED Replacement Kit Instructions

**WARNING:** Fixtures must be grounded in accordance with local codes or the National Electrical Code. Failure to do so may result in serious personal injury.

**NOTE:** All wiring must be done by a qualified electrician.

**REMARQUE:** Tout le câblage doit être fait par un électricien certifié.

**KEEP THIS SHEET FOR FUTURE REFERENCE.**

### Parts List:

LED Kit (includes driver and LED modules)

### Tools Required:

- Flathead screwdriver
- Phillips screwdriver
- 9/16" Wrench
- 5/32" Allen Wrench
- Drive Ratchet
- 9/16" Deep Socket
- 1/8" Allen Wrench
- 3/16" Allen Wrench
- 6" Extension

**!** Make certain electrical supply is **OFF** before replacing LED components.

**!** Assurez-vous que l'alimentation électrique est éteint avant de remplacer des composants LED.

1. Loosen 1/4-20 captive screw and swing hinged hood open
2. Unscrew (4) 10-32 screws to remove LED bracket.
3. Disconnect LED assembly wiring from push-in connectors.
4. Install replacement LED bracket. Reconnect LED assembly wiring to push-in connectors connected to electronic driver wiring.
5. Loose (2) 10-32 screws to remove hub cover.
6. Remove mounting rod hex nuts and slide top tube support, extrusion body, bottom tube support, riser and fixture base from mounting rods.
7. Disconnect driver wiring harness from LED bracket wiring and line voltage.
8. Remove screws holding electronic driver assembly to base plate and swap out with replacement electronic driver assembly.
9. Reverse steps to reassemble bollard.

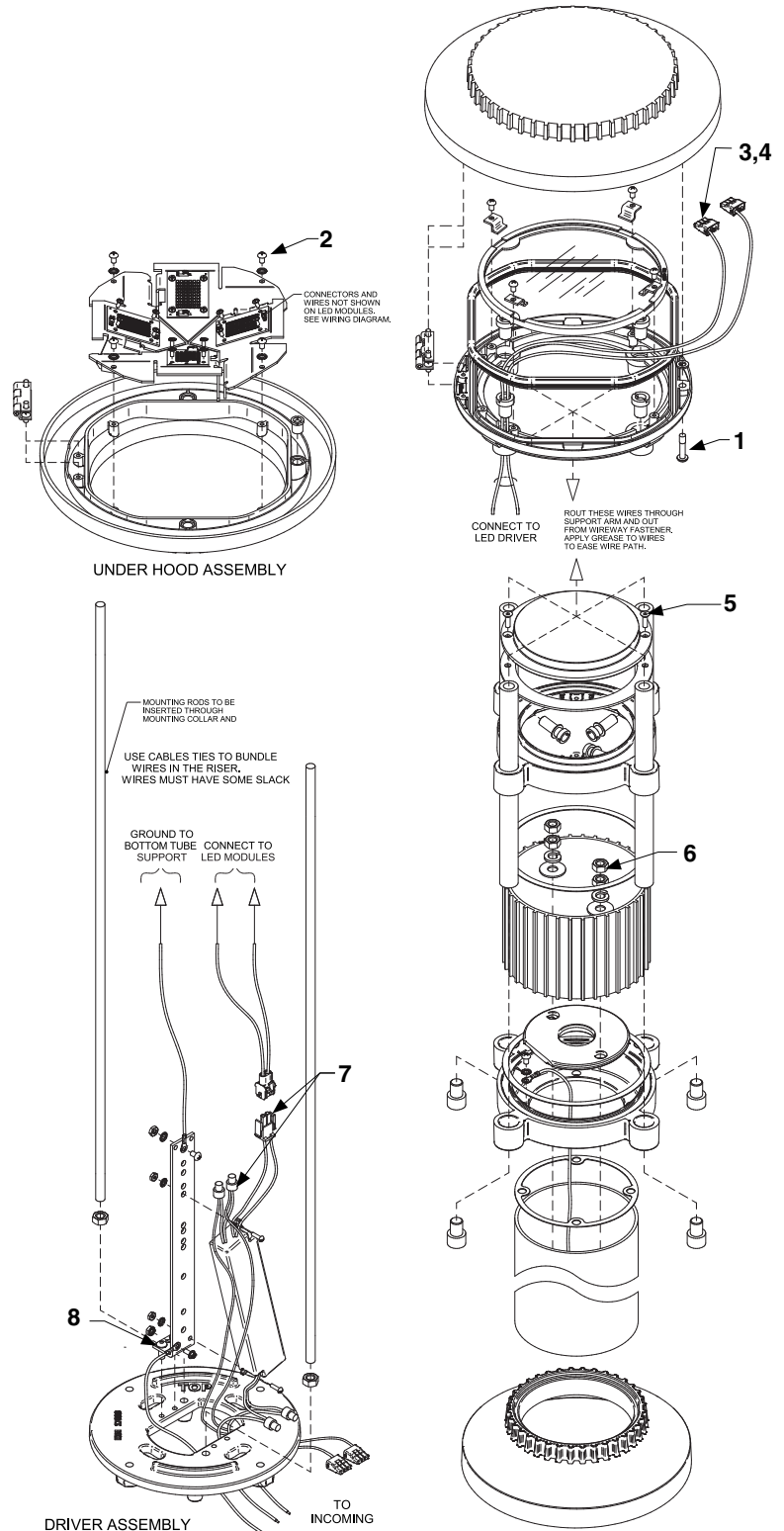

# BNB1-LED Bounce Bollard LED Replacement Kit Instructions

## WIRING DIAGRAM

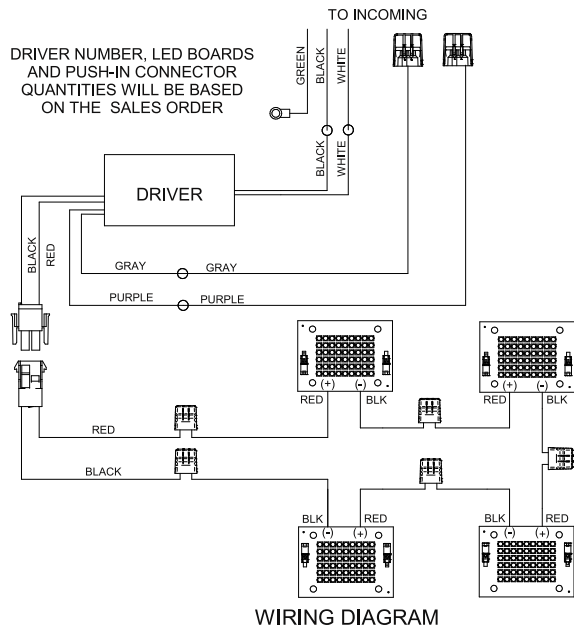

### 0-10V Dimming

Driver has a 0-10V dimming interface with a dimming range of 10-100%. Is compatible with most control systems including Hubbell Building Automation wiHUBB™. Approved dimmers include Lutron Diva AVTV, Lutron Nova NFTV and NTFTV. Note: Not compatible with current sourcing dimmers. Controls compatible via Gray and Purple dimming lead.

### Battery Backup

If your fixture includes Battery Backup Option, an additional power wire is included labeled "Unswitched Power". This lead must be connected to an unswitched power source running 120-277 VAC to function properly.

# BNB1-LED Bounce Bollard LED Replacement Kit Instructions

## Installation warnings and cautions for upgrade kits

Avertissements et précautions pour l'installation de kits de mise à niveau.

 **WARNING:** Make certain all electrical supply is OFF before starting installation or beginning maintenance procedures.

 **AVERTISSEMENT:** S'assurer que toute alimentation possible est COUPÉE avant de commencer l'installation ou l'entretien.

 **WARNING:** Fixtures must be grounded in accordance with local codes or the National Electrical Code. Failure to do so may result in serious personal injury.

 **AVERTISSEMENT:** Les appareils doivent être mis à la terre en conformité avec le Code canadien de l'électricité et les codes locaux. Une non-conformité pourrait conduire à des blessures graves.

 **WARNING:** To prevent wiring damage or abrasion, do not expose wiring to edges of sheet metal or other sharp objects.

 **AVERTISSEMENT:** Pour empêcher l'endommagement ou l'éraflure des fils, empêchez tout contact avec les rebords des parties métalliques.

 **MAINTENANCE:** A regularly scheduled maintenance program should be established to retain optimum light output and reduce heat retention. Dusting with a soft, clean, dry cloth is normally sufficient for the reflector.

 **ENTRETIEN:** Un programme d'entretien régulier devrait être établi pour conserver la luminosité optimale et réduire l'accumulation de chaleur. Un chiffon doux et propre est normalement suffisant pour dépoussiérer le réflecteur optique.

 **NOTE:** All wiring must be done by a qualified electrician.

 **REMARQUE:** Tout le câblage doit être fait par un électricien certifié.

 **CAUTION:** LED fixtures are available in 120 volt input or 277 volt input. Please verify before wiring fixture to field wires. (see lamp label to verify).

 **MISE EN GARDE:** Les appareils d'éclairage à DEL sont offerts pour alimentation à 120 V ou 277 V. Veuillez vérifier avant de raccorder (voir l'étiquette de l'appareil pour confirmer).

 **WARNING: RISK OF FIRE OR ELECTRICAL SHOCK.** Install this kit only in the luminaires that have the construction features and dimensions shown in the photographs and/or drawings. Luminaires wiring, power supply, or other electrical parts may be damaged when drilling for installation of retrofit assembly hardware. Inspect all wiring and components for damage.

 **AVERTISSEMENT: DANGER DE CHOC ÉLECTRIQUE OU D'INCENDIE.** N'installez cette trousse que sur les luminaires qui sont construits pour l'accepter et qui ont les dimensions montrées sur les photographies et/ou dessins. Il y

a risque d'endommagement du câblage, du bloc d'alimentation ou d'autres parties lors du perçage pour installer la quincaillerie pour modification. Vérifiez qu'aucun dommage aux fils ou composants n'a été fait.

 **CAUTION:** Unless otherwise specified, do not make or alter any openings in the compartment of wiring or electrical components during installation of this retrofit assembly. Plug all unused openings in the compartment of wiring or electrical components.

 **ATTENTION:** Pour cette modification, ne pas percer ou modifier toute ouverture du compartiment de connexion des câbles ou celui des composants électriques sauf si clairement indiqué dans une autre directive. Bouchez toutes les ouvertures du compartiment de connexion ou des composants électriques qui ne sont pas utilisées.

 **CAUTION:** Only the holes indicated in the photographs and/or drawings may be made or altered as a result of kit installation. Do not leave any other open holes in an enclosure of wiring or electrical components.

 **ATTENTION:** Seuls les trous indiqués dans les photographies et/ou les dessins peuvent être percés ou modifiés pour installer la présente tousse. Les compartiments de connexion ou des composants électriques ne doivent comprendre aucune ouverture non obstruée autre que celles requises au câblage.

 **CAUTION:** Installation of this retrofit assembly requires a person familiar with the construction and operation of LED luminaire electrical systems and the hazards involved

 **ATTENTION:** installation de ce nécessaire de modernisation a une personne connaissant la construction et le fonctionnement des installations d'éclairage fluorescent et consciente des risques qu'elles comportent.

 **CAUTION:** Do not alter, relocate, or remove wiring, lampholders, ballasts, or any other electrical components.

 **ATTENTION:** Ne pas modifier, déplacer ni enlever de câble, de douille de lampe, de ballast ou autre composant électrique.

 **WARNING:** The H.I.D./Fluorescent fixtures utilizes a lamp that may contain mercury. For information on disposal of lamp go to website: [www.lamprecycle.org](http://www.lamprecycle.org).

 **AVERTISSEMENT:** Les appareils d'éclairage à décharge à haute intensité ou à fluorescents peuvent contenir du mercure. Pour l'information de disposition des ampoules/tubes, visitez le site Web: [www.lamprecycle.org](http://www.lamprecycle.org).

**CONSERVER LA PRÉSENTE FEUILLE POUR RÉFÉRENCE ULTÉRIEURE.**

**KEEP THIS SHEET FOR FUTURE REFERENCE.**



**KIM LIGHTING**



**HUBBELL  
Lighting**