



KIM LIGHTING

P.O. Box 60080 • 16555 East Gale Ave.
City of Industry, California 91716-0080
626/968-5666 • FAX 626/330-3861



W30H



WF31H



W32H

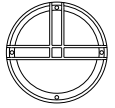

WF33H

WALL FORMS® Round - WF30H Series Installation Instructions

WARNING: Fixtures must be grounded in accordance with local codes or the National Electrical Code. Failure to do so may result in serious personal injury.

CAUTION: Use only the lamp type and watts shown on the fixture label on the electrical assembly. The fixture label must indicate the same electrical data as the ballast label. **KEEP THIS SHEET FOR FUTURE REFERENCE.**

IMPORTANT! All "H" recessed models (for hollow stud walls) are supplied with an insulation detector (HID and Incandescent). No insulation is permitted above the housing or within 3" of sides and bottom. Detector will cut power if fixture overheats due to insulation.

Tools Required: Flat Blade Screwdriver 1/8" Allen Wrench Silicone Grease

ELECTRICAL ASSEMBLY INSTALLATION: Make sure electrical supply is **OFF** before installing equipment.

1. Remove fiberboard cover from front of housing. The cover and the screws may be discarded.
2. Remove the three (3) mounting screws from the bosses around the inside perimeter of the housing.
3. Connect quick disconnect plug assemblies.
4. Install the electrical assembly into the housing. Make certain no wires are pinched within the fixture and install mounting screws.

LAMP INSTALLATION: Make sure electricity is **OFF** before installing lamp.

1. Screw the proper lamp (as per fixture label) into the socket and tighten the lamp sufficiently to ensure a vibration safe installation. L.E.D. if offered in 15W or 30W.

DIFFUSER FRAME ASSEMBLY INSTALLATION:

1. Check that the flange area of the housing is clean and free of any concrete or paint build-up. Make sure there is no dirt in the four (4) screw holes on the inside of the circular flange.
2. Before installing the diffuser frame assembly, always coat the four 10-32 captive screws with silicone grease.
3. Install the diffuser frame assembly by tightening the four screws progressively and evenly to insure even gasket seating around the frame.

DO NOT exceed 20 in-pounds torque on these screws.

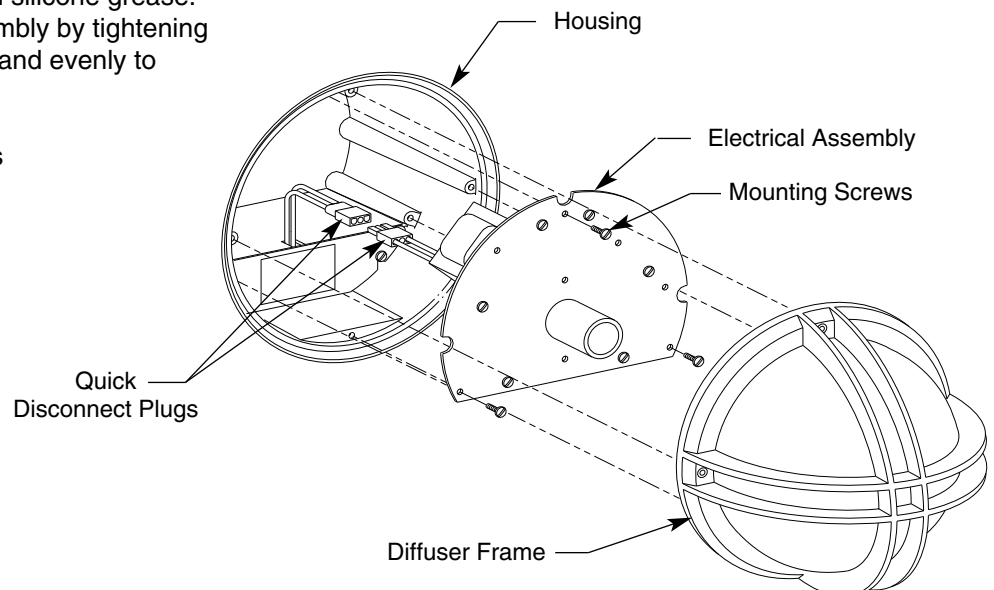

Wall Forms® Round - WF30H Series Installation Instructions

MAINTENANCE  Make certain electricity is **OFF**.

1. To replace lamp, proceed as follows:
 - a. Remove diffuser frame assembly.
 - b. Replace lamp with type and wattage shown on fixture label.
 - c. Clean lens and diffuser frame gasket.
 - d. Coat diffuser frame screws with silicone grease and install diffuser frame assembly. Tighten the four screws progressively and evenly to insure even gasket sealing around the frame. **Do not** exceed 20 in-pound torque on these screws.

2. To replace electrical assembly, proceed as follows:

 Make certain electricity is **OFF**.

- a. Remove diffuser frame assembly and lamp.
- b. Loosen the three (3) mounting screws securing electrical assembly to housing. Remove electrical assembly and unplug quick disconnect plug assemblies.
- c. If ballast type and/or watts are not the same as replaced equipment, mark fixture label in housing to correspond with new ballast information.
- d. Connect quick disconnect plug assemblies.
- e. Install the electrical assembly into the housing & tighten screws.
- f. Screw the proper lamp (as per fixture label) into the socket and tighten the lamp sufficiently to ensure a vibration safe installation.
- g. Clean lens and diffuser frame gasket.
- h. Coat diffuser frame screws with silicone grease and install door frame assembly. Tighten the four screws progressively and evenly to insure even gasket seating around frame. **Do not** exceed 20 in-pounds torque on these screws.

WARNING:

This H.I.D. / Fluorescent fixture utilizes a lamp that may contain mercury. For information on disposal of lamp, go to website: www.lamprecycle.org

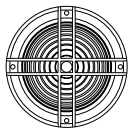

WF 30

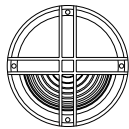

WF 31

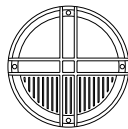

WF 32

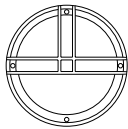

WF 33

REPLACEMENT PARTS LIST

Cat. No.	Diffuser Type	Diffuser Part No.	Diffuser Gasket	*Diffuser Frame Assy.
WF30	Smooth Prism	84133	82291	85625
		84136		85626
WF31	Smooth Prism	84133	82291	85627
		84136		85628
WF32	Diffused	84140	82302	85629
WF33	Diffused	84141	82302	85630

***NOTE:** When ordering a diffuser frame give model and finish i.e., WF32/BL-P

KIM LIGHTING LIMITED WARRANTY

When installed in accordance with Kim Installation Instructions and accepted trade practices, the following shall apply:

General Product Limited Warranty Coverage

All material and component parts used in the manufacture of Kim Products, are warranted to be free from defects of material and/or workmanship for a period of 1 year from date of sale, with the following exceptions:

Auxiliary Equipment

All auxiliary equipment (such as lamps, ballasts, and transformers) provided by and/or included in Kim Products shall carry the component manufacturer's warranty.

Copper and Bronze Landscape Components

Copper and Bronze Landscape fixture components shall be warranted against defects of material and/or workmanship, and failure due to corrosion, for a period of 25 years from date of sale.

Composite In-Grade Components

Composite In-Grade fixture components installed below grade, shall be warranted against defects of material and/or workmanship, and failure due to corrosion for a period of 7 years from date of sale.

Aluminum Landscape Components

Aluminum Landscape fixture components not in direct contact with soil, shall be warranted from defects of material and/or workmanship for a period of 3 years from date of sale. Aluminum fixture components in direct contact with soil shall be warranted from defects of material and failure from corrosion for a period of 1 year from date of sale.

Limit of Liability and General Conditions

Only products which are installed, used and maintained in accordance with applicable Kim instructions, specifications and accepted trade practices, are covered by the Kim Warranty. During the warranty period, with proof of purchase, Kim will repair or replace with the same or similar product, at Kim's option, without charge. Labor costs are the owner's responsibility and are excluded from this warranty. This warranty is void if the product is modified, tampered with, misapplied, poorly installed, improperly maintained, or subjected to abnormal conditions.

Repair or replacement as provided under this warranty is the exclusive remedy of the purchaser. This warranty is in lieu of all other warranties, expressed or implied, including any implied warranty of fitness for a particular application. Kim Lighting shall not be liable to the purchaser for indirect or consequential damages.



How may we serve you better?
Please let us know. Visit our website at:
www.kimlighting.com
Your concerns are important to us.