



Compact Flood Options Barn Doors / Fixed Hood / Full Shield Installation instructions

⚠ WARNING: Fixtures must be grounded in accordance with local codes or the National Electrical Code. Failure to do so may result in serious personal injury.

KEEP THIS SHEET FOR FUTURE REFERENCE.

BARN DOORS / BD-CFL INSTALLATION INSTRUCTIONS:

Tools Required: 7/16" Allen Wrench

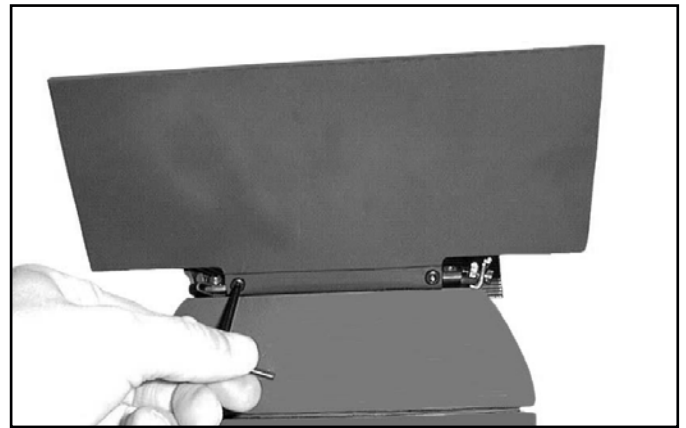
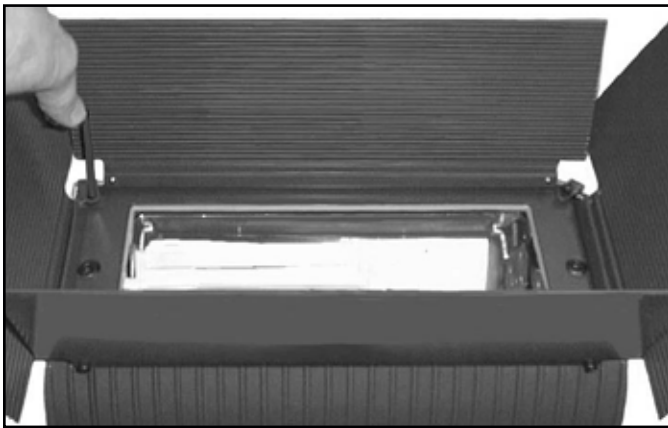

Mounting Instructions:

1. Install barn door assembly with four 6-32 x 3/8" mounting screws into the pre-tapped holes located on the Compact Flood lens frame.

Adjusting Barn Doors:

1. Loosen the two 6-32 x 1/4" adjusting screws on the door to be adjusted. Move door to desired angle and tighten screws.

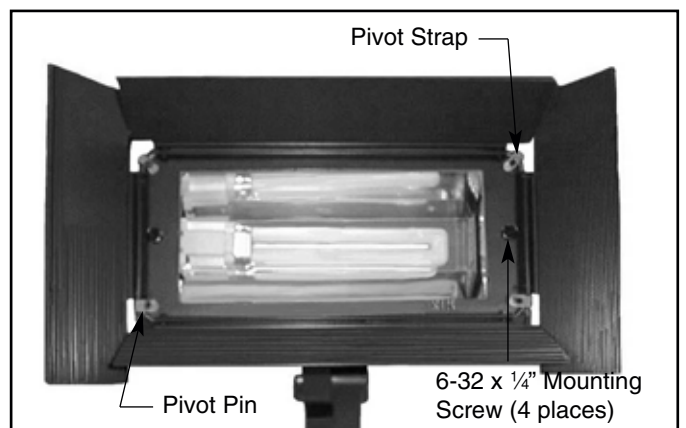
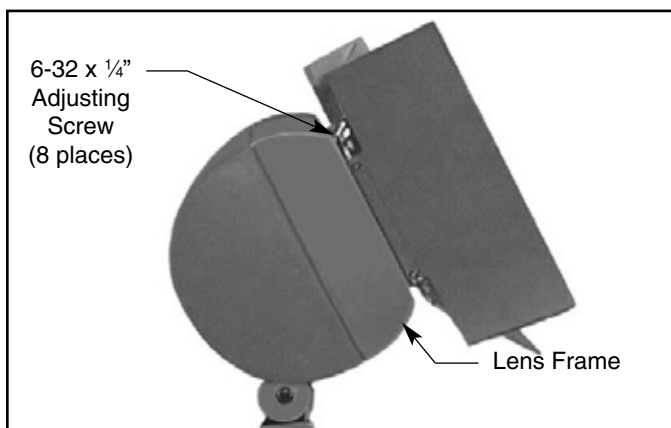

Removing Barn Door(s) From Assembly:

1. Loosen the two 6-32 x 1/4" adjusting screws on door to be removed and loosen one screw from each adjacent door.
2. Using care not to distort pivot pins, gently pull on door until it comes free.
3. Replace pivot pins and pivot straps in adjacent doors.
4. Reattach barn door assembly to Compact Flood lens frame (see "Mounting Instructions" above).

Note: Barn doors can be installed with lens frame on or off the fixture.

Compact Flood Options / Barn Doors / Fixed Hood / Full Shield Installation Instructions

Fixed Hood / FH-CFL Installation Instructions:

Tools Required: Flat Blade Screwdriver

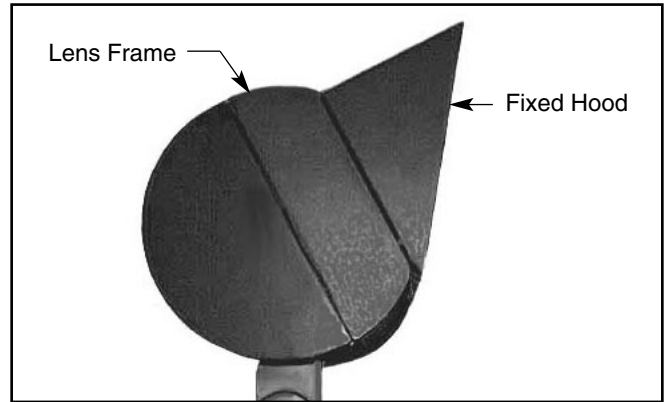

1. Install Fixed Hood with four 6-32 x $\frac{3}{16}$ " mounting screws to the pre-tapped holes located on the Compact Flood lens frame.

NOTE: Fixed Hood can be installed with lens frame on or off the fixture.

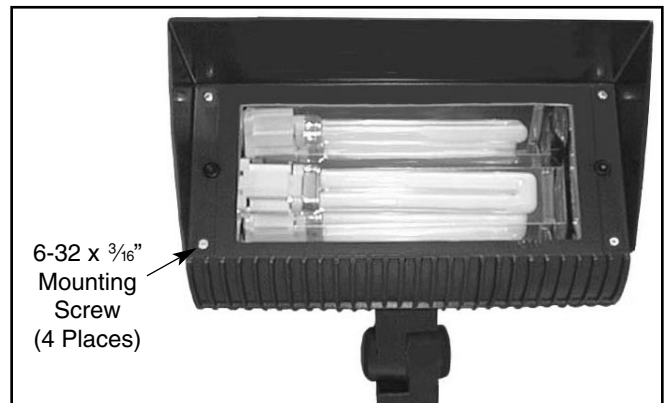

Full Shield / FS-CFL Installation Instructions:

Tool Required: Flat Blade Screwdriver

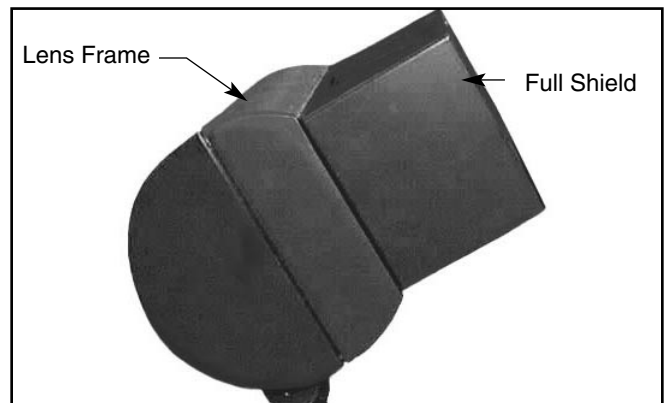

1. Install Full Shield with four 6-32 x $\frac{3}{16}$ " mounting screws to the pre-tapped holes located on the Compact Flood lens frame.

NOTE: Full Shield can be installed with lens frame on or off the fixture.

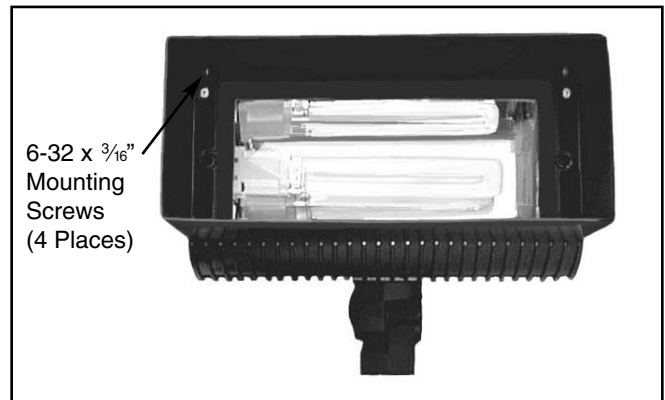

Compact Flood Options / Barn Doors / Fixed Hood / Full Shield Installation Instructions

KIM LIGHTING LIMITED WARRANTY

When installed in accordance with Kim Installation Instructions and accepted trade practices, the follow shall apply:

General Product Limited Warranty Coverage

All material and component parts used in the manufacture of Kim Products, are warranted to be free from defects of material and/or workmanship for a period of 1 year from date of sale, with the following exceptions:

Auxiliary Equipment

All auxiliary equipment (such as lamps, ballasts, and transformers) provided by and/or included in Kim Products shall carry the component manufacturer's warranty.

Copper and Bronze Landscape Components

Copper and Bronze Landscape fixture components shall be warranted against defects of material and/or workmanship, and failure due to corrosion, for a period of 25 years from date of sale.

Composite In-Grade Components

Composite In-Grade fixture components installed below grade, shall be warranted against defects of material and/or workmanship, and failure due to corrosion, for a period of 7 years from date of sale.

Aluminum Landscape Components

Aluminum Landscape fixture components not in direct contact with soil, shall be warranted against defects of material and/or workmanship for a period of 3 years from date of sale. Aluminum fixture components in direct contact with soil shall be warranted from defects of material and failure from corrosion for a period of 1 year from date of sale.

Limit of Liability and General Conditions

Only products which are installed, used and maintained in accordance with applicable Kim instructions, specifications and accepted trade practices, are covered by the Kim Warranty. During the warranty period, with proof of purchase, Kim will repair or replace with the same or similar product, at Kim's option, without charge. Labor costs are the owner's responsibility and are excluded from this warranty. This warranty is void if the product is modified, tampered with, misapplied, poorly installed, improperly maintained, or subjected to abnormal conditions.

Repair or replacement as provided under this warranty is the exclusive remedy of the purchaser. This warranty is in lieu of all other warranties, expressed or implied, including any implied warranty of fitness for a particular application. Kim Lighting shall not be liable to the purchaser for indirect or consequential damages.



How may we serve you better?
Please let us know. Visit our website at:
www.kimlighting.com
Your input matters to us.