



IMPORTANT SAFEGUARDS

When using electrical equipment, basic safety precautions should always be followed including the following.

READ AND FOLLOW ALL SAFETY INSTRUCTIONS

1. Review the diagrams thoroughly before beginning. If you feel you do not have electrical wiring experience, refer to a do-it-yourself wiring handbook or have your fixture installed by a qualified licensed electrician.
2. All electrical connections must be in accordance with local codes, ordinances, and the National Electric Code. If you are unfamiliar with methods from installing electrical wiring, secure the services from a qualified licensed electrician.
3. Before starting the installation, disconnect the power by turning off the circuit breaker or by removing the appropriate fuse at the fuse box. Using the light switch to turn off power is not sufficient to prevent electrical shock.
4. Do not use outdoors
5. Do not let power supply cords touch hot surfaces
6. Do not mount near gas or electric heaters
7. Use caution when servicing batteries. Battery acid can cause burns to skin and eyes. If acid is spilled on skin or eyes, flush acid with fresh water and contact a physician immediately
8. Equipment should be mounted in locations and at heights where it will not be subjected to tampering by unauthorized personnel.
9. The use of accessory equipment not recommended by the manufacturer may cause an unsafe condition
10. Do not use this equipment for other than its intended use
11. All servicing should be performed by qualified personnel only
12. Allow battery to charge for 24 hours before first use
13. Test cycling: the Life Safety Code (NFPA 101) requires testing of emergency lighting units once a month for a minimum of 30 seconds, and once a year for a minimum of 90 minutes

INSTALLER:

- SEE UNIT LABEL FOR ADDITIONAL MODEL SPECIFICATIONS
- SAVE THESE INSTRUCTIONS FOR USE BY OWNER/OCCUPANT



RECYCLING INFORMATION

All steel, aluminum and thermoplastic parts are recyclable.
 NOTICE: Emergency units contain rechargeable batteries which must be recycled or disposed of properly.

Hubbell Lighting, Inc. Life Safety Products • www.dual-lite.com

Copyright© Hubbell Lighting, Inc., All Rights Reserved • Specifications subject to change without notice. • Printed in U.S.A.

COMP0003_EM_INST_SHT 5/20



PACKAGE CONTENTS

Part	Description	Quantity
1	LED Edge-Lit EXIT Sign	1
2	Adjust Bracket and Bar hanger	2
3	Hardware Bag	1

WARNING – This product contains chemicals known to the State of California to cause cancer, birth defects and/or other reproductive harm. Thoroughly wash hands after installing, handling, cleaning, or otherwise touching this product.

Before Installation

ELECTRICAL CONNECTIONS

1. If using 120VAC, connect the black and white wires to the building utility
2. If using 277VAC, connect the orange and white wires to the building utility
3. Connect ground wires to building utility.
4. Cap off unused wires. In all cases use standard wire nuts in connection to wires

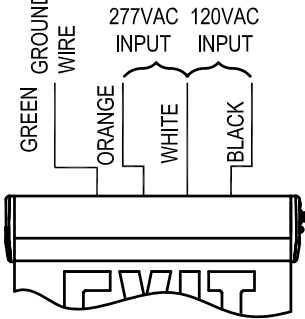

DETERMINE DIRECTIONS

5. If indicator chevron is required, leave chevron and remove locator template.
6. If indicator chevron is not required, remove both the chevron and locator template.



NOTICE: MUST WEAR GLOVES FOR ALL INSTALLATION PROCESSES

INSTALLATION

NOTE: FIRST TURN OFF ELECTRICITY
RECESSED CEILING MOUNTING

1. Use screwdriver to open front cover and connect battery connector, feed AC wires out of housing.
3. Unscrew and remove trim plate from metal box, fix test switch and LED bushing on the trim plate

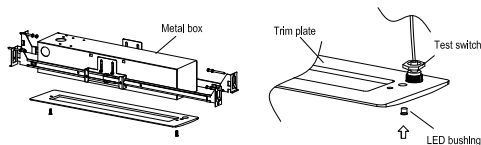
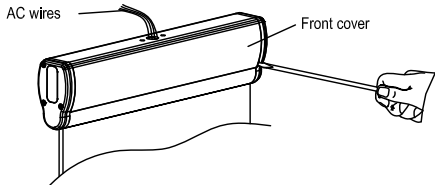

2. Unscrew and remove test switch side end cap, disconnect test switch connector, remove test switch and LED indicator and bushing from end cap, feed test switch and LED indicator wire out of end cap, replace end cap on housing by screws.
4. Position recessed kits and bar hangers between joists. Make sure bar hangers are hung in the correct position. Position recessed kits temporarily by hammering "nail-in" tabs on bar hangers, then secure permanently with nails. Bar hangers should be level with bottom of joists

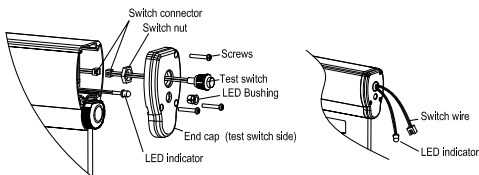

INSTALLATION

5. Adjust height of recessed kits vertically using adjusting slots and then tightening all screws on adjusting slots and bar hanger bracket to secure adjusting bracket and bar hangers

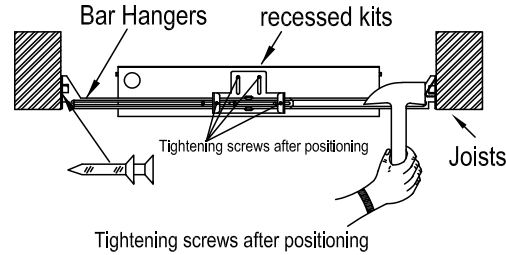

6. Make proper electrical connections at J-box in the metal housing, refer to "ELECTRICAL CONNECTIONS" You may need to use holding wire during wiring.

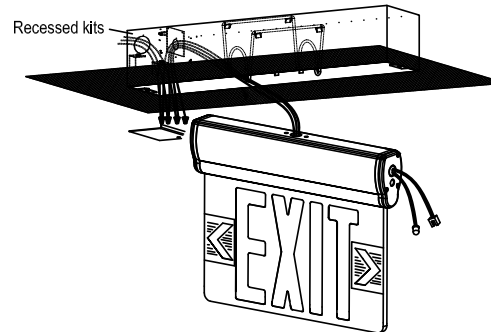

7. Insert fixture into metal box and snap by spring
8. Connect test switch, assemble LED indicator on bushing at trim plate. Fix trim plate on metal box by 2 screws

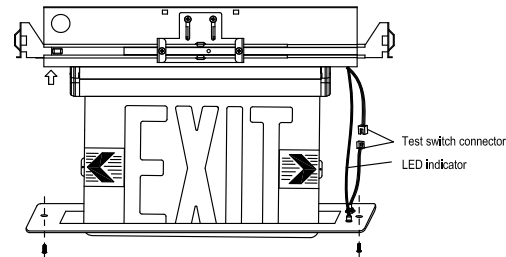

9. Peel off protective film from both sides of EXIT panel

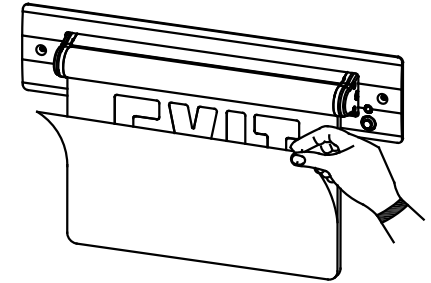

10. Determine direction of chevron indicator (See DETERMINE DIRECTION)
11. The unit can be installed on any surface, you may rotate the EXIT panel in any angle from 0° to 180°

RECESSED WALL MOUNTING

1. Reference steps 1-10 in recessed ceiling mounting above for recessed wall mounting.
2. Recessed ceiling mounting rotate 90° become recessed wall mounting.

