



DPLAF50

UL 924 LISTED PHOTOLUMINESCENT EXIT SIGN

Notice: External Illumination Source Required

Activation

Minimum 5-foot candles (54 lux) of unfiltered fluorescent, LED, metal halide, or mercury vapor lighting.

Install DPLAF50 Photoluminescent exit signs only in locations where an external illumination source is present, is deemed reliable and is supplied by a circuit not controlled by automatic timers or sensors, and whose controls are accessible only to authorized personnel. This reliable external illumination source is to be energized at all times during building occupancy.

DPLAF50 Photoluminescent exit signs are UL 924 Listed for high location, floor proximity and INDOOR use only. Do not expose to direct sunlight, liquid spray or temperature outside the range of 10°C - 40°C (50°C - 104°F). Check with your applicable installation codes (such as NFPA 101 – Life Safety Code) to perform periodic visibility tests.

Should any changes in your external lighting types or lighting levels occur, make sure that the DPLAF50 exit sign is still being illuminated with a minimum of 5-foot candles (54 lux) of unfiltered LED, fluorescent, metal halide, or mercury vapor lighting.

Periodically clean sign face with a damp cloth. Do not use any thinners or solvents on the sign face.

Viewing Distance

50 foot viewing distance

Directional Indicators

Two self-adhesive photoluminescent directional indicators are supplied with each sign. Small dots are provided to the left of the letter E and to the right of the letter T for easy alignment. If your exit sign is to be located other than directly over an exit, apply a directional indicator to the left of the E, pointing left, or to the right of the T, pointing right, or both, as appropriate.

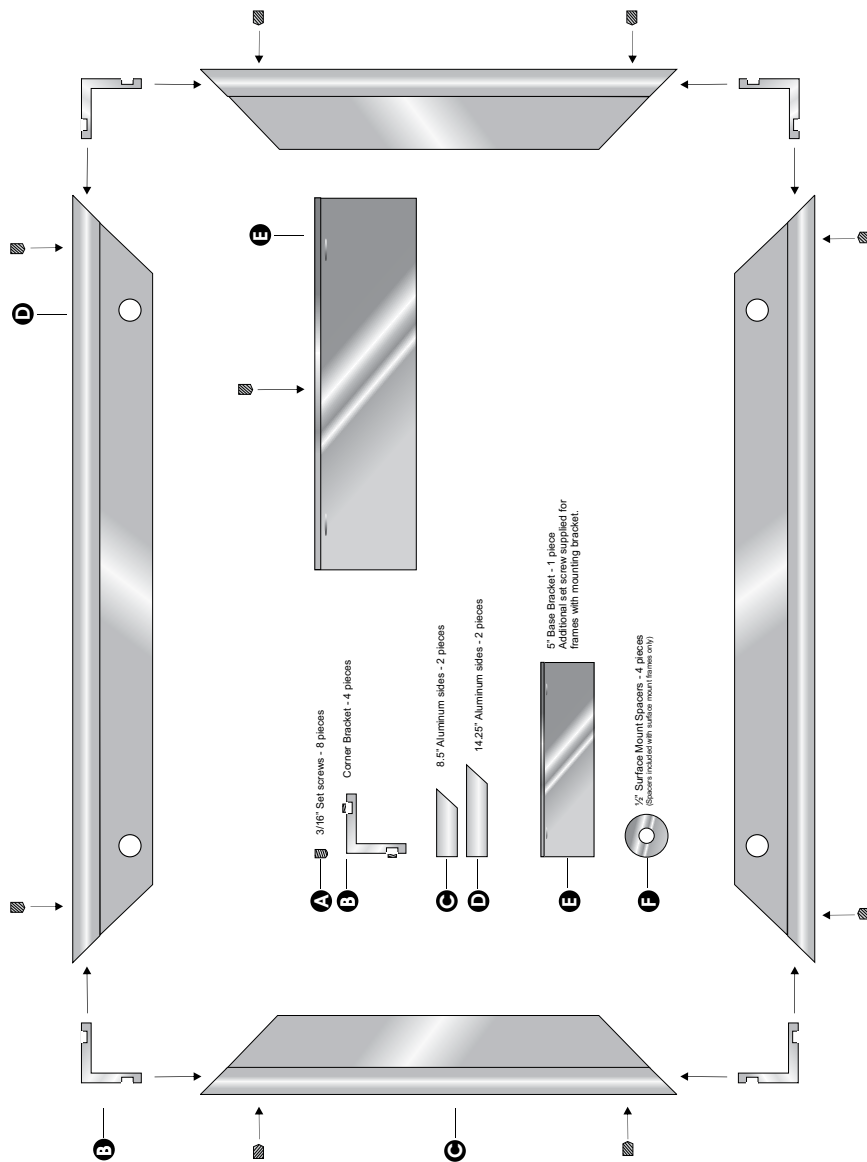

RECYCLING INFORMATION

All steel, aluminum and thermoplastic parts are recyclable.
NOTICE: Emergency units contain rechargeable batteries which must be recycled or disposed of properly.

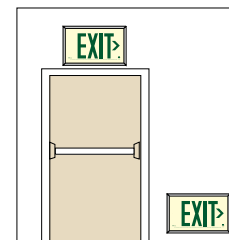

SURFACE MOUNT
UPPER OR LOWER

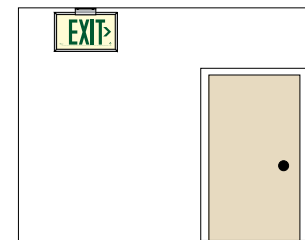

CEILING MOUNT

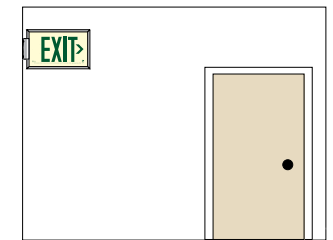

FLAG MOUNT

Hubbell Lighting, Inc. Life Safety Products • www.dual-lite.com

Copyright © Hubbell Lighting, Inc., All Rights Reserved • Specifications subject to change without notice. • Printed in U.S.A.

0604088_A 09/18



Flag and Ceiling Mount



1. Using the supplied 3/32" Allen wrench, remove the top and bottom set screws from one frame side

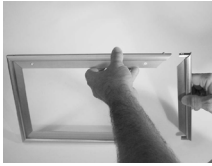

2. Pull frame side away from frame assembly.

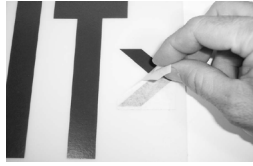

3. If a directional arrow is to be used, apply supplied arrows to the exit sign at this time. For exit paths to the left, apply an arrow on the left side of the exit sign. For exit paths to the right, apply an arrow on the right side of the exit sign. For exit paths straight ahead, no arrows are needed. If exit paths are located to the left and right, apply both arrows to the exit sign. Alignment dots are provided on the face of the sign to ensure proper positioning of the arrows.



4. Slide the exit sign into the first groove of the frame assembly. If this is a double-sided installation, prepare a sign and assemble as per steps 2 and 3. Slide the assembly into the second groove facing the opposite direction.
 • For ceiling mount installation go to steps A-B.
 • For flag mount installation go to steps C-E.

Ceiling Mount (continued)



A. Slide the mounting bracket onto the top frame piece.



B. Center the mounting bracket and secure it into place by tightening the set screw which is accessible through the center hole of the mounting bracket.
 • Go to steps 6-9.



C. Remove the set screw from one of the corner angle brackets on the previously removed frame side. Remove the corner bracket.



D. Slide the mounting bracket onto the frame side. Center the mounting bracket and secure it into place by tightening the set screw which is accessible through the center hole of the mounting bracket.

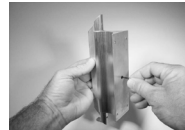

E. Reinstall the corner bracket and secure using the set screw.
 • Go to steps 6-9.



6. Reinstall the frame side onto the assembly, being careful to align the sign into the frame side groove.



7. Square up the frame. Reinstall and tighten the previously removed top and bottom set screws.



8. Mark the position of the mounting screws on the wall or ceiling.



9. Mount the exit sign using supplied screws and hardware.

Surface Mount



1. Reinstall the frame side onto the assembly, being careful to align the sign into the frame side groove.

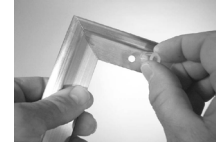

2. Locate the four supplied frame spacers. The spacers attach to the back side of the frame, which is not countersunk. Attach one selfadhesive spacer over each framemounting hole.

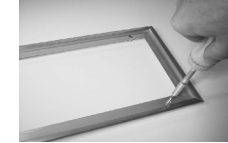

3. Locate the four supplied frame spacers. The spacers attach to the back side of the frame, which is not countersunk. Attach one selfadhesive spacer over each framemounting hole.

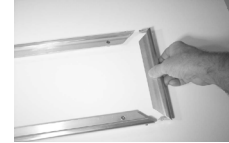

3. Locate the four supplied frame spacers. The spacers attach to the back side of the frame, which is not countersunk. Attach one selfadhesive spacer over each framemounting hole.

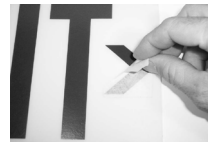

5. If a directional arrow is to be used, apply supplied arrows to the exit sign at this time. For exit paths to the left, apply the arrow on the left side of the exit sign. For exit paths to the right, apply the arrow on the right side of the exit sign. For exit paths straight ahead, no arrows are needed. If exit paths are located to the left and right, apply both arrows to the exit sign. Alignment dots are provided on the face of the sign to ensure proper positioning of the arrows



6. Slide the exit sign into the front groove of the frame assembly.



7. Reinstall the frame side onto the frame assembly being careful to align the sign into the frame side groove.



8. Reinstall and tighten the previously removed top and bottom set screws.