

Instructions for RACO® Heavy Duty Universal Box Support

For 4-11/16" Square, 2-1/8" Deep Boxes with NEMA Standard .250" Diameter, 1.5" Center Hole Locations

STEP 1. If required, bend cable support to access far side support.

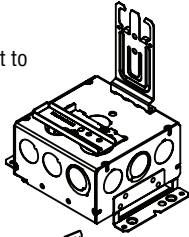

STEP 2. For 2.5" stud, use out of carton position of far side support.

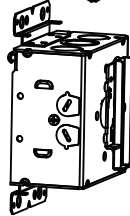

STEP 3. For studs greater than 2.5", rotate far side support perpendicular to box and follow instructions below based on stud depth. 3b Using pliers, bend straight tab in opposite direction of pre-bent tab. 3c Tab must be bent in opposite direction to positively secure support to box.

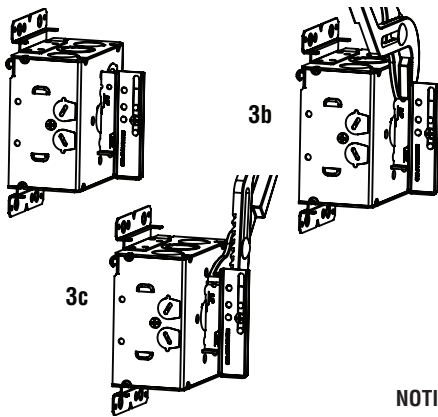

STEP 4. For 3.5" stud, lock base perpendicular to box and discard extension.

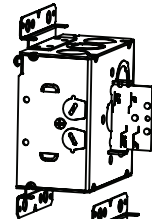

STEP 5. For 3.625" stud, lock base perpendicular to box.

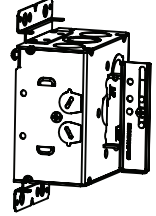

STEP 6. For 4" stud, lock base perpendicular to box, loosen screw and rotate extension 180°. Tighten screw.

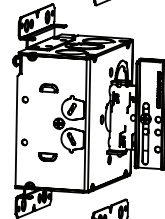

STEP 7. For 5.5" stud, lock base perpendicular to box, loosen screw and rotate 90°. Position as shown and tighten screw.

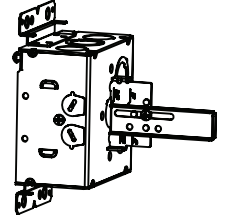

STEP 8. For 6" stud, lock base perpendicular to box, loosen screw and rotate 90°. Position as shown and tighten screw.

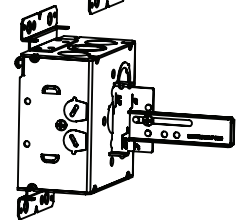

NOTICE: Bottom knockouts are NOT usable with the FS Support.

Instructions for using RACO® cable support bracket with STAB-IT® boxes

STEP 1. Install box to the stud.

STEP 2. Pre-bend cable support bracket as shown

STEP 3. Remove pry-out(s) and install cable(s)

STEP 4. Bend cable support bracket as shown

STEP 5. Bend up/down center tab.

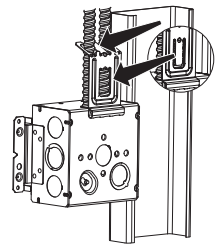
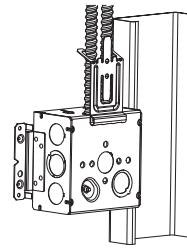
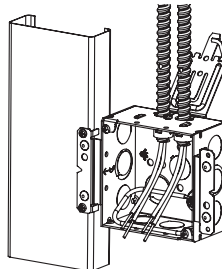
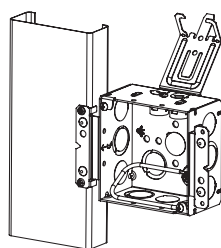
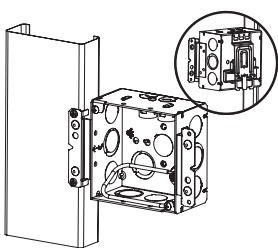

Alternate instructions for installing larger diameter cables in RACO® STAB-IT® II boxes (if needed)

1. Loosen up screw

2. Push in cable

3. Tighten up screw

4. Push in cable until it snaps into place

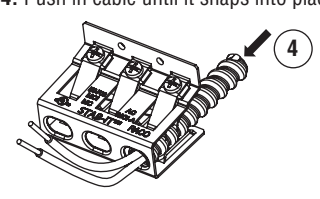
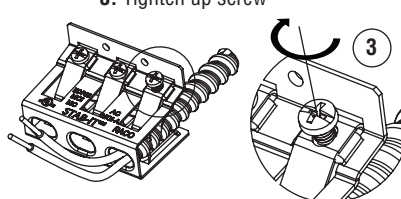
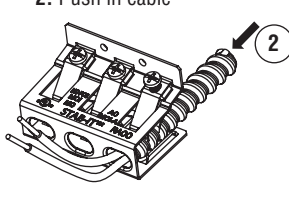
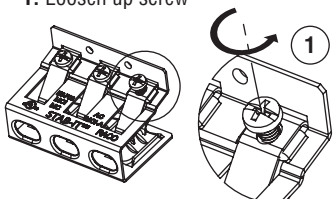

Instructions for removing cables from RACO® STAB-IT® II boxes

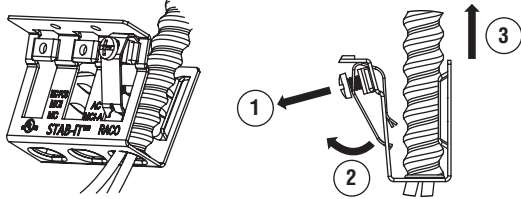

1. Loosen screw
2. Pull the spring clip away from cable as shown
3. Pull cable out

**Instructions for using RACO® Hinged Adjustable Mud Ring
768HAMR, 769HAMR, 818HAMR & 843HAMR**

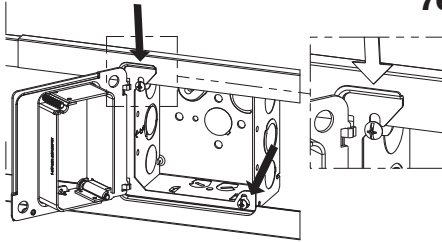

STEP 1.
Place hinged adjustable mud ring over screws and slide it down.
NOTE: The device may be installed before or after the mud ring installation.

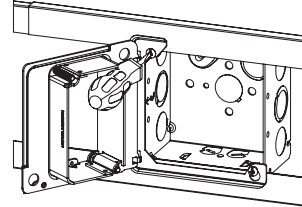

STEP 2.
Tighten top screw.

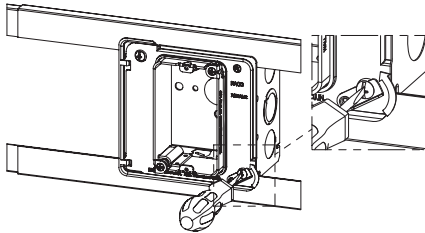

STEP 3.
Close hinged adjustable mud ring and position bottom screw into key hole.

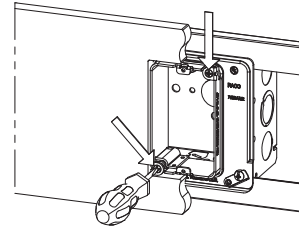

STEP 4.
After drywall is mounted, adjust height of mud ring with adjustment screws until flush with drywall.

Instructions for using RACO® Adjustable Open Center Bracket 9020R

To retain cUL listing in Canada, RACO boxes with the UBS (Universal Box Stabilizer) must be used.

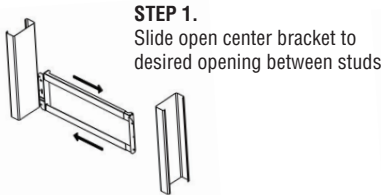

STEP 1.
Slide open center bracket to desired opening between studs

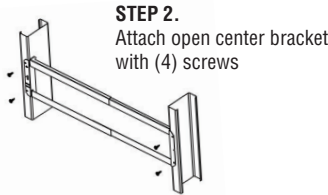

STEP 2.
Attach open center bracket with (4) screws

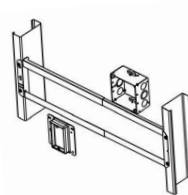

STEP 3.
Install box and cover as shown. Box and cover not included with open center bracket.

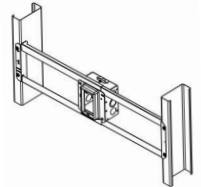

Cable Types & Ranges for STAB-IT® II Clamp

CABLE TYPE	CABLE RANGE	CABLE DIA. RANGE
AC STEEL	14-2,14-3, 14-4, 12-2, 12-3, 12-4, 10-2, 10-3	0.44" - 0.62"
HCF AC STEEL	12-2, 12-3, 10-2, 10-3	
AC ALUMINUM	14-2,14-3, 14-4, 12-2, 12-3, 12-4, 10-2, 10-3	0.44" - 0.62"
HCF AC ALUMINUM	12-2, 12-3, 12-4, 10-2, 10-3	
MC STEEL	14-2,14-3, 14-4, 12-2, 12-3, 12-4, 10-2, 10-3	
MCI-A STEEL	14-2, 12-2, 12-3, 12-4, 10-2, 10-3	
HCF MCI-A STEEL	12-2, 12-3, 10-2	
MC-PCS STEEL	12-2/16-2, 12-3/16-2, 10-2/16-2	0.38" - 0.62"
MC ALUMINUM	14-2,14-3, 14-4, 12-2, 12-3, 12-4, 10-2, 10-3	
MCI-A ALUMINUM	14-2,14-3, 14-4, 12-2, 12-3, 12-4, 10-2, 10-3	
HCF MCI-A ALUMINUM	12-2, 12-3, 12-4, 10-2, 10-3	
MC-PCS ALUMINUM	12-2/16-2, 12-3/16-2, 10-2/16-2	

Cable Armor must comply with NEC 250.96.
To install more cables use any of the knockouts with RACO® connectors.