

INSTALLATION and MAINTENANCE INSTRUCTIONS

MMD21 GEAR DRIVE ELECTRIC CABLE REELS

All units are provided with right hand rotation unless otherwise specified. This means that cable is pulled off spool top left or bottom right (spool rotates clockwise to wind cable) **when viewing spring end of reel**. See diagram on parts page.

Clock-type springs provide power for automatic cable take-up. **Spring must be pretensioned at time of installation** to insure that tension is applied to cable at all times. A tension adjustment spanner wrench is provided with each reel.

WARNING

Some reels with large or multiple springs are equipped with a ratcheted adjustment wrench. Follow separate instructions for its use. Failure to use ratcheted wrench, on reels so equipped, could result in serious personal injury.

WARNING

Do not attempt to relieve spring tension using spanner wrench. Doing so may result in personal injury.

INSTALLATION

1. Insure that machinery to be serviced by reel is at position closest to reel.
2. Securely mount reel in desired position using 3/8"(M10) bolts. Be sure spool is aligned with cable run.
3. Position optional cable guide, if reel is so equipped. See CABLE INSTALLATION DRAWING.
4. Unspool cable from reel, without allowing spool to rotate, so that desired length of cable extends from reel. Do not pull cable directly off reel as this will apply tension to the spring and may cause overtensioning when the reel is put into service. Connect free end of cable to junction box on machine or adjust cable stop
5. Remove cover plate on spring housing to expose shaft and spring hub. (See Figure 1).
6. Insert spanner wrench into holes in spring hub (Fig 2). Rotate wrench clockwise (for standard rotation). Number of 360° turns should match last digit in model number on serial plate. *If model number includes an "R", reel is reverse rotation and wrench must be rotated counterclockwise.* (See EXPLANATION on parts list page.)

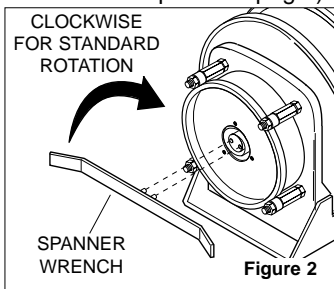
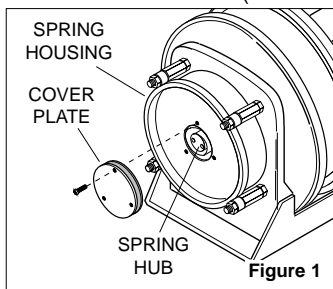

CAUTION

Do not exceed number of turns indicated on serial plate. Over-tensioning can cause a broken spring, sheared shaft or other damage.

NOTE: If reel is equipped with ratcheted adjustment wrench, follow instructions on separate sheet.

NOTE: On reels containing more than one spring, the hubs are connected at the factory. Therefore, by tightening the outer spring, the inside spring(s) will be tightened.

7. Remove collector cover and connect individual supply conductors to collector terminals. See ELECTRICAL CONNECTIONS diagram, on parts page.

MAINTENANCE

Periodically: A. Use compressed air to clean collector assembly and inside of collector housing. Inspect collector assembly for brush wear and pitted slip rings.

B. Inspect cable for wear and check mounting bolts and other hardware for tightness.

C. Check for broken springs by pulling about 2/3 cable off reel and observing "Broken Spring Indicators" on sides of spring canisters. See Fig. 3.

D. Apply grease to gears through grease fitting on side of gear housing.

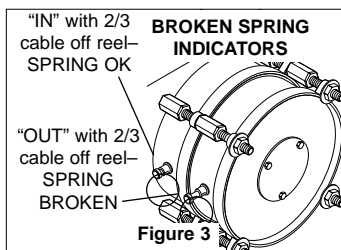

NOTE: Bearings and springs are prelubricated and require no periodic maintenance.

WARNING

Do not attempt to remove spring from its housing. Clock-type springs can be dangerous to handle. Removal of spring from housing could result in personal injury.

SPRING REPLACEMENT

The unique SAFETYCHANGE® spring motor consists of a spring and hub sealed within a housing. A replacement spring is supplied sealed in its housing and the old unit should be discarded completely.

1. Turn off all electric power.
2. Disconnect cable from machine junction box.
3. Wind all cable onto reel to relieve all spring tension.
4. Remove inspection cover from face of spring housing.
5. Rotate spool clockwise and observe spring shaft. Shaft should rotate counterclockwise and hub (with spring attached) should remain stationary.

NOTE: Do not attempt to remove spring if resistance is met or hub tends to rotate with shaft.

- Continue to rotate spool and strike end of shaft with a rubber mallet until shaft rotates freely and hub remains stationary.
6. Remove (4) nuts which secure spring motor(s) to frame.
 7. Slide spring motor(s) off shaft and discard.

NOTE: On multi-spring reels, be sure to remove and **save** dowel pins which connect one spring hub with another. Also remove snap rings on shaft between reel housings.

8. Install replacement spring motor(s), pawls and pawl springs. **NOTE:** Pawl springs must be located between the pawls and the deepest section of the shaft grooves. Make sure that pawls and pawl springs are inserted flush with ends of shaft and hub or they may rub against inspection cover.
9. Tighten nuts (and extension bolts) securing spring housing(s) to reel frame.

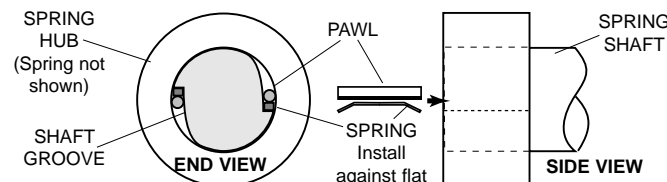

10. Connect free end of cable to junction box on machine or adjust cord stop so that desired length of cord extends from reel.
11. Tension spring with spanner wrench. Refer to **INSTALLATION** section.
12. Replace inspection cover.

ILLUSTRATED PARTS LIST

For MMD21 GEAR DRIVE ELECTRIC CABLE REELS manufactured after July 1, 1999

Always specify SERIAL NUMBER & MODEL NUMBER when ordering parts.

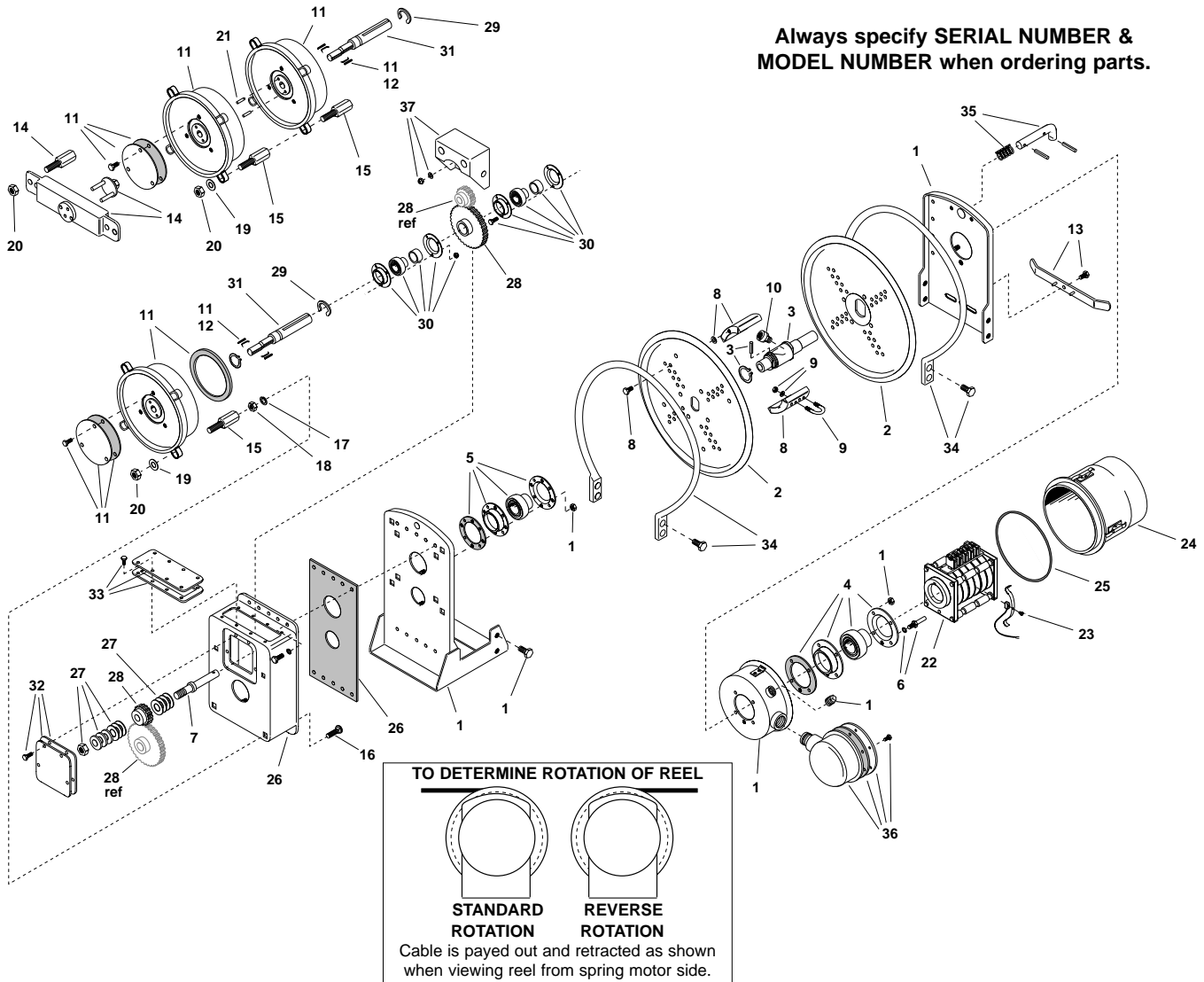

ELECTRICAL CONNECTIONS

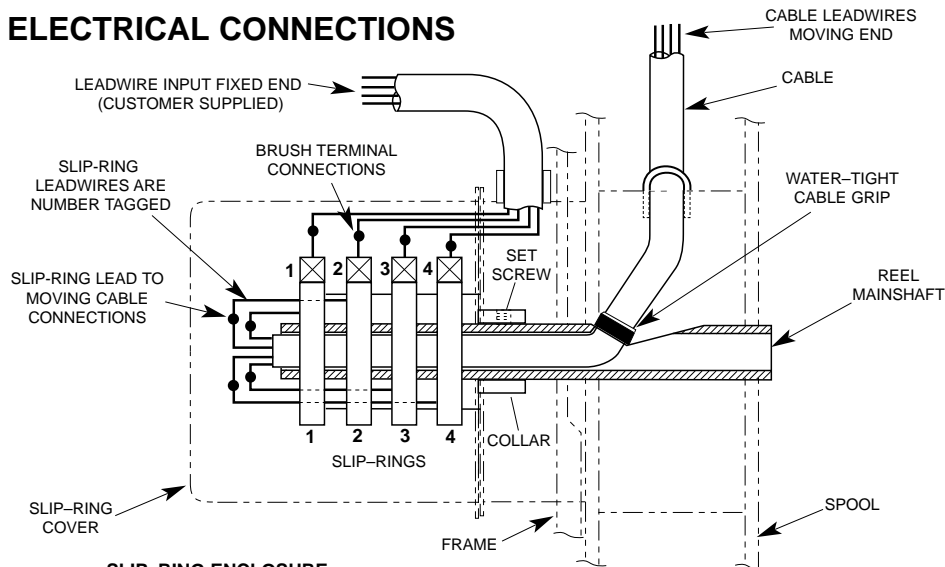

NOTE:
Wire size, wire connectors, connection sequence, and connection methods must comply with National Electrical code and Local Electrical ordinances. If in doubt, contact a local electrical contractor or electrical inspector.

COLOR SEQUENCE FOR TYPE SO CABLE

- THREE CONDUCTOR CABLE**
 # 1 - BLACK
 # 2 - WHITE
 # 3 - GREEN (ground)
- FOUR THRU TWELVE CONDUCTOR CABLE**
 # 1 - BLACK
 # 2 - WHITE
 # 3 - RED
 # 4 - GREEN (ground)
 # 5 - ORANGE
 # 6 - BLUE
 # 7 - WHITE W/ BLACK TRACER
 # 8 - RED W/ BLACK TRACER
 # 9 - GREEN W/ BLACK TRACER
 # 10 - ORANGE W/ BLACK TRACER
 # 11 - BLUE W/ BLACK TRACER
 # 12 - BLACK W/ WHITE TRACER

SLIP-RING ENCLOSURE

- 600 VOLT AC. 250 VOLT DC. WATERTIGHT, DUST TIGHT.
- DO NOT EXCEED AMPERAGE RATING OF CABLE OR SLIP RING.
- NUMBER OF CIRCUITS MAY VARY FROM TWO (MINIMUM) TO 36 (MAXIMUM). FOUR CIRCUITS SHOWN.

MMD21 GEAR DRIVE ELECTRIC CABLE REEL REPLACEMENT PARTS LIST

For reels manufactured after July 1, 1999.

NOTE: Applicable mounting hardware included with each kit.

ITEM	KIT NO.	DESCRIPTION	QTY.	ITEM	KIT NO.	DESCRIPTION	QTY.
1	012393	Frame Assembly	1	22	012376	Collector Assembly, 6 Pole, 75 Amp	1
2	012406	Discs (Set of two)	1	22	012377	Collector Assembly, 8 Pole, 75 Amp	1
3	012397	Main Shaft Assembly (Includes drive pin and retaining rings)	1	22	037194	Collector Assembly, 2 Pole, 125 Amp	1
4	012402	Bearing Kit--2" Bore (Includes housing and gasket)	1	22	037294	Collector Assembly, 3 Pole, 125 Amp	1
5	012401	Bearing Kit--1.75" Bore (Includes housing and gasket)	1	22	037295	Collector Assembly, 4 Pole, 125 Amp	1
6	012456	Drive Stud Kit	1	22	012304	Collector Assembly, 2 Pole, 200 Amp	1
7	017230	Stub Shaft, Gear Ratios 'A'-'K'	1	22	012381	Collector Assembly, 3 Pole, 200 Amp	1
8	012416	Wrapper Kit--5" Wide, 8" to 14" Dia. (Includes 4 wrapper sections)	1	22	012382	Collector Assembly, 4 Pole, 200 Amp	1
8	012417	Wrapper Kit--5" Wide, 15" to 20" Dia. (Includes 8 wrapper sections)	1	22	012383	Collector Assembly, 6 Pole, 200 Amp	1
9	012444	Cable Clamp Kit .38--.74 Dia. Cable (U-bolt with lockwashers and hex nuts)	1	22	012384	Collector Assembly, 8 Pole, 200 Amp	1
9	012445	Cable Clamp Kit .75--1.11 Dia. Cable	1	23	012440	Brush Kit (35 Amp) <i>(Each kit includes 4 brushes and 4 fingers)</i>	ar
9	012446	Cable Clamp Kit 1.12--1.50 Dia. Cable	1	23	012441	Brush Kit (75 Amp)	ar
10	012459	Cable Connector .38--.50 Cable Dia.	1	23	012443	Brush Kit (125 Amp/200 Amp)	ar
10	012460	Cable Connector .50--.62 Cable Dia.	1	24	012409	Collector Cover Kit (8" long) <i>(Includes seal ring)</i>	1
10	012461	Cable Connector .62--.75 Cable Dia.	1	24	012410	Collector Cover Kit (10.5" long)	1
10	012462	Cable Connector .75--.88 Cable Dia.	1	24	012411	Collector Cover Kit (13" long)	1
10	012463	Cable Connector .88--1.00 Cable Dia.	1	24	012412	Collector Cover Kit (15.5" long)	1
10	012464	Cable Connector 1.00--1.12 Cable Dia.	1	24	012413	Collector Cover Kit (20.5" long)	1
10	012465	Cable Connector 1.12--1.25 Cable Dia.	1	24	012414	Collector Cover Kit (28.5" long)	1
10	012466	Cable Connector 1.25--1.38 Cable Dia.	1	25	012458	Seal Ring (only)	1
10	012467	Cable Connector 1.38--1.50 Cable Dia.	1	26	045716	Gear Enclosure Kit <i>(Includes gasket)</i>	1
11	017052	Spring Motor Kit, Std. Rot.--100 Geared <i>(Includes pawl, pawl springs, cover, gaskets, and snap ring)</i>	ar	27	016525	Tensioner Kit <i>(Includes washers, pad and nut)</i>	1
11	017051	Spring Motor Kit, Rev. Rot.--100 Geared	ar	28	045717	Gear Kit, Ratio 'A' (1.22--8 pitch) <i>(Includes 2 gears and key)</i>	1
12	012427	Pawl Kit (100 Springs) <i>(Includes 2 pawls and springs)</i>	ar	28	045718	Gear Kit, Ratio 'B' (1.50--8 pitch)	1
13	017191	Spanner Wrench (100 Springs)	1	28	045719	Gear Kit, Ratio 'C' (1.86--8 pitch)	1
14	032804	Ratchet Wrench Kit (100 Springs) <i>(Includes mounting bolts)</i>	1	28	045720	Gear Kit, Ratio 'D' (2.07--8 pitch)	1
15	017055	Extension Bolts (100 Springs) (4 bolts per kit--less hardware)	ar	28	045721	Gear Kit, Ratio 'E' (2.33--8 pitch)	1
16	016182	Carriage Bolt, .50--13 x 1.5	ar	28	045722	Gear Kit, Ratio 'F' (3.00--8 pitch)	1
17	021291	Lockwasher, .56 Med., Z.P.	ar	28	045723	Gear Kit, Ratio 'G' (4.00--8 pitch)	1
18	100959	Hex Nut, .50--13, Z.P.	ar	28	045724	Gear Kit, Ratio 'H' (1.22--6 pitch)	1
19	101211	Flat Washer, .50	ar	28	045725	Gear Kit, Ratio 'I' (1.50--6 pitch)	1
20	P06-03	ESNA Lock Nut, .50--13, Z.P.	ar	28	045726	Gear Kit, Ratio 'J' (2.00--6 pitch)	1
21	021762	Hub Lock Pins (100 Springs)	ar	28	045727	Gear Kit, Ratio 'K' (2.33--6 pitch)	1
22	012285	Collector Assembly, 2 Pole, 35 Amp	1	29	118320	Retaining Ring	1
22	012286	Collector Assembly, 3 Pole, 35 Amp	1	30	012400	Gearbox Bearing Kit <i>(Includes collar, housing and hardware)</i>	2
22	012287	Collector Assembly, 4 Pole, 35 Amp	1	31	012217	Spring Shaft, Gear, Std. Rot. (1001)	1
22	012288	Collector Assembly, 6 Pole, 35 Amp	1	31	01221701	Spring Shaft, Gear, Rev. Rot. (1001)	1
22	012289	Collector Assembly, 8 Pole, 35 Amp	1	31	012218	Spring Shaft, Gear, Std. Rot. (1002)	1
22	012290	Collector Assembly, 10 Pole, 35 Amp	1	31	01221801	Spring Shaft, Gear, Rev. Rot. (1002)	1
22	012291	Collector Assembly, 12 Pole, 35 Amp	1	31	012219	Spring Shaft, Gear, Std. Rot. (1003)	1
22	012292	Collector Assembly, 14 Pole, 35 Amp	1	31	01221901	Spring Shaft, Gear, Rev. Rot. (1003)	1
22	012293	Collector Assembly, 16 Pole, 35 Amp	1	31	012220	Spring Shaft, Gear, Std. Rot. (1004)	1
22	012294	Collector Assembly, 20 Pole, 35 Amp	1	31	01222001	Spring Shaft, Gear, Rev. Rot. (1004)	1
22	012295	Collector Assembly, 24 Pole, 35 Amp	1	32	045728	Front Gear Case Cover Kit	1
22	012296	Collector Assembly, 30 Pole, 35 Amp	1	33	045729	Top Gear Case Cover Kit	1
22	012297	Collector Assembly, 36 Pole, 35 Amp	1	34	012098	Hoop Kit	1
22	012298	Collector Assembly, 2 Pole, 75 Amp	1	35	012091	Spool Lock Assembly	1
22	012299	Collector Assembly, 3 Pole, 75 Amp	1	36	015660	Entrance Assembly Kit--1.50 NPT <i>(Includes pipe nipple, conulet and dome cover)</i>	1
22	012300	Collector Assembly, 4 Pole, 75 Amp	1	37	045747	Gear Guard Kit	1

NOTE: Please consult factory for optional accessories: roller guides, ratchet lock, limit switch, hoop guides, spool lock, and swivel base

MODEL NUMBER EXPLANATION

AMPACITY

SPRING REEL: MMD
 FRAME SERIES: 21
 SPRING SERIES: 100
 NO. OF SPRINGS: 2
 NO. OF POLES: R
 AMPACITY: 12
 CORE DIAMETER: 3
 GEAR RATIO: 10
 PRETENSION TURNS: B
 1

INDICATES REVERSE ROTATION.
NO LETTER INDICATES STANDARD ROTATION.

CODE	AMPS
3	35
7	75
12	125
20	200

SPRING DETENSIONING

Use the following procedure to relieve spring tension prior to cable or spring replacement..

⚠ WARNING

DO NOT insert hands into gearbox until springs are fully detensioned. Doing so could lead to serious injury.

1. Cycle reel thru normal operating cycle and stop when maximum amount of cable is wound onto reel spool.
2. Set spool lock to prevent spool from turning.
3. Remove access cover from top of gearbox.
4. Using open end wrench, loosen large hex nut slowly to allow springs to unwind. Fully loosen nut further with wrench until springs are completely unwound.
5. Repair reel or replace springs or cable as necessary.
6. Retighten nut until definite resistance is felt and spring washers are full compressed (flat). Replace cover.
NOTE: If hex nut is not adequately tightened, spring unwinding can occur during reel operation.
7. Pretension reel. See INSTALLATION section, front page.

CABLE REMOVAL

⚠ CAUTION

Failure to relieve all spring tension prior to removing cable could result in damage to equipment or personal injury. Follow instructions carefully.

Use the following procedure to remove worn or damaged cable from reel prior to installation of new cable.

1. Move machine serviced by reel to a position closest to reel. Springs will still be under pre-tension at this point.
2. Turn off all electric power.
3. Lock spool to prevent turning using spool lock.
4. Disconnect cable from machine junction box.
5. Detension springs as described above.
6. Remove cable from spool. Loosen U-bolt and water-tight connector and disconnect conductors from slip ring.

CABLE INSTALLATION

Use the following procedure to replace cable or if reel was ordered without cable. Refer to CABLE INSTALLATION REFERENCE DRAWING, below.

1. Unspool new cable from shipping spool and lay out to eliminate twist.
NOTE: This step is not essential, but will aid in winding operation of the reel and prolong cable life.
2. Feed one end of the cable through water-tight connector on the main shaft inside the spool and into the slip ring side. (See drawing below).
NOTE: This may require that jacket of cable be stripped to allow conductors to pass through shaft.
3. Connect individual conductors to appropriate rings on collector using crimp fitting or similar connection method.
4. Tighten water-tight connector and U-bolt provided on drum wrapper segments. **Do not over-tighten.**
5. Wind the cable onto the reel spool by hand rotating spool in direction it turns free of spring tension.
6. Connect free end of cable to machine junction box.
7. Pretension reel and complete installation as previously described.

COLLECTOR REPLACEMENT

1. Turn off all power to reel.
2. Remove collector cover and gasket.
3. Disconnect electric leads to and from collector.
4. Remove drive stud bolt from bearing housing.
5. Remove pipe plug from hole in side of housing. Insert long 1/8" Allen wrench through hole and loosen two set screws in collector locking collar. Set screws are at 90° to one another.
NOTE: Older reels may have lock screws which must be removed to reach set screws holding collector to shaft.
6. Slide collector off shaft.
7. Install new collector by reversing above steps.

CABLE INSTALLATION REFERENCE DRAWING

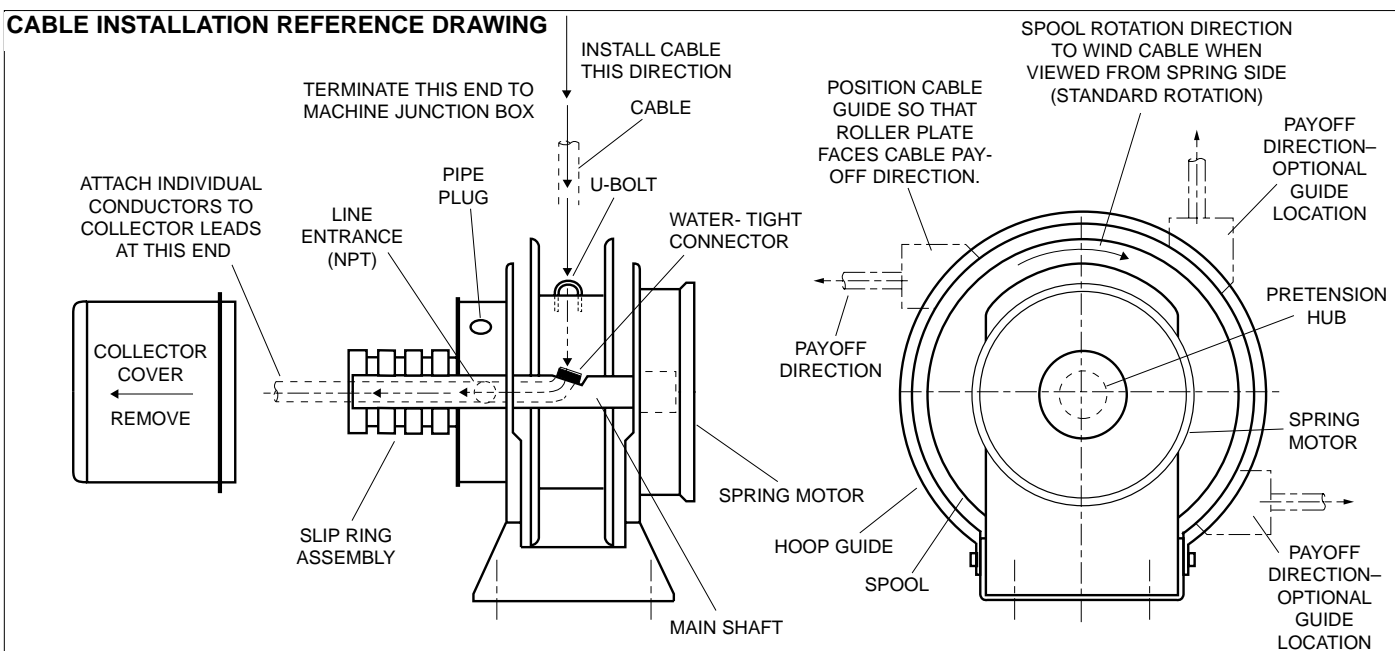

GLEASON REEL CORP.
600 South Clark St.
Mayville, WI 53050-0026
Phone 920-387-4120
Fax 920-387-4189