

GLEASON® PowerTrak®

EF Type Model PT60EF-WC Parts List

ITEM	DESCRIPTION	PART NO.
1	Outer Link	P60E-99
2	Inner Link-11.00 radius	P60E-01
	" 14.81 radius	P60E-02
	" 20.50 radius	P60E-03
	" 24.12 radius	P60E-04
	" 29.50 radius	P60E-05
	" 36.00 radius	P60E-06
3	Anti-friction Plate	028922
4 & 5	-See Below-	
6	Socket Hd Cap Screw	051116
7	Flanged Bushing	051114
8	Washer	051115
9	Hex Locknut	028268
10	Shim Washer, .01 thick*	028915
11	Shim Washer, .02 thick*	028916
12	Skt. Hd. CSCR, M6-1.0 x 16	028920
13	Lockwasher, M6	028912
14	Mounting Bracket, L.H.	P07-345
15	Mounting Bracket, R.H.	P07-346

* Not required on all systems.

CARRIER WIDTH	ITEM 4 CHANNEL WELDMENT	ITEM 5 CHANNEL CARRIER
6.00"	02892301	02889501
8.00"	02892302	02889502
10.00"	02892303	02889503
12.00"	02892304	02889504
14.00"	02892305	02889505
16.00"	02892306	02889506
18.00"	02892307	02889507
20.00"	02892308	02889508
22.00"	02892309	02889509
24.00"	02892310	02889510

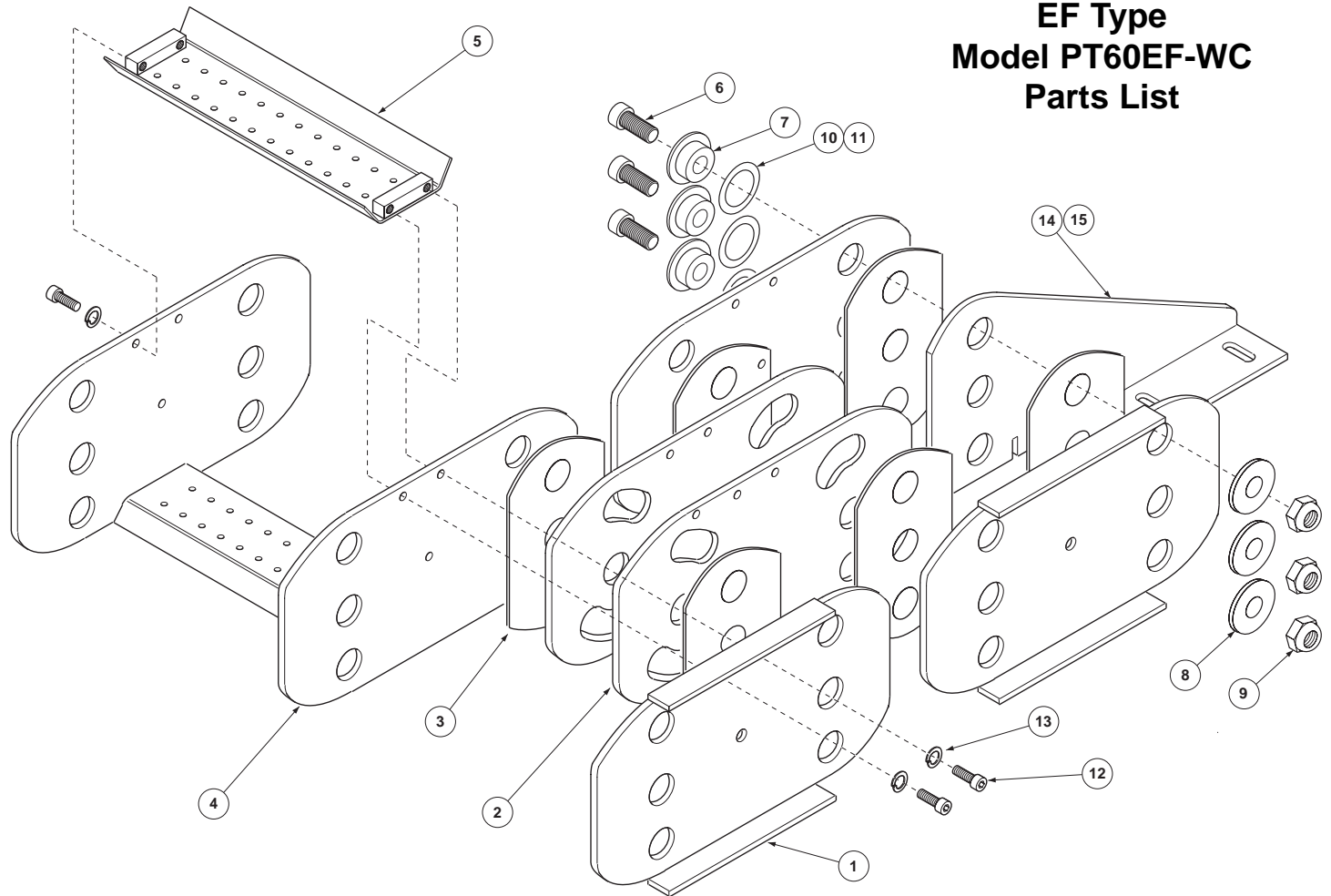

GLEASON REEL CORP.
600 South Clark St.
Mayville, WI 53050-0026
Phone 920-387-4120 • Fax 920-387-4189