

INSTALLATION and MAINTENANCE INSTRUCTIONS

UH32 UNIVERSAL HOSE REEL-CHAIN DRIVE



NOTE: These instructions are written for machine pull reels.
If installing or servicing hand pull reel, use only those steps marked with hand .

All units are provided with right hand rotation unless otherwise specified. This means that hose is pulled off spool top left or bottom right (spool rotates clockwise to wind hose) **when viewing spring end of reel**. See diagram on parts page.

Clock-type springs provide power for automatic hose take-up. **Spring must be pretensioned at time of installation** to insure that tension is applied to hose at all times. A tension adjustment spanner wrench is provided with each reel.

INSTALLATION

WARNING

If machine pull reel, move machinery to position closest to reel before adjusting spring tension. Adjusting tension with hose extended may result in damage to reel or personal injury.

1. Install hose if reel was purchased without hose. See instructions on page 4.
2. Insure that machinery to be serviced by reel is at position closest to reel.
2. Securely mount reel in desired position using 1/2"(M12). Be sure spool is aligned with hose run.
3. Position hose guide if supplied so hose pays-out as straight as possible through hose guide.
4. Connect free end of hose to connections on machine or adjust hose stop so that desired length of hose extends from reel.
5. Connect flexible supply lines to swivel fitting. See HOSE INSTALLATION REFERENCE DRAWING.
NOTE: Do not hard plumb to swivel fitting.
6. Remove cover plate on spring housing to expose shaft and spring hub. (See Figure 1).
7. Insert spanner wrench into holes in spring hub (Fig 2). Rotate spanner wrench counter-clockwise. Number of 360° turns should match last digit in model number on serial plate.

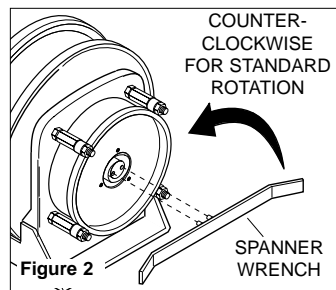
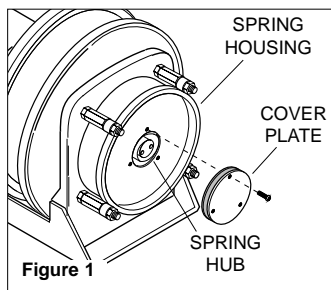

CAUTION

Do not exceed number of turns indicated on serial plate. Over-tensioning can cause a broken spring, sheared shaft or other damage.

WARNING

Do not attempt to relieve spring tension using spanner wrench. Doing so may result in personal injury.

WARNING

Some reels with large or multiple springs are equipped with a ratcheted adjustment wrench. Follow separate instructions for its use. Failure to use ratcheted wrench, on reels so equipped, could result in serious personal injury.

MAINTENANCE

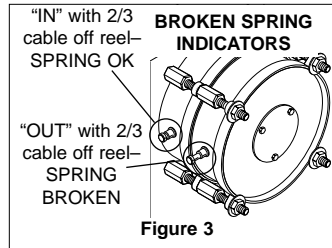

Periodically: A. Inspect hose for wear and check mounting bolts and other hardware for tightness.

B. Check for broken springs by pulling about 2/3 hose off reel and observing "Broken Spring Indicators" on sides of spring canisters (Fig. 3).

C. Periodically remove top chain guard (Fig 4) and grease roller chain.

NOTE: Bearings and springs are pre-lubricated and require no periodic maintenance.

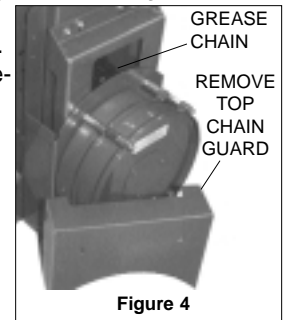

SPRING REPLACEMENT

The unique SAFETYCHANGE® spring motor consists of a spring and hub sealed within a housing. A replacement spring is supplied sealed in its housing and the old unit should be discarded completely.

WARNING

Do not attempt to remove spring from its housing. Clock-type springs can be dangerous to handle. Removal of spring from housing could result in personal injury.

1. Turn off supply pressure to reel.
2. Insure that machinery to be serviced by reel is at position closest to reel. Disconnect hose from machine connections.
3. Wind all hose onto reel to relieve all spring tension.
4. Remove inspection cover from face of spring housing.
5. Rotate spool clockwise and observe inner shaft. Shaft should rotate clockwise and hub (with spring attached) should remain stationary.

NOTE: Do not attempt to remove spring if resistance is met or hub tends to rotate with shaft. Continue to rotate spool and strike end of shaft several sharp blows with a lead hammer or rubber mallet until shaft rotates freely and hub remains stationary.

6. Remove (4) bolts which secure spring motor to frame.
7. Slide spring motor off shaft and discard.

CHAIN DRIVE UH32 UNIVERSAL HOSE REEL REPLACEMENT PARTS LIST

ITEM	PART NO.	DESCRIPTION	QTY.
1	042019	Vertical Frame Assy., Swivel Side	1
2	012140	Housing, 2" Bore Bearing	2
3	103837	Ball Bearing, 2" Bore	1
4	038424	Flat Washer, M8	9
5	028268	ESNA Lock Nut, M8-1.25	8
6	042009	Vertical Frame Assy., Drive Side	1
7	119114	Housing, 1.75" Bore Bearing	2
8	103823	Ball Bearing, 1.75" Bore	1
9	042030	Spool Support Hub, Drive Side	1
10	012137	Stub Shaft Drive Pin	1
11	118322	Retaining Ring	1
12	042029	Spool Disk, U32	2
13	04271001	Wrapper Assy. Kit, 6"w, 10"-12"dia. core <i>(Includes segments & hardware)</i>	1
13	04271002	Wrapper Assy. Kit, 8"w, 10"-12"dia. core	1
13	04271003	Wrapper Assy. Kit, 10"w, 10"-12"dia. core	1
13	04271004	Wrapper Assy. Kit, 12"w, 10"-12"dia. core	1
13	04271005	Wrapper Assy. Kit, 14"w, 10"-12"dia. core	1
13	04271006	Wrapper Assy. Kit, 6"w, 14"-18"dia. core	1
13	04271007	Wrapper Assy. Kit, 8"w, 14"-18"dia. core	1
13	04271008	Wrapper Assy. Kit, 10"w, 14"-18"dia. core	1
13	04271009	Wrapper Assy. Kit, 12"w, 14"-18"dia. core	1
13	04271010	Wrapper Assy. Kit, 14"w, 14"-18"dia. core	1
14	042711	Hose Adapter Kit, 0.25NPT, Standard Rotation <i>(Includes swivel, hub, reducer & elbow)</i>	1
14	042712	Hose Adapter Kit, 0.38NPT, Standard Rotation	1
14	042713	Hose Adapter Kit, 0.50NPT, Standard Rotation	1
14	042714	Hose Adapter Kit, 0.75NPT, Standard Rotation <i>(Includes swivel, hub & goose neck fitting)</i>	1
14	042715	Hose Adapter Kit, 1.00NPT, Standard Rotation	1
14	042716	Hose Adapter Kit, 1.25NPT, Standard Rotation	1
14	042717	Hose Adapter Kit, 1.50NPT, Standard Rotation	1
14	04271401	Hose Adapter Kit, 0.75NPT, Reverse Rotation	1
14	04271501	Hose Adapter Kit, 1.00NPT, Reverse Rotation	1
14	04271601	Hose Adapter Kit, 1.25NPT, Reverse Rotation	1
14	04271701	Hose Adapter Kit, 1.50NPT, Reverse Rotation	1
14a	102159	Swivel Joint Only, 0.25 (Reducer Required)	1
14a	102159	Swivel Joint Only, 0.38 (Reducer Required)	1
14a	102159	Swivel Joint Only, 0.50	1
14a	024670	Swivel Joint Only, 0.75	1
14a	102160	Swivel Joint Only, 1.00	1
14a	102161	Swivel Joint Only, 1.25	1
14a	041276	Swivel Joint Only, 1.50	1
15	028138	Lockwasher, M10	4
16	028131	Hex Hd. Cap Screw, M10-1.5 x 20L	4
17	04272201	Bottom Base Kit, 6" wide Wrapper <i>(Includes mounting hardware)</i>	1
17	04272202	Bottom Base Kit, 8" wide Wrapper	1
17	04272203	Bottom Base Kit, 10" wide Wrapper	1
17	04272204	Bottom Base Kit, 12" wide Wrapper	1
17	04272205	Bottom Base Kit, 14" wide Wrapper	1
18	042733	Spanner Wrench (35-80 Springs) <i>(Includes mounting hardware)</i>	1
18	042734	Spanner Wrench (100 Springs)	1
19	042041	Gearbox backplate	1
20	103826	Housing, 1" Bore Bearing	4

ITEM	PART NO.	DESCRIPTION	QTY.
21	103825	Ball Bearing, 1" Bore	2
22	042042	Outside Gearbox Plate	1
23	042043	Stub Shaft, Chain Drive	1
24	029880	Key	1
25	046803	Sprocket-50B12	1
25	042045	Sprocket-50B15	1
25	042046	Sprocket-50B16	1
25	042047	Sprocket-50B18	1
25	042049	Sprocket-50B24	1
25	042050	Sprocket-50B36	1
25	046804	Sprocket-50B39	1
25	042051	Sprocket-50B40	1
25	046802	Sprocket-50B45	1
25	042052	Sprocket-50B48	1
26	104789	Roller Chain (May be shortened as Required)	3.5 ft.
Not shown	015680	Connecting Link	1
27	031484	Hex Hd. Cap Screw, M12-1.75 x 35L	4
28	025942	Lockwasher, M12	4
29	025941	Hex Nut, M12-1.75	4
30	042044	Bottom Guard, Chain Drive	1
31	042184	Top Guard, Chain Drive	1
32	028151	Hex Hd. Cap Screw, M6-1.0 x 12L	4
33	042168	Stub Shaft, 1002, Chain, Standard Rotation	1
33	042169	Stub Shaft, 1001, Chain, Standard Rotation	1
33	042172	Stub Shaft, 802/622/752, Chain, Std. Rot.	1
33	042173	Stub Shaft, 801/621/751, Chain, Std. Rot.	1
33	042176	Stub Shaft, 1002, Chain, Reverse Rotation	1
33	042177	Stub Shaft, 1001, Chain, Reverse Rotation	1
33	042180	Stub Shaft, 802/622/752, Chain, Rev. Rot.	1
33	042181	Stub Shaft, 801/621/751, Chain, Rev. Rot.	1
34	012426	Pawl Kit (62, 75 & 80 Springs) <i>(Includes 2 pawls & springs)</i>	AR
34	012427	Pawl Kit (100 Spring)	AR
35	042183	Stand-off, 62, 75 & 80 Springs	AR
35	042182	Stand-off, 100 Spring	AR
36	029159	Flat Washer, M12	4
37	028502	ESNA Nut, M12-1.75	4
38	042725	Spring Motor Kit, 62, Standard Rotation <i>(Includes items 20, 27, 28, 29, & 30)</i>	AR
38	042730	Spring Motor Kit, 62, Reverse Rotation	AR
38	042726	Spring Motor Kit, 75, Standard Rotation	AR
38	042731	Spring Motor Kit, 75, Reverse Rotation	AR
38	042724	Spring Motor Kit, 80, Standard Rotation	AR
38	042729	Spring Motor Kit, 80, Reverse Rotation	AR
38	042723	Spring Motor Kit, 100, Standard Rotation	AR
38	042728	Spring Motor Kit, 100, Reverse Rotation	AR
39	G51-23	Gasket, Hub Cover	1
40	G27-42	Hub Cover, Springs	1
41	101220	Screw, #8-32 x 0.25" Lg.	3
42	021762	Hub Lock Pin Kit (100 Springs) <i>(Includes two pins)</i>	1
42	021761	Hub Lock Pin Kit (All Other Springs)	1
43	042735	Ratchet Wrench Kit (35-80 Springs)	1
43	042736	Ratchet Wrench Kit (100 Springs)	1

ACCESSORY CODE

Horizontal Roller Guide = H	340° Pivot Base = P
Vertical Roller Guide = V	Dog & Ratchet (ratchet lock) = D
Spool Lock = S	Limit Switch = L

Reel Model Number Structure

UH 32 80 1 - 08 - 10 06 - B - 1 - HSD

REEL TYPE	ACCESSORIES
SPOOL DIAMETER	PRETENSION TURNS
SPRING MODEL	CHAIN RATIO*
QUANTITY SPRINGS	SPOOL WIDTH
HOSE I.D. in 1/16"	CORE DIAMETER

*See chart, following page

TO DETERMINE ROTATION OF REEL

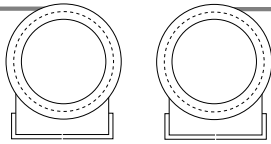

**STANDARD
ROTATION**

**REVERSE
ROTATION**

Hose is played out and retracted as shown when viewing reel from spring motor side.

Always specify
SERIAL NUMBER & MODEL NUMBER
when ordering parts.

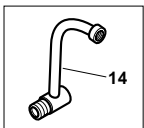
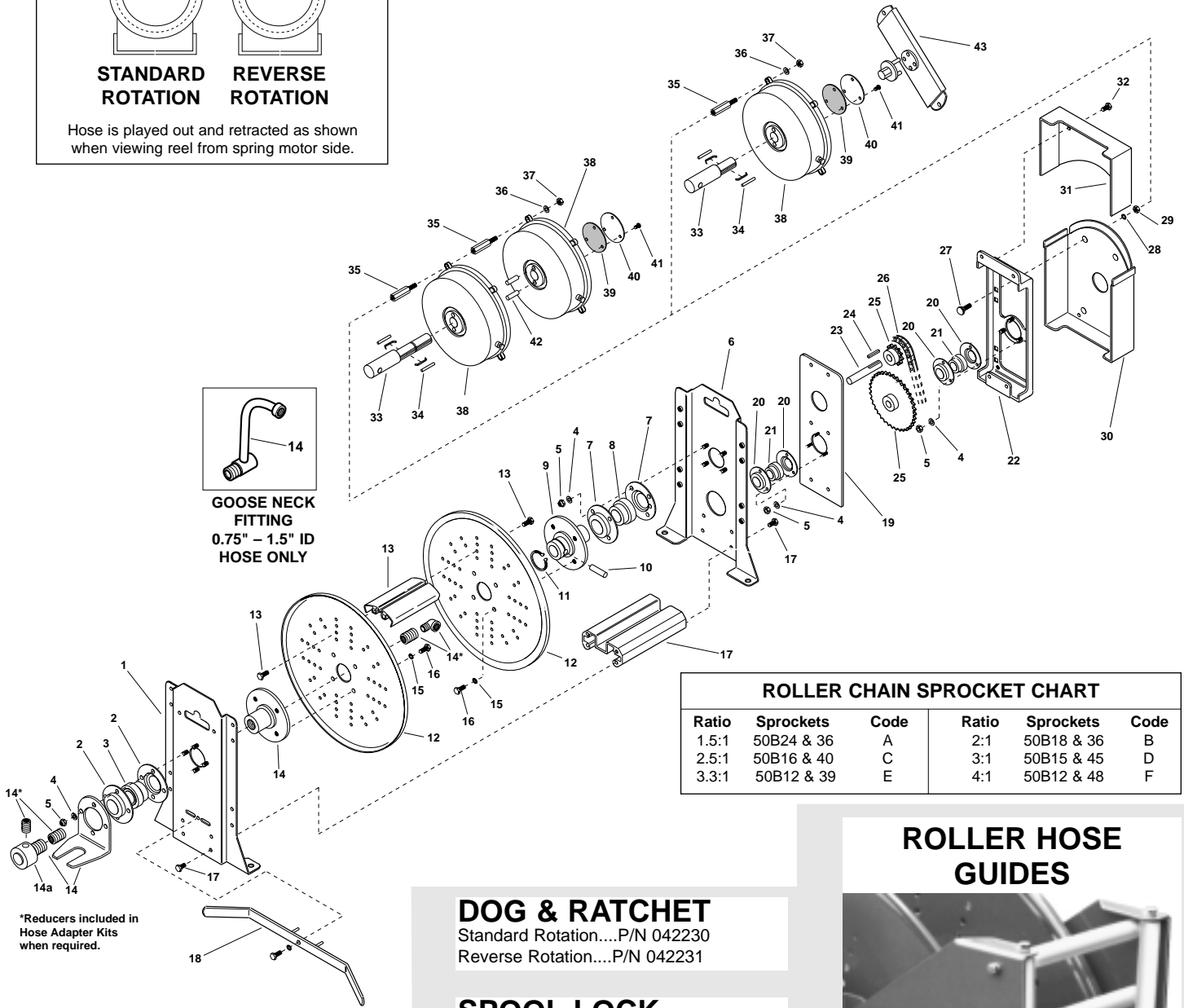

**GOOSE NECK
FITTING**
0.75" - 1.5" ID
HOSE ONLY

Ratio	Sprockets	Code	Ratio	Sprockets	Code
1.5:1	50B24 & 36	A	2:1	50B18 & 36	B
2.5:1	50B16 & 40	C	3:1	50B15 & 45	D
3.3:1	50B12 & 39	E	4:1	50B12 & 48	F

ROLLER HOSE GUIDES

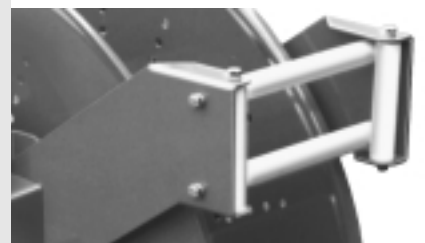

HORIZONTAL (shown)

SPOOL WIDTH	PART NUMBER
6"	042210
8"	042211
10"	042212
12"	042213
14"	042214

VERTICAL

SPOOL WIDTH	PART NUMBER
6"	042275
8"	042276
10"	042277
12"	042278
14"	042279

DOG & RATCHET

Standard Rotation....P/N 042230
Reverse Rotation....P/N 042231

SPOOL LOCK

All models....P/N 042227

340° PIVOT BASE

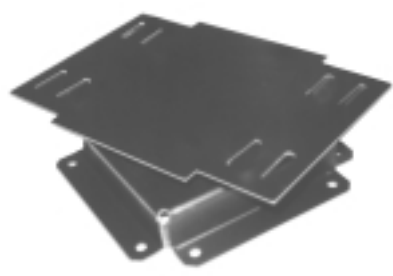

SPOOL WIDTH	PART NUMBER
4"-6"	042284
8"-10"	042285
12"-14"	042286

HOSE STOPS



TYPE A
3.00" O.D.

TYPE B
3.50" O.D.

PART NUMBER	TYPE	FITS O.D.s MIN - MAX
037529	B	0.44 - 0.62
037531	A	0.62 - 0.75
037532	A	0.75 - 1.05
037533	A	1.06 - 1.30
037535	B	0.75 - 1.05
037536	B	1.06 - 1.38
037537	B	1.39 - 1.55
041845	B	1.56 - 1.87
041846	B	1.88 - 2.06

*Reducers included in
Hose Adapter Kits
when required.

8. Install replacement spring motor, pawls and pawl springs.

NOTE: Pawl springs must be located between the pawls and the deepest section of the shaft grooves. Make sure that pawls and pawl springs are inserted flush with ends of shaft and hub or they may rub against inspection cover (Fig. 5).

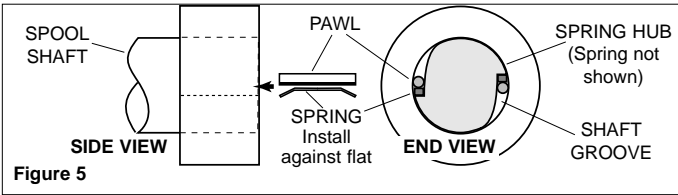

9. Tighten bolts securing spring housing to reel frame.

10. Connect free end of hose to connections on machine or adjust hose stop so that desired length of hose extends from reel.

11. Tension spring with spanner wrench. Refer to **INSTALLATION** section.

12. Replace inspection cover.

HOSE REMOVAL

Use the following procedure to remove worn or damaged hose from reel prior to installation of new hose.

1. Move machine serviced by reel to a position closest to reel. Spring will still be under pre-tension at this point.

2. Turn off supply pressure to reel.

3. Disconnect hose from machine or other attachments. Remove hose stop, if installed, and allow hose to retract onto spool. Ensure all tension is off spring by manually rotating spool (normally clockwise when viewed from spring side).

4. Unwrap hose without allowing spool to turn.

5. Disconnect hose from elbows inside spool wrapper.

6. Install new hose following directions below.

HOSE INSTALLATION

Use the following procedure to replace hose or if reel was ordered without hose. Refer to **HOSE INSTALLATION REFERENCE DRAWING**, below.

1. Unspool new hose from shipping spool and lay out to eliminate twist.

NOTE: This step is not essential, but will aid in winding operation of the reel and prolong hose life.

2. Insert hose end through guide and connect to elbows inside spool wrapper. (See drawing below.)

5. Wind the hose onto the reel spool by hand rotating spool in direction it turns free of spring tension. (Normally clockwise when viewed from spring side)

6. Adjust hose stop (not used on machine pull reel).

7. Complete working end connections.

8. Pretension reel and complete installation as described in **REEL INSTALLATION** section.

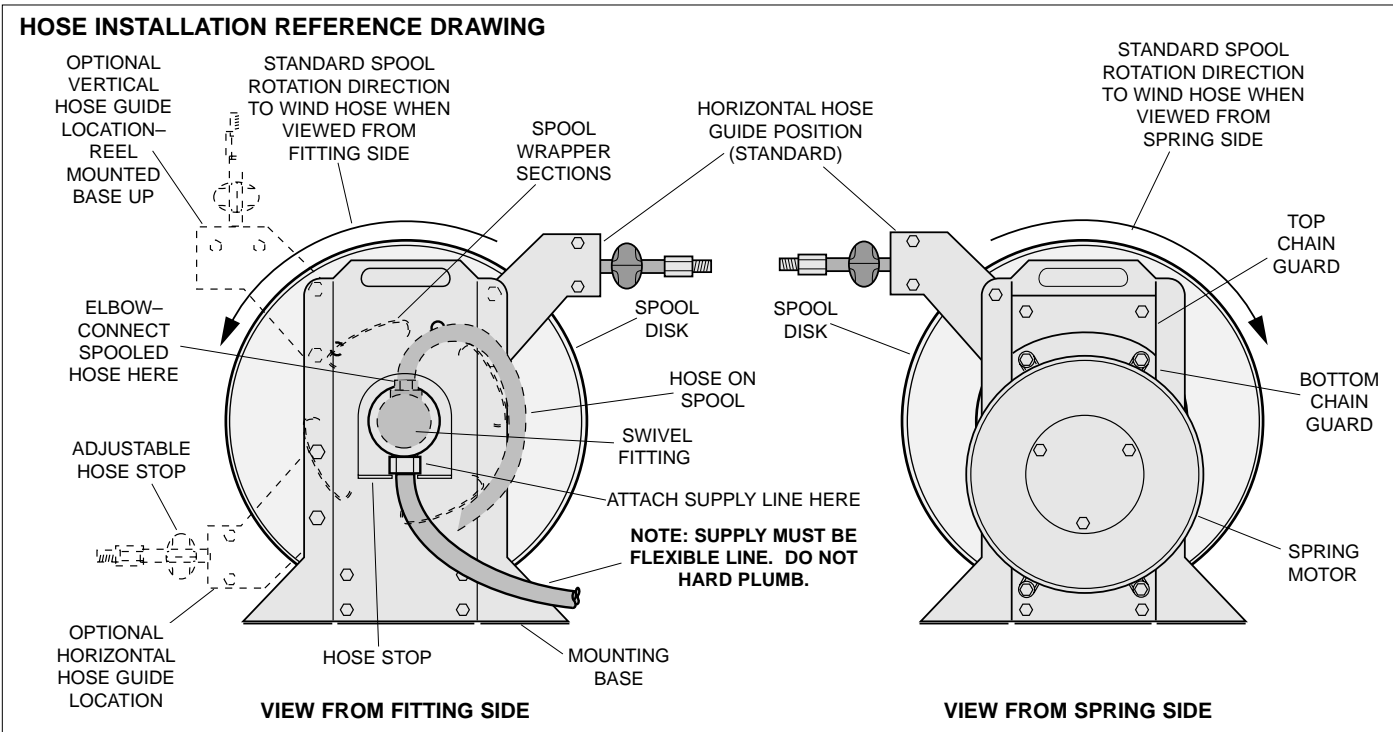

GLEASON REEL CORP.
600 South Clark St.
Mayville, WI 53050-0026
Phone 920-387-4120 • Fax 920-387-4189