

Series 55 Rotary Limit Switches



Workplace Solutions

Adjustment and Maintenance Instructions

Standard and Long Dwell Cams

OPERATION

Rotation of drive shaft (D) in either direction causes all cam gear assemblies (I) to turn, actuating the contact blocks (K). A timing line appears in the notch (J) when the corresponding contact block is actuated. Cam for each contact block is independently adjustable. Each contact block contains one normally open and one normally closed contact set.

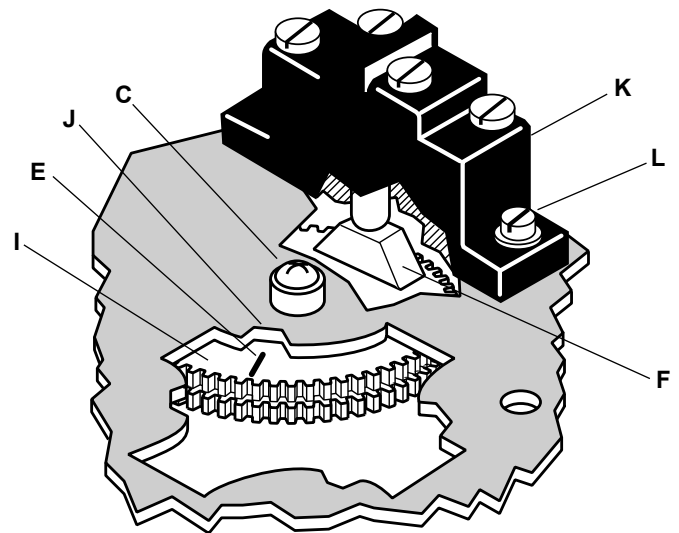
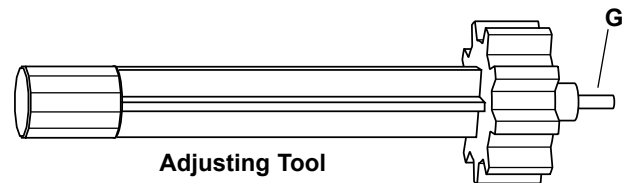
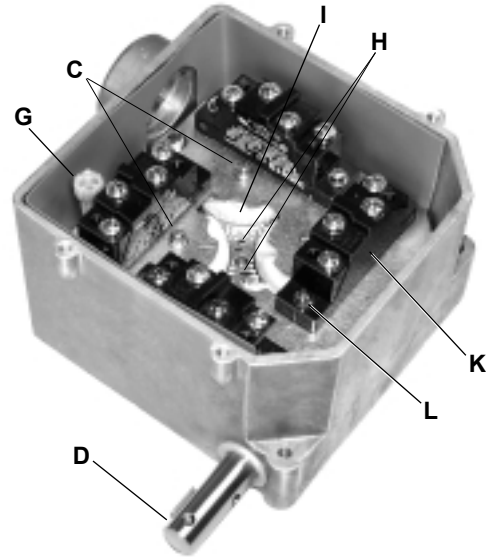

WARNING

Hazardous Voltage. Can cause death, serious personal injury, or property damage.

Disconnect power before working on this equipment.

CAUTION

When mounting Rotary Limit Switch, align drive shaft (D) with coupling to minimize stress on shaft and bushings.

DO NOT USE HAMMER OR SIMILAR TOOL TO FORCE COUPLING OR SPROCKET ONTO DRIVE SHAFT.

Excessive stress on shaft may result in damage to rotary limit switch and could invalidate warranty.

ADJUSTMENT

1. Operate the equipment until the desired travel limit is reached, taking into account coasting or braking distance.
2. Loosen the screw (C) for the cam wheel which actuates the contact block you wish to adjust.
3. Insert the adjustment tool (G) into the guide hole (H) closest to the cam wheel being adjusted. Engage teeth on adjustment tool with teeth on cam wheel.
4. Rotate adjusting tool, either direction, until the black line (E) appears in the notch (J). This will be the approximate position at which the contact block will be actuated.
5. Tighten the cam screw (C). Avoid over-tightening which could damage screw and screw threads.

CAUTION

Terminal of individual snap switch must be wired same polarity.

Contact Block Terminals Viewed from Top

A: Terminals N.C. B: Terminals N.O.

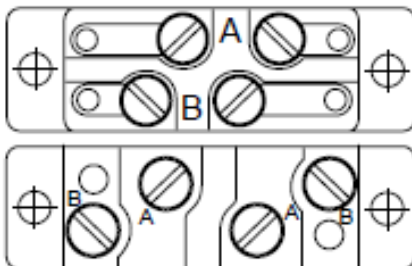

NOTE:

Limit switch may be equipped with contact blocks manufactured by Square D (top) or Micro Switch (bottom). Use drawings at left as guides when wiring.

Legend

- *C - Cam Screw
- D - Drive Shaft
- E - Black Timing Line
(Black on white cam for Standard Dwell. White on black cam for Long Dwell)
- *F - Cam
- *G - Adjustment Tool
- H - Guide Hole
- *I - Cam Gear Assembly
(White for Standard Dwell. Black for Long Dwell)
- J - Notch
- *K - Contact Block
- *L - Contact Block Screws

*Replacement parts available (consult factory).

CIRCUIT OPERATION

Switch Terminals	Position of Line* on Cam Gear	
	Not in Notch	In Notch
A – NC		
B – NO		

*Timing line is black on white standard dwell cam.
Line is white on black long dwell cam.

Replacement Parts Available (Consult Factory)

	Contact Block Kit*	Cat. No.
	Standard Cam	54BBGB
	Long Dwell Cam	54EBGB

*Includes contact block, cam & screws

	WARNING
	Hazardous Voltage. Can cause death, serious personal injury, or property damage. Disconnect power before working on this equipment.

CONTACT BLOCK KIT INSTALLATION

1. Remove switch cover (T) and disconnect wiring to contact blocks.
2. Remove switch mounting plate (R) which is secured by three regular screws (Q) and one green ground terminal screw (P).
3. Lift out old cam gear assembly (I) and replace with a new assembly.
4. Place switch mounting (R) into switch housing and secure with four screws (Q & P).
5. Identify the contact block which corresponds to new cam gear assembly. Remove two machine screws which secure that contact block to switch mounting plate.
6. Install new contact block and contact block screws.
7. Adjust cam gear assembly as outlined on page one (over).
8. Connect wiring to new contact block and replace switch cover.

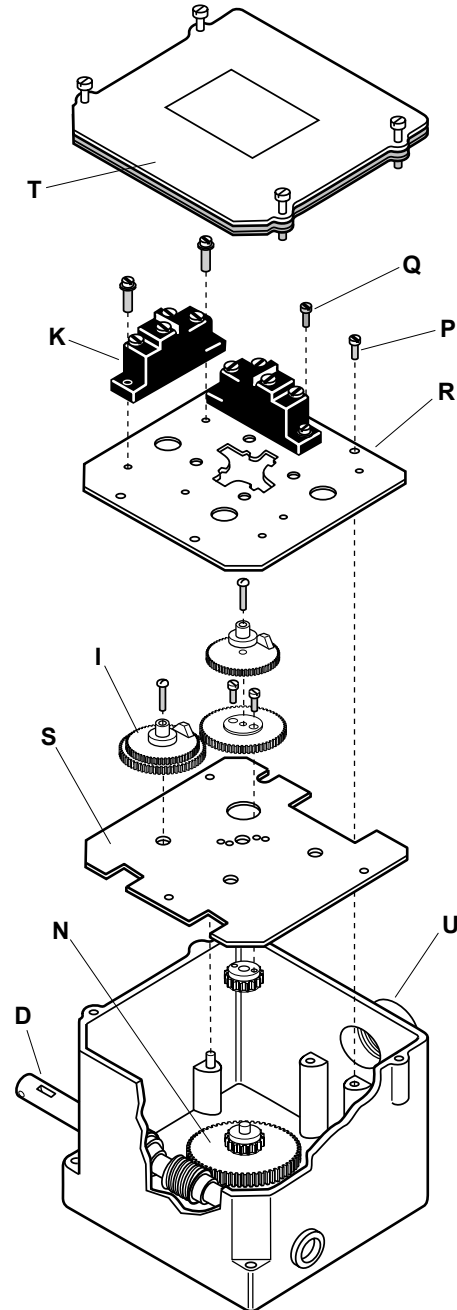

Legend

D - Drive Shaft Assembly	Q - Top Plate Screws
I - Cam Gear Assembly	R - Switch Mounting Plate
K - Contact Block and (2) 6-32 x 1/2" screws	S - Cam Mounting Plate
N - Helical/Cam Drive Gear Assembly	T - Cover
P - Ground Screw	U - Threaded Outlet



Workplace Solutions

Gleason Reel Corp.
600 South Clark Street
Mayville, WI 53050
Phone: 920-387-4120
FAX: 920-387-4189
www.gleasonreel.com

Part No. 630535.c