



GAI-TRONICS®
A HUBBELL COMPANY

SP2 Remote Subset/Speaker Amplifier Station

TABLE OF CONTENTS

<i>Confidentiality Notice</i>	<i>1</i>
<i>General Information</i>	<i>1</i>
Product Overview	1
Features	2
Options	2
Subsets	3
<i>Installation</i>	<i>3</i>
Important Safety Instructions	3
Mounting the Enclosure	4
Cable Entries	4
Opening the Station	5
Field Wiring and Configuration	5
Station Ground	5
Termination PCBA Connections	6
Direct Speaker Connection and Jumper Settings	6
70 V / 100 V Termination Board Option—Speaker Connections with Monitoring	8
RTU Inputs.....	9
RTU Output	10
Power	11
Main PCBA.....	11
600-Ohm Audio I/O with Control.....	11
Ethernet Termination	12
<i>Settings and Adjustments</i>	<i>13</i>
Opening the Station	13
Main PCBA Configuration	13
Write Protect (EEPROM) Jumper.....	13
WDOG Enable (Watchdog) Jumper	13
Boot Enable Jumper	13
Reset Switch.....	14
Speaker and 600-ohm Audio Output Volume.....	14
Receiver Volume	15
Group and Station Number Selector Switches.....	15
Main PCBA Indicators	15
Power LED.....	15
Heartbeat LED	15

Ethernet Connection LEDs	15
Five Configurable LEDs	16
Attaching the Front Cover	16
<i>Programming</i>	<i>16</i>
<i>Remote Subset Operation</i>.....	<i>16</i>
Standard Handset Paging.....	16
Party Line Communication.....	16
<i>Maintenance</i>.....	<i>17</i>
Troubleshooting	17
Service	18
Replacement Parts	18
<i>Specifications</i>	<i>18</i>
<i>Approvals</i>.....	<i>20</i>



GAI-TRONICS®
A HUBBELL COMPANY

SP2 Remote Subset/Speaker Amplifier Station

Confidentiality Notice

This manual is provided solely as an installation, operation, and maintenance guide and contains sensitive business and technical information that is confidential and proprietary to GAI-Tronics. GAI-Tronics retains all intellectual property and other rights in or to the information contained herein, and such information may only be used in connection with the operation of your GAI-Tronics product or system. This manual may not be disclosed in any form, in whole or in part, directly or indirectly, to any third party.

This product contains copyrighted computer programs stored in semiconductor memory. These programs are copyrighted by GAI-Tronics Corporation and may not be reproduced in any form without express written permission from GAI-Tronics.

General Information

Product Overview

The GAI-Tronics SP2 station is a modular industrial multicast VoIP (Voice over Internet Protocol) communication system. The standard Remote SP2 configuration is an indoor handset/speaker amplifier station using ac power with RTU control. The SP2 Remote Handset/Speaker Amplifier Station is designed to be used in conjunction with a remote subset. They are constructed of cold rolled steel with a gray or safety orange powder coat finish. A number of options are available to add to or modify station capabilities (see the Features and Options below for more details).

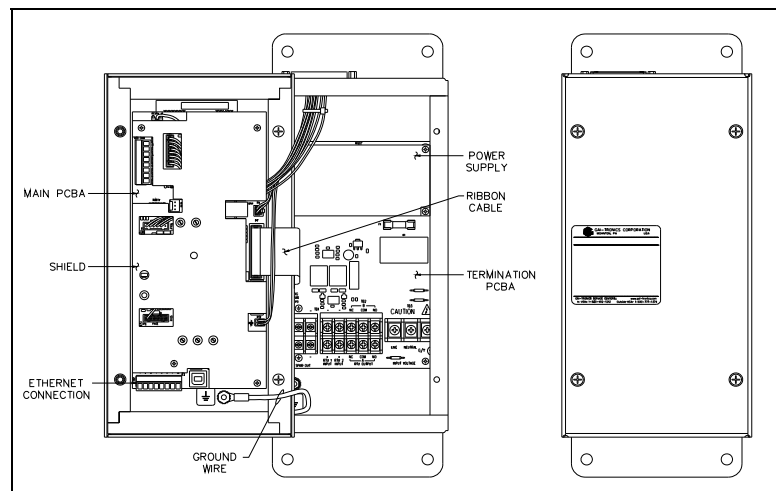

Figure 1. SP2 Remote Station Front Panel

SP2 stations connect to an Ethernet network so the loss of a single station will not adversely affect the system as a whole. The stations require a 100 Mbps link to a switch or router using Category 5 or better Ethernet cable. To ensure the quality of SP2 audio, it is recommended that SP2 network traffic be isolated from other devices and that network switches and routers be properly configured for IGMP (Internet Group Management Protocol) snooping and multicast filtering. Maximum cable runs between fiber SP2 stations and network switches are limited to 100 meters to comply with Ethernet standards.

Features

- flexible and highly configurable SMART technology featuring ALS (ambient level sensing), real time self-diagnostics, and available remote monitoring
- real-time operation providing instantaneous page and party line communication
- no SIP server or conference bridge requirement
- one-way live paging and alarm annunciation over system speakers
- distributed amplifier topology—loss of an individual amplifier will not adversely affect the system as a whole
- mutual provisioning mode allows easy system deployment
- high efficiency (>80%) Class D paging amplifier provides up to 30 watts of speaker output at 8 ohms
- five configurable multicast channels for full-duplex conference communication with party line selector switch
- eight configurable multicast channels for receiving page announcements
- one isolated output for beacon activation
- two isolated inputs (one isolated input with optional 70V/100V termination PCBA)
- 600-ohm audio I/O with control
- configurable priority scheme allows urgent/emergency pages to override less important pages
- configuration stored in non-volatile memory
- field adjustable volume control for handset earpiece, headset earpiece, and speaker amplifier
- configurable local and nearby speaker mutual muting to prevent acoustic feedback of live pages
- configurable pre-announcement tone
- off-hook and page switch timeout functionality
- configurable virtual zoning ability
- USB interface for field or bench configuration
- universal ac power supply
- durable, high visibility, safety orange powder coat finish.

Options

All SP2 Station options are factory installed.

- 70/100V constant voltage termination board with 24-watt monitored output
- 24 V dc power supply
- speaker amplifier only (no remote station)
- conformal coating for PCBA
- gray powder-coat finish

Subsets

For proper operation, the SP2 Remote Handset/Speaker Amplifier Station must be installed with a remote subset configuration from the following list:



- single or multi-party desktop subset
- single or multi-party desk-edge subset
- single or multi-party flush-mount subset



The SP2 Remote Subset must be mounted within 10 feet of the subset due to the subset cable limitations. In addition, the amplifier enclosure must be mounted at an indoor location—the amplifier enclosure is not designed for outdoor use.

Installation

Important Safety Instructions

- Read, follow, and retain instructions—All safety and operating instructions should be read and followed before operating the unit. Retain instructions for future reference.
- Heed warnings—Adhere to all warnings on the unit and in the operating instructions.
- Attachments—Attachments not recommended by the product manufacturer should not be used, as they may cause hazards.
- Servicing—Do not attempt to service this unit by yourself. Opening or removing covers may expose you to dangerous voltage or other hazards. Refer all servicing to qualified service personnel.

 **ATTENTION**  —Install equipment without modification and according to all applicable local, national and international electrical codes. North America - Consult the National Electrical Code (NFPA 70), Canadian Standards Association (CSA 22.1), and local codes for specific requirements regarding your installation. Class 2 circuit wiring must be performed in accordance with NEC 725.55.

 **WARNING**  —In 24 V dc systems: Under NO condition should this equipment be operated from a battery charger without the batteries connected.

In 24 V dc systems, most chargers have an unloaded output of 35 to 45 volts that can quickly damage the equipment designed for nominal 24 volts. The maximum battery voltage should never exceed the maximum specified input voltage.

 **WARNING**  —**Do not disconnect equipment while energized.**
Insure proper grounding to protective earthing.

These enclosures must be installed by trained, qualified and competent personnel. Installation must comply with state and national regulations, as well as safety practices for this type of equipment. The mounting location must be flat and provide proper clearance, rigidity and strength to support the enclosure and all contained devices.

Mounting the Enclosure

Mount the enclosure using the four 0.312-inch (8 mm) diameter holes located on the mounting flanges with ¼-inch (M6) hardware. The standard SP2 Remote station is not supplied with conduit or cable openings.

Cable Entries

Remove the front panel and drill or punch entry openings in the rear section of the enclosure. The station is suitable for top and/or bottom entry (see [Figure 2](#)); however, bottom entry is recommended to prevent moisture from dripping onto the termination board. There must be a minimum of ½ inch (13 mm) of material between entry holes.

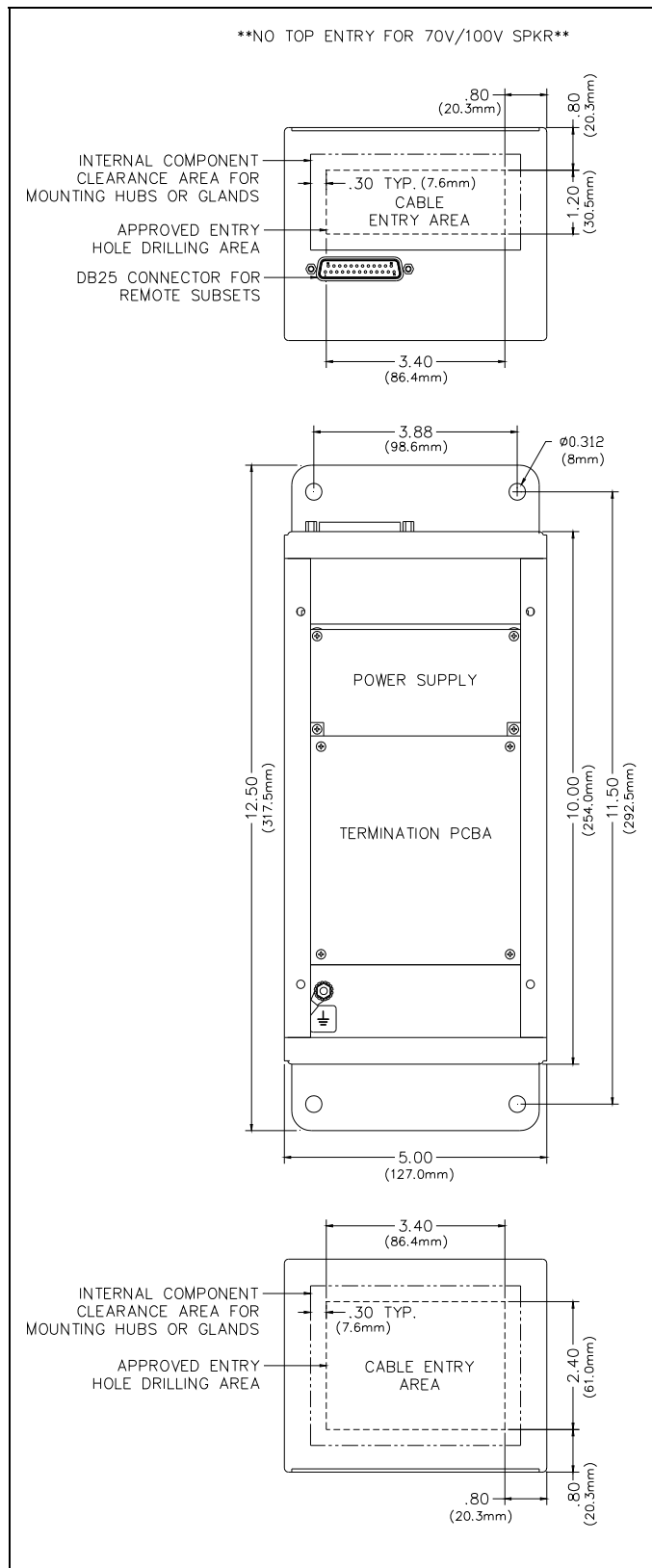

Figure 2. Suggested Wire Entry Locations

Opening the Station

Complete the following steps to open the station:

1. Remove the four screws from the front panel and turn it to the left to expose the interior surfaces.
2. Keep the wiring and ribbon cables connected.
3. Mount the front panel to the back box's left-side mounting holes using two of the screws just removed.

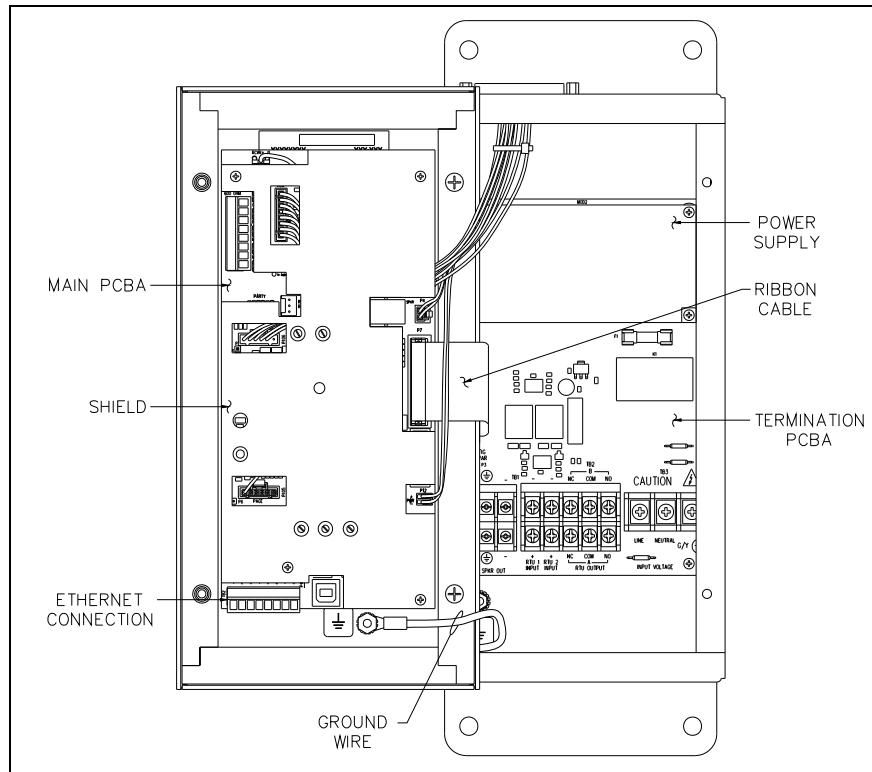

Figure 3. SP2 Standard Remote Station—Interior View

Field Wiring and Configuration

The SP2 Standard Remote Station provides terminal blocks on the Termination PCBA located in the rear of the enclosure for field wiring the power, speaker, and RTU connections. The Main PCBA, mounted to the back of the front panel, provides the 600-ohm audio connection. The fiber termination board is mounted on top of the Main PCBA and provides fiber optic termination for the Ethernet SFP Transceiver.

NOTE: Consult the National Electrical Code (NFPA 70), Canadian Standards Association (CSA 22.1), and local codes for the specific requirements regarding your installation. Install all equipment without modification and according to the local and national codes. Class 2 circuit wiring must be performed in accordance with NEC 725.55.

Station Ground

The station enclosure must be connected to earth ground.

1. Install a #6 ring lug on the ground conductor.
2. Secure it to the ground terminal located in the lower left corner at the back of the rear enclosure (see [Figure 3](#)).

Termination PCBA Connections

Install all connections as indicated in the following sections:

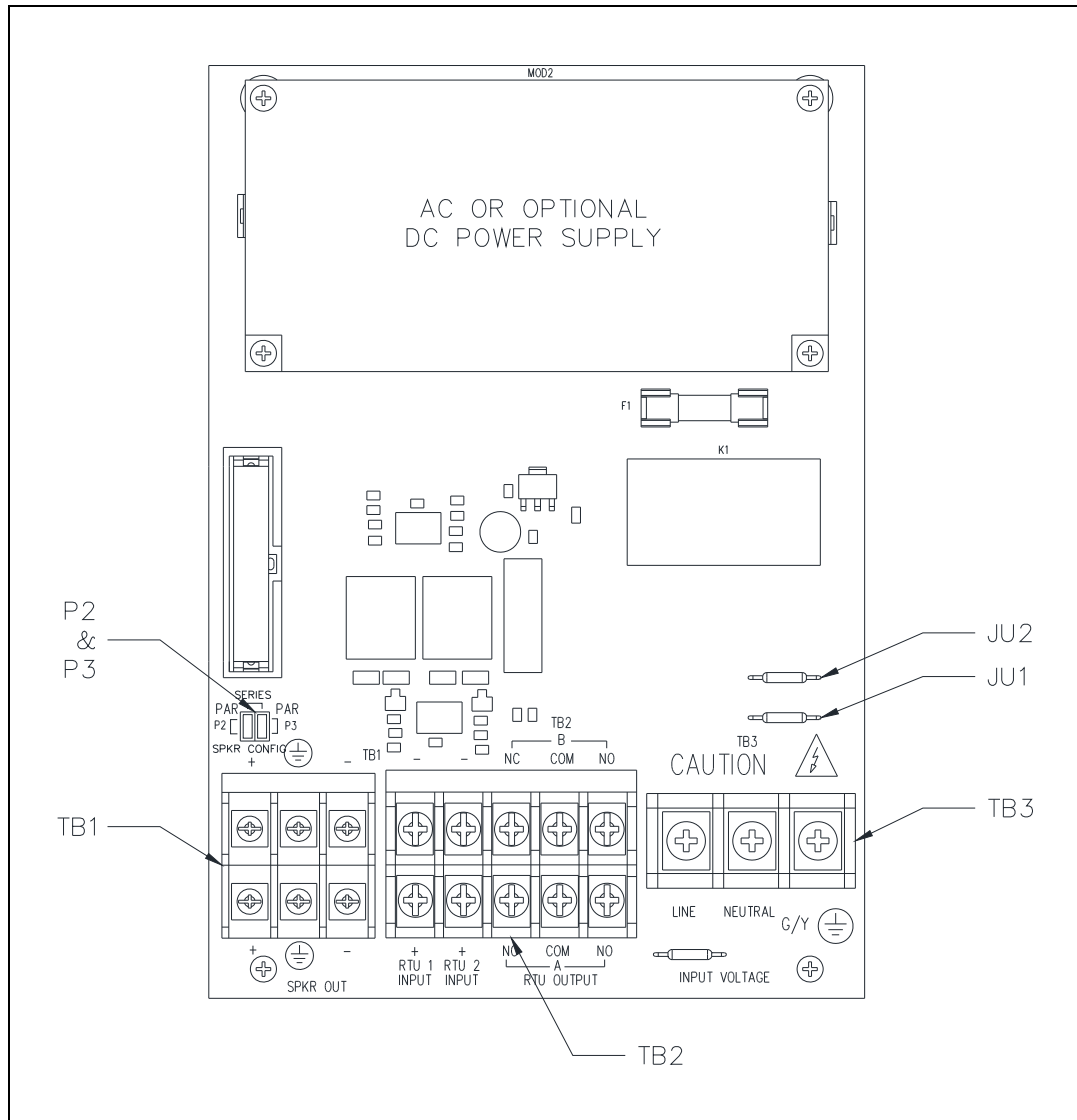

Figure 4. SP2 Standard Termination PCBA
(Optional 70V/100V Termination PCBA Similar)

Direct Speaker Connection and Jumper Settings

Terminal block TB1 provides termination for the station's 8 or 16-ohm remote speaker(s).

1. Pull the speaker cable(s) into the enclosure.
2. Connect spade lugs to the wires.
3. Install the speaker wires to terminal block TB1 in accordance with the table below.
4. Torque the terminal block screws to 8–10 in·lb (0.90–1.13 N·m).
5. Configure the speaker jumpers; P2 and P3, for the appropriate impedance for use with 8-ohm or 16-ohm speakers (see [Figure 4](#) and [Figure 5](#)).

A redundant set of terminals is provided for a second speaker branch that can be connected in series or parallel with the primary speaker.

Table 1. Direct Speaker Connections—TB1

Pin	Label	Description
TB1-1	+	Primary Parallel/SPEAKER A Series—Output
TB1-2	⊥	Earth Reference
TB1-3	-	Primary Parallel/SPEAKER A Series—Output
TB1-4	+	Secondary Parallel/SPEAKER B Series—Output
TB1-5	⊥	Earth Reference
TB1-6	-	Secondary Parallel/SPEAKER B Series—Output

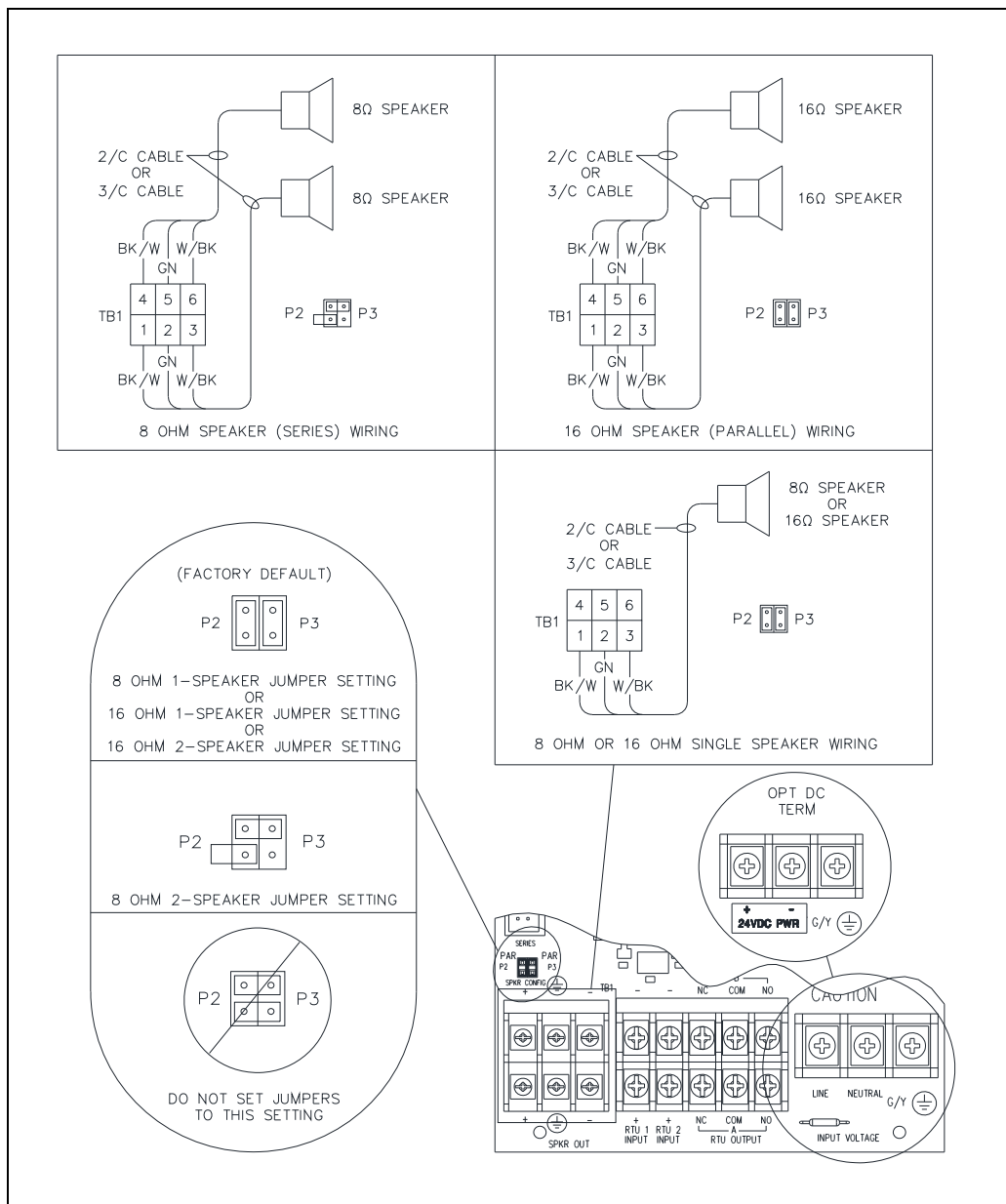

Figure 5. 8/16-ohm Speaker Impedance Configuration and AC/DC Termination at TB3

**70 V / 100 V Termination Board Option—
Speaker Connections with Monitoring**

The optional 70V/100V Speaker Line Monitoring PCBA replaces the standard termination board and provides for connection of 70-volt and/or 100-volt speakers to the SP2 Station. Terminal block TB1 provides termination for the station’s speaker loop(s). All speakers must be wired in parallel. One speaker loop can be monitored by terminating the return cable to the LINE SPRVN terminals on TB2 (see [Figure 4](#), [Figure 6](#), and [Table 2](#)).

1. Pull the 70 volt and/or 100 volt speaker cable(s) into the enclosure.
2. Connect spade lugs to the wires.
3. Connect 100-volt speakers to the 100V and COM terminals on TB1. Connect 70-volt speakers between the 70V and COM terminals on TB1.

Two sets of terminals exist for the 70 V and 100 V speaker loops providing termination for additional speaker loops.

NOTE: An SP2 station can only monitor one speaker loop.

4. For speaker line supervision, connect the speaker return wires to the LINE SPRVN + and – terminals at TB2 (see [Table 4](#)).
5. Torque the terminal block screws to 8–10 in·lb (0.90–1.13 N·m).

NOTE: The combined wattage (tap settings) for all speakers must never exceed the amplifier power rating (24 W).

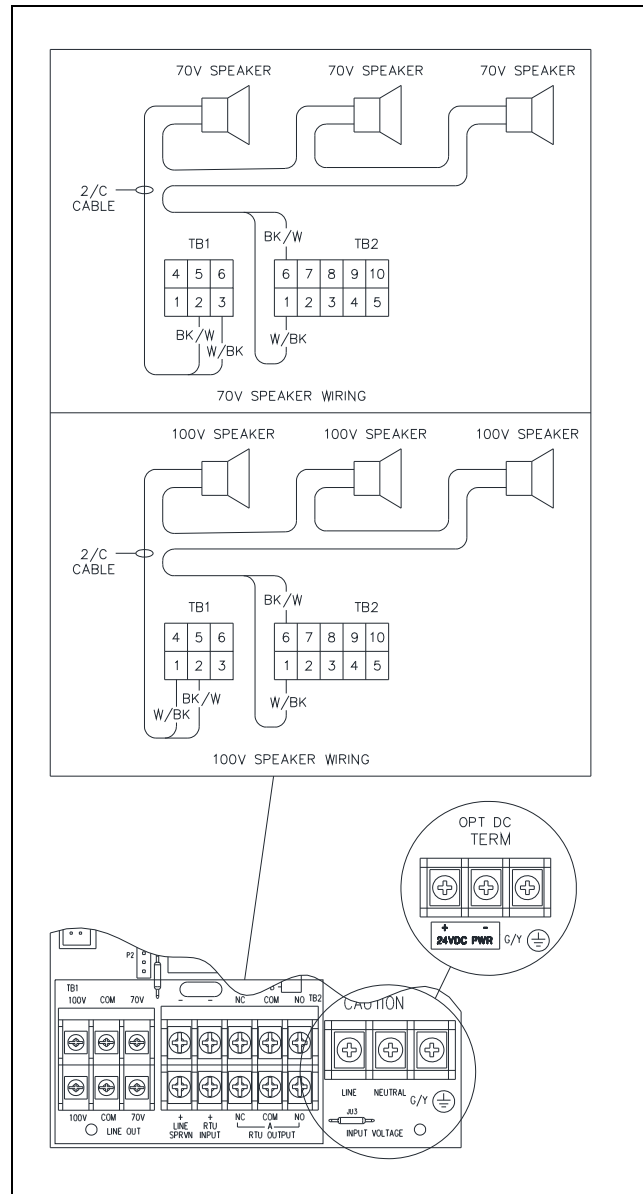

Figure 6. 70 V/100 V Termination Board Wiring

Table 2. 70 V/100 V Speaker Connections—TB1

Pin	Label	Description
TB1-1	100V	100 V Parallel Speakers—Output
TB1-2	COM	Earth Reference
TB1-3	70V	70 V Parallel Speakers—Output
TB1-4	100V	100 V Parallel Speakers—Output
TB1-5	COM	Earth Reference
TB1-6	70V	70 V Parallel Speakers—Output

RTU Inputs

The standard Termination PCBA contains two auxiliary RTU inputs. The optional 70V/100V termination board provides for speaker line monitoring and is equipped with just one auxiliary RTU input. These inputs are terminated at terminal block TB2 (see [Figure 4](#)).

1. Pull the RTU Input cable(s) into the enclosure.
2. Connect spade lugs to the wires.
3. Install the RTU Input wires to terminal block TB2 (see [Table 3](#) or [Table 4](#)).
4. Torque the terminal block screws to 8–10 in·lb (0.90–1.13 N·m).
5. Install end-of-line resistors as shown to enable RTU input-cable monitoring (see [Figure 7](#)):

Table 3. Standard Termination Board
RTU Input Termination—TB2

Pin	Label	Function
TB2-1	+ RTU 1 INPUT	RTU Input 1 +
TB2-2	-	RTU Input 1 -
TB2-3	+ RTU 2 INPUT	RTU Input 2 +
TB2-4	-	RTU Input 2 -

Table 4. 70V/100V Termination Board
Speaker Line Monitoring and RTU Input
Termination—TB2

Pin	Label	Function
TB2-1	+ LINE SPRVN	70 V/100 V Supervision +
TB2-2	-	70 V/100 V Supervision -
TB2-3	+ RTU INPUT	RTU Input +
TB2-4	-	RTU Input -

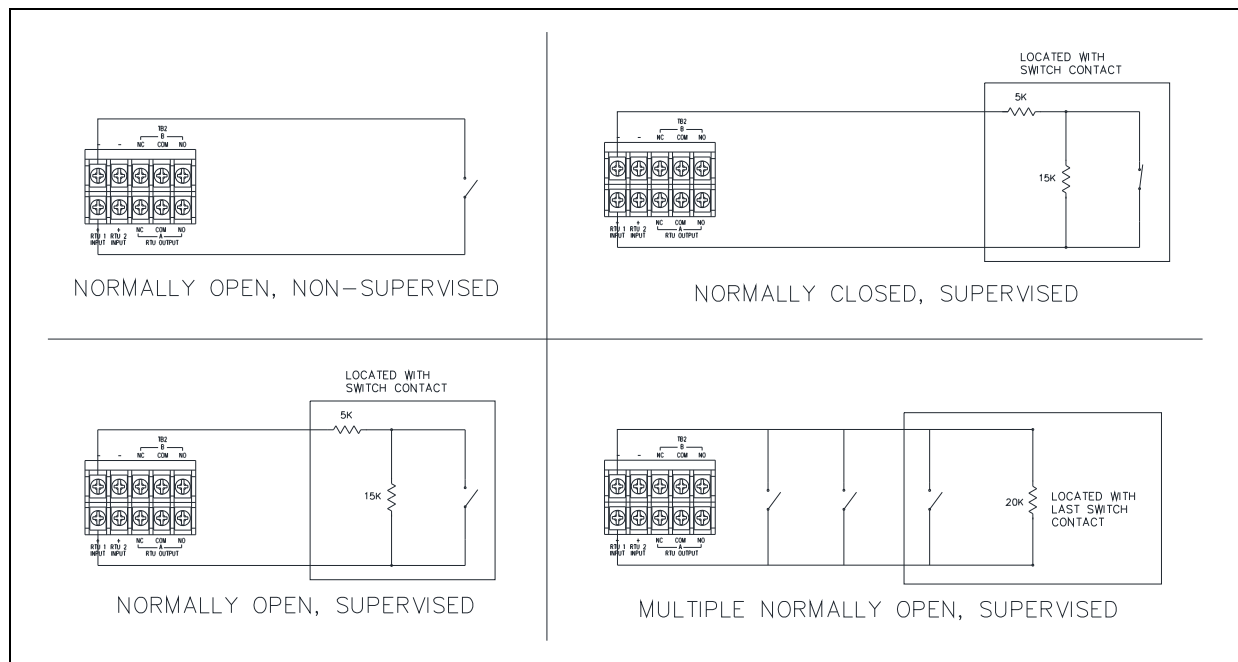

Figure 7. RTU Input Wiring Configurations for Cable Monitoring

RTU Output

Two Form “C” contacts are provided to power a beacon (see [Figure 8](#)). These outputs can be reconfigured for dry contact use by removing jumpers JU1 and JU2. Terminations for these outputs are provided at terminal board TB2 on the Termination PCBA (see [Figure 4](#)).

⚠ WARNING ⚠ —Line voltage is present at the NO contact until JU1 and JU2 are removed.

1. Pull the RTU Output cable into the enclosure.
2. Connect spade lugs to the wires.
3. Install the RTU Output wires to terminal block TB2 (see [Table 5](#)).
4. Torque the terminal block screws to 8–10 in·lb (0.90–1.13 N·m).

For beacon cable monitoring:

5. Install a 20-kilohm 10-watt resistor across the terminals of the beacon cable (see [Figure 8](#)).
6. Install jumpers at TB2 as shown below to enable cable monitoring.

NOTE: If an RTU Input is used to monitor beacon wiring then it is not available for other functions.

Table 5. RTU Output Contacts—TB2

Pin	Label	Description
TB2-5	NC A	Normally Closed Output A
TB2-6	NC B	Normally Closed Output B
TB2-7	COM A	Common Output A
TB2-8	COM B	Common Output B
TB2-9	NO A	Normally Open Output A
TB2-10	NO B	Normally Open Output B

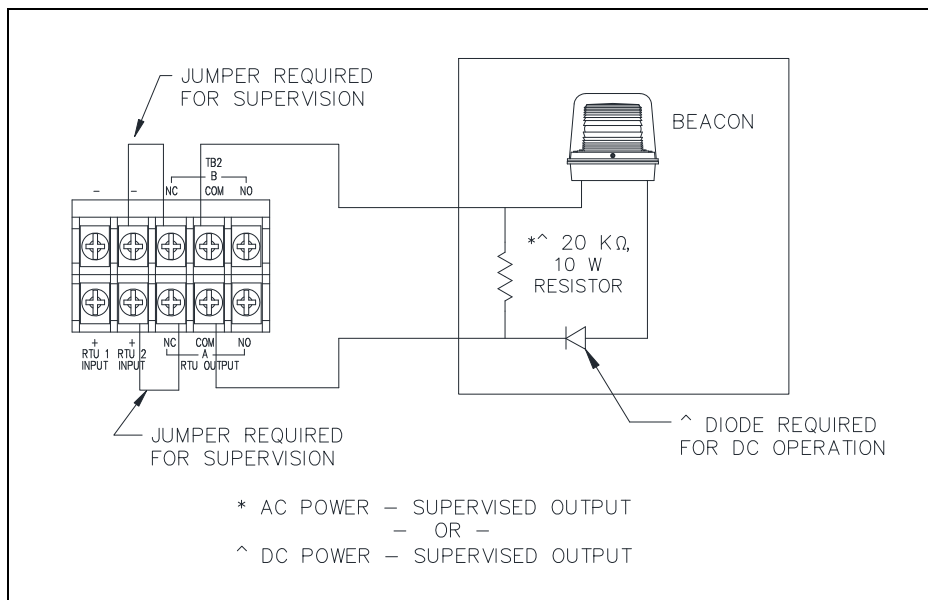

Figure 8. Supervised Output Wiring—TB2

Power

The ac or optional dc power supply is mounted on the Termination PCBA. The termination PCBAs include terminal block TB3 for connecting the local power source to the station (see [Figure 4](#)):

1. Pull the cable from the power source into the enclosure.
2. Connect spade lugs to the wires.
3. Connect the conductors from the ac or dc power source to the appropriate terminals at terminal block TB3:

Table 6. AC Power—TB3

Pin	Label	Description
TB3-1	LINE	Positive
TB3-2	NEUTRAL	Negative
TB3-3	⏏	Earth ground

Table 7. DC Power—TB3

Pin	Label	Description
TB3-1	+	Positive
TB3-2	-	Negative
TB3-3		No Connection

Main PCBA**600-Ohm Audio I/O with Control**

SP2 stations provide a 600-ohm audio input to facilitate broadcasting line level audio over the page line. A control input exists that requires a normally open dry contact closure to enable the station to broadcast the 600-ohm input audio. SP2 stations also provide a 600-ohm audio output for sending page line audio to a remote audio amplifier. A solid state dry contact relay is provided that can be used to control when the remote audio amplifier plays the audio.

1. Pull the cable for the 600-ohm audio I/O into the enclosure.
2. Install ferrules onto the wire ends.
3. Connect the 600-ohm audio wires to the pluggable terminal block for the 600-ohm audio I/O connection (see [Table 8](#) and [Figure 9](#)).
4. Connect the pluggable terminal block to terminal block receptacle TB1.

Table 8. 600-Ohm Audio I/O Interface Connections—TB1

Pin	Label	Description
TB1-1	IN CT1+	Input Control Positive
TB1-2	IN CT1-	Input Control Negative
TB1-3	IN AUD+	Input Audio Positive
TB1-4	IN AUD-	Input Audio Negative
TB1-5	OUT AUD+	Output Audio Positive
TB1-6	OUT AUD-	Output Audio Negative
TB1-7	OUT CT1+	Output Control Positive
TB1-8	OUT CT1-	Output Control Negative

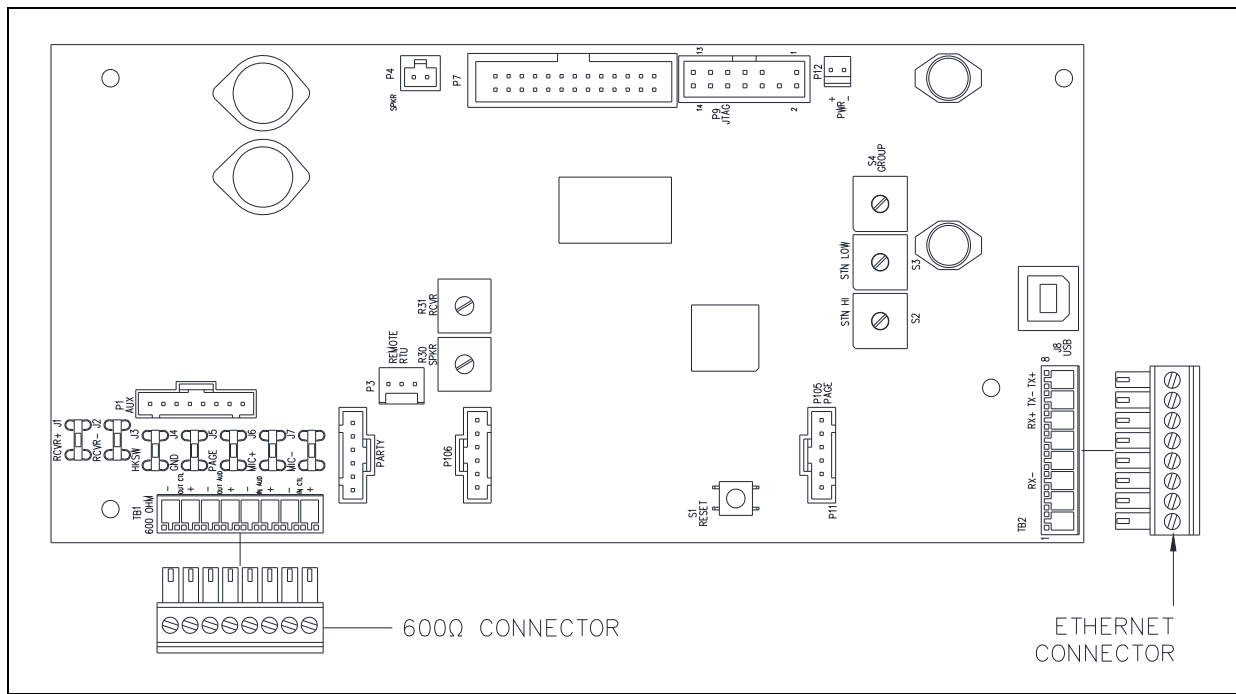

Figure 9. SP2 Main PCBA (Ethernet)

Ethernet Termination

1. Pull a dedicated Category-5 or better Ethernet cable into the rear enclosure.
2. Install ferrules onto the wire ends.
3. Connect the Ethernet cable to the 8-position pluggable terminal block.
4. Connect the pluggable terminal block to the Main PCBA terminal block TB2 (see [Figure 9](#)).

NOTE: Shielded Ethernet cable or metallic conduit is required for installation.

Table 9. Ethernet Connection—TB2

Pin	Label	Description
TB2-1		Unused
TB2-2		Unused
TB2-3	RX-	Data Receive -
TB2-4		Unused
TB2-5		Unused
TB2-6	RX+	Data Receive +
TB2-7	TX-	Data Transmit -
TB2-8	TX+	Data Transmit +

Settings and Adjustments

Opening the Station

Complete the following steps to open the station:

1. Remove the four screws from the front panel and turn it to the left to expose the interior surfaces.
2. Keep the wiring and ribbon cables connected.
3. Mount the front panel to the back box's left-side mounting holes using two of the screws just removed.

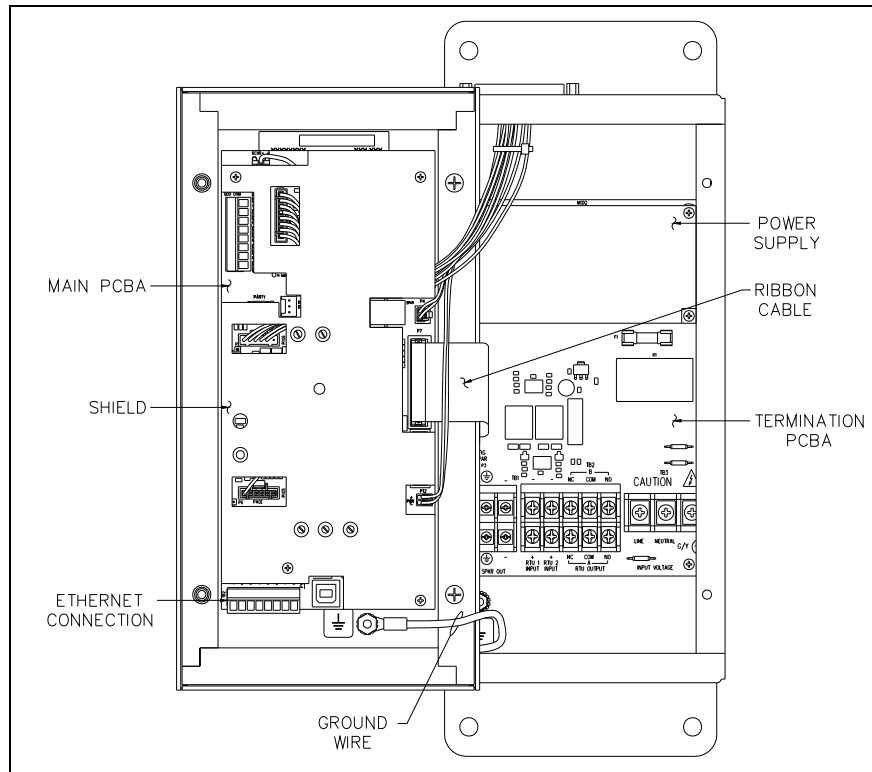

Figure 10. SP2 Standard Remote Station—Interior View

Main PCBA Configuration

Refer to [Figure 11](#) for switch, jumper, and LED locations on the Main PCBA.

Write Protect (EEPROM) Jumper

NOTE: This jumper should not be changed in the field.

WDOG Enable (Watchdog) Jumper

Watchdog jumper, P11, enables a watchdog feature for software purposes and should not be adjusted in the field. The default setting is installed.

Boot Enable Jumper

Jumper P8 – BOOT, is required for development purposes and should not be adjusted in the field. The default setting for this jumper is open.

Reset Switch

Reset switch, S1 reboots the station to its initial state. All configuration settings remain programmed.

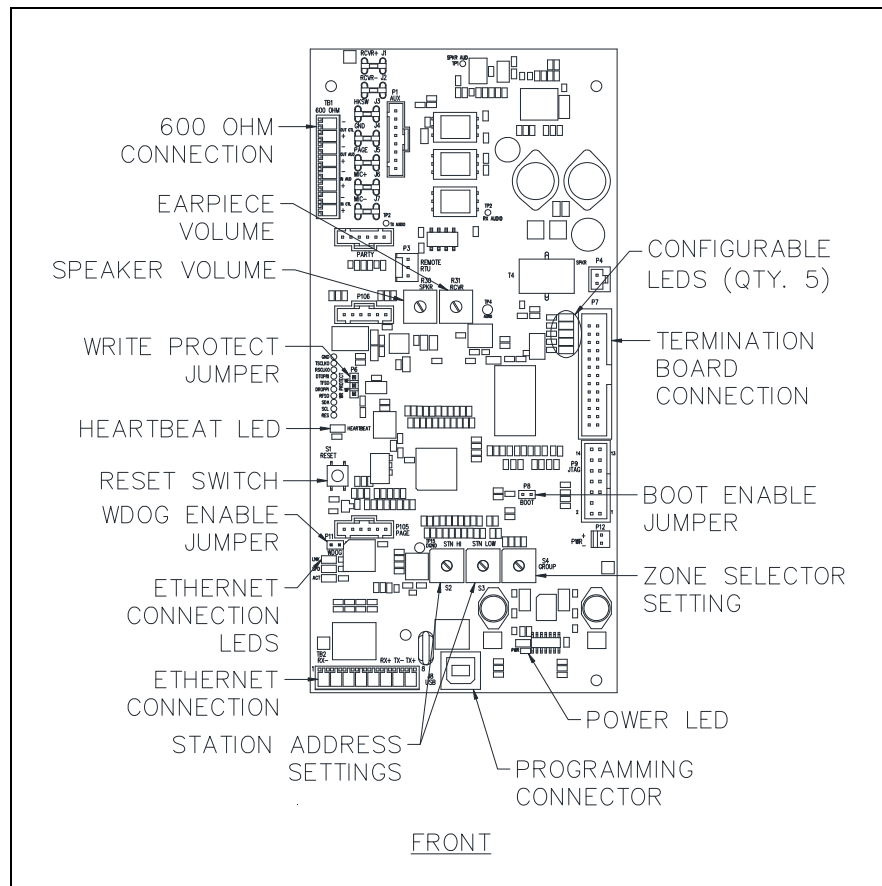

Figure 11. Main PCBA—Remote Subset SP2 Station

Speaker and 600-ohm Audio Output Volume

The speaker volume potentiometer, R36, adjusts the signal level to the speaker from the page line. When 600-ohm audio is also connected, R36 will adjust the volume for both. If only 600-ohm audio is utilized then the volume for the 600-ohm audio must be configured via the CLI (Command Line Interface). The default setting is 4 watts from an 8-ohm speaker and 2 watts from a 16-ohm speaker.

⚠ WARNING ⚠ —Maximum output power may exceed rated speaker wattage resulting in speaker damage.

To adjust the speaker or speaker and 600-ohm output volume:

1. Turn the SPKR speaker volume potentiometer R36 fully counter-clockwise. An audible test-tone will be heard from the speaker.
2. Slowly turn R36 clockwise until the desired output volume is reached. The test-tone ceases three seconds after no adjustment has been made.

This setting can also be configured via USB or Ethernet connection using the CLI.

NOTE: This setting is overridden if it is configured for the station using the SP2 Console in a mutually provisioned system. See the SP2 Configuration Guide, Pub. 42004-784.

Receiver Volume

The Receiver Volume is adjusted using the RCVR potentiometer R37. To adjust the volume for the handset:

1. Remove the handset from the cradle.
2. Turn the RCVR potentiometer R37 fully counter clockwise. An audible test-tone will be heard in the handset.
3. Slowly turn R36 clockwise until the desired output volume is reached. The test-tone ceases three seconds after no adjustment has been made.

This setting can also be configured via USB or Ethernet connection using the CLI.

NOTE: This setting will be overridden if it is configured for the station using the SP2 Console in a mutually provisioned system. See the SP2 Configuration Guide, Pub. 42004-784.

Group and Station Number Selector Switches

One Group-Number and two Station-Number hex-selector switches are used to configure SP2 stations for Mutual Provisioning (see [Figure 11](#)). Each hex switch has a small arrow to indicate the current setting.

1. Adjust the position of the Group-Number selector switch to the desired group [0-F].
2. Adjust the two Station-Number switches to assign the station number [00–FF]. No two stations can be assigned the same address.

At least one SP2 station must be configured as a Master Station to utilize Mutual Provisioning in an SP2 system. Master stations must be assigned addresses [0.01], [0.02], or [0.03] using the selector switches. Master station(s) store the configuration of all SP2 stations on the network. As SP2 stations are powered on, they retrieve the mutual provisioning configuration from the master station. See Pub. 42004-784, SP2 Configuration Guide, for detailed information on configuring SP2 stations and SP2 system mutual provisioning. GAI-Tronics' product documentation is located on the GAI-Tronics website at <https://www.gai-tronics.com>.

Main PCBA Indicators

Power LED

The Power LED located on the Main PCBA illuminates when power is applied to the station indicating the main board power supply is operational (see [Figure 11](#)).

Heartbeat LED

The Heartbeat LED located on the Main PCBA will flash once communication over the LAN is established to indicate the microprocessor is operational (see [Figure 11](#)).

Ethernet Connection LEDs

Three Ethernet connection LEDs are located on the Main PCBA; Link (LNK), Link Speed (SPD), and Activity (ACT). The LNK LED is blue, the SPD LED is green, and the ACT LED is yellow. The LNK and SPD LEDs must be off to indicate that a 100 Mbps Ethernet link is active. The activity LED; ACT, will blink yellow to indicate Ethernet data activity (see [Figure 11](#)).

Five Configurable LEDs

Five LEDs are located on the Main PCBA (see [Figure 11](#)). These LEDs are configured through firmware. Information for configuring these LED indicators is provided in the SP2 Configuration Guide, Pub. 42004-784. GAI-Tronics' product documentation is located on the GAI-Tronics website at <https://www.gai-tronics.com>.

Attaching the Front Cover

After all adjustments have been completed, place the front cover onto the rear enclosure, being careful not to pinch any cables. Secure the front cover using the four screws and washers provided. Torque the screws to 50 in·lb (5.65 N·m).

Programming

SP2 stations are factory configured to provide basic Page/Party[®] functions upon power-up. For custom configurations and larger system designs the stations may need to be reconfigured. Refer to Publication 42004-784, SP2 Configuration Guide, located on the GAI-Tronics website at <https://www.gai-tronics.com>.

Remote Subset Operation

Standard Handset Paging

Complete the following steps to make a page announcement from an SP2 handset station:

1. Lift the handset from the cradle.
2. If party line conversation is desired, rotate the selector switch to an unoccupied party line.
3. Press and hold the handset pressbar.
4. After the short *preannouncement* tone is heard (if configured), speak directly into the microphone to broadcast your page announcement.

NOTE: SP2 stations incorporate a noise-canceling microphone to reduce transmitted ambient noise. This requires the user to place the microphone as close as possible to their mouth.

5. Release the handset pressbar and wait for a response on the party line (if requested) or replace the handset in the cradle.

Party Line Communication

To respond to a page:

1. Turn the selector switch on any SP2 station in the system to the requested party line.
2. Pick up the station handset and party line communication can occur.

NOTE: SP2 stations incorporate a noise-canceling microphone to reduce transmitted ambient noise. This requires the user to place the microphone as close as possible to their mouth.

3. Return the handset to the cradle following the party line conversation.

Party line conversations are not broadcast over the system speakers. Other individuals can join the conversation at any time by picking up a handset rotating the selector switch to the party line in use.

Maintenance

Troubleshooting

The following table is provided to aid qualified service personnel in troubleshooting problems with the SP2 Station.

Problem	Solution
station not functional	<ul style="list-style-type: none"> • check wiring and cable terminations • check power supply voltage at TB3 on Termination PCBA • Power LED on Main PCBA illuminated • Heartbeat LED blinking once per second for normal operation
network communication not functional	<ul style="list-style-type: none"> • verify LNK LED on main PCBA is off • verify SPD LED on main PCBA is off • verify IP connection settings using telnet • ping station IP address from an admin PC • verify network switch settings for Internet Group Management Protocol (IGMP) snooping and multicast filtering
remote subset handset receiver audio is too high/low	<ul style="list-style-type: none"> • adjust the <u>Receiver Volume</u> • check potentiometer R37 setting • check handset connections • check cable terminations between the Termination and Main PCBAs • check hookswitch operation • replace handset
speaker volume is too high/low	<ul style="list-style-type: none"> • adjust the <u>Speaker and 600-ohm Audio Output Volume</u> • check potentiometer R36 setting • P2 and P3 Termination PCBA jumper positions incorrect (see <u>Figure 5</u>) • check speaker wiring configuration on TB1 • replace the speaker or driver
RTU output is not functional	<ul style="list-style-type: none"> • verify no monitored output faults exist • check fuse F1 on the Termination PCBA • check connected device operation
RTU input does not function	<ul style="list-style-type: none"> • verify no monitored input faults exist • check <u>RTU Inputs</u> on TB2 • Check operation of connected device.

Service

If the equipment requires service or spare parts, contact your Regional Service Center for assistance. If service is required, a return authorization number (RA#) will be issued. Equipment should be shipped prepaid to GAI-Tronics with a return authorization number and a purchase order number. If the equipment is under warranty, repairs or a replacement will be made in accordance with GAI-Tronics' warranty policy. Please include a written explanation of all defects to assist our technicians in their troubleshooting efforts. Call 800-492-1212 inside the USA or 610-777-1374 outside the USA for help with identifying the Regional Service Center closest to you.

Replacement Parts

Part No.	Description
12508-002	Screw Kit (Qty. 32)

Specifications

Power

AC Input

Input voltage 120/230 V ac (nominal), 50/60 Hz

Power factor @ nominal 120 V ac 0.5

DC Input

Input voltage 24 V dc +/-20%

Power Consumed (8-ohm load)	120 V AC	230 V AC	24 V DC
Idle	80 mA/6.6 VA	50 mA/12 VA	165 mA/4.0 W
4-watt output (default setting)	150 mA/18 VA	110 mA/25 VA	460 mA/11.0 W
30-watt output	550 mA/65 VA	350 mA/80 VA	1.95 A/46.8 W
Maximum Current Consumed (8-ohm load)	108 V AC	253 V AC	19.2 V DC
30-watt output	600 mA/65 VA	370 mA/77 VA	2.44 A/46.8 W

Current/Power requirements (+/-10%)

Ethernet

Cable Category 5 or better

Speed 100 Mbps

Maximum Stations 4096

RTU**Output Control**

Maximum load current.....	8 A OUTPUT 1A (unfused) 1.6 A OUTPUT 1B (fused)
Maximum in-rush current	15 A
Maximum voltage	250 V ac

Input Control

Switch type	NO or NC dry contacts
End-of-line termination.....	20 k Ω , or 15 k Ω + 5.1 k Ω
Cable resistance	100 Ω maximum loop resistance
Contact closure resistance.....	1 k Ω maximum
Open fault detection.....	>65 k Ω
Short fault detection.....	<200 Ω

Audio**Handset Amplifier**

Frequency response.....	250–3,000 Hz, +0/–3 dB ref. to 1 kHz
Distortion	<1.5% THD @ 1 kHz
Receiver level.....	200 mV nominal, adjustable 100–350 mV

Speaker Amplifier

Maximum output:	
8-ohm speaker*	30 W into 8- Ω load with –6 dBfs data signaladjustable to 30 W; default: 4 W @ 8 Ω
16-ohm speaker	15 W into 16- Ω load with –6 dBfs data signaladjustable to 15 W; default: 2 W @ 16 Ω
Frequency response.....	250–3,000 Hz, +0/–3 dB ref. to 1 kHz
Distortion	<1% THD @ 1 kHz to 24 W <3% THD @ 1 kHz to 30 W

70V/100V Speaker Output

Maximum output.....	24 W
Nominal output voltage.....	70.7 V or 100 V

600-ohm Audio Input

Audio Level	1 V _(RMS) maximum
Control type	NO dry contact
Control cable resistance	1 k Ω maximum loop resistance

600-ohm Audio Output

Frequency response.....	250–3,000 Hz, +0/–3 dB reference to 1 kHz
Distortion	<1% THD @ 1 kHz to 1 V _(RMS) into 600 Ω
Audio level.....	adjustable 100 mV _(RMS) to 1 V _(RMS) into 600 Ω
Control type	NO solid state relay, maximum on resistance; 35 Ω
Control maximum load current.....	100 mA
Control maximum load voltage.....	24 V ac/dc

Mechanical

Construction/finish..... 16-gauge cold-rolled steel; safety orange polyurethane
 Mounting..... wall or column, four 0.31-inch (7.8 mm) mounting holes
 Termination connections..... screw-type barrier terminal blocks for power, speaker, and RTU
 Phoenix connector pluggable terminals for 600-Ω

Dimensions:

Enclosure 10.00 H × 5.00 W × 4.00 D in (254.0 × 127.0 × 101.6 mm)

Overall 12.50 H × 5.25 W × 7.34 D in (317.5 × 133.4 × 188.4 mm)

Net weight..... standard amplifier: 6.0 lb
 70V/100V amplifier: 7.0 lb
 multi-party and options stations: 7.0 lb
 70V/100V multi-party and option stations: 8.0 lb

Shipping weight standard amplifier: 7.0 lb
 70V/100V amplifier: 8.0 lb
 multi-party and options stations: 8.0 lb
 70V/100V multi-party and option stations: 9.0 lb

Environmental

Temperature range (operation and storage) -22 °F to 140 °F (-30 °C to 60 °C)

Humidity 95% non-condensing

Approvals

NRTL certified for use in US and Canada..... UL/CSA 60950
 CE Mark

Warranty

Equipment. GAI-Tronics warrants for a period of one (1) year from the date of shipment, that any GAI-Tronics equipment supplied hereunder shall be free of defects in material and workmanship, shall comply with the then-current product specifications and product literature, and if applicable, shall be fit for the purpose specified in the agreed-upon quotation or proposal document. If (a) Seller's goods prove to be defective in workmanship and/or material under normal and proper usage, or unfit for the purpose specified and agreed upon, and (b) Buyer's claim is made within the warranty period set forth above, Buyer may return such goods to GAI-Tronics' nearest depot repair facility, freight prepaid, at which time they will be repaired or replaced, at Seller's option, without charge to Buyer. Repair or replacement shall be Buyer's sole and exclusive remedy. The warranty period on any repaired or replacement equipment shall be the greater of the ninety (90) day repair warranty or one (1) year from the date the original equipment was shipped. In no event shall GAI-Tronics warranty obligations with respect to equipment exceed 100% of the total cost of the equipment supplied hereunder. Buyer may also be entitled to the manufacturer's warranty on any third-party goods supplied by GAI-Tronics hereunder. The applicability of any such third-party warranty will be determined by GAI-Tronics.

Services. Any services GAI-Tronics provides hereunder, whether directly or through subcontractors, shall be performed in accordance with the standard of care with which such services are normally provided in the industry. If the services fail to meet the applicable industry standard, GAI-Tronics will re-perform such services at no cost to buyer to correct said deficiency to Company's satisfaction provided any and all issues are identified prior to the demobilization of the Contractor's personnel from the work site. Re-performance of services shall be Buyer's sole and exclusive remedy, and in no event shall GAI-Tronics warranty obligations with respect to services exceed 100% of the total cost of the services provided hereunder.

Warranty Periods. Every claim by Buyer alleging a defect in the goods and/or services provided hereunder shall be deemed waived unless such claim is made in writing within the applicable warranty periods as set forth above. Provided, however, that if the defect complained of is latent and not discoverable within the above warranty periods, every claim arising on account of such latent defect shall be deemed waived unless it is made in writing within a reasonable time after such latent defect is or should have been discovered by Buyer.

Limitations / Exclusions. The warranties herein shall not apply to, and GAI-Tronics shall not be responsible for, any damage to the goods or failure of the services supplied hereunder, to the extent caused by Buyer's neglect, failure to follow operational and maintenance procedures provided with the equipment, or the use of technicians not specifically authorized by GAI-Tronics to maintain or service the equipment. **THE WARRANTIES AND REMEDIES CONTAINED HEREIN ARE IN LIEU OF AND EXCLUDE ALL OTHER WARRANTIES AND REMEDIES, WHETHER EXPRESS OR IMPLIED BY OPERATION OF LAW OR OTHERWISE, INCLUDING ANY WARRANTIES OF MERCHANTABILITY OR FITNESS FOR A PARTICULAR PURPOSE.**

Return Policy

If the equipment requires service, contact your Regional Service Center for a return authorization number (RA#). Equipment should be shipped prepaid to GAI-Tronics with a return authorization number and a purchase order number. If the equipment is under warranty, repairs or a replacement will be made in accordance with the warranty policy set forth above. Please include a written explanation of all defects to assist our technicians in their troubleshooting efforts.

Call 800-492-1212 (inside the USA) or 610-777-1374 (outside the USA) for help identifying the Regional Service Center closest to you.