



Installation and User Guide

PHP400 Help Point

**Analogue version (1090/1099 series)
48V DC power supply**

GAI-TRONICS

A division of Hubbell Ltd.

CONTENTS

1.	Safety and Care Information.....	3
2.	Product Description and Features	3
3.	Operation / Testing.....	4
3.1.	Making a Call.....	4
3.2.	Answering calls.....	4
3.3.	Ending the Call	4
3.4.	Call timer	5
3.5.	Semi Duplex Operation.....	5
4.	SMART features.....	5
5.	Installation and dimensions	6
5.1.	General.....	6
5.2.	Units dimensions and weight	6
5.3.	Site requirements.....	6
5.4.	Opening the Unit.....	6
5.5.	Installation method.....	7
6.	Connections	8
6.1.	Connections between Front and Rear Sections	8
6.2.	DC Power connections.....	8
6.3.	Telephone Module Connections.....	9
6.4.	Internal power connections	9
6.5.	Relay outputs.....	9
6.6.	Optional external inputs	10
7.	Programming and Option Settings.....	11
7.1.	Quick Programming Guide (using a tone phone).....	11
7.2.	Further programming options.....	12
7.3.	TMA.....	13
8.	Cleaning	13
8.1.	Normal Cleaning	13
8.2.	Stainless Steel Push-buttons	13
8.3.	Graffiti.....	13
8.4.	Anti-Graffiti Coating.....	13
9.	Aftercare.....	14
10.	Repairs and Spare Parts.	14
11.	Technical Specifications	15
12.	CE Declaration	18

1. Safety and Care Information

- ▲ **The safety of the user/installer relies on the isolation of the telephone network and not on the earthing of the case**
- ▲ **Please read these instructions thoroughly before starting installation. These products must be installed by competent personnel familiar with telephone installation.**
- ▲ **Telephone network voltages can be hazardous. Take adequate precautions when opening the case or installing. If in doubt, disconnect the telephone line elsewhere before accessing the line connections.**
- ▲ **For increased protection against lightning transients, attach a local earth to the main terminal block (see section 6.3)**

2. Product Description and Features

This manual describes the analogue (PSTN) version of the GAI-Tronics 400mm circular Help Point. This product is based on the standard 1090/1099 Help Point product range and has been specifically configured for use on rail platforms, with features including:

- Weather and vandal resistant casing
- Large, palm-operable, vandal resistant buttons
- Internal induction loop
- Raised text and Braille legends
- Wide operating temperature range
- Auto-dial numbers are remotely programmable
- 48Vdc powered for induction loop and relay outputs
- Line powered phone operation
- 4 auxiliary inputs, 2 volt-free contact outputs

Models are available with different pushbutton options.

The Help Point casing is a two-part construction with electronics in both sections. The 2 sections are held together with 4 security screws through the sides, and there are several cables between the 2 sections. Cable entry points are provided to top and bottom of the casing. Blanking plugs are provided for unused cable entries.

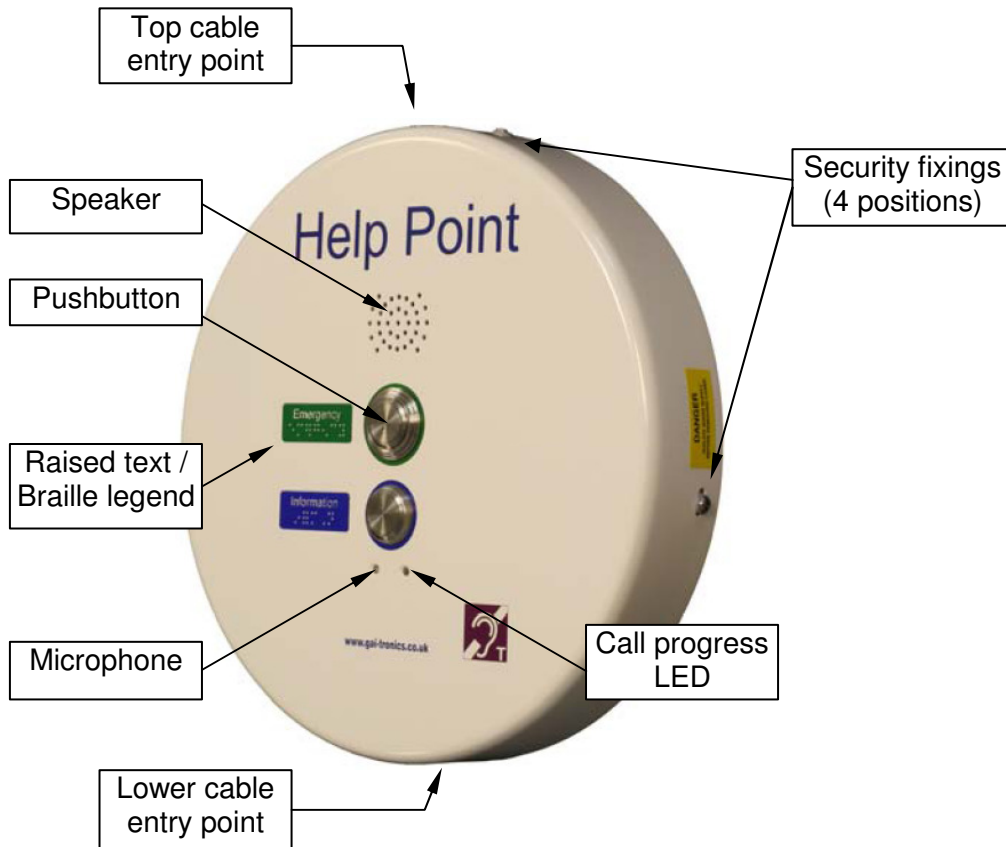

3. Operation / Testing

Please note that, following its initial connection to the line (ie first installation), there may be a delay of up to 30s before the telephone can make an outgoing call.

3.1. Making a Call

To make a call, press the required button and wait for connection. The unit will seize the line and then automatically dial the pre-programmed number.

3.2. Answering calls

To receive a call, press any button when ringing is heard.

3.3. Ending the Call

There is no direct way for a user to end a call from the unit. The unit will close down and release the line on receipt of the following signals, usually when the remote party clears:

- Line polarity reversal
- A line break (sometimes referred to as a “k break”).
- Receipt of exchange call progress tones (see section 11 for specification)

3.4. Call timer

The phone has a programmable call timer that can limit the maximum call duration.

When ON, the timer forces the phone back off line after the preset time. This prevents the line remaining tied if the neither party ends the call. The timer is factory-set to 7mins by default, but can be set to any value (up to 2³/₄hrs) or disabled. See section 7.2.1.

3.5. Semi Duplex Operation

The Help Point is semi duplex, with automated switching between transmit and receive depending on which signal is the stronger. It therefore requires an adequate signal level to be able to switch into receive mode. This level may vary according to ambient noise levels at the Help Point, but we would recommend ensuring that the incoming signal level received at the Help point is at least -35dBm.

This level may have to increase if the ambient noise level at the Help point is high, and in any event correct operation cannot be guaranteed in ambient noise levels exceeding 80dBA.

Semi duplex operation can also be affected if the impedance of the telephone line differs significantly from the pan-European standard – see section 11.

4. SMART features

This family of products has a wide range of intelligent features including:

- Monitoring of faults and health status
- Remote programming of auto-dial numbers and configuration parameters
- Alternate day / night autodial numbers
- Call logs for calls made to and from the telephones¹

These features are all available over standard, 2 wire telephone lines with no external power required at the phone.

To use these features, GAI-Tronics provide a Telephone Management Application (TMA) available separately, see section 7.3.

¹ Called Party Answered signalling (CPA), ie a reversal of line polarity when an outgoing call is answered, is required to ensure accurate recognition of call connection and answer delay times. CPA is a telephone line service and may not be available from all telecom service providers.

5. Installation and dimensions

5.1. General

IMPORTANT

All possible measures must be taken to ensure water, fluid or dust does not contaminate the internal components of the unit whilst unpacking, preparing and installing it in inclement weather conditions or by negligence.

Do not drill any additional holes in the casing. Make sure any unused cable entry or mounting holes are properly sealed against water or dust ingress.

Failure to do so may result in an unsafe condition and will invalidate your warranty.

5.2. Units dimensions and weight

Overall diameter	405mm
Depth (rear surface to front face)	88mm
Pushbutton height from front face	10mm
Unit weight	6.5kg
Mounting centres	4 x 7mm holes on 145 x 270mm centres, see drawing 112-11-0081-001 appended to this manual.
Cable entries	5 off 20mm gland entry points are provided, with blanking plugs to blank off any that are not used: 2 x rear 2 x lower 1 x upper Positions are detailed on drawing 112-11-0081-001 appended to this manual.

5.3. Site requirements

Ensure that the following are available before installation:

1. Power supply: 48V dc @ 2A.
2. Analogue telephone line
3. This is normally a two-person installation, due to the size/weight of the unit and due to the need to connect cables between the 2 sections.

5.4. Opening the Unit

To open the case, undo the 4 security screws around the edge of the unit. These screws are normally Torx type with a centre security pin.



The front section is fitted over the rear section and can be gently lifted clear.

Take care when separating the 2 sections – there are up to 4 cable sets between the 2 halves:

1. Induction loop audio (2 conductors)
2. DC power (2 conductors)
3. Earth cable
4. Telephone cable (if already through one of the cable entries in the rear section).

These cables are deliberately short, but will allow the front section to sit to the **left** of the rear for set-up purposes if required.

5.5. Installation method

The Help Point is intended for vertical installation to a solid wall or suitable post as detailed below.

1. Choose a suitable location for the Help Point, bearing in mind the weight of the unit, and that the operating button(s) should normally be in the range 1200 – 1400mm from the ground for ease of access by people in wheelchairs.
2. Mark the wall or surface with fixing centres as shown above. If necessary use the rear section to help mark the centres. Do not use the rear section as a drilling template.
3. Select fixing screws or bolts appropriate to the type of wall or surface, suitable to support the unit. Drill fixing holes to suit.
4. Separate the front and rear sections of the Help Point, taking care to disconnect interconnecting cables as described in section 5.4.
5. Secure the rear section to the wall, making sure that the fixing holes are sealed to prevent water ingress using nylon washers or other appropriate sealing methods.
6. Bring power and telephone cables into the unit through one or both of the cable entry holes. Cables will normally be contained in conduit, but glands may also be used.
7. The power cable is terminated directly to the terminal block provided, and secured using the cable restraint.
8. The telephone cable should be left long enough to allow connection to the front section (approximately 450mm from entry point) where it is terminated into screw terminals.
9. Ensure that cable entries are sealed to prevent water ingress. If only one cable entry is used, the blanking plug fitted to the other positions must be left in place.
10. Connect induction loop audio, dc power, telephone and earth cables to the front section of the case as shown below.
11. Apply power. The LED on the internal PSU should illuminate. Test the unit by pressing a front panel button. You should hear dial tone even if no autodial number has been programmed.
12. Fit the front section over the rear section and secure in place using the 4 security screws.

6. Connections

6.1. Connections between Front and Rear Sections

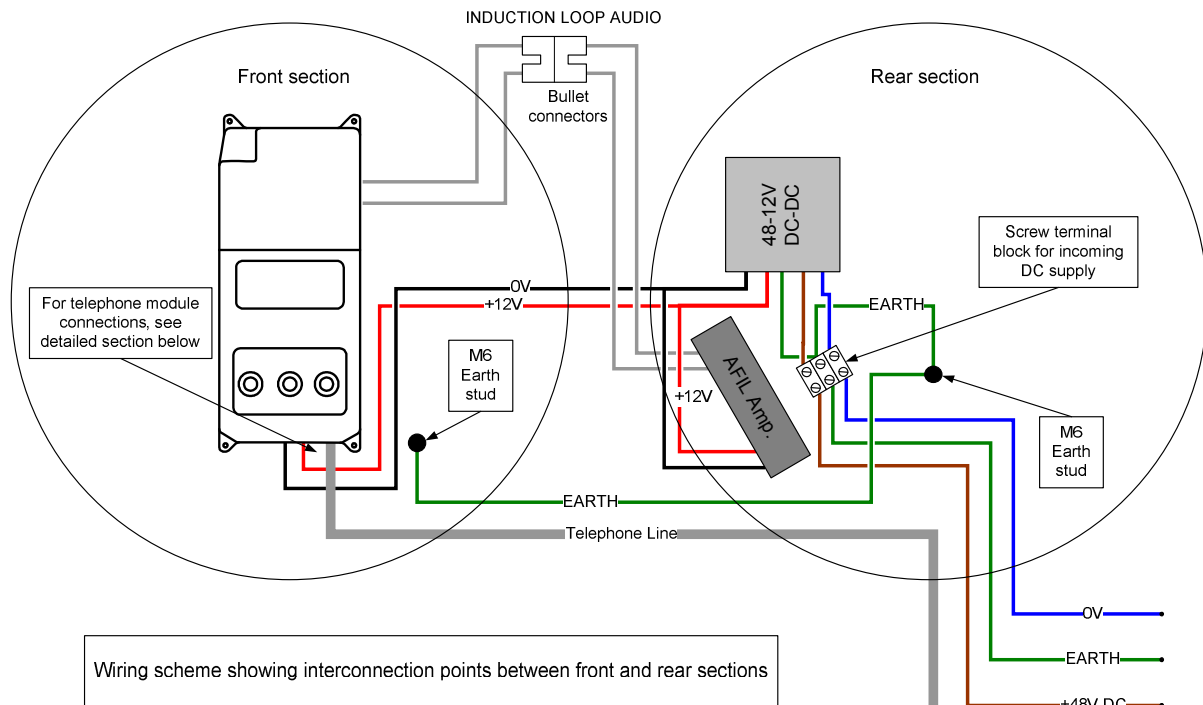

6.2. DC Power connections

Connect a 48V DC power supply to the terminal block as shown on the connection label.

If a 48V power supply is not available, GAI-Tronics can supply a suitable unit, see spare parts (section 10).

One power supply can supply more than one PHP400, provided it is capable of delivering the total current.

Cabling from the 48V supply to each PHP400 must be sufficient to provide the required current (2A) without causing a significant voltage drop over the required distance.

The fuse must always be replaced by the correct type, ie 3.15A T (20x5mm).

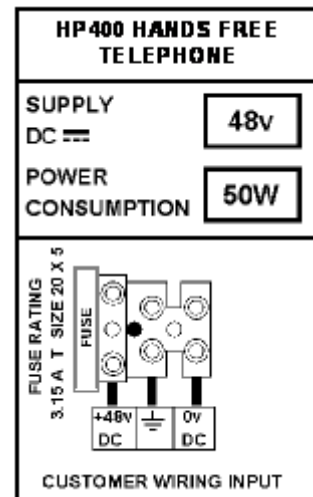

6.3. Telephone Module Connections

Connect the telephone line A and B to the main terminal block CON1 as shown.

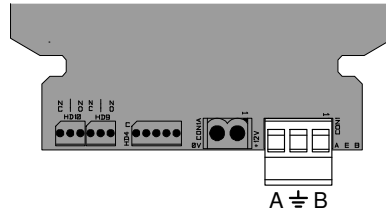

The centre earth terminal is intended for connection to a local earth to provide common mode protection from lightning transients. **If this terminal is not earthed there is an increased risk that the telephone could be damaged by line-born transients.**

Note that user safety from the telephone network is provided by isolation and does not rely on this earth connection.

Note: Conductor sizes to be 0.5mm-2.5mm² (flexible cable); 0.5-4.0mm² (solid cable)
The terminal block can be disconnected from the circuit board for easier installation
Cabling must not infringe European Low Voltage Directive (LVD) 2006/95/EC .

6.4. Internal power connections

The PHP400 Help Point is provided with a 12V power supply unit, required to power the induction loop, external relays and generally to provide increased audio output level.

The telephone module itself does not require this supplementary supply for normal operation, but note that ringing on exchanges with low ring voltages (<40Vac) may be unreliable without it.

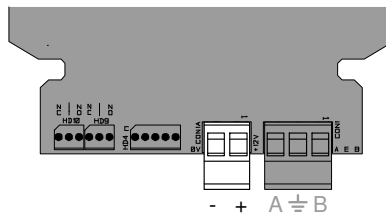

The power input is on CON1A as shown and is connected to the PSU in the rear section via screw terminals in a 2 way push-in connector.

6.5. Relay outputs

The PHP400 is equipped with 2 external relay outputs, controlled by the telephone software. As standard only relay 1 is enabled (HD9), set to activate when the telephone is off-hook and deactivate when back on-hook. Other options are available, but must be specified at order time. Contact GAI-Tronics for details.

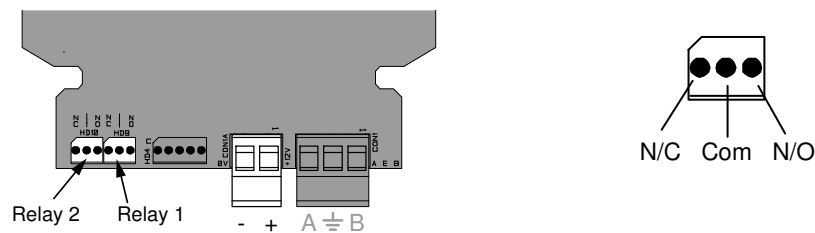

The additional outputs are provided on HD9 & HD10 as shown and are isolated SELV outputs as defined by EN 60950-1.

To comply, the installer must ensure that any connections are within SELV limits.

Relay ratings / SELV limits: 30Vdc, 42.4V peak (resistive load)

Max switching current: 3A

6.6. Optional external inputs

The PHP400 can be equipped with 4 external inputs, which can be used to generate call-in events or alarm reports (using TMA). Note – these optional connections are only available if specifically ordered. Contact GAI-Tronics for details.

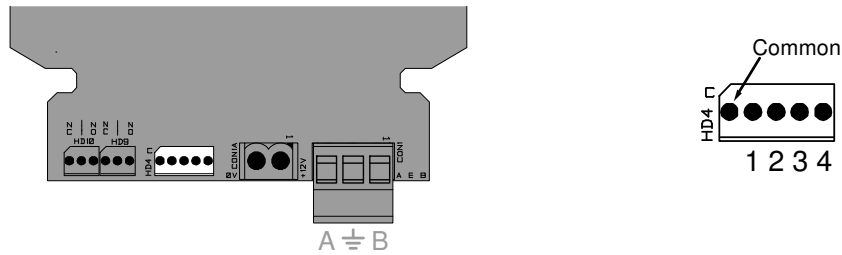

The inputs are provided on HD4 as shown, and are also labelled on the circuit board. Control inputs are for connection to voltage free contacts only. Internal pull-up resistor source current = 33 μ A. These inputs form part of a TNV3 circuit and precautions must be taken to prevent hazardous voltages being applied to these circuits.

NB these inputs are not isolated from the telephone network.

7. Programming and Option Settings

Programming and option setting is done remotely by sending commands down the telephone line to the unit. This can be done by either using a tone phone, or by using GAI-Tronics TMA - a PC software application.

7.1. Quick Programming Guide (using a tone phone).

	Stage	What you do	What you hear back	Notes
1	Call the SMART phone	Dial the number of the phone to be programmed	ringing	The number of rings before auto-answer is programmable (see below), but is factory set to 5
		Wait for it to auto-answer	A single tone (beep), then ringing resumes	
2	Put the phone into maintenance mode	Enter *	Ringing stops	If you still hear ringing, either the phone hasn't auto-answered yet, or it didn't hear the *. Wait a second and try again.
3	Enter the access PIN	Enter **0000	No response	If you don't hear 6 tones in response to *20, it means the PIN was not recognised. Enter *# and try again.
4	Confirm access	Enter *20	6 tones	
5	the phone is now in maintenance mode and ready to receive programming commands, eg:			
	Program memory 1	Enter *1 01 <number> #	A single tone	If you make a mistake, or hear 2 tones instead of one, just repeat the command.
	Program memory 2	Enter *1 02 <number> #	A single tone	
6	Save and close down	Enter *99	A single tone	The final tone confirms that the changes have been saved.

Eg, to program memory 1 to 01283 500500, use

*101 01283500500 #

7.2. Further programming options

In addition to programming auto-dial numbers, several other features can be programmed using a tone-phone.

7.2.1 Time-out

The call time out is factory set to 7 minutes, meaning that the phone will drop the call and go back on hook electronically after this period even if a call is in progress. This feature is provided to guard against the handset being left off hook and tying up the line.

The timer can be set in increments of 10s from 60s to 9980s by entering the code *50, followed by the required timeout divided by 10s, followed by #.

For example to set the timer to 3 minutes enter *50 18 # (3min is 180s, 18 is 180/10).

This command must be entered between entering the PIN and closing the phone down with *99 (ie during step 5 of the quick programming guide above).

To disable the timer use a value of 999, ie *50 999 #.

The phone will respond to a successful command with a single tone.

7.2.2 Inserting a pause into an auto-dial number

To enter a pause (approx 1 second gap) into a dial number, use the digits *1.

For example to program 9 <pause> 12345 into memory 1, use

*101 9 *1 12345 #

This command must be entered between entering the PIN and closing the phone down with *99 (ie during step 5 of the quick programming guide above)

7.2.3 Auto-answer behaviour

To set a SMART help point to automatically answer in a voice call, use

*70 0 #

To set a SMART phone to answer immediately, and only ring after auto-answering (ie for silent monitoring), use

*70 240 #

The actual formula for rings before and after auto-answer is

*70 n #

Where n is a number between 0 and 255 calculated as follows:

$$n = 16 \times R_a + R_b,$$

where R_a is the number of rings after autoanswer, and R_b is the number of rings before autoanswer

This command must be entered between entering the PIN and closing the phone down with *99 (ie during step 5 of the quick programming guide above)

7.2.4 Receive level

To change the receive level, use

*72 n #

Where n is the level in dB, minimum 10, maximum 31, the factory default setting is 26.

This command must be entered between entering the PIN and closing the phone down with *99 (ie during step 5 of the quick programming guide above)

CAUTION - changing this level may cause the phone to be too loud or too quiet, and in extreme cases could affect the semi duplex operation.

To set the phone back to its factory default volume setting use

***72 26 #**

7.3. TMA

GAI-Tronics TMA is a fully featured software application (Telephone Management Application) for Windows™ XP, offering the facilities to program, maintain, monitor and report on all types of GAI-Tronics SMART products.

Full details on the configuration and use of TMA are provided with the package itself.

Contact GAI-Tronics for further details.

TMA part numbers:

TMA package (UK): 100-02-0309-001

TMA package (Europe): 100-02-0309-002

Each package includes the TMA software (including comprehensive help documentation and installation instructions), external modem and dongle.

8. Cleaning

Recommended cleaning methods are outlined below:

8.1. Normal Cleaning

For normal cleaning we recommend "Virosol", manufactured by Clover products. Carefully follow manufacturer's instructions for storage, handling and use.

8.2. Stainless Steel Push-buttons

Stainless steel push-buttons, where fitted, should be cleaned regularly especially if the Help Point is in a marine environment. The stainless steel may show signs of discolouration or rust – this will not damage the buttons or impair their performance but may look unsightly and can be cleaned off using normal cleaning agents as above. In extreme cases a mild abrasive may be necessary.

8.3. Graffiti

For graffiti, paint and ink we recommend the use of 3M GR1 graffiti stain remover. **CAUTION:** This is a very aggressive chemical. Pay close attention to the manufacturer's recommendations for storage, handling and use.

8.4. Anti-Graffiti Coating

Where polyurethane anti-graffiti coating or paint has been specified (as an option), it can be cleaned using Methylated Spirits or Methyl Isobutyl Ketone. Other cleaners can be used but should be tested on a small area first.

9. Aftercare

The purchase of your GAI-Tronics product does not end our commitment to you.

In addition to our warranty obligations, GAI-Tronics are able to offer various levels of maintenance packages, installation and commissioning packages and technical support, from ad-hoc repairs to full maintenance contracts.

By choosing GAI-Tronics as your aftercare provider you are ensured of manufacturer expertise and ISO 9000-certified quality control standards throughout the life of the product.

We can also supply a full range of accessories including mounting posts, beacons and high-volume sounders.

Contact GAI-Tronics for details. www.gai-tronics.co.uk

10. Repairs and Spare Parts.

It is recommended that Help Points are returned to GAI-Tronics for service or repair, to ensure that any repairs are fully tested. In the event of work having to be carried out onsite, the following spare parts are available:

Part No	Description	Notes
228-02-xxxx-xxx	Complete Help Point	The part number will be unique to the particular project and will be printed on a label inside the case.
999-02-1090-003	Main PCB	When ordering, specify the part number of the Help Point that it is for.
999-02-1099-003	Carrier PCB	
610-99-0421-000	48-12V DC-DC converter	
610-99-0425-001	Mains to 48V Power Supply	Mounted external to Help Point (usually in electrical cabinet). Not water protected.
500-02-0505-002	Induction loop amplifier	Encapsulated module with flying leads

11. Technical Specifications

Operational Requirements	
Systems.	<ul style="list-style-type: none"> • Analogue Public Switched Telephone Network (PSTN) • Private Automatic Branch Exchange (PABX)
Not suitable for connection to:	<ul style="list-style-type: none"> • Payphone extensions • Public Emergency Telephone System (PETS)
Telephone line parameters (without supplementary power supply)	<ul style="list-style-type: none"> • Ring Voltage: 40V to 100V rms, 20Hz to 50Hz • Line voltage 20 to 70 Vdc • Loop current $\geq 25\text{mA}$ • Max loop resistance 2800Ω • Line impedance $270R + 750R 150\text{nF}$ as defined in ETSI standard ES 203 021 (previously TBR21)
With supplementary power supply	<ul style="list-style-type: none"> • Ring Voltages down to 30V • Loop current down to 15mA
<p>Note: these telephones have been designed for pan-European single terminal connection to the PSTN. However, due to differences between the individual PSTNs & PABXs provided in different countries, this does not, of itself, give an unconditional assurance of successful operation on every PSTN or PABX termination point.</p>	
Product features	
Power supply	<ul style="list-style-type: none"> • Integral isolated 48Vdc to 12Vdc power supply provided as standard. • Input requirement 48Vdc ($\pm 10\%$) at 2A • Internal fuse 3.15A (T). 20 x 5mm. • Can operate from line power only (without induction loop and relays).
Hookswitch	Electronic with no external moving parts
Ringer loudness	80dBA @ 1m

Call termination	<p>Calls started from the hands-free telephone can terminate in one of three ways:</p> <ul style="list-style-type: none"> • Polarity reversal of DC feed • K-break (interruption of loop current > 50ms) • Call progress tone: a tone received on the line, in the frequency range 280 – 550Hz, either: <ul style="list-style-type: none"> ○ A continuous tone for 5s, or ○ A repeated tone (“beep”) for 5 identical repetitions. <p>Note that, for reliable operation, progress tone level should be between -10dBm and -35dBm, measured at the help point.</p>
Induction loop (if fitted)	<p>Suitable for inductive coupling to Hearing Aids having a ‘T’ switch position. Supplementary power required.</p> 
Dialling and recall mode	MF only. TBR only.
Monitored faults and sensors	<ul style="list-style-type: none"> • Hookswitch • Brown out (power failure) • Call log full • 4 auxilliary inputs (optional)
Parameters configurable with TMA	<ul style="list-style-type: none"> • Autodial numbers - including time-switched alternate numbers • Speech receive level. • Rings before / after auto-answer • Time out (default 7 minutes) • Mute before dial • DTMF detection window
Monitoring method	<ul style="list-style-type: none"> • Remote polling (initiated by TMA) • Call-in (initiated by the telephone at a preset time)

Environmental limits	
Temperature:	<p>Operating: -20°C to +60°C (-4°F to 140°F) Storing: -40°C to +70°C (-40°F to 158°F)</p>
Relative Humidity	Up to 95% (non-condensing)
Ingress Protection	IP65 to EN60529:1992 – Degrees of protection provided by enclosures.
Physical characteristics	
Casing material	Mild steel, zinc coated and polyester powder coated
Weight	6.5kg (11lbs).
Dimensions	405mm diameter. 88mm depth. Buttons may protrude a further 10mm from front face.

Compliance to standards	
European Directives	1999/5/EC – European Radio & Telecommunications Terminal Equipment Directive. 2011/65/EC - Restriction of the use of certain hazardous substances in electrical and electronic equipment (recast) (RoHS 2) Directive
	2002/96/EC - Waste Electrical and Electronic Equipment (WEEE) Directive
EMC	EN55022 – Information technology equipment. Radio disturbance characteristics. EN55024 – Information technology equipment. Immunity characteristics. EN 50121-4 - Railway applications, emission and immunity RT/E/S/30003 – The performance of Telecommunications Equipment under Conditions of Electrical Interference
Safety	EN60950-1 – Specification for information technology equipment, including electrical business equipment. BS6789 Pt.2:1984 (Clause 7.5) – Acoustic Shock. Apparatus with loudspeaking facilities for connection to U.K public switched telephone networks. EN50371 - Generic standard to demonstrate the compliance of low power electronic and electrical apparatus with the basic restrictions related to human exposure to electromagnetic fields (10 MHz - 300 GHz). General public.
Telephony	ES 203 021 - Access and Terminals (AT); Harmonized basic attachment requirements for Terminals for connection to analogue interfaces of the Telephone Networks. EN 301 437 - Terminal Equipment (TE) - Attachment requirements for pan-European approval for connection to the analogue Public Switched Telephone ES 201 729 - Public Switched Telephone Network (PSTN) - 2-wire analogue voice band switched interfaces; - Timed break recall (register recall); - Specific requirements for terminals BS6789 Pt.2:1984 – Apparatus with loudspeaking facilities for connection to U.K public switched telephone networks.
Lightning and transients	ITU-T recommendation K.21 - Enhanced surge protection.



Recycling information	<p>The symbol shown here and on the product means that the product is classed as Electrical or Electronic Equipment and should not be disposed with other household or commercial waste at the end of its working life.</p> <p>The Waste of Electrical and Electronic Equipment (WEEE) Directive has been put in place to recycle products using best available recovery and recycling techniques to minimise the impact on the environment, treat any hazardous substances and avoid the increasing landfill.</p> <p>Business users should contact their suppliers and check the terms and conditions of the purchase contract and ensure that this product is not mixed with other commercial waste for disposal.</p>	
-----------------------	---	--

12. CE Declaration

GAI-TRONICS

A Division of Hubbell Ltd

EC Declaration of Conformity



We, GAI-Tronics (a division of Hubbell Ltd.), of Brunel Drive, Stretton Business Park, Burton upon Trent, Staffordshire, England, DE13 0BZ, declare under our sole responsibility, that the following product is in conformity with the directives listed below and hold the relevant technical documentation at the above address.

Product description	<p style="text-align: center;">Weather Resistant Handsfree Telephones incorporating 999-02-1090-xxx PCB as follows:</p> <p style="text-align: center;">PHP400 analogue Help Points (all variants)</p>
----------------------------	---

EC Directives
1999/5/EC – Radio Equipment and Telecommunications Terminal Equipment (R&TTE) Directive
2011/65/EC - Restriction of the use of certain hazardous substances in electrical and electronic equipment (recast) (RoHS 2) Directive

Date of issue	Name/Job Function of authorised signatory	Signature of signatory
30 November 2012	R Rumsby Engineering Manager	

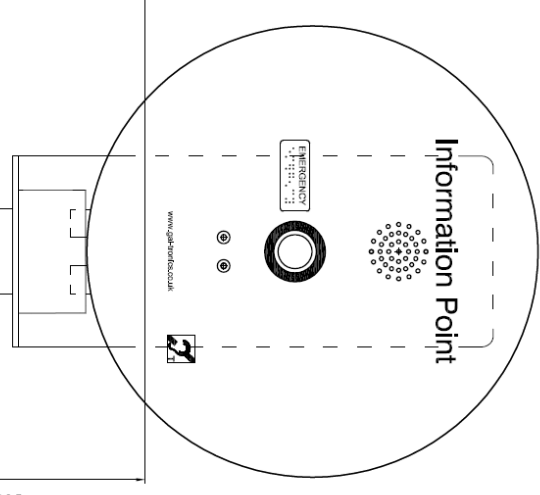
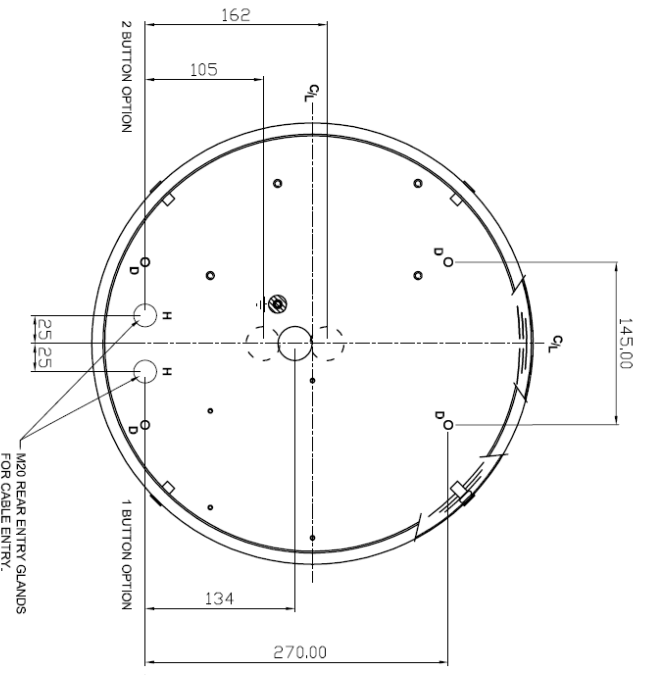
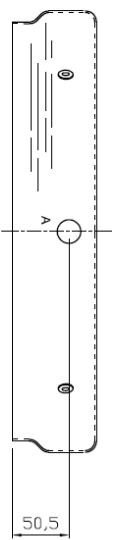
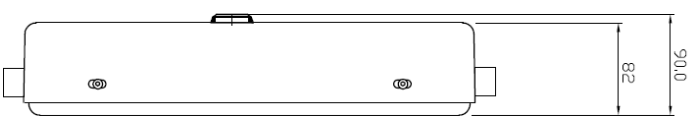
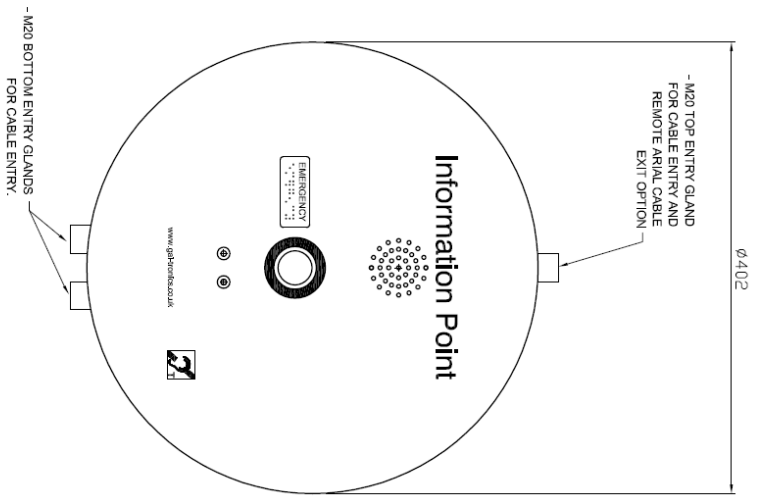

FRONT VIEW

SIDE VIEW

INTERNAL VIEW
REAR CASE (COVER REMOVED)

POST MOUNTING
OPTION

- NOTES:-
- 1 - ROUND HELP POINT:-
 - VOIP HANDS FREE TELEPHONE 1 & 2 BUTTON OPTIONS
 - GSM TELEPHONE HANDS FREE 1 & 2 BUTTON OPTIONS
 - EUROPHONE HANDS FREE TELEPHONE 1 & 2 BUTTON OPTIONS
 - 2 - THE ROUND HELP POINT HOLE FIXING PATTERN IS THE SAME AS THE TITAN, COMMANDER, VR AND DDA RANGE OF TELEPHONES.

CERT AUTHORITY DETAILS:

MANUFACTURING CODE:

THE DRAWING IS COPYRIGHT AND IS THE PROPERTY OF HUBBELL LTD AND MUST NOT BE REPRODUCED OR TRANSMITTED IN ANY FORM OR BY ANY MEANS WITHOUT PERMISSION IN WRITING FROM HUBBELL LTD.

DO NOT SCALE THIS PRINT

PAPER: SHEET LIFE: CODES: IN MSP: SINGLE SOURCE APPROVAL: SCALE: N/A

CAD Ref.: 11001A2

NTS

TITLE: ROUND HELP POINT INSTALLATION INFORMATION FOR VOIP & GSM VERSIONS

CAN CODE:	STRIKE OUT	MANUFACTURING CODE:	0-FACT 4-SKAY
INAPPROPRIATE CODES	I	1-RMNT 5-RNG	1-FACT 4-SKAY
	K	2-BDRP 6-PHIN	2-BDRP 6-PHIN
		3-DRP	3-DRP

TOLERANCES (UNLESS STATED):	NO DEC. PLACES: ± 0.2
	ONE DEC. PLACES: ± 0.1
	TWO DEC. PLACES: ± 0.05
	HOLE TOLERANCES: ± 0.1
	ANGLE TOLERANCES: ± 0.1

PROL. REF.: 33848

DATE: 19-11-09

CHANGE DETAILS

DRAWN

Sheet 1 of 1
112-11-0081-001

GAI-TRONICS

A division of Hubbell Ltd.

Brunel Drive, Stretton Park
Burton on Trent, DE13 0BZ
England

Tel: 01283 500500, Fax: 01283 500400

www.gai-tronics.co.uk

The policy of GAI-Tronics is one of continuous improvement, therefore the Company reserves the right to change specifications without notice