



## Installation and User Guide

# PHP400 Help Point

**GSM version (1090/1099 series)  
48V DC power supply**

**GAI-TRONICS**

A division of Hubbell Ltd.

## CONTENTS

1.	Safety and Care Information.....	3
2.	Product Description and Features .....	3
3.	Operation / Testing.....	5
3.1.	Making a Call .....	5
3.2.	Answering calls.....	5
3.3.	Ending the Call .....	5
3.4.	Testing the GSM module .....	5
3.5.	Call timer .....	5
3.6.	Semi Duplex Operation.....	5
4.	Installation and dimensions .....	6
4.1.	General.....	6
4.2.	Units dimensions and weight .....	6
4.3.	Site requirements.....	6
4.4.	Opening the Unit.....	7
4.5.	Installation method.....	7
4.6.	Remote aerial. ....	9
5.	Connections .....	10
5.1.	Connections between Front and Rear Sections .....	10
5.2.	DC Power connections.....	10
5.3.	Internal power connections .....	10
5.4.	Relay outputs.....	11
5.5.	Optional external inputs .....	11
6.	Programming and Option Settings.....	11
6.1.	DTMF tones over GSM .....	11
6.2.	Quick Programming Guide (using a tone phone).....	12
6.3.	Further programming options.....	12
7.	Cleaning.....	14
7.1.	Normal Cleaning .....	14
7.2.	Stainless Steel Push-buttons .....	14
7.3.	Graffiti.....	14
7.4.	Anti-Graffiti Coating.....	14
8.	Aftercare.....	14
9.	Repairs and Spare Parts. ....	15
10.	Technical Specifications .....	16
11.	CE Declaration .....	18

## 1. Safety and Care Information

- ▲ **Please read these instructions thoroughly before starting installation. These products must be installed by competent personnel familiar with telephone installation.**
- ▲ **Battery**  
**Do not use any other battery other than the one supplied with the GSM terminal.**
- ▲ **Operating environment**  
**Make sure that no special regulations are in force that impose restrictions on the use of mobiles. Restrictions to mobiles would also apply to the GSM Help Point. These could include for example potentially explosive atmospheres or proximity to medical equipment.**
- ▲ **The fitted aerial is rugged but has limited resistance to deliberate damage or vandalism. The aerial can be mounted remotely if appropriate, see section 4.6**

## 2. Product Description and Features

This manual describes the GSM version of the GAI-Tronics 400mm circular Help Point. This product is based on the standard 1090/1099 Help Point product range and has been specifically configured for use on rail platforms, with features including:

- Weather and vandal resistant casing
- Large, palm-operable, vandal resistant buttons
- Raised text and Braille legends
- Internal induction loop
- Integral, vandal resistant aerial
- Quad band GSM module, accepts SIM from any network (SIM not supplied).
- Wide operating temperature range
- Auto-dial numbers are remotely programmable
- 48Vdc powered
- 4 auxiliary inputs, 2 volt-free contact outputs

Models are available with different pushbutton options.

The Help Point is essentially an analogue Help Point module, connected to a GSM terminal contained within the same casing.

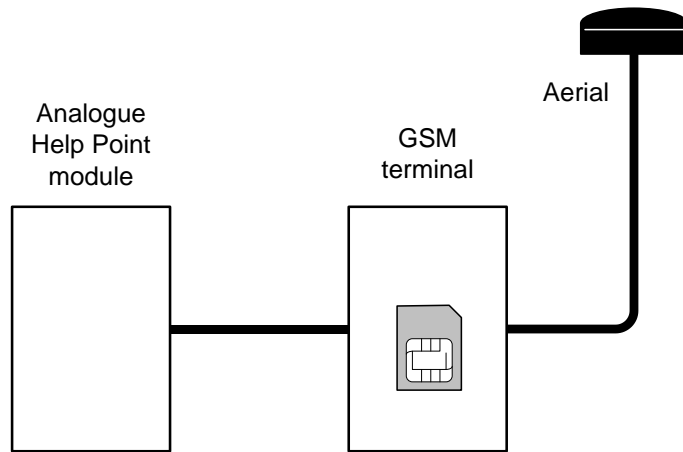

The Help Point casing is a two-part construction with electronics in both sections. The 2 sections are held together with 4 security screws though the sides, and there are several cables between the 2 sections. Cable entry points are provided to top and bottom of the casing. Blanking plugs are provided for unused cable entries.

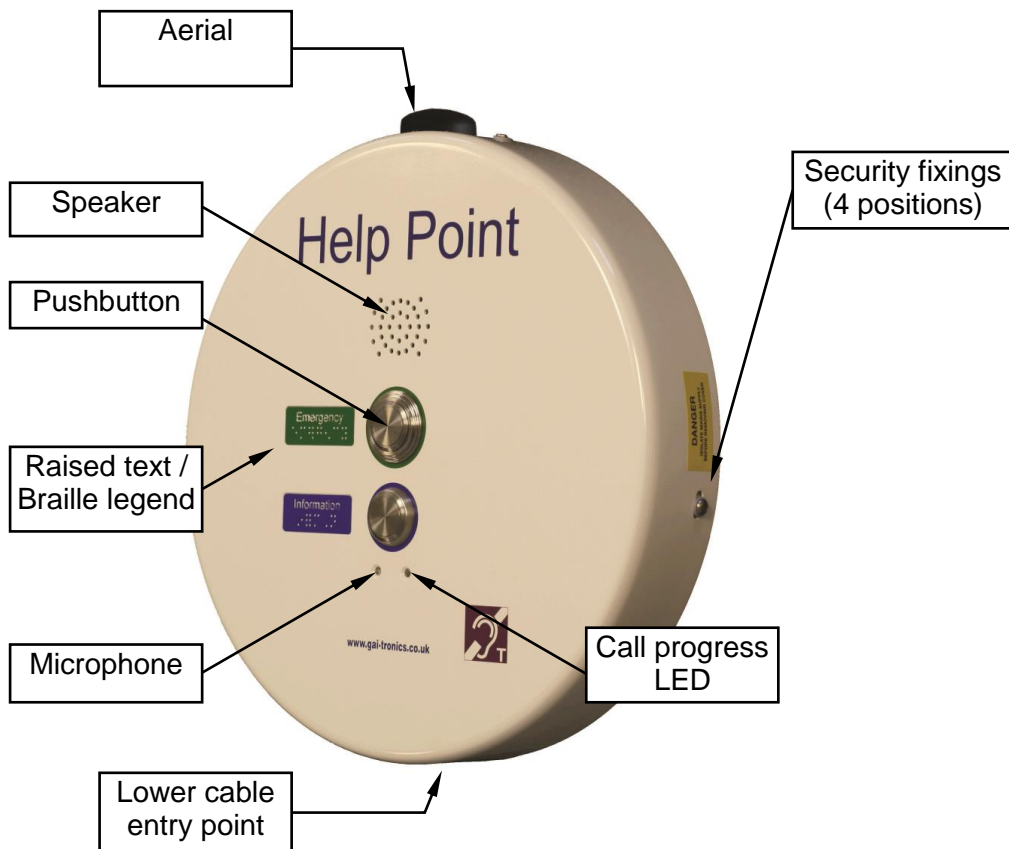

### 3. Operation / Testing

#### 3.1. Making a Call

To make a call, press the required button and wait for connection. The unit will seize the line and then automatically dial the pre-programmed number.

#### 3.2. Answering calls

To receive a call, press any button when ringing is heard.

#### 3.3. Ending the Call

There is no direct way for a user to end a call from the unit. The unit will close down when the remote party clears. Depending on how the network handles this, a tone may be heard from the Help Point for a short period of time (up to 5 seconds) before it closes down.

#### 3.4. Testing the GSM module

To check that the GSM module is operating correctly, send an SMS message to it (ie to the telephone number of its SIM) as follows:

1234stat

It will respond with an SMS containing the following diagnostic information:

- Signal level (must be between -90dBm and -50dBm)
- Charger status (should say "on")
- Battery voltage (an internal voltage, should be between 4.1 and 4.2)
- Temperature (now, min & max) Note that min and max will show 127 or 128 on first reading after power up.
- IMEI (the IMEI number of the GSM module)
- Firmware version

This information will verify that the unit is on the network and can help diagnose various problems.

In particular if the Signal level is between -110dBm and -91dBm then it is too low – Help Point operation will not be reliable until the signal level is increased, for example by repositioning the antenna or choosing a different network.

#### 3.5. Call timer

The phone has a programmable call timer that can limit the maximum call duration.

When ON, the timer forces the phone back off line after the preset time. This prevents the line remaining tied if the neither party ends the call. The timer is factory-set to 7mins by default, but can be set to any value (up to 2<sup>3</sup>/<sub>4</sub>hrs) or disabled. See section 6.3.1.

#### 3.6. Semi Duplex Operation

The Help Point is semi duplex, with automated switching between transmit and receive depending on which signal is the stronger. It therefore requires an adequate signal level to be able to switch into receive mode. This level may vary according to ambient noise levels at the Help Point, but we would recommend ensuring that the incoming signal level received at the analogue telephone port is at least -35dBm.

This level may have to increase if the ambient noise level at the Help point is high, and in any event correct operation cannot be guaranteed in ambient noise levels exceeding 80dBA.

#### 4. Installation and dimensions

##### 4.1. General

### IMPORTANT

---

**All possible measures must be taken to ensure water, fluid or dust does not contaminate the internal components of the unit whilst unpacking, preparing and installing it in inclement weather conditions or by negligence.**

**Do not drill any additional holes in the casing. Make sure any unused cable entry or mounting holes are properly sealed against water or dust ingress.**

**Failure to do so may result in an unsafe condition and will invalidate your warranty.**

---

##### 4.2. Units dimensions and weight

Overall diameter	405mm
Depth (rear surface to front face)	88mm
Pushbutton height from front face	10mm
Unit weight	6.5kg
Mounting centres	4 x 7mm holes on 145 x 270mm centres, see drawing 112-11-0081-001 appended to this manual.
Cable entries	5 off 20mm gland entry points are provided, with blanking plugs to blank off any that are not used:  2 x rear 2 x lower 1 x upper (used for aerial)  Positions are detailed on drawing 112-11-0081-001 appended to this manual.

##### 4.3. Site requirements

Ensure that the following are available before installation:

1. Survey the proposed site for GSM signal strength. Using an appropriate testing device, establish that there is sufficient signal strength at the proposed location for the network provider being proposed. Note that GSM performance can vary widely between different providers' networks and can be affected by building structures. Occasionally there can be "dead spots" where signal is low, but may be adequate a short distance away. If signal strength is too low it may be necessary to either re-site the unit, choose a different provider or site the aerial remotely (see below).

2. Ensure that a suitable SIM card is available (no SIM is supplied with the Help Point). **IMPORTANT:** Ensure that the SIM is activated and not locked. If the SIM is locked there is no way of unlocking it from the Help Point and the Help Point will not function. It is also recommended to disable voicemail on the SIM.
3. Ensure that power is available: 48V dc @ 2A.
4. This is normally a two-person installation, due to the size/weight of the unit and due to the need to connect cables between the 2 sections.

#### 4.4. Opening the Unit

To open the case, undo the 4 security screws around the edge of the unit. These screws are normally Torx type with a centre security pin.



The front section is fitted over the rear section and can be gently lifted clear.

Take care when separating the 2 sections – there are 4 cable sets between the 2 halves:

1. Induction loop audio (2 conductors)
2. DC power (2 conductors)
3. Earth cable
4. Telephone cable.

These cables are deliberately short, but will allow the front section to sit to the **left** of the rear for set-up purposes if required.

#### 4.5. Installation method

The Help Point is intended for vertical installation to a solid wall or suitable post as detailed below.

1. Choose a suitable location for the Help Point, bearing in mind the weight of the unit, and that the operating button(s) should normally be in the range 1200 – 1400mm from the ground for ease of access by people in wheelchairs.
2. Mark the wall or surface with fixing centres as shown above. If necessary use the rear section to help mark the centres. Do not use the rear section as a drilling template.
3. Select fixing screws or bolts appropriate to the type of wall or surface, suitable to support the unit. Drill fixing holes to suit.
4. Separate the front and rear sections of the Help Point, taking care to disconnect interconnecting cables as described in section 4.4. Note that the protective edging strip fitted to the rear edge of the front section may be removed if required. This strip does not form any part of the water seal, and is primarily to provide protection to the front section during installation (for example when laying it on the ground). The edging strip may be refitted after installation or left off as required.
5. Secure the rear section to the wall, making sure that the fixing holes are sealed to prevent water ingress using nylon washers or other appropriate sealing methods.
6. Bring the power cable into the unit through one of the cable entry holes. Cables will normally be contained in conduit, but glands may also be used.
7. The power cable is terminated directly to the terminal block provided, and secured using the cable restraint. Do not apply power until the SIM is fitted. If necessary remove the fuse to disconnect power until the SIM has been fitted.
8. Ensure that all cable entries are sealed to prevent water ingress. The blanking plugs fitted to unused cable entry positions must be left in place.

9. Before refitting the front case section, set up the GSM terminal as follows. Remove the 2 screws holding the GSM terminal retaining bracket to allow access to the cover and SIM holder.
10. Remove the cover from the GSM terminal to reveal the SIM card holder, fit the SIM as shown below

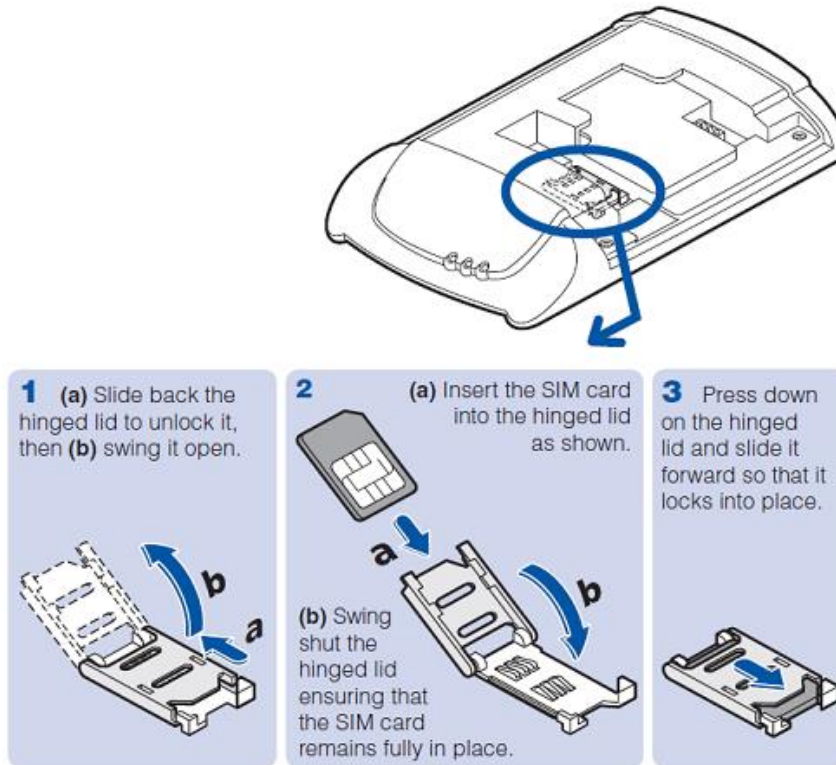

11. Apply power (or replace the fuse). The LED on the internal power supply unit and the right-hand green LED on the GSM terminal will illuminate. The centre green indicator will show a rapid on/off flash while the GSM terminal initialises itself (approx 15 secs).
12. Following initialization, the centre green indicator should be lit steadily – indicating that the terminal is ready. The 3 LEDs on the GSM terminal can indicate various different operating states and faults as shown below:  
NOTE if the unit indicates that the SIM is locked (or blocked) this must be rectified before the Help Point will operate. There is no way to unblock or unlock a SIM from the Help Point.



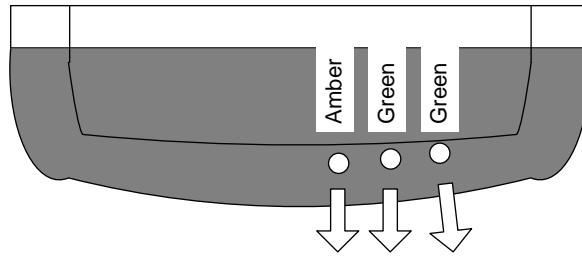

In these diagrams each complete circle represents two seconds, and the shaded portions show the period for which each LED is on within that two seconds.

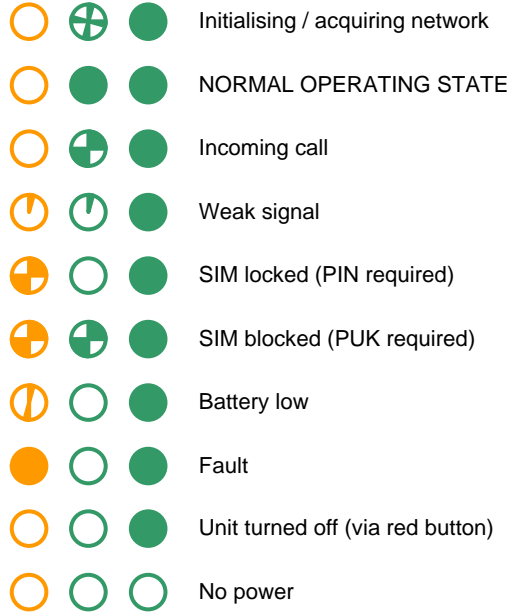

13. Note that the GSM terminal has been set to power up as soon as power is applied, without the need to press its reset button. This results in the green status LED being on permanently in the standby state.
14. Connect induction loop audio, dc power, telephone and earth cables to the front section of the case as shown below.
15. Test the unit by pressing a front panel button. You should hear dial tone even if no autodial number has been programmed.
16. Fit the front section over the rear section and secure in place using the 4 security screws. Note that the protective edging strip fitted to the rear edge of the front section may be removed if required. This strip does not form any part of the water seal, and is primarily to provide protection to the front section during installation (for example when laying it on the ground). The edging strip may be refitted after installation or left off as required.

#### 4.6. Remote aerial.

Occasionally it may be necessary to site the aerial remotely from the Help Point either to improve signal reception or to reduce the risk of vandal damage. For this reason the unit is supplied with 3m of aerial cable, tied up inside the casing. In this case, disconnect the aerial cable from the top of the GSM terminal, free the cable and unscrew the aerial itself from the Help Point casing. The aerial has a 20mm threaded adapter which will allow it to be mounted remotely up to 3m away, for example on conduit, and the cable fed back to the help point. GAI-Tronics can provide a 2.5m mounting pole that can support the Help Point and position the aerial at height, to improve reception and make it less vulnerable. Please contact GAI-Tronics for details.

## 5. Connections

### 5.1. Connections between Front and Rear Sections

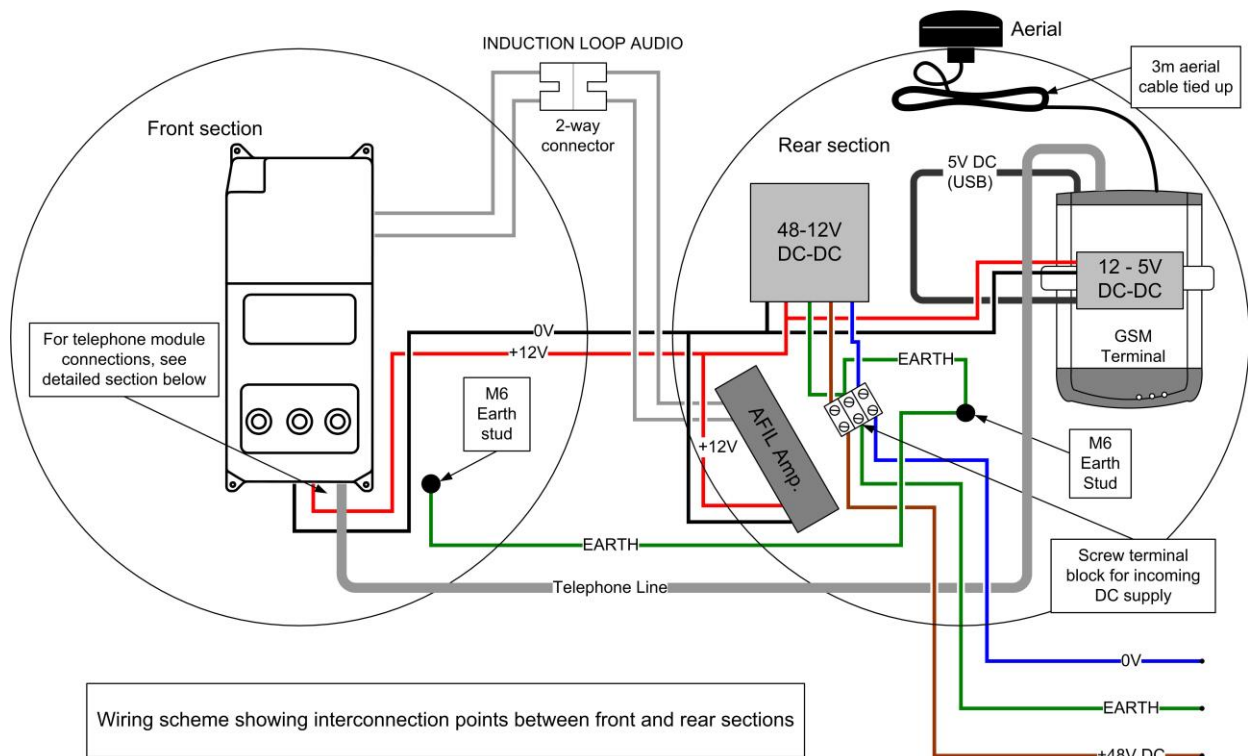

### 5.2. DC Power connections

Connect a 48V DC power supply to the terminal block as shown on the connection label.

If a 48V power supply is not available, GAI-Tronics can supply a suitable unit, see spare parts (section 9).

One power supply can supply more than one PHP400, provided it is capable of delivering the total current.

Cabling from the 48V supply to each PHP400 must be sufficient to provide the required current (2A) without causing a significant voltage drop over the required distance.

The fuse must always be replaced by the correct type, ie 3.15A T (20x5mm).

### 5.3. Internal power connections

The PHP400 Help Point is provided with a 48 to 12V power supply unit, required to power the induction loop and telephone module itself.

The telephone power input is on CON1A as shown and is connected to the PSU in the rear section via screw terminals in a 2 way push-in connector.

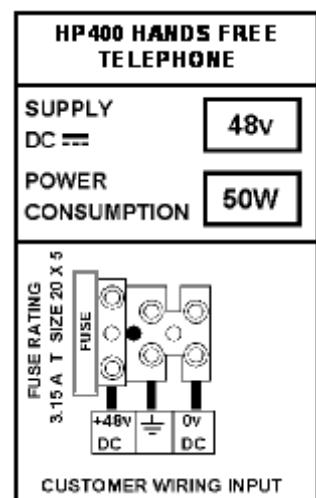

## 5.4. Relay outputs

The PHP400 is equipped with 2 external relay outputs, controlled by the telephone software. As standard only relay 1 is enabled (HD9), set to activate when the telephone is off-hook and deactivate when back on-hook. Other options are available, but must be specified at order time. Contact GAI-Tronics for details.

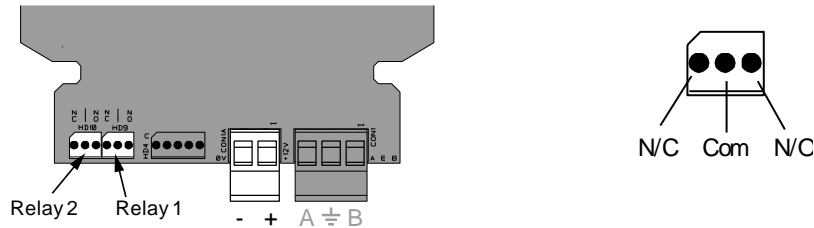

The additional outputs are provided on HD9 & HD10 as shown and are isolated SELV outputs as defined by EN 60950-1.

To comply, the installer must ensure that any connections are within SELV limits.

Relay ratings / SELV limits: 30Vdc, 42.4V peak (resistive load)

Max switching current: 3A

## 5.5. Optional external inputs

The PHP400 can be equipped with 4 external inputs, which can be used to generate call-in events or alarm reports (using TMA). Note – these optional connections are only available if specifically ordered. Contact GAI-Tronics for details.

The inputs are provided on HD4 as shown, and are also labelled on the circuit board.

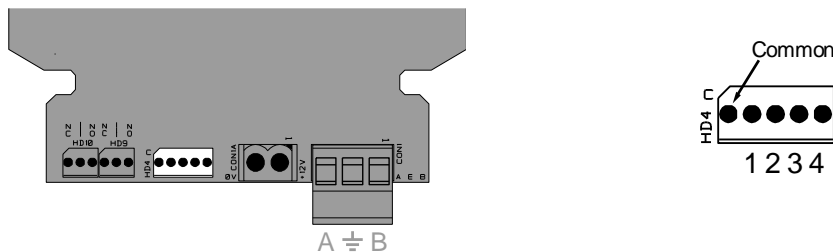

Control inputs are for connection to voltage free contacts only. Internal pull-up resistor source current = 33 $\mu$ A. These inputs form part of a TNV3 circuit and precautions must be taken to prevent hazardous voltages being applied to these circuits.

NB these inputs are not isolated from the telephone network.

## 6. Programming and Option Settings

Programming and option setting is done remotely by sending DTMF tone commands to the unit. This can be done by either using a tone phone, or by using GAI-Tronics TMA – a PC software application.

### 6.1. DTMF tones over GSM

Note that sending DTMF tones over the GSM network is very dependant on the network provider, signal strength and other local conditions beyond our control. This means that programming is not as reliable as it would be over a fixed line, especially if the phone used to do the programming is also a GSM phone. Please follow the procedure below and always confirm that programming has been successful by testing. If a programming step or command should fail, just repeat it - programming will be possible but

occasionally may need retrying. If possible, program using a fixed line telephone. If the Help Point is to be sited in an area where the signal quality is known to be poor, it is recommended to program the unit before going to site.

## 6.2. Quick Programming Guide (using a tone phone).

	Stage	What you do	What you hear back	Notes
1	Call the SMART phone	Dial the number of the phone to be programmed	ringing	The number of rings before auto-answer is programmable (see below), but is factory set to 5
		Wait for it to auto-answer	A single tone (beep), then ringing resumes	
2	Put the phone into maintenance mode	Enter *	Ringing stops	If you still hear ringing, either the phone hasn't auto-answered yet, or it didn't hear the *. Wait a second and try again.
3	Enter the access PIN	Enter **0000	No response	If you don't hear 6 tones in response to *20, it means the PIN was not recognised. Enter *# and try again.
4	Confirm access	Enter *20	6 tones	
5	the phone is now in maintenance mode and ready to receive programming commands, eg:			
	Program memory 1	Enter *1 01 <number> #	A single tone	If you make a mistake, or hear 2 tones instead of one, just repeat the command.
	Program memory 2	Enter *1 02 <number> #	A single tone	
6	Save and close down	Enter *99	A single tone	The final tone confirms that the changes have been saved.

## 6.3. Further programming options

In addition to programming auto-dial numbers, several other features can be programmed using a tone-phone.

### 6.3.1 Time-out

The call time out is factory set to 7 minutes, meaning that the phone will drop the call and go back on hook electronically after this period even if a call is in progress. This feature is provided to guard against the handset being left off hook and tying up the line.

The timer can be set in increments of 10s from 60s to 9980s by entering the code \*50, followed by the required timeout divided by 10s, followed by #.

For example to set the timer to 3 minutes enter \*50 18 # (3min is 180s, 18 is 180/10).

This command must be entered between entering the PIN and closing the phone down with \*99 (ie during step 5 of the quick programming guide above).

To disable the timer use a value of 999, ie \*50 999 #.

The phone will respond to a successful command with a single tone.

### 6.3.2 Inserting a pause into an auto-dial number

To enter a pause (approx 1 second gap) into a dial number, use the digits \*1.

For example to program 9 <pause> 12345 into memory 1, use

\*101 9 \*1 12345 #

### 6.3.3 Auto-answer behaviour

To set a SMART help point to automatically answer in a voice call, use

\*70 0 #

To set a SMART phone to answer immediately, and only ring after auto-answering (ie for silent monitoring), use

\*70 240 #

The actual formula for rings before and after auto-answer is

\*70 n #

Where n is a number between 0 and 255 calculated as follows:

$n = 16 \times Ra + Rb$ ,

where Ra is the number of rings after autoanswer, and Rb is the number of rings before autoanswer

**CAUTION** – It is recommended to set the number of rings before autoanswer to zero. Setting it to 1 or greater increases the risk of an incoming call being diverted to voicemail before the phone module has answered, rendering the Help Point impossible to program.

This command must be entered between entering the PIN and closing the phone down with \*99 (ie during step 5 of the quick programming guide above).

### 6.3.4 Receive level

To change the receive level, use

\*72 n #

Where n is the level in dB, minimum 10, maximum 31, the factory default setting is 26.

This command must be entered between entering the PIN and closing the phone down with \*99 (ie during step 5 of the quick programming guide above).

**CAUTION** - changing this level may cause the phone to be too loud or too quiet, and in extreme cases could affect the semi duplex operation.

**To set the phone back to its factory default volume setting use**

\*72 26 #

This command must be entered between entering the PIN and closing the phone down with \*99 (ie during step 5 of the quick programming guide above).

## **7. Cleaning**

Recommended cleaning methods are outlined below:

### **7.1. Normal Cleaning**

For normal cleaning we recommend "Virosol", manufactured by Clover products. Carefully follow manufacturer's instructions for storage, handling and use.

### **7.2. Stainless Steel Push-buttons**

Stainless steel push-buttons, where fitted, should be cleaned regularly especially if the Help Point is in a marine environment. The stainless steel may show signs of discolouration or rust – this will not damage the buttons or impair their performance but may look unsightly and can be cleaned off using normal cleaning agents as above. In extreme cases a mild abrasive may be necessary.

### **7.3. Graffiti**

For graffiti, paint and ink we recommend the use of 3M GR2 graffiti stain remover. CAUTION: This is a very aggressive chemical. Pay close attention to the manufacturer's recommendations for storage, handling and use.

### **7.4. Anti-Graffiti Coating**

Where polyurethane anti-graffiti coating or paint has been specified (as an option), it can be cleaned using Methylated Spirits or Methyl Isobutyl Ketone. Other cleaners can be used but should be tested on a small area first.

## **8. Aftercare**

The purchase of your GAI-Tronics product does not end our commitment to you.

In addition to our warranty obligations, GAI-Tronics are able to offer various levels of maintenance packages, installation and commissioning packages and technical support, from ad-hoc repairs to full maintenance contracts.

By choosing GAI-Tronics as your aftercare provider you are ensured of manufacturer expertise and ISO 9001-certified quality control standards throughout the life of the product.

We can also supply a full range of accessories including mounting posts, beacons and high-volume sounders.

Contact GAI-Tronics for details. [www.gai-tronics.co.uk](http://www.gai-tronics.co.uk)

## 9. Repairs and Spare Parts.

It is recommended that Help Points are returned to GAI-Tronics for service or repair, to ensure that any repairs are fully tested. In the event of work having to be carried out on site, the following spare parts are available:

<b>Part No</b>	<b>Description</b>	<b>Notes</b>
228-02-xxxx-xxx	Complete Help Point	The part number will be unique to the particular project and will be printed on a label inside the case.
999-02-1090-003	Telephone module main PCB	When ordering, specify the part number of the Help Point that it is for.
999-02-1099-003	Telephone module carrier PCB	
610-99-0421-000	48-12V DC-DC converter	
610-99-0425-001	Mains to 48V Power Supply	Mounted external to Help Point (usually in electrical cabinet). Not water protected.
500-02-0505-002	Induction loop amplifier	Encapsulated module with flying leads
610-99-0557-001	GSM terminal	Supplied without SIM
100-02-0667-001	Replacement aerial kit	Includes sealing kit.



## 10. Technical Specifications

<b>Operational Requirements</b>	
Systems.	<ul style="list-style-type: none"> <li>• Quad-band GSM phase 2/2+ 850/900/1800/1900 MHz</li> <li>• Minimum signal strength typically -90dBm</li> </ul>
<b>Product features</b>	
Power supply	<ul style="list-style-type: none"> <li>• Integral isolated 48Vdc to 12Vdc power supply provided as standard.</li> <li>• Input requirement 48Vdc (±10%) at 2A</li> <li>• Internal fuse 3.15A (T). 20 x 5mm.</li> </ul>
Hookswitch	Electronic with no external moving parts
Ringer loudness	80dBA @ 1m

Induction loop (if fitted)	Suitable for inductive coupling to Hearing Aids having a 'T' switch position. Supplementary power required.	
Dialling and recall mode	MF only. TBR only.	
Monitored faults and sensors	<ul style="list-style-type: none"> <li>• Hookswitch</li> <li>• Brown out (power failure)</li> <li>• Call log full</li> <li>• 4 auxilliary inputs (optional)</li> </ul>	
Parameters configurable with TMA	<ul style="list-style-type: none"> <li>• Autodial numbers - including time-switched alternate numbers</li> <li>• Speech receive level.</li> <li>• Rings before / after auto-answer</li> <li>• Time out (default 7 minutes)</li> <li>• Mute before dial</li> <li>• DTMF detection window</li> </ul>	
Monitoring method	<ul style="list-style-type: none"> <li>• Remote polling (initiated by TMA)</li> <li>• Call-in (initiated by the telephone at a preset time)</li> </ul>	

<b>Environmental limits</b>	
Temperature:	Operating: -20°C to +60°C (-4°F to 140°F) Storing: -40°C to +70°C (-40°F to 158°F)
Relative Humidity	Up to 95% (non-condensing)
Ingress Protection	IP65 to EN60529:1992 – Degrees of protection provided by enclosures.
<b>Physical characteristics</b>	
Casing material	Mild steel, zinc coated and polyester powder coated
Weight	6.5kg (11lbs).
Dimensions	405mm diameter. 88mm depth. Buttons may protrude a further 10mm from front face.



<b>Compliance to standards</b>	
European Directives	<p>1999/5/EC – European Radio &amp; Telecommunications Terminal Equipment Directive.</p> <p>2011/65/EC - Restriction of the use of certain hazardous substances in electrical and electronic equipment (recast) (RoHS 2) Directive</p> <p>2002/96/EC - Waste Electrical and Electronic Equipment (WEEE) Directive</p> 
EMC	<p>EN55022 – Information technology equipment. Radio disturbance characteristics.</p> <p>EN55024 – Information technology equipment. Immunity characteristics.</p> <p>EN 50121-4 - Railway applications, emission and immunity</p> <p>EN 301489-1 - Electromagnetic compatibility and Radio spectrum Matters (ERM); ElectroMagnetic Compatibility (EMC) standard for radio equipment and services. Part 1: Common technical requirements</p> <p>EN 301489-7 -ElectroMagnetic Compatibility and Radio spectrum Matters (ERM); ElectroMagnetic Compatibility (EMC) standard for radio equipment and services. Part 7: Specific conditions for mobile and portable radio and ancillary equipment of digital cellular radio telecommunications systems (GSM and DCS)</p>
RF Spectrum Efficiency	<p>3GPP TS 51.010-1 Mobile Station (MS) conformance specification;</p> <p>EN 301 511 Global System for Mobile communications (GSM);</p> <p>Harmonized EN for mobile stations in the GSM 900 and GSM 1800 bands</p>
Safety	<p>EN60950-1 – Specification for information technology equipment, including electrical business equipment.</p> <p>EN50371 - Generic standard to demonstrate the compliance of low power electronic and electrical apparatus with the basic restrictions related to human exposure to electromagnetic fields (10 MHz - 300 GHz). General public.</p>
Recycling information	<p>The symbol shown here and on the product means that the product is classed as Electrical or Electronic Equipment and should not be disposed with other household or commercial waste at the end of its working life.</p> <p>The Waste of Electrical and Electronic Equipment (WEEE) Directive has been put in place to recycle products using best available recovery and recycling techniques to minimise the impact on the environment, treat any hazardous substances and avoid the increasing landfill.</p> <p>Business users should contact their suppliers and check the terms and conditions of the purchase contract and ensure that this product is not mixed with other commercial waste for disposal.</p> 

## 11. CE Declaration

A copy of the current CE Declaration of Conformity is available from our website. [www.gai-tronics.org/support/certificates-approvals/](http://www.gai-tronics.org/support/certificates-approvals/)

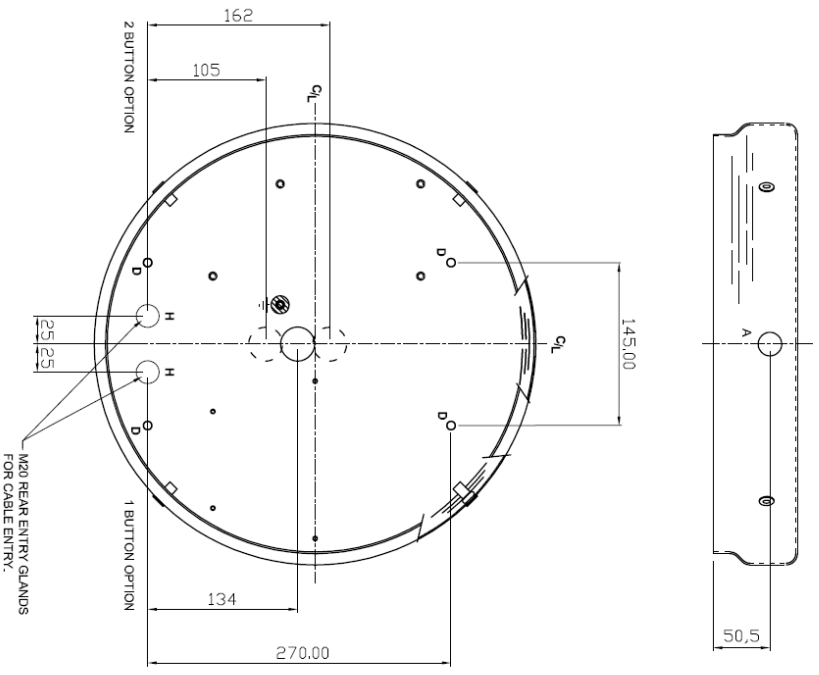
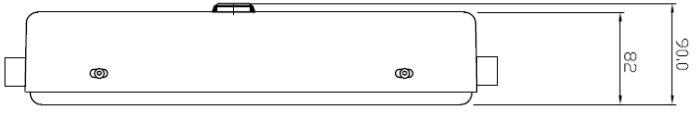
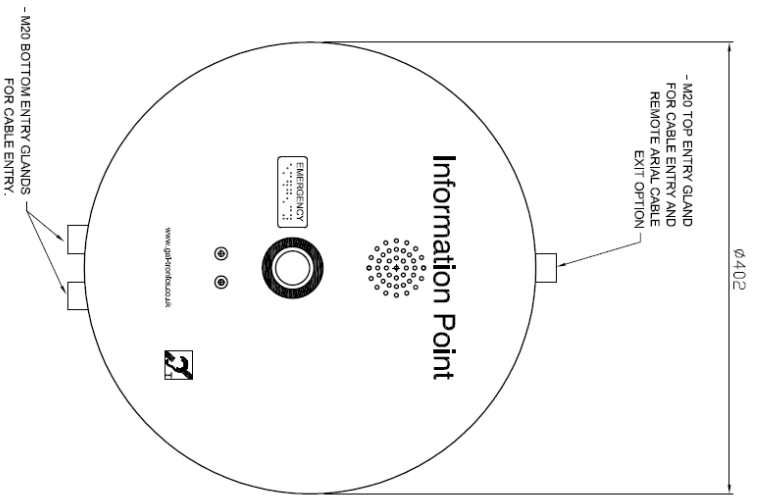

FRONT VIEW

SIDE VIEW

INTERNAL VIEW (COVER REMOVED)

- NOTES:-
- 1 - ROUND HELP POINT:-
    - VOIP HANDS FREE TELEPHONE 1 & 2 BUTTON OPTIONS
    - GSM TELEPHONE HANDS FREE 1 & 2 BUTTON OPTIONS
    - EUROPHONE HANDSFREE TELEPHONE 1 & 2 BUTTON OPTIONS
  - 2 - THE ROUND HELP POINT HOLE FIXING PATTERN IS THE SAME AS THE TITAN , COMMANDER, VR AND DDA RANGE OF TELEPHONES.

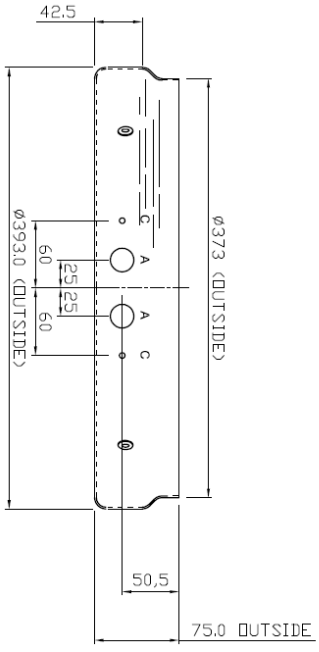

POST MOUNTING OPTION

POST 501-20-0697-002

CERT AUTHORITY DETAILS:		CAN CODE:		MANUFACTURING CODE:		THIS DRAWING IS THE PROPERTY OF GAL-TRONICS AND IS NOT TO BE REPRODUCED OR COPIED IN ANY MANNER WITHOUT THE WRITTEN PERMISSION OF GAL-TRONICS.	
1-FACTORY	2-ROD	3-IMP	4-STRIKE OUT	1-FACTORY	2-ROD	3-IMP	4-STRIKE OUT
TOLERANCES (U.O.S.):		TWO DEC. PLACES: ± 0.2		TOLERANCES (U.O.S.):		TWO DEC. PLACES: ± 0.2	
NO DEC. PLACES: ± 0.5		HOLE TOLERANCES: ± 0.1		NO DEC. PLACES: ± 0.5		HOLE TOLERANCES: ± 0.1	
ANGLE TOLERANCES: ± 0.1		ANGLE TOLERANCES: ± 0.1		ANGLE TOLERANCES: ± 0.1		ANGLE TOLERANCES: ± 0.1	
GAL-TRONICS		A DIVISION OF HUBBEL LIMITED		GAL-TRONICS		A DIVISION OF HUBBEL LIMITED	
PROJ. REF.: 33848		SHEET LIFE: N/A		SHEET LIFE: N/A		SHEET LIFE: N/A	
ISSUE DATE		DATE		DATE		DATE	
CHANGE DETAILS		CHANGE DETAILS		CHANGE DETAILS		CHANGE DETAILS	
SCALE: NTS		SCALE: NTS		SCALE: NTS		SCALE: NTS	
CAD Ref.: 11001A2		CAD Ref.: 11001A2		CAD Ref.: 11001A2		CAD Ref.: 11001A2	
TITLE: ROUND HELP POINT INSTALLATION INFORMATION FOR VOIP & GSM VERSIONS		TITLE: ROUND HELP POINT INSTALLATION INFORMATION FOR VOIP & GSM VERSIONS		TITLE: ROUND HELP POINT INSTALLATION INFORMATION FOR VOIP & GSM VERSIONS		TITLE: ROUND HELP POINT INSTALLATION INFORMATION FOR VOIP & GSM VERSIONS	
VOCB/DRG. No: 112-11-0081-001		VOCB/DRG. No: 112-11-0081-001		VOCB/DRG. No: 112-11-0081-001		VOCB/DRG. No: 112-11-0081-001	
Sheet 1 of 1		Sheet 1 of 1		Sheet 1 of 1		Sheet 1 of 1	

**GAI-TRONICS**

A division of Hubbell Ltd.

Brunel Drive, Stretton Park  
Burton on Trent, DE13 0BZ  
England

Tel: 01283 500500, Fax: 01283 500400

[www.gai-tronics.co.uk](http://www.gai-tronics.co.uk)

The policy of GAI-Tronics is one of continuous improvement, therefore the Company reserves the right to change specifications without notice