



GAI-TRONICS®
A HUBBELL COMPANY

Rack-Mount Audio Messenger Interface

TABLE OF CONTENTS

<i>Confidentiality Notice</i>	<i>1</i>
<i>General Information</i>	<i>1</i>
Features	1
Options	2
Functions	2
Alarms.....	2
Inputs/Outputs.....	2
Timed Events	3
Optional Telephone Operation.....	3
Page/Party Operation	3
Optional ADVANCE Operation	4
Optional Zone Operation	4
Optional AMI Redundancy.....	4
Installation	4
Mounting	5
Desktop installation	5
Rack Installation	5
Field Connections	6
Digital Outputs.....	6
Digital Inputs	7
Audio.....	8
System.....	8
Ethernet.....	9
Power	9
Optional PBX Connection	9
Page/Party	9
Auxiliary Microphone.....	9
Configuration	10
Open the Unit	10
Adjustments	10
Display Brightness	10
Phone Line Levels.....	10
Party Line Levels	10
Page Line Levels.....	11
Jumper Settings	11
600-Ohm Line Termination	11
AUBUS1 Termination	11
AUBUS2 Termination	12

Audio Contact Supervision	12
Date and Time Set Up	13
Date Set Up	13
Time Set Up	13
ACT (AMI Configuration Tool)	13
Overview	13
System Requirements.....	13
Configurable Parameters.....	14
CompactFlash®	15
<i>Operation</i>	15
LCD Power Up Display	15
LCD Operational Display	16
Push-Button Menu Operation	17
Stop Message	17
Play Message	17
Firmware Update	17
Reset AMI.....	17
Return.....	17
<i>Maintenance</i>	18
Service	18
Replacement Parts	18
<i>Specifications</i>	18
Power Supply	18
Audio	18
Communication	19
I/O Control	19
Environmental	19
FCC Information	19
<i>Approvals</i>	19



GAI-TRONICS®
A HUBBELL COMPANY

Rack-Mount Audio Messenger Interface

Confidentiality Notice

This installation, operation, and maintenance manual contains sensitive business and technical information that is confidential and proprietary to GAI-Tronics. GAI-Tronics retains all intellectual property and other rights in or to the information contained herein, and you may only use this information in connection with the operation of your GAI-Tronics product or system. Do not disclose this manual in any form, in whole or in part, directly or indirectly, to any third party.

The following are trademarks of GAI-Tronics Corporation:

SmartSeries®

Page/Party®

ADVANCE

SmartVolume™

General Information

GAI-Tronics' Model 10959-207 and Model 10959-208 AMI (Audio Messenger Interface) tone/speech generators broadcast live pages, telephone pages, pre-recorded alarm tones, pre-recorded speech messages, etc., for use in any application.

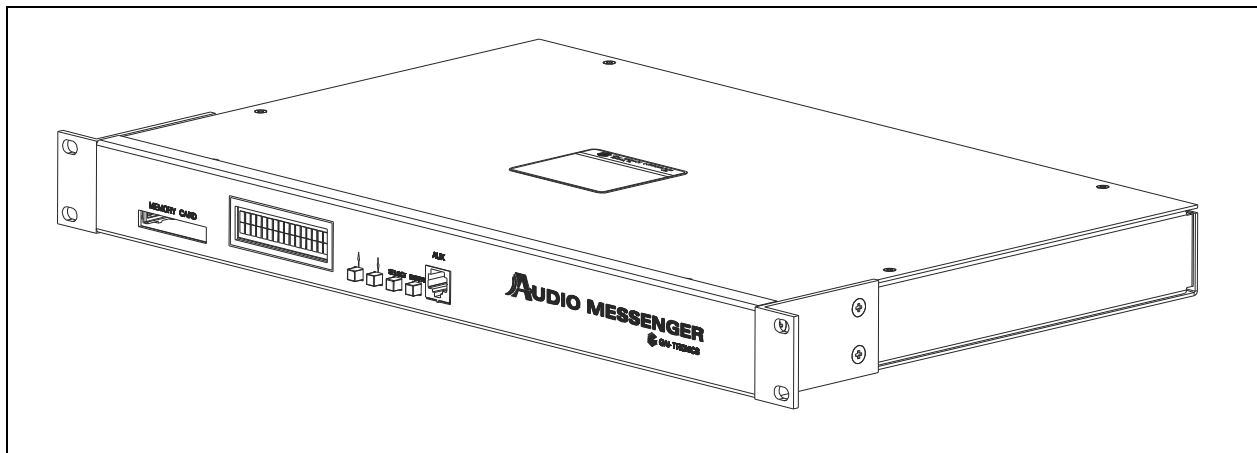

Figure 1. Rack-Mount Audio Messenger Interface

Features

- recorded alarm tones
- eight inputs and eight outputs upgradeable to 40 inputs and outputs
- 600-ohm, 1 V_{RMS} audio output
- CompactFlash® memory
- ACT (AMI Configuration Tool) PC software
- scheduled events
- day/night modes
- live/recorded speech messages
- integration to Page/Party systems

Options

- telephone access (*Model 10959-208 only*)
- desktop paging microphone
- up to 40 inputs and 40 outputs
- audio routing to eight zones
- AMI redundancy for system reliability
- integration to ADVANCE systems

Table 1. Rack-Mount AMI Models and Accessories

Model	Description
10959-207	AMI, rackmount with Page/Party interface
10959-208	AMI, rackmount with Page/Party and telephone interfaces
12584-001	I/O control module option
XDM002A	desktop paging microphone
10960-001	zone interface module
10962-00x	AMI redundancy controller

Functions

Use the ACT (AMI Configuration Tool) software, included with the AMI, to define and change the AMI's configuration. The AMI accesses a CompactFlash[®] memory card, pre-programmed with the Model 10959-207 or 10959-208 product configuration, to retrieve configurations and play audio messages.

Alarms

The ACT software includes pre-recorded tones suitable for most applications. The tones include typical emergency tones (i.e., a siren, slow whoop, etc.) and signaling or process tones (i.e., a gong, steady tone, etc.). The AMI stores all tones and speech messages in MP3 file format.

Use any tone stored in the MP3 file format for applications requiring custom tones. Record custom speech messages using commercially available audio editing software. Create speech-over-tone messages by recording live voice audio on one channel with a tone on the other channel.

Inputs/Outputs

The AMI includes eight configurable inputs and outputs. Use inputs to activate tones and/or speech messages, mute audio playback, or reset alarms. Use outputs to activate external signaling devices, interface to automated control systems, or interface to paging system equipment.

Add the optional I/O control module to the system if the standard eight inputs and outputs are insufficient for an application. The I/O control module provides an additional 32 inputs and 32 digital outputs expanding the total possible inputs and outputs to 40 of each.

Timed Events

The AMI can perform several functions based on the time of day. Schedule events to occur at any interval (hourly, daily, weekly, and monthly, etc.). Configure scheduled events using the ACT software.

Optional Telephone Operation *(Model 10959-208 only)*

The Model 10959-208 AMI provides passcode-protected telephone access to the system that allows access only after entering the correct *remote access security code*. Use the remote access code to prevent unwanted callers from directly accessing the system. Callers must enter the correct security code to gain access to the system when configured to use a security code. Day and night modes can have different security codes.

The telephone interface has multiple operational modes. Configure the appropriate mode using the ACT software. The operational modes are:

- **Page/Party**—Delivers live voice pages (not pre-recorded) to the page line output and holds the party line open following the page.
- **Record Page**—Records each page before delivery to the page line output.
- **Mixed Mode**—Records a page, delivers it to the page line output, and holds the party line open following the page.
- **Live Page Mode**—Delivers a live voice page (not pre-recorded) to the page line output. The party line is not open following the page.
- **Ring Mode**—Plays a preconfigured message on the page line to signal an incoming call.
- **Manual/Disabled**—The telephone interface does not automatically answer a phone call. However, an input configured for *manual access* allows an attendant to manually answer the phone and transfer calls to a party line.

NOTE: The party line for telephone operation is hardwired in the system and cannot be changed by the caller or with the AMI configuration tool.

The AMI supports two temporal modes of operation: *day mode* and *night mode*. Configure the day and night modes independently of each other. As an example of different day and night modes; the day mode may be configured to allow callers to page and wait for a subsequent party line communication, while the night mode is configured to play a tone over the paging system, alerting personnel of an incoming call. Answer the call at any Page/Party station in this mode.

Page/Party Operation

Page/Party operation allows the AMI to:

- play messages/alarms
- connect phone calls (see the [Optional Telephone Operation](#) section)
- generate a VLC (*volume level control*) tone—The AMI can generate a VLC tone during a message/alarm that signals VLC-equipped Page/Party stations to change the volume of the played message/alarm.
- party hot dial—allows a Page/Party system user to initiate a call.

Configure party hot dial with the ACT software. The AMI recognizes when a station goes off-hook on the designated party line. The AMI connects that party line to the telephone interface and automatically dials a preprogrammed telephone number. The call terminates, after a *hang-up delay*, after the station is back on-hook.

Optional ADVANCE Operation

Page/Party operation allows an AMI to play messages/alarms and connect phone calls to an ADVANCE system. The operation of the telephone interface includes all page modes (see the Optional Telephone Operation section) when interfacing the Model 10959-208 AMI to an ADVANCE system.

Schedule events and live pages to play through the ADVANCE system to a specified zone group. Configure zone groups using the ACT software and the ADVANCE system configuration software. Assign configured zone groups to individual events, messages, or the AMI auxiliary microphone jack.

NOTE: ADVANCE systems use party lines one and two. This not changeable by the caller or in the AMI configuration.

Refer to the Jumper Settings section when using the AMI in an ADVANCE system.

Optional Zone Operation

The optional zone interface module allows the AMI to route audio to eight individually controlled zones. Each zone provides a 0 dBm/600-ohm output. Use the ACT software to assign zones to zone groups. Zone groups consist of any combination of zones. Assign zone groups unique descriptions. Create up to a maximum of 60 zone groups. Use the ACT software to assign various events and messages to each zone group. Telephone callers use DTMF signaling to select the zone group prior to making a page.

Optional AMI Redundancy

The optional ARC (AMI redundant controller) increases system reliability by using two AMI units; one as the primary, and one as a backup. The ARC module(s) control which AMI is active.

During normal alarm operation, input contacts apply simultaneously to both the active and back-up AMIs. The ARC module(s) allow only the active generator to play the tone/speech message over the system speakers. The module holds the backup AMI in standby mode to prevent audio mixing of the two AMI tone/speech messages.

In the event of a failure of the active AMI, the backup AMI becomes active and plays its tone/speech message over the system speakers.

Installation



Power Disconnect—The power cord is the main power disconnect for all units.





Disjonction de l'alimentation—Le cordon d'alimentation est la disjonction d'alimentation principale tous les appareils.







Para Desconectar la Alimentación—El cable de alimentación es el medio principal de desconexión del equipo.





Netzanschluß—Wenn man das Netzkabel aus der Steckdose zieht, dann ist die Spannungszuführung zum Gerät vollkommen unterbrochen.

 **CAUTION** —To reduce the risk of fire, use only No. 26 AWG or larger telecommunication line cord.

 **ATTENTION** —Pour réduire le risque d'incendie, utiliser uniquement des conducteurs de télécommunications 26 AWG ou de section supérieure.

 **PRECAUCIÓN** —Para aminorar la posibilidad de incendios, utilice solamente cable de telecomunicaciones de calibre 26 (sistema AWG americano) o mayor.

 **VORSICHT** —Um die Brandgefahr zu verringern, verwenden Sie bitte nur Fernmeldekabel der Stärke Nr. 26 AWG oder höher.

Mounting

Place the Model 10959-207 and 10959-208 Rack-Mount AMI units on a table or desk or mount them in a standard EIA 19-inch electronic equipment rack. The AMI requires 1U (1.75 inches) in a standard 19-inch rack.

Desktop installation

1. Install the five stabilizing feet.
2. Attach the top to the base with the four #4 countersink toothed washers and screws.

These washers help provide good contact to ensure adequate grounding.

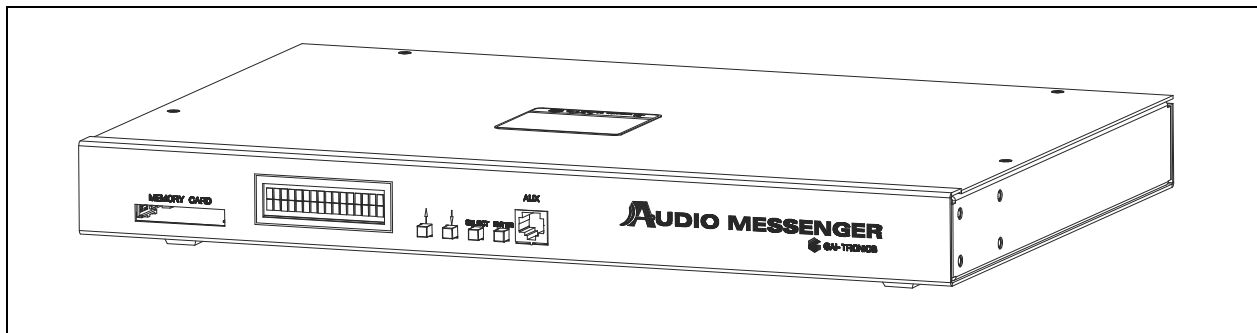

Figure 2. AMI with feet for tabletop

Rack Installation

1. Install the mounting brackets with the eight 8–32 × 3/8-inch screws provided.
2. Mount the AMI into the rack using the four 10–32 × 3/4-inch screws provided.

Field Connections

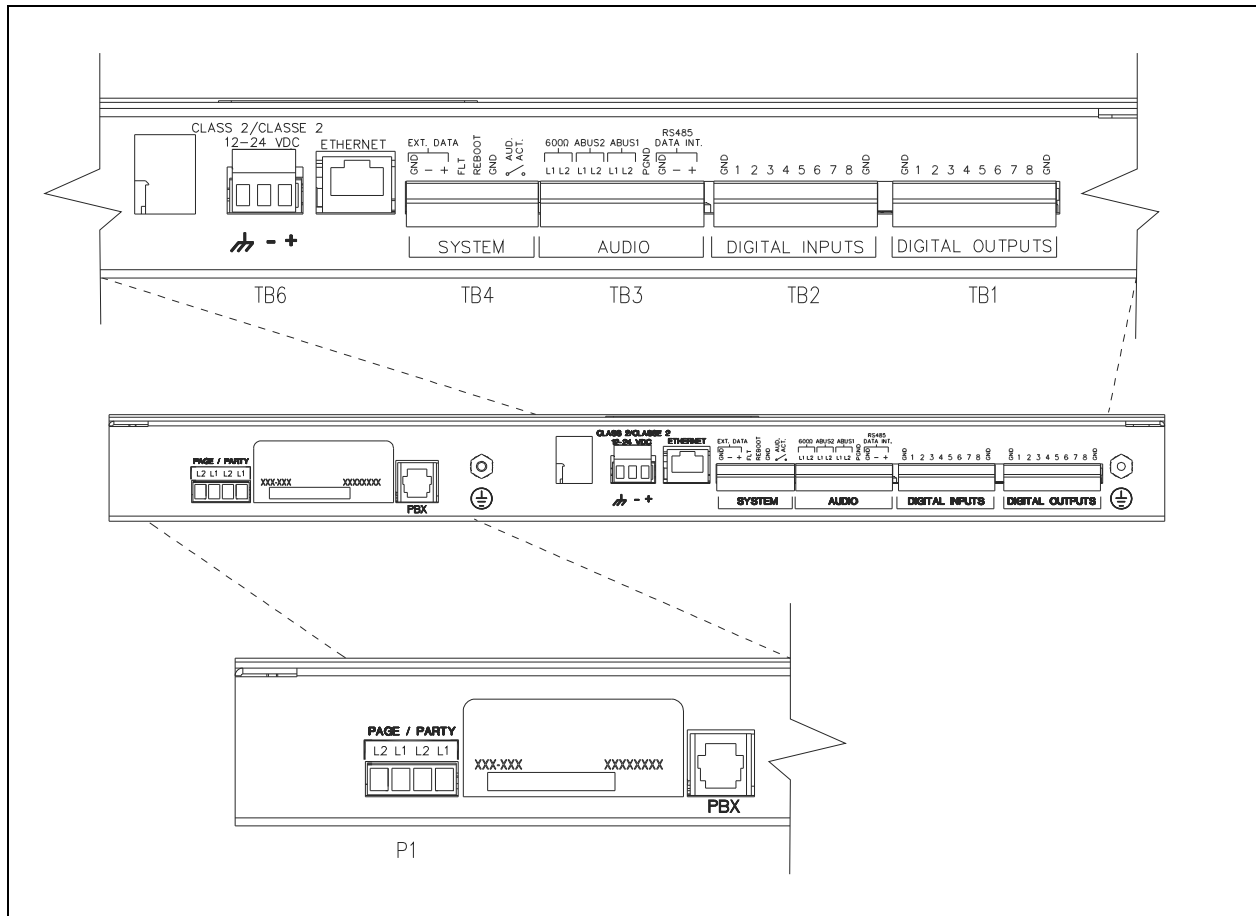

Figure 3. Rear of AMI with Connections Labeled

Digital Outputs

Terminate up to eight digital common ground outputs at terminal block **TB1** (see Figure 3), labeled **DIGITAL OUTPUTS**.

- The outputs are open collector active low.
- The controlled circuits must use the same voltage that powers the AMI.
- Each output can supply 100 mA maximum current.

Tie the ground or dc common terminals for the controlled circuits to the **GND** terminal on the terminal block.

Table 2. Digital Output Termination

Label	Terminal	Function or ACT Description
GND	TB1-1	Ground or dc common
1	TB1-2	Output 1
2	TB1-3	Output 2
3	TB1-4	Output 3
4	TB1-5	Output 4
5	TB1-6	Output 5
6	TB1-7	Output 6
7	TB1-8	Output 7
8	TB1-9	Output 8
GND	TB1-10	Ground or dc common

Digital Inputs

Connect up to eight digital common ground inputs at terminal block **TB2**, labeled DIGITAL INPUTS, on the rear of the AMI (see Figure 3).

- Configure the input contacts for any combination of momentary (pulsed) switches and maintained (latched) switches.
- Use either NO (normally open) or NC (normally closed) dry contacts rated at 5 mA or better.

Tie the ground or dc common terminals of the controlled circuits to the GND terminal on the terminal block.

NOTE: The cable loop resistance connecting the relay/switch contact closures cannot exceed 200 ohms for the inputs to operate reliably.

Table 3. Digital Input Termination

Label	Terminal	Function or ACT Description
GND	TB2-1	Ground or dc common
1	TB2-2	Input 1
2	TB2-3	Input 2
3	TB2-4	Input 3
4	TB2-5	Input 4
5	TB2-6	Input 5
6	TB2-7	Input 6
7	TB2-8	Input 7
8	TB2-9	Input 8
GND	TB2-10	Ground or dc common

Audio

Connect the audio input, audio output, and local RS-485 data connections to terminal block TB3, labeled AUDIO, on the termination PCBA (see [Figure 3](#)).

- Audio connections to a public address amplifier require shielded pair conductors.
- Use local data connections with the I/O control module and/or the zone interface module.

Table 4. Audio/RS485 Connections

Label	Terminal	Function or ACT Description
600 OHM L1	TB3-1	page output audio to public address amplifier, ADVANCE system, or zone interface module
600 OHM L2	TB3-2	
AUDBUS2 L1	TB3-3	internal audio bus and ADVANCE, ARC, or party audio from AMI
AUDBUS2 L2	TB3-4	
AUDBUS1 L1	TB3-5	internal audio bus and ADVANCE party audio to AMI
AUDBUS1 L2	TB3-6	
PGND	TB3-7	power supply ground
RS485 INT GND	TB3-8	no connection
RS485 INT -	TB3-9	data/ground connection for I/O control module
RS485 INT +	TB3-10	

System

Terminal block TB4, labeled SYSTEM, on the rear of the AMI (see [Figure 3](#)), provides connections for system applications such as system reboot, fault indicator, and external data communication.

Table 5. System Connections

Label	Terminal	Function or ACT Description
EXT DATA GND	TB4-1	no connection
EXT DATA-	TB4-2	data connection for ADVANCE or external CPU control
EXT DATA+	TB4-3	
FLT	TB4-4	active high signal representing a fault with AMI
REBOOT	TB4-5	momentary active low signal to reboot AMI
GND	TB4-6	ground reference for FLT and REBOOT
AUD ACT 1	TB4-7	isolated SSR—closed during AMI page On resistance = 30 ohms
AUD ACT 2	TB4-8	

Ethernet

The Ethernet connector is reserved for future implementation.

Power

Connect a 12 to 24 V dc power source to terminal block, TB6, labeled CLASS 2 12–24 VDC (see Figure 3).

Table 6. Input Power Termination

Label	Terminal	Function or ACT Description
+	TB6-1	positive terminal of external power supply (black wire with white stripe from power supply)
–	TB6-2	negative terminal of external power supply (solid black wire from power supply)
GND	TB6-3	frame ground

Optional PBX Connection (Model 10959-208 only)

Connect a telephone cable, with an RJ11 plug, from a standard PBX analog station port to the PBX jack, on the rear of the AMI

Page/Party

Connect a Page/Party system to connector P1, labeled PAGE/PARTY, on the back of the AMI (see Figure 3).

Table 7. Page/Party Termination

Label	Terminal	Function or ACT Description
PARTY L1	P1-1	33-ohm line interface to GAI-TRONICS party line internal 33-ohm termination
PARTY L2	P1-2	
PAGE L1	P1-3	33-ohm line interface to GAI-TRONICS page line external 33-ohm termination required
PAGE L2	P1-4	

NOTE: Pin 1 on this connector is on the right side.

Auxiliary Microphone

Connect an auxiliary microphone to jack J1, on the front panel of the AMI. The pinout for the microphone jack is:

Table 8. Auxiliary Microphone Jack Pinout

Pin	Label	Function
1	HEADSET_RX_AUD	headset receive audio
2	RS232_RXD	RS-232 receive
3	PTT	Push-to-Talk
4	MIC_HI	microphone high
5	MIC_LO	microphone low
6	MONITOR	Monitor
7	RS232_TXD	RS-232 transmit
8	PGND	Ground

Configuration

Open the Unit

Rack Installations:

1. Label and disconnect all wiring to the AMI.
2. Remove the four 10-32 × ¾-inch screws holding the unit in the rack.
3. Pull the unit out of the rack.

All Installations:

4. Remove the four screws securing the cover to the enclosure.
5. Remove the cover from the AMI enclosure.

Adjustments

Display Brightness

Adjust potentiometer R237, on the main PCBA, to change the brightness of the LCD on the front of the assembly.

Phone Line Levels

Two potentiometers, on the optional telephone interface PCBA, adjust the telephone audio levels:

- **Volume level from telephone line**—Adjust the receiver volume potentiometer, R36.
- **Volume to telephone line**—Adjust the transmit volume potentiometer, R1.

Party Line Levels

Two potentiometers on the Page/Party interface PCBA adjust the party line audio levels:

- **Volume level to party line**—Adjust the party volume potentiometer, R66.
- **Sidetone level from party line**—Adjust the party sidetone potentiometer, R30.

Page Line Levels

Two potentiometers, on the Page/Party interface PCBA, adjust the page line audio levels:

- **Volume level to the page line**—Adjust the page volume potentiometer, R39.
- **Page line audio monitor level**—Adjust the page monitor potentiometer, R69.

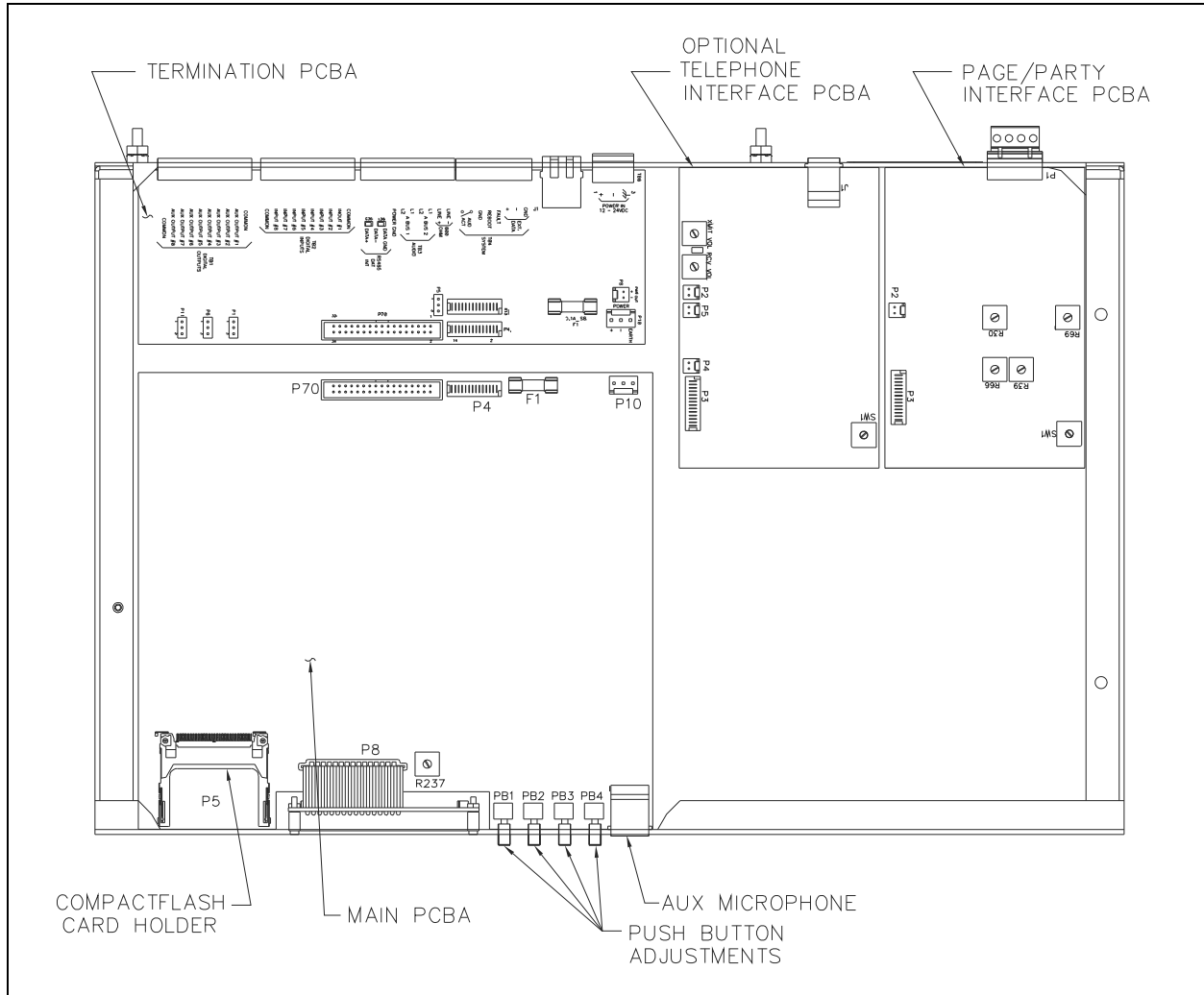

Figure 4. Model 10959-208 AMI (open with all PCBAs installed).

Jumper Settings

600-Ohm Line Termination

Terminate the 600-ohm audio lines with 600 ohms for impedance matching. Use jumper P5, located on the termination PCBA (see Figure 5), to enable/disable impedance matching on the 600-ohm audio line connections (see Table 9).

AUDBUS1 Termination

Terminate the AUDBUS1 connection with 600 ohms for impedance matching. Use jumper P1, located on the termination PCBA (see Figure 5), to configure impedance matching on the AUDBUS1 connection (see Table 9).

AUDBUS2 Termination

Terminate the AUDBUS2 connection with 600 ohms for impedance matching. Use jumper P6, located on the termination PCBA (see Figure 5), to configure impedance matching on the AUDBUS2 connection (see Table 9).

Audio Contact Supervision

Configure the audio contact (AUD ACT) as supervised or unsupervised. Use jumper P11, on the termination PCBA (see Figure 5), to configure the audio contact as supervised for use with an ADVANCE cabinet, or as an isolated SSR (solid state relay) contact (see Table 9).

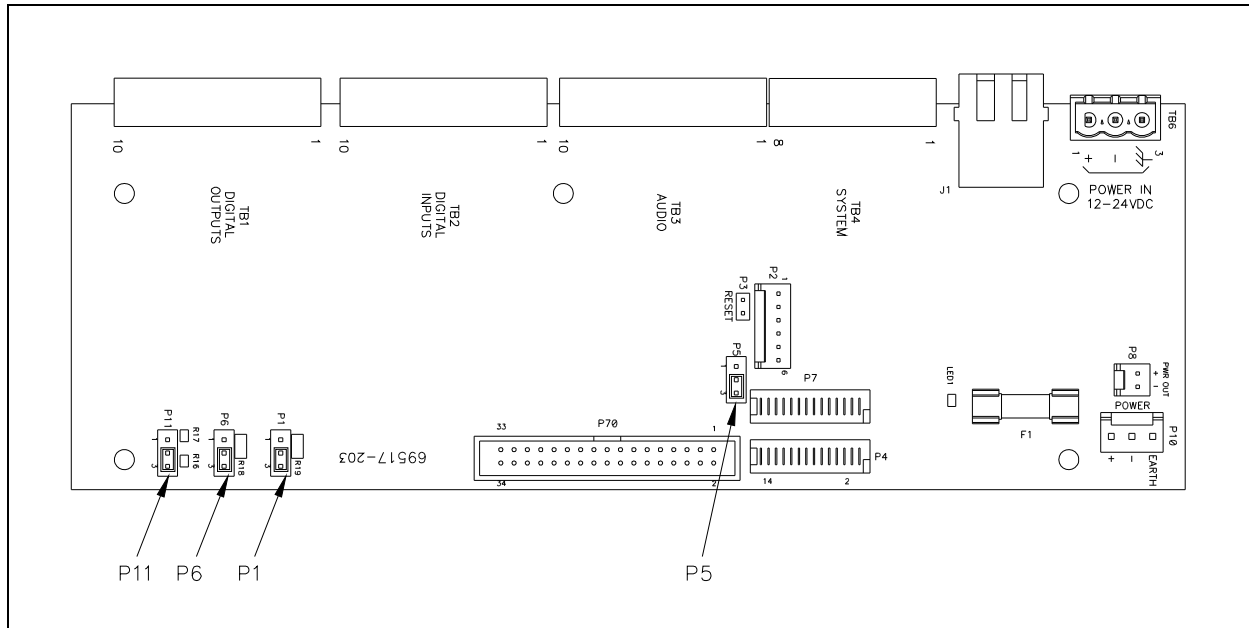

Figure 5. Termination PCBA

Table 9. Termination PCBA Jumper Functions

Jumper	Output	Position	Function
P1	TB3-5, 6 Audio bus 1	1-2	600-ohm resistor connected (ADVANCE position)
		2-3	Default: unterminated
P5	TB3-1, 2 600 ohms	1-2	600-ohm resistor connected (ADVANCE position)
		2-3	Default: unterminated
P6	TB3-3, 4 Audio bus 2	1-2	600-ohm resistor connected (ADVANCE position)
		2-3	Default: unterminated
P11	TB4-7, 8 Audio contact	1-2	Supervision resistor network, 4.7 kilohms in series, 15 kilohms in parallel (ADVANCE position)
		2-3	Default: unsupervised

Date and Time Set Up

Date Set Up

Use the push buttons, on the front of the AMI (see [Figure 4](#)), to set the date. Complete the following procedure to set the date:

1. Press <ENTER>, PB4, to enter the menu system.
2. Press <SELECT>, PB3, to scroll to the DATE: display.
3. Press <ENTER>, PB4, to enter the DATE set up.
4. Press <ENTER>, PB4, to confirm choice.
5. Press <UP>, PB1 or <DOWN>, PB2 to select the desired day.
6. Press <SELECT>, PB3, to scroll to the month.
7. Press <UP>, PB1 or <DOWN>, PB2 to select the desired month.
8. Press <SELECT>, PB3, to scroll to the year.
9. Press <UP>, PB1 or <DOWN>, PB2 to select the desired year.
10. Press <ENTER>, PB4, to accept the DATE setting.

Time Set Up

Use the push buttons, on the front of the AMI (see [Figure 4](#)), to set the time. Complete the following procedure to set the time:

1. Press <ENTER>, PB4, to enter the menu system.
2. Press <SELECT>, PB3, to scroll to the TIME: display.
3. Press <ENTER>, PB4, to enter the TIME: set up.
4. Press <ENTER>, PB4, to confirm choice.
5. Press <UP>, PB1 or <DOWN>, PB2 to select the desired hour.
6. Press <SELECT>, PB3, to scroll to the minute.
7. Press <UP>, PB1 or <DOWN>, PB2 to select the desired minute.
8. Press <ENTER>, PB4, to accept the TIME: setting.

ACT (AMI Configuration Tool)

Overview

Use the ACT software to define and change configurations for the AMI. All AMI models include the software. The AMI accesses a CompactFlash® card to retrieve configurations and play audio messages. Each AMI ships with a CompactFlash® card pre-programmed with the **AMI Factory Default** configuration.

Please refer to the ACT software online help for specific instructions.

System Requirements

Install the ACT software on a Windows PC (Windows® XP/7/10) equipped with a USB port. Connect a CompactFlash® memory card reader/writer to the USB port. The AMI does not include the CompactFlash® reader/writer.

Configurable Parameters

Fragments

A CompactFlash® card stores all digitally recorded tones and voice messages as audio fragments in MP3 files.

Messages

Each message is a collection of fragments. Define the content of each message by selecting the fragment(s) to incorporate in the message. Other message parameters include:

- message title
- priority
- volume
- play mode and repeat interval

Inputs

Enable or disable input circuits. Program the enabled input circuits with the following parameters:

- title containing a brief text description of the input and its use
- type of switch contact being used to activate the input (NO, NC)
- action of the switch (maintained, momentary, toggle on/off)
- function of the input (activate a message, reboot, mute, etc.)

Outputs

Enable or disable output circuits. Program the enabled output circuits with the following parameters:

- title containing a brief text description of the output and its use
- mode of operation when active (maintained, flash, momentary, flicker)
- activation assignment from an input or scheduled event

Event Scheduling

Use the event-scheduling feature to set messages to automatically play at certain dates and times. Set the following parameters when scheduling events:

- start and stop times
- start and stop dates
- event duration and intervals

Optional Telephone Interface

Configure the following parameters if using the telephone interface:

- number of rings before answer
- paging mode (live or recorded)
- page delay, if recorded
- maximum page duration
- greeting message played to the caller
- pre-announcement tone played to the PA system

Page/Party Interface

Set the following parameters for the Page/Party interface:

- VLC activation
- party hot dial

Optional Zone Groups

Configure zone groups with unique descriptions and assign any combination of the eight available output zones.

CompactFlash®

A CompactFlash® memory card stores the system configuration, speech messages, and alarm tones. To install the memory card:

1. Insert the memory card through the rectangular MEMORY CARD slot on the AMI main PCBA with the label on the memory card facing up.
2. Slide the memory card in until it seats in the slot.

When seated properly, the card protrudes approximately ¼ inch from the front of the socket.

NOTE: The memory card and its socket are keyed for proper insertion—*do not force the card into the socket.*

3. Reboot the system so the AMI unit can read the memory card.

Operation

After programming and installing the CompactFlash® card, the AMI operates from system inputs and outputs or by manual operation.

LCD Power Up Display

The AMI completes a self-diagnostic of its settings during power up. The LCD cycles through the following messages:

- AMI firmware version
- media detected
- DSP firmware version
- configuration version
- configuration file name
- ASM (Zone Interface Module) PCBA firmware version or **ASM not installed.**
- AMI main PCBA firmware version
- telephone interface PCBA firmware version or **Telephone Interface not installed.**
- AMI ready
- boot DSP
- EEPROM firmware version
- progress bar/LOAD CONFIG
- configuration date and time
- HIO (I/O control module) PCBA firmware version or **HIO not installed.**
- Page/Party PCBA firmware version
- telephone interface mode (if telephone interface installed)
- telephone interface greeting file name (if recording a new greeting)
- time, page symbol/date

LCD Operational Display

The LCD displays various symbols to indicate AMI's activity:

The VU meter indicates the volume of the current page.



Mute indicates muting of the page audio.

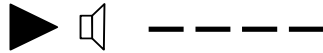

A progress bar indicates the time remaining before party line connection timeout.



A telephone handset indicates an active telephone connection to the AMI.



A microphone indicates a page from the auxiliary jack.



Off hook indicates that a digital input designated as party line off hook is active.



Right/left arrows indicate transmit and receive activity on the auxiliary jack or external RS-485.



Text display (scrolling) displays current system status, such as the name of the current message playing, telephone connection status, and party connection status.

Rotating slash, when visible, indicates the AMI has a lower priority message pending, ready to play.



Push-Button Menu Operation

Front panel push buttons provide menu access for various control features including; play a message, stop a message, and firmware update.

Stop Message

This menu item halts the currently playing message. The button sequence is:

1. Press <ENTER>, PB4, to enter the menu system.
2. Press <ENTER>, PB4, to select the STOP: item.
3. Press <ENTER>, PB4, to confirm the selection.

Play Message

This menu item plays a specific message. Messages are grouped by priority (1 through 7). The button sequence allows the user to select a message to be played from a specific priority group:

1. Press <ENTER>, PB4, to enter the menu system.
2. Press <SELECT>, PB3, to scroll to the PLAY: item.
3. Press <ENTER>, PB4, to enter the PLAY: item.
4. Press <SELECT>, PB3, to scroll to the message.
5. Press <ENTER>, PB4, to play the selected message.

Firmware Update

This menu item facilitates updating the firmware of the AMI main PCBA. The button sequence used is:

1. Press <ENTER>, PB4, to enter the menu system.
2. Press <SELECT>, PB3, to scroll the menu to the FIRMWARE UPDATE: item.
3. Press <ENTER>, PB4, to select the FIRMWARE UPDATE: item.
4. Press <ENTER>, PB4, to confirm the selection.

Reset AMI

Complete the following menu sequence to restart the AMI:

1. Press <ENTER>, PB4, to enter the menu system.
2. Press <SELECT>, PB3, to scroll the menu to the SYSTEM REBOOT: item.
3. Press <ENTER>, PB4, to select the SYSTEM Reboot: item.
4. Press <ENTER>, PB4, to confirm the selection.

Return

Select this menu item to return the system to normal operation mode:

1. Press <ENTER>, PB4, to enter the menu system
2. Press <SELECT>, PB3, to scroll the menu to the RETURN item
3. Press <ENTER>, PB4, to select the RETURN menu item and return to normal operating mode.

Maintenance

Service

Contact a regional service center for assistance if the AMI requires service or spare parts. An RA# (return authorization number) is issued for required service. Ship equipment prepaid to GAI-Tronics with an RA# and a purchase order number. Repairs or a replacement are made in accordance with GAI-Tronics' warranty policy, if the equipment is under warranty. Please include a written explanation of all defects to assist our technicians in their troubleshooting efforts. Call 800-492-1212 inside the USA or 610-777-1374 outside the USA for help with identifying nearest regional service center.

Replacement Parts

Table 10. Replacement Parts

Model Number	Description
69517-204	Termination PCBA
69462-001	Telephone Interface PCBA
69463-001	AMI Single-Party Interface
49100-007	CompactFlash® Card (blank)

Specifications

Power Supply

Voltage..... 12 to 24 V dc (UL listed) Class 2 power source
(plug-in 12 V dc power supply included with AMI)

Current 1 A (minimum)

Power consumed 10 W (maximum)

Audio

Speech capacity.....500 min with 512 Mb CompactFlash® card

Scheduled events..... 29 maximum

Frequency response..... 250–6500 Hz, +0/–3 dB ref. to 1 kHz

Distortion <1% THD @ 1 kHz @ nominal settings

Outputs

600-ohm output..... 1 V_{RMS} nominal

33-ohm page output 1.5 V_{RMS} nominal

33-ohm party output..... 1.5 V_{RMS} nominal

Telephone line output –10 dBm nominal

Inputs

Telephone line input –10 dBm nominal

33-ohm party input..... 1.5 V_{RMS} nominal

Microphone

Type passive input
Input impedance..... > 2 kΩ
Nominal input level..... -20 dBm
Input Adjustment Range N/A

Communication

ADVANCE..... RS-485
Phone line DTMF

I/O Control

Digital outputs..... open collector
Maximum output sinks current 100 mA per output
Maximum output voltage..... AMI input voltage
Isolated output..... dry contact or GAI-TRONICS proprietary supervision
Digital inputs..... open collector or dry contact

Mechanical

Material steel body with aluminum cover; black, fine-textured paint finish
Mounting..... 1-U in standard 19-inch rack
Connections..... screw-type terminal blocks, phone jack
Dimensions 17.00 W × 11.18 D × 1.72 H in, (432 × 284 × 44 mm)
Weight..... 8.5 lb (3.86 kg)

Environmental

Temperature range +32 °F to +122 °F (0 °C to +50 °C)

FCC Information

Complies with CFR47, Part 15 Class A

Approvals

Safety of Information Technology Equipment.....UL 60950, CAN/CSA-C22.2 No. 60950-00, IEC 60950

Warranty

Equipment. GAI-Tronics warrants for a period of one (1) year from the date of shipment, that any GAI-Tronics equipment supplied hereunder shall be free of defects in material and workmanship, shall comply with the then-current product specifications and product literature, and if applicable, shall be fit for the purpose specified in the agreed upon quotation or proposal document. If (a) Seller's goods prove to be defective in workmanship and/or material under normal and proper usage, or unfit for the purpose specified and agreed upon, and (b) Buyer's claim is made within the warranty period set forth above, Buyer may return such goods to GAI-Tronics nearest depot repair facility, freight prepaid, at which time they will be repaired or replaced, at Seller's option, without charge to Buyer. Repair or replacement shall be Buyer's sole and exclusive remedy. The warranty period on any repaired or replacement equipment shall be the greater of the ninety (90) day repair warranty or one (1) year from the date the original equipment was shipped. In no event shall GAI-Tronics warranty obligations with respect to equipment exceed 100% of the total cost of the equipment supplied hereunder. Buyer may also be entitled to the manufacturer's warranty on any third-party goods supplied by GAI-Tronics hereunder. The applicability of any such third-party warranty will be determined by GAI-Tronics.

Services. Any services GAI-Tronics provides hereunder, whether directly or through subcontractors, shall be performed in accordance with the standard of care with which such services are normally provided in the industry. If the services fail to meet the applicable industry standard, GAI-Tronics will re-perform such services at no cost to buyer to correct said deficiency to Company's satisfaction provided any and all issues are identified prior to the demobilization of the Contractor's personnel from the work site. Re-performance of services shall be Buyer's sole and exclusive remedy, and in no event shall GAI-Tronics warranty obligations with respect to services exceed 100% of the total cost of the services provided hereunder.

Warranty Periods. Every claim by Buyer alleging a defect in the goods and/or services provided hereunder shall be deemed waived unless such claim is made in writing within the applicable warranty periods as set forth above. Provided, however, that if the defect complained of is latent and not discoverable within the above warranty periods, every claim arising on account of such latent defect shall be deemed waived unless it is made in writing within a reasonable time after such latent defect is or should have been discovered by Buyer.

Limitations / Exclusions. The warranties herein shall not apply to, and GAI-Tronics shall not be responsible for, any damage to the goods or failure of the services supplied hereunder, to the extent caused by Buyer's neglect, failure to follow operational and maintenance procedures provided with the equipment, or the use of technicians not specifically authorized by GAI-Tronics to maintain or service the equipment. **THE WARRANTIES AND REMEDIES CONTAINED HEREIN ARE IN LIEU OF AND EXCLUDE ALL OTHER WARRANTIES AND REMEDIES, WHETHER EXPRESS OR IMPLIED BY OPERATION OF LAW OR OTHERWISE, INCLUDING ANY WARRANTIES OF MERCHANTABILITY OR FITNESS FOR A PARTICULAR PURPOSE.**

Return Policy

If the equipment requires service, contact your Regional Service Center for a return authorization number (RA#). Equipment should be shipped prepaid to GAI-Tronics with a return authorization number and a purchase order number. If the equipment is under warranty, repairs or a replacement will be made in accordance with the warranty policy set forth above. Please include a written explanation of all defects to assist our technicians in their troubleshooting efforts.

Call 800-492-1212 (inside the USA) or 610-777-1374 (outside the USA) for help identifying the Regional Service Center closest to you.