



GAI-TRONICS®
A HUBBELL COMPANY

733-001 Single-Party Weatherproof Non-Metallic 120 V AC Amplifier Enclosure

Confidentiality Notice



This manual is provided solely as an operational, installation, and maintenance guide and contains sensitive business and technical information that is confidential and proprietary to GAI-Tronics. GAI-Tronics retains all intellectual property and other rights in or to the information contained herein, and such information may only be used in connection with the operation of your GAI-Tronics product or system. This manual may not be disclosed in any form, in whole or in part, directly or indirectly, to any third party.

General Information

This manual applies to the GAI-Tronics 733-001 Single-Party Weatherproof Non-Metallic 120 V AC Amplifier Enclosure, which is an important component of the 700 series Page/Party® system. This enclosure is configured for single-party systems.

The 733-001 Enclosure is made of glass-reinforced polyester, which is extremely weatherproof and corrosion-resistant. It is equipped with terminal strips for connecting system cable. The 701 and 751 series Amplifiers mate directly with this enclosure.

Installation

 **CAUTION**  **Do not install this equipment in hazardous areas other than those indicated on the approval listing in the “Specifications” section of this manual. Such installation may cause a safety hazard and consequent injury or property damage.**

When installing an add-on station, consult the system layout diagram at the end of this manual. This figure, when used in conjunction with the station installation information and cable layout guide, should provide all the information necessary to install additional Page/Party® stations.

Enclosure Placement

All GAI-Tronics Page/Party® units are wired in parallel. Good system layout design minimizes the cable required for each installation. GAI-Tronics multi-conductor cable, designed especially for this application, is recommended. The number, size, and color-coding of conductors are listed in the accompanying system connection diagrams.

System layout and power cable length are very important when installing Page/Party® equipment. Although it varies for different systems, the general guideline is that the total power cable length should not exceed one mile (5280 feet) for 120 V ac systems. The total cable length is the most important consideration while cable length between the stations is generally not a factor.

Mounting

The 733-001 Enclosure is not supplied with conduit or cable openings. Drill or punch these openings using the template supplied before mounting the enclosure. The recommended cable entry point is via the bottom of the enclosure near the rear surface to prevent moisture from dripping onto the terminals or PCBAs. A secondary location for cable entry is in the top of the enclosure toward the sides. Avoid the top center, as it may interfere with the plug-in amplifier receptacle. Under no circumstances should cable entries be made in the side of the enclosure as this may interfere with the installation of the plug-in amplifier.

For specific details including mounting hole dimensions, refer to Figure 1. When mounting the enclosure, use caution to avoid damaging the terminal blocks inside. The suggested mounting height for all station enclosures is 54 inches (137 cm) up to the centerline of the enclosure.

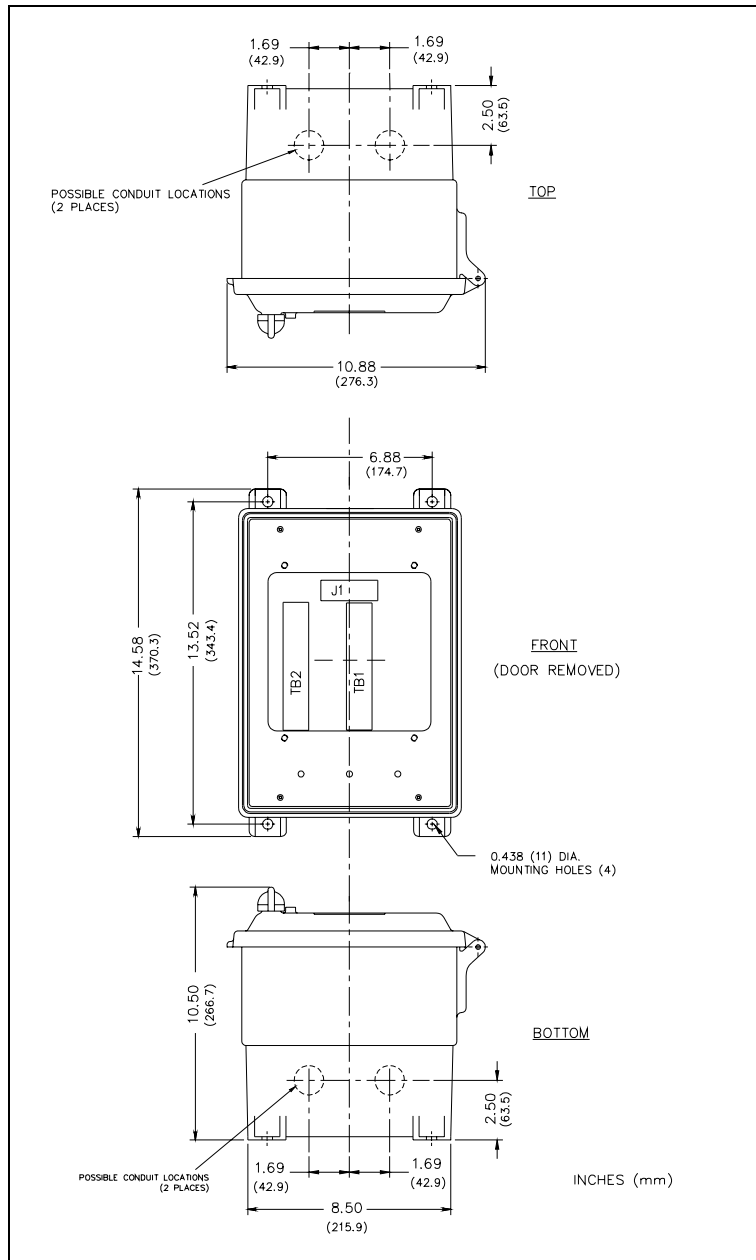

Figure 1. 733-001 Single-Party Weatherproof Non-Metallic Enclosure Mounting Details

Wiring

Attach the conduit to the enclosure. Feed the wiring through the conduit and bring it into the enclosure. See Figure 2. Follow the wire colors carefully because the colors correspond to GAI-Tronics' 60038 series cable. The wires must be spade-lugged and connected carefully and completely to the terminal block. An improper termination may result in diminished station performance.

Local Muting

Figure 2 illustrates local speaker muting when stations are completely assembled and paging operation occurs. Normally, when the station button is pressed, the paging speaker connected to that station is silenced (muted) to prevent acoustic feedback to the handset microphone. However, while the handset is in use for party line conversations, the paging speaker is "live" to enable paging calls from other stations.

To disable the mute feature, follow these instructions:

1. Locate the lugged violet wire attached to terminal point 7 (mute) on the terminal block within the enclosure.
2. Transfer the lugged violet wire to terminal point 8 (Page L1).

After any muting changes are made, unpack the station amplifier and install.

Mutual Muting

In the event that feedback occurs within an area and repositioning of the system speakers does not help, mutual muting may be used to correct this problem.

Perform the following steps to mutually mute adjacent amplifiers/handsets within a zone.

1. Ensure that the purple lugged wire is connected to terminal 7 of TB1.
2. Connect terminal TB1-7 of the handset station to TB1-7 of the station within the zone that is causing feedback. This is done by using the spare system wire (orange conductor) from within the system cable that runs between the stations.

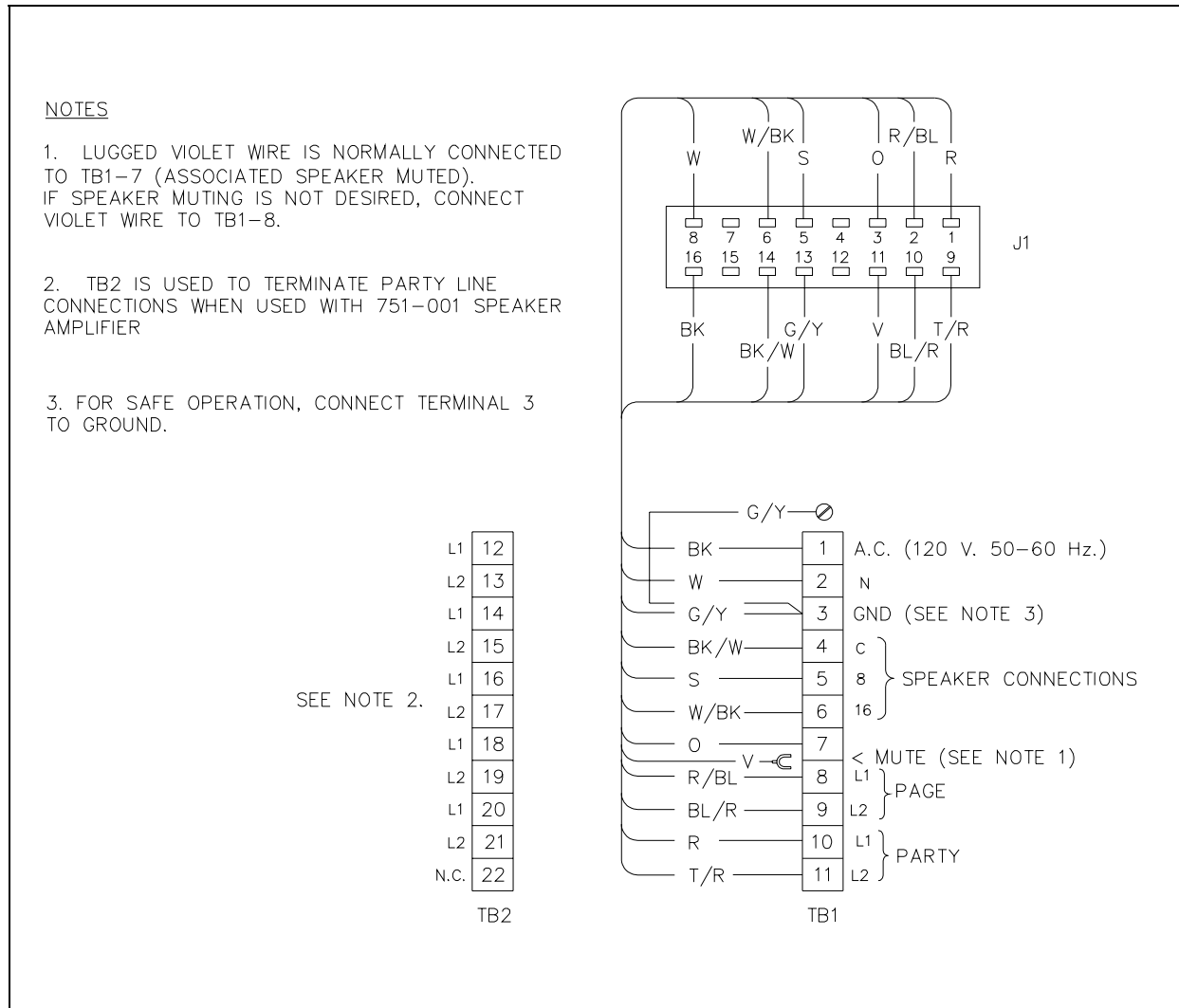



Figure 2. Wiring Diagram

Maintenance

Regular inspection and a good preventive maintenance program will increase the reliability of your GAI-Tronics station. The GAI-Tronics Field Service Department can formulate a service contract suited to your facility's specific need for preventive maintenance.

In addition, the following procedure can be used to keep Page/Party® systems operating effectively.

 **WARNING**  **Before performing any of the following preventive maintenance steps, remove all power from the station.**

1. Remove the amplifier from the enclosure.
2. Visually check the interior of the enclosure for signs of contamination such as dust, condensation or process liquid.
3. Using the No. 10440-002 Maintenance Cable, plug the amplifier into the connector in the enclosure. Check, and if necessary, adjust the amplifier to maximize performance.
4. Reinstall the amplifier in the enclosure. Ensure that all gaskets and hardware are in place. Failure to install the gaskets, which also act as spacers, can result in damage to the connectors on the amplifiers and inside the enclosures and can cause system faults.

It may become necessary to re-terminate some or all of the enclosures in a system. If so, strip the wires back to clean copper and connect only one wire to each connector to allow for easier future troubleshooting.

Troubleshooting

The following table lists some hints to aid technicians in troubleshooting.

Problem	Solution
Feedback occurs only during page.	<ol style="list-style-type: none"> 1. If a speaker is close to the station, try using the muting feature in the amplifier enclosure at the terminal blocks. Connect the violet wire at TB1-8 to TB1-7. Refer to the wiring diagram. 2. Ensure that speakers attached to other stations located nearby are not pointed in your direction. If changing the orientation of the other speakers has no effect, mutual muting may be required. Mutual muting silences all the speakers within proximity to the affected stations during a page from any one of the mutually muted stations. Connect the orange wire (spare) to the TB1-7 of all the stations to be mutually muted. NOTE: If too many stations are selected, paging coverage can be adversely affected. 3. Check line terminations at the line balance assembly. Line balance assembly connections are critical.
Crosstalk occurs.	One or more system cable pairs may be improperly terminated. Visually inspect the system cable connections for accidental crossing of the cable pairs or grounds.

Specifications

Construction/Finish.....	Glass-reinforced polyester, J-hook latch, hinged door with gasket
Mounting.....	Wall, column, or pole (mounting kit required for pole mount), four 7/16-inch mounting holes
Connections	Internal screw-type barrier terminal blocks
Dimensions	14.6 H × 10.9 W × 10.5 D inches (371 × 276 × 267 mm)
Shipping weight	10.2 lbs. (4.6 kg)
Net weight.....	8.3 lbs. (3.8 kg)
Approvals.....	NRTL Listed for USA and Canada Class I, Div. 2, Groups A, B, C, D; Class II, Div. 2, Groups F and G; Class III, Div. 2
Outdoor environmental rating.....	Type 3R; Type 4X with door closed when used with Listed 700 series amplifier

Replacement Parts

Part No.	Description
10440-002	Maintenance Cable, 16-pin
12251-001	Spring Door Kit
12505-005	Door
12504-004	Door Handle
25405-006	Ground Label
61509-004	Harness Assembly

TYPICAL SINGLE-PARTY SYSTEM CONNECTION DIAGRAM

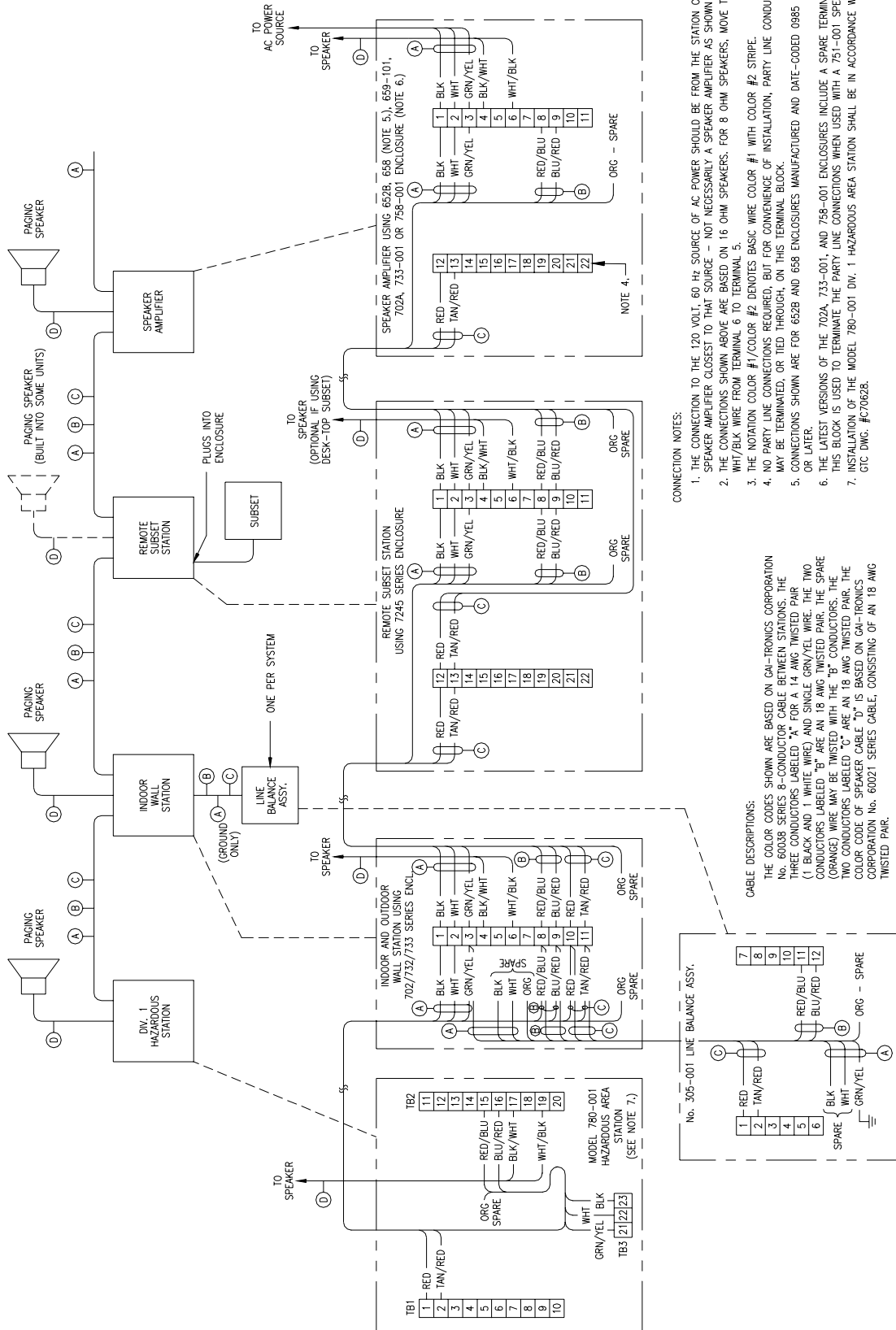

CONNECTION NOTES:

1. THE CONNECTION TO THE 120 VOLT, 60 Hz SOURCE OF AC POWER SHOULD BE FROM THE STATION OR SPEAKER AMPLIFIER CLOSEST TO THAT SOURCE - NOT NECESSARILY A SPEAKER AMPLIFIER AS SHOWN ABOVE.
2. THE CONNECTIONS SHOWN ABOVE ARE BASED ON 16 OHM SPEAKERS. FOR 8 OHM SPEAKERS, MOVE THE WHT/BLK WIRE FROM TERMINAL 6 TO TERMINAL 5.
3. THE NOTATION COLOR #1/COLOR #2 DENOTES BASIC WIRE COLOR #1 WITH COLOR #2 STRIPE.
4. NO PARTY LINE CONNECTIONS REQUIRED, BUT FOR CONVENIENCE OF INSTALLATION, PARTY LINE CONDUCTORS MAY BE TERMINATED, OR TIED THROUGH, ON THIS TERMINAL BLOCK.
5. CONNECTIONS SHOWN ARE FOR 652B AND 658 ENCLOSURES MANUFACTURED AND DATE-CODED 0985 (SEPTEMBER 1985) OR LATER.
6. THE LATEST VERSIONS OF THE 702A, 733-001, AND 758-001 ENCLOSURES INCLUDE A SPARE TERMINAL BLOCK (TB2). THIS BLOCK IS USED TO TERMINATE THE PARTY LINE CONNECTIONS WHEN USED WITH A 751-001 SPEAKER AMPLIFIER.
7. INSTALLATION OF THE MODEL 780-001 DIV. 1 HAZARDOUS AREA STATION SHALL BE IN ACCORDANCE WITH GTC DWG. #C70628.

CABLE DESCRIPTIONS:

THE COLOR CODES SHOWN ARE BASED ON CAL-TRONICS CORPORATION No. 60038 SERIES 8-CONDUCTOR CABLE BETWEEN STATIONS. THE THREE CONDUCTORS LABELED "A" FOR A 14 AWG TWISTED PAIR (1 BLACK AND 1 WHITE WIRE) AND SINGLE GRN/YEL WIRE, THE TWO CONDUCTORS LABELED "B" ARE AN 18 AWG TWISTED PAIR, THE SPARE (ORANGE) WIRE MAY BE TWISTED WITH THE "B" CONDUCTORS, THE TWO CONDUCTORS LABELED "C" ARE AN 18 AWG TWISTED PAIR, THE COLOR CODE OF SPEAKER CABLE "D" IS BASED ON CAL-TRONICS CORPORATION No. 60021 SERIES CABLE, CONSISTING OF AN 18 AWG TWISTED PAIR.

Warranty

Equipment. GAI-Tronics warrants for a period of one (1) year from the date of shipment, that any GAI-Tronics equipment supplied hereunder shall be free of defects in material and workmanship, shall comply with the then-current product specifications and product literature, and if applicable, shall be fit for the purpose specified in the agreed-upon quotation or proposal document. If (a) Seller's goods prove to be defective in workmanship and/or material under normal and proper usage, or unfit for the purpose specified and agreed upon, and (b) Buyer's claim is made within the warranty period set forth above, Buyer may return such goods to GAI-Tronics' nearest depot repair facility, freight prepaid, at which time they will be repaired or replaced, at Seller's option, without charge to Buyer. Repair or replacement shall be Buyer's sole and exclusive remedy. The warranty period on any repaired or replacement equipment shall be the greater of the ninety (90) day repair warranty or one (1) year from the date the original equipment was shipped. In no event shall GAI-Tronics warranty obligations with respect to equipment exceed 100% of the total cost of the equipment supplied hereunder. Buyer may also be entitled to the manufacturer's warranty on any third-party goods supplied by GAI-Tronics hereunder. The applicability of any such third-party warranty will be determined by GAI-Tronics.

Services. Any services GAI-Tronics provides hereunder, whether directly or through subcontractors, shall be performed in accordance with the standard of care with which such services are normally provided in the industry. If the services fail to meet the applicable industry standard, GAI-Tronics will re-perform such services at no cost to buyer to correct said deficiency to Company's satisfaction provided any and all issues are identified prior to the demobilization of the Contractor's personnel from the work site. Re-performance of services shall be Buyer's sole and exclusive remedy, and in no event shall GAI-Tronics warranty obligations with respect to services exceed 100% of the total cost of the services provided hereunder.

Warranty Periods. Every claim by Buyer alleging a defect in the goods and/or services provided hereunder shall be deemed waived unless such claim is made in writing within the applicable warranty periods as set forth above. Provided, however, that if the defect complained of is latent and not discoverable within the above warranty periods, every claim arising on account of such latent defect shall be deemed waived unless it is made in writing within a reasonable time after such latent defect is or should have been discovered by Buyer.

Limitations / Exclusions. The warranties herein shall not apply to, and GAI-Tronics shall not be responsible for, any damage to the goods or failure of the services supplied hereunder, to the extent caused by Buyer's neglect, failure to follow operational and maintenance procedures provided with the equipment, or the use of technicians not specifically authorized by GAI-Tronics to maintain or service the equipment. **THE WARRANTIES AND REMEDIES CONTAINED HEREIN ARE IN LIEU OF AND EXCLUDE ALL OTHER WARRANTIES AND REMEDIES, WHETHER EXPRESS OR IMPLIED BY OPERATION OF LAW OR OTHERWISE, INCLUDING ANY WARRANTIES OF MERCHANTABILITY OR FITNESS FOR A PARTICULAR PURPOSE.**

Return Policy

If the equipment requires service, contact your Regional Service Center for a return authorization number (RA#). Equipment should be shipped prepaid to GAI-Tronics with a return authorization number and a purchase order number. If the equipment is under warranty, repairs or a replacement will be made in accordance with the warranty policy set forth above. Please include a written explanation of all defects to assist our technicians in their troubleshooting efforts.

Call 800-492-1212 (inside the USA) or 610-777-1374 (outside the USA) for help identifying the Regional Service Center closest to you.