



GAI-TRONICS®
A HUBBELL COMPANY

Model 400-003 & 400-004 IEC/ATEX Zone 1 RigCom Stations

Confidentiality Notice

This manual is provided solely as an operational, installation, and maintenance guide and contains sensitive business and technical information that is confidential and proprietary to GAI-Tronics. GAI-Tronics retains all intellectual property and other rights in or to the information contained herein, and such information may only be used in connection with the operation of your GAI-Tronics product or system. This manual may not be disclosed in any form, in whole or in part, directly or indirectly, to any third party.

General Information

GAI-Tronics Model 400-003 (120 V ac) and 400-004 (230 V ac) IEC/ATEX Zone 1 RigCom Stations are designed for common-talk, or master/slave communication system operation in IEC/ATEX Zone 1 hazardous locations.

The unit provides push-to-call, release-to-listen operation, and has a local on/off volume-control switch to activate and control the volume level for each station independently.

Models 400-003 and 400-004 have three M20 threaded entry holes for system, power, loudspeaker and optional remote microphone and footswitch connection.

The Models 400-003 and 400-004 are designed to operate with other 400 Series RigCom stations, and GAI-Tronics EZ Page Series of non-hazardous area rated equipment.

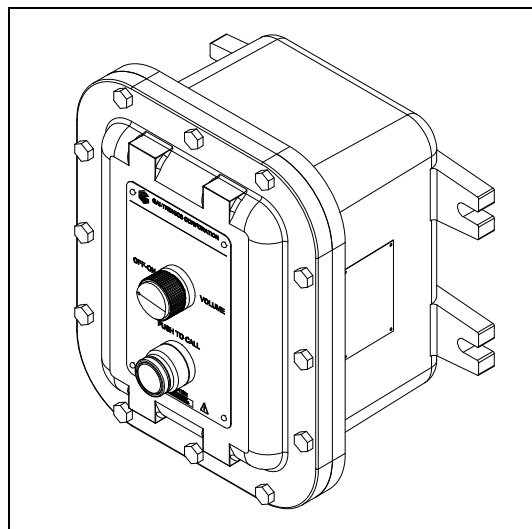

Figure 1. Model 400-003/400-004 RigCom Station

Safety Precautions



	CAUTION RISK OF ELECTRIC SHOCK. DO NOT OPEN!	
<p>CAUTION: TO REDUCE THE RISK OF ELECTRIC SHOCK, DO NOT REMOVE COVER (OR BACK). NO USER SERVICEABLE PARTS INSIDE. REFER SERVICING TO QUALIFIED SERVICE PERSONNEL.</p>		
	<p>This symbol indicates the presence of uninsulated “dangerous voltage” within the product’s enclosure. This may constitute a risk of electric shock.</p>	
	<p>The user should consult the operating and maintenance (servicing) instructions in the literature accompanying the appliance.</p>	

Important Safety Instructions

1. Read, follow, and retain instructions - All safety and operating instructions should be read and followed before operating the unit. Retain instructions for future reference.
2. Comply with all warnings on the unit and in the operating instructions.
3. Attachments not recommended by the product manufacturer shall not be used as they may cause hazards.
4. Do not attempt to service this unit yourself. Opening or removing covers may expose you to dangerous voltage or other hazards. Refer all servicing to qualified service personnel.
5. Electrical and mechanical installation and connection should be in compliance with all regulations. This permanently connected apparatus must have an ALL-POLE MAINS switch with a contact separation of at least 3 mm in each pole incorporated in the electrical installation of the building.

Installation

These enclosures must be installed by trained, qualified and competent personnel. Installation must comply with state and national regulations, as well as safety practices for this type of equipment.

 **CAUTION**  **Do not install this equipment in hazardous areas other than those indicated on the approval listing in the “Specifications” section of this manual. Such installation may cause a safety hazard and consequent injury or property damage.**

The mounting location must be flat and provide proper clearance, rigidity and strength to support the enclosure and all contained devices.

Securely fasten the enclosure to the mounting location, using (customer-supplied) 11 mm (7/16-inch) diameter steel mounting bolts and washers, or washer head bolts.



Insure proper grounding to protective earthing.

Do not disconnect equipment while energized.

Inspect and clean the machined flange flame joint surfaces of both the cover and box. Surfaces must be smooth, free of nicks, scratches, dirt or any foreign particle build-up that would prevent a proper seal. Surfaces must seat fully against each other to provide a proper explosion-proof joint. Clean surfaces by wiping with a clean lint-free cloth.

Make certain no cover bolts are omitted. Use only those bolts supplied with the enclosure. Recommended torque setting of cover bolts: 23 N-m (17 ft-lbs).

Mounting

NOTE: The mounting surface must be able to support the weight of the aluminum enclosure. The unit weight is 10.5 kg (23.0 lbs).

The enclosure must be securely fastened with 11mm (7/16-inch) diameter steel mounting bolts located on all four mounting feet. Stainless steel hardware is recommended for applications in corrosive environments. Refer to Figure 2 for mounting dimensions.

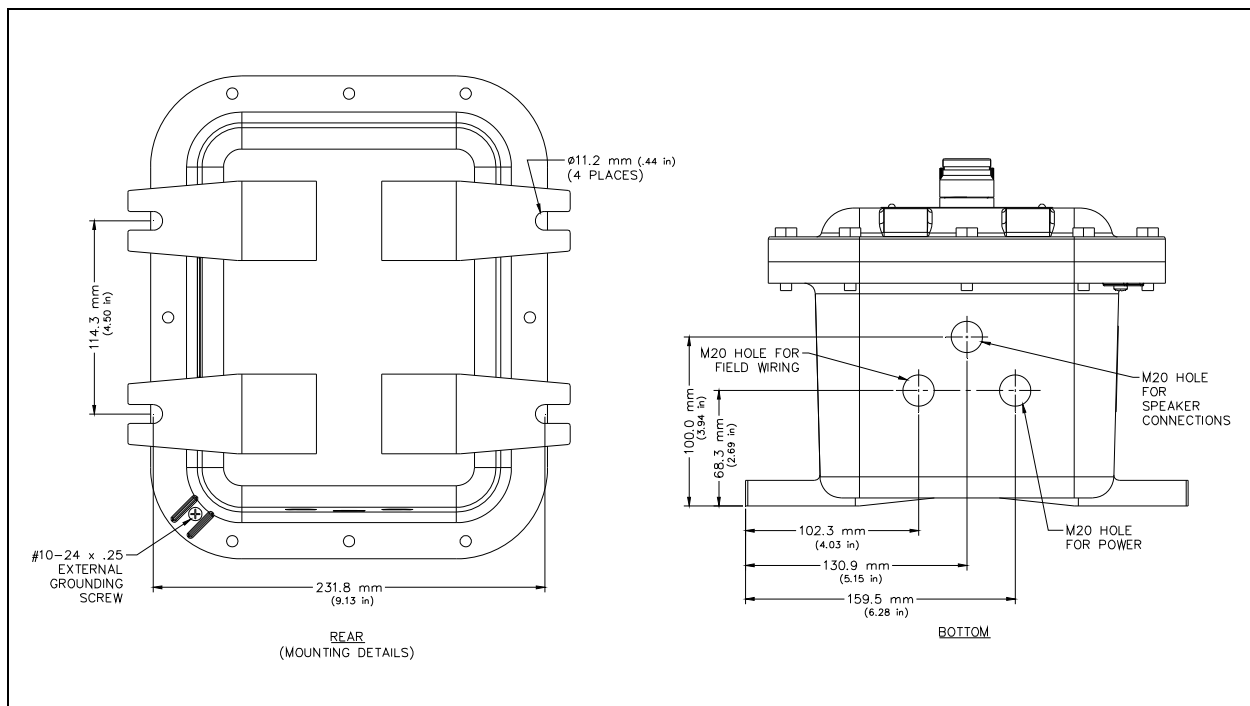

Figure 2. Model 400-003/400-004 Mounting Details and Entries

Hardware Configuration

External

The enclosure contains a push-to-call push button, an on-off/volume-control switch and applicable approval labeling. There are twelve 5/16-18 × 1.25-inch cover mounting bolts located around the perimeter of the enclosure.

The enclosure has an external grounding screw located on the underside of the flange. See Figure 2.

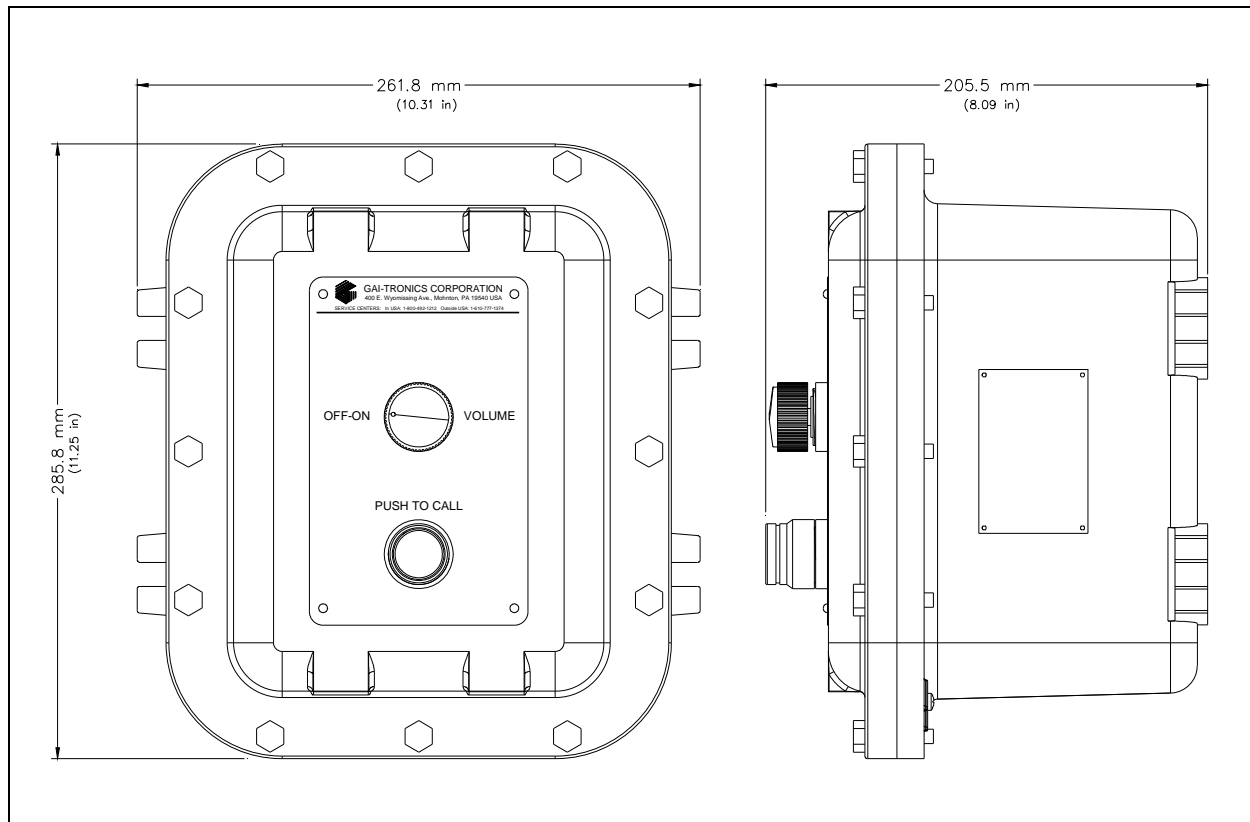

Figure 3. Model 400-003/400-004 RigCom Station Outline

Internal

The enclosure contains a single PCBA to which all customer cable terminations are made. Internal connections to the front cover assembly are by a plug-in single wiring harness with a plug. Internal grounding terminals are provided for ground connection.

Wiring

Station Wiring

While supporting the front cover, remove the 12 cover bolts on the enclosure flange. Pull the front cover far enough away to expose the internal connections and disconnect any wiring between the front cover and rear enclosure. Place the front cover aside.

Attach the cable glands to the holes on the bottom of the enclosure.

Cable glands must be certified to current ATEX and IECEx standards for type 'd' Flameproof protection as well as ambient protection.

In rigid conduit systems, a sealing fitting must be installed in accordance with local codes.

Feed the low-voltage wiring in the left side hole and the power wiring through the right side hole. Refer to Figure 2.

Attach the wires to the terminal blocks located on the PCBA within the enclosure. See Figure 4 and charts for connection points and descriptions. Use one conductor (0.50 mm² to 4 mm²) per screw terminal. Apply torque to 0.6 N-m.

If using the 10438-101 Auxiliary Microphone Assembly, connect the assembly to the station at terminal block TB4-1 (+) and TB4-2 (-), shield to TB4-5, if used. The maximum distance from the station is 50 feet using 1 mm² wire.

If using an auxiliary footswitch assembly (customer-supplied), connect the assembly to the station at terminal block TB4-8 (+) and TB4-9 (-), shield to TB4-5, if used. The maximum distance from the station is 50 feet using 1 mm² wire.

In this operation, the auxiliary microphone replaces the speaker as the microphone, and the auxiliary footswitch provides parallel functionality to the push-to-call switch.

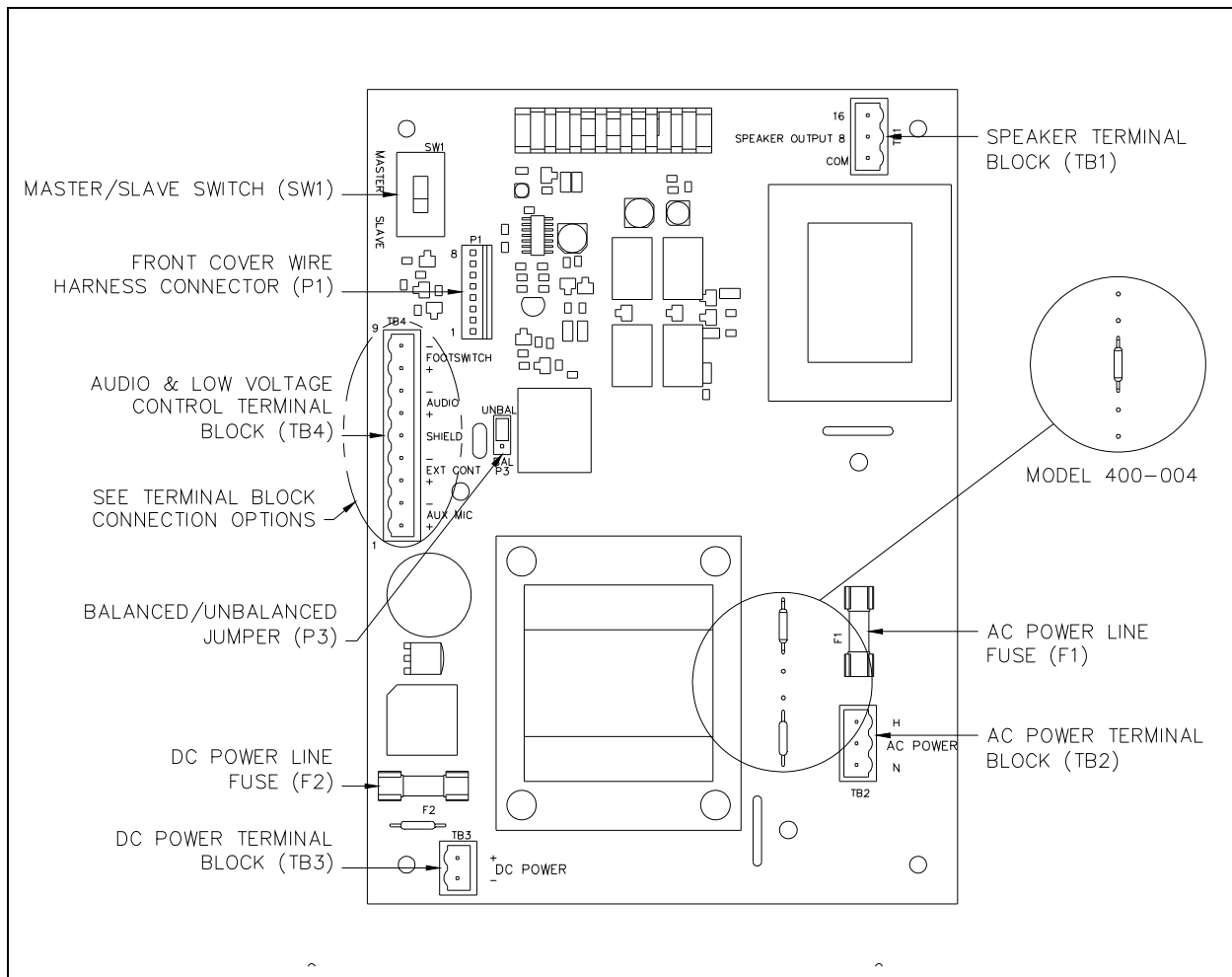

Figure 4. RigCom Station PCBA - Model 400-003 PCBA shown (with Model 400-004 difference shown in pull out)

System Line Balance

Each system requires termination of the audio pair wires with the 1 kΩ/1-watt resistor (included with each unit). The line balance resistor assembly is easily installed into the customer-supplied junction box.

NOTE: Only one line balance resistor assembly is needed per system.

For cable runs that are approximately 1219m (4,000 feet) or longer, it is recommended that the resistor assembly be installed in a junction box (customer-supplied) that is close to the center of the system. Refer to Figure 5 and Figure 6. The junction box must be suitable for the applicable hazardous location in which it is located.

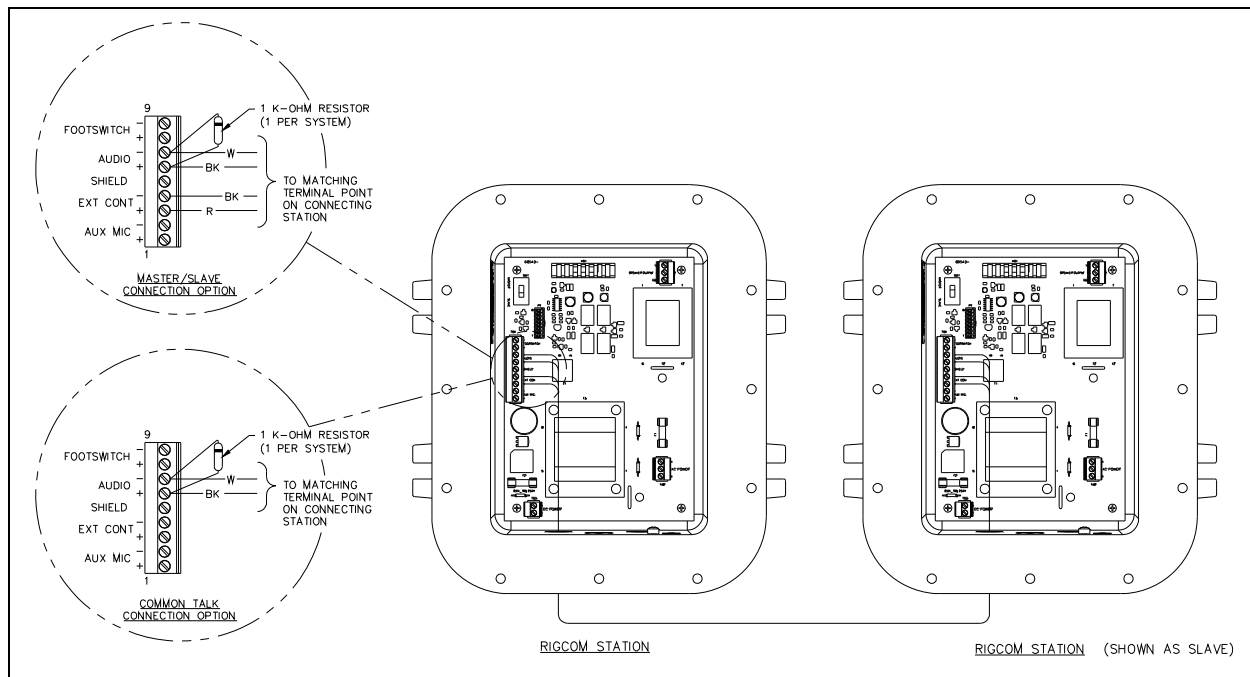

Figure 5. System cable wiring less than 1219m/4,000 feet in length (Model 400-003 stations shown)

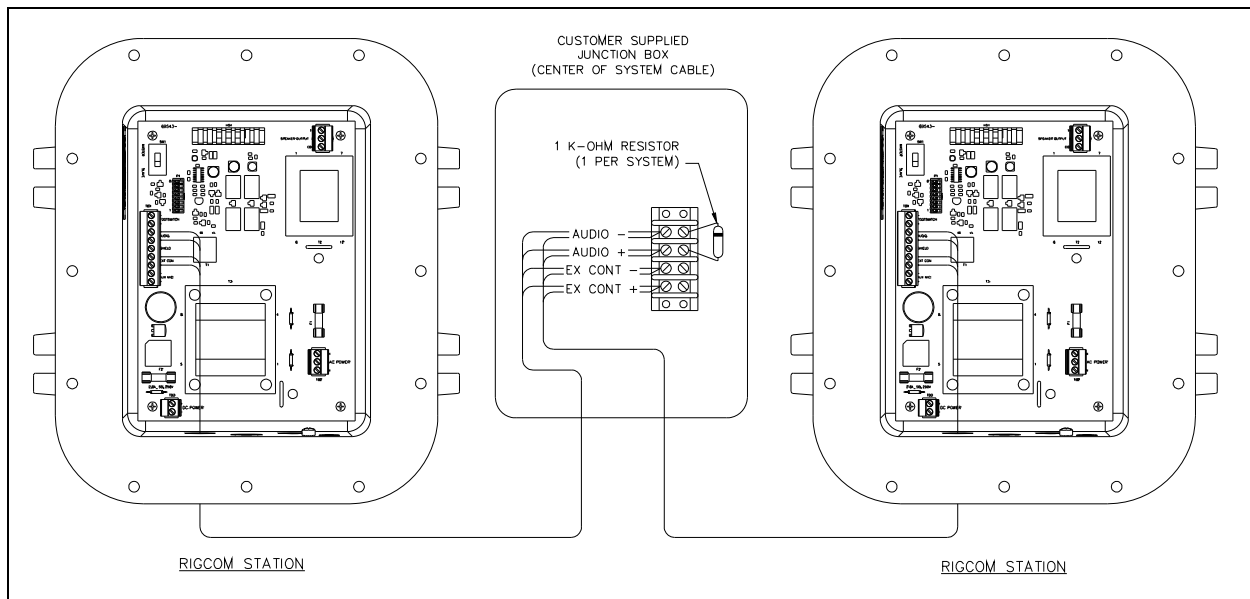

Figure 6. Master/Slave System cable wiring greater than 1219m/4,000 feet in length (Model 400-003 stations shown)

System Wiring

The maximum line length for the complete system, while still maintaining maximum output signal, is 4.5 km/15,000 feet for a system with less than ten stations using 1 mm² wiring, with stations spaced equidistantly, and one station in the call mode at a time. For each station in call mode, the signal level reduces by half. For systems with more than ten stations refer to Figure 7 for the maximum line distance.

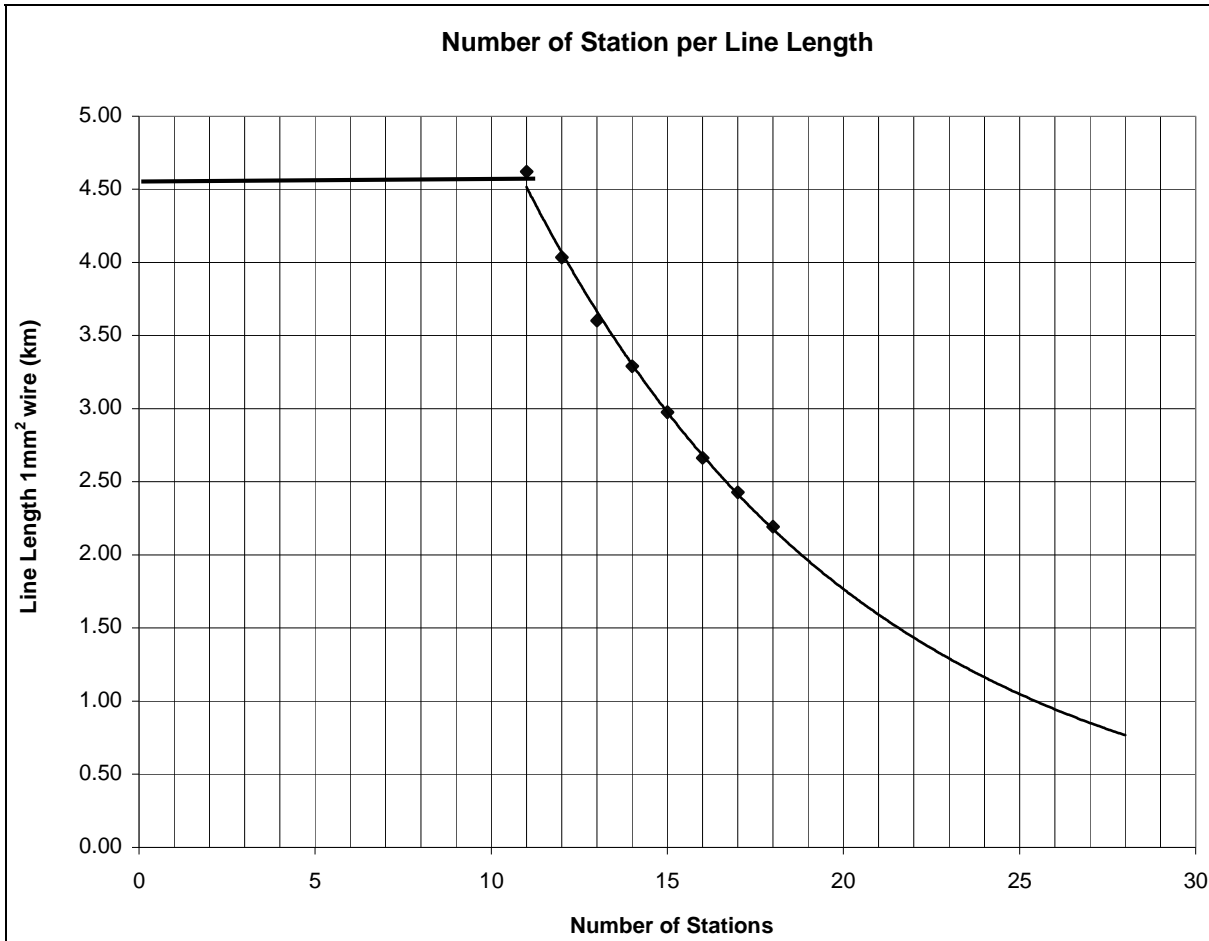

Figure 7. Number of Stations vs. Line Length

Field Installation Interface

TB1 - Speaker Terminal Block

The following is a list of connections for the speaker output terminal block, TB1:

Name	Pin No.	Description
16	1	16-ohm terminal for speaker connection.
8	2	8-ohm terminal for speaker connection.
COM	3	Common terminal for speaker connection.

TB2 - AC Voltage Terminal Block

The following is a list of connections for the ac voltage terminal block, TB2:

Name	Pin No.	Description
AC Power H	1	Live/hot terminal of the external ac power supply. No connection when external ac power supply is not used.
AC Power N	3	Neutral terminal of the external ac power supply. No connection when external ac power supply is not used.
AC Power GND		Ground/earth terminal for the ac power must be electrically connected to the chassis.

TB3 - DC Voltage Terminal Block

The following is a list of connections for the dc voltage terminal block, TB3:

Name	Pin No.	Description
DC Power Input+	2	Positive terminal of the external dc power supply. No connection when external dc power supply is not used.
DC Power Input-	1	Negative terminal of the external dc power supply. No connection when external dc power supply is not used.

NOTES:

- 1. Either 120 V ac power or 12 V dc may be connected to the Model 400-003 RigCom. Under no circumstances should ac and dc power be connected to the 400-003 station.**
- 2. Either 230 V ac power or 12 V dc may be connected to the Model 400-004 RigCom. Under no circumstances should ac and dc power be connected to the 400-004 station.**

TB4 - Audio and Low Voltage Control Terminal Block

The following is a list of connections for the low voltage control and audio signal terminal block, TB4:

Name	Pin No.	Description
Aux Mic+	1	Positive terminal for auxiliary microphone (optional).
Aux Mic-	2	Negative terminal for auxiliary microphone (optional).
Ext Cont+	3	Call/listen control signal for Master/Slave operation. No connection in Common Line mode.
Ext Cont-	4	Ground reference for call/listen control signal for Master/Slave operation. No connection in Common Line mode or UNBAL audio configuration.
Shield	5	Ground reference for shield terminations.
Audio+	6	Positive of the audio line during 600-ohm or 15-kilohm termination configuration.
Audio-	7	Negative of the audio page line during 600-ohm or 15-kilohm termination configuration.
Footswitch+	8	Positive of optional auxiliary footswitch operating as local push-to-call switch.
Footswitch-	9	Negative of optional auxiliary footswitch that operating as local push-to-call switch.

P1 - Front Cover Wire Harness Connections

Plug in the front cover wire harness connector at P1. Refer to Figure 8.

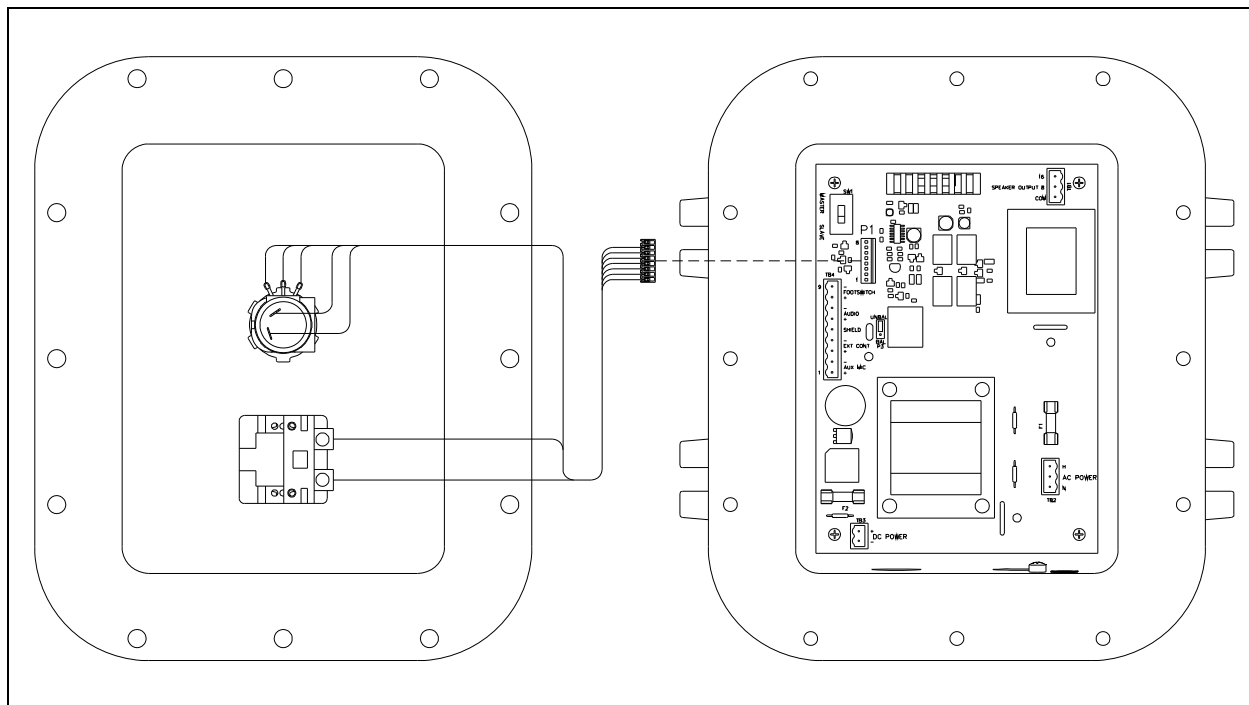

Figure 8. Model 400-003 shown

P3 - Balanced / Unbalanced Jumper

Jumper P3 allows the installer to configure the unit for balanced or unbalanced audio connections. If the header is installed in the **BAL** position, the assembly is configured for a balanced audio input signal operation. If the header is installed in the **UNBAL** position, the assembly is configured for an unbalanced input signal. In systems where the external control signal is single-ended, the system must be set up as an unbalanced system.

SW1 - Master/Slave Switch

Switch SW1 allows the installer to configure the unit as a Slave or Master unit. If the switch is in the **SLAVE** position, the unit is configured as a Slave. If the switch is in the **MASTER** position, the unit is configured as a Master. For Common Line operation, the switch must be in the **MASTER** position.

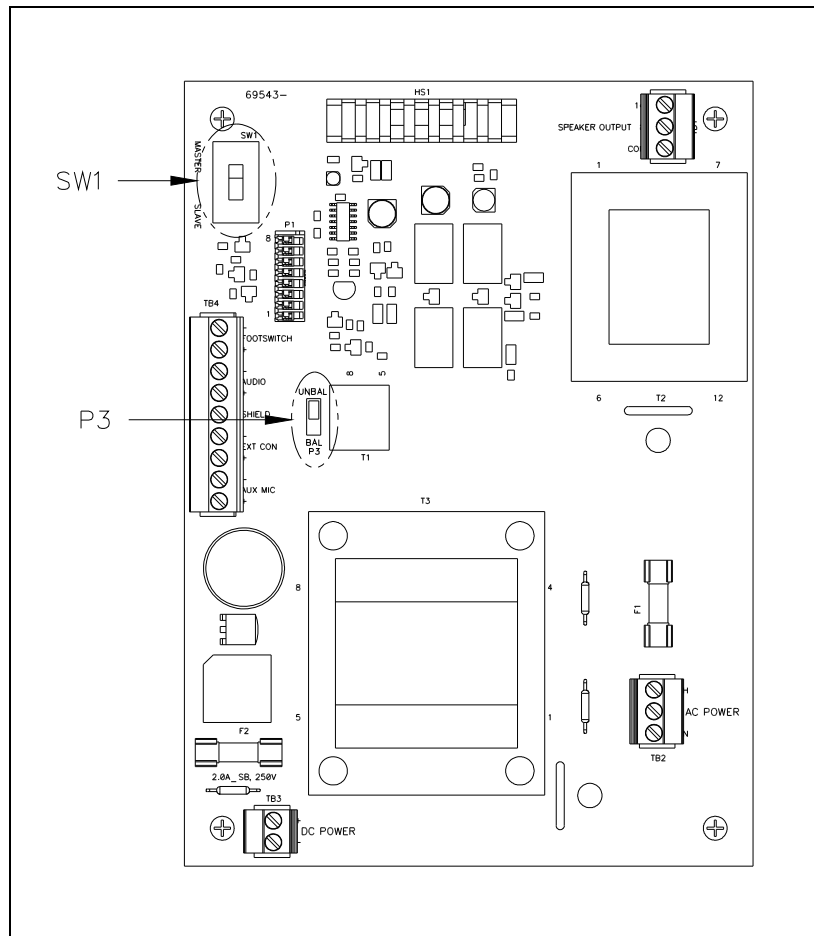

Figure 9. RigCom Station PCBA (Model 400-003 shown)

Operation

The operator has access to an on-off/volume-control switch and the push-to-call push button.

The on-off/volume-control switch allows the operator to turn the unit on or off and adjust the volume level in the listen mode.

Turn the unit off by turning the switch completely anti/counterclockwise. For maximum volume, adjust the switch completely clockwise.

The push-to-call push button controls the audio communication between stations.

When activated, the push-to-call switch allows the operator to send a message to another station. When not activated, the station is in listen mode and the station receives messages from other stations. When a station is configured as a Slave station, the push-to-call switch has no function.

Common Line System

In the Common Line configuration, all of the stations are on common calling path and are normally in the listen mode. When one of the stations has its push-to-call toggle switch activated, its audio signal is supplied to the audio lines. All other units receive the audio signal and broadcast the announcement over their speakers. The push-to-call switch must be held down as long as the operator talks. Releasing the switch deactivates the microphone and returns the unit to the listen mode.

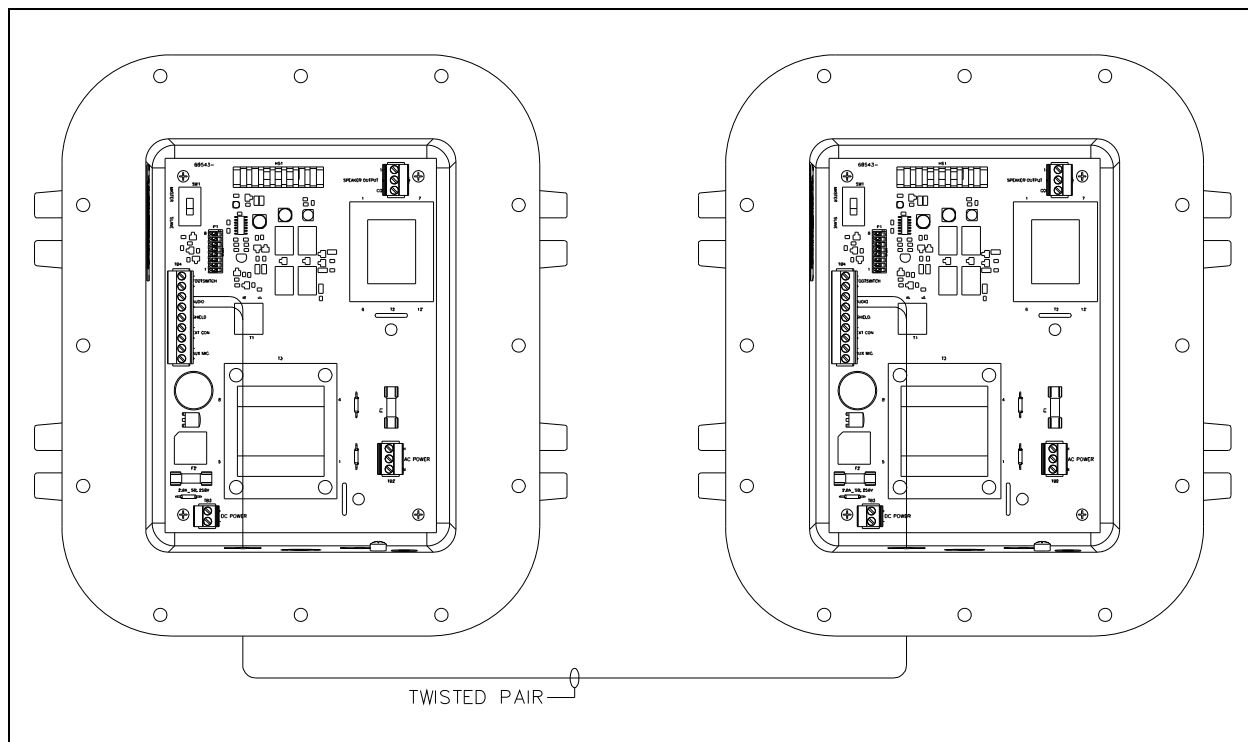

Figure 10. Common Talk Wiring Detail (Model 400-003 shown)

Master/Slave System

In the Master/Slave configuration, a Master station controls the call-listen function of the Slave units through external control wiring.

When the Master's push-to-call is not activated, the Slave stations are in call mode allowing the Master to monitor the Slave's audio. When the Master's push-to-call is activated, the Slaves are in listen mode allowing the Master to transmit audio to the Slave stations. The Slave's push-to-call is not operable, and their operation is hands-free.

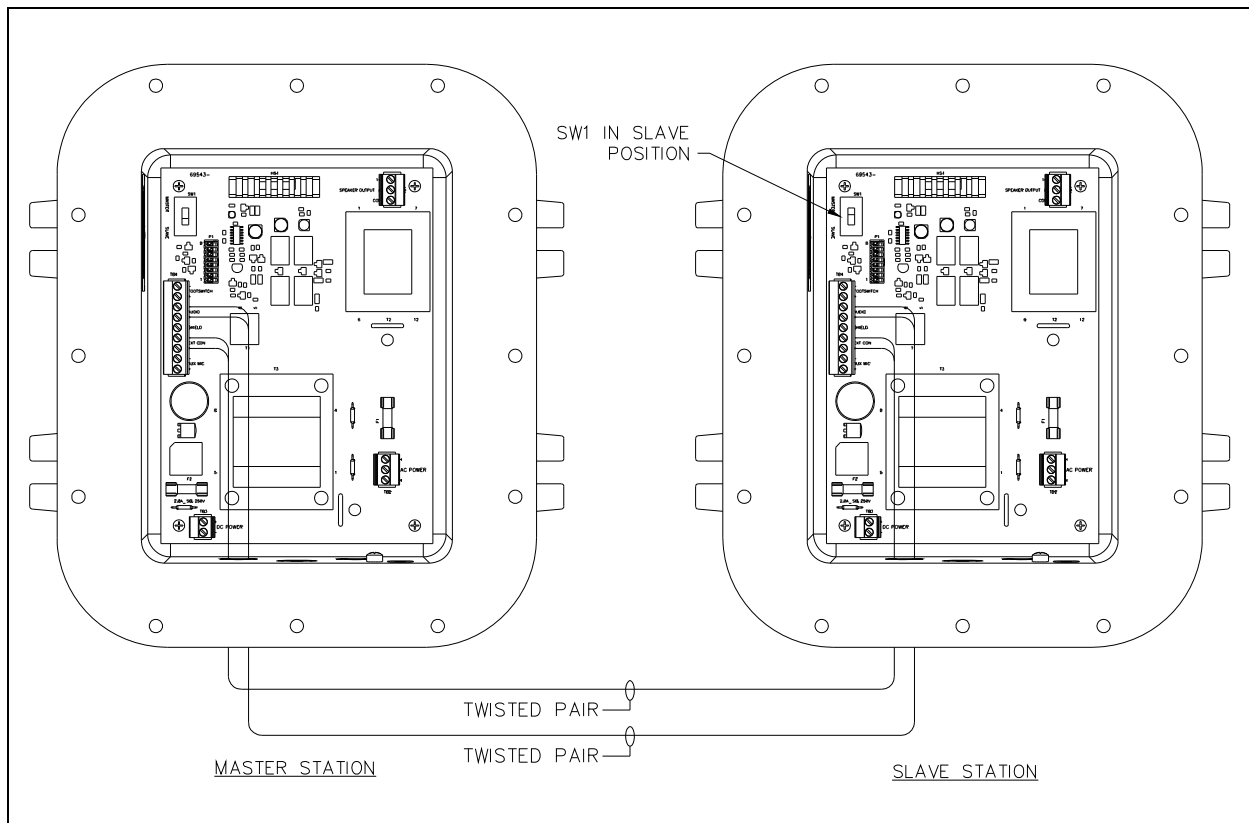







Figure 11. Master/Slave Wiring Detail (Model 400-003 shown)

Maintenance



 **CAUTION**  **These servicing instructions are for use by qualified service personnel only. To reduce risk of electric shock, do not perform any servicing other than that contained in the operating section unless you are qualified to do so.**

Regular inspection and a good preventive maintenance program will increase the reliability of your GAI-Tronics station. The GAI-Tronics Field Service Department can formulate a service contract suited to your facility's specific need for preventive maintenance.

 **WARNING**  **Before performing any of the following preventive maintenance steps, remove all power from the station.**

 **CAUTION**  **To reduce the risk of ignition of hazardous atmospheres, disconnect the equipment from the supply circuit before making any adjustments to the PCBA's settings.**

F1/F2 Fuses

 **WARNING**  **Do not remove fuses when energized. Replace with the same type and size fuse for continued safe operation.**

Model 400-003

F1 is the fuse on the ac power line: T400 mA, 250 V, 5×20mm, IEC 60127-2/3.

F2 is the fuse on the dc power line: T1.6 A, 250 V, 5 × 20mm, IEC 60127-2/3.

Model 400-004

F1 is the fuse on the ac power line: T315 mA, 250 V, 5×20mm, IEC 60127-2/3.

F2 is the fuse on the dc power line: T1.6 A, 250 V, 5×20mm, IEC 60127-2/3.

Closing the Unit - All Models

Inspect and clean the machined flange flame joint surfaces of both the cover and box. Surfaces must be smooth, free of nicks, scratches, dirt or any foreign particle build-up that would prevent a proper seal. Surfaces must seat fully against each other to provide a proper explosion-proof joint. Clean surfaces by wiping with a clean lint-free cloth.

Install and tighten all cover bolts to 23 N-m (17 ft-lbs). Make certain no cover bolts are omitted. Use only those bolts supplied with the enclosure.

Troubleshooting

Problem	Solution
Problem with station performance	Review installation, ensuring that you correctly followed all steps. Check all terminations on the board.
Speaker volume too low.	Adjust volume control. Replace speaker.
Crosstalk	One or more system cable pairs may be improperly terminated. Visually inspect the system cable for accidental crossing of cable pairs or grounds.

Specifications

AC Power

Voltage

Model 400-003.....	120 V ac, 50/60 Hz
Model 400-004.....	230 V ac, 50/60 Hz

Power consumed (at nominal)

Off (mute)	6 VA, 1.8 W
Standby.....	7.2 VA, 3.6 W
Maximum speaker out	30 VA, 27 W

DC Power

Voltage.....	12 V dc
--------------	---------

Power consumed (at nominal)

Off (mute)	0.3 W
Standby.....	3 W
Maximum speaker out	20 W

Amplifier PCBA

Frequency response.....	300–8 kHz, +/-3 dB
Audio output	8.0 W
Audio THD distortion	1% maximum, 8-W output
Hum/Noise.....	1% maximum, 8-W output
Gain - Listen mode.....	30 dB
Gain - Call mode (speaker as the microphone).....	42 dB
Gain - Call mode (auxiliary microphone).....	48 dB

Station
 Construction/finish..... Cast aluminum/Tumblast finish
 Mounting..... Wall or column, four 11-mm mounting feet with slots
 Connections..... Plug-in style terminal blocks
 Conduit entries..... Bottom – three M20 × 1.5 tapped holes
 Dimensions 508.0 H × 261.9 W × 360.9 D mm (20.00 × 10.31 × 14.21 inches)
 Shipping weight 10.5 kg (23.0 lbs)

Environmental
 Temperature range (operating and storage) -40° C to +60° C (-40° F to +140° F)
 Humidity 95% non-condensing
 Outdoor environmental rating.....IP66

Approvals
 CE Mark
 Certificate No.
 Notified Body Id No. 0539
 Lyskear 8
 DK-2730 Herlev
 Denmark
 DEMKO 12 ATEX 1116051 (ATEX)..... II 2 Ex d IIB T6 Gb
 II 2 D Ex tb IIIC T85 °C Db IP66
 IECEx UL 12.0012 (IECEx)..... Ex d IIB T6 Gb
 Ex tb IIIC T85 °C Db IP66

Replacement Parts

Contact GAI-Tronics for replacement part information.

Accessories

Part No.	Description
12801-001	Auxiliary Microphone
51052-003	Auxiliary Footswitch
10438-101	Microphone I.S. Barrier Kit (contains 12801-001 Auxiliary Mic assembly)
12807-001	Connector Kit
60075-001	Audio cable, No. 18 AWG, (two-pair)

Warranty

Equipment. GAI-Tronics warrants for a period of one (1) year from the date of shipment, that any GAI-Tronics equipment supplied hereunder shall be free of defects in material and workmanship, shall comply with the then-current product specifications and product literature, and if applicable, shall be fit for the purpose specified in the agreed-upon quotation or proposal document. If (a) Seller's goods prove to be defective in workmanship and/or material under normal and proper usage, or unfit for the purpose specified and agreed upon, and (b) Buyer's claim is made within the warranty period set forth above, Buyer may return such goods to GAI-Tronics' nearest depot repair facility, freight prepaid, at which time they will be repaired or replaced, at Seller's option, without charge to Buyer. Repair or replacement shall be Buyer's sole and exclusive remedy. The warranty period on any repaired or replacement equipment shall be the greater of the ninety (90) day repair warranty or one (1) year from the date the original equipment was shipped. In no event shall GAI-Tronics warranty obligations with respect to equipment exceed 100% of the total cost of the equipment supplied hereunder. Buyer may also be entitled to the manufacturer's warranty on any third-party goods supplied by GAI-Tronics hereunder. The applicability of any such third-party warranty will be determined by GAI-Tronics.

Services. Any services GAI-Tronics provides hereunder, whether directly or through subcontractors, shall be performed in accordance with the standard of care with which such services are normally provided in the industry. If the services fail to meet the applicable industry standard, GAI-Tronics will re-perform such services at no cost to buyer to correct said deficiency to Company's satisfaction provided any and all issues are identified prior to the demobilization of the Contractor's personnel from the work site. Re-performance of services shall be Buyer's sole and exclusive remedy, and in no event shall GAI-Tronics warranty obligations with respect to services exceed 100% of the total cost of the services provided hereunder.

Warranty Periods. Every claim by Buyer alleging a defect in the goods and/or services provided hereunder shall be deemed waived unless such claim is made in writing within the applicable warranty periods as set forth above. Provided, however, that if the defect complained of is latent and not discoverable within the above warranty periods, every claim arising on account of such latent defect shall be deemed waived unless it is made in writing within a reasonable time after such latent defect is or should have been discovered by Buyer.

Limitations / Exclusions. The warranties herein shall not apply to, and GAI-Tronics shall not be responsible for, any damage to the goods or failure of the services supplied hereunder, to the extent caused by Buyer's neglect, failure to follow operational and maintenance procedures provided with the equipment, or the use of technicians not specifically authorized by GAI-Tronics to maintain or service the equipment. **THE WARRANTIES AND REMEDIES CONTAINED HEREIN ARE IN LIEU OF AND EXCLUDE ALL OTHER WARRANTIES AND REMEDIES, WHETHER EXPRESS OR IMPLIED BY OPERATION OF LAW OR OTHERWISE, INCLUDING ANY WARRANTIES OF MERCHANTABILITY OR FITNESS FOR A PARTICULAR PURPOSE.**

Return Policy

If the equipment requires service, contact your Regional Service Center for a return authorization number (RA#). Equipment should be shipped prepaid to GAI-Tronics with a return authorization number and a purchase order number. If the equipment is under warranty, repairs or a replacement will be made in accordance with the warranty policy set forth above. Please include a written explanation of all defects to assist our technicians in their troubleshooting efforts.

Call 800-492-1212 (inside the USA) or 610-777-1374 (outside the USA) for help identifying the Regional Service Center closest to you.