



GAI-TRONICS®  
A HUBBELL COMPANY

# SP2 Fiber Zone 2/22 Weatherproof Handset/Speaker Amplifier Station

## TABLE OF CONTENTS

<i>Confidentiality Notice</i> .....	<i>1</i>
<i>General Information</i> .....	<i>1</i>
<b>Product Overview</b> .....	<b>1</b>
<b>Features</b> .....	<b>2</b>
<b>Options</b> .....	<b>2</b>
<i>Installation</i> .....	<i>3</i>
<b>Important Safety Instructions</b> .....	<b>3</b>
<b>Enclosure Mounting and Cable Entries</b> .....	<b>4</b>
<b>Open the Station</b> .....	<b>5</b>
<b>Field Wiring and Configuration</b> .....	<b>5</b>
Station Ground.....	5
Termination PCBA .....	6
<b>Main PCBA—600-Ohm Audio I/O with Control</b> .....	<b>11</b>
<b>Fiber Termination Board</b> .....	<b>12</b>
<i>Settings and Adjustments</i> .....	<i>13</i>
<b>Open the Station</b> .....	<b>13</b>
<b>Main PCBA Configuration</b> .....	<b>13</b>
Write Protect (EEPROM) Jumper.....	13
WDOG Enable (Watchdog) Jumper .....	13
Boot Enable Jumper .....	14
Reset Switch.....	14
Speaker and 600-ohm Audio Output Volume.....	14
Receiver Volume .....	15
Group and Station Number Selector Switches.....	15
<b>Main PCBA Indicators</b> .....	<b>15</b>
Power LED.....	15
Heartbeat LED .....	15
Ethernet Connection LEDs .....	15
Five Generic LEDs .....	16
<b>Front Cover Installation</b> .....	<b>16</b>
<i>Programming</i> .....	<i>16</i>
<i>Operation</i> .....	<i>16</i>

---

<b>Standard Handset Paging</b> .....	<b>16</b>
<b>Party Line Communication</b> .....	<b>17</b>
<b>All-Call Button Use</b> .....	<b>17</b>
<b>Alternate-Page Destination Switch Use</b> .....	<b>18</b>
<b>Headset Use</b> .....	<b>18</b>
<b><i>Troubleshooting</i></b> .....	<b><i>19</i></b>
<b><i>Service and Spare Parts</i></b> .....	<b><i>20</i></b>
<b><i>Reference Documentation</i></b> .....	<b><i>20</i></b>
<b><i>Specifications</i></b> .....	<b><i>20</i></b>
<b>Power</b> .....	<b>20</b>
<b>Ethernet</b> .....	<b>20</b>
<b>RTU</b> .....	<b>21</b>
<b>Audio</b> .....	<b>21</b>
<b>Mechanical</b> .....	<b>22</b>
<b>Environmental</b> .....	<b>22</b>
<b><i>Approvals</i></b> .....	<b><i>22</i></b>



**GAI-TRONICS® CORPORATION**  
A HUBBELL COMPANY

# SP2 Fiber Zone 2/22 Weatherproof Handset/Speaker Amplifier Station

## Confidentiality Notice

This manual is provided solely as an installation, operation, and maintenance guide and contains sensitive business and technical information that is confidential and proprietary to GAI-Tronics. GAI-Tronics retains all intellectual property and other rights in or to the information contained herein, and such information may only be used in connection with the operation of your GAI-Tronics product or system. This manual may not be disclosed in any form, in whole or in part, directly or indirectly, to any third party.

This product contains copyrighted computer programs stored in semiconductor memory. These programs are copyrighted by GAI-Tronics Corporation and may not be reproduced in any form without express written permission from GAI-Tronics.

## General Information

### Product Overview

The GAI-Tronics SP2 station is a modular industrial multicast VoIP (Voice over Internet Protocol) communication system. The standard SP2 fiber Zone 2/22 configuration is an outdoor, multi-party, handset/speaker amplifier station using ac power with RTU control. They are constructed of black carbon-loaded, glass-reinforced polyester and are extremely weatherproof and corrosion resistant. A number of options are available to add to or modify station capabilities (see the [Features](#) and [Options](#) sections below).

SP2 stations connect to an Ethernet network so the loss of a single station will not adversely affect the entire system. The stations require a 100 Mbps link to a switch or router using fiber optic cable. Isolate SP2 network traffic from other network devices to ensure the quality of SP2 audio. Properly configure network switches and routers for IGMP (Internet Group Management Protocol) snooping and multicast filtering. Maximum cable runs between fiber SP2 stations and network switches are determined by the type of fiber optic cable used in the installation.

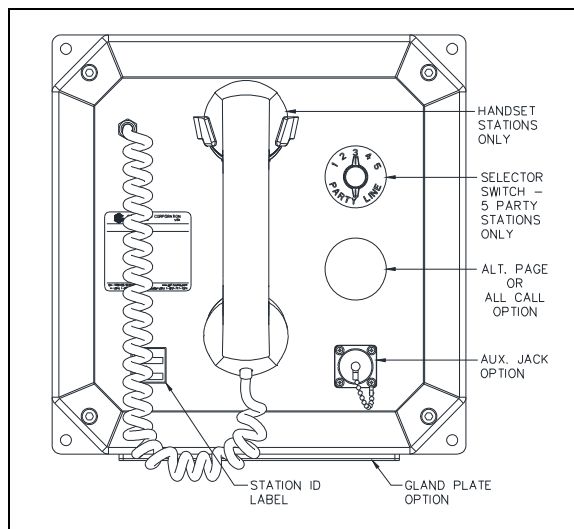

Figure 1. SP2 Zone 2/22 Weatherproof Station Front Panel

## Features

- flexible and highly configurable SMART technology featuring ALS (ambient level sensing), real time self-diagnostics, and available remote monitoring
- real-time operation providing instantaneous page and party line communication
- no SIP server or conference bridge requirement
- one-way live paging and alarm annunciation over system speakers
- distributed amplifier topology—loss of an individual amplifier will not adversely affect the system as a whole
- mutual provisioning mode allows easy system deployment
- high efficiency (>80%) Class D paging amplifier provides up to 30 watts of speaker output at 8 ohms
- five configurable multicast channels for full-duplex conference communication with party line selector switch
- eight configurable multicast channels for receiving page announcements
- one isolated output for beacon activation
- two isolated inputs
- 600-ohm audio I/O with control
- configurable priority scheme to allow urgent/emergency pages to override less important pages
- configuration stored in non-volatile memory
- field adjustable volume control for handset earpiece, headset earpiece, and speaker amplifier
- configurable local and nearby speaker mutual muting to prevent acoustic feedback of live pages
- configurable pre-announcement tone
- off-hook and page switch timeout functionality
- configurable virtual zoning ability
- USB interface for field or bench configuration
- universal ac power supply
- black carbon-loaded, glass-reinforced polyester enclosure

## Options

All SP2 station options are factory installed.



- 70/100V constant voltage termination board with 24-watt monitored output
- 24 V dc power supply
- speaker amplifier only (no handset)
- headset with page pressbar for loud environments
- five configurable multicast channels for alternate page destinations with page line selector
- All-Call push button for secondary page destination
- PVC or HytreI<sup>®</sup> handset cords in 6-, 15-, or 25-foot lengths
- conformal coating for PCBA

# Installation



## Important Safety Instructions



This equipment is suitable for use in Zone 2/22 hazardous areas OR non-hazardous locations only. Combinations of equipment in your system are subject to investigation by the local authority at the time of installation.

- **Read, follow, and retain instructions**—Read and follow all safety and operating instructions before installing or operating the unit. Retain instructions for future reference.
- **Heed warnings**—Adhere to all warnings on the unit and in the operating instructions.
- **Attachments**—Do not use attachments not recommended by the product manufacturer, as they may cause hazards.
- **Servicing**—Do not attempt to service this unit. Opening or removing covers may expose dangerous voltage or other hazards. Refer all servicing to qualified service personnel.



 **WARNING**  —**POTENTIAL ELECTROSTATIC CHARGING HAZARD**—Use the Model 10401-201 Headset and 10416-103 Extension Cord in Group IIB or Group IIA areas only.

The external metallic unearthed components of this equipment have measured capacitance values of 140 pF to 580 pF. As such, take exceptional care with the location and environment of the installation to address this hazard. See EN TR50404, Electrostatics—Code of Practice for Avoidance of Hazards Due to Static Electricity, for additional information regarding proper installation and potential hazards.

 **WARNING**  —**EXPLOSION HAZARD**—Do not disconnect equipment before removing power and verifying the area is known to be non-hazardous. Avertissement—Risque d'explosion—avant de déconnecter l'équipement, couper le courant ou s'assurer que l'emplacement est désigné non dangereux.

 **WARNING**  —**In 24 V dc systems:** Do **NOT** operate this equipment from a battery charger with the batteries disconnected. Most 24 V dc battery chargers have an unloaded output of 35 to 45 volts that can quickly damage equipment designed for 24 volts nominal. Do not allow the maximum battery voltage to exceed the maximum specified input voltage.

 **WARNING**  —**Do not disconnect equipment while energized.**  
**Ensure proper grounding to protective earthing.**

 **ATTENTION**  —This device requires an active laser component provided by the end installer: supply voltage 3.3 V dc, supply current 300 mA, power dissipation 1 W, operating at 100 Mbps. Fiber optic module must comply with the provisions of Laser Class 1.

Only trained, qualified, and competent personnel must install these enclosures. Installation must comply with state and national regulations, as well as safety practices for this type of equipment. The mounting location must be flat and provide proper clearance, rigidity, and strength to support the enclosure and all contained devices.

## Enclosure Mounting and Cable Entries

Mount the enclosure to a flat surface that provides proper clearance, rigidity, and strength to support the enclosure and all contained devices:

1. Mount the enclosure using the four 0.31-inch (8 mm) diameter holes, located on the mounting flanges, with 5/16-inch (M6) hardware (see Figure 2).

- Use caution to avoid damaging the internal components.
- The suggested mounting height for all station enclosures is 48 inches (1219 mm) to the center of the bottom mounting holes of the enclosure.
- SP2 stations are not supplied with conduit or cable openings.

2. Remove the front panel (see the Open the Station section).

Zone 2/22 stations are supplied with or without a stainless-steel gland plate located on the bottom of the rear enclosure

3. *For stations with a gland plate:* Remove the gland plate.

4. Drill or punch wire entry openings in the rear enclosure or gland plate (see Figure 2).

- The station is suitable for bottom and/or top entry.
- *Recommended:* Bottom entry prevents condensation that may form in the conduit from dripping onto the termination PCBA.
- The minimum material (spacing) between entry holes is 1/2 inch (13 mm).

5. *For stations with a gland plate:*

1. Reinstall the gland plate.
2. Torque the #6-32 gland-plate nuts to 10–12 in·lb (1.13–1.36 N·m).

6. Seal all unused openings with proper fittings per local standards.

- All metric cable entry devices and blanking elements shall be certified for Zone 2/22 applications with an IP66 rating, suitable for conditions of use, and correctly installed.
- Use field wiring suitable for the ambient temperature.

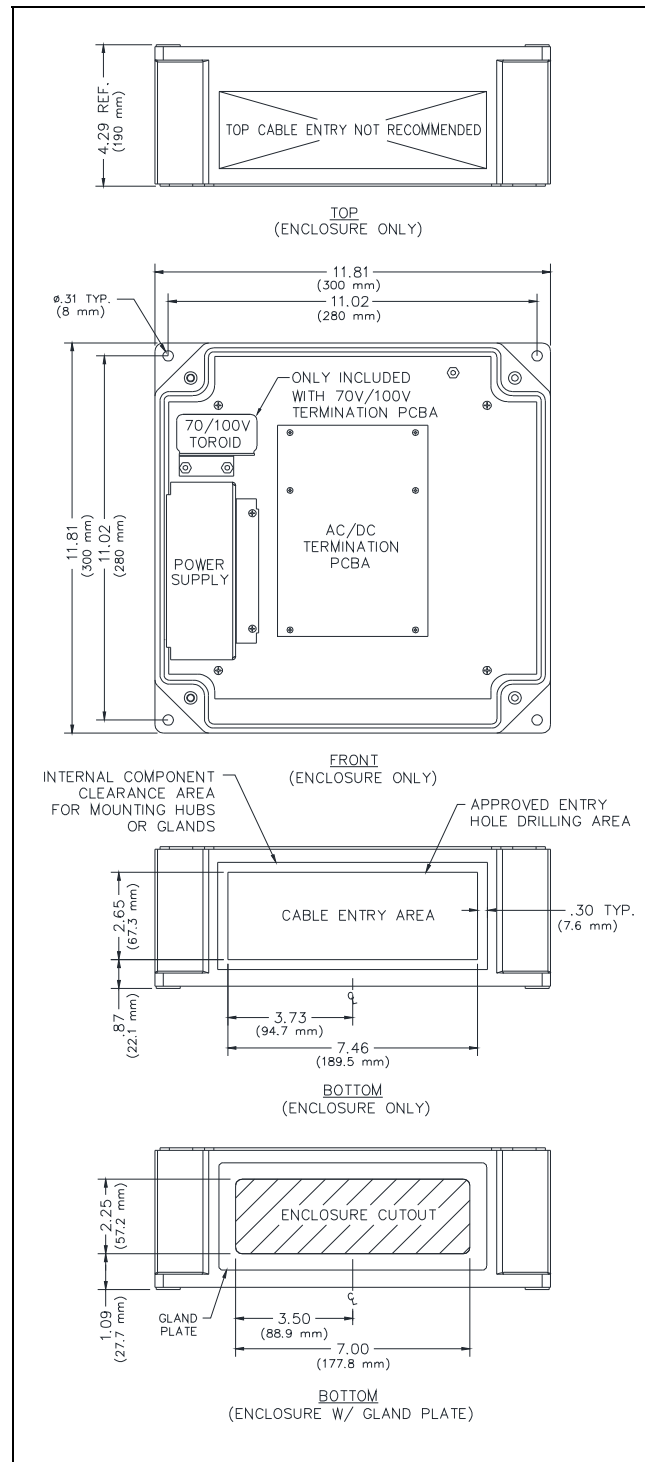

Figure 2. Mounting Details and Suggested Cable Entry Locations

## Open the Station

Complete the following steps to open the station:

1. Remove the four screws from the front cover and turn it to the left to expose the interior surfaces.
2. Keep the wiring and ribbon cables connected.

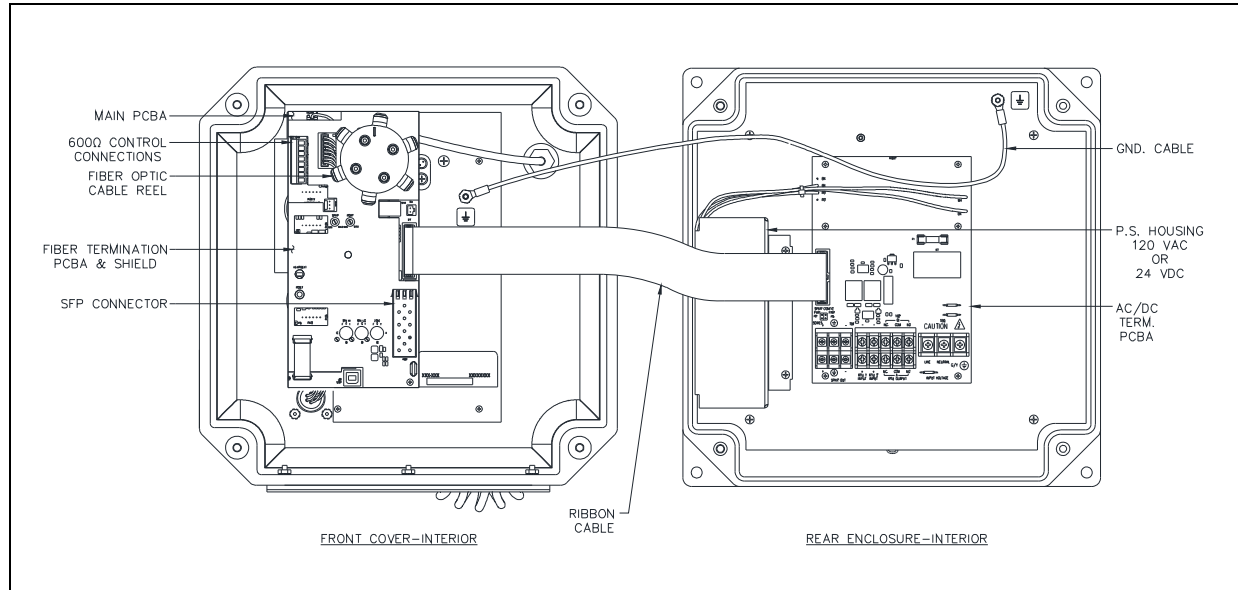

Figure 3. SP2 Zone 2/22 Fiber Station—Interior View

## Field Wiring and Configuration

The Fiber Zone 2/22 SP2 station provides terminal blocks on the termination PCBA, in the rear of the enclosure, for field wiring the power, speaker, and RTU connections. The main PCBA, mounted to the back of the front panel, contains the 600-ohm audio connection. The fiber termination board, mounted on top of the main PCBA, provides fiber optic termination for the Ethernet SFP transceiver.

- Seal all unused openings with proper fittings per local standards.
- All metric cable entry devices and blanking elements shall be certified for Zone 2/22 applications with an IP66 rating suitable for conditions of use and correctly installed.
- Use field wiring suitable for the ambient temperature.

**NOTE:** Consult the National Electrical Code (NFPA 70), Canadian Standards Association (CSA 22.1), and local codes for the specific requirements regarding your installation. Install all equipment without modification and according to local and national codes. Class 2 circuit wiring must be performed in accordance with the NEC.

### Station Ground

The station enclosure must have an earth ground connection.

1. Install a #6 ring lug on the ground conductor.
2. Secure it to the ground terminal located in the upper right corner at the back of the rear enclosure (see Figure 3).

Termination PCBA

Install all connections as indicated in the following sections:

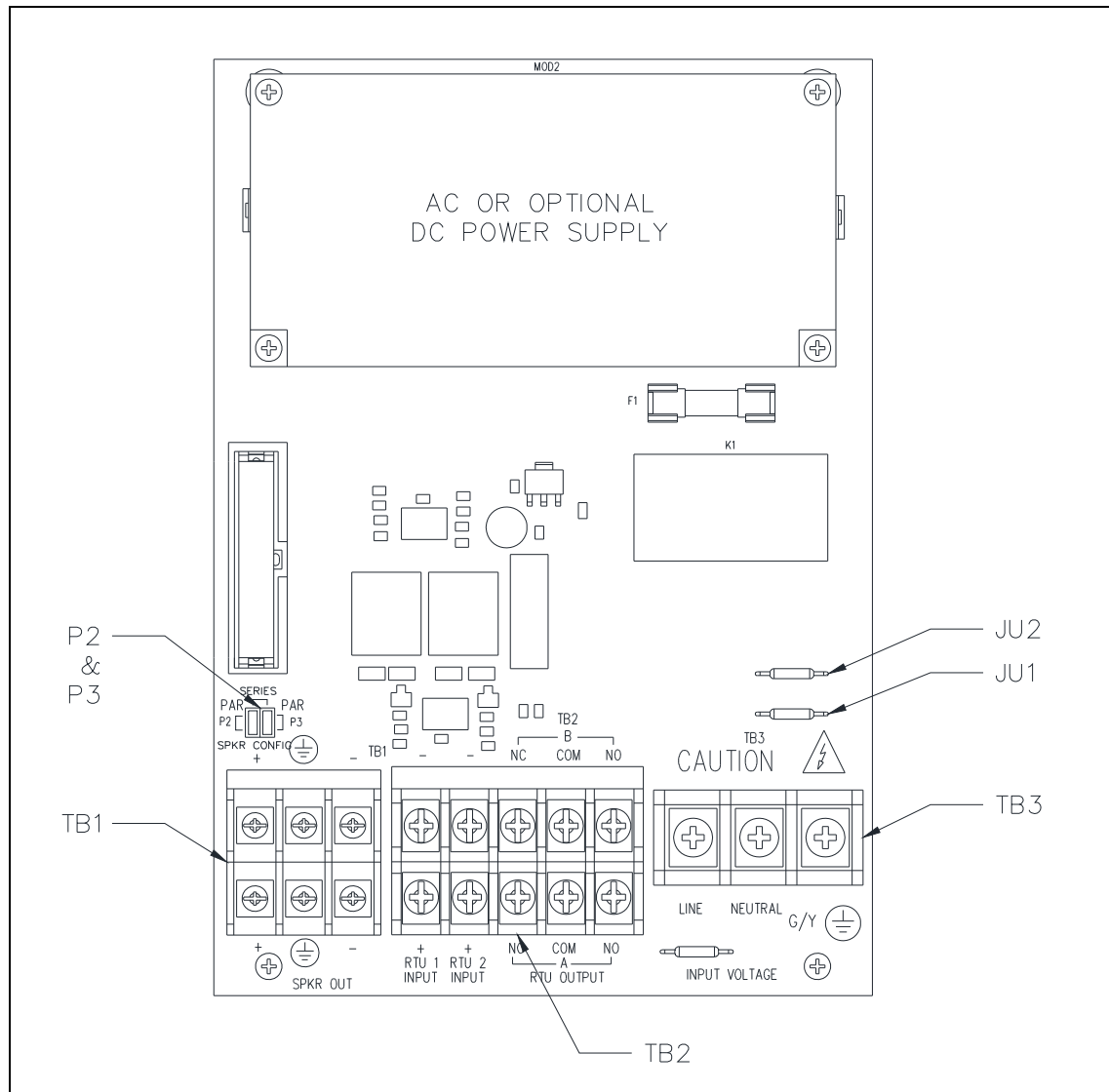

Figure 4. SP2 Standard Termination PCBA  
(Optional 70V/100V Termination PCBA Similar)

**Direct Speaker Connection and Jumper Settings**

Terminal block TB1 provides termination for the station’s 8 or 16-ohm remote speaker(s).

1. Pull the speaker cable(s) into the rear enclosure.
2. Install spade lugs on the wires.
3. Connect the speaker wires to terminal block TB1 (see Table 1).
4. Torque the terminal block screws to 8–10 in·lb (0.90–1.13 N·m).
5. Configure the speaker jumpers; P2 and P3, for the appropriate impedance for use with 8-ohm or 16-ohm speakers (see Figure 4 and Figure 5).

A redundant set of terminals enables connection of a second speaker branch connected in series or parallel with the primary speaker.



Table 1. Direct Speaker Connections—TB1

Pin	Label	Description
TB1-1	+	Primary Parallel/SPEAKER A Series—Output
TB1-2	⊥	Earth Reference
TB1-3	-	Primary Parallel/SPEAKER A Series—Output
TB1-4	+	Secondary Parallel/SPEAKER B Series—Output
TB1-5	⊥	Earth Reference
TB1-6	-	Secondary Parallel/SPEAKER B Series—Output

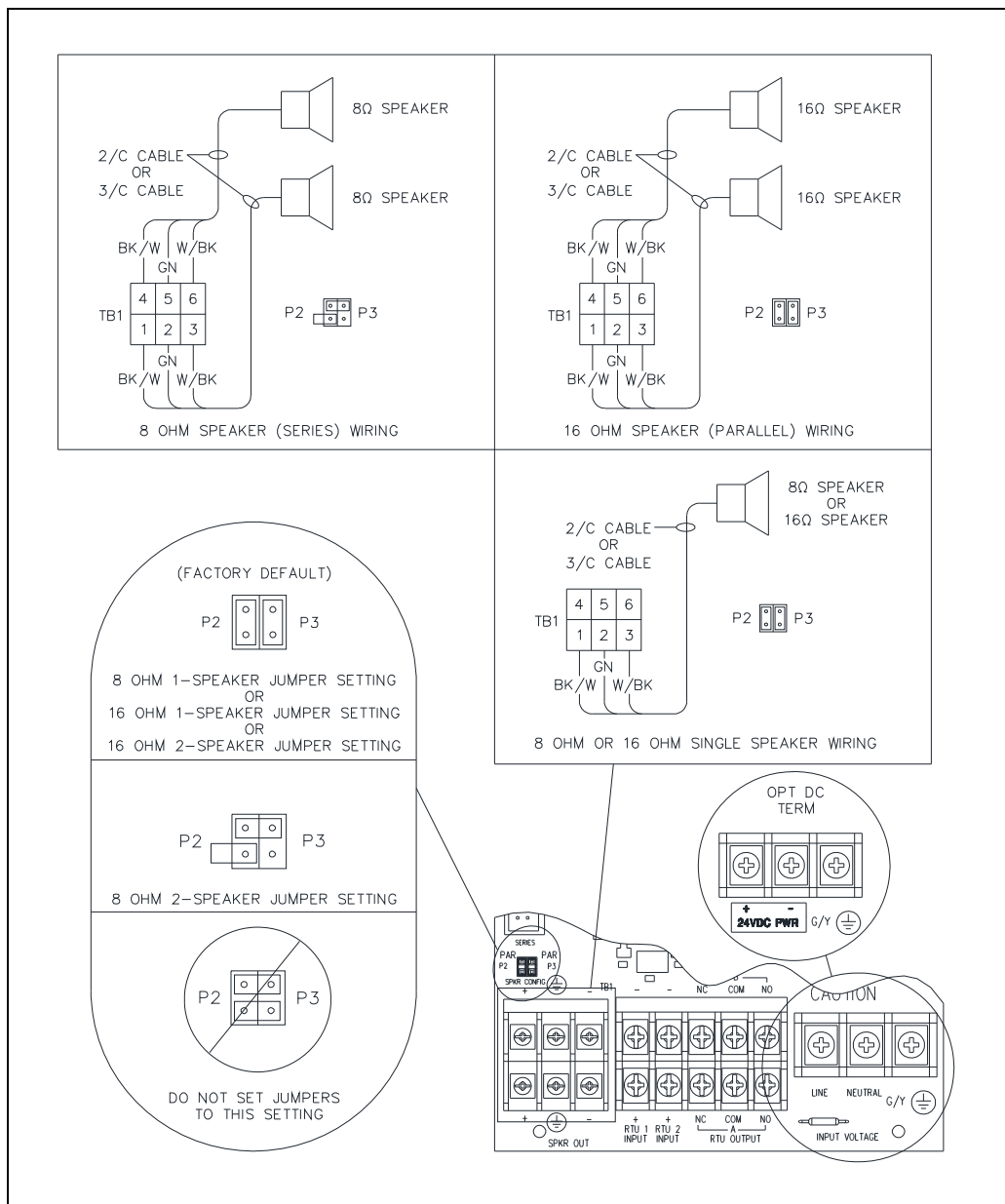

Figure 5. 8/16-ohm Speaker Impedance Configuration and AC/DC Termination at TB3

**70-V/100-V Termination Board Option—Speaker Connections with Monitoring**

The optional 70-volt/100-volt speaker line-monitoring PCBA replaces the standard termination board and enables connection of 70-volt and/or 100-volt speakers to the SP2 station. Terminate the station’s speaker loop(s) to terminal block TB1. Wire all speakers in parallel. Monitor one speaker loop for faults by terminating the return cable to the LINE SPRVN terminals at terminal block TB2 (see Figure 6 and Table 2).

1. Pull the 70-volt and/or 100-volt speaker cable(s) into the enclosure.
2. Install spade lugs on the wires.
3. Connect 100-volt speakers between the 100V and COM terminals on TB1. Connect 70-volt speakers between the 70V and COM terminals on TB1.

Two sets of terminals exist for the 70-volt and 100-volt speaker loops, providing termination for additional speaker loops.

**NOTE:** The station can only monitor one speaker loop.

4. For speaker line supervision, connect the speaker return wires to the LINE SPRVN + and – terminals at TB2 (see Table 4).
5. Move jumper P2 to pins 2–3 to enable ground fault monitoring
6. Torque the terminal block screws to 8–10 in·lb (0.90–1.13 N·m).

**NOTE:** The combined wattage (tap settings) for all speakers must never exceed the amplifier power rating (24 W).

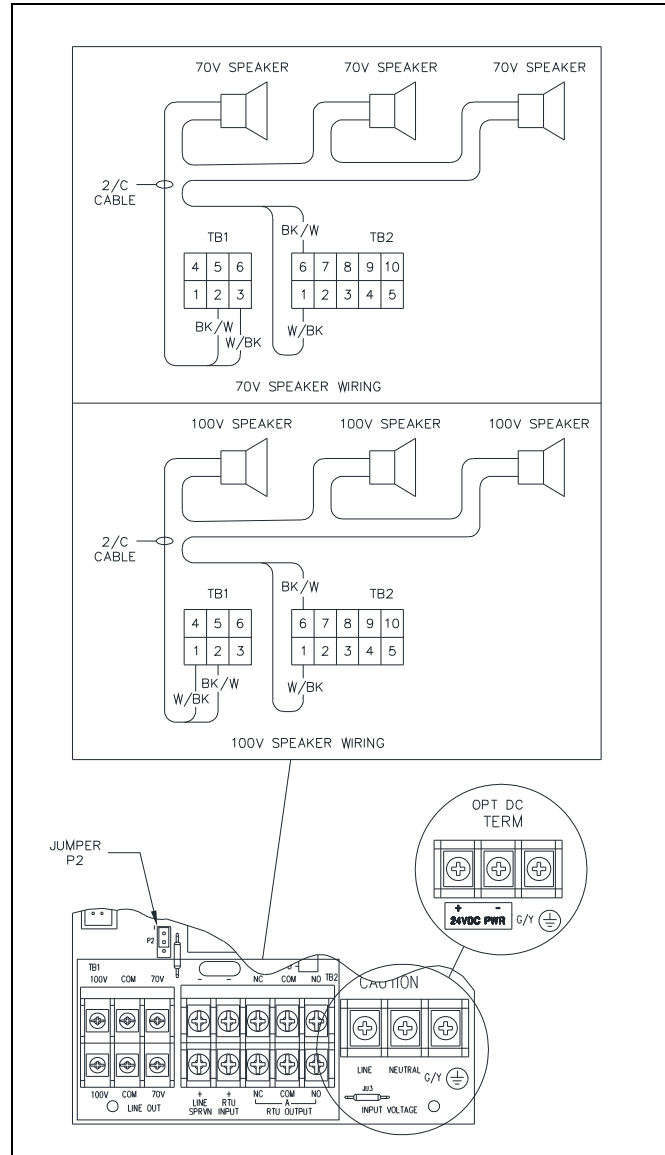

Figure 6. 70-V/100-V Termination PCBA

Table 2. 70 V/100 V Speaker Connections—TB1

Pin	Label	Description
TB1-1	100V	100 V Parallel Speakers—Output
TB1-2	COM	Common
TB1-3	70V	70 V Parallel Speakers—Output
TB1-4	100V	100 V Parallel Speakers—Output
TB1-5	COM	Common
TB1-6	70V	70 V Parallel Speakers—Output

**RTU Inputs**

The termination PCBA contains two auxiliary RTU inputs. The optional 70V/100V termination board provides for speaker line monitoring and has just one auxiliary RTU input. These inputs are terminated at terminal block TB2 (see Figure 5 or Figure 6).

1. Pull the RTU input cable(s) into the rear enclosure.
2. Install spade lugs on the wires.
3. Connect the RTU input wires to terminal block TB2 (see Table 3 or Table 4).
4. Torque the terminal block screws to 8–10 in·lb (0.90–1.13 N·m).
5. Install end-of-line resistors as shown to enable RTU input-cable monitoring (see Figure 7):

Table 3. Standard Termination Board  
RTU Input Termination—TB2

Pin	Label	Function
TB2-1	+ RTU 1 INPUT	RTU Input 1 +
TB2-2	-	RTU Input 1 -
TB2-3	+ RTU 2 INPUT	RTU Input 2 +
TB2-4	-	RTU Input 2 -

Table 4. 70V/100V Termination Board  
Speaker Line Monitoring and RTU Input  
Termination—TB2

Pin	Label	Function
TB2-1	+ LINE SPRVN	70 V/100 V Supervision +
TB2-2	-	70 V/100 V Supervision -
TB2-3	+ RTU INPUT	RTU Input +
TB2-4	-	RTU Input -

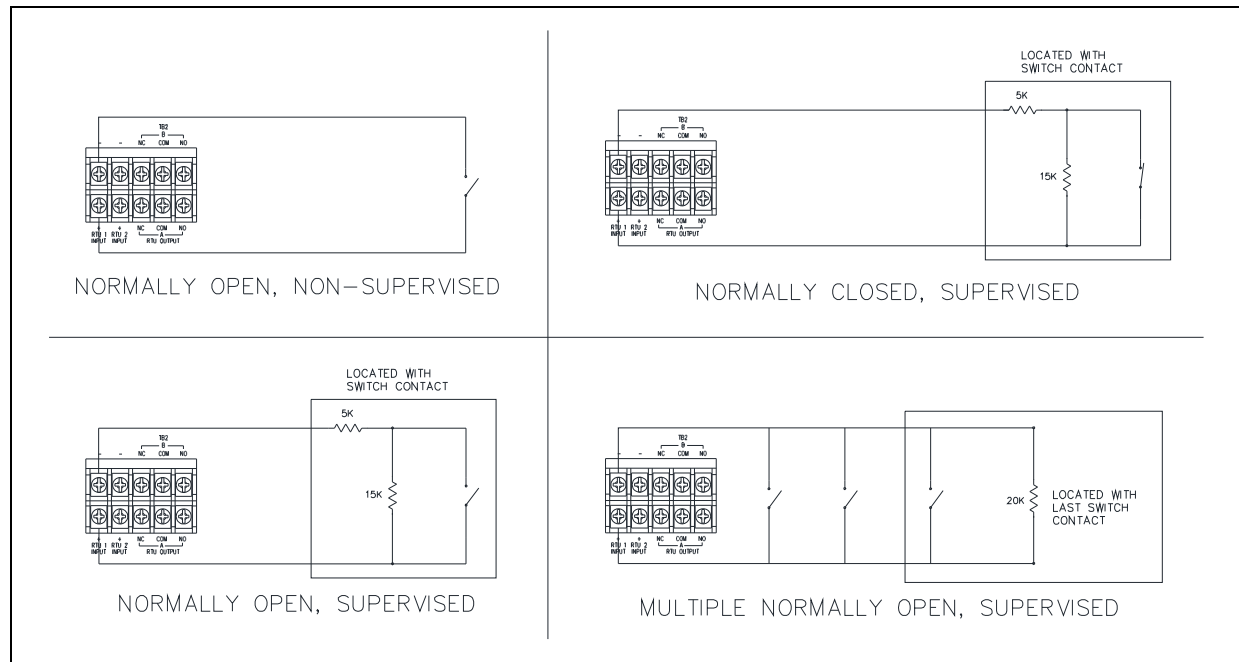

Figure 7. RTU Input Wiring Configurations for Cable Monitoring

**RTU Output**

Two form C contacts are provided to power a beacon (see Figure 8). Terminate the outputs at terminal block TB2 (see Figure 4, Figure 5, and Figure 6). Configure the outputs for dry contact use by removing jumpers JU1 and JU2.

**⚠ WARNING ⚠** —Line voltage is present at the NO contact until JU1 and JU2 are removed.

1. Pull the RTU output cable into the enclosure.
2. Install spade lugs on the wires.
3. Connect the RTU output wires to terminal block TB2 (see Figure 8).
4. Torque the terminal block screws to 8–10 in·lb (0.90–1.13 N·m).

For beacon cable monitoring:

5. Install a 20-kilohm 10-watt resistor across the terminals of the beacon (see Figure 8).
6. Install jumpers at terminal block TB2 (see Figure 8) to enable cable monitoring.

**NOTE:** Using an RTU input to monitor the beacon wiring makes it unavailable for other functions.

Table 5. RTU Output Contacts—TB2

Pin	Label	Description
TB2-5	NC A	Normally Closed Output A
TB2-6	NC B	Normally Closed Output B
TB2-7	COM A	Common Output A
TB2-8	COM B	Common Output B
TB2-9	NO A	Normally Open Output A
TB2-10	NO B	Normally Open Output B

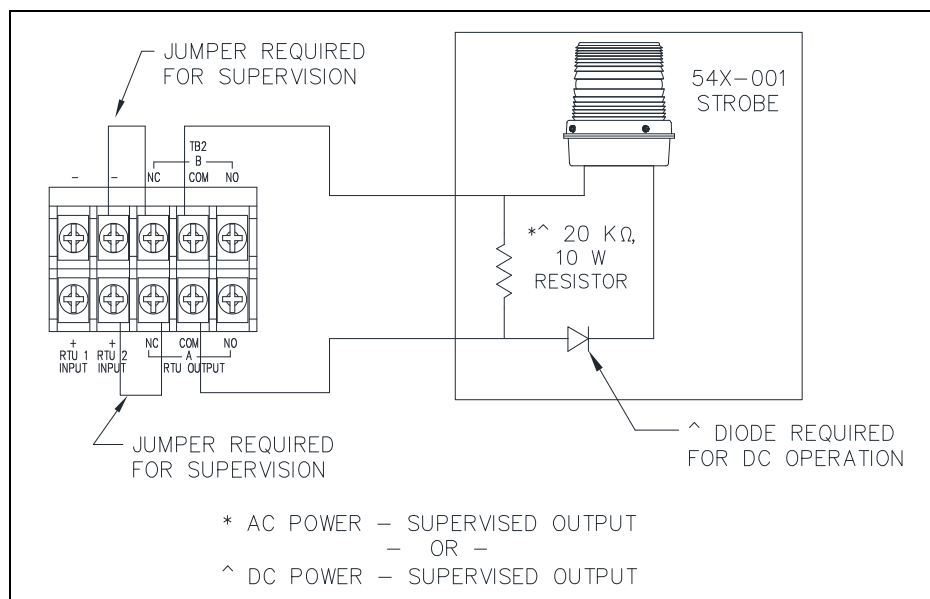

Figure 8. Supervised Output Wiring—TB2

## Power

The ac or optional dc power supply is mounted in the Zone 2/22 enclosure. Connect the local ac or dc power source to terminal block TB3 (see [Figure 4](#), [Figure 5](#), and [Figure 6](#)):

1. Pull the cable from the power source into the rear enclosure.
2. Install spade lugs on the wires.
3. Connect the conductors from the ac (see [Table 6](#)) or dc (see [Table 7](#)) power source to the appropriate terminals at terminal block TB3.
4. Torque the terminal block screws to 8–10 in·lb (0.90–1.13 N·m).

Table 6. AC Power—TB3

Pin	Label	Description
TB3-1	LINE	Positive
TB3-2	NEUTRAL	Negative
TB3-3	⊥	Earth ground

Table 7. DC Power—TB3

Pin	Label	Description
TB3-1	+	Positive
TB3-2	-	Negative
TB3-3		No Connection

## Main PCBA—600-Ohm Audio I/O with Control

SP2 stations have a 600-ohm audio input to broadcast line level audio over the page line. The station broadcasts the 600-ohm input audio stream upon closure of a normally open dry contact input control. SP2 stations also provide a 600-ohm audio output for sending page line audio to a remote audio amplifier. A solid-state dry contact relay controls when the remote amplifier plays the audio.

1. Pull the cable for the 600-ohm audio I/O into the rear enclosure.
2. Install ferrules onto the wire ends.
3. Connect the 600-ohm audio wires to the pluggable terminal block for the 600-ohm audio I/O connection (see [Table 8](#) and [Figure 9](#)).
4. Insert the pluggable terminal block into terminal block receptacle TB1.

Table 8. 600-Ohm Audio I/O Interface Connections—TB1

Pin	Label	Description
TB1-1	IN CT1+	Input Control Positive
TB1-2	IN CT1-	Input Control Negative
TB1-3	IN AUD+	Input Audio Positive
TB1-4	IN AUD-	Input Audio Negative
TB1-5	OUT AUD+	Output Audio Positive
TB1-6	OUT AUD-	Output Audio Negative
TB1-7	OUT CT1+	Output Control Positive
TB1-8	OUT CT1-	Output Control Negative

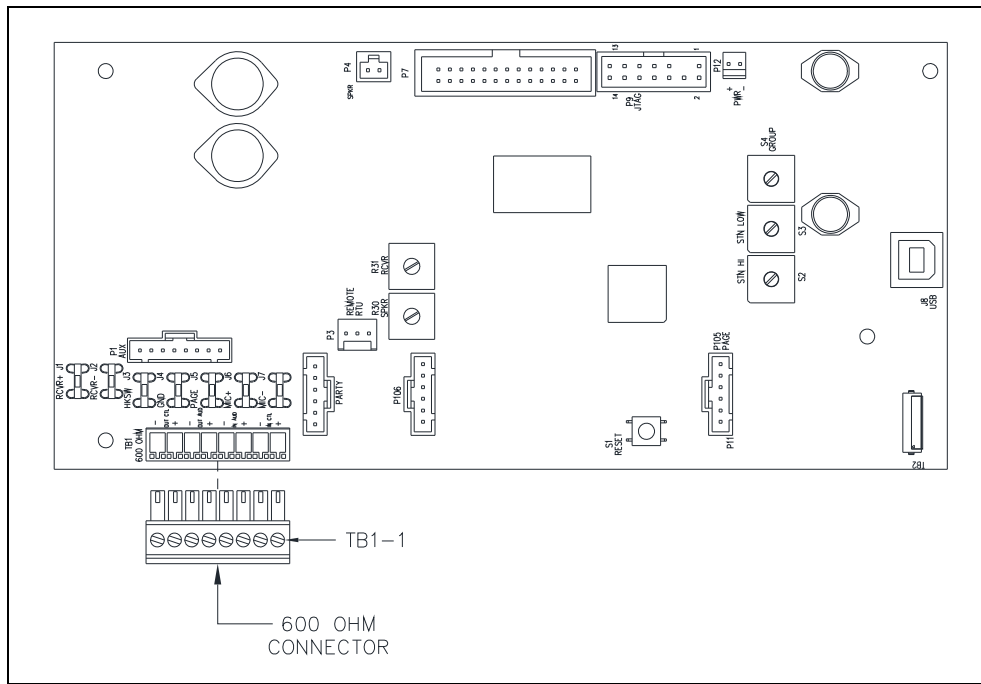

Figure 9. SP2 Main PCBA (Fiber)

### Fiber Termination Board

The fiber termination PCBA is mounted to the main PCBA (see Figure 3). Exact fiber termination is installation dependent because the fiber optic cable and SFP (Small Form-factor Pluggable) transceivers in SP2 system installations are customer supplied. Here are the basic steps for terminating the fiber optic cable to the SP2 station:

1. Insert the SFP transceiver into the SFP receptacle (see Figure 10 and Figure 11).
2. Route the terminated fiber with the appropriate connectors into the bottom rear of the station and over to the fiber termination PCBA.
3. Wrap the fiber cable around the excess fiber spool.
4. Plug the fiber connector into the SFP (see Figure 11).

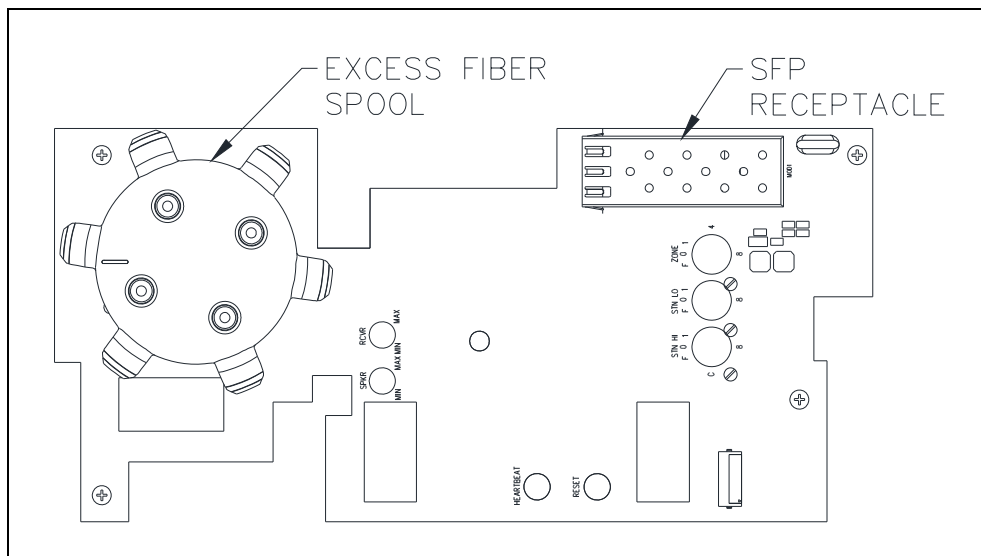

Figure 10. Fiber Termination PCBA

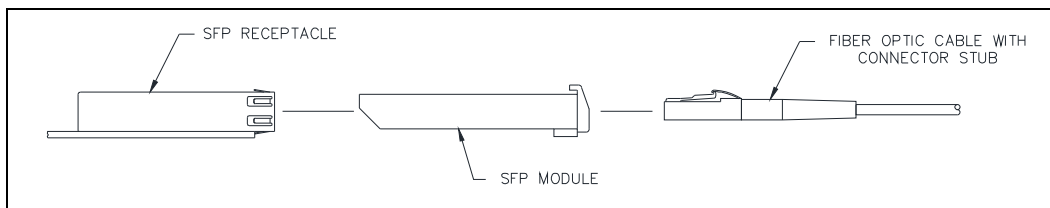

Figure 11. SFP Transceiver Insertion and Fiber Plug-in

## Settings and Adjustments

### Open the Station

Complete the following steps to open the station:

1. Remove the four screws from the front cover and turn it to the left so that the interior surfaces face out.
2. Keep the wiring and ribbon cables connected.

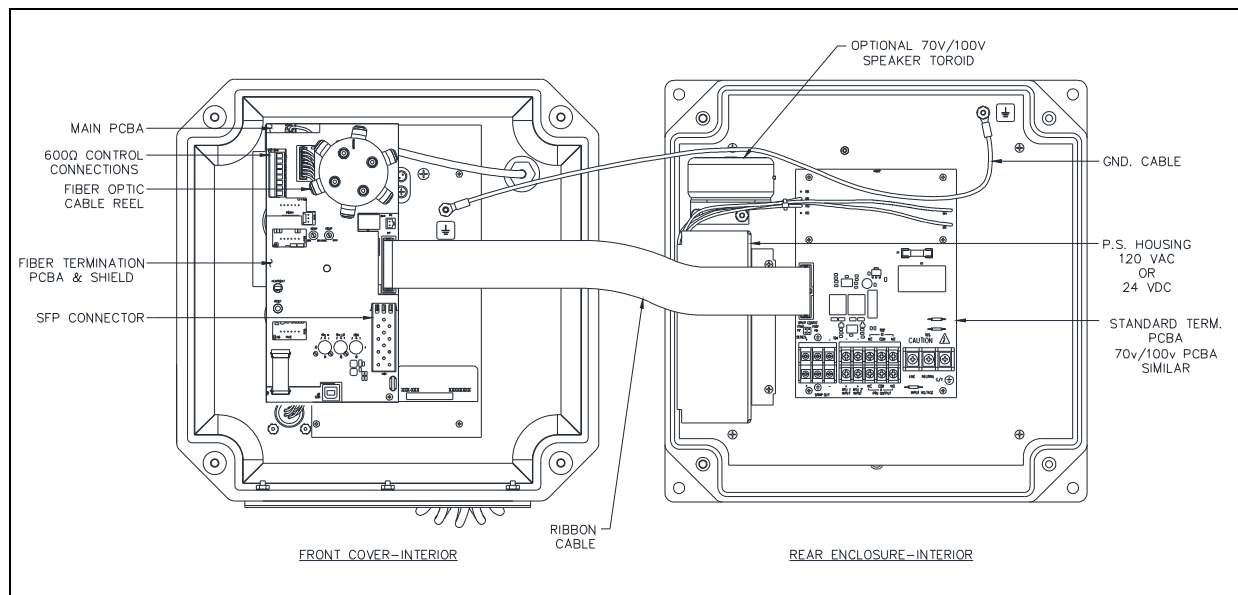

Figure 12. SP2 Zone 2/22 Fiber Weatherproof Handset/Speaker Amplifier Station Interior View and Maintenance Configuration

### Main PCBA Configuration

Refer to [Figure 13](#) for switch, jumper, and LED locations on the main PCBA.

#### Write Protect (EEPROM) Jumper

**NOTE:** Do not change this jumper in the field.

#### WDOG Enable (Watchdog) Jumper

Watchdog jumper, P11, is for software purposes only. Do not adjust this jumper in the field. The default setting for this jumper is shorted.

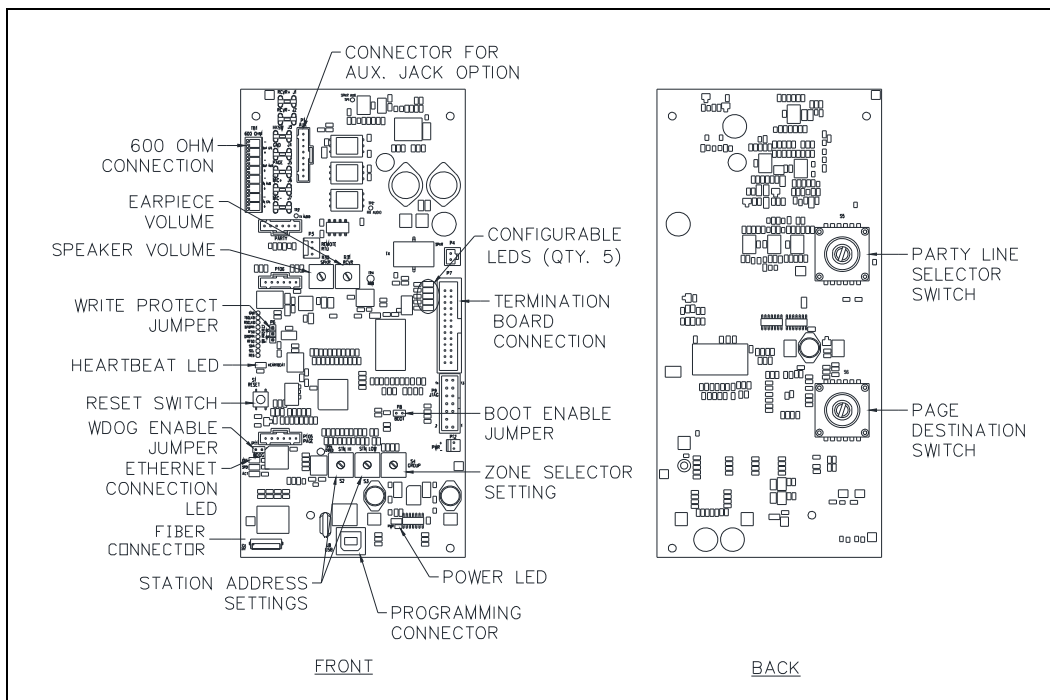

Figure 13. Main PCBA (Front and Rear Views)

### Boot Enable Jumper

Jumper P8 – BOOT, is for development purposes. Do not adjust this jumper in the field. The default setting for this jumper is open.

### Reset Switch

Reset switch S1 reboots the station to its initial state. All configuration settings remain programmed.

### Speaker and 600-ohm Audio Output Volume

The speaker volume potentiometer, R36, adjusts the signal level to the speaker from the page line. When 600-ohm audio is also connected, R36 adjusts the volume for both. Use the CLI (Command Line Interface) to configure the output level when using 600-ohm audio without external speakers. The default setting is 4 watts from an 8-ohm speaker and 2 watts from a 16-ohm speaker.

**⚠ WARNING ⚠** —Maximum output power may exceed rated speaker wattage resulting in speaker damage.

To adjust the speaker or speaker and 600-ohm output volume:

1. Turn the SPKR speaker volume potentiometer R36 fully counterclockwise.  
The speaker emits an audible test-tone.
2. Slowly turn R36 clockwise to obtain the desired output volume.  
The test-tone ceases three seconds after making no adjustments.

This setting can also be configured via USB or Ethernet connection using the CLI.

**NOTE:** Configuring this setting with the SP2 Console in a mutually provisioned system overrides this setting on the station. See the SP2 Configuration Guide, Pub. 42004-784 (see the Reference Documentation section).



## Receiver Volume

Use the receiver volume potentiometer, R37, to adjust the handset volume:

1. Remove the handset from the cradle.
2. Turn the receiver volume potentiometer, R37, fully counterclockwise.

The receiver emits an audible test-tone.

3. Slowly turn R37 clockwise to obtain the desired output volume.

The test-tone ceases three seconds after making no adjustments.

This setting can also be configured via USB or Ethernet connection using the CLI.

**NOTE:** Configuring this setting with the SP2 Console in a mutually provisioned system overrides this setting on the station. See the SP2 Configuration Guide, Pub. 42004-784 (see the [Reference Documentation](#) section).

## Group and Station Number Selector Switches

One *group-number* and two *station-number* hex-selector switches configure SP2 stations for *mutual provisioning* (see [Figure 13](#)). Each hex switch has a small arrow that indicates the current setting.

1. Adjust the position of the group-number selector switch to the desired group [0-F].
2. Adjust the two station-number switches to assign the station number [00–FF].

**NOTE:** Do NOT assign the same group/station number to more than one station.

Configure at least one SP2 station as a *master station* to utilize mutual provisioning in an SP2 system. Master stations must be assigned addresses [0.01], [0.02], or [0.03] using the selector switches. Master station(s) store the configuration for all SP2 stations on the network. Each SP2 station retrieves the mutual provisioning configuration from the master station as it powers up. See Pub. 42004-784, SP2 Configuration Guide, for detailed information on configuring SP2 stations and SP2 system mutual provisioning (see the [Reference Documentation](#) section).

## Main PCBA Indicators

### Power LED

The PWR LED illuminates when power is applied to the station indicating the main board power supply is operational (see [Figure 13](#)).

### Heartbeat LED

The HEARTBEAT LED flashes when network communication is established; indicating the microprocessor is operational (see [Figure 13](#)).

### Ethernet Connection LEDs

Three Ethernet connection LEDs are located on the main PCBA; link (LNK), link speed (SPD), and activity (ACT). The LNK LED is blue, the SPD LED is green, and the ACT LED is yellow. The LNK and SPD LEDs indicate an active 100 Mbps Ethernet link when **off**. The activity LED, ACT, blinks yellow to indicate Ethernet data activity (see [Figure 13](#)).

## Five Generic LEDs

Configure the five LEDs (see [Figure 13](#)) through firmware. Information for configuring these LED indicators is in the SP2 Configuration Guide, Pub. 42004-784 (see the [Reference Documentation](#) section).

## Front Cover Installation

After all adjustments are complete:

1. Place the front cover onto the rear enclosure.  
Do not to pinch any cables.
2. Secure the front cover using the four screws and washers provided.
3. Torque the screws to 50 in·lb (5.65 N·m).

## Programming

SP2 stations are factory configured to provide basic page/party functions upon power-up. Configure stations for custom operation and/or larger system designs using the CLI or SP2 Console application. Refer to Publication 42004-784, SP2 Configuration Guide (see the [Reference Documentation](#) section).

## Operation

### Standard Handset Paging

Complete the following steps to make a page announcement from an SP2 handset station:

1. Lift the handset from the cradle.
2. *If requesting conversation:* rotate the party-line selector switch (if equipped) to select an unoccupied party line.
3. Press and hold the handset pressbar (not necessary when using the optional ALL-CALL button).
4. After hearing the short *preannouncement* tone (if configured), speak directly into the microphone to broadcast the page/announcement.

**NOTE:** SP2 stations incorporate a noise-canceling microphone to reduce transmitted ambient noise. This requires the user to place the microphone as close as possible to their mouth.

5. *If requesting conversation:*
  1. Designate the party line selected in Step 2.
  2. Release the handset pressbar.
  3. Wait for the designated individual(s) to respond.

Full-duplex communication takes place on the party line without broadcasting over the system's speakers.

6. Replace the handset in the cradle.

## Party Line Communication

To respond to a page:

1. Turn the selector switch on any SP2 station in the system to the requested party line.
2. Pick up the station handset.

Full-duplex communication takes place on the party line without broadcasting over the system's speakers.

**NOTE:** SP2 stations incorporate a noise-canceling microphone to reduce transmitted ambient noise. This requires the user to place the microphone as close as possible to their mouth.

3. Return the handset to the cradle following the party line conversation.

The system speakers do not broadcast party line conversations. Other individuals can join the conversation at any time by picking up a handset and rotating the party-line selector switch to the party line in use.

## All-Call Button Use

Use the ALL-CALL button to page an alternate destination that is programmed for the station (see Figure 14). The ALL-CALL option must be software configured for the SP2 station. To initiate a page using the ALL-CALL feature:

1. Lift the handset from the cradle.
2. *If requesting party line conversation:* rotate the party-line selector switch to an unoccupied party line.
3. Press and hold the ALL-CALL button.

The ALL-CALL button eliminates the need to press the handset or headset (if equipped) pressbar.

4. After hearing the short *preannouncement* tone (if configured), speak directly into the microphone to broadcast the page/announcement.

**NOTE:** SP2 stations incorporate a noise-canceling microphone to reduce transmitted ambient noise. This requires the user to place the microphone as close as possible to their mouth.

5. Release the ALL-CALL button and wait for a response on the party line (if requested).
6. Return the handset to the cradle when finished.

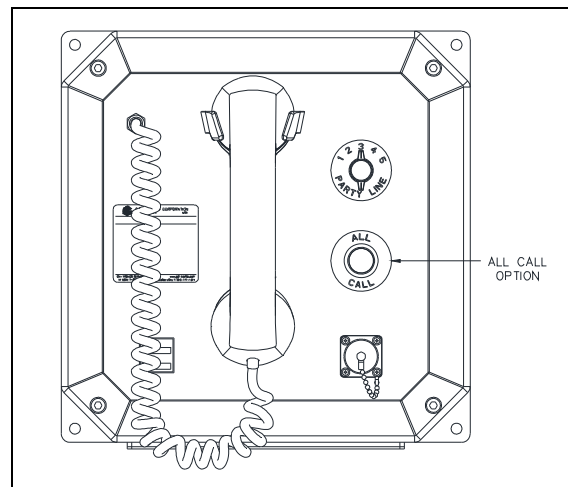

Figure 14. All-Call Option Location

## Alternate-Page Destination Switch Use

Use the ALT-PAGE selector switch to page one of five alternate destinations programmed for the station (see [Figure 15](#)). Alternate page destinations must be software configured for SP2 stations. To initiate a page using the ALT-PAGE selector switch:

1. Lift the handset from the cradle.
2. *If requesting conversation:* rotate the party-line selector switch to an unoccupied party line.
3. Select the desired page destination using the ALT-PAGE selector switch.
4. Press and hold the handset pressbar.
5. After hearing the short *preannouncement* tone (if configured), speak directly into the microphone to broadcast the page/announcement.

**NOTE:** SP2 stations incorporate a noise-canceling microphone to reduce transmitted ambient noise. This requires the user to place the microphone as close as possible to their mouth.

6. Release the handset pressbar.
7. Return the handset to the cradle or wait for a response on the party line (if requested).

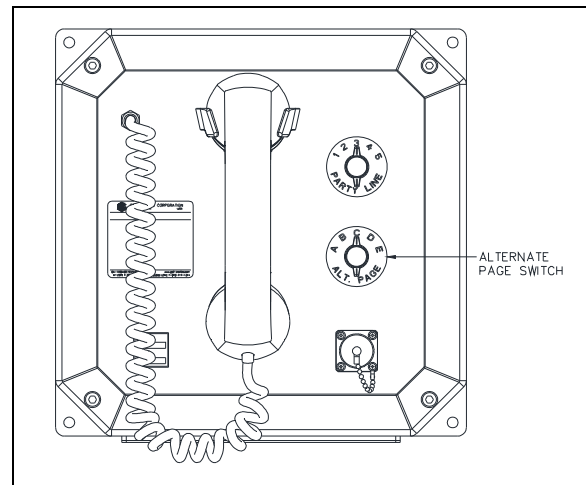

Figure 15. Alternate Page Switch Location

## Headset Use

Initiate a call with the optional headset feature as follows:

1. Attach the headset assembly to the auxiliary jack on the station (see [Figure 14](#) or [Figure 15](#)).
2. *If requesting conversation:* rotate the party-line selector switch (if equipped) to an unoccupied party line.
3. Rotate the ALT-PAGE selector switch (if available) or press the ALL-CALL button (if available) to select an alternate destination for the page/announcement.
4. Press and hold the headset pressbar (not necessary when using the optional ALL-CALL button).
5. After hearing the short *preannouncement* tone (if configured), speak directly into the microphone to broadcast the page/announcement.
6. Release the headset pressbar.
7. Wait for a response on the party line (if requested).

**NOTE:** For stations with an auxiliary jack, the Model 10401-201 Headset and Model 10416-103 Extension Cord allow the user to be hands-free and mobile while maintaining communication. Connecting the headset disables the handset microphone.

## Troubleshooting

The following table provides aid for qualified service personnel in troubleshooting problems with an SP2 station:

Problem	Solution
station not functional	<ul style="list-style-type: none"> <li>• check wiring and cable terminations</li> <li>• check power supply voltage at TB3 on termination PCBA</li> <li>• PWR LED on main PCBA not illuminated</li> <li>• HEARTBEAT LED blinking once per second for normal operation</li> </ul>
network communication not functional	<ul style="list-style-type: none"> <li>• verify LNK LED on main PCBA is off</li> <li>• verify SPD LED on main PCBA is off</li> <li>• verify IP connection settings using telnet</li> <li>• ping the station's IP address from an admin PC</li> <li>• verify network switch settings for IGMP snooping and multicast filtering</li> </ul>
handset receiver audio too high/low	<ul style="list-style-type: none"> <li>• adjust the <u>receiver volume</u></li> <li>• check potentiometer R37 setting</li> <li>• check handset connections</li> <li>• check cable terminations between the termination and main PCBAs</li> <li>• check hookswitch operation</li> <li>• replace handset</li> </ul>
speaker volume too high/low	<ul style="list-style-type: none"> <li>• adjust the <u>speaker and 600-ohm audio output volume</u></li> <li>• check potentiometer R36 setting</li> <li>• P2 and P3 termination PCBA jumper positions incorrect (see <u>Figure 5</u>)</li> <li>• check speaker wiring at terminal block TB1</li> <li>• replace the speaker or driver</li> </ul>
RTU output not functional	<ul style="list-style-type: none"> <li>• verify no monitored output faults exist</li> <li>• check fuse F1 on the termination PCBA</li> <li>• check connected device operation</li> </ul>
RTU input not functional	<ul style="list-style-type: none"> <li>• verify no monitored input faults exist</li> <li>• check the <u>RTU Inputs</u> at terminal block TB2</li> <li>• check connected device operation</li> </ul>

## Service and Spare Parts

If the equipment requires service or spare parts, contact your Regional Service Center for assistance. If service is required, a return authorization number (RA#) will be issued. Equipment should be shipped prepaid to GAI-Tronics with a return authorization number and a purchase order number. If the equipment is under warranty, repairs or a replacement will be made in accordance with GAI-Tronics' warranty policy. Please include a written explanation of all defects to assist our technicians in their troubleshooting efforts. Call 800-492-1212 inside the USA or 610-777-1374 outside the USA for help with identifying the Regional Service Center closest to you.

## Reference Documentation

GAI-Tronics' product documentation is located on the GAI-Tronics website at <https://www.gai-tronics.com>.

SP2 Configuration Guide ..... 42004-784

## Specifications

### Power

#### AC Input

Input voltage ..... 120/230 V ac (nominal), 50/60 Hz

Power factor @ nominal 120 V ac ..... 0.5

#### DC Input

Input voltage ..... 24 V dc +/-20%

<b>Power Consumed (8-ohm load)</b>	<b>120 V AC</b>	<b>230 V AC</b>	<b>24 V DC</b>
Idle	80 mA/6.6 VA	50 mA/12 VA	165 mA/4.0 W
4-watt output (default setting)	150 mA/18 VA	110 mA/25 VA	460 mA/11.0 W
30-watt output	550 mA/65 VA	350 mA/80 VA	1.95 A/46.8 W
<b>Maximum Current Consumed (8-ohm load)</b>	<b>108 V AC</b>	<b>253 V AC</b>	<b>19.2 V DC</b>
30-watt output	600 mA/65 VA	370 mA/77 VA	2.44 A/46.8 W

Current/Power requirements (+/-10%)

### Ethernet

Cable ..... fiber optic cable (customer supplied)

Fiber Optic Transceiver ..... 100 Mbps SFP (customer supplied)

Supply Voltage ..... 3.3 V dc

Supply Current ..... 300 mA

Power Dissipation ..... 1 W

Connection Speed ..... 100 Mbps

Maximum Stations ..... 4096

**RTU**

**Output Control**

Maximum load current:

Output 1A (unfused) .....	8.0 A
Output 1B (fused) .....	1.6 A
Maximum in-rush current .....	15 A
Maximum voltage .....	250 V ac

**Input Control**

Switch type.....	NO or NC dry contacts
End-of-line termination.....	20 k $\Omega$ , or 15 k $\Omega$ + 5.1 k $\Omega$
Cable resistance .....	100 $\Omega$ maximum loop resistance
Contact closure resistance.....	1 k $\Omega$ maximum
Open fault detection.....	>65 k $\Omega$
Short fault detection.....	<200 $\Omega$

**Audio**

**Handset**

Microphone.....	dynamic, noise-canceling
Receiver .....	dynamic, hearing aid compatible
Cord .....	retractile, 6-foot extended, PVC
Material.....	ABS

**Handset Amplifier**

Frequency response.....	250–3,000 Hz, +0/–3 dB ref. to 1 kHz
Distortion .....	<1.5% THD @ 1 kHz
Receiver level.....	200 mV nominal, adjustable 100–350 mV

**Headset Earpiece**

Level .....	100 mV nominal, adjustable 50–200 mV
-------------	--------------------------------------

**Speaker Amplifier**

Maximum output:

8-ohm speaker*.....	30 W into 8- $\Omega$ load with –6 dBFs data signal adjustable to 30 W; default: 4 W @ 8 $\Omega$
16-ohm speaker.....	15 W into 16- $\Omega$ load with –6 dBFs data signal adjustable to 15 W; default: 2 W @ 16 $\Omega$
Frequency response.....	250–3,000 Hz, +0/–3 dB ref. to 1 kHz
Distortion .....	<1% THD @ 1 kHz to 24 W <3% THD @ 1 kHz to 30 W

**70V/100V Speaker Output**

Maximum output.....	24 W
Nominal output voltage.....	70.7 V or 100 V

**600-ohm Audio Input**

Audio Level .....	1 V <sub>RMS</sub> maximum
Control type .....	NO dry contact
Control cable resistance .....	1 k $\Omega$ maximum loop resistance





# Warranty

---

Equipment. GAI-Tronics warrants for a period of one (1) year from the date of shipment, that any GAI-Tronics equipment supplied hereunder shall be free of defects in material and workmanship, shall comply with the then-current product specifications and product literature, and if applicable, shall be fit for the purpose specified in the agreed upon quotation or proposal document. If (a) Seller's goods prove to be defective in workmanship and/or material under normal and proper usage, or unfit for the purpose specified and agreed upon, and (b) Buyer's claim is made within the warranty period set forth above, Buyer may return such goods to GAI-Tronics nearest depot repair facility, freight prepaid, at which time they will be repaired or replaced, at Seller's option, without charge to Buyer. Repair or replacement shall be Buyer's sole and exclusive remedy. The warranty period on any repaired or replacement equipment shall be the greater of the ninety (90) day repair warranty or one (1) year from the date the original equipment was shipped. In no event shall GAI-Tronics warranty obligations with respect to equipment exceed 100% of the total cost of the equipment supplied hereunder. Buyer may also be entitled to the manufacturer's warranty on any third-party goods supplied by GAI-Tronics hereunder. The applicability of any such third-party warranty will be determined by GAI-Tronics.

Services. Any services GAI-Tronics provides hereunder, whether directly or through subcontractors, shall be performed in accordance with the standard of care with which such services are normally provided in the industry. If the services fail to meet the applicable industry standard, GAI-Tronics will re-perform such services at no cost to buyer to correct said deficiency to Company's satisfaction provided any and all issues are identified prior to the demobilization of the Contractor's personnel from the work site. Re-performance of services shall be Buyer's sole and exclusive remedy, and in no event shall GAI-Tronics warranty obligations with respect to services exceed 100% of the total cost of the services provided hereunder.

Warranty Periods. Every claim by Buyer alleging a defect in the goods and/or services provided hereunder shall be deemed waived unless such claim is made in writing within the applicable warranty periods as set forth above. Provided, however, that if the defect complained of is latent and not discoverable within the above warranty periods, every claim arising on account of such latent defect shall be deemed waived unless it is made in writing within a reasonable time after such latent defect is or should have been discovered by Buyer.

Limitations / Exclusions. The warranties herein shall not apply to, and GAI-Tronics shall not be responsible for, any damage to the goods or failure of the services supplied hereunder, to the extent caused by Buyer's neglect, failure to follow operational and maintenance procedures provided with the equipment, or the use of technicians not specifically authorized by GAI-Tronics to maintain or service the equipment. **THE WARRANTIES AND REMEDIES CONTAINED HEREIN ARE IN LIEU OF AND EXCLUDE ALL OTHER WARRANTIES AND REMEDIES, WHETHER EXPRESS OR IMPLIED BY OPERATION OF LAW OR OTHERWISE, INCLUDING ANY WARRANTIES OF MERCHANTABILITY OR FITNESS FOR A PARTICULAR PURPOSE.**

## Return Policy

---

If the equipment requires service, contact your Regional Service Center for a return authorization number (RA#). Equipment should be shipped prepaid to GAI-Tronics with a return authorization number and a purchase order number. If the equipment is under warranty, repairs or a replacement will be made in accordance with the warranty policy set forth above. Please include a written explanation of all defects to assist our technicians in their troubleshooting efforts.

Call 800-492-1212 (inside the USA) or 610-777-1374 (outside the USA) for help identifying the Regional Service Center closest to you.