



GAI-TRONICS® CORPORATION
A HUBBELL COMPANY

Model MI05-101 Merge/Isolate Cabinet

Confidentiality Notice

This manual is provided solely as an installation, operation, and maintenance guide, which contains sensitive business and technical information, that is confidential and proprietary to GAI-Tronics. GAI-Tronics retains all intellectual property and other rights in or to the information contained herein, and such information may only be used in connection with the operation of your GAI-Tronics product or system. This manual may not be disclosed in any form, in whole or in part, directly or indirectly, to any third party.

General Information

The Model MI05-101 Merge/Isolate (M/I) Cabinet is designed to operate in a multi-zone Page/Party® communication system. The cabinet can selectively merge and isolate up to five zones that normally operate independently. Each zone's Page/Party® communication cable, which contains five party lines and one page line, is connected to the M/I cabinet.

When merged, the zones share a page line and a party line. For example, two zones can be merged while the remaining zones in the system are isolated and continue to operate independently. Voice pages generated from handset stations within one zone can be heard in the other zone when the two zones are merged. The actual merging and isolating of the zones is controlled by a GAI-Tronics Model MS05-101 Master Desktop Station (or equivalent), which works in conjunction with the cabinet. The cabinet supports a maximum of eight master stations.

In addition to merging and isolating the system zones, the cabinet can also perform other functions when equipped with the following accessories, all of which can be added at any time:

- *MS05-101 Master Desktop Station or equivalent*—a Page/Party® handset station that also provides the capability for an operator to direct the merging and isolating of zones and manual initiation of alarms when used in conjunction with the M/I cabinet.
- *10959-201 Audio Messenger Interface (AMI)*—a microprocessor-controlled tone/speech generator that produces alarm tones (with speech messages) to alert people of emergency conditions.
- *10959-203 Audio Messenger Interface with Telephone Interface*—provides the same features and functions as the Model 10959-201 described above but adds telephone interface circuits to allow telephone users the ability to make voice pages and to communicate with handset stations in the Page/Party® system on party line five.
- *GTK99019 Audio Interface*—allows other audio sources, such as two-way radio equipment, to be connected to the system.
- *Alarm Activation Switches*—allows external switch or relay contacts to activate the AMI. (The AMI must be connected).
- *GTD99001-VLCX Volume Level Control Transmitter*—provides activation of remote devices using existing system cable. This kit can be used to activate strobe lights via other devices or mute and un-mute speakers at Page/Party® stations.

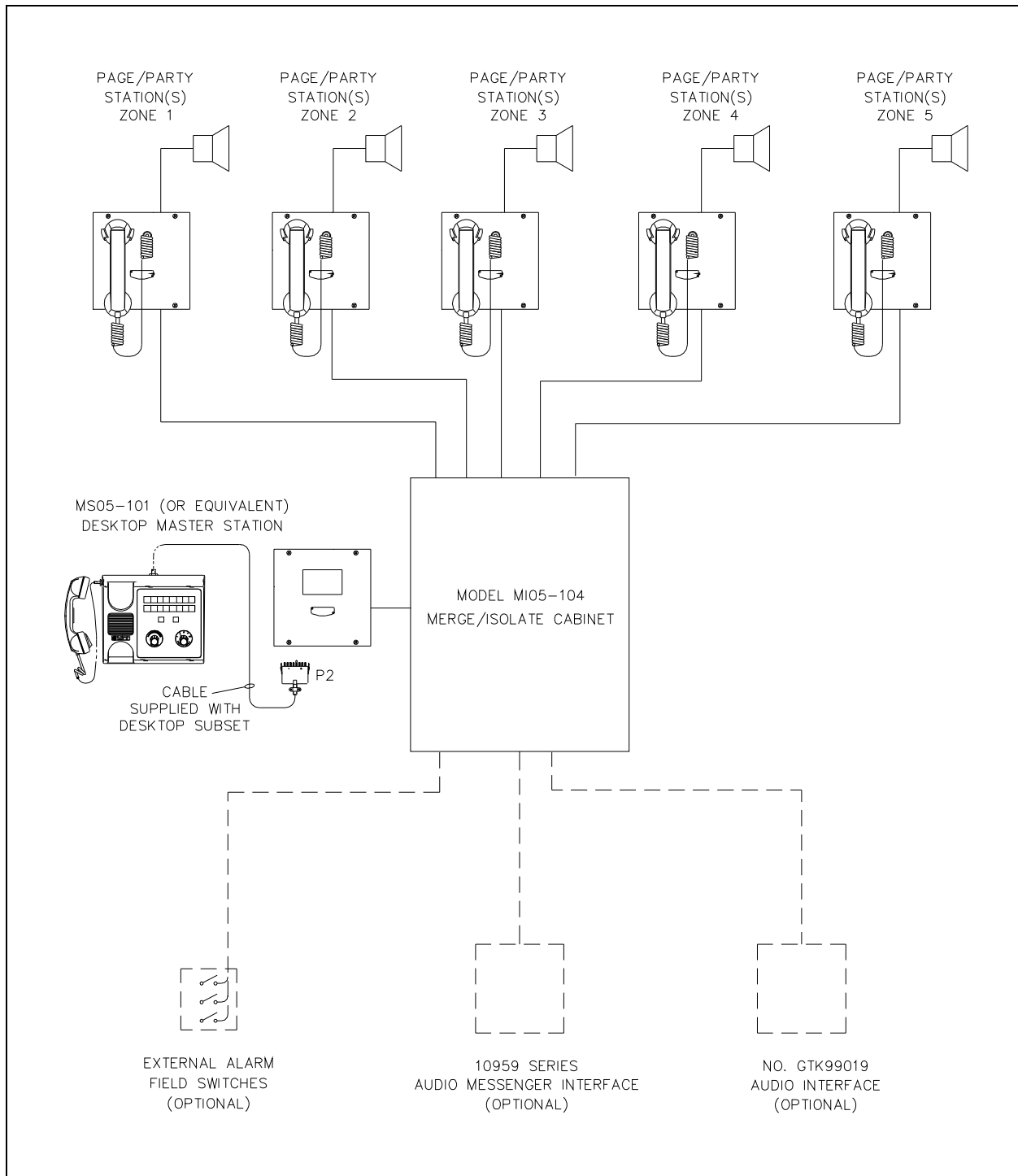

Figure 1. Typical Block Diagram

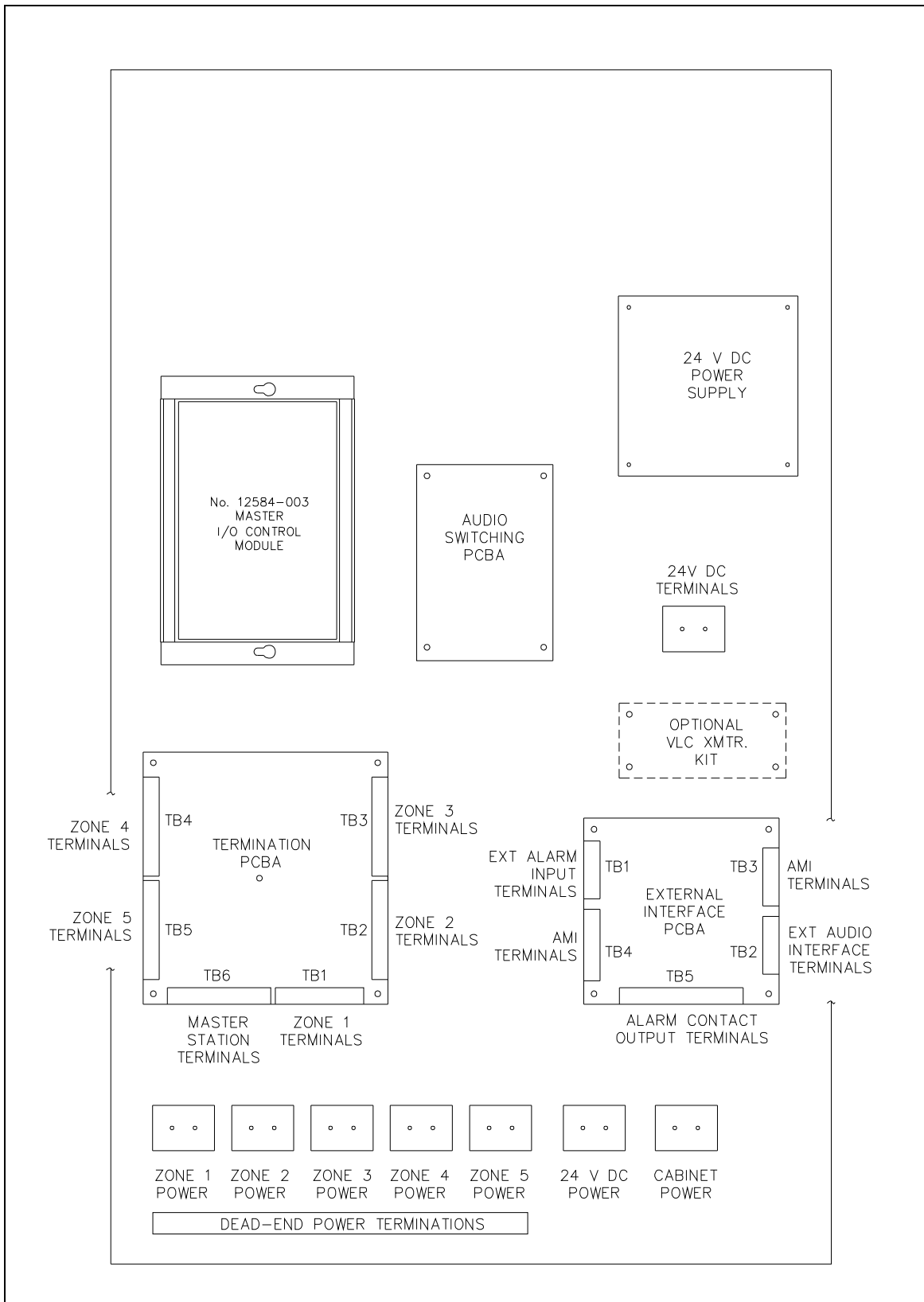

Figure 2. Merge/Isolate Cabinet Component Locations

Installation

NOTE: All system line balancing is located in this cabinet; therefore, any existing page and party line balance assemblies must be removed when the Model MI05-101 Merge/Isolate Cabinet is installed.

Cabinet Mounting

Mount the M/I cabinet in a secure area that is protected from adverse environmental conditions such as rain, heavy dust, excess moisture, and temperature extremes. For optimum performance, mount the cabinet no farther than one mile from the farthest Page/Party[®] station. Mount the enclosure to the wall by installing four mounting bolts through the predrilled holes in the rear of the enclosure.

Field Wiring

All terminations are made to the termination PCBA using modular terminal block connections. Each connection is labeled inside the M/I cabinet.

Connecting Field Stations

1. Locate the termination PCBA in the lower left corner of the cabinet. See Figure 2.
2. Connect all page and party lines from each of the zones to the appropriate terminals on the termination PCBA. GAI-Tronics 60038 Series single party cable or 60029 Series multi-party cable is recommended.

TB1	Zone 1 field stations
TB2	Zone 2 field stations
TB3	Zone 3 field stations
TB4	Zone 4 field stations
TB5	Zone 5 field stations

3. Make the following connections:

Table 1. Field Station to M/I Cabinet Connections

Terminals		Function
Field Stations	Merge/Isolate Cabinet	
TB1-8 and TB1-9	TB _x -1 and TB _x -2	Page
TB2-12 and TB2-13	TB _x -3 and TB _x -4	Party Line 1
TB2-14 and TB2-15	TB _x -5 and TB _x -6	Party Line 2
TB2-16 and TB2-17	TB _x -7 and TB _x -8	Party Line 3
TB2-18 and TB2-19	TB _x -9 and TB _x -10	Party Line 4
TB2-20 and TB2-21	TB _x -11 and TB _x -12	Party Line 5
Refer to the manual for the custom station for terminal block numbers.	TB _x -13 and TB _x -14	Merge control

x = Applicable zone

NOTE: For systems not employing any stations equipped with the all-call or merge functions, connect the spare orange conductor from the system cable to the C2 terminal at the respective zone terminal block.

Be sure to use GAI-Tronics system cable to connect all field stations to this cabinet and terminate the spare ac power conductors to the designated zone terminal block at the bottom of the cabinet. The ac power conductors are color-coded black (L), white (N), and green/yellow (GND).

NOTE: These terminals do not provide ac power to the field stations and are provided only for the convenience in terminating the system cable power conductors.

Connecting Model MS05-101 Desktop Master Stations (or equivalent)

1. Locate the termination PCBA in the lower left corner of the cabinet. See Figure 2.
2. Connect the desktop master station to TB6 in the cabinet. The recommended cable for this connection is a nine-pair cable.
3. Make the following connections:

Table 2. Master Station to M/I Cabinet Terminations

Terminals		Function
Master Station	Merge/Isolate Cabinet	
TB3-23 and TB3-24	TB6-1 and TB6-2	RS-485 data line (+/-)
TB3-25	TB6-3	Data ground
TB1-10 and TB1-11	TB6-5 and TB6-6	Page monitor
TB1-8 and TB1-9	TB6-7 and TB6-8	Page
TB2-12 and TB2-13	TB6-9 and TB6-10	Party Line 1
TB2-14 and TB2-15	TB6-11 and TB6-12	Party Line 2
TB2-16 and TB2-17	TB6-13 and TB6-14	Party Line 3
TB2-18 and TB2-19	TB6-15 and TB6-16	Party Line 4
TB2-20 and TB2-21	TB6-17 and TB6-18	Party Line 5

Master I/O Controller Switch Settings

The master I/O controller contains two hex switches labeled ADDRESS ID on the cover. Refer to Figure 3. These switches must be set to identify the number of master stations in the system. This setting is critical to ensure the master I/O controller recognizes the commands from all the master stations. Up to eight master stations can be parallel-connected to the M/I cabinet.

Switches S1 and S2 are used to set the number of master stations in the system. The switch setting is read as a hexadecimal number. Switch S1 is the LO address and switch S2 is HI address.

Table 3. Switch Setting Examples

Switch S2	Switch S1	Number of Master Stations
0	1	1
0	2	2
0	3	3
0	4	4
0	5	5
0	6	6
0	7	7
0	8	8

NOTE: The switch setting is recognized only when either the master I/O controller is powered up, or when the RESET button is pressed. Momentarily press the RESET button each time a switch is changed. The RESET button located next to the ADDRESS ID switches.

DIP Switch Settings

The master I/O controller switch S4 is an eight-position DIP switch that is used to set the data baud rate. This switch is factory set and should not be changed. To access the DIP switch, the cover must be removed from the I/O controller. If replacing the master I/O controller, be sure to set the switch as follows:

Table 4. DIP Switch Settings

Switch Position	Open/Close	Switch Position	Open/Close
S4-1	Open	S4-5	Open
S4-2	Open	S4-6	Open
S4-3	Open	S4-7	Open
S4-4	Open	S4-8	Close

Press the RESET switch following any switch changes.

Jumper Clip Settings

The master I/O controller has two jumper clips, J6 and J7, which determine the data connection and operating mode of the module, as follows:

J6—is a three-position jumper that selects either RS-232 or RS-485 data communication. Always select RS-485 by inserting the shorting clip across pins two and three on J6.

J7—is a three-position jumper that puts the board in programming mode. Always select run mode by inserting the shorting clip across pins one and two on J7.

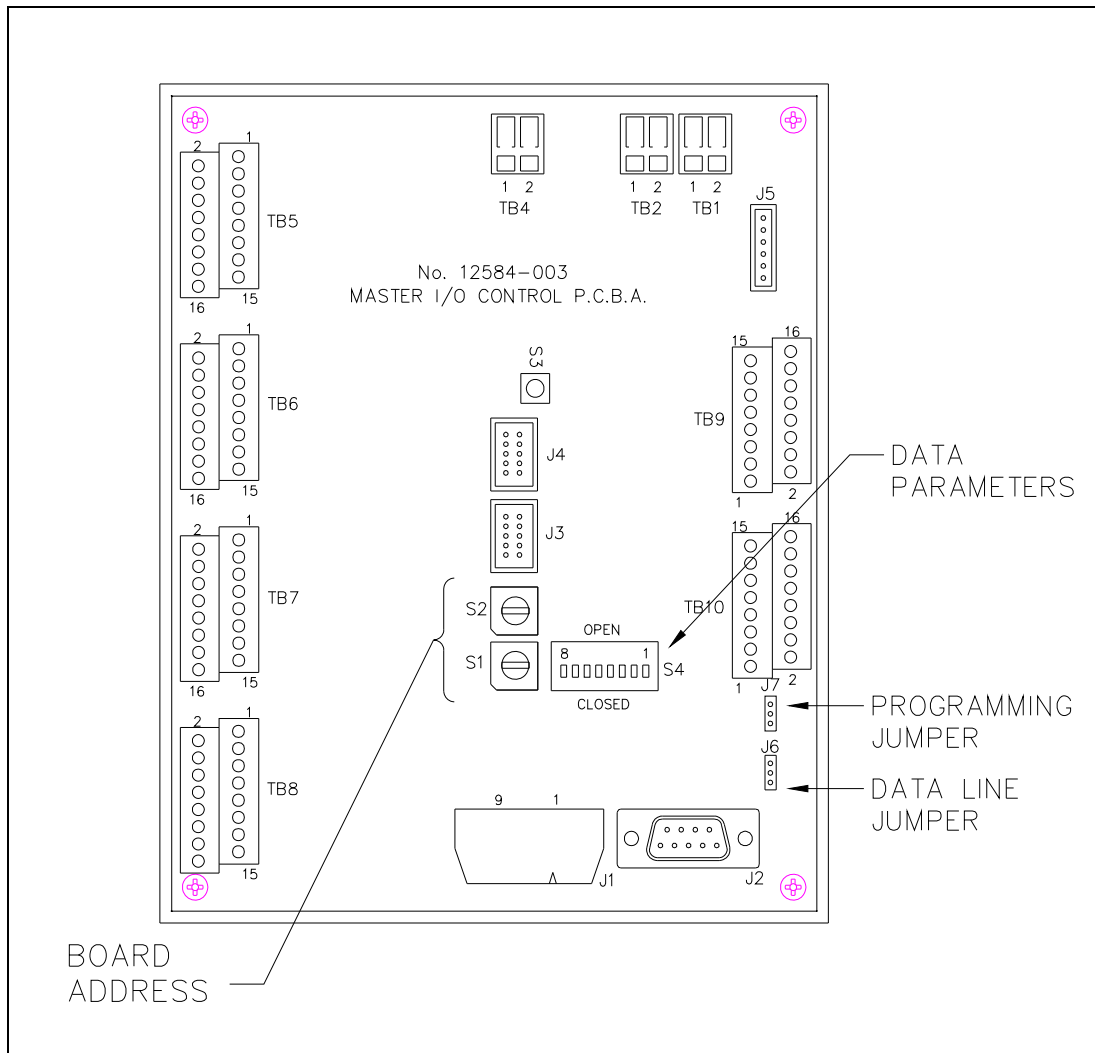

Figure 3. Master I/O Controller Module (Cover removed)

Fault Light Indicator

The red LED indicator on the audio switching PCBA illuminates if data communication is lost to any of the master stations.

Alarm Mode Jumper

At the master I/O controller module, a jumper is pre-installed at the factory between terminals 15 and 16 at TB8. The following describes the modes of operation if the jumper is installed or removed:

Installed (manual alarm routing)—With the jumper installed, any alarm activation at the master or at an external input will cause the AMI to become active, but the alarm audio will be broadcast only to the master station(s). This feature allows the master station operator to direct the alarm audio to the zone(s) affected by the alarm event.

Removed (automatic All-Zone alarm)—If the jumper is removed, any alarm activation at the master or at an external input will cause the AMI to become active, and also automatically route the alarm audio to all zones. The master operator can intervene and deselect zone(s) not affected by the alarm event.

Setting Jumpers and Adjustments

Line Balance Adjustment for Page Lines

A line balance adjustment is provided for each zone and the master stations. The line balance adjustment is factory-set for optimum performance but may need adjustment in some situations. If the line balance adjustment is set too low, the speaker volume will also be low. If the line balance adjustment is set too high, the speaker audio will be distorted. To correct low or distorted audio, complete the following adjustments.

Master Stations

Perform the following steps to properly adjust the line balance assembly:

1. Remove the page line conductors from terminals 7 and 8 on the termination PCBA. See Figure 2 for terminal block location for the master station.
2. Place an ohmmeter across terminals 7 and 8 on the termination PCBA.
NOTE: The optimum page line balance is 33 ohms.
3. Adjust potentiometer R15 on the audio switching PCBA to achieve 33 ohms on the ohmmeter.

Field Stations

Perform the following steps to properly adjust the line balance assembly for all zones:

1. Remove the zone page line conductors from terminals 1 and 2 on the termination PCBA. See Figure 2 for the terminal block location for each zone.
2. Place an ohmmeter across terminals 1 and 2 on the termination PCBA.
NOTE: The optimum page line balance is 33 ohms.
3. Adjust the applicable potentiometer on the audio switching PCBA for each zone to achieve a reading of 33 ohms on the ohmmeter. Refer to the table below for the correct potentiometer for each zone.

Table 5. Zone Line Balance Potentiometers

Zone	Potentiometer
Zone 1	R2
Zone 2	R5
Zone 3	R8
Zone 4	R11
Zone 5	R17

Line Balance for Party Lines

The Model MI05-101 Merge/Isolate Cabinet provides line balancing for all system party lines. No user adjustments are required for the party lines *unless* the party lines are made common and an external device such as the Model 10959-203 Audio Messenger Interface with telephone interface circuits, or the Model GTK99019 External Audio Interface, is used with the system. If party line four and/or five is used for either the audio messenger interface or the external audio interface, the line balance must be removed because each device provides the necessary line balancing for the designated party line.

To disable the internal line balance for either party line four and/or five, refer to the following table:

Table 6. Internal Party Line Balance Jumpers

Party Line	Jumpers	Enable Internal Line Balance	Disable Internal Line Balance
4	JB51 and JB52	Jumper pins 1 and 2	Jumper pins 2 and 3
5	JB53 and JB54	Jumper pins 1 and 2	Jumper pins 2 and 3

Enable/Disable the CallIn Feature

Jumpers are provided on the termination PCBA to enable or disable the call-in feature for each zone.

- To enable the call-in feature, jumper pins 2 and 3 on the termination PCBA.
- To disable the call-in feature, jumper pins 1 and 2 on the termination PCBA.

Table 7. Call-In Feature Jumpers

Zone	Call-In Feature Jumpers
1	JB1 and JB2
2	JB3 and JB4
3	JB5 and JB6
4	JB7 and JB8
5	JB9 and JB10

Configuring Common Party Lines between Zones and Master Station

Jumpers are provided on the termination PCBA to make party lines two through five common across zones and the master station(s). When a party line is made common between zones and the master station, any station can pick up a handset and join the conversation.

- To make a party line common, jumper pins 1 and 2 on the jumper assigned to the zone or master station party line.
- To isolate the party line, jumper pins 2 and 3 on the jumper assigned to the zone or master station party line.

The following table lists the jumpers for each zone.

Table 8. Zone to Master Station Common Party Line Jumpers

Zone	Party Line 2	Party Line 3	Party Line 4	Party Line 5
1	JB11 and JB12	JB13 and JB14	JB15 and JB16	JB17 and JB18
2	JB19 and JB20	JB21 and JB22	JB23 and JB24	JB25 and JB26
3	JB27 and JB28	JB29 and JB30	JB31 and JB32	JB33 and JB34
4	JB35 and JB36	JB37 and JB38	JB39 and JB40	JB41 and JB42
5	JB43 and JB44	JB45 and JB46	JB47 and JB48	JB49 and JB50
Master	N/A	N/A	JB51 and JB52	JB53 and JB54

Configuring Remote Switches to Activate Alarms

The cabinet can be configured to accept either normally open or normally closed switch contacts for alarm activation. The cabinet provides connection for up to seven different alarm input circuits. Each input circuit contains jumpers for the type of switch used: either normally open or normally closed.

The following table outlines the jumper settings that are located on the external interface PCBA.

Table 9. External Interface PCBA Jumpers

Input	Jumper	Normally Open	Normally Closed
1	J6	<ul style="list-style-type: none"> • Jumper pins 1 and 2 • Jumper pins 4 and 5 	<ul style="list-style-type: none"> • Jumper pins 3 and 4 • Jumper pins 5 and 6
2	J7	<ul style="list-style-type: none"> • Jumper pins 1 and 2 • Jumper pins 4 and 5 	<ul style="list-style-type: none"> • Jumper pins 3 and 4 • Jumper pins 5 and 6
3	J8	<ul style="list-style-type: none"> • Jumper pins 1 and 2 • Jumper pins 4 and 5 	<ul style="list-style-type: none"> • Jumper pins 3 and 4 • Jumper pins 5 and 6
4	J9	<ul style="list-style-type: none"> • Jumper pins 1 and 2 • Jumper pins 4 and 5 	<ul style="list-style-type: none"> • Jumper pins 3 and 4 • Jumper pins 5 and 6
5	J10	<ul style="list-style-type: none"> • Jumper pins 1 and 2 • Jumper pins 4 and 5 	<ul style="list-style-type: none"> • Jumper pins 3 and 4 • Jumper pins 5 and 6
6	J11	<ul style="list-style-type: none"> • Jumper pins 1 and 2 • Jumper pins 4 and 5 	<ul style="list-style-type: none"> • Jumper pins 3 and 4 • Jumper pins 5 and 6
7	J12	<ul style="list-style-type: none"> • Jumper pins 1 and 2 • Jumper pins 4 and 5 	<ul style="list-style-type: none"> • Jumper pins 3 and 4 • Jumper pins 5 and 6

Cabinet Power Connections



Connect a 3-conductor, No. 14 AWG ac power cable (customer-supplied) to the line (L), neutral (N), and ground (GND) terminals at the ac input terminal block located at the bottom right corner of the cabinet's termination panel. The ac source voltage to this cabinet can be either 120 V or 240 V, 50/60 Hz (*see note*). Current draw is approximately 0.2 A at 120 V ac or 0.1 A at 240 V ac.

NOTE: The ac input voltage range for this cabinet is 90–264 V ac.

External Accessory Components

The following components are installed externally to the Model MI05-101 Merge/Isolate Cabinet. All cable required for installation of this equipment must be provided by the installer.

Model 10959-201 Audio Messenger Interface

 **CAUTION**  The AMI is supplied with an external plug-in power supply adapter and it should not be used in this application. Instead, connect the AMI's input power terminals to the 24 V dc output power terminals provided on the merge/isolate cabinet's termination panel per the table below.



1. Mount the AMI in accordance with GAI-Tronics Pub. 42004-403, which is packaged with the equipment.
2. Reprogram the AMI as described in the "Programming the AMI" section on Page 13. Several parameters must be changed from the AMI's factory default programming to allow proper operation with the MI05 Series Merge/Isolate Cabinets.

3. Connect the AMI to the external interface PCBA as follows using five pairs of No. 18–22 AWG conductors for audio and alarm inputs, and a three-conductor cable for dc power. Refer to the following table for all connections between the AMI and the M/I cabinet:

Table 10. AMI to External Interface PCBA Connections

Function	AMI Page/Party® Interface PCBA	Connect to	Merge/Isolate External Interface PCBA
Page Line	P1-3 P1-4		TB3-8 TB3-7
Function	AMI Termination PCBA	Connect to	Merge/Isolate External Interface PCBA
Common	TB2-1		TB4-1
Alarm Input 1	TB2-2		TB4-8
Alarm Input 2	TB2-3		TB4-7
Alarm Input 3	TB2-4		TB4-6
Alarm Input 4	TB2-5		TB4-5
Alarm Input 5	TB2-6		TB4-4
Alarm Input 6	TB2-7		TB4-3
Alarm Input 7	TB2-8		TB4-2
Function	AMI Termination PCBA	Connect to	Merge/Isolate Termination Panel
24 V dc	TB6 +		AMI 24 V dc (+)
	TB6 –		AMI 24 V dc (–)
Ground	TB6 ⚡		AMI GND

Model 10959-203 Audio Messenger Interface with Telephone Interface

 **CAUTION**  The AMI is supplied with an external plug-in power supply adapter, and it should not be used in this application. Instead, connect the AMI’s input power terminals to the 24 V dc output power terminals provided on the merge/isolate cabinet’s termination panel per the table below.

1. Mount the AMI in accordance with Pub. 42004-403, which is packaged with the equipment.
2. Reprogram the AMI as described in the “Programming the AMI” section on Page 13. Several parameters must be changed from the AMI’s factory default programming to allow proper operation with the MI05 Series Merge/Isolate Cabinets.
3. Connect the AMI to the External Interface PCBA as follows using eight pairs of No. 18–22 AWG conductors for audio and alarm inputs, and a three-conductor cable for dc power cable. Refer to the following table for all connections between the AMI and the M/I cabinet:

Table 11. AMI with Telephone Interface to External Interface PCBA Connections

Function	AMI Page/Party® Interface PCBA	Connect to	Merge/Isolate External Interface PCBA
Page Line	P1-3 P1-4		TB3-8 TB3-7
Party Line 5	P1-1 P1-2		TB3-6 TB3-5
Function	AMI Termination PCBA	Connect to	Merge/Isolate External Interface PCBA
Common	TB2-1		TB4-1
Alarm Input 1	TB2-2		TB4-8
Alarm Input 2	TB2-3		TB4-7
Alarm Input 3	TB2-4		TB4-6
Alarm Input 4	TB2-5		TB4-5
Alarm Input 5	TB2-6		TB4-4
Alarm Input 6	TB2-7		TB4-3
Alarm Input 7	TB2-8		TB4-2
Master Stn. Page	TB2-9		TB3-4
Common	TB2-10		TB3-3
Common	TB1-1		TB3-1
Aux. Output 1	TB1-2		TB3-2
Function	AMI Termination PCBA	Connect to	Merge/Isolate Termination Panel
24 V dc	TB6 +		AMI 24 V dc (+)
	TB6 -		AMI 24 V dc (-)
Ground	TB6 		AMI GND

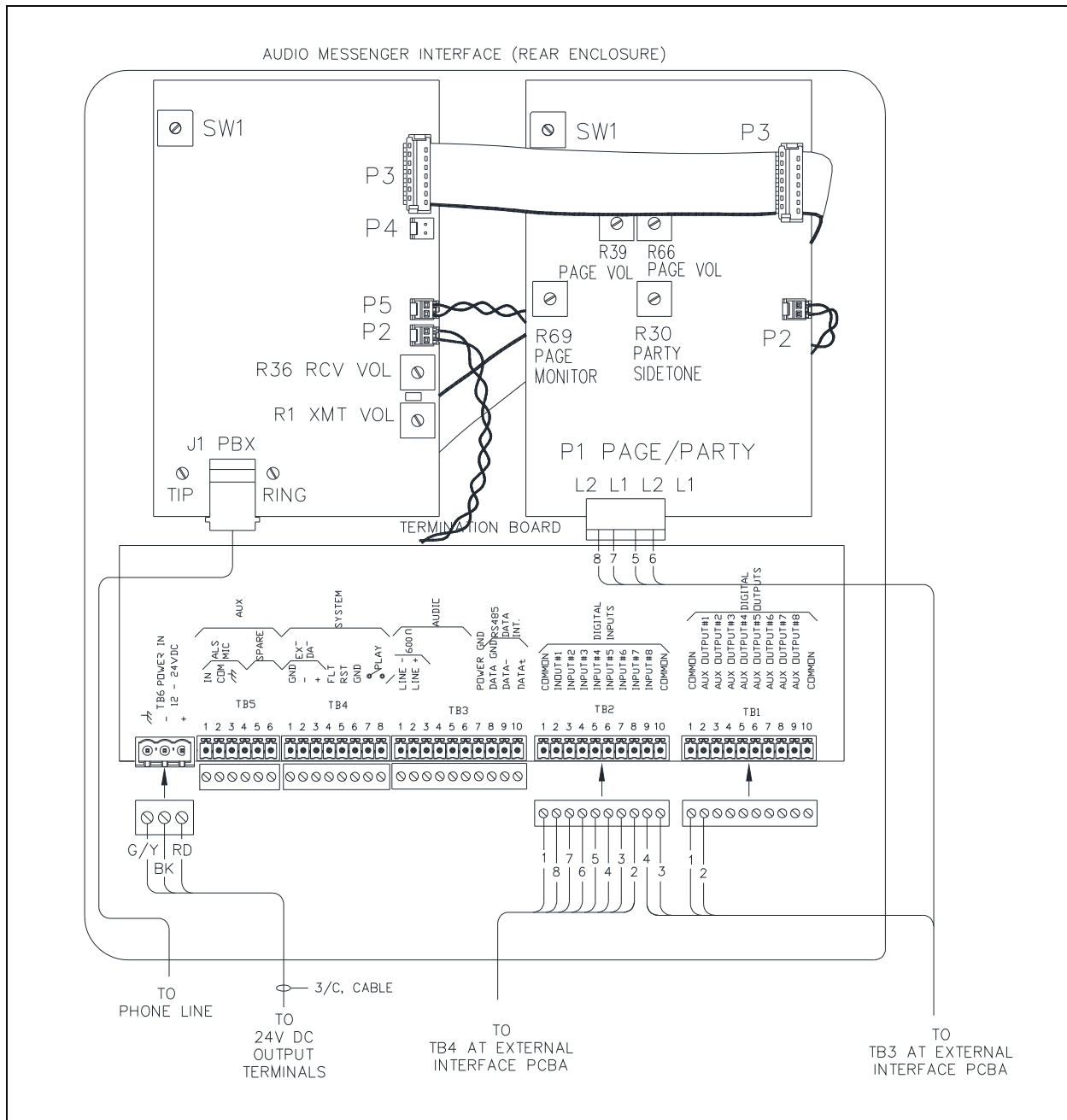

Figure 4. Audio Messenger Interface Connection Diagram

Programming the AMI

The Model 10959 Series AMI's factory default programming must be changed prior to use with the Model MI05 Series Merge/Isolate Cabinet. The programming is accomplished using the AMI Configuration Tool (ACT) software provided with the AMI. Refer to the AMI manual and ACT help screens for details on using the configuration software. Changes required for use with the Model MI05 Series Merge/Isolate Cabinet are as follows:

Message Screen

Create a new message for play during a master station page. The message should be configured per the screen below. When this message is active the AMI will play a silent tone. Note the message priority must be set to the highest priority to enable the master station's pages to override any active alarms or telephone pages (if applicable).

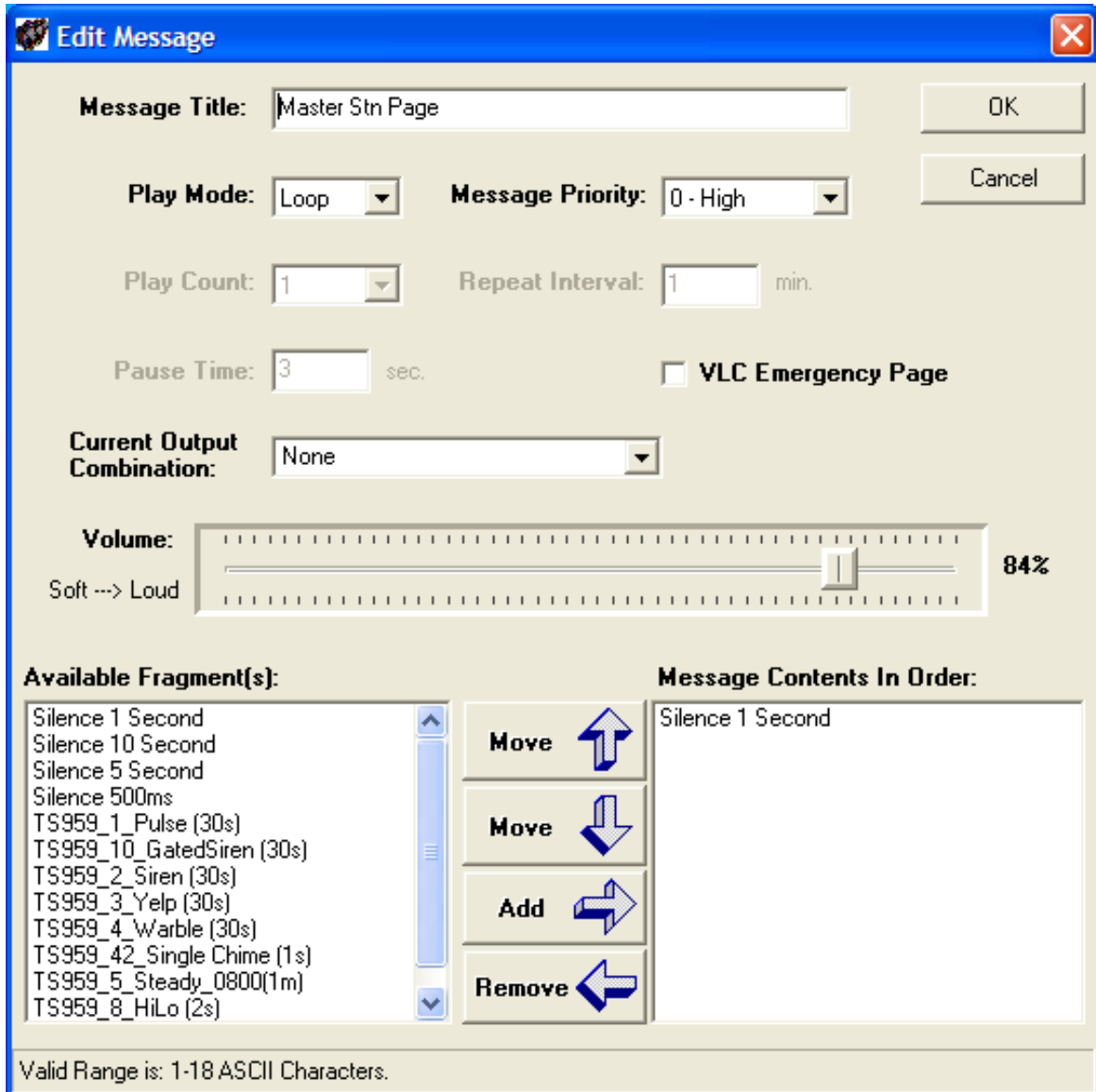

Edit Message

Message Title: Master Stn Page OK

Play Mode: Loop **Message Priority:** 0 - High Cancel

Play Count: 1 **Repeat Interval:** 1 min.

Pause Time: 3 sec. **VLC Emergency Page**

Current Output Combination: None

Volume: Soft --> Loud 84%

Available Fragment(s):

- Silence 1 Second
- Silence 10 Second
- Silence 5 Second
- Silence 500ms
- TS959_1_Pulse (30s)
- TS959_10_GatedSiren (30s)
- TS959_2_Siren (30s)
- TS959_3_Yelp (30s)
- TS959_4_Warble (30s)
- TS959_42_Single Chime (1s)
- TS959_5_Steady_0800(1m)
- TS959_8_HiLo (2s)

Message Contents In Order:

- Silence 1 Second

Valid Range is: 1-18 ASCII Characters.

Inputs Screen

- Inputs one through seven must have the **CONTINUOUS AUDIO MESSAGE** box selected. This allows the message to play while the input is active and stop when the input is inactive. Input control lines are supplied from the M/I cabinet's external interface PCBA. A reset input to the AMI is not required. See screen shot below for example of **INPUT 1**. Duplicate these settings for inputs two through seven.
- Change the **CURRENT OUTPUT COMBINATION** to **NONE**. This will prevent the AMI auxiliary output one from activating during an alarm. This output should only activate during a telephone page (if applicable).

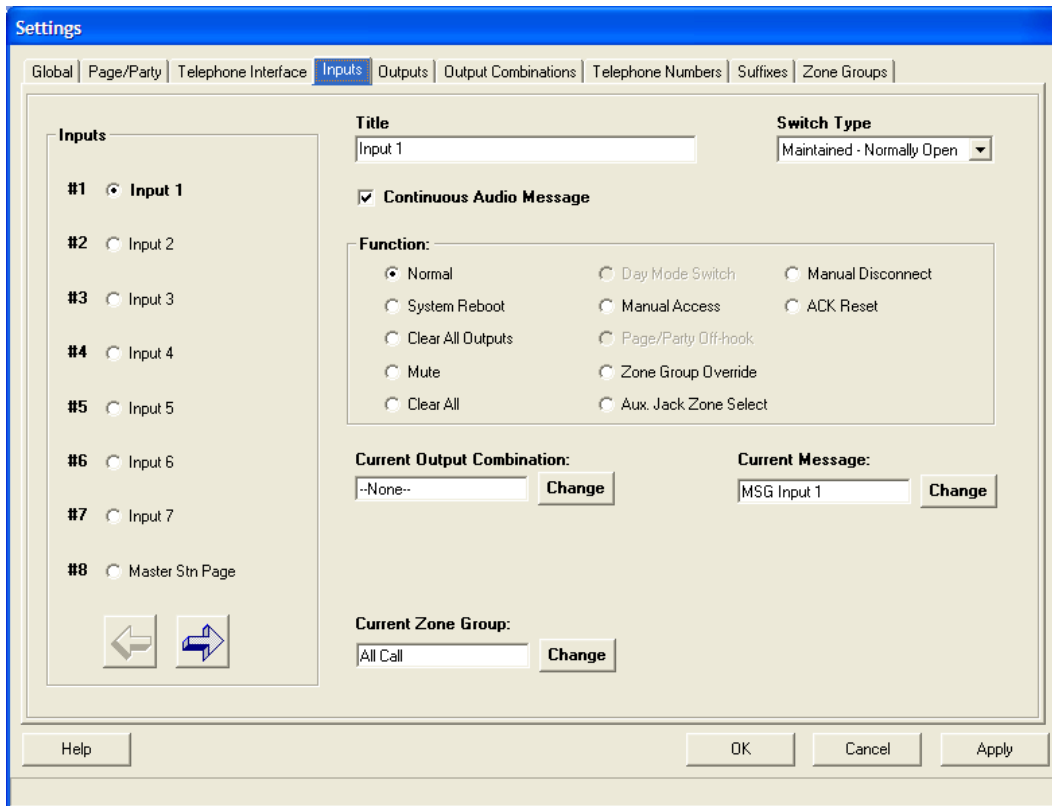

Input eight must be configured the same as inputs one through seven except it must be set to activate the MASTER STATION PAGE message created in the previous step. The screen shot below shows the correct settings for INPUT 8.

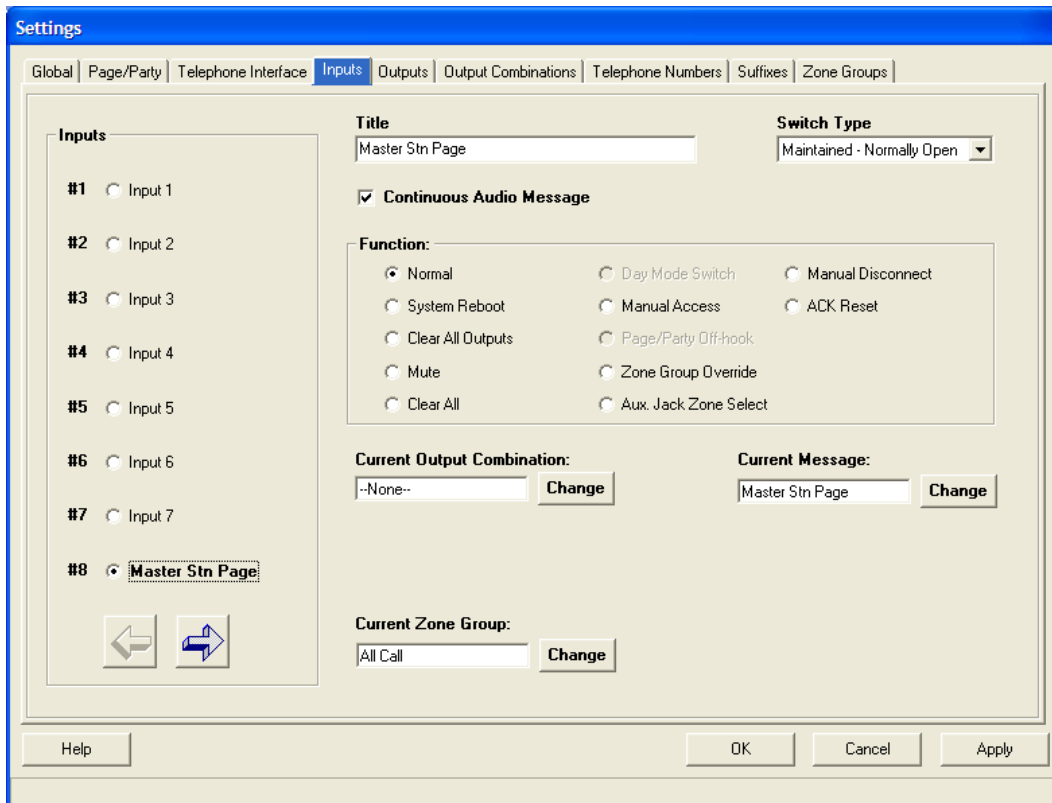

For additional features regarding the AMI alarm messages, refer to help screens supplied with the AMI programming software. The changes noted above are the minimum changes required to allow AMI alarm activation from the MI05 Series Merge/Isolate Cabinet.

Outputs Screen

Select the FOLLOW EVENT box for OUTPUT 1. This output will be active during telephone paging and return to the inactive state when the page is ended. The M/I cabinet will merge all zones during the telephone page as a result of the active output.

The screenshot shows a software window titled "Settings" with a tabbed interface. The "Outputs" tab is selected. It contains a table with 8 rows, each representing an output. The columns are: Title, Mode, Normally Open, Normally Closed, and Follow Event. Output #1 has "Follow Event" checked, while all other outputs have it unchecked. All modes are set to "Maintained".

	Title	Mode	Normally Open	Normally Closed	Follow Event
#1	Output 1	Maintained	<input checked="" type="radio"/>	<input type="radio"/>	<input checked="" type="checkbox"/>
#2	Output 2	Maintained	<input checked="" type="radio"/>	<input type="radio"/>	<input type="checkbox"/>
#3	Output 3	Maintained	<input checked="" type="radio"/>	<input type="radio"/>	<input type="checkbox"/>
#4	Output 4	Maintained	<input checked="" type="radio"/>	<input type="radio"/>	<input type="checkbox"/>
#5	Output 5	Maintained	<input checked="" type="radio"/>	<input type="radio"/>	<input type="checkbox"/>
#6	Output 6	Maintained	<input checked="" type="radio"/>	<input type="radio"/>	<input type="checkbox"/>
#7	Output 7	Maintained	<input checked="" type="radio"/>	<input type="radio"/>	<input type="checkbox"/>
#8	Output 8	Maintained	<input type="radio"/>	<input checked="" type="radio"/>	<input type="checkbox"/>

At the bottom of the window are buttons for "Help", "OK", "Cancel", and "Apply".

Telephone Interface Screen

The ANNOUNCEMENT OUTPUT COMBINATION must be set to OUTPUT 1. This will cause output 1 to activate while telephone paging is active. The M/I cabinet will merge all zones during the telephone page as a result of the active output. Also the PRE-ANNOUNCEMENT TONE AND TELEPHONE PAGING PRIORITY must be set to the lowest priority to prevent telephone pages from interfering with alarms or master station pages.

Settings

Global | Page/Party | **Telephone Interface** | Inputs | Outputs | Output Combinations | Telephone Numbers | Suffixes | Zone Groups

Day/Night Mode

Disable Schedule Manual

Access Method: Page/Party® Party Line: 5

Remote Access Security Code: 0000

Current Ring Message: -None- Change

Current Greeting Message: -None- Change

Announcement Output Combination: Output 1 Change

Party Line Pick-up Output Combination: -None- Change

Page Answer Delay: 60 sec.

Page Duration: 15 sec.

Off-hook Timeout: 7 min.

Disable Off-hook Timeout

Number of Rings: 1

Default Zone Group: All Call Change

Day/Night Mode Shared Settings

Pre-Announcement Tone: TS959_8_HiLo (2s) Change

Pre-Announcement Tone Volume: 84%

Pre-Announcement Tone and Telephone Page Priority: 8

Page/Party® Off-hook Detection Method: Hardware

Hang-up Delay: 15 sec.

Help OK Cancel Apply

For additional features regarding the AMI telephone interface, refer to help screens supplied with the AMI programming software. The changes noted above are the minimum changes required to allow the telephone paging access to the Model MI05 Series Merge/Isolate Cabinets.

Using the 12584-001 AMI I/O Expansion Module

If using the Model 12584-001 I/O Expansion Module with the AMI for additional alarm inputs, the input screen for each input 9–40 must be programmed.

1. First, program the input switch type and the current message to be activated by the input.
2. Next, program the current output combination to OUTPUT 1. This will cause output one to activate while the input is active. The M/I cabinet will merge all zones during the alarm message as a result of the active output.

Inputs 9–40 are independent of the master station and will be automatically broadcast to all zones of the system. The following screen is an example of INPUT 9. The remaining inputs; 10–40, must be programmed in the same fashion if used.

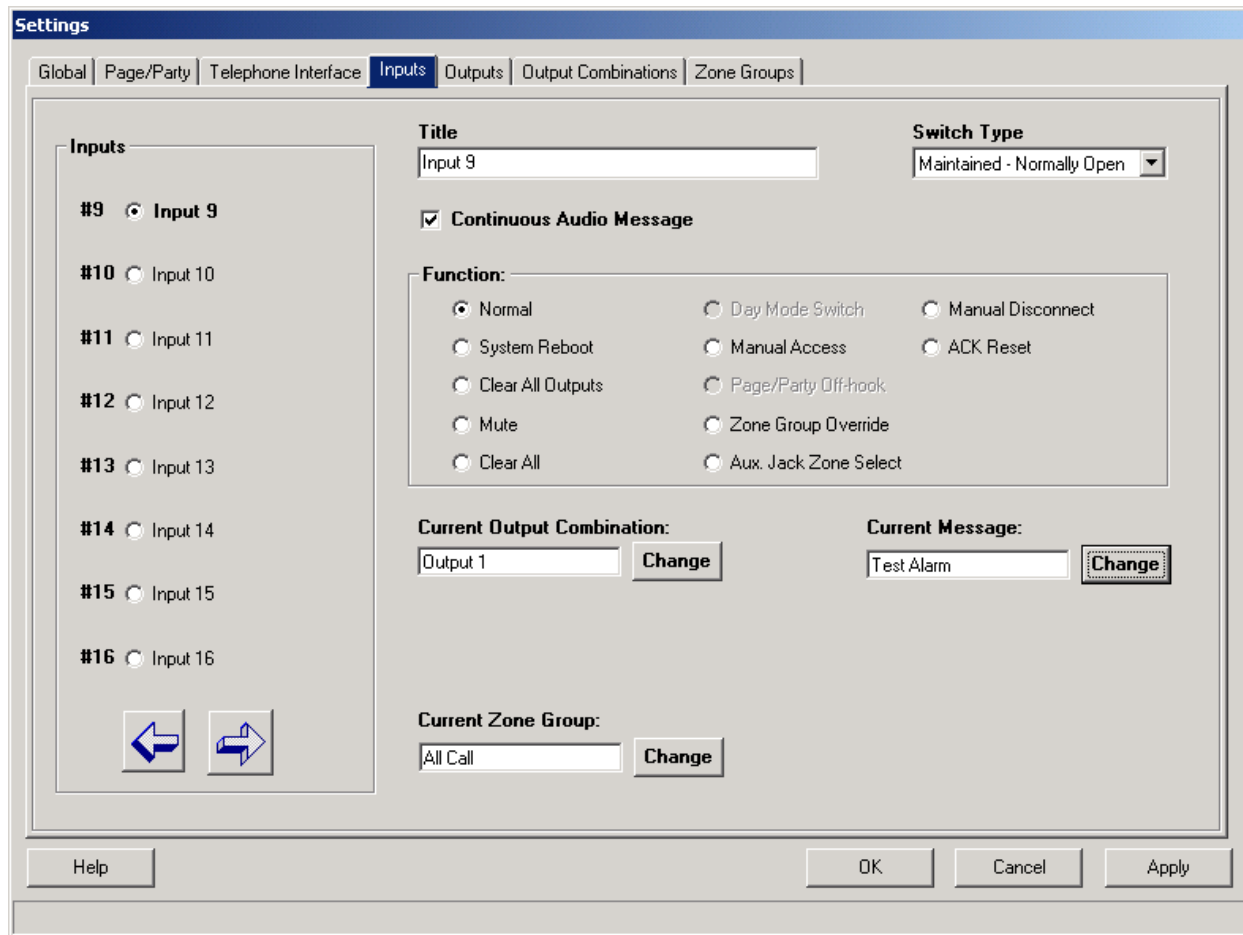

Model GTK99019 Audio Interface

1. Mount the Model GTK99019 Audio Interface in accordance with GAI-Tronics Pub. K99019iom, which is packaged with the equipment.
2. Connect TB1 of the audio interface to the 120 V ac power source using 3-conductor, No. 14 AWG ac power cable. Power requirements for this interface are 120 V ac, 50/60 Hz at 0.2 A.
3. Connect the audio interface to the Model MI05-101 Merge/Isolate Cabinet’s external interface PCBA as follows using a 4-pair, No. 18–20 AWG cable. Refer to Figure 5.

Table 12. Model GTK99019 Audio Interface to M/I Cabinet Connections

Function	Audio Interface Terminals	Connect to	M/I Cabinet’s External Interface PCBA
Page Line	TB2-4 and TB2-5		TB2-1 and TB2-2
Party Line	TB2-6 and TB2-7		TB2-3 and TB2-4
All-Call Control Lines	TB2-14 and TB2-15		TB2-7 and TB2-8
Page Override Control Lines	TB2-16 and TB2-17		TB2-5 and TB2-6

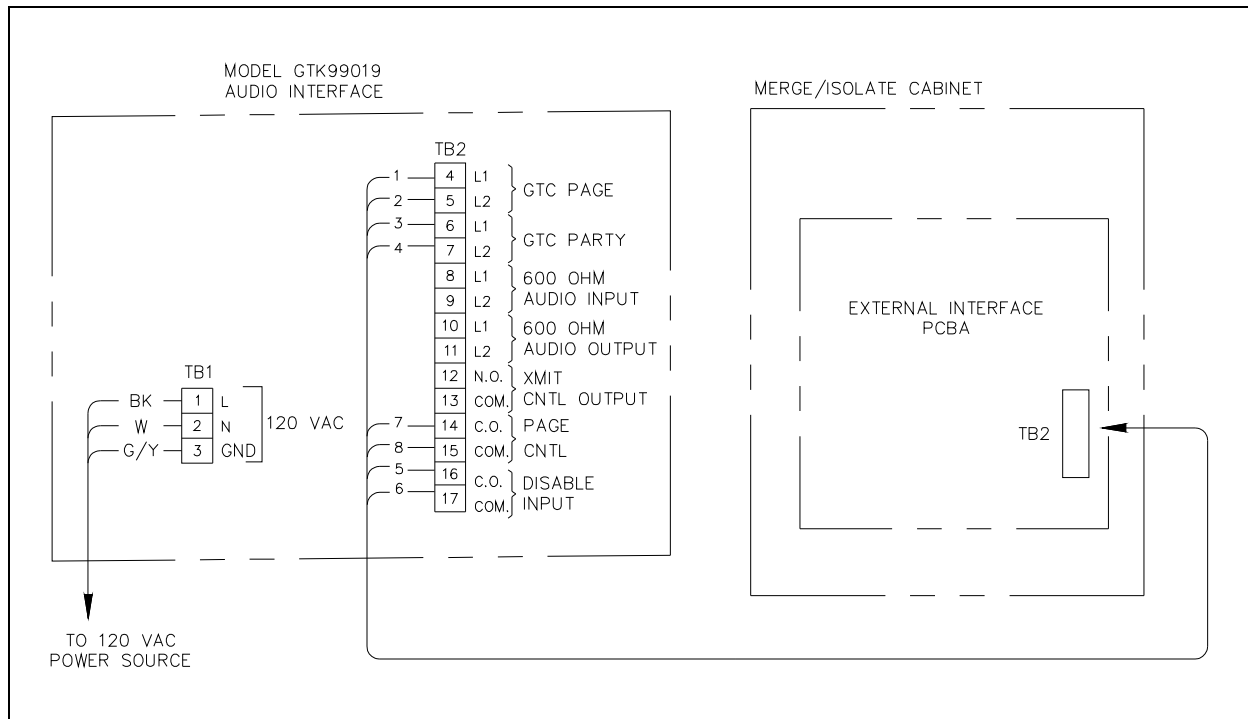

Figure 5. Model GTK99019 Audio Interface Connection Diagram

Model D99001-VLCX Volume Level Control Transmitter Kit

Install the Volume Level Control Transmitter Kit as follows:

1. Mount the VLC transmitter PCBA to the cabinet panel just above the external interface PCBA. Panel (refer to Figure 2 for location external interface PCBA). The panel contains stand-offs for mounting the VLC transmitter. Mounting screws are provided with the kit.
2. Plug the VLC transmitter PCBA cable assembly into J5 on the external interface PCBA.

Operation

The Model MI05-101 Merge/Isolate Cabinet's functions are controlled by one or more Model MS05-101 Master Stations. The cabinet allows the master stations to selectively merge any combination of zones or all zones for paging and party line communication. The cabinet also allows the master stations to make voice pages to any combination of zones or all zones simultaneously. A detailed description of the master station controls is outlined in the manual that is packaged with the master station.

External accessories can be added to the cabinet to expand the system operation. To accommodate the additional devices using the page line, a priority scheme is used. There are a total of three levels of priorities. If more than one device attempts to broadcast audio on the page line, only the audio from the highest priority device will be broadcast from the paging speakers. The following priorities are assigned (1 being the highest) and can not be altered:

1. Master Stations
2. Alarms
3. Page/Party[®] stations, telephone interface, and audio interface

Accessories

Model 10959-201 Audio Messenger Interface (AMI)

The Model 10959-201 Audio Messenger Interface (AMI) produces alarms or warning tones to alert people of emergency conditions. The AMI can generate seven prioritized alarm tones, selected from a default library of tones. Custom tones or messages can also be stored on the AMI for playback. These tones/messages are activated by either the external field switches or by master stations. If an alarm is activated from a field switch, the alarm is broadcast to all zones. If an alarm is activated from a master station, the alarm can be broadcast to any zone, combination of zones or all zones.

NOTE: All alarm tones must be reset by the master station.

Detailed programming options and operation are explained in GAI-Tronics Pub. 42004-403 for the Model 10959-201.

Model 10959-203 Audio Messenger with Telephone Interface

The Model 10959-203 provides all of the same functions as the 10959-201 described above, but also allows individuals to access the system page and party line using a standard telephone. Voice paging and party line conversations are supported; however, this feature does not support dial out access from the Page/Party[®] stations. By dialing a predetermined extension, the telephone caller can broadcast a page over the system speakers in all zones and converse on party line 5.

Detailed programming options and operation are explained in GAI-Tronics Pub. 42004-403 for the Model 10959-203.

Model GTK99019 Audio Interface

The Model GTK99019 Audio Interface allows access to the Page/Party[®] system from a remote device. Access to the page line and party line four is supported. Possible applications for this interface include broadcasting an external audio source over the paging speakers. One-way or two-way radio communication between the Page/Party[®] handset stations and an external radio system is another possible application.

Detailed operation is explained in the instructions provided in Pub. K99019iom.

Model GTD99001-VLCX Volume Level Control Transmitter

The VLC transmitter is activated when a voice page is generated from the master station. When active, the transmitter produces a signal on the page line, which in turn activates remote devices that are set to monitor the page line.

Typical applications of the VLC transmitter include:

- Activating speaker amplifiers in locations such as conference rooms or crew's quarters, where the broadcasting of operational pages is unnecessary.
- Activating strobes or other external signaling devices.
- Increasing output to speakers and disabling handset page capabilities at Page/Party[®] field stations equipped with VLC receivers.

Maintenance

If the equipment requires service, contact your Regional Service Center for a return authorization number (RA#). Equipment should be shipped prepaid to GAI-Tronics with a return authorization number and a purchase order number. If the equipment is under warranty, repairs or a replacement will be made in accordance with GAI-Tronics' warranty policy. Please include a written explanation of all defects to assist our technicians in their troubleshooting efforts.

Call 800-492-1212 inside the USA or 610-777-1374 outside the USA for help identifying the Regional Service Center closest to you.

Supplemental Information

Reference Documentation

- 73535 No. MI05-101 5-Zone Merge/Isolate Cabinet Outline & Mounting Details (2 sheets)
- 73536 No. MI05-101 5-Zone Merge/Isolate Cabinet Interconnection Diagram
- 42004-403 Model 10959-201 and -203 Wall-Mount Audio Messenger Interfaces (AMI)
- K99019iom Model GTK99019 Merge/Isolate Audio Interface Manual

Spare Parts

Part No.	Description
12584-003	Master I/O Controller
69281-001	Termination PCBA
69282-001	Audio Switching PCBA
69284-001	External Interface PCBA