



industrial controls division

INSTRUCTIONS

2210/2220

Publication No. 130
January 1987
Repl. March 1983

INSTRUCTIONS FOR BULLETIN 2210 & 2220 SPEED RESPONSIVE SWITCHES



**BULLETIN 2210, TYPE C SPEED RESPONSIVE SWITCH,
FLYWEIGHT TYPE WITH SLOW ACTION BUTT TYPE
NON-DIRECTIONAL CONTACTS**

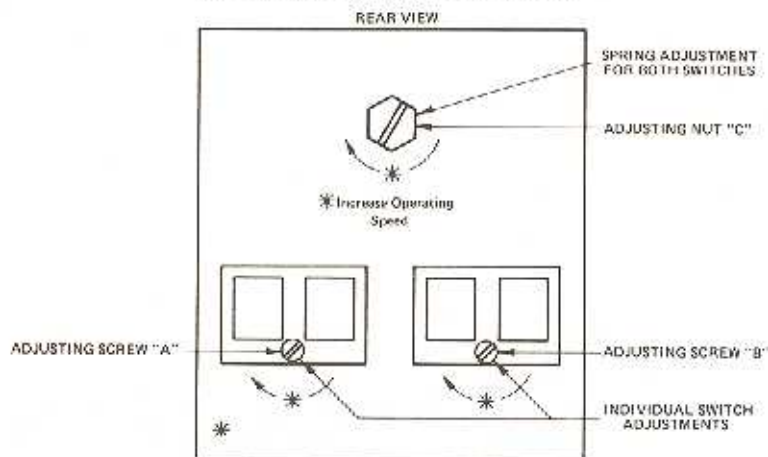

**BULLETIN 2210, TYPE C SPEED RESPONSIVE SWITCH
FLYWEIGHT TYPE WITH FAST ACTION BREAK,
NORMALLY CLOSED BUTT TYPE NON-DIRECTIONAL
CONTACTS, MANUALLY RESET**

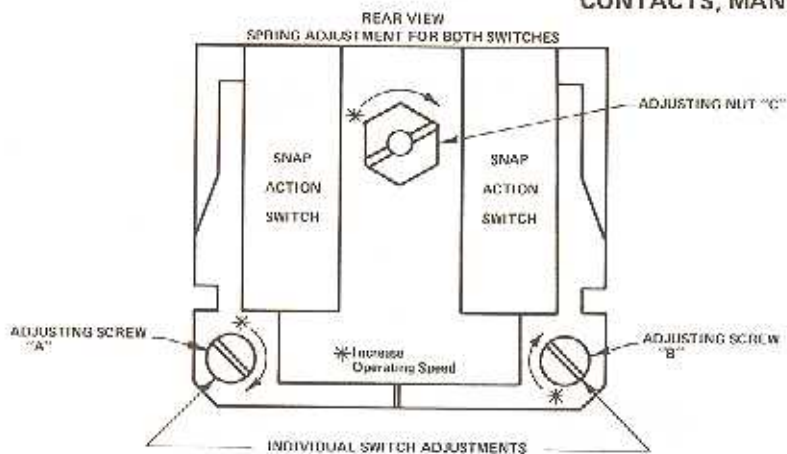

GENERAL

Euclid Type C Flyweight Speed Responsive Switches are pilot devices used to sense speed in overspeed or underspeed applications, for plugging control and conveyor interlocking, etc. This type of switch is available with snap action contacts, slow action contacts, or air valve operator. These switches can be supplied for either surface mounting, or flange mounting. A 2.94 to 1 or 8.64 to 1 integrally mounted speed increaser is also available for these switches.

INSTALLATION

Surface mounting type switches shall be properly aligned and mounted on a smooth flat surface by means of mounting screws through the mounting holes provided in the switch housing. Normally sufficient clearance is provided in the four mounting holes in flange to permit proper alignment. If extreme vibration conditions exist, doweling of the switch mounting feet is recommended. When direct connecting these switches to a mating shaft, a suitable resilient separator type coupling, see Bulletin 2210 or equivalent, must be used. Under no circumstances shall the switch shaft be subject to any end thrust. When the switch is to be belt driven reasonable belt tightness shall be observed to minimize overhanging bearing load. Couplings or pulleys shall have a push fit and shall be applied or removed without hammering.

Flange mounting switches shall be mounted true and concentric with mating shaft. The accurately machined flange with pilot ring assures true alignment if mating surfaces are

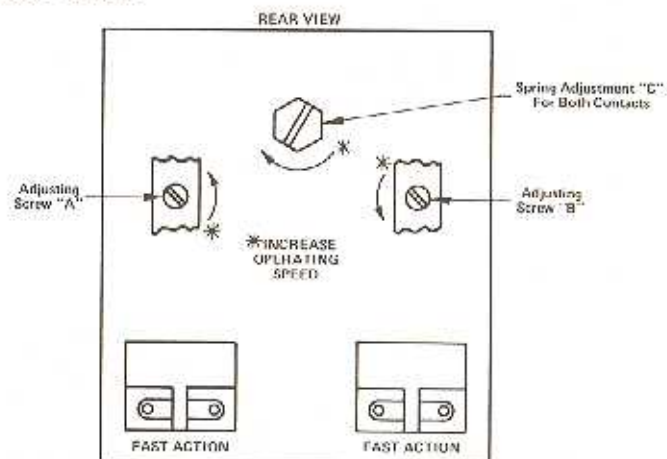

carefully machined. A suitable resilient separator type positive drive coupling must be used. Under no circumstances shall the switch shaft be subject to any end thrust. Couplings shall have a push fit and shall be applied or removed without hammering.

ADJUSTMENTS

Referring to sketch above, the speed at which the contacts operate can be varied by two adjusting means while the switch is rotating. The major adjustment is made by turning adjusting nut "C". Turning adjusting nut "C" clockwise causes the contacts to operate at a higher speed. If the switch has two sets of contacts, both sets will be affected by this adjustment. Each switch can be independently adjusted by turning adjustment screw "A" for the left hand switch and screw "B" for the right hand switch. Turning screw "A" or "B" clockwise will cause the contacts to operate at a higher speed. In the case where the two sets of contacts are being adjusted for operation at two different speeds some interaction of adjustment may be experienced. Always re-check setting on each set of contacts and readjust slightly if necessary.

MAINTENANCE

All of the bearings used in these switches are permanently lubricated. Therefore, no maintenance is required once these switches are installed and properly adjusted.

**BULLETIN 2220, TYPE F SPEED RESPONSIVE SWITCH
FLUID/EDDY CURRENT TYPE WITH SNAP ACTION
DIRECTIONAL CONTACTS**

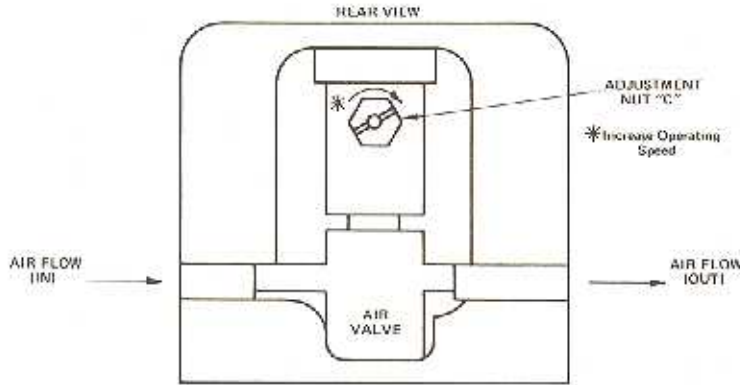

ADJUSTMENTS

Referring to sketch above, the speed at which the air valve operates can be varied while the switch is rotating. The adjustment is made by turning adjusting nut "C". Turning adjusting nut "C" clockwise causes the air valve to operate at a higher speed. NOTE: The tripping point is effected by the air pressure.

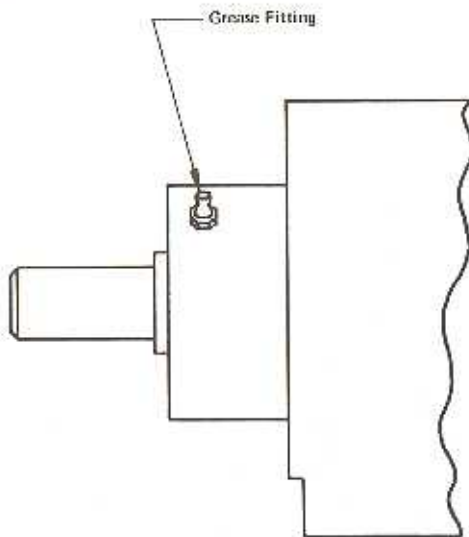

THE NEMA TYPE 4 & 9 CONSTRUCTION

This construction includes a double shaft seal with grease fitting for lubrication and purging of the area between the two shaft seals. Proper purging provides protection against an accumulation of abrasive dirt at the shaft entrance.

Inject a general purpose non-fibrous high-pressure lubricating grease every 500 to 1000 running hours as required to purge dirt and contaminants from the seals.

A sufficient quantity of grease should be injected at each purging operation to show a clean ring of grease around the shaft outside the seal.

Note that excess of grease due to purging is expelled out the front between shaft and lip of the outer seal. Excess grease and accumulated dirt should be wiped off after each grease purging.

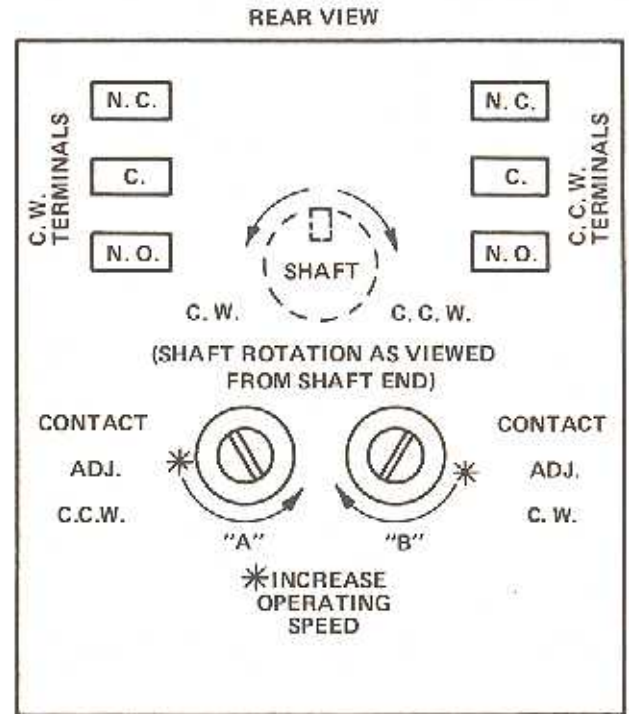

GENERAL

Euclid Type F Fluid/Eddy Current Speed Responsive Switches are low speed pilot devices. They are suitable for sensing rotation, for low speed conveyor sequencing, anti-plugging, monitoring, and safety interlocking applications where precise speed sensing is not required. These switches should only be used in applications where it is necessary to merely sense that rotation is taking place or the stoppage of rotation. The contacts are adjustable over a limited range and the operating point of the contacts, once adjusted, will vary slightly with changes in temperature. All applications requiring precise speed sensing and repetitive action should utilize either Euclid Bulletin 2210, Type C Flyweight, or Bulletin 2243, Type D Electronic Speed Responsive Switches.

Ref: 2260 also.

ADJUSTMENTS

Referring to the sketch above, the speed at which the snap-action contacts operate can be varied or adjusted by turning adjusting screws "A" and "B". Turning adjusting screw "A" counter clockwise will cause the C.C.W. contacts to operate at a higher speed. Turning adjusting screw "B" clockwise will cause the clockwise contacts to operate at a higher speed.

CAUTION!!!

Disassembly of these switches without factory authorization and instructions, **VOIDS** all applicable factory warranties and may result in damage to associated equipment.

TYPICAL ELEMENTARY SCHEMATICS

NON-REVERSING PLUGGING APPLICATION

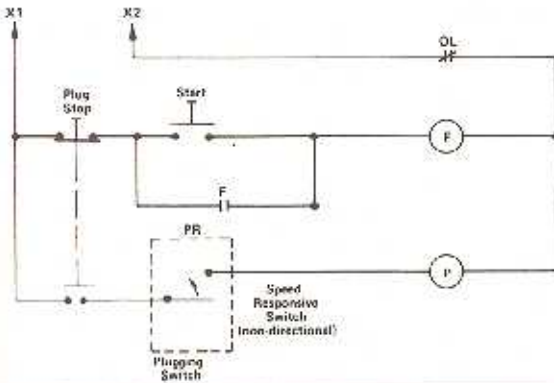
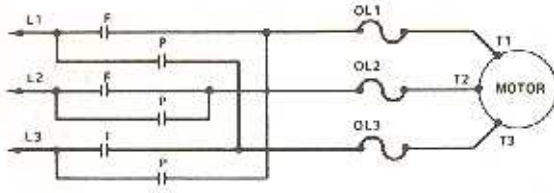

REVERSING PLUGGING APPLICATION

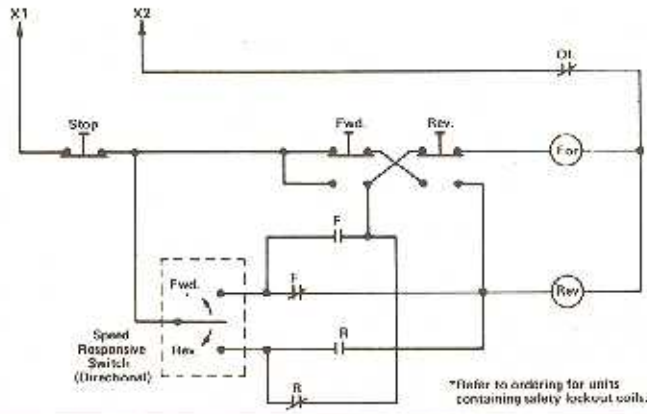
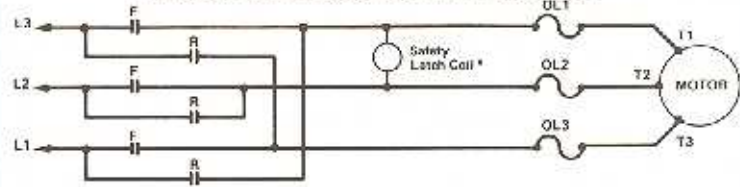

ANTI PLUGGING APPLICATION

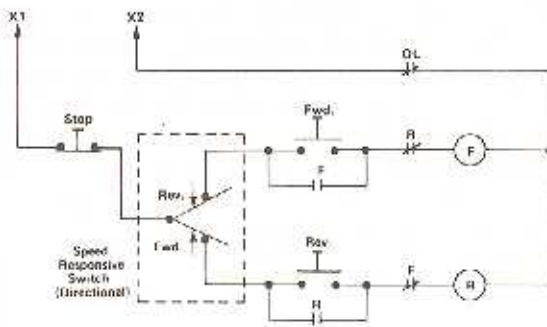
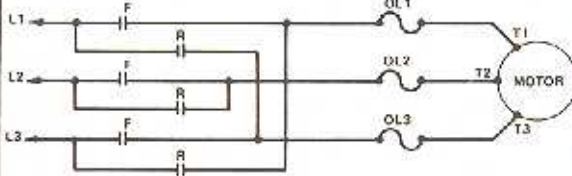

*UNDER-SPEED APPLICATION

(A) Non-Reversing Squirrel Cage induction motor drives

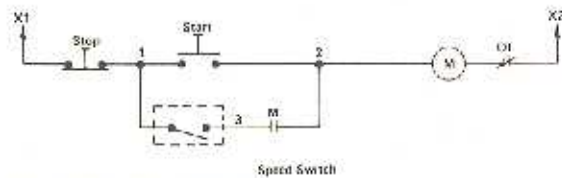

(B) Reversing Squirrel Cage induction motor drives

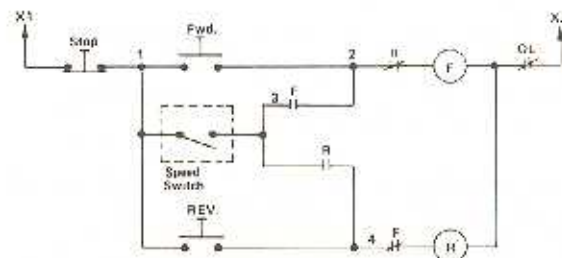
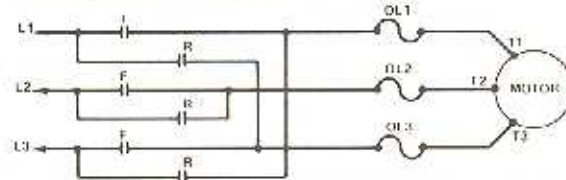

*NOTE: For over speed application use normally closed contacts in place of normally open contacts



industrial controls division