

---

**Hubbell Industrial Controls, Inc.**

*A subsidiary of Hubbell Incorporated*

4301 Cheyenne Dr.

Archdale, NC 27263

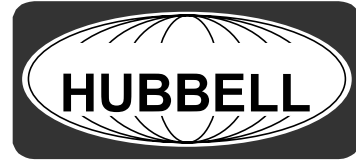

Telephone (336) 434-2800

FAX (336) 434-2803

---

**Instruction Manual  
Model LX3000  
Diesel Engine  
Fire Pump Controller**

Publication No. 203  
December 2003

# Instruction Manual

## LX3000 Diesel Fire Pump Controller

### Introduction

Model LX3000 engine controllers, automatically control the operation of diesel engine driven centrifugal fire pumps.

### Installation

1. Consult the Controller nameplate to verify that the DC voltage and ground polarity matches the engine battery. Also verify that the Controller AC power requirement matches available AC power.
2. Set the CONTROLLER ON / OFF - RESET SWITCH (inside controller) to the OFF position.

**CAUTION: Before drilling and punching holes in the cabinet for wiring connections, cover the components inside the cabinet with a protective covering. Debris may cause shorts or prevent operation of components.**

3. 2 holes are pre-punched in the top left side of the cabinet for conduit entry.
4. Connect the water line to the INLET side of the solenoid valve located on the left side of the Controller. Connect a drain line to the DRAIN side of the valve.
5. Connect Engine and Battery leads to TB1-1 through 12, connect the AC input to TB2-1 through 5, and connect required alarm contacts, all per the Field Connection drawing supplied with the controller.
6. Connect remote start normally closed input contacts (if used) to TB1-13 and battery common.
7. Connect lockout/low suction normally open input contacts (if allowed by local jurisdiction) to TB1-14 and battery common.

### Start Up Instructions

1. Adjust the pressure switch set points to meet water system requirements. The adjustment switches are located on the pressure switch control board, which is contained inside the pressure recorder enclosure. Open the pressure recorder door and loosen the two chart plate screws. Swing the chart plate outwards to gain access to the pressure switch control board. Set the STOP (HIGH) pressure setting on the upper three switches. Set the START (LOW) pressure setting on the lower three switches.

The Green LED on the left (Excitation Voltage) indicates that the Gauge Transducer is connected and power is available to the recorder. The middle LED (Relay Status) is bi-colored to indicate the status of the output relay contacts. If this LED is green, pressure is above the Stop pressure. If the LED is red, pressure is below the Start pressure. The red LED to the right (CAUTION) indicates the Start pressure is set higher than the Stop pressure and needs to be corrected.

2. Set the recorder time using a coin or screwdriver to turn the chart hub clockwise to the time indicator on the right side of the chart.
3. Remove the pen tip cover. If necessary, adjust the pen with the adjusting screw in the upper left corner of the dial plate. The recorder accuracy is 2% of scale.
4. Adjust the weekly Test Timer for the correct timing settings as follows:

### Set the time

- 1) Press the **Reset** button to clear the memory

- 2) Press and hold the ☰ clock symbol key during entire time setting procedure.
  - a) Press the **Day** key to bring the actual day of the week into display.
  - b) Press the **h** button to set the hours and the **m** button to set the minutes. If the keys are depressed for more than a second, the digits will advance rapidly.
  - c) Release the ☰ clock key when finished with the settings. The colon between the hours and minutes will be flashing indicating the timer has started.

## Programming

- 1) To set the Timer to start the engine once a week and run for a selected period of time. Press **Timer** once (do not keep depressed) The display will show "1ON and "--:--" for the time.
  - a) Press **h+ m+** to set the ON time.
  - b) Press **Day** to select the day of the week to run.
  - c) Press **Timer** key to enter program. The display will show 1"OFF".
  - d) Program OFF command using steps b-d above.
  - e) Press the ☰ key to return to time of day display.
- 2) To review the programming
  - a) Press **Timer** key to review the individual commands as preprogrammed, at any time, be brought consecutively into the display for revision or checking. Revisions are carried out by writing over the existing programs using the steps outlined above.

## 5. Set Control Settings – also see attached drawing for locations of items 5 through 11.

- a. Set the pressure switch start time delay (P/SWT DELAY SEC) on the Main Logic Board. The adjustment range is 0 to 15 seconds in 1 second increments.
- b. Set the AC Power Loss Delay Time on the Main Logic Board. The adjustment range is 0 to 90 seconds in 6 second increments.
- c. Set the Auto Stop time switch (SW6). Settings are none, 15 minutes or 30 minutes.
- d. Set the AC PowerLoss Start switch (SW4-2). Setting is on or off.
- e. Set the AC Loss Audible Alarm switch (SW4-1). Setting is on or off.

## 6. Controller Testing

- a. Verify pressure is above the Stop setting.
- b. Turn CONTROLLER ON / OFF SWITCH to the ON position

**Check the Test Timer to make sure that the Timer contacts are not about to close.** Closure of the Timer contacts during testing causes incorrect results.

## Manual Start

- a. Turn the AUTOMATIC / MANUAL SWITCH to the MANUAL position.
- b. Operate the MANUAL CRANK # 1 switch or the MANUAL CRANK # 2 switch. Release as soon as the engine starts.

- c. Turn the AUTOMATIC / MANUAL SWITCH to the AUTO position to stop the engine.

### **Automatic Engine Cranking in TEST**

- a. Disconnect engine wire from TB1-1 to prevent starting.
- b. Press the TEST PUSHBUTTON on the weekly TEST TIMER. The solenoid valve opens to discharge water, and the pressure switch contacts close to initiate cranking.
- c. The controller will crank the engine on battery 1 for 15 second intervals followed by 15 second rest period. It will then crank 15 seconds on battery 2, followed by 15 second rest period. This cycle is repeated 3 times, then cranking should will stop and the FAILURE TO START light comes on, the alarm sounds, and the Common TROUBLE relay is energized.
- d. Turn the CONTROLLER ON / OFF to the OFF position.
- e. Reconnect the starter motor cable(s).

### **Automatic Pressure Start**

- a. With the AUTOMATIC / MANUAL SWITCH in the AUTO position, lower the system pressure below the Start pressure.
- b. The engine will start and run until pressure is above the Stop setting and the STOP button is pressed, or the CONTROLLER ON / OFF SWITCH is turned to the OFF position, or the optional Automatic Stop Timer, typically set for 15 or 30 minutes, stops the engine.

### **Battery Failure Test**

- a. With the AUTOMATIC / MANUAL SWITCH in the AUTO position, disconnect the battery wire on TB1-6. The BATTERY NO.1 FAILURE LED should come on within two minutes. The alarm should sound and the Common TROUBLE relay should energize. Reconnect the wire to TB1-6. Reset the alarm by turning the CONTROLLER ON / OFF - RESET SWITCH from CONTROLLER ON to OFF - RESET position then back to the CONTROLLER ON position.
- b. Disconnect the battery wire on TB1-8. The BATTERY NO.2 FAILURE LED should come on within two minutes. The alarm should sound and the Common TROUBLE relay should energize. Reconnect the wire to TB1-8. Reset the alarm by turning the CONTROLLER ON / OFF - RESET SWITCH from CONTROLLER ON to OFF - RESET position then back to the CONTROLLER ON position.

### **Charger Failure Test**

- a. With the AUTOMATIC / MANUAL SWITCH in the AUTO position, disconnect the wire on TB1-6, and disconnect the AC input to charger(s) no. 1. BATTERY NO.1 FAILURE & CHARGER 1 FAILURE light should come on within two minutes. The alarm should sound and the Common TROUBLE relay should energize. Reconnect the wire to TB1-6, reset the alarm by turning the CONTROLLER ON / OFF - RESET SWITCH from CONTROLLER ON to OFF - RESET position then back to the CONTROLLER ON position.
- b. Repeat the above for battery No. 2 & charger(s) no. 2, using the wire on TB1-8

### **Low Oil Pressure Test**

- a. With the AUTOMATIC / MANUAL SWITCH in the AUTOMATIC position, start the engine by depressing the TEST PUSHBUTTON on the Weekly Timer.

- b. Wait 10 seconds for the Oil Pressure Delay interval to expire, then momentarily jumper TB1-4 to TB1-11. The alarm will sound and the Common Trouble relay will energize. The LOW OIL PRESSURE LED will come on and remain on after the engine stops.
- c. Turn the CONTROLLER ON / OFF - RESET SWITCH to the OFF - RESET position then back to the CONTROLLER ON position to reset the LOW OIL PRESSURE Alarm.

### **High Water Temperature Test**

- a. WITH the AUTOMATIC / MANUAL SWITCH in the AUTOMATIC position, start the engine by depressing the TEST PUSHBUTTON on the Weekly Timer.
- b. Momentarily jumper the TB1-5 to TB1-11. The alarm will sound and the Common Trouble relay will energized. The HIGH WATER TEMPERATURE LED will come on and remain on after the engine stops.
- c. Turn the CONTROLLER ON / OFF - RESET SWITCH to the OFF - RESET position then back to the CONTROLLER ON position to reset the HIGH WATER TEMPERATURE Alarm.

### **Optional Remote Start**

- a. With the AUTOMATIC / MANUAL SWITCH in the AUTO position, open the remote start contacts, TB1-12 & 13, starting the engine.
- b. Turn the CONTROLLER ON / OFF SWITCH to the OFF position to stop engine.
- c. Close the remote start contacts.

### **Optional AC Power Failure Start (if enabled)**

- a. With the AUTOMATIC / MANUAL SWITCH to the AUTO position, disconnect the AC power supply to the Controller.
- b. After the pre-set time delay (0 to 90 seconds) the engine will start. The audible alarm should sound, AC POWER LOSS LED will come on, and both the Common TROUBLE and AC POWER LOSS relays will energize.
- c. Reconnect the AC power to reset the alarms.
- d. Turn the CONTROLLER ON / OFF - RESET SWITCH to the OFF - RESET position to stop the engine.

## **End of Startup Testing**

### **Switches**

- 1. Automatic/Manual – Selects automatic or manual mode.
- 2. Crank Battery 1 – Cranks the engine using battery 1.
- 3. Crank Battery 2 – Cranks the engine using battery 2.
- 4. Stop – Stops the engine in automatic if there are no start conditions and control switch is in “Auto”.
- 5. Normal/ Silence – Silences optional pump house alarm only. Standard alarms required NFPA 20 cannot be silenced.

## Troubleshooting

 **DANGER**

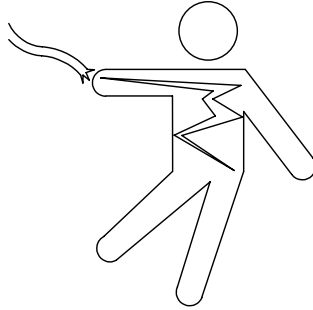

Hazardous voltage will shock, burn, or cause death. Do not touch until ALL power is disconnected.

**WARNING: Disconnect AC power to the Controller before servicing to prevent shock or accident hazard.**

Before troubleshooting, perform the following checks:

- a. visual inspection for physical damage.
- b. ensure that all switches are in the normal operating position.
- c. ensure that the engine controls are set for operation.
- d. ensure that all wiring connections are secure.
- e. review the Startup procedure for proper operation to help determine if one of the system boards is faulty.

**Table 6-1 Troubleshooting**

<b>Condition</b>	<b>Possible cause</b>	<b>Checks</b>	<b>Action</b>
Engine does not crank with MANUAL START	Batteries	Voltmeters should read at least 12.5 or 25 VDC Check each battery in bank for correct voltage	Check electrolyte Test and recharge bad battery(s) Replace battery(s) with good battery(s)
	Battery circuits	Check battery and ground connections  Check battery voltage Check battery cables and connections	Clean and tighten connections as necessary
		Check engine starter cables and connections	Clean and tighten connections as necessary
Engine does not crank using MANUAL START - Battery No. 1	MANUAL CRANK #1 switch	Check battery voltage while holding MANUAL CRANK #1 switch	Refer to schematic Use volt/ohm meter to determine which component is faulty
Engine does not crank using MANUAL START - Battery No. 2	MANUAL CRANK #2 switch	Check battery voltage while holding MANUAL CRANK #2 switch	Refer to schematic Use volt/ohm meter to determine which component is faulty
If voltage checks indicate batteries and circuits OK then the engine starter or the pilot (or starting) contactors are faulty.			

**Table 6-1 Troubleshooting (Continued)**

<b>Condition</b>	<b>Possible cause</b>	<b>Checks</b>	<b>Action</b>
Engine cranks but does not start	Water and fuel solenoid circuits	Check battery voltage  Check WATER and FUEL Relay	Clean and tighten connections  Replace Engine Relay Board Replace Main Logic Board
	Water and fuel solenoid valves	Check solenoids Check fuel and water lines  Check engine, fuel, fuel filter	Replace solenoid(s) or valve(s)  Complete necessary engine repairs
Engine continues to crank after starting AUTOMATIC / MANUAL SWITCH set to AUTO Or Test Mode Active	Engine Crank Relay or Main Logic Board faulty  Engine Run signal absent  Magnetic Pickup or circuit faulty	Check Crank 1 and Crank 2 relays on Engine Relay Board  Check Run LED on Main Logic Board  Check for Pickup signal at Main Logic Board	Replace Engine Relay Board. Replace Main Logic Board  Replace magnetic Pickup
Engine does not crank in TEST or AUTO  Engine cranks with MANUAL START  Water and fuel solenoids energized	Relay, or Main Logic Board faulty	Check Crank 1 and Crank 2 relays on Engine Relay Board	Replace Engine Relay Board  Replace Main Logic Board
Engine does not crank in AUTO when water pressure decreases  Engine cranks with MANUAL START	Pressure Switch, or Main Logic Board faulty	Press P/S TEST button	If cranking cycle begins refer to Appendix B Pressure Switch / Recorder  Replace Main Logic Board

**Table 6-1 Troubleshooting (Continued)**



<b>Condition</b>	<b>Possible cause</b>	<b>Checks</b>	<b>Action</b>
Engine stops without having to press STOP button or before run time is complete	Water and Fuel solenoid circuits and valves, or  Main Logic Board faulty	Check Water and Fuel Relay	Replace Engine Relay Board  Replace Main Logic Board
Test Timer or Test Pushbutton does not start engine AUTOMATIC / MANUAL SWITCH in AUTO  Engine starts after pressure drop	No power to solenoid drain valve, or faulty valve  Faulty Timer	Check Water Dump Solenoid Relay  Check solenoid valve Check Timer program	Replace Engine Relay Board  Replace valve Replace Timer
Alarm does not sound, Associated light not on	Alarm faulty LED Display faulty  Main Logic Board faulty	Check alarm	Replace alarm Replace LED Display  Replace Main Logic Board
No BATTERY FAILURE indication  Engine cranks	Power Sense Board faulty  Main Logic Board faulty	Check Power Sense Board	Replace Power Sense Board  Replace Main Logic Board

**Table 6-1 Troubleshooting (Continued)**

<b>Condition</b>	<b>Possible cause</b>	<b>Checks</b>	<b>Action</b>
------------------	-----------------------	---------------	---------------

<p>No HIGH ENGINE TEMP indication</p>	<p>Water temperature switch</p>	<p>Connect a jumper across the water temperature switch on the engine Start engine with MANUAL START switch Verify that engine starts and alarm sounds</p>	<p>Replace water temperature switch</p>
<p>Engine overspeed does not stop engine No indication</p> <p>Indication but engine does not stop under overspeed simulation</p>	<p>Faulty or mis-adjusted magnetic sensor</p> <p>Main Logic Board faulty</p>	<p>Check sensor installation</p>	<p>Replace sensor</p> <p>Replace Main Logic Board</p>
<p>Cranking and rest periods greater than or less than <math>15 \pm 2</math> sec.</p> <p>Engine cranks less than six times</p> <p>Engine continues to crank in AUTO position but does not start</p>	<p>Main Logic Board faulty</p>	<p>Check Main Logic Board</p>	<p>Replace Main Logic Board</p>
<p>Controller does not crank engine with good battery</p> <p>Engine cranking and indication OK</p>	<p>Engine Relay Board faulty</p> <p>Main Logic Board faulty</p>	<p>Check Engine Relay Board</p> <p>Check Main Logic Board</p>	<p>Replace Engine Relay Board</p> <p>Replace Main Logic Board</p>

**Table 6-1 Troubleshooting (Continued)**

<b>Condition</b>	<b>Possible cause</b>	<b>Checks</b>	<b>Action</b>
Engine does not crank with Remote Start Crankes when water pressure decreases	Remote switch faulty Main Logic Board faulty	Check switch and switch circuits Check Main Logic Board	Repair circuits Replace switch Replace Main logic Board
Engine does not start after AC power loss	Power Sense Board or Main Logic Board faulty	Check Power Sense Board Check Main Logic Board	Replace Power Sense Board Replace Main Logic Board
Engine does not stop with optional AUTO STOP	Another start condition present Main Logic Board faulty	Check controller start conditions Check Main Logic Board	Replace Main Logic Board

**Note**

The above troubleshooting guide does not represent all possible conditions or problems. If the above information can not resolve a problem, consult the factory or a local representative for further assistance.



## Pressure Switch / Recorder

### Changing the Chart Paper

First, locate the “change chart” button (#3) located in the upper left corner of the recorder. Press and hold this button for approximately one (1) second until the pen begins to move to the left of the chart. Wait until the pen has moved completely off of the chart. To remove the chart paper, unscrew (counter-clockwise) the “hub” knob at the center of the chart. Remove the old chart paper and position the new one so that the correct time coincides with the time line groove on the chart plate. Refer to Figure 3 for the location of the time line groove on the left side of the chart plate. Re-attach the chart “hub” knob and screw securely (by hand) against the chart. Press the “change chart” button (#3) again for approximately one (1) second until the pen begins to move back onto the chart paper.

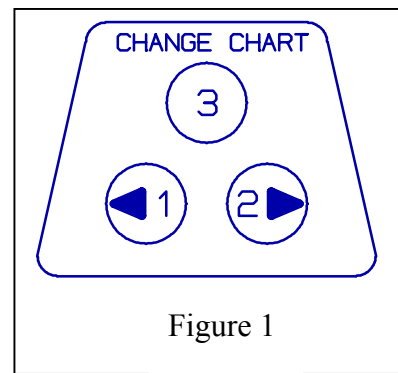

### Pen replacement

Slide the used pen cartridge off the pen arm. Slide on new cartridge and remove tip cover.

To replace the pen, loosen the two screws that hold the pen arm and the pen cartridge, and metal pen arm be removed as an assembly. Refer to Figure 3 for the location of the pen arm screws. Unsnap the plastic “U” clip tab of the pen cartridge from the metal pen arm (see Figure 2), remove and discard the old pen cartridge. Replace the new cartridge by opening the hinge and snapping it securely around the metal pen arm.

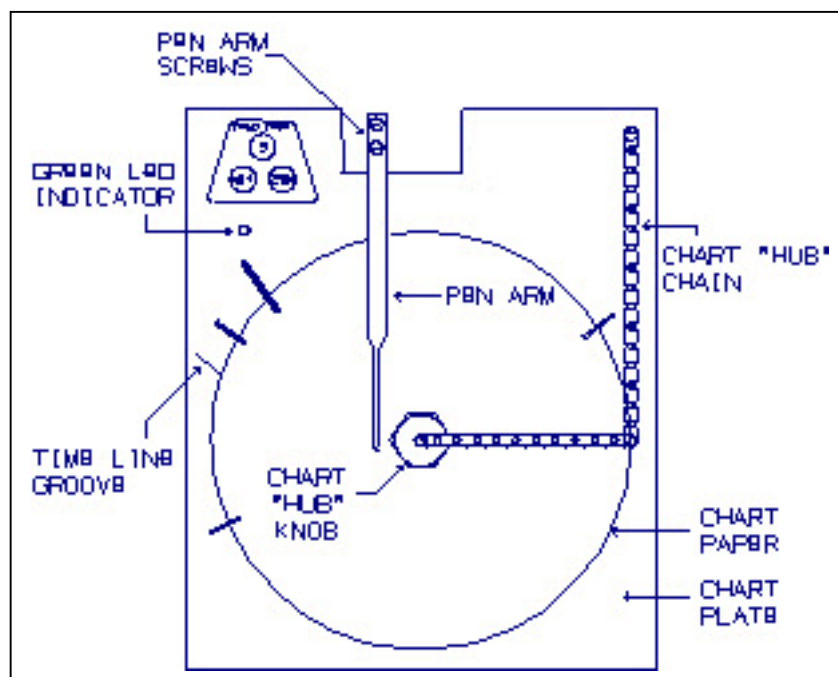
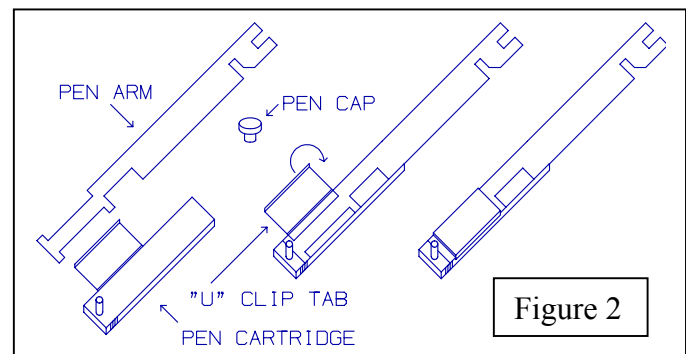

**Figure 4**  
**Pressure Settings**

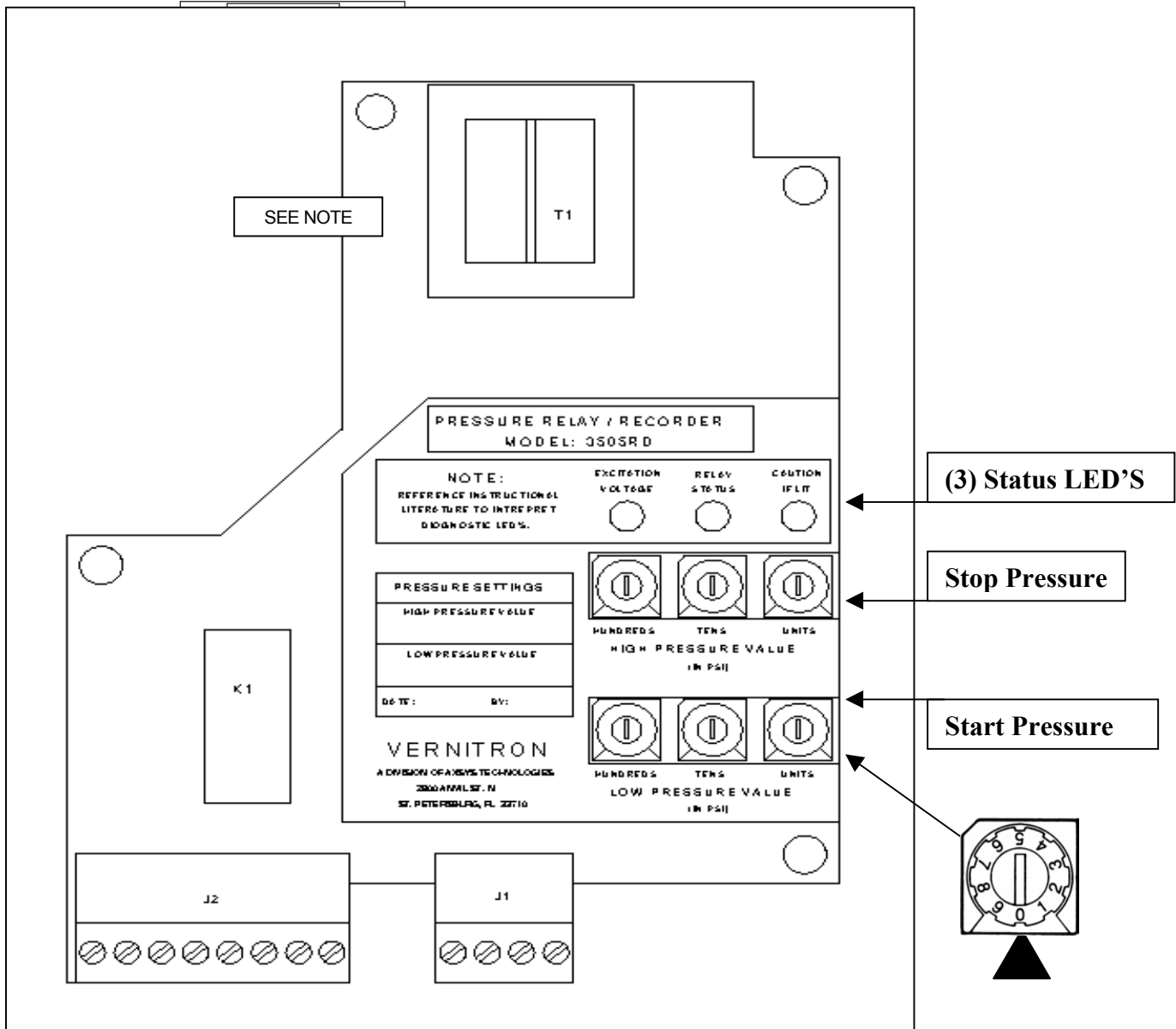

# Battery Charger

## Introduction

The Power Sense Board monitors the charging current and voltage of both chargers. LED's indicate that the chargers are supplying current output, that the battery / charger voltage is above 90%, and that AC Power is available to power the chargers.

## Specifications

### LED Indication

READY, green	On indicates float condition
CHARGING, yellow	On indicates charge in progress
CHARGE CURRENT, green	Charging current greater than or equal to current indicated

**WARNING: Lead acid batteries generate explosive gases during normal operation.**

**Precautions: Do not work alone.**

**Wear eye protection and protective clothing.**

**Have soap and water available in case of skin contact with acid.**

**If acid enters eye, immediately flush eyes with cold running water for ten minutes and get medical attention.**

If problems develop, check all connections and clean the battery terminal connections. Use the LED indicators on the chargers and the LOBC as an aid to determine the cause of any potential problems. Return faulty chargers to the factory.

**CAUTION: Always disconnect the AC power source before disconnecting the batteries when performing maintenance.**

## Troubleshooting Chart

Symptom	Possible cause	Solution
All charger LED's off, cabinet CHARGER FAILURE indicating light on	1) No AC power 2) Charger AC fuse blown	1) Check for 120 V Charger power 2) Hubbell recommends that the charger be returned for repair
Charge Current LED's scroll,* cabinet CHARGER FAILURE indicating light on	1) Battery connections reversed, 2) Charger DC fuse blown	1) Check battery connections 2) Hubbell recommends that the charger be returned for repair

\* The charger LED's scroll in order as follows: Charge Current LED's 10 A to 2 A, Charging, Ready.

## Troubleshooting Chart (Continued)

Symptom	Possible cause	Solution
Charging LED blinking,	Battery voltage high due to Engine charging circuit supplying charging voltage above control charger value.	Troubleshoot engine charging circuit
10 A Charge Current LED flashing	Charger stopped charging due to high temperature	Allow charger time to cool Improve ventilation in area
Ready LED does not come on, Batteries do not charge fully	1) Battery capacity too high 2) Excessive load on batteries 3) Short to ground 4) Battery terminals corroded 5) Battery has faulty cell	1) Check battery rating, must be less than 200 Ah 2) Verify load is normal 3) Clear the short 4) Clean battery terminals 5) Check battery/Replace

Contact the local Hubbell representative to request additional information, parts, or drawings.



# Location and Description of Control Settings

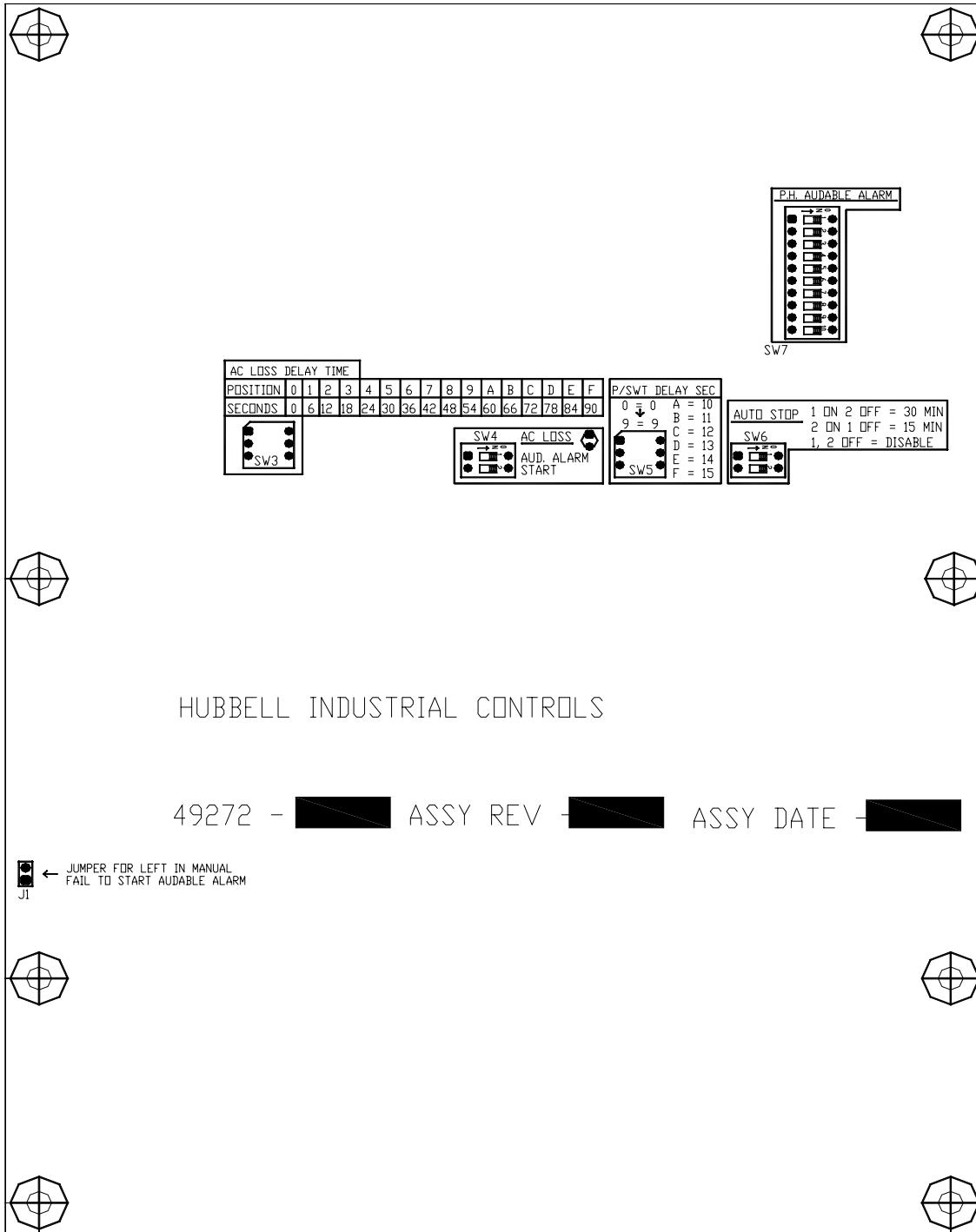

AC LOSS DELAY TIME

POSITION	0	1	2	3	4	5	6	7	8	9	A	B	C	D	E	F
SECONDS	0	6	12	18	24	30	36	42	48	54	60	66	72	78	84	90



P/SWT DELAY SEC

0	A = 10
1	B = 11
2	C = 12
3	D = 13
4	E = 14
5	F = 15



P.H. AUDABLE ALARM

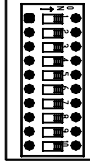

SW7

AUTO STOP

1 ON 2 OFF	= 30 MIN
2 ON 1 OFF	= 15 MIN
1, 2 OFF	= DISABLE

