

Assembly & Installation Instructions

CAUTION: Read instructions carefully and turn electricity off at main circuit breaker panel before beginning installation.

4621, 4622, 4623, 4625

WARNING - If any Special Control Devices are used with this Fixture, Follow the Instructions Carefully to assure full compliance with N.E.C. requirements. If there are any questions, contact a Qualified Electrical Contractor.

CAUTION - All glass is fragile, use care when handling Glass component(s) and or Lamp(s).

WARNING - This product contains chemicals known to the State of California to cause cancer, birth defects and /or other reproductive harm. Thoroughly wash hands after installing, handling, cleaning, or otherwise touching this product.

ASSEMBLY STEPS:
PASOS PARA ENSAMBLAR:
MODE D'ASSEMBLAGE:

B, C, G & T
(NOT FURNISHED)
(NO INCLUIDA)
(NON FOURNIE)

1. D,E → A
2. B,A → C
3. U,V,H → D
4. V → H
5. F → M
6. M → N
7. L → M
8. K,J → L
9. L → H
10. F → L,K,J,H,D
11. F → G
12. Q,R → P
13. S → P

TO LOCK
 APRETAR
 À VERROUILLER

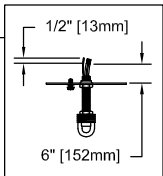

ADJUST HEIGHT WITH "D"
 U → A (TO LOCK)
 AJUSTAR LA ALTURA CON "D"
 U → A (APRETAR)
 RÉGLEZ LA HAUTEUR AVEC "D"
 U → A (À VERROUILLER)

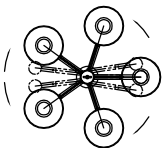
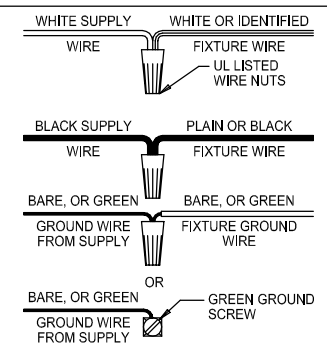

P4623

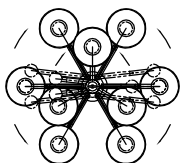

P4625

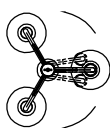

P4621

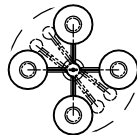

P4622

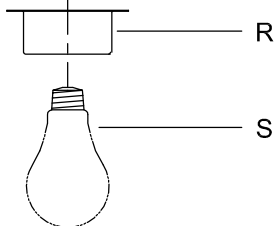
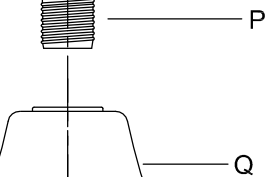
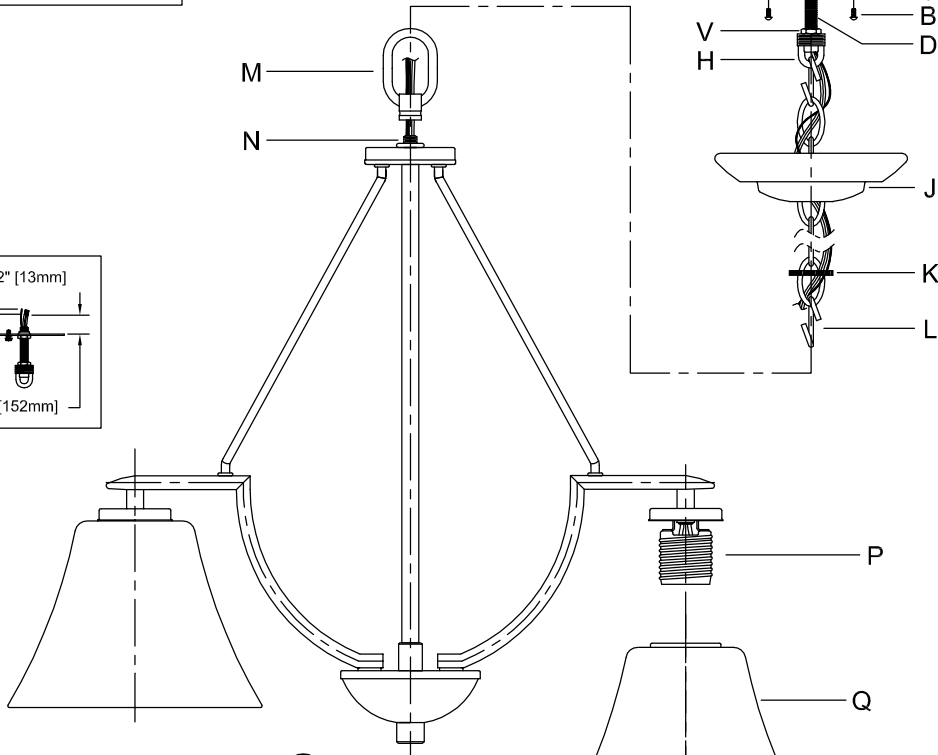
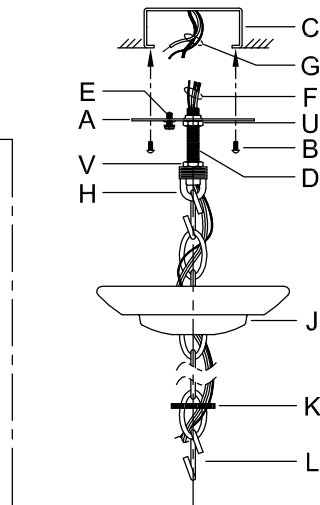
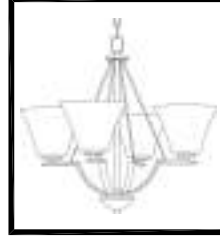

DIAGRAM - A

- Adjust Arms, if required, as shown in diagram A.
- Ajuste los brazos, como necesario, según el diagrama A.
- Ajustez les branches, comme nécessaire, selon le diagramme A.

Instrucciones de ensamblaje e instalación

Precaución: Lea cuidadosamente las instrucciones y desconecte la electricidad del cortacircuitos principal antes de iniciar la instalación.

ADVERTENCIA - SI CON ESTE APLIQUE SE USAN DISPOSITIVOS DE CONTROL ESPECIALES, DEBE SEGUIR LAS INSTRUCCIONES DETALLADAMENTE PARA GARANTIZAR EL CUMPLIMIENTO ESTRICTO CON EL CODIGO NACIONAL DE ELECTRICIDAD (N.E.C.) SI TIEN PREGUNTAS, COMUNIQUESE CON UN ELECTRICISTA CALIFICADO.

PRECAUCIÓN - El vidrio es frágil; tenga cuidado al manipular la(s) bombilla(s) o los otros componentes de vidrio.

ADVERTENCIA - Este producto contiene sustancias químicas que según el Estado de California causa cáncer, defectos de nacimiento y (o) daño al sistema reproductor. Lavarse bien las manos después de instalar, manipular, limpiar o tocar de manera alguna este producto.

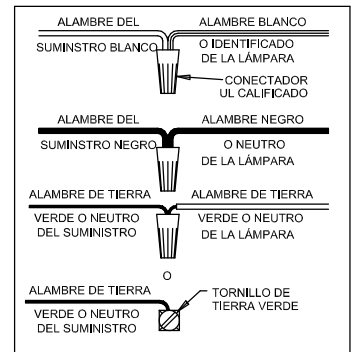

Instructions d'Assemblage et Installation

Mise en garde: Lire les instructions avec soin et couper le courant au disjoncteur central avant de commencer l'installation.

AVERTISSEMENT - S'ILS Y A DES DISPOSITIFS DE CONTROLE SPECIAUX SONT UTILISES EN CONJONCTION AVEC CE LUMINAIRE, SUIVRE SCRUPULEUSEMENT CES INSTRUCTIONS POUR ASSURER LA CONFORMITE N.E.C. POUR TOUTE ASSISTANCE SUPPLEMENTAIRE, DEMANDER CONSEIL AUPRES D'UN ELECTRICIEN QUALIFIE.

MISE EN GARDE - Le verre est toujours fragile; maniez l'(les) ampoule(s) et les autres éléments de verre avec prudence.

AVERTISSEMENT - Ce produit contient des composants chimiques qui selon L'état de Californie provoquent un cancer, des infirmités de naissance et (ou) du mal au système reproductif. Il faut laver les mains soigneusement après avoir installé, manipulé, nettoyé, ou autrement touché ce produit.

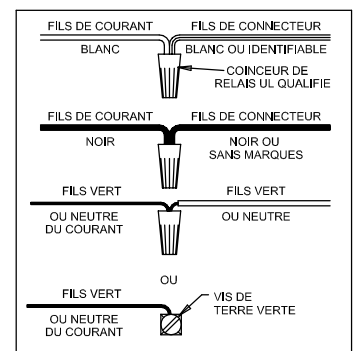

REVISION TRACKING HISTORY

REV	DESCRIPTION	DATE	INIT.	ECN
A	RELEASED NEW	04/08/11	KJH	1104005
B	REVISED TO USE ONE PIECE SOCKET RING	04/18/11	KJH	1104010
C	REVISED ASSEMBLY STEPS	05/26/11	HC	1105019
D	CHANGED "T" TO "S" IN UNFURNISHED BOX	07/25/11	KJH	1107027
E	UPDATED FOR "DI" FIXTURES	06/24/13	SRG	1306033