



ISTZ28S3/S4

Installation Instructions

Guide TZS OUTDOOR SERIES

Cold Shrink Outdoor Termination for 25kV & 28KV Copper Tape Shielded, Lead Sheathed, Unishield and Drain Wire Shielded Power Cables

DESCRIPTION

Hubbell Cold Shrink Terminations are designed for terminating solid dielectric - shielded medium voltage cables. Removal of the inner support core allows the termination to shrink evenly over the cable, creating a void free interface between the cable and termination housing. Hubbell Cold Shrink Terminations meet the requirements of IEEE Standard 48 - latest revision.

- 28kV Class: 165kV BIL
- Class 1 Termination

INSTALLATION TOOLS

- Crimp Tools & Dies
- Hand Tools

CONTENTS OF PACKAGE

- (1) Silicone Rubber Termination
- (1) Set of Mastic Strips
- (1) Ground Kit
- (1) Instruction Sheet
- (1) Cutback Template
- (1) Connector (optional)

No Silicone Grease Required

KIT NO.	Conductor Size Range		Insulation Diameter		Jacket OD Max		Packaging Kits/Box
	OUTDOOR	MIN	MAX	IN	MM	IN	
15kV 100% and 133%							
28TZ2S	1/0	250	0.71-1.26	18-32	1.50	38	3
28TZ3S	4/0	500	0.83-1.34	21-34	1.65	42	3
28TZ4S	350	750	1.04-1.54	26.5-39	1.97	50	3
28TZ5S	750	2000	1.34-2.19	34-55.5	2.83	72	3
25kV & 28kV 100% and 133%							
28TZ2S	#2	4/0	0.71-1.26	18-32	1.50	38	3
28TZ3S	1/0	250	0.83-1.34	21-34	1.65	42	3
28TZ4S	250	500	1.04-1.54	26.5-39	1.97	50	3
28TZ5S	500	1500	1.34-2.19	34-55.5	2.83	72	3

Important: Read these instructions thoroughly before operating the system. Be sure that the terminations are rated for their intended energized use.

DANGER

All associated apparatus must be de-energized before performing any installation. Do not touch or move energized product by hand. Be sure that the connectors are rated for the intended application. Failure to follow this instruction may result in serious or fatal injury, as well as damage to the product.

CAUTION

The equipment covered by these instructions should be installed, operated and serviced only by competent personnel familiar with safety practices. This instruction is written for such personnel and is not intended as a substitute for adequate training and experience in safe procedures for this type of equipment.

These instructions do not purport to cover all details or variations in equipment nor to provide for every possible contingency to be met in connection with installation, operation or maintenance. Should further information be desired or should particular problems arise which are not covered sufficiently for the purchaser's purposes, the matter should be referred to Hubbell Power Systems, Inc



Product Selection Confirmation

Check kit selection to ensure that you are installing the proper kit on the cable(s) to be terminated. If using the termination on the smallest or largest conductor size compare the cable dimensions to those of the kit.

CABLE PREPARATION INSTRUCTIONS

1. Shape or train cable to its termination point and cut off any excess cable.
2. Determine crimp lug barrel depth and add 1/4" for "L" dimension

Note: The "L" dimension is the connector barrel depth plus 1/4" (6.4mm). If no connector is used: L = 2" (51mm).

3. Cable Cut Back Dimensions

Prepare cable to the dimensions shown below:

- a. "L" = lug barrel depth + 1/4(6.4mm) = _____
- b. Jacket Cut Back length = 13 1/2" (342mm) + "L" = _____

4. Remove Cable Jacket

Remove cable jacket according to the "Jacket Cut Back Length" determined in step 3b.

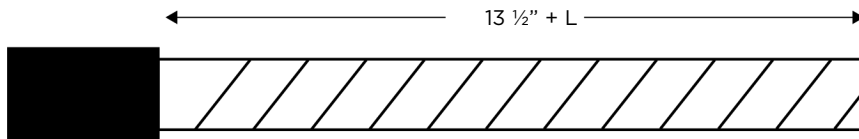

5. Remove insulation to expose the bare conductor to "L" dimension. Cut squarely making sure not to nick the conductor
6. Remove semi-con layer to 11 1/2" (292mm), to expose the insulation, as shown below. Edge of semi-con layer should be smooth and square. Do not nick the insulation while removing semi-con layer.

Note: If any nicks are present in the insulation or conductor, cut off damaged portion of cable and return to step 1

CABLE PREPARATION INSTRUCTIONS

Metallic Tape & Lead Sheathed

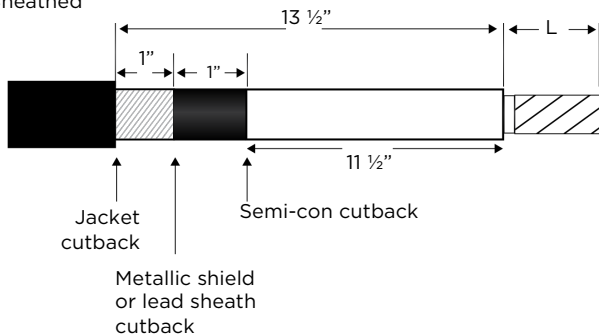

Braided Shield & Uni-shield

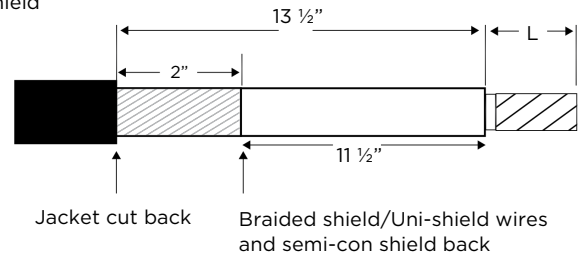



- Install the connector in accordance with the manufacturer's instructions. If the step between the insulation and connector is 1/8" or more, bevel the edge with a 1/8" chamfer.

Note: A copper tape shielded cable is illustrated here. The procedures are the same for all cables except where specifically addressed in this installation guide.



- Clean the cable insulation thoroughly with suitable solvent. If necessary, remove imbedded conductive particles with nonconductive abrasive cloth.

Note:
All remnants of semi-con layer must be removed. There should be no contaminants on the cable insulation layer.

If abrasive must be used:

- Use on insulation only, not on semi-con layer
- Use ONLY aluminum oxide abrasive; grit 120 or finer.
- Take care not to reduce the cable insulation diameter below that allowed by the kit.

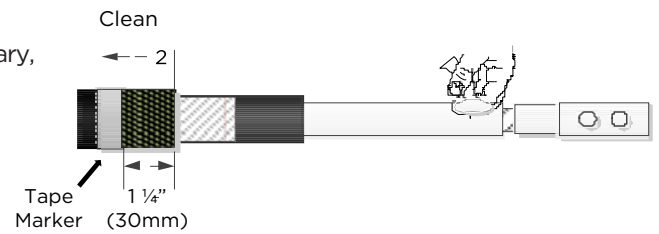

Clean the cable jacket for 2" (50mm) approximately from cable jacket cut back.

Place a tape marker at 1 1/4" or 30mm from edge of jacket cutback.

- Lightly stretching to approximately 3/4 of its width, wrap the red mastic strip around the cable jacket at the edge of the cutback. Ensure there is a clear gap between the tap marker and mastic strip. Do not apply more than 2 layers.

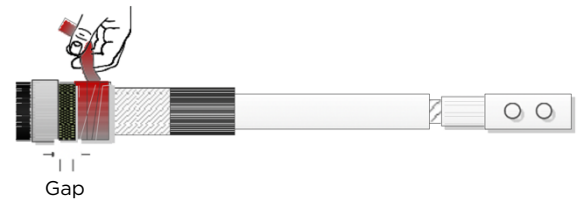



10. a. Metallic Tape Shielded and Unishield.

Butt the solder blocked end of the braid (concave side up) against the cable jacket so that when folded back the radius in the braid will conform to the jacket.

Position spring clamp next to jacket cut back and make two wraps of the spring clamp around the braid.

Fold the braid back along the jacket and finish wrapping the spring onto the braid. Confirm that the solder block is over the red mastic strip.

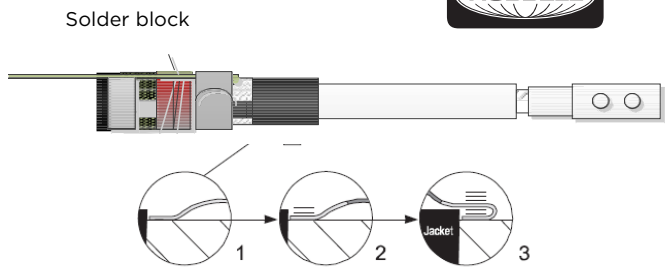

b. Braid Wire Shielded and Lead Sheathed.

Bend leading edge of shield wires back upon themselves and lay next to jacket edge.

Position end of braid and spring clamp against jacket cut back and apply braid.

Fold the braid back along the jacket and finish wrapping the spring onto the braid. Confirm that the solder block is over the mastic strip.

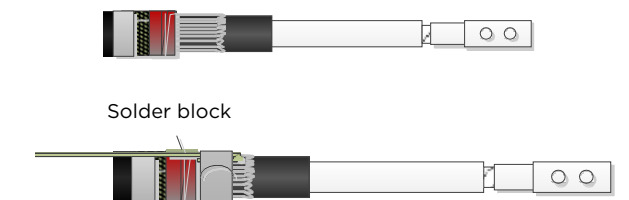

11. Tighten the spring and wrap a stretched layer of PVC tape in the direction of the spring. Continue to wrap 2 layers over any exposed wires or copper tape. Ensure there is a minimum of 3/4" (19mm) of semi-con screen exposed.

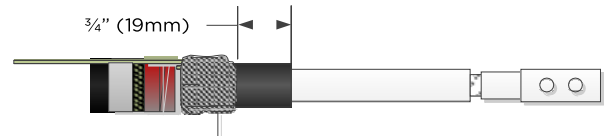

12. Apply red sealant mastic for only the conductor sizes shown in table 3:

Due to variations in connector types, some of the smallest conductor sizes used in the application ranges require extra sealant mastic to fill the transition over the connector barrel. Build up the lug barrel diameter to that of cable insulation using the supplied 1" wide red tape sealant mastic strips. Overlap at least 1/2" (10mm) onto insulation.

Table 3 - Sizes requiring additional sealant

Size	Conductor
28TZ3Sxx	1/0, 2/0
28TZ4Sxx	250, 350

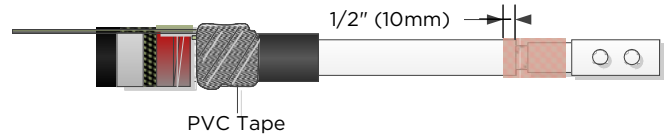

13. Position cold shrink termination at the edge of the (1 1/4 ") tape marker. Slowly pull ripcord counterclockwise, holding the body of the termination in place at the tape mark until securely recovered over braid. Hold termination while pulling remainder of cord. Do not put tension on the termination while pulling the remainder of the rip cord. After pulling the cord, ensure all rain sheds are open, and manually open any shed that is not fully extended.

Installation is complete.

NOTE: The ripcord material can be recycled as:

