

Installation Instructions

GENERAL INFORMATION

Enc. Type rating 4X when devices connected and used with Hubbell Single Pole Devices.

Enc. Types rating 3R, 3RX, 12 when cover closed.

CAUTION: Ensure adequate clearance between conductor components & enclosure fasteners.

INSTALLATION

- Maximum enclosure thickness 1/4" (6.33mm)
- Receptacle can be front or rear mounted to the enclosure.
- Cut the hole pattern shown in the enclosure mounting surface.

1. Position weatherproof cover onto receptacle with hinge on top & cover down.
2. Secure weatherproof cover & receptacle to enclosure with user-supplied #10 fasteners.
3. Tighten fasteners to 10 in. lbs. (1.13 Nm) for weatherproof base. Do not over-tighten.

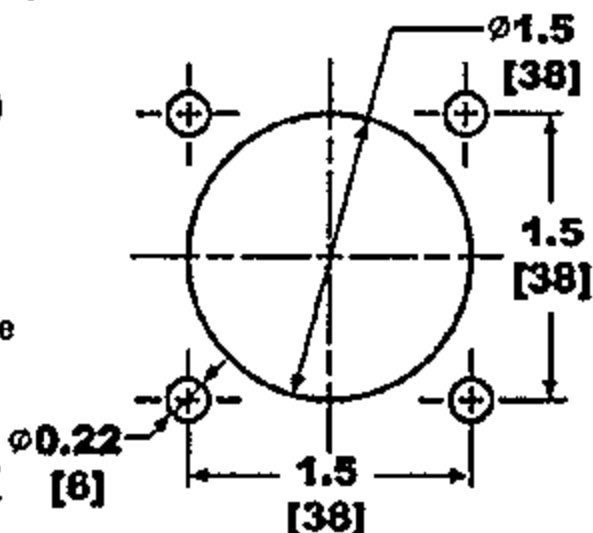
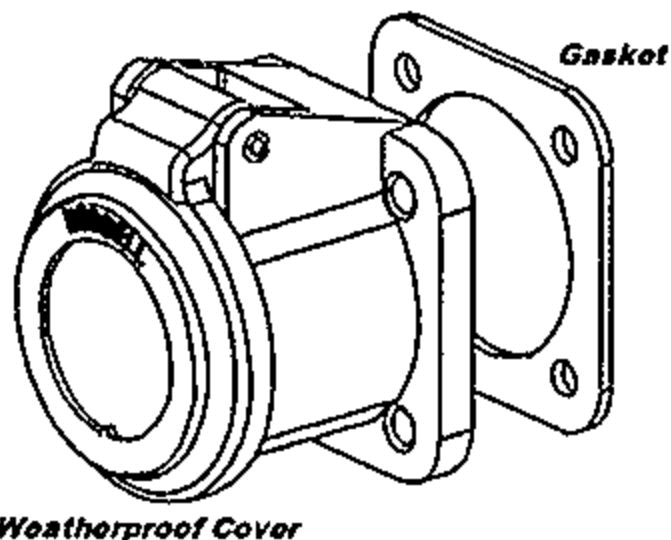

Wiring Device-Kellems
Hubbell Incorporated (Delaware)
Shelton, CT 06484
1-800-288-6000
www.hubbell-wiring.com