



Installing and Testing an Outlet Branch Circuit AFCI

Please read this leaflet completely before getting started.

PDS2605 (Page 1) (English) 01/14

CAUTION

- To prevent severe shock or electrocution always turn the power OFF at the service panel before working with wiring.
- Use this Outlet Branch Circuit AFCI with copper or copper-clad wire. Do not use it with aluminum wire.
- Do not install this Outlet Branch Circuit AFCI on a circuit that powers life support equipment because if the AFCI trips it will shut down the equipment.
- Must be installed in accordance with national and local electrical codes.
- This Outlet Branch Circuit AFCI must be installed as the first outlet in the branch circuit.

1. What is a Outlet Branch Circuit AFCI?

An Outlet Branch Circuit AFCI is different from conventional receptacles. It is intended to provide protection to branch circuit wiring, cord sets, and power-supply cords connected to it against the unwanted effects of arcing. In the event of an arc fault, an AFCI will trip and quickly stop the flow of electricity to mitigate the effects of the arcing that may have posed a risk of fire ignition if the arcing persisted.

Definition of an arcing fault:

An arcing fault is an unintentional arcing condition in a circuit. Arcing occurs as a normal condition in some motors or when a switch opens. An example of unintentional arcing would be arcing that occurs due to severed power-supply cord conductors.

An Outlet Branch AFCI does not protect against circuit overloads, short-circuits or against shock hazards.

NOTE:

The AFCI's contain a lockout feature that will prevent RESET if:

- There is no power being supplied to the AFCI.
- The AFCI is miswired due to reversal of the LINE and LOAD leads.
- The AFCI cannot pass its internal test, indicating that it may not be able to provide protection in the event of an arc fault.

2. The AFCI's features

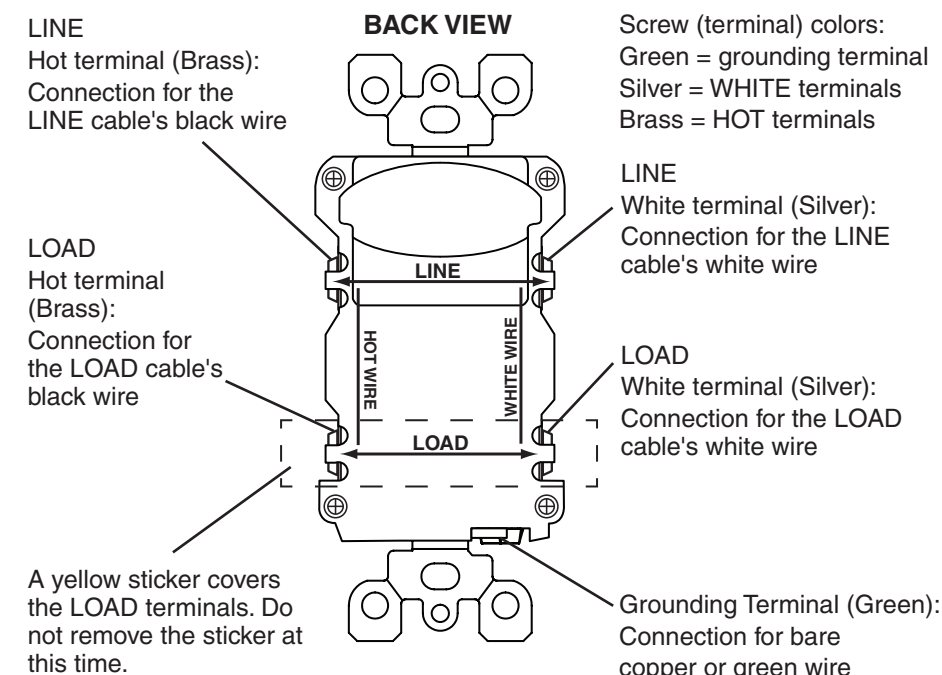
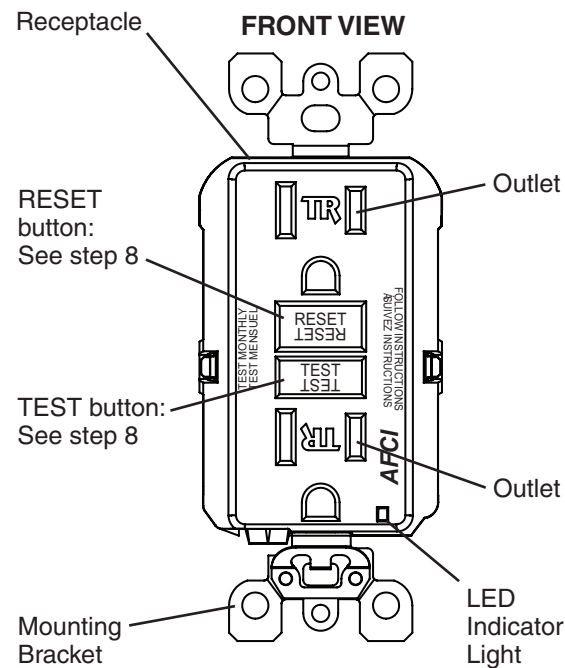

3. Should you install it?

Installing an Outlet Branch Circuit AFCI receptacle can be more complicated than installing a conventional receptacle.

Make sure that you:

- Understand basic wiring principles and techniques
- Can interpret wiring diagrams
- Have circuit wiring experience
- Are prepared to take a few minutes to test your work, making sure that you have wired the Outlet Branch Circuit AFCI correctly

4. LINE vs. LOAD

A cable consists of 2 or 3 wires.

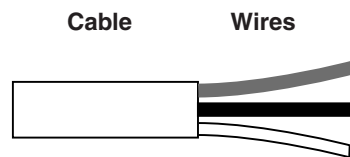

LINE cable:

Delivers power from the service panel (breaker panel or fuse box) to the AFCI. If there is only one cable entering the electrical box, it is the LINE cable. This cable should be connected to the AFCI's LINE terminals only.

LOAD cable:

Delivers power from the AFCI to another receptacle in the circuit. This cable should be connected to the AFCI's LOAD terminals only. The LOAD terminals are under the yellow sticker. Do **NOT** remove the sticker at this time.

5. Turn the power OFF

Plug an electrical device, such as a lamp or radio, into the receptacle on which you are working. Turn the lamp or radio ON. Then, go to the service panel. Find the breaker or fuse that protects that receptacle. Place the breaker in the OFF position or completely remove the fuse. The lamp or radio should turn OFF.

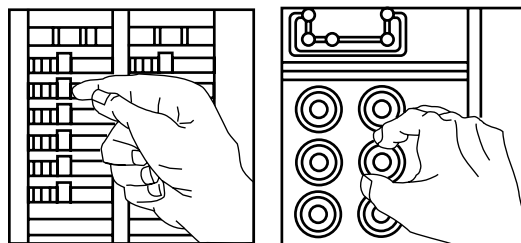

Next, plug in and turn ON the lamp or radio at the receptacle's other outlet to make sure the power is OFF at both outlets. If the power is not OFF, stop work and call an electrician to complete the installation.

6. Identify cables/wires

Important:

DO NOT install the Outlet Branch Circuit AFCI in an electrical box containing (a) more than four (4) wires (not including the grounding wires) or (b) cables with more than two (2) wires (not including the grounding wire). Contact a qualified electrician if either (a) or (b) are true.

If you are replacing an old receptacle, pull it out of the electrical box without disconnecting the wires.

- If you see one cable (2-3 wires), it is the LINE cable. The receptacle is probably in position C (see diagram to the right). Remove the receptacle and go to step 7A.
- If you see two cables (4-6 wires), the receptacle is probably in position A or B (see diagram to the right). Follow steps a-e of the procedure to the right.

Procedure: box with two (2) cables (4-6 wires):

- Detach one cable's white wire and hot wires from the receptacle and cap each one separately with a wire connector. Make sure that they are from the same cable.
- Re-install the receptacle in the electrical box, attach the faceplate, then turn the power ON at the service panel.
- Determine if power is flowing to the receptacle. If so, the capped wires are the LOAD wires. If not, the capped wires are the LINE wires.
- Turn the power OFF at the service panel, label the LINE and LOAD wires, then remove the receptacle.
- Go to step 7B.

Placement in circuit:
The Outlet Branch Circuit Type AFCI must be placed as the first outlet in the circuit.

Sample circuit:

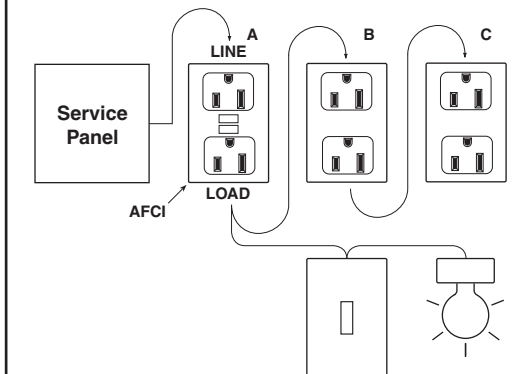

Always place Outlet Branch Circuit Type AFCI in position A. All outlets of the protected branch, including lighting and receptacle outlets must be connected to the load side of the AFCI.

7. Connect the wires (choose A or B)... only after reading other side completely

A: One Cable (2 or 3 wires) entering the box

OR

B: Two cables (4 or 6 wires) entering the box

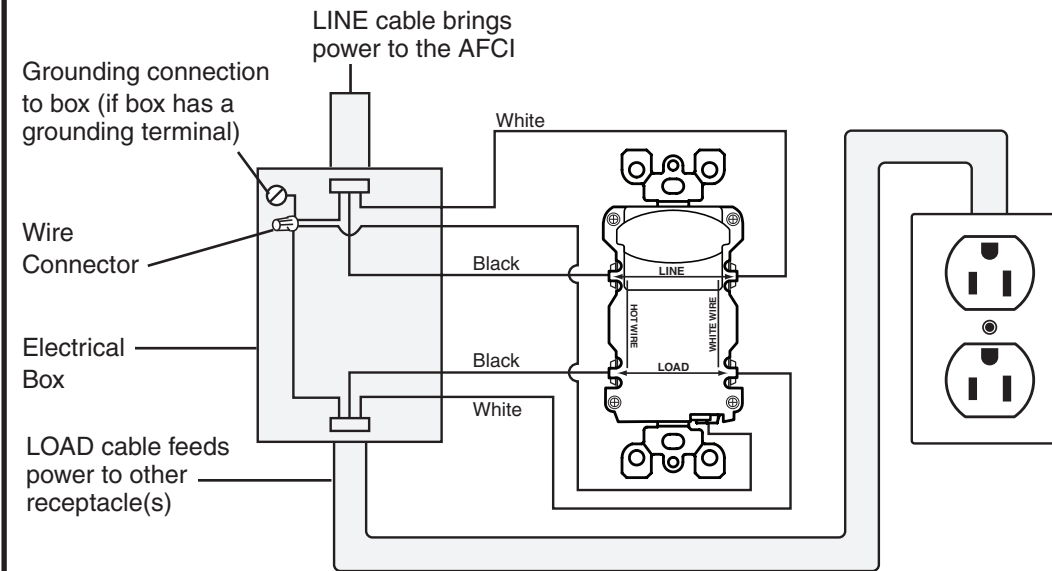
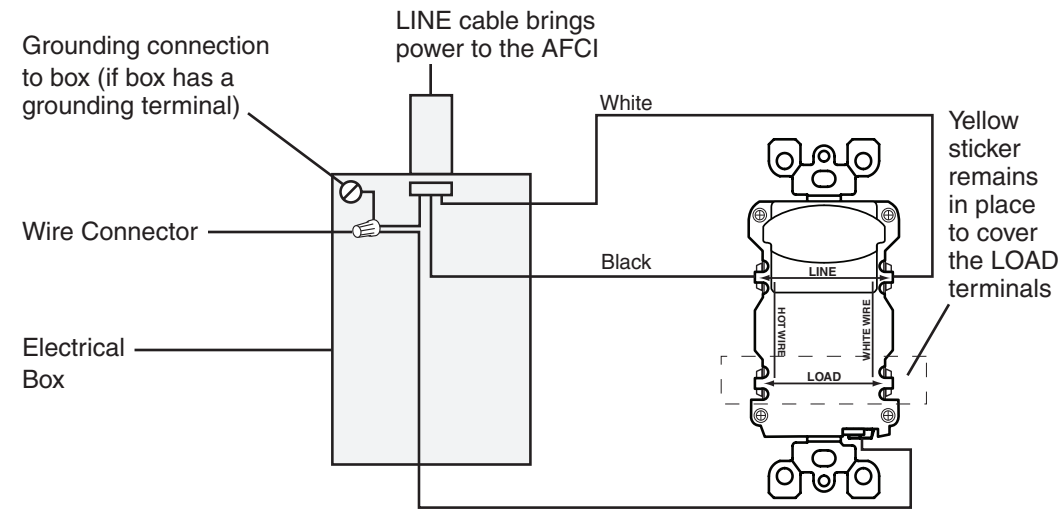

About Wire Connections: Side Wire:

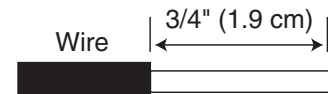

For Side wire -
Loop clockwise 2/3 of the way around screw

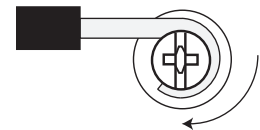

Back Wire:

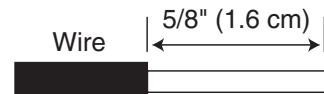

For Back wire -
Insert bare wire fully and tighten terminal clamp on conductor ONLY

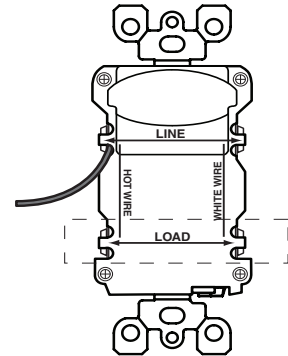

About Wire Connections: Side Wire:



For Side wire -
Loop clockwise 2/3 of the way around screw

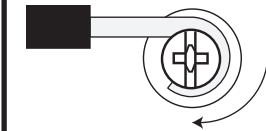

Back Wire:



For Back wire -
Insert bare wire fully and tighten terminal clamp on conductor ONLY

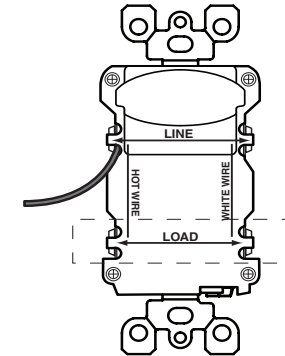

Connect the LINE cable wires to the LINE terminals:

- The white wire connects to the WHITE terminal (Silver)
- The black wire connects to the HOT terminal (Brass)

Connect the LOAD cable wires to the LOAD terminals:

- Remove the YELLOW sticker to reveal the LOAD terminals
- The white wire connects to the WHITE terminal (Silver)
- The black wire connects to the HOT terminal (Brass)

Connect the grounding wires (only if there is a grounding wire):

- Connect a 6-inch bare copper (or GREEN) 12 or 14 AWG wire to the grounding terminal on the AFCI. If the box has a grounding terminal, also connect a similar wire to the grounding terminal on the box. Connect the ends of these wires to the LINE or LOAD cable's bare copper (or GREEN) wire using a wire connector. If these wires are already in place, check the connections.

Complete the installation:

- Fold the wires into the box, keeping the grounding wire away from the WHITE and HOT terminals. Screw the receptacle to the box and attach the faceplate.
- Go to step 8.

8. Test your work

Why perform this test?

- If you miswire the AFCI it may not mitigate the effects of arcing faults due to unintentional arcing in a circuit.
- If you mistakenly connect the LINE wires to the LOAD terminals, the AFCI will not reset and will not provide power to either the AFCI receptacle face or any receptacles fed from the AFCI.

Procedure:

- This AFCI is shipped from the factory in the tripped condition and cannot be reset until it is wired correctly and power is supplied to the device. Plug a lamp or radio into the AFCI (and leave it plugged in). Turn the power ON at the service panel. Ensure that the AFCI is still in the tripped condition by pressing the TEST button. If the indicator light on the AFCI receptacle face is ON and the lamp or radio is OFF go to the Troubleshooting section because LINE and LOAD wiring connections have been reversed. You will not be able to RESET the AFCI in this condition.
- Press the RESET button **fully**. If the lamp or radio turns ON and the Indicator Light turns ON, the AFCI has been installed correctly. If the AFCI cannot be reset, go to the Troubleshooting section.
- If you installed your AFCI using step 7B press the TEST button, then plug a lamp or radio into surrounding receptacles to see which one(s), in addition to the AFCI, lost power when you pressed the TEST button. DO NOT plug life saving devices into any of the receptacles that lost power. Place a "AFCI PROTECTED OUTLET" sticker on every receptacle that lost power, then press the RESET button to reset the AFCI.
- Press the TEST button (then RESET button) every month to assure proper operation. If the Indicator light does not go out and come back on or if the AFCI cannot be reset, then it must be replaced.

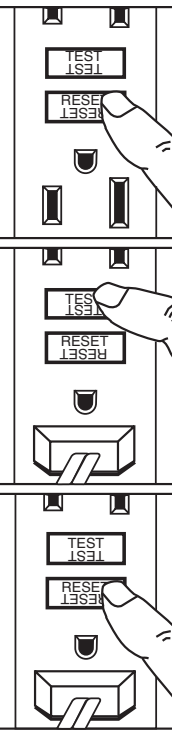

TROUBLESHOOTING

Turn the power OFF and check the wire connections against the appropriate wiring diagram in step 7A or 7B. Make sure that there are no loose wires or loose connections. Start the test from the beginning of step 8 if you rewired any connections to the AFCI.

General Information

| Cat. No. | Ratings |
|------------------------------------|--|
| AFR15 | 15A-125V AC, 60 Hz Tamper Resistant Outlet Circuit AFCI |
| AFR20 | 20A-125V AC, 60 Hz Tamper Resistant Outlet Circuit AFCI |
| All devices rated 20A feed-through | |

This product is covered by US Patent Nos. 6,040,967; 6,088,205; 6,246,558; 6,282,070; 6,381,112; 6,433,978; 6,437,953; 6,639,769; 6,646,838; 6,657,834; 6,788,173; 6,864,766; 6,944,001; 7,336,458; 7,355,117; 7,400,479; 7,463,124; 7,697,252; 7,737,809; 7,764,151; 7,820,909; 7,868,719; 7,907,371; 8,054,595; 8,130,480 and corresponding foreign patents (*applies only to AFR20).

**Wiring Device - Kellems
Hubbell Incorporated (Delaware)
Shelton, CT 06484
1-800-288-6000
www.hubbell-wiring.com**