



Installing and Testing a GFCI Receptacle

Please read this leaflet completely before getting started

PD2739 (Page 1) (English) 07/16

CAUTION

- To prevent severe shock or electrocution, always turn the power OFF at the service panel before working with wiring.
- Use this GFCI receptacle with copper or copper-clad wire. Do not use it with aluminum wire.
- Do not install this GFCI receptacle on a circuit that powers life support equipment because if the GFCI trips it will shut down the equipment.
- For installation in damp or wet locations, the GFCI receptacle must be Listed and marked as Weather Resistant (WR).
- For installation in wet locations, protect the GFCI receptacle with a weatherproof cover that will keep both the receptacle and any plugs dry.
- Must be installed in accordance with national and local electrical codes.

1. What is a GFCI?

A GFCI receptacle is different from conventional receptacles. In the event of a ground fault, a GFCI will trip and quickly stop the flow of electricity to prevent serious injury.

Definition of a ground fault:

Instead of following its normal safe path, electricity passes through a person's body to reach the ground. For example, a defective appliance can cause a ground fault.

A GFCI receptacle does not protect against circuit overloads, short circuits, or shocks. For example, you can still be shocked if you touch bare wires while standing on a non-conducting surface, such as a wood floor.

2. The GFCI's features

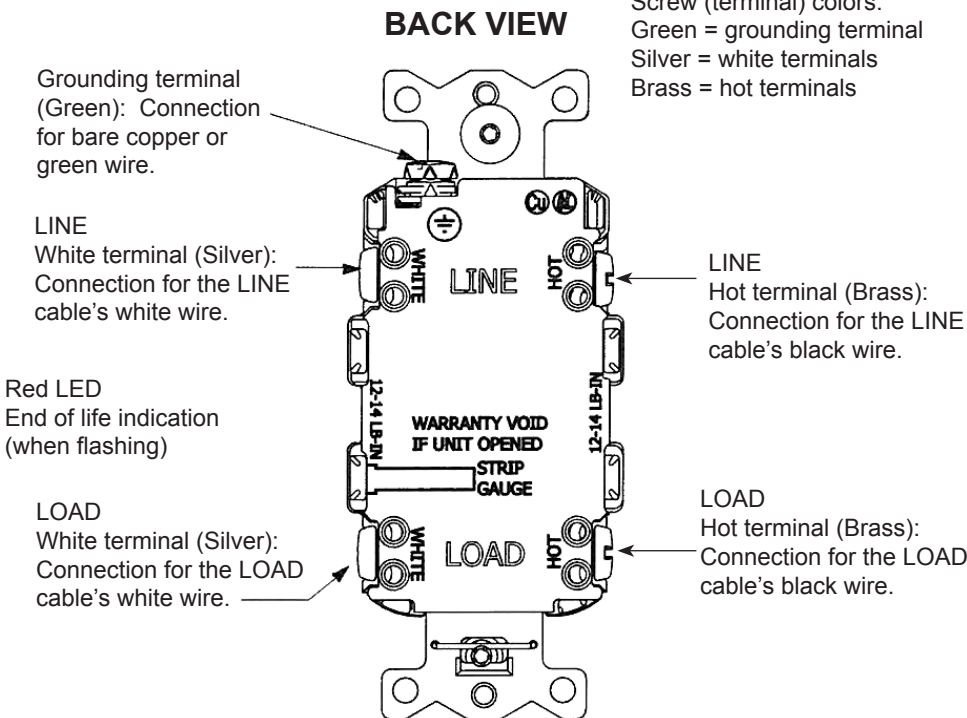
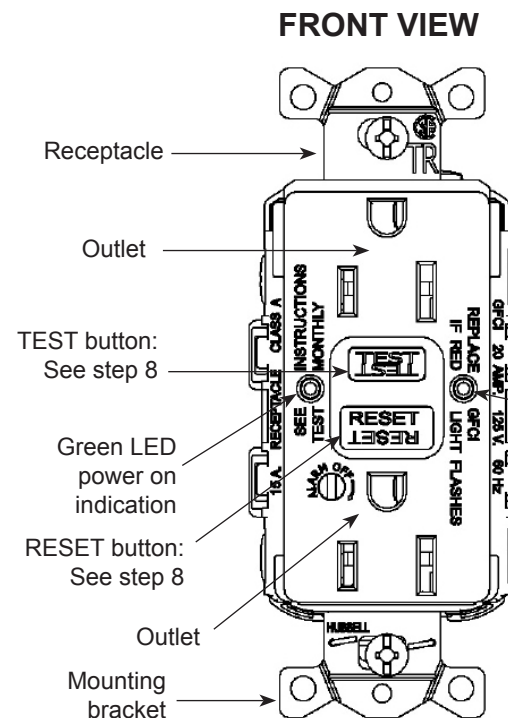

Screw (terminal) colors:
Green = grounding terminal
Silver = white terminals
Brass = hot terminals

3. Should you install it?

Installing a GFCI receptacle can be more complicated than installing a conventional receptacle.

Make sure that you:

- Understand basic wiring principles and techniques.
- Can interpret wiring diagrams.
- Have circuit wiring experience.
- Are prepared to take a few minutes to test your work, making sure that you have wired the GFCI receptacle correctly.

4. LINE vs. LOAD

A cable consists of 2 or 3 wires.

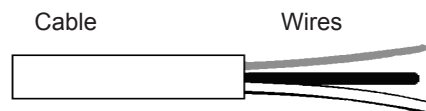

LINE cable:

Delivers power from the service panel (breaker panel or fuse box) to the GFCI. If there is only one cable entering the electrical box, it is the LINE cable. This cable should be connected to the GFCI's LINE terminals only.

LOAD cable:

Delivers power from the GFCI to another receptacle in the circuit. This cable should be connected to the GFCI's LOAD terminals only.

5. Turn the power OFF

Plug an electrical device, such as a lamp or radio, into the receptacle on which you are working. Turn the lamp or radio on. Then, go to the service panel. Find the breaker or fuse that protects that receptacle. Place the breaker in the OFF position or completely remove the fuse. The lamp or radio should turn OFF.

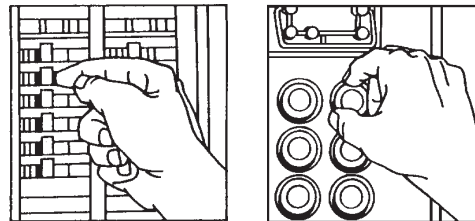

Next, plug in and turn ON the lamp or radio at the receptacle's other outlet to make sure the power is OFF at both outlets. If the power is not OFF, stop work and call an electrician to complete the installation.

6. Identify cables/wires

Important:

Do not install the GFCI receptacle in an electrical box containing (a) more than 4 wires (not including the grounding wires) or (b) cables with more than two wires (not including the grounding wire). Contact a qualified electrician if either (a) or (b) is true.

If you are replacing an old receptacle, pull it out of the electrical box without disconnecting the wires.

- If you see one cable (2-3 wires), it is the LINE cable. The receptacle is probably in position C (see diagram to the right). Remove the receptacle and go to step 7A.
- If you see two cables (4-6 wires), the receptacle is probably in position A or B (see diagram to the right). Follow steps a-e of the procedure to the right.

Procedure: box with two cables (4-6 wires)

- Detach one cable's white and hot wires from the receptacle and cap each one separately with a wire connector. Make sure that they are from the same cable.
- Re-install the receptacle in the electrical box, attach the faceplate, then turn the power ON at the service panel.
- Determine if power is flowing to the receptacle. If so, the capped wires are the LOAD wires. If not the capped wires are the LINE wires.
- Turn the power OFF at the service panel, label the LINE and LOAD wires, then remove the receptacle.
- Go to step 7B.

Placement in circuit:

The GFCI's place in the circuit determines if it protects other receptacles in the circuit.

Sample circuit

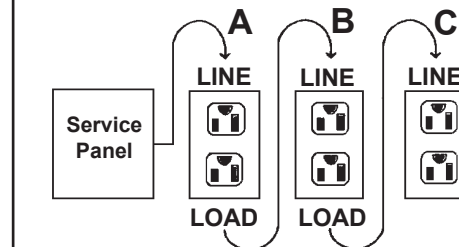

Placing the GFCI in position A will also provide protection to "load side" receptacles B and C. On the other hand, placing the GFCI in position C will not provide protection to receptacles A or B. Remember that receptacles A, B, and C can be in different rooms.

7. Connect the wires (choose A or B) ... only after reading other side completely

A: One cable (2 or 3 wires) entering the box **OR** **B: Two cables (4 or 6 wires) entering the box**

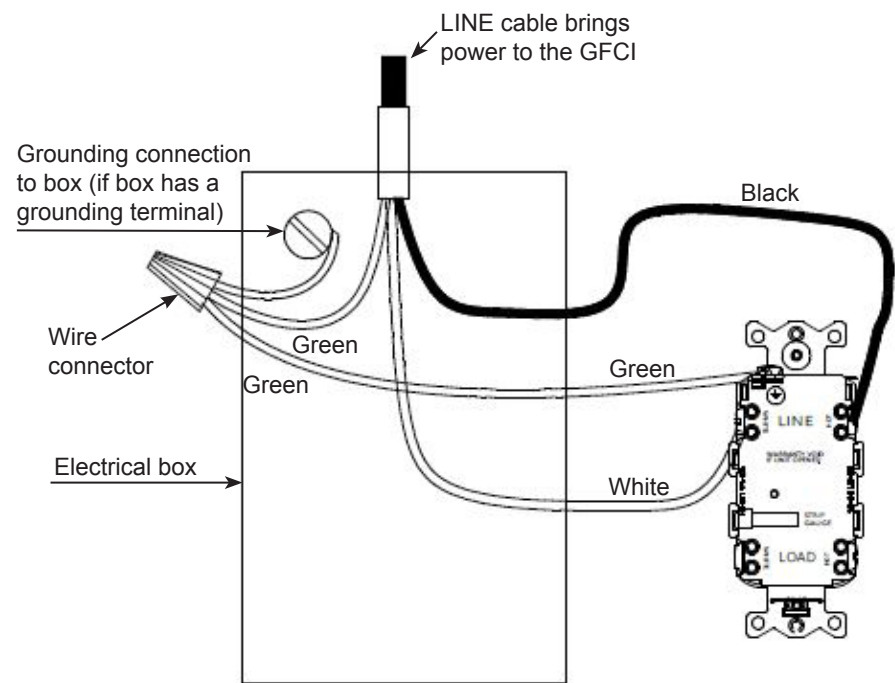

About wire connections

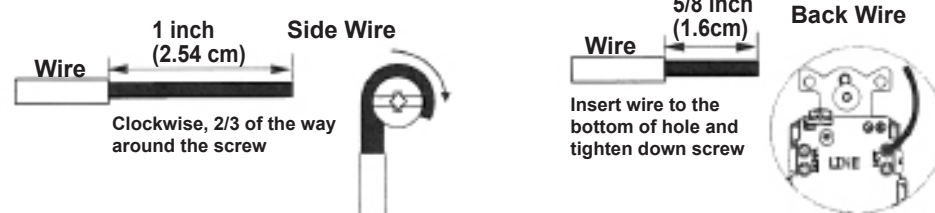

Connect the LINE cable wires to the LINE terminals:

- The white wire connects to the White terminal (Silver)
- The black wire connects to the Hot terminal (Brass)

Connect the grounding wire (only if there is a grounding wire):

- For a box with no grounding terminal: (diagram not shown) Connect the LINE cable's bare copper (or green) wire directly to the grounding terminal on the GFCI receptacle.
- For a box with a grounding terminal: (diagram shown above) Connect a 6-inch bare copper (or green) 12 or 14 AWG wire to the grounding terminal on the GFCI. Also connect a similar wire to the grounding terminal on the box. Connect the ends of these wires to the LINE cable's bare copper (or green) wire using a wire connector. If these wires are already in place, check the connections.

Complete the installation:

- Fold the wires into the box, keeping the grounding wire away from the White and Hot terminals. Screw the receptacle to the box and attach the faceplate.
- Go to step 8

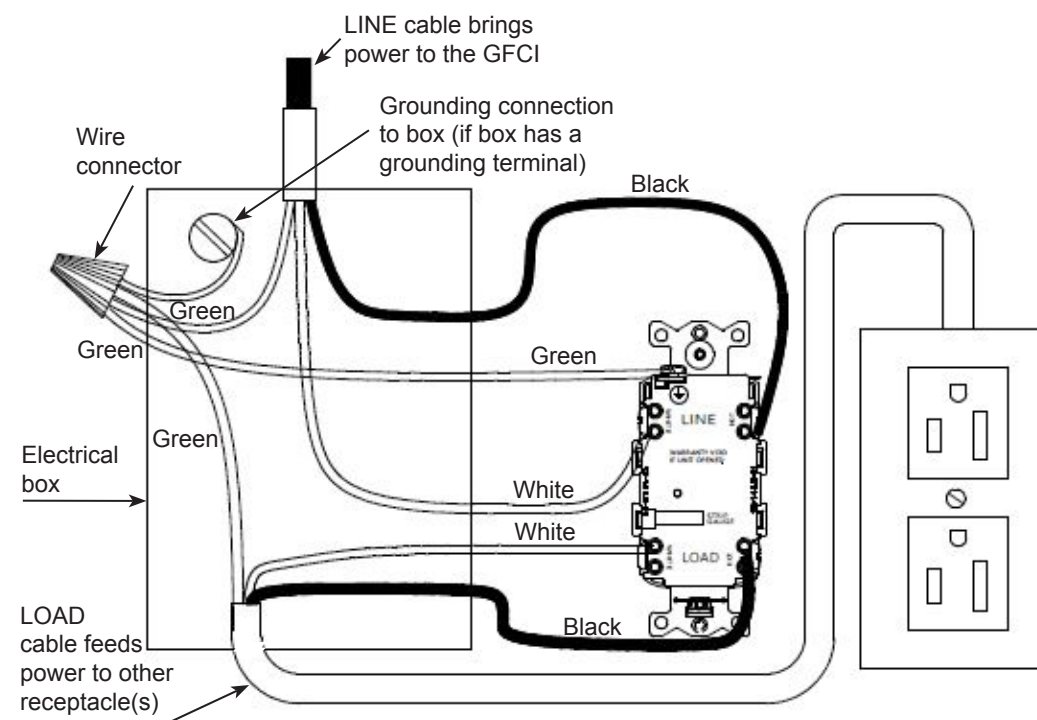

About wire connections

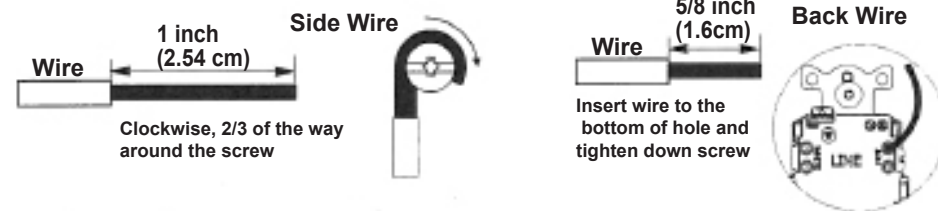

Connect the LINE cable wires to the LINE terminals:

- The white wire connects to the White terminal (Silver)
- The black wire connects to the Hot terminal (Brass)

Connect the LOAD cable wires to the LOAD terminals:

- The white wire connects to the White terminal (Silver)
- The black wire connects to the Hot terminal (Brass)

Connect the grounding wires as shown above (only if there is a grounding wire):

- Connect a 6-inch bare copper (or green) 12 or 14 AWG wire to the grounding terminal on the GFCI. If the box has a grounding terminal, also connect a similar wire to the grounding terminal on the box. Connect the ends of these wires to the LINE and LOAD cable's bare copper (or green) wire using a wire connector. If these wires are already in place, check the connections.

Complete the installation:

- Fold the wires into the box, keeping the grounding wire away from the White and Hot terminals. Screw the receptacle to the box and attach the faceplate.
- Go to step 8

8. Test your work

Why perform this test?

- If you miswired the GFCI it may not prevent personal injury or death due to a ground fault (electrical shock).

Procedure:

- Turn the power ON at the service panel. Press the RESET button fully. The GFCI cannot be reset until it is wired correctly and power is supplied to the device. Plug a lamp or radio into the GFCI (and leave it plugged-in) to verify that the power is ON. If there is no power, go to Troubleshooting.
- Press the TEST button in order to trip the device. This should stop the flow of electricity, making the radio or lamp shut OFF. Note that the RESET button will pop-out. If the power stays ON, go to Troubleshooting. If the power goes OFF, you have installed the GFCI receptacle correctly. To restore power, press the RESET button. If the red Light Emitting Diode (LED) begins to flash, or if the GFCI cannot be reset, the receptacle has lost its GFCI protection and should be replaced immediately.
- If you installed your GFCI using step 7B, plug a lamp or radio into surrounding receptacles to see which one(s), in addition to the GFCI, lost power when you pressed the TEST button. Do not plug life saving devices into any receptacles that lost power. Place a "GFCI Protected" sticker on every receptacle that lost power.
- Manual Test: Press the TEST button (then RESET button) every month to assure proper operation. Automatic Self-Test: The Hubbell AUTOGUARD® GFCI automatically performs a self-test of the electronics every minute. The Manual Test should be performed every month to assure proper mechanical operation. In the event of a failure during either the Manual Test or the Automatic Self-Test, the red LED will flash indicating that the receptacle has lost its GFCI protection. If this occurs the GFCI should be replaced immediately.

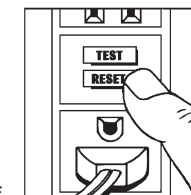
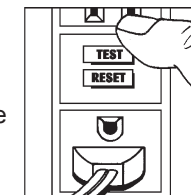
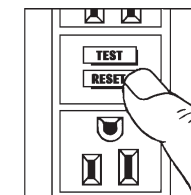

This unit is equipped with an audible alarm that sounds if the GFCI trips or goes into end of life. The alarm may be silenced by turning the "ALARM OFF" screw on the front of the receptacle clockwise.

TROUBLESHOOTING

Turn the power OFF and check the wire connections against the appropriate wiring diagram in step 7A or 7B. Make sure that there are no loose wires or loose connections. Also, it is possible that you reversed the LINE and LOAD connections. LINE/LOAD reversal will be indicated by power remaining OFF at the GFCI Face and by the Reset Button not staying in. Reverse the LINE and LOAD connections if necessary. Start the test from the beginning of step 8 if you rewired any connections to the GFCI.

GENERAL INFORMATION

GFCI receptacle rating: 20 Amps, 120 Volts 60 Hz

This device complies with part 15 of the FCC Rules. Operation is subject to the following two conditions: (1) this device may not cause harmful interference, and (2) this device must accept any interference received, including interference that may cause undesired operation.

Wiring Device-Kellems
Hubbell Incorporated (Delaware)
Shelton, CT 06484
1-800-288-6000
www.hubbell-wiring.com