

EdgeConnect™

TECHNOLOGY

TWIST-LOCK® DEVICES WITH
SCREWLESS TERMINATIONS



Twist-Lock® devices with screwless terminations

Hubbell's innovative, patented EdgeConnect™ devices with screwless terminations are the fastest termination devices on the market. Strong steel springs continuously apply pressure to wires, ensuring a strong connection in the most abusive environments.



RECEPTACLES

Available in 3, 4, and 5 wire configurations, these receptacles fit in standard depth boxes



PLUGS AND CONNECTORS

Cord mounted plugs include funneled wire entry to direct conductor strands as well as molded in leverage points for easy unwiring



FLANGED INLETS AND RECEPTACLES

Designed with easy termination access in the back of the device with laser etched terminal markings for clear identification of correct wiring

IT'S ABOUT **PERFORMANCE**



Speed

80% faster terminations



Durability

Built to withstand the industry's harshest environments



Performance

Terminations are 25-60% stronger when subjected to vibration



Patented

The only screwless termination in an industrial NEMA wiring device



FOOD PROCESSING

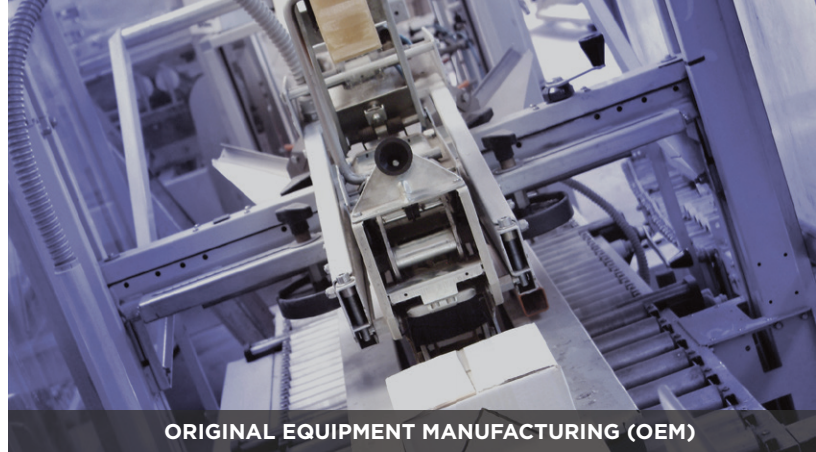

ORIGINAL EQUIPMENT MANUFACTURING (OEM)



INDUSTRIAL MANUFACTURING



ENTERTAINMENT

For every application

Applications subject to vibration or thermal cycling benefit from increased performance and productivity savings with Hubbell's EdgeConnect™ technology. Perfect for use in power distribution systems, for powering motor drives, or simply installing equipment on the production floor.



OEMs

Save money with 80% reduction in installation time, while providing consistently reliable connections



ELECTRICIANS

Terminate in just 11 seconds, no torque screwdriver required, with no exposed live metal



ELECTRICAL CONTRACTORS

Ensure quick yet reliable installations, even in harsh environments

CERTIFICATIONS



LISTED TO UL 498



VERIFIED TO
FEDERAL SPECIFICATION
W-C-596H

(Plugs and flanged inlets only)



CERTIFIED TO
CSA C22.2 NO.42

Super fast connections for greater efficiency

For decades, installers have had to spend considerable time wiring each screw and torquing it down with a screwdriver or torque wrench, with the responsibility of measuring and ensuring the integrity of each connection. Even experienced installers needed well over a minute to terminate one device.

With the Twist-Lock EdgeConnect™ Screwless Termination system, simply insert the wire and press the plunger down. No tools are required. That connection is fool-proof and long lasting, to all but guarantee a high quality result. Any qualified installer regardless of level of training can guarantee a high quality result. Elapsed time? About 11 seconds!

Labor savings, easy as:

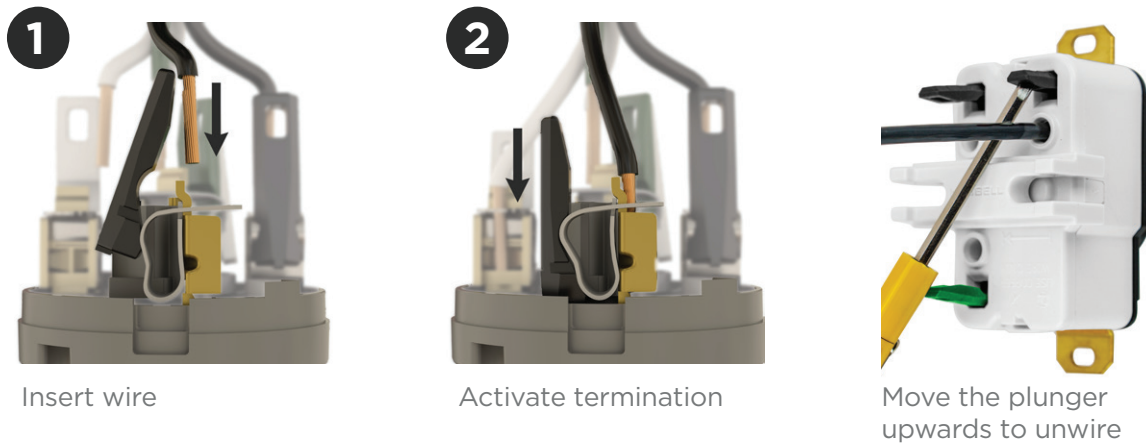

With this new termination method, NEC® code 110.14(D) “Terminal connection torque” requiring the use of a torque driver to secure the terminations is no longer applicable.

Time study analysis

	Screw Terminated Device	Screwless Terminated Device
Example catalog number	HBL2310	HBL2310ST
	Seconds	Seconds
Time per pc	61.5	11.8

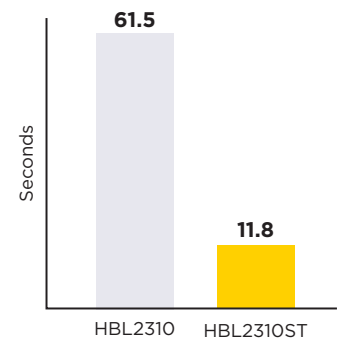

Seconds saved with Screwless Termination, per piece **49.7**

Improve labor time on a repetitive, time consuming task by 80%!

The highest reliability— even under constant vibration!

The terminations are tight from day one and stay tight, gripping hard to keep the power flowing even through high vibration environments that can steadily work wires loose and cause unscheduled downtime.

Wires secured with Hubbell Twist-Lock EdgeConnect™ screwless termination devices not only stay tight, they actually dig in and get tighter in the face of the relentless vibration from industrial equipment which constantly threatens the integrity of traditional connections.

Throughout industry, vibration is generally expected to degrade, not improve, a product's performance in every instance. Not with Hubbell Twist-Lock EdgeConnect™ devices—tough environments just make them perform even better and even more reliably for our users.

Similar performance is also demonstrated in the face of related industrial threats such as temperature cycling and strand relaxation. No matter what the environment, with Twist-Lock EdgeConnect™ devices you won't have to go back and retighten—just install once and you're all set.



Vibration performance

25%-60% higher retention

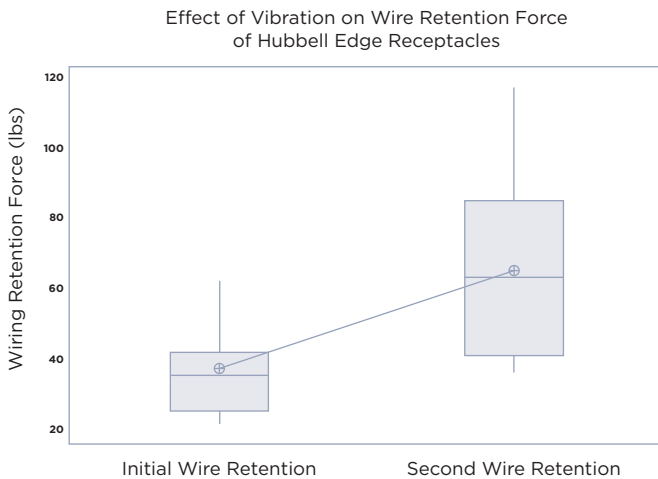

Upon installation, a 10 AWG THHN stranded wire required 40 lbs of force to disengage.

After exposure to vibration per the UL standard, 65 lbs of force were required to disengage the wire.

Three-axis vibration sequence test performed in accordance with "UL 498, Standard for Safety—Attachment Plugs and Receptacles"

Wire retention

13.5 lb UL minimum requirement

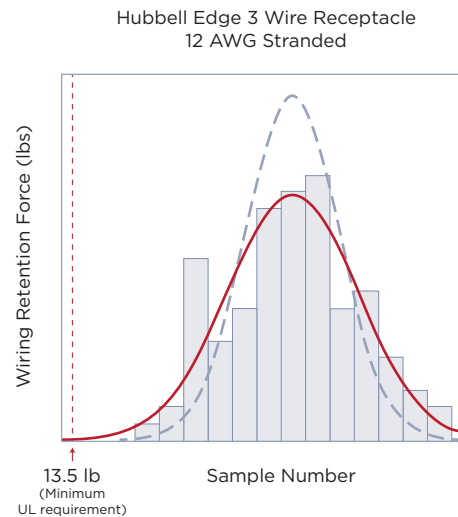

When compared to the minimum UL requirement for wire retention, Twist-Lock EdgeConnect™ screwless termination offers superior strength.

Plugs and flanged inlets

4 and 5 wire plugs and flanged inlets will bring enormous benefits to more users than ever before—such as OEMs and machine manufacturers, maintenance and repair operations, builders and other professionals who must efficiently and cost-effectively install up to thousands of plugs every day.

ORDERING INFORMATION

Twist-Lock® Insulgrip® Plugs

Description	Poles/Wires	Rating	20 Amp	30 Amp
Spring termination locking plugs	2P/3W	125V	HBL2311ST	HBL2611ST
		250V	HBL2321ST	HBL2621ST
		277V	HBL2331ST	
		480V	HBL2341ST	
Spring termination locking plugs	3P/4W	125/250V	HBL2411ST	HBL2711ST
		3Ø 250V	HBL2421ST	HBL2721ST
		3Ø 480V	HBL2431ST	HBL2731ST
Spring termination locking plugs	4P/5W	3ØY 120/208V	HBL2511ST	HBL2811ST
		3ØY 277/480V	HBL2521ST	HBL2821ST



Twist-Lock® Flanged Inlets

Description	Poles/Wires	Rating	20 Amp	30 Amp
Spring termination locking plugs	2P/3W	125V	HBL2315ST	HBL2615ST
		250V	HBL2325ST	HBL2625ST
		277V	HBL2335ST	
		480V	HBL2345ST	
Spring termination locking flanged inlets	3P/4W	125/250V	HBL2415ST	HBL2715ST
		3Ø 250V	HBL2425ST	HBL2725ST
		3Ø 480V	HBL2435ST	HBL2735ST
Spring termination locking flanged inlets	4P/5W	3ØY 120/208V	HBL2515ST	HBL2815ST
		3ØY 277/480V	HBL2525ST	HBL2825ST



SPECIFICATIONS

Product Dimensions Inches (mm)

Catalog Number	Amps	A	B	C
Spring termination locking plugs	20A	3.38" (85.7)	2.22" (56.5)	2.33" (59.2)
	30A	3.38" (85.7)	2.22" (56.5)	2.33" (59.2)

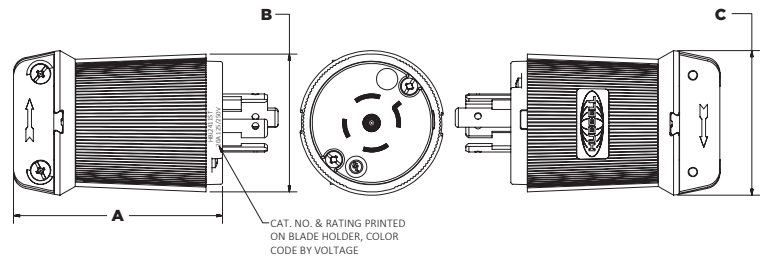

Product Dimensions Inches (mm)

Catalog Number	Amps	A	B	C	D	E	F
Spring termination locking flanged inlets, 3P/4W	20A	3.06" (77.8)	2.69" (68.2)	.186" (4.7)	2.47" (62.7)	.09" (2.4)	2.23" (56.6)
	30A	3.06" (77.8)	2.69" (68.2)	.186" (4.7)	2.56" (65.0)	.09" (2.4)	2.23" (56.6)
Spring termination locking flanged inlets, 4P/5W	20A	3.06" (77.8)	2.69" (68.2)	.186" (4.7)	2.64" (67.0)	.09" (2.4)	2.23" (56.6)
	30A	3.06" (77.8)	2.69" (68.2)	.186" (4.7)	2.64" (67.0)	.09" (2.4)	2.23" (56.6)

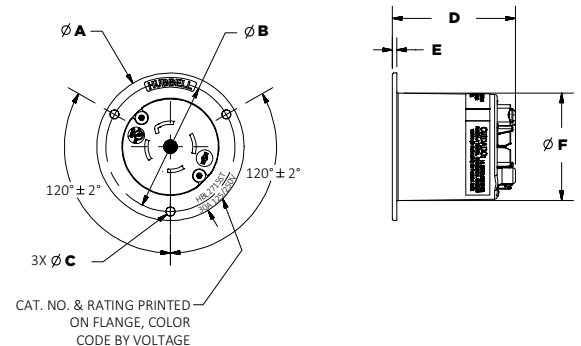

Receptacles, connectors and flanged receptacles

Twist-Lock screwless termination connectors and receptacles provide power for a variety of applications, including power drops, facility power, data center power supplies, entertainment power distribution, and industrial production equipment. OEMs that utilize these receptacles in their products instantly realize the time saves when wiring hundreds, if not thousands of these devices.

ORDERING INFORMATION

Twist-Lock® Single Receptacles

Description	Poles/Wires	Rating	20 Amp	30 Amp
Spring termination locking receptacles	2P/3W	125V	HBL2310ST	HBL2610ST
		250V	HBL2320ST	HBL2620ST
	3P/4W	125/250V	HBL2410ST	HBL2710ST
		3Ø 250V	HBL2420ST	HBL2720ST
		3Ø 480V	HBL2430ST	HBL2730ST
	4P/5W	3ØY 120/208V	HBL2510ST	HBL2810ST
3ØY 277/480V		HBL2520ST	HBL2820ST	
Removal bridge, for use with all Twist-Lock EdgeConnect™ Series receptacles				HBLSTRB



Twist-Lock® Connectors

Description	Poles/Wires	Rating	20 Amp	30 Amp
Spring termination locking connectors	2P/3W	125V	HBL2313ST	HBL2613ST
		250V	HBL2323ST	HBL2623ST
		277V	HBL2333ST	
		480V	HBL2343ST	



Twist-Lock® Flanged Receptacles

Description	Poles/Wires	Rating	20 Amp	30 Amp
Spring termination locking flanged receptacles	2P/3W	125V	HBL2316ST	HBL2616ST
		250V	HBL2326ST	HBL2626ST

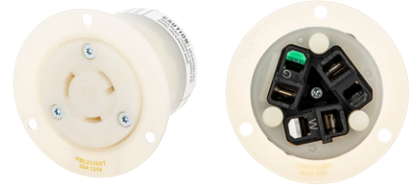

SPECIFICATIONS

Product Dimensions Inches (mm)

	Amps	A	B	C	D	E	F	G	H
Spring termination locking receptacles	20A	3.28" (83.3)	2.38" (60.3)	1.56" (39.6)	.24" (6.0)	1.17" (29.8)	1.45" (36.8)	2.77" (70.4)	1.70" (43.2)
	30A	3.28" (83.3)	2.38" (60.3)	1.56" (39.6)	.24" (6.1)	1.26" (32.0)	1.53" (39.0)	2.77" (70.4)	1.70" (43.2)

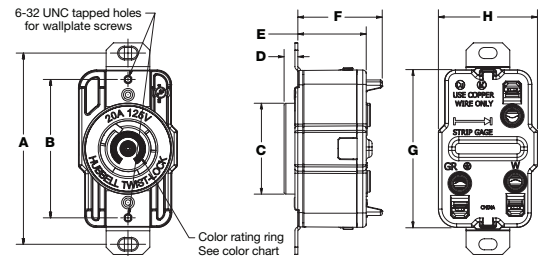

Product Dimensions Inches (mm)

Catalog Number	Amps	A	B	C
Spring termination locking connectors	20A	4.12" (104.8)	1.95" (49.7)	2.26" (57.4)

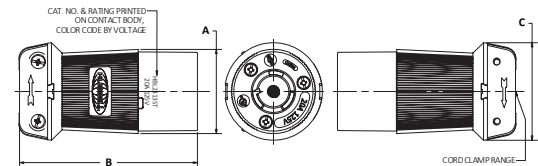

Product Dimensions Inches (mm)

Catalog Number	Amps	A	B	C	D	E	F
Spring termination locking flanged receptacles, 2P/3W	20A	2.88" (73.0)	2.50" (63.5)	.187" (4.7)	2.67" (67.9)	.12" (3.0)	2.04" (51.8)

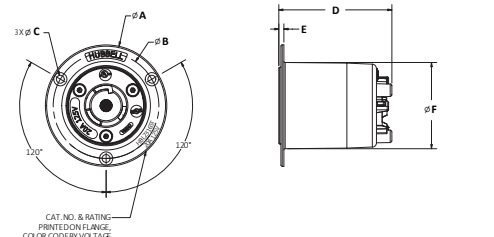

EdgeConnect™ TECHNOLOGY

Twist-Lock® devices with screwless terminations

CONTACT US

Count on Hubbell Wiring Device-Kellems for the most reliable and innovative wiring device product line in North America.

- ✉ custserv@hubbell.com
- ☎ (800) 288-6000
- 📍 Find your local representative at www.hubbell.com/wiringdevice-kellems

ONLINE RESOURCES

The Hubbell Wiring Device-Kellems website offers fast and convenient information through our online catalog, technical support, videos and more. Visit www.hubbell.com/wiringdevice-kellems.



ONLINE RESOURCES



VIDEO

LITERATURE SUPPORT

Hubbell offers an extensive literature library for product support. Downloadable PDFs are available online.

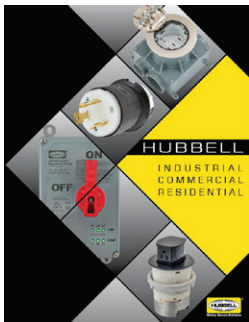

Full Line Catalog



Safety Guide



Entertainment Guide

