

Healthcare

Product Solutions



Delivering Power, Data and AV



Table of Contents

SNAPConnect® Devices	4
Hospital Grade Devices	6
Power Quality Products	8
Ground Fault Protection	10
Switches	11
Charging Solutions	13
Pre-Wired Raceway	15
Wall/Trench and Underfloor Duct	16
Energy Efficiency	17
Twist-Lock® Devices	19
Hubbell SystemOne Floor Boxes & Fire-Rated Poke-Throughs	21
Cord Reels	23
Services	24

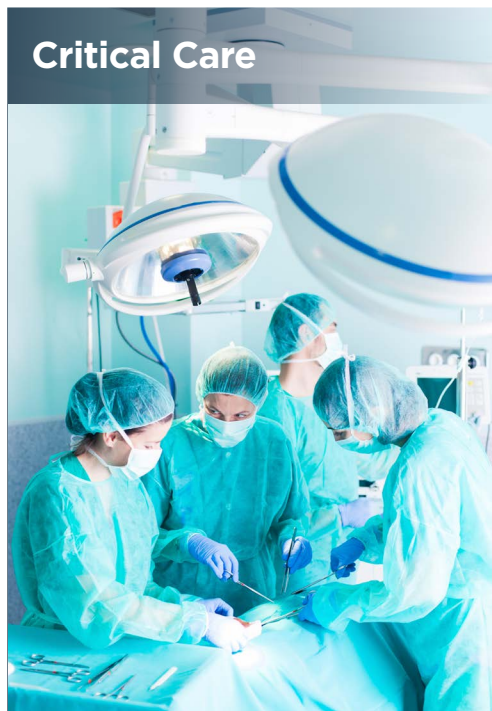



Public Spaces

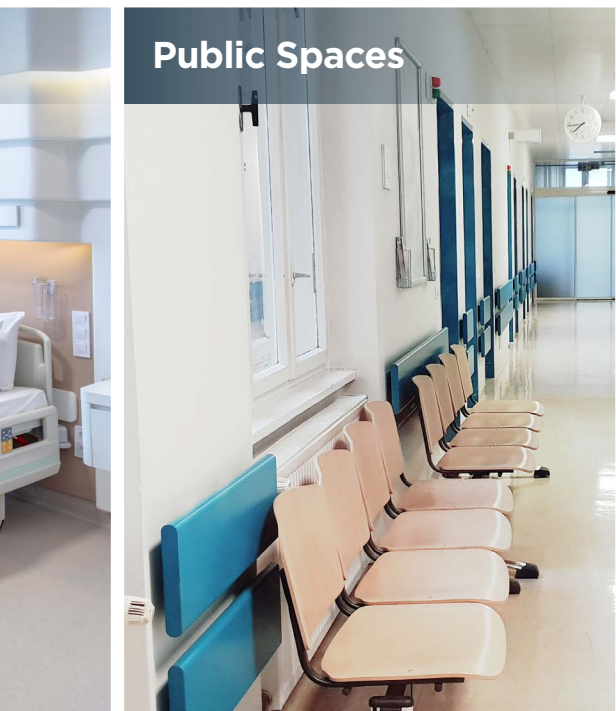

Administrative



Services



SNAPConnect® Devices

SNAPConnect devices provide an ideal solution for larger projects with the potential for future change outs. From new construction and renovation to demanding locations, the modular SNAPConnect design eliminates exposed live parts and replaces pigtailed. Consistent, safe, and reliable connections are ensured during rough-in installation. Once walls are up, the protective cover is removed, and the connector simply snaps into the device. Going forward, device change outs by maintenance personnel are simple and easy.

- Modular wiring provides the long term benefit of safe, easy, fast device replacement for building owners and facilities departments
- Ability to energize and test circuits at rough-in and resolve issues during less critical project stages
- Widest breadth of modular devices on the market

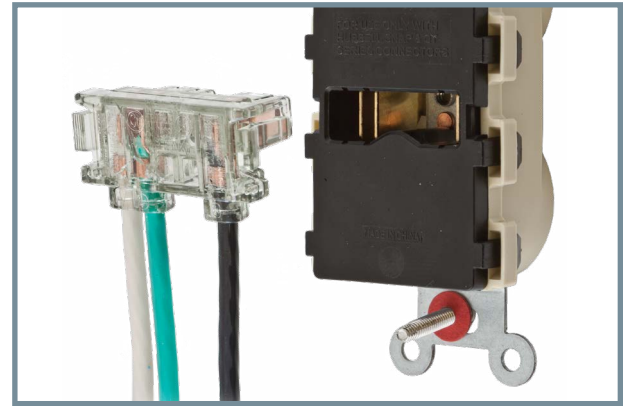

Applications

- Critical Care Rooms
- ICU & Operating Rooms
- Patient Rooms
- Waiting Areas
- Nurses' Stations
- Examination Rooms



SNAPConnect Extra Heavy Duty Hospital Grade Receptacles with Power Indicating LED

Description	Duplex			Decorator	
	Standard	Tamper-Resistant	Face LED Tamper Resistant	Standard	Tamper-Resistant
15A 125V Red White	SNAP8200RL SNAP8200WL	SNAP8200RLTRA SNAP8200WLTRA	SNAP8200RLTR SNAP8200WLTR	SNAP2172RL SNAP2172WL	SNAP2172RLTRA SNAP2172WLTRA
20A 125V Red White	SNAP8300RL SNAP8300WL	SNAP8300RLTRA SNAP8300WLTRA	SNAP8300RLTR SNAP8300WLTR	SNAP2182RL SNAP2182WL	SNAP2182RLTRA SNAP2182WLTRA

For additional colors, see our full line catalog.

SNAPConnect Extra Heavy Duty Hospital Grade Receptacles

Description	Duplex		Decorator	
	Standard	Tamper-Resistant	Standard	Tamper-Resistant
15A 125V Red White	SNAP8200RNA SNAP8200WNA	SNAP8200RTRA SNAP8200WTRA	SNAP2172RNA SNAP2172WNA	SNAP2172RTRA SNAP2172WTRA
20A 125V Red White	SNAP8300RNA SNAP8300WNA	SNAP8300RTRA SNAP8300WTRA	SNAP2182RNA SNAP2182WNA	SNAP2182RTRA SNAP2182WTRA

For additional colors, see our full line catalog.

SNAPConnect Right Angle Pigtailed Connector for Use with Receptacles

Description	Solid	Stranded
Clear right angle terminal with 6 inch leads #12 AWG THHN/THWN-2; Polycarbonate housing material	SNAP1RNA	SNAP2RNA
6 inch wire connector, red (Emergency Circuit)	SNAP1REM	SNAP2REM
6 inch wire connector, blue (Surge Circuit)	SNAP1RS	SNAP2RS
6 inch wire connector, orange (Isolated Ground Circuit)	SNAP1RIG	SNAP2RIG



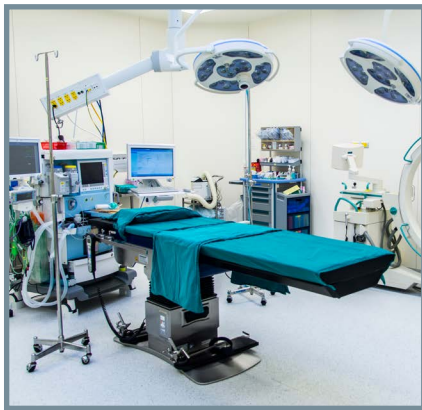

Installation Efficiency

Available in standard, heavy duty and extra heavy duty specification grades, SNAPConnect® can reduce installation time and meet National Electrical Code® specialty device requirements in commercial, institutional and healthcare applications.

The SNAPConnect family of connectors, receptacles and switches includes a wide variety, including Tamper-Resistant (TR), USB Charger, Isolated Ground (IG), Power Indicating LED and Surge Suppressing.

Duplex receptacles are available in standard or decorator faces, 15 or 20A.

Labor Savings

Save up to 5 minutes and complete your job in a SNAP

- Step 1: Rough-in the SNAPConnect terminal instead of pigtails
Save one minute
- Step 2: Remove the protective packaging, attach the SNAPConnect device to the circuit
Save over three minutes
- Step 3: Secure the mounting screws, attach the wallplate and the job is complete
Save over a minute

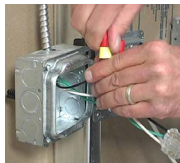

SNAPConnect Specification Grade Toggle Switches

Description	15A, 120-277V AC	20A, 120-277V AC
Single Pole	SNAP1201WNA	SNAP1221WNA
3-Way	SNAP1203WNA	SNAP1223WNA
Illuminated, Single Pole	SNAP1201ILWNA	SNAP1221ILWNA
Illuminated, 3-Way	SNAP1203ILWNA	SNAP1223ILWNA
Pilot Light, Single Pole	SNAP1201PLWNA	SNAP1221PLWNA



SNAPConnect Specification Grade Style Line® Decorator Switches

Description	15A, 120-277V AC	20A, 120-277V AC
Single Pole	SNAP2101WNA	SNAP2121WNA
3-Way	SNAP2103WNA	SNAP2123WNA
Illuminated, Single Pole	SNAP2101ILWNA	SNAP2121ILWNA
Illuminated, 3-Way	SNAP2103ILWNA	SNAP2123ILWNA
Pilot Light, Single Pole	SNAP2101PLWNA	SNAP2121PLWNA



SNAPConnect Right Angle Pigtailed Connector for Use with Switches

Clear right angle terminal with 6-inch leads #12 AWG THHN/THWN-2, 600V wire

Description	Solid Wire	Stranded Wire
Single Pole (3 Wires)	SNAPSP1NA	SNAPSP2NA
Single Pole with Pilot	SNAPSPP1NA	SNAPSPP2NA
3-Way (4 Wires)	SNAP3W1NA	SNAP3W2NA



Hospital Grade Devices

Healthcare facilities require products that withstand day-to-day punishment and ensure safety and convenience for staff, patients, and visitors. Hubbell was instrumental in creating hospital grade, with more stringent requirements than for standard devices. Ever since, we provide maximum value for healthcare facilities. Not all hospital grade devices are the same. While the green dot signifies UL compliance, our receptacles are designed to meet and exceed the standards.

- Exclusive nickel-plated bypass contact design increases contact pressure, lowering the operating temperature
- Four point grounding system provides redundant grounding for low resistance ground continuity in high abuse areas
- Impact resistant deep face design prevents breakage

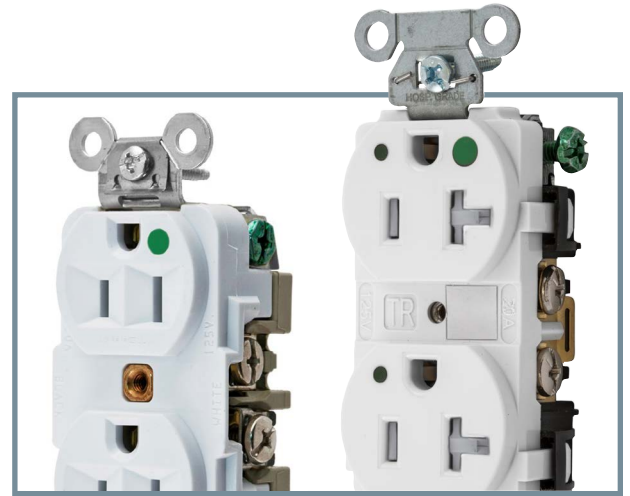

Applications

- Pediatric Hospitals
- Medical Offices
- Healthcare OEM
- University Laboratories
- Patient Care Facilities

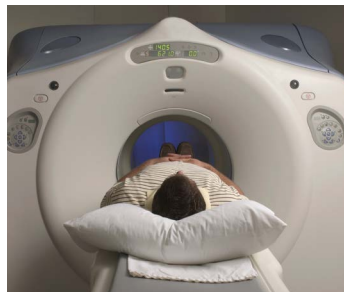

HBL8200 Series Hospital Grade Receptacles

Description			15A 125V	20A 125V
HBL extra heavy duty hospital grade receptacle	Tamper-resistant duplex	White	HBL8200SGWA	HBL8300SGWA
	Standard duplex		HBL8200W	HBL8300W
	Illuminated duplex		HBL8200ILW	HBL8300ILW
	Single receptacle		HBL8210W	HBL8310W

Shown in white. For additional colors, see our full line catalog.



Hubbell-PRO Hospital Grade Receptacles

Description			15A 125V	20A 125V
Hubbell-PRO tamper-resistant hospital grade receptacle	Duplex	White	8200WTRA	8300WTRA
	With power indicating LED		8200WLTRA	8300WLTRA

Shown in white. For additional colors, see our full line catalog.





Plugs & Connectors

Every healthcare facility includes maintenance and plant areas that are similar to an industrial facility. Large equipment such as back-up generators, compactors, loading dock equipment, HVAC units and air handlers all need high-capacity, safe and reliable power. Without it, an entire healthcare facility can shut down, compromising patient care.

MRI Receptacle

With Hubbell's hospital grade MRI duplex receptacle, a completely non-magnetic receptacle design is available for magnetic imaging areas within hospitals.



Hospital Grade Plugs and Connectors

Description		15A 125V	20A 125V
Insulgrip® plugs	Black and white nylon	HBL8215C	HBL8315C
	Transparent housing	HBL8215CT	HBL8315CT
	Angled plug, transparent	HBL8215CAT	HBL8315CAT
Valise® plugs	White nylon	HBL8115V	HBL8364V
Insulgrip connectors	Black and white nylon	HBL8219C	HBL8319C
	Transparent housing	HBL8219CT	HBL8319CT
Valise connectors	White nylon	HBL8119V	-



MRI Hospital Grade Receptacles

Description	15A 125V	20A 125V
MRI receptacle, thermoplastic polyester face, back and side wired	HBL8200WMRI	HBL8300WMRI

Shown in white. For additional colors, see our full line catalog.



Power Quality Products

SpikeShield® Surge Protection Plug Strips

Hubbell's healthcare outlet assembly (HCOA) is the only UL Listed power strip approved by CMS for use in patient and critical care areas of a healthcare facility. SpikeShield® surge protective power strips with hospital grade tamper-resistant receptacles and plugs feature a durable heavy-duty metal housing and are cULus Listed to UL1449.*

Top 3 features

- UL2930 Listed for patient care areas
- 15A and 20A 125V versions
- 6 ft. or 15 ft. cord length



Applications

- General Patient Care Spaces
- Critical Patient Care Spaces
- Moveable equipment, such as rolling carts or rolling IV poles



UL2930 Healthcare Outlet Assembly (HCOA)

Description	# of Outlets	Cord Length (ft)	15 Amp	20 Amp
UL 2930 HCOA with L-N surge protection, white	6	6	HBL6MG6	HBL6MG620
	4		HBL4MG6	HBL4MG620
	6	15	HBL6MG15	HBL6MG1520
	4		HBL4MG15	HBL4MG1520
UL 2930 HCOA relocatable power tap (RPT), white	6	6	HBL6MGRPT6	HBL6MGRPT620
	4		HBL4MGRPT6	HBL4MGRPT620
	6	15	HBL6MGRPT15	HBL6MGRPT1520
	4		HBL4MGRPT15	HBL4MGRPT1520



SpikeShield UL Type 3 Surge Protective Devices (SPD)

Description	# of Outlets	Cord Length (ft)	15 Amp	20 Amp
Heavy duty metal housing with hospital grade tamper-resistant receptacles and plug, white	6	6	HBL6HG6	HBL6HG620
	6	15	HBL6HG15	HBL6HG1520
Heavy duty metal housing with 2-port USB, hospital grade tamper-resistant receptacles and plug, white	4	6	HBL6HGUSB6	—



*Not for use in patient and critical care areas



Wired-In Branch Panel Protection

The wired-in surge protection device brick design is ideal for areas where space is a major consideration.

The surge unit can be mounted directly to the panel through a chase nipple connection, which reduces lead length and impedance while increasing protection levels.

Service/Branch Panel Protection

The SpikeShield® service entrance product line includes a line of panels with replaceable modules. This series features improved performance through the use of a low impedance bus-bar design and easily replaceable bolt-down modules.

They incorporate a modular (replaceable surge protection modules) design and feature the latest industry approvals and safety ratings, including UL1449 4th edition.



Wired-In Branch Panel Protection 100,000 Peak Amp Capacity (Type 2 SPD)

Service Voltage	Configuration	Catalog Number
120/240V AC single phase	1Ph. 3-wire +G	HBL3W100C
120/208V AC Wye*	3Ph. Wye 4-wire +G	HBL4W100C
277/480V AC Wye**	3Ph. Wye 4-wire +G	HBL8W100C
480V AC Delta	3Ph. Delta 3-wire Corner Gnd [†]	HBL9W100C
347/600V AC Wye	3Ph. Wye 4-wire +G	HBL10W100C
600V AC Delta	3Ph. Delta 3-wire Corner Gnd [†]	HBL11W100C

Service/Branch Panel Protection (Type 1 SPD)

Voltage	Configuration	Peak Amp Capacity	
		320,000	160,000
120/208V AC Wye*	3Ph. Wye 4-wire +G	HBL4P320B	HBL4P160B
277/480V AC Wye**	3Ph. Wye 4-wire +G	HBL8P320B	-
347/600V AC Wye	3Ph. Wye 4-wire +G	HBL10P320B	HBL10P160B
600V AC Delta	3Ph. Delta 3-wire Corner Gnd [†]	-	HBL11P160B

Units come standard with surge counter. For additional options, see our full line catalog.

*120/208 Wye also applies to 127/220 Wye. | **277/480 Wye also applies to 220/380 Wye, 230/400 Wye and 240/415 Wye. | [†]Also can be used on ungrounded systems.

Ground Fault Protection

The combination of GFCI protection and tamper-resistant safety provides an ideal solution. Hubbell tamper-resistant GFCI devices also provide UV and corrosion resistance for harsh, damp applications. While GFCIs protect people in bathrooms, scrub rooms, kitchenettes and other potentially wet locations throughout healthcare facilities, they should not be used in critical care areas or in ICUs and operating rooms because of the possibility of power interruption.

- Fed Spec UL Listed hospital grade
- Single LED provides visual indication of status
- Patented Autoguard® self-test technology

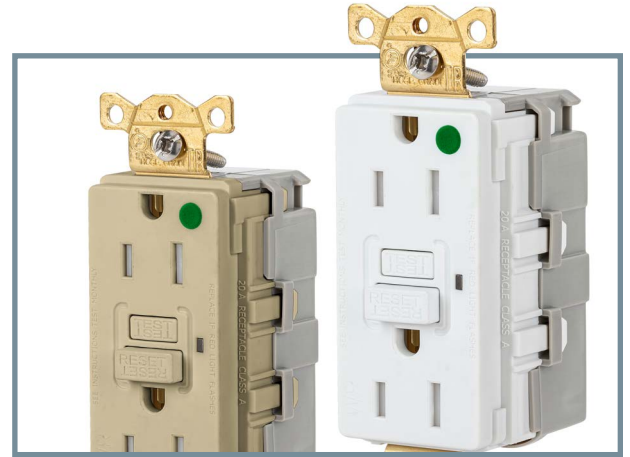

Applications

- Bathrooms
- Scrub Rooms
- Kitchenettes
- Laboratories



Hospital Grade Tamper-Resistant Weather Resistant Ground Fault Receptacles

Description		15A, 125V	20A, 125V
Standard	Ivory	GFRTW82I	GFRTW83I
	Red	GFRTW82W	GFRTW83W
	White	GFRTW82R	GFRTW83R
Assembled in USA	Ivory	GFTWRST82IU	GFTWRST83IU
	Red	GFTWRST82RU	GFTWRST83RU
	White	GFTWRST82WU	GFTWRST83WU
Isolated Ground	Ivory	GFTWRST82IIG	GFTWRST83IIG
	Red	GFTWRST82RIG	GFTWRST83RIG
	White	GFTWRST82WIG	GFTWRST83WIG
SNAPConnect	Ivory	SNAPGFTW82I	SNAPGFTW83I
	White	SNAPGFTW82W	SNAPGFTW83W
	Red	SNAPGFTW82R	SNAPGFTW83R

For additional colors, see our full line catalog.



SNAPConnect® Right Angle Pigtailed Connector for Use with Receptacles

Description	Wire Type	General Use	Assembled in USA
Clear right angle terminal with 6 inch leads #12 AWG THHN/THWN-2; polycarbonate housing material	Solid	SNAP1RA	SNAP1RNA
	Stranded	SNAP2RA	SNAP2RNA



Switches

HBL switches provide safety and reliability perfect for heavy-duty environments. Standard and rotary locking switches protect critical circuits from unauthorized access. StyleLine® switches feature rocker design. Multiple configurations and options available for each.

- **Quality construction and materials resist abuse, chemical attack and impact for the most demanding environments**
- **Full line of ratings, colors, and applications**
- **Deep back wire termination slots with brass binding screws provide feed through capability and secure wire connections**



Applications

- Hospitals
- Patient Care Facilities
- Testing Centers
- Diagnostic Labs
- Medical Equipment Manufacturing
- Mobile & Temporary Test Trailers
- Field Offices



HBL Extra Heavy Duty Industrial Series

Description	Amps	Color	Single Pole	Double Pole	Three Way	Four Way
Toggle, back and side wired	20	White	HBL1221W	HBL1222W	HBL1223W	HBL1224W
	30	Ivory	HBL3031I	HBL3032I	HBL3033I	-
Locking series; key guide	20	White	HBL1221LW	HBL1222LW	HBL1223LW	HBL1224LW
Locking series; AC barrel	20	Chrome	HBL1221RKL	HBL1222RKL	HBL1223RKL	HBL1224RKL
Illuminated, light ON with load OFF	20	Clear	HBL1221ILC	-	HBL1223ILC	-
Pilot light, light ON with load ON	20	Red	HBL1221PL	HBL1222PL	HBL1223PL	-
	30		HBL3031PL	HBL3032PL	-	-

For additional colors (such as red) and options, see our full line catalog.



StyleLine Decorator Specification Grade Commercial Series

Description	Amps	Color	Single Pole	Double Pole	Three Way	Four Way
Rocker, back and side wired	20	White	DS120W	DS220W	DS320W	DS420W
Illuminated, light ON with load OFF	20	White	DS120ILW	-	DS320ILW	-
Pilot light, light ON with load ON	20	White	DS120PLW	-	-	-
Nightlight	20	White	DS120NLWH	-	-	-

For additional colors (such as red) and options, see our full line catalog. | Prewired/leaded versions available.

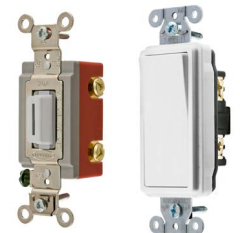

Switches designed to be disinfected

Hospitals clean and disinfect high touch surfaces like patient room switches frequently to control the spread of illness. New sealed ScrubSwitch® devices stand up to elevated cleaning and sanitizing schedules. These are the first switches designed to withstand the rigors of medical cleaning solutions and stricter protocols. The switch module is 100% sealed against liquids and installs in a standard electrical box.

Proximity sensing technology allows users to simply tap on or off, like a phone. However, the technology doesn't require skin contact, so it works with a latex gloved hand, or an elbow in a shirt sleeve. That helps reduce the transmission of viruses and bacteria.

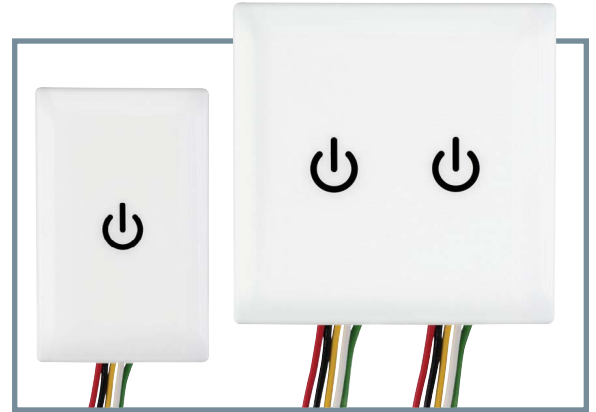

- **Single gang stainless steel, single and 2-gang plastic models are single pole and 3-way capable. The 8A, 120/277Vac switch is compatible with LED, fluorescent and incandescent lighting loads.**
- **3R Rated - able to get wet.**
- **Impact-resistant ABS plastic cover plates features Microban® silver ion antimicrobial technology to suppress bacterial growth.**
- **Plates made of 302/304 grade stainless steel are also available.**
- **These new switches have been tested for aggressive cleaning with: Bleach, Hydrogen peroxide, Alcohol/Quat, Phenols**

Applications

- Hospitals
- Patient Care Facilities
- Testing Centers
- Diagnostic Labs
- Medical Equipment Manufacturing
- Mobile & Temporary Test Trailers
- Field Offices



ScrubSwitch Series

Description	Amperage/ Voltage Rating	Color	Catalog Number	Single Pole	3-Way	4-Way
Tap Switch, 1 Gang with Stainless-Steel Cover Plate	8 AMP, 120/277 Volt	Stainless	WSS1277SS			
Tap Switch, 1 Gang with ABS Plastic Cover Plate	8 AMP, 120/277 Volt	White	WSS1277PW			
Tap Switch, 2 Gang with ABS Plastic Cover Plate	8 AMP, 120/277 Volt	White	WSS2277PW			
Tap Switch, Base Module Only 1 gang - add cover plate	8 AMP, 120/277 Volt	White	WSS1277			
Stainless Steel Cover Plate 1 Gang	NA	Stainless	WSS1SS			
ABS Plastic Cover 1 Gang	NA	White	WSS1PW			
ABS Plastic Cover 2 Gangs	NA	White	WSS2PW			

For additional colors (such as red) and options, see our full line catalog. | Prewired/leaded versions available.

*All units can be used as SP, 3&4-Way. When using for multi-way, additional ScrubSwitches need to be used. Do not use a mechanical switch

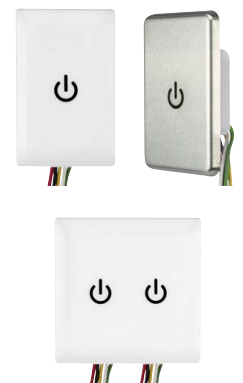

Charging Solutions

Wireless Combination Wall Mount Phone Charger

Simply slide a smartphone into the flexible holder for the increased convenience of wireless charging with no risk of cord-set failure or slow charging from a bad connection. Charge additional devices with either USB Type A or C ports. Electrical power is provided for charging, lighting and accessories. Fits into a standard one gang outlet box. Excellent for renovation or new construction without special requirements in office and administrative areas. Not designed for patient or critical care areas.

- Qi certification assures compliance to wireless charging standards
- Dual coil design optimizes charging, even through protective cases up to ¼ inch thick
- Two LED lights to indicate USB power status and wireless charging status



Applications

- Offices
- Conference Rooms
- Training Rooms
- Administration
- Waiting Areas



Qi Certified Wireless Chargers

Description	Color	Rating	Receptacle	Catalog Number
Wireless wall mount phone charger	White	Coil: 7.5 watt inductive, 125 volt input	-	USB1518
USB combination wireless wall mount phone charger, inductive coil with USB Type A&C ports and tamper-resistant receptacle	White	Coil: 7.5 watt inductive, USB: 5A 5V DC	15A 125V	USB1528AC
			20A 125V	USB2028AC



Ideal for renovation

Easily replaces a duplex receptacle

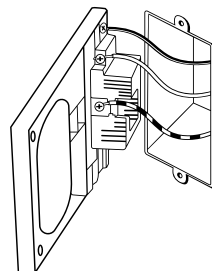

Attach existing wires

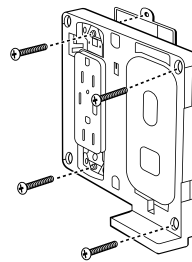

Screw on subplate

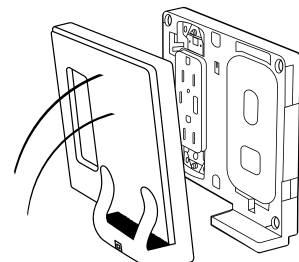

Snap on wallplate

USB Receptacles

Charge your mobile devices where and when you need them. Hubbell's hospital grade USB duplex receptacles provide durability and long life. Using patented advanced solid state design, these devices provide maximum power. Available in both Types A and C USB configurations, these devices provide up to 5 amps of low voltage current to assure there is plenty of power, no matter how many devices you plug in.



- Complies with USB BC1.2 battery charging and 3.0 power delivery specifications
- Suitable for use on AFCI and GFCI protected circuits
- LED light indicates USB power status

Applications

- Nurses stations
- Pharmaceutical prep
- General office
- Charging stations



Hospital Grade USB Charger Receptacles

Description	USB Configuration	15A 125V	20A 125V
Tamper-resistant duplex receptacle, 5 amp, 5 volt DC USB output	(1) Type C, (1) Type A (2) Type C	USB8200AC5W USB8200C5W	USB8300AC5W USB8300C5W

Shown in white. For additional colors, see our full line catalog.

4 Port USB Charger Outlets

Description	USB Configuration	Catalog Number
5 Amp 5 Volt USB A Port, USB C port modulates up to 9 volts for fast charge	(2) Type C, (2) Type A (4) Type C	USB4ACW USB4CW

Shown in white. For additional colors, see our full line catalog.



Pre-Wired Raceway

Facility use has changed, and increased power and data requirements must keep pace with new demands. Hubbell Pre-Wired Raceway Systems accommodate changing requirements while keeping fast track projects on schedule. Our Application Engineers are your partners, completing the take off and providing quotes, preparing layout drawings and shipping products. Available in aluminum, steel and non-metallic, factory pre-cut and pre-wired lengths of raceway arrive ready for installation with all device cover plates, end caps, elbows and other required fittings. And, since aluminum raceway covers and cover plates are cut from the same extrusion, aesthetics are guaranteed.

- Handling and installation time reduces labor costs by up to 45%
- Issue one purchase order for a complete raceway system
- SNAPConnect® devices may be used for future proofing the installation



Applications

- Nurses' Stations
- Laboratories
- Waiting Areas
- Testing Facilities
- Patient Rooms



Hubbell Pre-Wired Raceway Ordering Process

- 1 Contact your Hubbell sales representative and provide specifications and drawings for the project.
- 2 Upon receipt of an order, Hubbell's application engineer will provide a detailed product submittal for customer approval.
- 3 Raceway is shipped in clearly marked cartons with building number, floor, and/or room number referenced for easy job site installation.



Learn more

Find your Hubbell sales representative at hubbell.com/wiringdevice-kellems/en, under the Company tab.



Wall/Trench & Underfloor Duct

Our comprehensive steel and aluminum duct product offering is approved by UL for enclosing wiring to power X-Ray and MRI diagnostic equipment in healthcare applications. The system provides complete lay-in wiring capability and customization to accommodate the large cables and connectors used in today's installations. Wall Duct, when used in combination with Floor trench, provides protection for diagnostic room wiring to power supplies to remote locations. Hubbell's ability to design customized products for challenging projects can be an important resource for contractors and end users looking for the right product to meet demanding applications. Duct is available in a wide variety of widths, depths, and styles.



- **Factory cut to length duct reduces labor time**
- **Duct comes with dividers installed, eliminating on-site assembly**
- **Professional take off service saves time and ensures accuracy**
- **Factory compartmentalized underfloor duct reduces installation labor cost**

Applications

- X-Ray and MRI Diagnostic Rooms
- Fitness/Physical Therapy Centers
- Cafeteria/Retail Cashier Equipment



Hubbell Duct System Ordering Process

- 1** Contact your Hubbell sales representative and provide job name, location, drawings, and specifications for the duct project.
- 2** Quotation and production lead time will be provided. Hubbell includes ground freight charges in each quotation. If submittals are needed, these will be completed once purchase order is issued to Hubbell.
- 3** All trench duct and wall duct orders are shipped under a generic TW prefix number, while floor duct projects are shipped under a generic FD part number.



Learn more

Find your Hubbell sales representative at hubbell.com/wiringdevice-kellems/en, under the Company tab.

Energy Efficiency Solutions

Automatic Receptacle Control

Hubbell load control duplex receptacles are automatically controlled by a low voltage wired or wireless signal from occupancy sensors or other control systems. The integrated relay deactivates the controlled receptacle and any receptacle downstream in the branch circuit eliminating plug load when not in use. Permanent markings on the receptacle clearly identify which outlets are turned OFF when the space is vacant. Hubbell's patented tamper-resistant mechanism provides tamper protection and code compliance for the education market without the difficulty and frustration often experienced with other tamper-resistant receptacles.

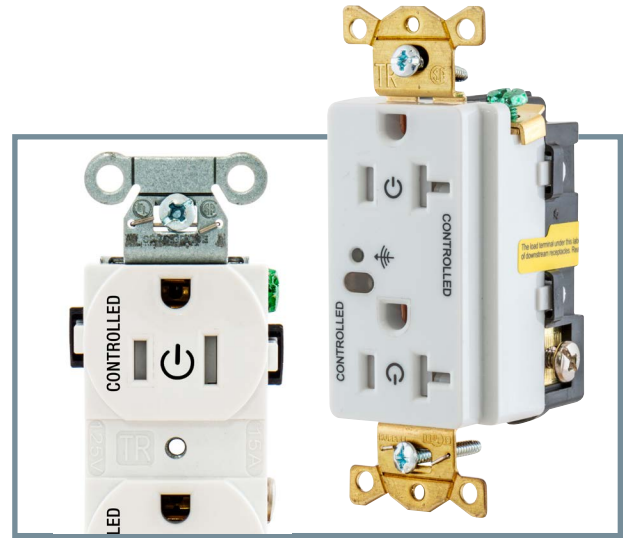

- Comply with ASHE and IEEC energy code requirements
- Meets energy conservation standards
- Wired or wireless solutions
- Integrates with centralized or distributed control systems

Applications

- Offices
- Conference Rooms
- Training Rooms
- Administration



Switched Tamper-Resistant Receptacles for Automatic Receptacle Control

Description		15A		20A	
		Split Circuit	Fully Controlled	Split Circuit	Fully Controlled
Auto ON/Auto OFF control; can control receptacles downstream	Wired	HBL5262LC1W	HBL5262LC2W	HBL5362LC1W	HBL5362LC2W
	Wireless	HBL5262RFC1W	HBL5262RFC2W	HBL5362RFC1W	HBL5362RFC2W

Note: Special order for hospital grade devices. | Shown in white. For additional colors, see our full line catalog.

Heavy Duty Control Units for Automatic Receptacle Control

Description	Catalog Number
Control lighting loads and ARC; use with low voltage occupancy sensors	CU300HD
Add-A-Relay for ARC; use with CU300HD	AAR20P
Wireless transmitter heavy duty control unit; use with wireless ARC	WLCU301

Tamper-Resistant Permanently Marked Receptacles

Description	One Controlled Face Split Circuit Hot Tab		Two Controlled Faces	
	15A	20A	15A	20A
Duplex, back and side wired	BR15C1WHITR	BR20C1WHITR	BR15C2WHITR	BR20C2WHITR
StyleLine® decorator, back and side wired	DR15C1WHITR	DR20C1WHITR	DR15C2WHITR	DR20C2WHITR
	-	8300C1RED	-	8300C2RED
	-	8300C1WHI	-	8300C2WHI

Note: Special order for hospital grade devices. | Shown in white. For additional colors, see our full line catalog.





Adaptive Technology

Adaptive Technology is Hubbell's patented breakthrough in advanced controls that eliminates manual adjustment. Available on the majority of our occupancy/vacancy low voltage and switch sensors, smart microprocessors constantly monitor the controlled area and adjust the sensitivity and timer based on environmental history and automatically adjust for seasonal changes, modified airflow, furniture layout or occupancy pattern changes. No initial configuration is required, making this an "install and forget" solution.

0-10V Dimming Control

Low voltage and line voltage wall switches with 0-10V dimming provide occupancy based control plus standard compliant, smooth dimming operation. Increased adjustability of the lighting level can enhance learning environments.



Adaptive Dual Technology Dimming Sensors

Description	Catalog Number
0-10V dimming; Auto ON or Manual ON	ADD2000W1
120-277V AC Manual ON/Auto OFF	ADD2001W1

Shown in white. For additional colors, see our full line catalog.

Low Voltage Wall Switches with 0-10V Dimming

Description	Catalog Number
Manual ON operation	DSM010W
Auto ON operation	DSL010W

Shown in white. For additional colors, see our full line catalog.

Adaptive Dual Technology Ceiling Mount Sensors

Description	Voltage	Coverage Area	
		2000 sq. ft. (360°)	1000 sq. ft. (180°)
Low voltage sensor	24V DC	ATD2000CRP	ATD1000CRP
Line voltage sensor	120-277V AC	ATD2000CL	ATD1000CL

Low voltage ceiling sensors must use a CU300 series control unit.
Low voltage sensors include isolated relay and photocell.

Control Unit

Description	Catalog Number
100-277V AC, 50/60Hz Manual ON operation	CU300M
Automatic ON operation	CU300A



Twist-Lock® EdgeConnect™

Hubbell's innovative, patented Twist-Lock devices with screwless terminations are the fastest termination devices on the market. Strong steel springs continuously apply pressure to wires, ensuring a strong connection in the most abusive environments.

- No need for torque screwdriver
- Strong steel spring helps prevent strand relaxation
- No exposed metal at the termination point
- Molded in leverage point for unwiring
- Superior cord grip design protects terminations from excess strain
- High performance, reliable terminations for maintaining trouble free connections
- High impact nylon construction with voltage color coding resists abuse and facilitates easy identification

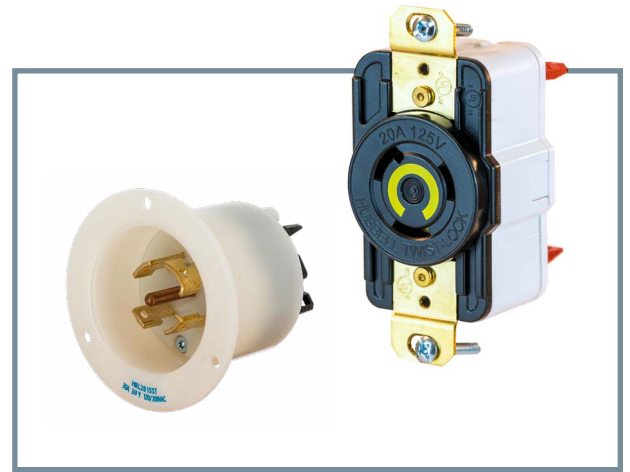

Applications

- Laboratories
- Maintenance
- Food Service
- Temporary Power & Generators



Twist-Lock Insulgrip® Plugs

Description	Poles/Wires	Rating	20 Amp	30 Amp
Screwless termination locking plugs	3P/4W	125/250V	HBL2411ST	HBL2711ST
		3Ø 250V	HBL2421ST	HBL2721ST
		3Ø 480V	HBL2431ST	HBL2731ST
	4P/5W	3ØY 120/208V	HBL2511ST	HBL2811ST
		3ØY 277/480V	HBL2521ST	HBL2821ST

Twist-Lock Flanged Inlets

Description	Poles/Wires	Rating	20 Amp	30 Amp
Screwless termination locking flanged inlets	3P/4W	125/250V	HBL2415ST	HBL2715ST
		3Ø 250V	HBL2425ST	HBL2725ST
		3Ø 480V	HBL2435ST	HBL2735ST
	4P/5W	3ØY 120/208V	HBL2515ST	HBL2815ST
		3ØY 277/480V	HBL2525ST	HBL2825ST

Twist-Lock Single Receptacles

Description	Poles/Wires	Rating	20 Amp	30 Amp
Screwless termination locking receptacles	2P/3W	125V	HBL2310ST	HBL2610ST
		250V	HBL2320ST	HBL2620ST
	3P/4W	125/250V	HBL2410ST	HBL2710ST
		3Ø 250V	HBL2420ST	HBL2720ST
	4P/5W	3Ø 480V	HBL2430ST	HBL2730ST
		3ØY 120/208V	HBL2510ST	HBL2810ST
	3ØY 277/480V	HBL2520ST	HBL2820ST	

Removal bridge, for use with all Twist-Lock Edge Series receptacles **HBLSTRB**

Receptacles, Connectors, and Flanged Receptacles

Description	Poles/Wires	Rating/Amp	Cat No
Locking Connector	2P/3W	30A 250V	HBL2623ST
		20A 250V	HBL2323ST
		20A 125V	HBL2313ST
		30A 125V	HBL2613ST
		20A 277V	HBL2333ST
		20A 480V	HBL2343ST
	Locking Flanged Receptacle	20A 250V	HBL2326ST
		30A 250V	HBL2626ST
		20A 125V	HBL2316ST
		30A 125V	HBL2616ST



Hubbelock®

Hubbelock devices feature an exclusive design: the spring-loaded safety shutter in both connectors and receptacles prevents the possibility of “lazy” connections. The shutter automatically ejects the plug if it hasn’t been properly locked into the female device. This is particularly important in operating rooms or emergency rooms, where presence of power is critical. The shutter mechanism also snuffs out arcs that may occur when connecting and disconnecting under load.



- **3-5 top features**
- **Stainless steel metallic components ensure corrosion resistance**
- **Enhanced safety because access to live contacts are restricted**
- **No lazy connections due to spring loaded shutter on connectors and receptacles ensuring a positive connection**

Applications

- 3-6 applications
- Mobile X-ray equipment
- Operative rooms
- Emergency rooms



Mobile X-ray Plugs & Receptacles

Description	50A 250V AC	60A 250V AC
Plug	with epoxy kit, less cord clamp	HBL25515
	with cord clamp, less epoxy kit	HBL25525
Receptacle	with stainless steel plate assembly	HBL25505
	with cast aluminum plate assembly	HBL25503
	replacement receptacle interior	-
		HBL25615
		HBL25625
		HBL25605
		HBL25603
		IN16494



Hubbelock Devices

Description	20A 125V AC
Plug	Nylon cover, thermoset interior
	Armored, epoxy filled, rubber cord grip
Connector	Nylon cover, thermoset interior
Receptacle	Black, back wired
	HBL23014HGB
	HBL23004HG
	HBL23001HGB
	HBL23000HG



Hubbell SystemOne

Floor Boxes

Hubbell SystemOne 4" recessed floor box features a patented installation cup and prewired 4-outlet plates that reduce labor costs. Hubbell SystemOne 2-, 4-, 6- and 10-gang floor boxes are available with round or rectangular covers, prewired device plates include receptacles, extender caps for polished concrete installations or deep concrete pours.

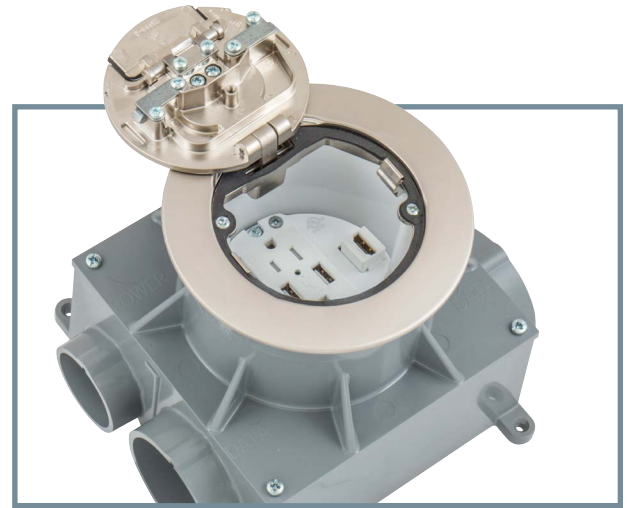

- Data and AV open system sub-plates satisfy customer requirements
- Low profile flange exceeds ADA requirements
- Recessed activation protects cables and connections
- Same round cover design offer synergy between floor box and FRPT installations
- UL 514A Listed covers meet scrubwater requirements

Applications

- Physical Therapy and Fitness Areas
- Conference Rooms
- Offices
- Cafeterias

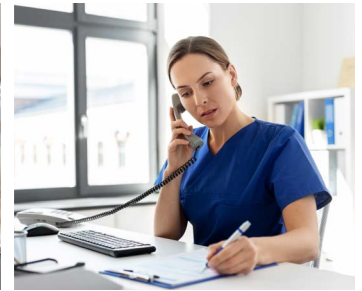

Hubbell SystemOne Floor Boxes

Description	4" Round Covers	6" Round Covers		8" Round Covers		
			2-Gang	4-Gang	6-Gang	10-Gang
Floor Boxes	Non-Metallic	CFBS1R4PFB*	—	—	—	—
	Stamp Steel	CFBS1R4SFB*	CFB2G25R CFB2G30R	CFB4G25R CFB4G30R	CFB6G30R	CFB10G55R
	Corrosion Resistant	CFBS1R4SFBCR*	CFB2G25CR CFB2G30CR	CFB4G25RCR CFB4G30RCR	CFB6G30RCR	CFB10G55RCR
Sub-Plates	Decorator	S1R4SPSTYLE	FBMPREC	FBMPREC	FBMPREC	FB10MPREC
	Duplex	S1R4SPDUPLEX	FBMPDUP	FBMPDUP	FBMPDUP	FB10MPDUP
Covers	Aluminum	CFBS1R4CVRALU	CFBS1R6CVRALU	CFBS1R8CVRALU	CFBS1R8CVRALU	CFBS1R8CVRALU
	Black	CFBS1R4CVRBLK	CFBS1R6CVRBLK	CFBS1R8CVRBLK	CFBS1R8CVRBLK	CFBS1R8CVRBLK
	Brass	CFBS1R4CVRBRS	CFBS1R6CVRBRS	CFBS1R8CVRBRS	CFBS1R8CVRBRS	CFBS1R8CVRBRS
	Bronze	CFBS1R4CVRBRZ	CFBS1R6CVRBRZ	CFBS1R8CVRBRZ	CFBS1R8CVRBRZ	CFBS1R8CVRBRZ
	Gray	CFBS1R4CVRGRY	CFBS1R6CVRGRY	CFBS1R8CVRGRY	CFBS1R8CVRGRY	CFBS1R8CVRGRY
	Nickel	CFBS1R4CVRNKL	CFBS1R6CVRNKL	CFBS1R8CVRNKL	CFBS1R8CVRNKL	CFBS1R8CVRNKL

Note: *Requires CFBS1R4CUP

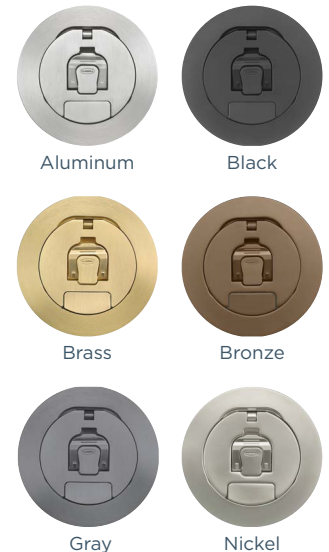

Fire-Rated Poke-Throughs

Hubbell SystemOne Recessed Fire-Rated Poke-Throughs (FRPT) enhance functionality by providing increased power, data and AV capacity. Our 4", 6", 8" and 10" product offering will meet every requirement for today's applications and for future expansion.

- Maintains concrete floor fire rating up to two hours
- Low profile flange exceeds ADA requirements.
- Large cable egress doors egress doors that hinge inwards
- Works with time and labor saving concrete pre-pour tubes
- Furniture feed covers also available



Applications

- Physical Therapy and Fitness Centers
- Conference Rooms
- Offices
- Cafeterias



Hubbell SystemOne Fire-Rated Poke-Throughs

Description	4" Round Covers	6" Round Covers	8" Round Covers	10" Round Covers
Fire-Rated Poke-Throughs	S1R4PTFIT	S1R6PTFIT	S1R8PTFIT	S1R10PTFIT
Quad	S1R4SPQUAD	S1R6SPH	—	—
Quad Marked Controlled	—	S1R6SPHC4	—	—
Duplex	—	S1R6SPZ	S1R8PSPZ	S1R10PSPZ
Duplex Marked Controlled	—	S1R6SPZC	S1R8PSPZC	S1R10PSPZC
Sub-Plates				
Duplex Blank	S1R4SPDUPEX	S1R6SPI	S1R8CSP	S1R10CSP
Duplex Tamper Resistant	—	S1R6SP3RTR	S1R8PSPZTR	S1R10PSPZTR
StyleLine Blank	S1R4SPSTYLE	S1R6SPK	S1R8CSPK	S1R10CSPD
2-Gang StyleLine AV	—	S1R6SPW	S1R8CSPM	S1R10CSPM
Covers				
Aluminum	S1R4CVRALU	S1R6CVRALU	S1R8CVRALU	S1R10CVRALU
Black	S1R4CVRBLK	S1R6CVRBLK	S1R8CVRBLK	S1R10CVRBLK
Brass	S1R4CVRBRS	S1R6CVRBRS	S1R8CVRBRS	S1R10CVRBRS
Bronze	S1R4CVRBRZ	S1R6CVRBRZ	S1R8CVRBRZ	S1R10CVRBRZ
Gray	S1R4CVRGRY	S1R6CVRGRY	S1R8CVRGRY	S1R10CVRGRY
Nickel	S1R4CVRNKL	S1R6CVRNKL	S1R8CVRNKL	S1R10CVRNKL

Note: S1R6SP3RTR is triplex TR receptacle



S1R4CVRALU



S1R6CVRBLK



S1R8CVRBRS



S1R10CVRNKL

Medical Grade Cord Reels

Cord Reels

From the inventors of Hospital Grade electrical devices, Hubbell introduces inREACH™ cord reels that provide safe and convenient power designed specifically for medical facilities.

Hospital Grade plugs and receptacles provide the most reliable performance in demanding medical applications. The all-white construction complies with sanitary practices by making contamination more visible and easier to clean.

Listings and Certifications:

- UL355 CSA C22.2 No. 308
- UL498 Supplement SC Hospital Grade
- UL 943, Section 6.7.2.1
- Fed. Spec. W-C-596

Plenum Rated Enclosure

Hubbell's inREACH plenum rated enclosure is the first of its kind, allowing customers to securely mount cord reels in drop ceilings, while isolating it from the plenum space. These enclosures are Listed to UL2416, making them compliant with plenum requirements per the NEC.



A cast aluminum housing withstands corrosive environments



Hospital grade, tamper-resistant receptacles provide four plug-in points, and a fully-illuminated LED face clearly indicates available power.



An optional inline GFCI module provides Class A ground fault protection even when the neutral conductor is compromised.

Plenum Rated Box features & Dimensions

- Steel enclosure, white powder coat surface finish
- UL 2416 Listed; CAN/CSA C22.2 No 60950-1-07, compliant with plenum requirements per NEC300.22
- Accepts most Hubbell inREACH industrial cord reels
- 4 in. square electrical box included
- Pre-punched knockout hole

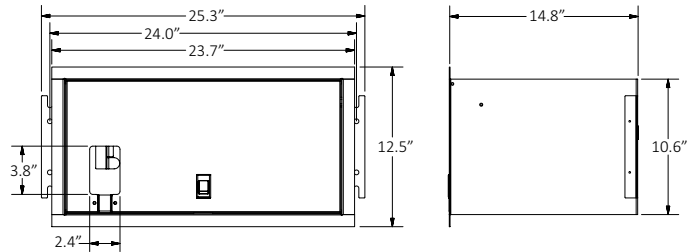

inREACH Industrial Cord Reels

Description	Amps	Voltage	Cable Length ft (m)	Cable Type	Weight lbs. (kg)	Catalog Number
White reel, white portable outlet box, GFCI module, and (2) 20A Hospital Grade receptacles	20A	125V AC	45 (13.7)	12/3 SJO	34.9 (15.8)	HBLIWC45123GF220HG
White reel, white portable outlet box, and (2) 20A Hospital Grade receptacles	20A	125V AC	45 (13.7)	12/3 SJO	34.4 (15.6)	HBLIWC45123R220HG
White reel and Hospital Grade connector HBL8319C	20A	125V AC	45 (13.7)	12/3 SJO	33.6 (15.2)	HBLIWC45123C20HG

For additional cord reel configurations, please view our online resources below, or contact your local Hubbell representative.

Plenum Rated Enclosure for inREACH Cord Reels

Description	Weight lbs. (kg)	Catalog Number
Plenum rated enclosure	30.0 (13.6)	HBLIPRBOX



Services

Ready to increase installation efficiency with quality products? We're here to help.

Space design, jobsite challenges and wiring systems are changing. We can help make the most of the newest innovations so you can focus on successfully completing more projects in less time.

From new construction and renovations to industrial, commercial, medical or residential structures, we manufacture quality systems that reduce installation time and support the latest design aesthetics. We also partner with several companies to make specifying, installing and using Hubbell products easy, and efficient.

Project Design

Our team of Application Engineers support project design work, from bid to installation for several Hubbell product lines including:

- Trench, wall and underfloor duct
- Pre-wired raceway
- CONNEXION plug-n-play raised access floor power distribution systems
- Lighting control/occupancy sensor layout and design

Takeoff Services

Hubbell Application Engineers can perform pre- or post-bid takeoffs for a variety of product lines:

- Wiring Devices
- Floor Boxes
- Fire-Rated Poke-Throughs
- Wire Basket Tray Systems
- Sensors
- Surface Raceway
- Power Poles

Submittal Builder

Hubbell's industry best submittal builder is available for distributors, contractors, and others on Hubbell's public website. Submittals can include all or some of the following documents: catalog page, data sheet, drawing and installation instructions. A link to the submittal, or a PDF copy, can easily be emailed.

- Fast
- Professional
- Thorough

Hubbell Duct Solutions			Quote No: ABC-1234-2018
Date: 8/1/2018			
Job Name: Memorial Hospital Renovation			
Location: United States of America			
Contractor: ACME Electric			
Qty	Catalog Number	Description	Price
	CT Scan RM 1105		
1	OKA/D6-2C-1/4	Two Compt Trench Duct 3-1/2 x 6 x 72 with 1/4 Cover	
1	OKA/D6-2C-1/4 x 24	Two Compt Trench Duct 3-1/2 x 6 x 24 with 1/4 Cover	
2	OKL5/D6-2C-1/4	Two Compt Trench Duct Horizontal 25 Elbow 3-1/2 x 6	
2	OKE/D6	Trench Duct End Cap 3-1/2 x 6	
1	DWR/DF	Trench to Wall Duct Riser 3-1/2 x 6 Flush	
3	OWA/D6S	Wall Duct 3-1/2 x 6 x 60 with Surface Cover	
4	DWE/D6S	Wall Duct End Cap 3-1/2 x 6 Surface	
6	OWA/DF	Wall Duct 3-1/2 x 6 x 60 with Flush Cover	
2	DWB/D6-6	Wall Duct Flush to Surface Adapter 6 - 6	
5	DWE/DF	Wall Duct End Cap 3-1/2 x 6 Flush	
1			
9	OWP/D	Wall Duct Divider	
1	GROM-15	15' Grommet Material	

Example Duct Takeoff and Quotations

Project Name : Community College		Address :		Take-off : Aluminium Raceway		Date on Drawing : 5/7/2018		Prepared By : T. Williams, Engineer	
SL No.		Product	Catalog No.	Qty	Unit	Bill of Material			
1		Raceway-1	HBLAL1380010 Series	500	ft	Catalog Links			
		Single Channel Base	HBLAL13800B10	500	ft	Click Here			
		Single Channel Cover	HBLAL1UC5	500	ft	Click Here			
		Wire Clip	HBLAL1WC	150	ea	Click Here			
		Coupling (Pair)	HBLAL1C01	25	ea	Click Here			
		Blank End Fitting	HBLAL1E10B	80	ea	Click Here			
		Duplex receptacle on Raceway	-	72	ea	-			
		Coverplate for Duplex receptacle on Raceway	-	72	ea	-			
		Emergency Duplex receptacle on Raceway	-	50	ea	-			
		Coverplate for Emergency Duplex receptacle on Raceway	-	50	ea	-			
		Emergency GFI Duplex receptacle on Raceway	-	50	ea	-			
		Coverplate for Emergency GFI Duplex receptacle on Raceway	-	50	ea	-			

Scale Notes:

1. The length measuring tool used for our takeoff activity is PDF Exchange Viewer. The default scale in this tool is 1 inch = 1 inch.
2. For this Project, Numeric Scale from the drawing sheet is 1/8" = 1'-0". So 1'-0" means each section length measured in inches from the db.
3. To ensure the correctness of scale, we have also measured the doorways and have ensured as 3 ft.

General Notes:

1. We have tried assigning catalog numbers referring raceway descriptions given in drawing sheets/ Specsheets.
2. Conduit Raceways are not considered in this takeoff.
3. Receptacles on raceways are calculated for the purpose of coverplates calculations only.

Example Takeoff

Shelton Elementary School Submittal		
Table of Contents		
SKU	Asset Type	Page
SNAP5362WA	eCatalog Page	2
	CAD Drawing	3
GFRST20SNAPW	Installation Instructions	4
	eCatalog Page	6
	CAD Drawing	7
SNAP20USBW	Installation Instructions	8
	eCatalog Page	11
	CAD Drawing	12
SNAP2RA	Installation Instructions	13
	eCatalog Page	14
	CAD Drawing	15
	Installation Instructions	16
SNAPSP2NA	eCatalog Page	18
	CAD Drawing	19
	Installation Instructions	20

A HUBBELL COMPANY OUR BRANDS

HUBBELL NEWS MARKETING TRAINING SALES COMPANY

Submit Builder

Please enter your list of SKUs (or paste in from excel, etc) and choose which asset types you'd like included in your submittal package.

eCatalog Pages

Spec Sheet

Drawing

Installation Instructions

Package Title (Project)

SKUs

BUILD SUBMITTAL PACKAGE

Create a submittal at hubbell.com/wiringdevice-kellems/en

Product Resources

CAD and PDF drawings are available for download on Hubbell's public website with detailed dimensional information on all Hubbell products.

A large library of Isometric and Flat product drawings for use in engineering plans are also housed on Hubbell's public website. These are ideal for ensuring that the electrical contractors are clear on the product that is required for all varieties of projects.

Hubbell has partnered with a number of companies that provide additional resources to our design engineer customers and our design build contractors.



BSD Softlink

Hubbell and BSD Softlink partner to provide Hubbell specifications through BSD's specification service.



BIM Object

Hubbell and BIM Object partner to provide BIM models for a wide variety of Hubbell products on BIM Objects industry leading BIM warehouse site.



MasterSpec

Hubbell partners with MasterSpec to provide CSI MasterFormat specifications on MasterSpec's industry leading site.



ConstructConnect

From pre-planning to post-bid, ConstructConnect provides Hubbell's sales team access to current plans and specifications for many public and private construction projects across the United States.

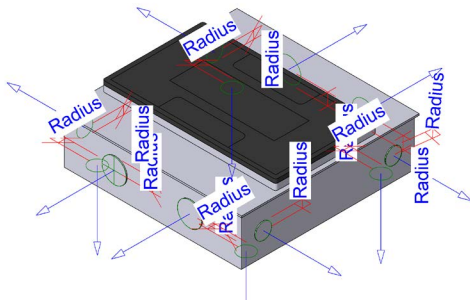

Comprehensive library of BIM models for design engineers and design/build contractors

Flat and isometric drawings for use on design engineer plans

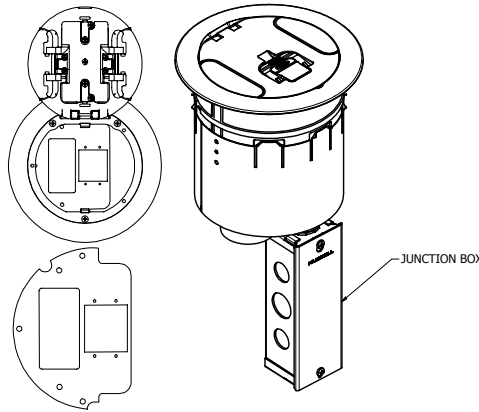

S1R6SPX

S1R6PTFIT

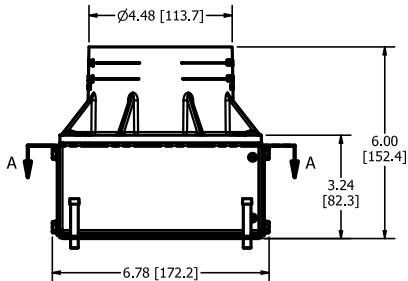

Product drawings with dimensional data in PDF and DWG formats

Export to PDF
Actions
Share
Download Documents

★ Woodland Heights Middle School

Project ID # 1004638560

Junior High Schools

Street Address: 288 Forest Lake Blvd., Mooresville, NC 28117

Country: Ireland

Architect: Moseley Architects - Raleigh-Durham Office

Documents Available: Plans, Specs available in Insight

Plans available from Architect Moseley Architects - Raleigh-Durham Office

Last Updated: 07/31/2018 Project reviewed, Stage confirmed as Biddate Set

[View All Updates](#)

Staff Estimate Value

\$10,000,000

Stage

Bidding - Biddate Set

Bid Date

8/23/2018 03:00PM

ConstructConnect Example Project

Healthcare Product Solutions



Critical Care



Patient Care



Public Spaces

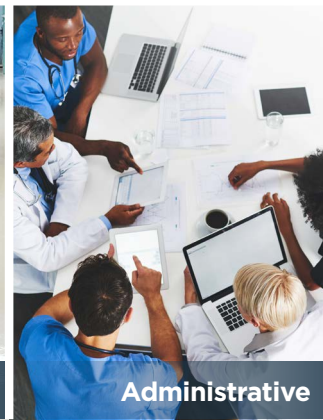

Administrative



Services



SNAPConnect® Devices



Hubbell SystemOne Floor Boxes and FRPTs



Hospital Grade Devices



Charging Solutions



Pre-Wired Raceway

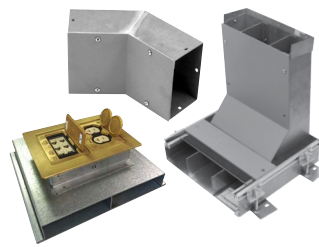

Wall/Trench and Underfloor Duct



Twist-Lock Devices



Adaptive Technology and Wireless Load Control

Hubbell Product Literature



10 Inch Fire-Rated Poke-Throughs



Wire Basket Tray



Fully Adjustable 4 Inch Round Recessed Floor Boxes

HUBBELL[®]
Wiring Device-Kellems

www.hubbell.com/wiringdevice-kellems/en



Hubbell Wiring Device-Kellems • Hubbell Incorporated (Delaware) • 40 Waterview Drive • Shelton, CT 06484 • Phone (800) 288-6000 • FAX (800) 255-1031

Printed in U.S.A. Specifications subject to change without notice.

® is a registered trademark of Hubbell Incorporated.

WLBVM035 3/23