



# trade**SELECT**<sup>®</sup>

INDOOR • INDUSTRIAL • OUTDOOR • LIFE SAFETY • CONTROLS



# tradeSELECT®

A collection of quality-driven indoor, industrial, outdoor, life safety and control solutions designed for the electrical contractor

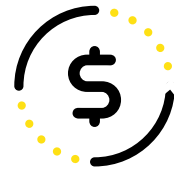

## VALUE FOCUSED

tradeSELECT offers Electrical Contractors a value-focused, budget friendly solution with some of our most popular products to get the job done right.



## CONVENIENT

tradeSELECT products are stocked and ready to ship from our five strategically located Distribution Centers and readily available through your preferred authorized Electrical Distributor.



## RELIABLE

tradeSELECT provides a collection of products you can rely on, backed by Hubbell Lighting brands that you can trust and designed with the contractor in mind.

*NEW* INDOOR FAMILIES,  
*NEW* OUTDOOR FAMILIES,  
*NEW* CONTROLS FAMILIES,  
COUNTLESS REASONS FOR  
YOU TO *Select Better...*

tradeSELECT®

### PARTICIPATING BRANDS

Columbia  
LIGHTING

HUBBELL®  
Outdoor Lighting

COMPASS®

HUBBELL®  
Control Solutions

# TABLE OF CONTENTS

INDOOR.....12	MINI COLT.....39	CS.....60
CCL.....13	MARSHAL.....39	CWC.....61
CFP.....14	FLOODLIGHT	CEW.....61
CBT.....15	PRODUCT SELECTION GUIDE.....40	CC SQ.....62
PANELS & TROFFERS	WALLPACKS MOUNTING	CCE.....62
PRODUCT SELECTION GUIDE.....16	HEIGHT GUIDE.....42	CEL.....63
CTK.....18	SLING WALLPACKS.....43	RME.....64
RETROFIT	WGH.....44	CSR.....64
PRODUCT SELECTION GUIDE.....19	PRS.....45	CU2W.....65
CNW.....20	NRG® 300L.....45	CU2.....65
CWP.....20	WALLPACKS	CU2SQ.....66
CRW.....21	PRODUCT SELECTION GUIDE.....46	CU2FO.....66
CUC.....21	SLING SGD DUSK-TO-DAWN.....48	CU2SO.....67
WRAPS	PATROLMAN.....48	CUW.....67
PRODUCT SELECTION GUIDE.....22	DUSK-TO-DAWN	CSWEU2LED.....68
CSL.....24	PRODUCT SELECTION GUIDE.....49	CUSO.....68
STRIPS	SLING CANOPY.....50	CIR.....69
PRODUCT SELECTION GUIDE.....26	CANOPY	COR.....69
CVT.....28	PRODUCT SELECTION GUIDE.....51	CONTROLS.....70
VAPORTITES	VAPORTITES.....52	CX LIGHTING CONTROL SYSTEMS 71
PRODUCT SELECTION GUIDE.....30	VAPORTITES	LIGHTHAWK®.....72
CHB.....32	PRODUCT SELECTION GUIDE.....53	LIGHTHAWK®
LINEAR HIGH BAY	LIFE SAFETY.....54	PRODUCT SELECTION GUIDE.....73
PRODUCT SELECTION GUIDE.....33	EXIT AND EMERGENCY	WASP.....74
CRN.....34	HEIGHT AND SPACING GUIDE.....55	OMNI® DUAL TECHNOLOGY.....75
ROUND HIGH BAY	CC.....56	OMNI® LOW VOLTAGE PIR.....76
PRODUCT SELECTION GUIDE.....35	CE.....57	POWER PACKS.....76
OUTDOOR.....36	CELEM.....58	UL924.....77
FLOODLIGHT BEAM	CU2HL.....58	WALLBOX DIMMERS.....78
SPREAD GUIDE.....37	CPL25.....59	LOW VOLTAGE SWITCHES.....78
ALF 6/12.....38	CELC.....59	
COLT LBUL.....38		

LOOK OUT FOR  
THE ULTIMATE  
PRODUCT SELECTION GUIDES

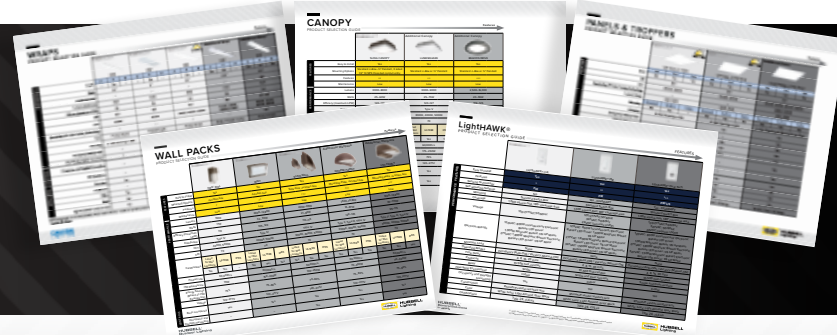

# tradeSELECT® MARKET SOLUTIONS



## COMMERCIAL SOLUTIONS

Hubbell Lighting leads the commercial lighting market by providing a wide array of luminaire and controls options. No application is too big or too small given Hubbell's industry leading performance, quality and energy efficiency. With our wide variety of products we can light the interior and exterior of any commercial space.



**CBT Back-Lit Troffer**  
Columbia Lighting

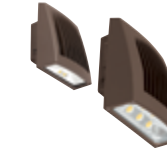

**SLING Wallpack**  
Hubbell Outdoor Lighting



**CE Exit**  
Compass

## INDUSTRIAL SOLUTIONS

Hubbell Lighting's innovative, industrial product portfolio is at the forefront of the lighting industry. Our luminaires and controls provide solutions to applications such as warehouse, distribution centers, light to heavy industrial, food processing and transportation.



**CHB**  
Columbia Lighting



**SLING Dusk-to-Dawn**  
Hubbell Outdoor Lighting



**CWC Wet Location Exit/Emergency**  
Compass



## INSTITUTIONAL SOLUTIONS

Key requirements for institutional lighting includes architectural aesthetics, performance, value and quality. Hubbell Lighting has a broad collection of products across multiple categories, which enable your customers to select the best solution for their specific applications.



**CRN Round High Bay**  
Columbia Lighting



**SLING Canopy**  
Hubbell Outdoor Lighting



**CEL Edge-Lit Exit**  
Compass

# LIGHTING LEADERSHIP

Hubbell Lighting is a trusted name, born from early innovations sought after for new technology. With tradeSELECT, you will find the lighting and control solutions you need day into night. From ambient to task to security and safety illumination, Hubbell Lighting has a solution. Hubbell Lighting assures that form, performance and reliability meet today's demanding expectations through the highest quality materials from among the top component suppliers in the industry.



COLUMBIA-CBT

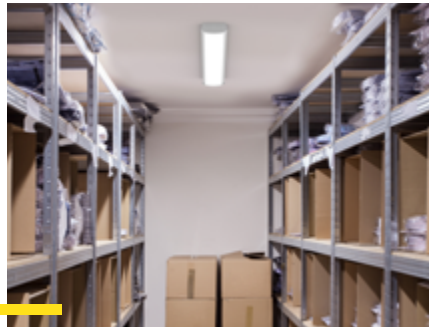

COLUMBIA-CNW



OUTDOOR-SLING

Through rigorous multi-level testing procedures, performed by in-house and partner accredited laboratories, Hubbell Lighting validates luminaire specifications prior to release. The demanding testing protocol simulates real life cases to assure a reliable performance. We engineer the luminaire design to withstand the elements, exceed safety, and code requirements and deliver quality illumination for occupants of its installation.

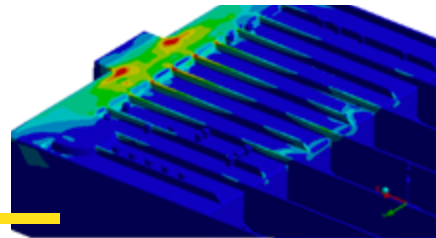

THERMAL TESTING

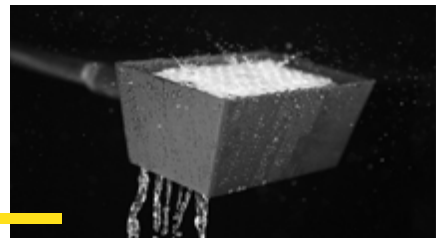

IP TESTING



ELECTRICAL TESTING

Every Hubbell Lighting luminaire is tested in manufacturing and goes through a dedicated burn-in process that has resulted in minuscule defect rates that support years of trouble-free operation. Our quality control operations are evaluated by Hubbell team members. Our strong product warranty is evidence of our confidence in the quality, reliability and value in every tradeSELECT luminaire and control solution.

# SERVICE FIRST APPROACH

Convenience is one of the pillars of tradeSELECT. Products within this collection are stocked throughout Hubbell Lighting's distribution center network. Delivered to your dock or picked up via will call, tradeSELECT is the solution to your stock and flow lighting needs.

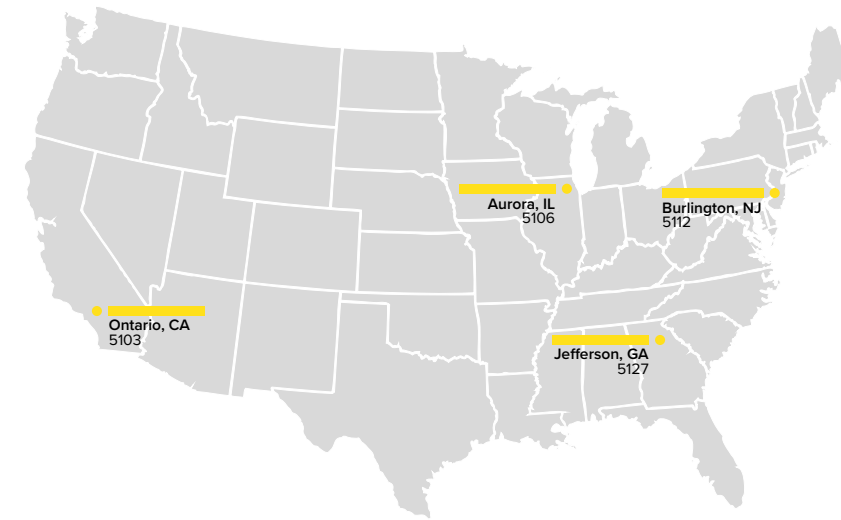

## LOCAL DISTRIBUTION STOCK

Strategically placed Regional Distribution Centers (RDC) are stocked with tradeSELECT luminaire and control solutions. Real time inventory status is available on each tradeSELECT product website page under the stocked items tab.

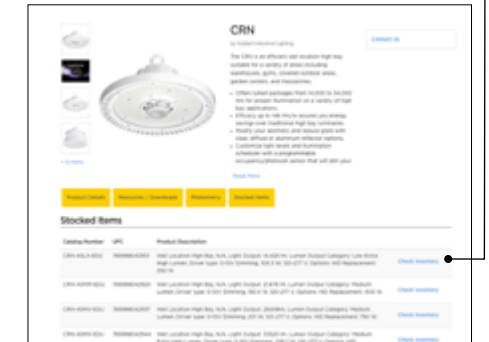

## QUICK-SHIP

For made-to-order products with abbreviated lead times, our Quick-Ship programs feature a collection of products available in as little as five days. For the full offering of Quick-Ship products please visit [HubbellLighting.com](http://HubbellLighting.com) and look for Quick-Ship under Resources.

# CERTIFICATIONS



Easily locate qualifying DLC product numbers in the ordering information tables.

Hubbell Lighting's Partnerships with DesignLights Consortium (DLC®), ENERGYSTAR®, UL and CSA assure our products are designed to meet and exceed industry standards. The DLC® (DesignLights Consortium) and DLC Premium Qualified. Please refer to the DLC website for specific product qualifications at [www.designlights.org](http://www.designlights.org)



# tradeSELECT® FOR RETROFIT OPPORTUNITIES



## NO RISK TRIAL INSTALLATION

Hubbell Lighting's Compare in the Air program allows you to see the results of a lighting retrofit or renovation real-time in your facility with no risk!

Grounded in serving customers' needs, Hubbell Lighting understands there's no one size fits all solution, especially for unique applications, offering lighting and control solutions that span the full spectrum for new construction and retrofit projects.

### 4 EASY STEPS

- STEP 1 – SELECT UP TO FOUR QUALIFYING PRODUCTS
- STEP 2 – MARK THE ORDER “COMPARE IN THE AIR”
- STEP 3 – RECEIVE A 90-DAY DATING TERMS ON YOUR ORDER
- STEP 4 – INSTALL THE PRODUCTS AND SEE THE RESULTS\*

Whether you are completing a retrofit and upgrading inefficient lighting systems, or starting from the beginning, Hubbell Lighting's createchange® resources help you find the solution for your space.

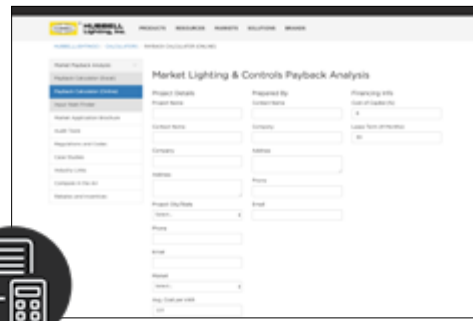

**MARKET PAYBACK ANALYSIS**  
Online ROI calculator to show how a new tradeSELECT lighting system can achieve payback goals.

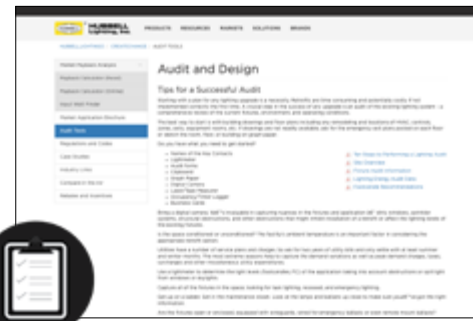

**AUDIT TOOLS**  
Having the right tools is a crucial step in the success of a lighting audit. Download prepared tools off the createchange website.

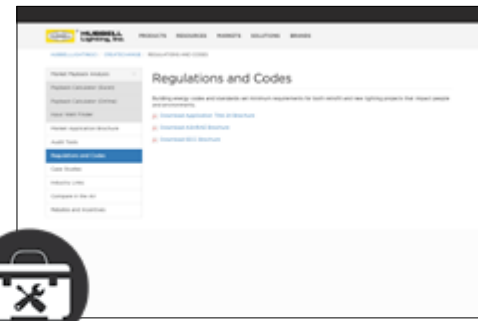

**REGULATIONS & CODES**  
Energy efficient tradeSELECT products support compliance with building energy codes and standards.

# TOOLS FOR tradeSELECT®

## QUICK DESIGN LAYOUT TOOL

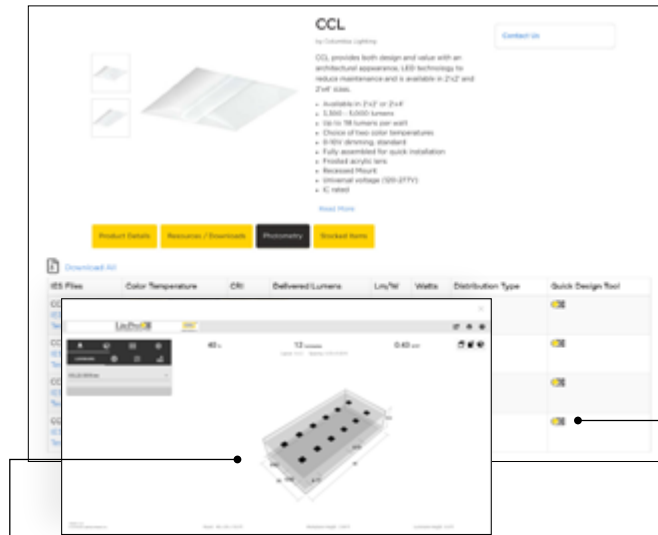

Hubbell Lighting's LitePro QD (Quick Design) Layout Tool allows you to compute iso-contours and point by point illuminance for selected fixtures. Use our Quick Design Tool to get the most out of tradeSELECT.

Look for the QD logo next to select fixtures' IES files, simply click on the logo and the application will launch in a separate window.

## CROSS REFERENCE

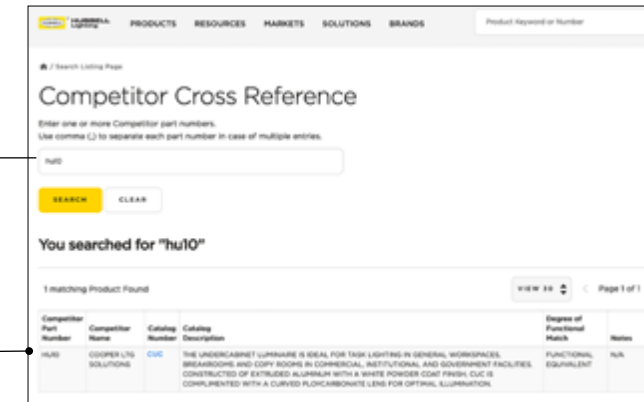

Online cross reference tool allows users to search a competitor's part number prefix to find the closest Hubbell Lighting match for tradeSELECT® products.

## mediaplus

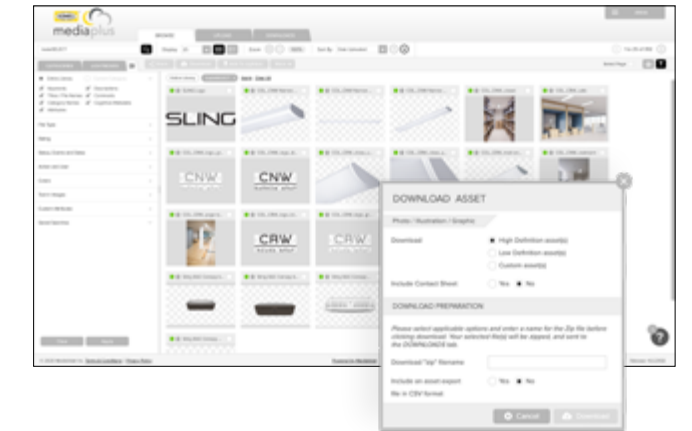

search download share

mediaplus allows users to search, download and share tradeSELECT content quickly and easily. Simply, search through prepopulated folders to access preformatted promotional material.

## REBATE SEARCH



Get access to the latest data from over 3,000 utility programs across North America for tradeSELECT® products on the DesignLights Consortium® Qualified Product Listing with our Rebate Search Tool.

# LET tradeSELECT® DO THE SELLING

Hubbell Lighting's tradeSELECT merchandising helps drive revenue with interactive and operational displays. When gondolas are stocked with product in informative full color packaging in counter areas, they provide the opportunity for immediate purchase!

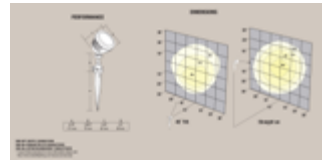

Hubbell Lighting's tradeSELECT® products are supplied in full color packaging and labels. The packaging features a large color product image, product specifications, features and benefits and lighting application example.



Hubbell Lighting has abbreviated commonly ordered part numbers for easier and quicker processing. For those everyday stock and off the shelf opportunity orders look for short catalog logic.

When displayed in available merchandising gondolas, wall boards and clouds, the product and packaging help sell themselves!



GONDOLA DISPLAY



WALL DISPLAY



COUNTER DISPLAY



CEILING CLOUD

Contact your Hubbell Lighting representative to learn what merchandising display and sales support is available.

# SWITCHABLE SOLUTIONS



## FIELD ADJUSTMENTS FOR EVERY APPLICATION

Switchable luminaires offer field adjust-ability of lumen output, color temperature or both-lumen and CCT. Simplify with the features of up to 9 in 1 SKU! Reduce inventory on the shelf, reduce inventory costs and reduce stock outs with Switchable luminaires.



## ORDER ONE SKU AND GET THE FEATURES OF UP TO 9 WITH 3 LUMEN OUTPUTS AND 3 CCTS

Accounting for higher mounting heights or warmer color temperatures is as easy as moving the switch! Switches are easily accessible and clearly labeled for simple selection of settings

## EXITS-2 SKUS IN 1

These units are designed with both red and green LEDs to meet luminance requirements and supplied with both color faceplates. To toggle between colors simply move the jumper inside the fixture and snap on the correct color faceplate.



Color Selector Jumper

Color Face Plates

# COLUMBIA LIGHTING

is a recognized leader in providing quality and innovation at value. Columbia Lighting manufactures an array of commercial and industrial luminaires, leading the industry with exceptional efficacy, optical performance and quality.

## INDOOR TABLE OF CONTENTS

CCL..... 13	CWP..... 20	VAPORTITES
CFP..... 14	CRW..... 21	PRODUCT SELECTION GUIDE..... 30
CBT..... 15	CUC..... 21	CHB..... 32
PANELS & TROFFERS	WRAPS	LINEAR HIGH BAY
PRODUCT SELECTION GUIDE..... 16	PRODUCT SELECTION GUIDE..... 22	PRODUCT SELECTION GUIDE..... 33
CTK..... 18	CSL..... 24	CRN..... 34
RETROFIT	STRIPS	ROUND HIGH BAY
PRODUCT SELECTION GUIDE..... 19	PRODUCT SELECTION GUIDE..... 26	PRODUCT SELECTION GUIDE..... 35
CNW..... 20	CVT..... 28	



# CCL

## CENTER-LENS TROFFER

The CCL is an efficient LED troffer with architectural style and appearance.

- Frosted acrylic lens
- Fully assembled for quick installation
- Universal voltage, 120-277V
- 0-10V Dimming
- Up to 118 lumens per watt
- IC rated

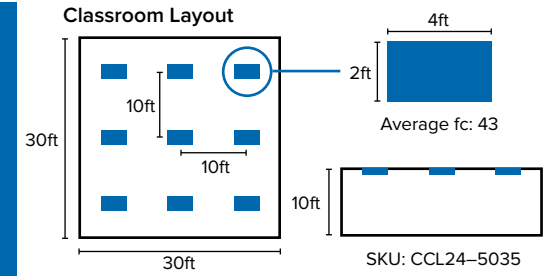
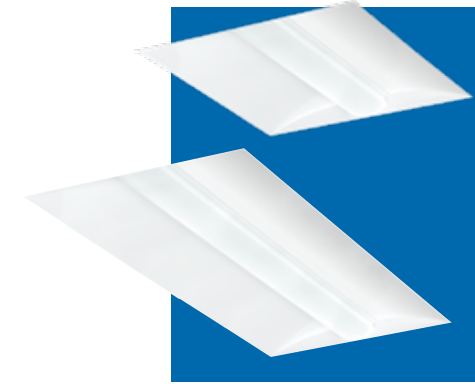

Fixture	Length	Width	Height	Weight
2'x2'	23.8in.	23.8in.	4.0in.	15lbs.
2'x4'	47.8in.	23.8in.	4.0in.	20lbs.



Part #	Catalog #	UPC	Lumens	CCT	LPW	Watts	Stock Locations				Pallet Qty	Equivalency	DLC Listing
							CA	GA	IL	NJ			
<b>2'x2'</b>													
93077477	CCL22-3335	78531127503	3223	3500K	112	29	.	.	.	.	40	2 Lamp T8	PKA8TBHS
93077478	CCL22-3340	78531127510	3345	4000K	116	29	.	.	.	.	40	2 Lamp T8	PBRBS4UZ
<b>2'x4'</b>													
93077479	CCL24-5035	78531127527	5001	3500K	114	44	.	.	.	.	20	3 Lamp T8	PMRJBMVH
93077480	CCL24-5040	78531127534	5191	4000K	118	44	.	.	.	.	20	3 Lamp T8	PQVJUNK8
<b>Accessories</b>													
FK22	FK22	78531000752	-	-			.	.	.	.	-	-	-
FK24	FK24	78531038991	-	-			.	.	.	.	-	-	-

# CFP

## EDGE-LIT FLAT PANEL

The CFP offers Edge-Lit LED technology in a sleek flat panel design.

- Switchable Lumen technology
- Recessed or surface mount
- Universal voltage, 120–277V
- Flex and battery back up available in 5–10 day Quick–Ship program
- 0–10V
- IC rated

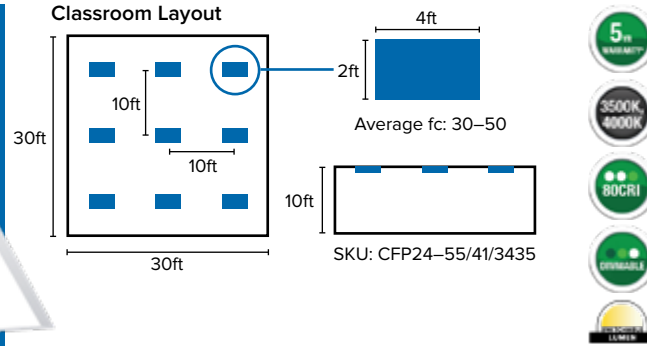

- 5 yr WARRANTY
- 3500K, 4000K
- 80CRI
- DRINKABLE
- LED LUMENS

Fixture	Length	Width	Height	Weight
1'x4' Recessed	47.7in.	11.8in.	1.6in.	7.7lbs.
2'x2' Recessed	23.7in.	23.7in.	1.6in.	8.2lbs.
2'x4' Recessed	47.7in.	23.7in.	1.6in.	15.1lbs.

\* Weights will differ for HE SKU luminaires,

Part #	Catalog #	UPC	Lumens	CCT	LPW	Watts	Stock Locations				Pallet Qty	Equivalency	DLC Listing
							CA	GA	IL	NJ			
<b>1'x4'</b>													
93114030	CFP14-55/41/3435	78531140953	5500, 4100, 3400	3500K	117, 121, 125	50, 40, 31	.	.	.	.	28	2 Lamp T5 or T8	PLGW6YKU
93114031	CFP14-55/41/3440	78531140960	5500, 4100, 3400	4000K	122, 126, 130	50, 40, 31	.	.	.	.	28	2 Lamp T5 or T8	P7HF8LTI
<b>2'x2'</b>													
93114403	CFP22-3335-HE	78531140571	3300	3500K	114	44	.	.	.	.	56	2 Lamp T8	PNTBAJF4
93114405	CFP22-3340-HE	78531140595	3300	4000K	118	44	.	.	.	.	56	2 or 3 Lamp T8	PBJO7QT4
93114032	CFP22-40/33/2835	78531140977	4000, 3300, 2800	3500K	108, 113, 115	40, 30, 25	.	.	.	.	56	2 Lamp T8	PKQBM9G7
93114033	CFP22-40/33/2840	78531140984	4000, 3300, 2800	4000K	125, 131, 133	40, 30, 26	.	.	.	.	56	2 or 3 Lamp T8	PSB40AA2
<b>2'x4'</b>													
93114409	CFP24-4135-HE	78531140632	4100	3500K	114	44	.	.	.	.	28	2 Lamp T8	POFQBK4I
93114411	CFP24-4140-HE	78531140656	4100	4000K	118	44	.	.	.	.	28	2 Lamp T8	PS2Q2171
93114034	CFP24-55/41/3435	78531140991	5500, 4100, 3400	3500K	122, 125, 128	50, 40, 31	.	.	.	.	28	2 or 3 Lamp T8	PXE068MB
93114035	CFP24-55/41/3440	78531141004	5500, 4100, 3400	4000K	102, 104, 107	49, 39, 30	.	.	.	.	28	2 or 3 Lamp T8	P2FVDW6D
93114414	CFP24-7535	78531140687	7364	3500K	132	56	.	.	.	.	28	3 Lamp T8	PPBJZ6U8
93114415	CFP24-7540	78531140694	7534	4000K	133	56	.	.	.	.	28	3 Lamp T8	P4D29LN4

**10-Day Quick-Ship options:**  
 Add **ELL14** (Emergency Battery Pack Installed, 1400 Lumens) or **C588** (5-wire Flex) to any stocked option.  
 Examples: **CFP14-55/41/3435-ELL14**; **CFP14-55/41/3435-C588**

Accessories													
93078803	PLD10M	782520869335	-	-	-	-	.	.	.	.	-	-	-
93080406	PLRTS	782520869410	-	-	-	-	.	.	.	.	-	-	-
FK14	FK14	78531000745	-	-	-	-	.	.	.	.	-	-	-
FK22	FK22	78531000752	-	-	-	-	.	.	.	.	-	-	-
FK24	FK24	78531038991	-	-	-	-	.	.	.	.	-	-	-
93094847	CFPSMK-14	78531133283	-	-	-	-	.	.	.	.	-	-	-
93094848	CFPSMK-22	78531133290	-	-	-	-	.	.	.	.	-	-	-
93094849	CFPSMK-24	78531133306	-	-	-	-	.	.	.	.	-	-	-
93093113	CFPCM36Y SC5F-KIT	78531133023	-	-	-	-	.	.	.	.	-	-	-

# CBT

## BACK-LIT TROFFER

Affordable LED lensed troffer with smooth even illumination. Shallow height is ideal for tight plenum applications.

- Switchable Lumen technology
- Recessed or surface mount
- Smooth even illumination
- Universal Voltage, 120-277V
- 0-10 Dimming up to 10%
- IC rated

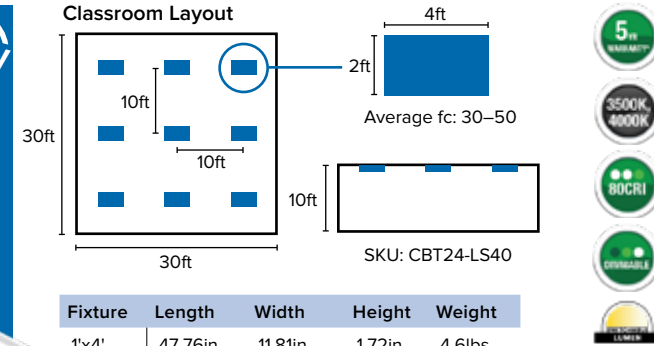

- 5 yr WARRANTY
- 3500K, 4000K
- 80CRI
- DRINKABLE
- LED LUMENS



Fixture	Length	Width	Height	Weight
1'x4'	47.76in.	11.81in.	1.72in.	4.6lbs.
2'x2'	23.74in.	23.74in.	1.71in.	4.4lbs.
2'x4'	47.76in.	23.74in.	1.72in.	8.8lbs.

Part #	Catalog #	UPC	Lumens	CCT	LPW	Watts	Stock Locations				Pallet Qty	Equivalency	DLC Listing
							CA	GA	IL	NJ			
<b>1'x4'</b>													
93123033	CBT14-LS35	840141400013	4400, 3300, 2750	3500K	107, 114, 120	42, 31, 25	.	.	.	.	28	1 or 2 Lamp T8	PLSHP7YN9BKK
93123034	CBT14-LS40	840141400020	4400, 3300, 2750	4000K	108, 117, 122	41, 30, 24	.	.	.	.	28	1 or 2 Lamp T8	PLKLSJTBZRZ9
<b>2'x2'</b>													
93123035	CBT22-LS35	840141400037	4400, 3300, 2750	3500K	111, 119, 122	40, 30, 24	.	.	.	.	56	2 U-Lamp or 3 Lamp T8	PLQPR9EXDJEK
93123036	CBT22-LS40	840141400044	4400, 3300, 2750	4000K	113, 121, 126	40, 30, 24	.	.	.	.	56	2 U-Lamp or 3 Lamp T8	PLOQK9FLMTCC
<b>2'x4'</b>													
93123037	CBT24-LS35	840141400051	5500, 4400, 3300	3500K	118, 125, 132	50, 39, 29	.	.	.	.	28	2 or 3 Lamp T8	PLM7Q6N7JKOQ
93123038	CBT24-LS40	840141400068	5500, 4400, 3300	4000K	120, 127, 133	50, 39, 29	.	.	.	.	28	2 or 3 Lamp T8	PLNU3PORHDW3
<b>Accessories</b>													
FK14	FK14	78531000745	-	-	-	-	.	.	.	.	-	-	-
FK22	FK22	78531000752	-	-	-	-	.	.	.	.	-	-	-
FK24	FK24	78531038991	-	-	-	-	.	.	.	.	-	-	-
93123039	CBTSMK14	840141400075	-	-	-	-	.	.	.	.	-	-	-
93123040	CBTSMK22	840141400082	-	-	-	-	.	.	.	.	-	-	-
93123041	CBTMK24	840141400099	-	-	-	-	.	.	.	.	-	-	-



# PANELS & TROFFERS

## PRODUCT SELECTION GUIDE

		GOOD			BETTER			BEST		
		tradeSELECT  CBT Back-Lit Troffer			tradeSELECT  CFP Edge-Lit Flat Panel			High-Spec Panel  Scaler™ Edge-Lit Flat Panel		
FEATURES	Sizes	1x4	2x2	2x4	1x4	2x2	2x4	1x4	2x2	2x4
		Yes	Yes	Yes	Yes	Yes	Yes	Yes	Yes	Yes
	CRI	80+			80+			80+		
	CCT	3500K, 4000K			3500K, 4000K			3000K, 3500K, 4000K, 5000K		
	SpectraSync™ Color Tuning Technology	-			-			3000-5000K		
	Switchable Technology	Switchable Lumen			Switchable Lumen			-		
	SpectraSAFE™ Integrated Surveillance	-			-			-		
	Lumen Range	2941-5964			2876-7534			1492-8995		
	Mounting	Recessed	Surface	Cable	Recessed	Surface	Cable	Recessed	Surface	Cable
		Yes	Yes	-	Yes	Yes	Yes	Yes	Yes	Yes
	Dimming	0-10V Dimming to 10%			0-10V Dimming to 10%			0-10V Dimming to 1% and Dim to Dark		
	Emergency Battery Pack	-			Yes			Yes		
	DTS (UL924 Bypass)	-			-			Yes		
	Flex	-			Yes			Yes		
Efficacy (maximum LPW)	133			137			145			
DLC® DesignLights Consortium	Standard			Premium			-			
INTEGRATED CONTROLS	Standalone Occupancy & Daylighting	-			-			-		
	NX Standalone Occupancy & Daylighting	-			-			-		
	NX Networked Occupancy & Daylighting	-			-			-		
	PowerHUBB™	-			-			-		
USES	Applications	Education, Healthcare, Office, Retail			Education, Healthcare, Office, Retail, Cleanroom (ISO Class 5-9 Rating)			Education, Healthcare, Office, Retail, Cleanroom (ISO Class 5-9 Rating)		

DLC® (DesignLights Consortium) Qualified. Please refer to the DLC website for specific product qualifications at [www.designlights.org](http://www.designlights.org)



# CTK

## TROFFER RETROFIT KIT

Retrofit for existing prismatic or parabolic troffers with integrated assembly for easy installation.

- High efficiency frosted polycarbonate lens
- Fits most standard housings
- 0-10V Dimming to 10%

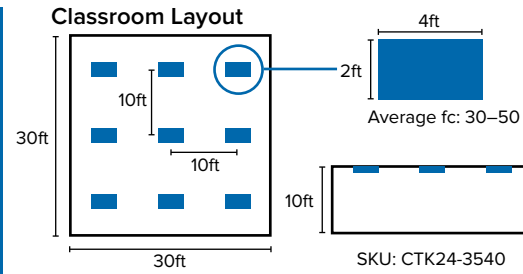

Fixture	Length	Width	Height	Weight
2'x2'	22.5 in.	22.5 in.	3.07 in.	3.9 lbs.
2'x4'	48 in.	22.5 in.	3.07 in.	6.4 lbs.

Part #	Catalog #	UPC	Lumens	CCT	LPW	Watts	Stock Locations				Pallet Qty	Equivalency	DLC Listing
							CA	GA	IL	NJ			
<b>2'x2'</b>													
93123046	CTK22-2835	840141400143	2800	3500K	127	21	•	•		40	2 Lamp T8	PLC8I187J2HW	
93123047	CTK22-2840	840141400150	2800	4000K	127	21	•	•		40	2 Lamp T8	PLO29ODI5ZJ9	
93123044	CTK22-3335	840141400129	3300	3500K	124	25	•	•		40	2 Lamp T8	PLHJ5XR0LHI2	
93123045	CTK22-3340	840141400136	3300	4000K	124	25	•	•		40	2 Lamp T8	PLEQAMLGWAWC	
93123042	CTK22-4035	840141400105	4000	3500K	125	32	•	•		40	3 Lamp T8	PLABNOJ7ZJCN	
93123043	CTK22-4040	840141400112	4000	4000K	125	32	•	•		40	3 Lamp T8	PLY2YEJR6U3S	
<b>2'x4'</b>													
93123052	CTK24-2535	840141400204	2500	3500K	128	20	•	•		20	1 Lamp T8	–	
93123053	CTK24-2540	840141400211	2500	4000K	130	20	•	•		20	1 Lamp T8	–	
93123050	CTK24-3535	840141400181	3500	3500K	125	28	•	•		20	1 Lamp T8	PLCV00ZH9RX8	
93123051	CTK24-3540	840141400198	3500	4000K	125	28	•	•		20	1 Lamp T8	PL2HPYGGH4DE	
93123048	CTK24-4435	840141400167	4400	3500K	126	35	•	•		20	2 Lamp T8	PLTDFS3BF59U	
93123049	CTK24-4440	840141400174	4400	4000K	126	35	•	•		20	2 Lamp T8	PLV8R4XKDFMK	

# RETROFIT

## PRODUCT SELECTION GUIDE

		GOOD		BETTER		
		tradeSELECT™		Mid-Spec Retrofit Kit		
		CTK		SLK		
FEATURES	<b>Sizes</b>	2x2	2x4	2x2	2x4	
		Yes	Yes	Yes	Yes	
	<b>CRI</b>	80+		80+		
	<b>CCT</b>	3500K, 4000K		3000K, 3500K, 4000K, 5000K		
	<b>SpectraSync™ Color Tuning Technology</b>	–		2700K–5000K, 2700K–6500K		
	<b>Lumen Range</b>	2551–4536		1545–6200		
	<b>Dimming</b>	0–10V Dimming to 10%		0–10V plus others		
	<b>Emergency</b>	Field Install		Yes		
	<b>DTS (UL924 Bypass)</b>	–		Yes		
	<b>Efficacy (maximum LPW)</b>	130		141		
INTEGRATED CONTROLS	<b>DLC® DesignLights Consortium</b>	Premium		Premium		
	<b>Buy America(n) Solutions</b>	–		TAA FAR §52.225-11		
	<b>Standalone Occupancy &amp; Daylighting</b>	–		Yes		
	<b>NX Standalone Occupancy &amp; Daylighting</b>	–		Yes		
	<b>NX Networked Occupancy &amp; Daylighting</b>	–		–		
	<b>PowerHUBB™</b>	–		–		
	USES	<b>Applications</b>	Education, Healthcare, Office, Retail		Education, Healthcare, Office, Retail	

DLC® (DesignLights Consortium) Qualified. Please refer to the DLC website for specific product qualifications at [www.designlights.org](http://www.designlights.org)

# CNW

## NARROW WRAP

An attractive narrow wrap with decorative end caps and a polished look, suitable for many applications.

- Frosted acrylic lens
- Fully assembled for quick installation
- Efficient 4' LED narrow utility wrap
- 116 lumens per watt



NEW

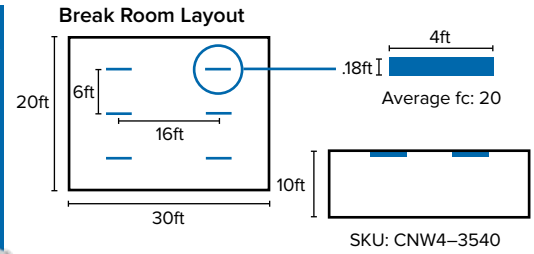

Length	Width	Height	Weight
47.6in.	5.3in.	2.1in.	4.08lbs.

- 5 yr WARRANTY
- 4000K
- 80CRI
- RECYCLABLE

Part #	Catalog #	UPC	Lumens	CCT	LPW	Watts	Stock Locations				Pallet Qty	Equivalency	DLC Listing
							CA	GA	IL	NJ			
93123055	CNW4-3540	840141400235	3501	4000K	116	30	.	.	.	.	64	1 Lamp T8	-*

\* Consult Factory

# CWP

## WRAP LUMINAIRE

Efficient general lighting solution with wide housing ideal for retrofit applications.

- Sturdy frosted acrylic lens
- Universal voltage, 120-277V
- 0-10V Dimming

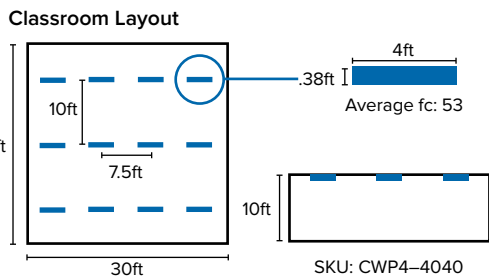

Length	Width	Height	Weight
48.0 in.	9.0 in.	4.5 in.	10.8 lbs.

- 5 yr WARRANTY
- 3500K, 4000K
- 80CRI
- RECYCLABLE

Part #	Catalog #	UPC	Lumens	CCT	LPW	Watts	Stock Locations				Pallet Qty	Equivalency	DLC Listing
							CA	GA	IL	NJ			
93075545	CWP4-4035	78531127480	4584	3500K	124	37	.	.	.	.	33	2 Lamp T8	PK3QCUC2
93075546	CWP4-4040	78531127497	4584	4000K	124	37	.	.	.	.	33	2 Lamp T8	PBX1ZHW2

# CRW

## ROUND WRAP

The CRW is a versatile round wrap with decorative end caps.

- Switchable Lumen and CCT technology
- Frosted acrylic lens
- Up to 153 lumens per watt
- 0-10V Dimming



NEW

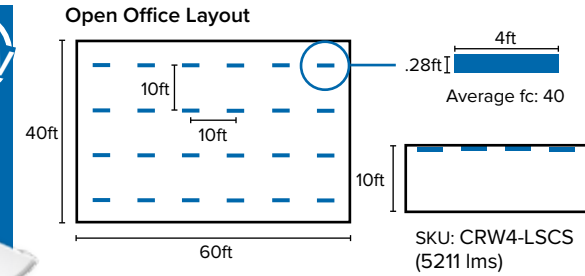

Length	Width	Height	Weight
46.0in.	9.7in.	3.4in.	6.83lbs.

- 5 yr WARRANTY
- RECYCLABLE
- 80CRI
- RECYCLABLE
- LUMENS & CCT

Part #	Catalog #	UPC	Lumens	CCT	LPW	Watts	Stock Locations				Pallet Qty	Equivalency	DLC Listing
							CA	GA	IL	NJ			
93123054	CRW4-LSCS	840141400228	5200, 4556, 3864	3500K	133, 136, 149	40	.	.	.	.	30	1 or 2 Lamp T8 or 1 Lamp T5HO	-*
			5240, 4590, 3892	4000K	141, 149, 160	27							
			5280, 4624, 3920	5000K	137, 145, 156	33							

\* Consult Factory

# CUC

## COMMERCIAL LED UNDERCABINET

Sleek LED undercabinet luminaire with a variety of applications.

- Durable polycarbonate lens
- Triac Dimming
- Direct wire or plug-and-play
- 120V



CUC4-ED120 Mounted at 20" from surface  
Workspace desktop foot candles

Fixture	Length	Width	Fixture	Weight
CUC1	11.5in.	3.33in.	1.0in.	1.0lbs.
CUC2	23.5in.	3.33in.	1.0in.	1.9lbs.
CUC3	35.5in.	3.33in.	1.0in.	2.9lbs.
CUC4	47.5in.	3.33in.	1.0in.	3.5lbs.

- 5 yr WARRANTY
- 3500K, 4000K
- 90 CRI
- RECYCLABLE
- ENERGY STAR

Part #	Catalog #	UPC	Lumens	CCT	LPW	Watts	Stock Locations				Carton Qty	
							CA	GA	IL	NJ		
93097056	CUC1-ED120	78531133580	366	3000K	49	8	.	.	.	.	4	
93097057	CUC2-ED120	78531133597	724	3000K	50	15	.	.	.	.	4	
93097058	CUC3-ED120	78531133603	1099	3000K	54	21	.	.	.	.	4	
93097059	CUC4-ED120	78531133610	1248	3000K	50	25	.	.	.	.	4	
Accessories												
93097061	CUC-13CC	078531133634	-	-			.	.	.	.	10	
93097062	CUC-24CC	078531133641	-	-			.	.	.	.	10	
93097060	CUC-5F-120-CP	078531133627	-	-			.	.	.	.	10	

# WRAPS

## PRODUCT SELECTION GUIDE

		GOOD								
		tradeSELECT <sup>™</sup> CNW			tradeSELECT <sup>™</sup> CWP			tradeSELECT <sup>™</sup> CRW		
		2'	4'	8'	2'	4'	8'	2'	4'	8'
FEATURES	Length	-	Yes	-	-	Yes	-	-	Yes	-
	Width	5.3"			9"			9.7"		
	Continuous Row	-			-			-		
	Lumens (maximum)	3507			4584			5880		
	Efficacy (maximum LPW)	116			124			153		
	Life Rating	54,000 hours @ L70			54,000 hours @ L70			54,000 hours @ L70		
	CRI	80+			80+			80+		
	CCT	4000K			4000K			3500K, 4000K, 5000K		
	SpectraSync <sup>™</sup> Color Tuning Technology	-			-			-		
	SpectraSAFE <sup>™</sup> Integrated Surveillance	-			-			-		
	Switchable Technology	-			-			Lumen & CCT		
	Lens	Frosted Acrylic			Frosted Acrylic			Frosted Acrylic		
	Dimming	0-10V Dimming to 10%			0-10V Dimming to 10%			0-10V Dimming to 10%		
	Emergency Battery Pack	-			-			-		
	DLC <sup>®</sup> DesignLights Consortium	Standard			Standard			Premium		
Buy America(n) Solutions	-			-			-			
INTEGRATED CONTROLS	Standalone Occupancy & Daylighting	-			-			-		
	NX Standalone Occupancy & Daylighting	-			-			-		
	NX Networked Occupancy & Daylighting	-			-			-		
	PowerHUBB <sup>™</sup>	-			-			-		
USES	Applications	Education, Office, Retail, Warehouse			Education, Healthcare, Office, Warehouse			Education, Healthcare, Office, Retail, Warehouse		

DLC<sup>®</sup> (DesignLights Consortium) Qualified. Please refer to the DLC website for specific product qualifications at [www.designlights.org](http://www.designlights.org)

		BETTER			BEST		
		Mid-Spec Wrap LAW			High-Spec Wrap RLW		
		2'	4'	8'	2'	4'	8'
	Length	Yes	Yes	-	Yes	Yes	Yes
	Width	8.31"			8.5"		
	Continuous Row	-			Yes		
	Lumens (maximum)	7263			14,711		
	Efficacy (maximum LPW)	125			144		
	Life Rating	60,000 hours @ L80			60,000 hours @ L80		
	CRI	80+			80+, 90		
	CCT	3000K, 3500K, 4000K, 5000K			3000K, 3500K, 4000K, 5000K		
	SpectraSync <sup>™</sup> Color Tuning Technology	-			Yes		
	SpectraSAFE <sup>™</sup> Integrated Surveillance	-			Yes		
	Switchable Technology	-			-		
	Lens	Acrylic, Frosted Overlay			Frosted Acrylic		
	Dimming	0-10V Dimming to 1% and Dim to Dark			0-10V Dimming to 1% and Dim to Dark		
	Emergency Battery Pack	Yes			Yes		
	DLC <sup>®</sup> DesignLights Consortium	Standard			Standard		
Buy America(n) Solutions	-			TAA FAR §52.225-11			
	Standalone Occupancy & Daylighting	-			Yes		
	NX Standalone Occupancy & Daylighting	-			Yes		
	NX Networked Occupancy & Daylighting	-			-		
	PowerHUBB <sup>™</sup>	-			Yes		
	Applications	Education, Healthcare, Office, Warehouse			Education, Healthcare, Office, Retail, Warehouse		



# CSL

## LENSED STRIPLIGHT

The CSL is an attractive narrow striplight with LED technology and a wide range of applications.

- Frosted acrylic lens
- Surface or suspended mount
- Fully assembled for quick installation
- Universal voltage, 120-277V
- 0-10V Dimming

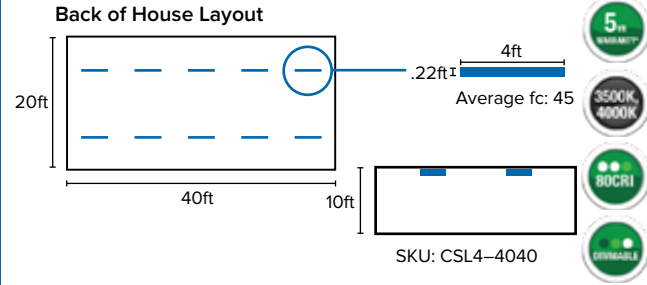
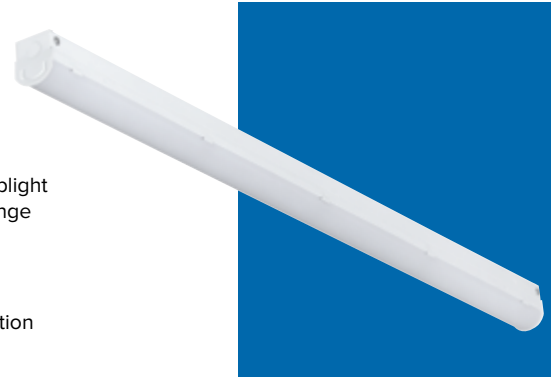

Fixture	Length	Width	Height	Weight
4'	48.0in.	2.25in.	2.69in.	4.9lbs.
8'	95.9in.	2.25in.	2.69in.	10.8lbs.

Part #	Catalog #	UPC	Lumens	CCT	LPW	Watts	Stock Locations				Pallet Qty	Equivalency	DLC Listing
							CA	GA	IL	NJ			
<b>4'</b>													
93075541	CSL4-4035	78531127442	4231	3500K	105	40	•	•	•	•	120	2 Lamp T8	PTH54URX
93075542	CSL4-4040	78531127459	4517	4000K	112	40	•	•	•	•	120	2 Lamp T8	PFA16VH6
<b>8'</b>													
93075543	CSL8-8035	78531127466	8460	3500K	105	80	•	•	•	•	120	4 Lamp T8	P67H7F6G
93075544	CSL8-8040	78531127473	9036	4000K	112	80	•	•	•	•	120	4 Lamp T8	PGUEY5Z6



# STRIPS

## PRODUCT SELECTION GUIDE

	GOOD			BETTER					
	tradeSELECT <sup>®</sup>			Mid-Spec Strip			Mid-Spec Strip		
	CSL			LCS			LCL		
	2'	4'	8'	2'	4'	8'	2'	4'	8'
<b>Length</b>	–	Yes	Yes	Yes	Yes	Yes	Yes	Yes	Yes
<b>Continuous Row</b>	–			–			–		
<b>Lumens (maximum)</b>	4584			23,274			21,354		
<b>Efficacy (maximum LPW)</b>	124			153			144		
<b>Lens</b>	Frosted Acrylic			None			Frosted Acrylic		
<b>Emergency Battery Pack</b>	–			Yes			Yes		
<b>CRI</b>	80+			80+			80+		
<b>SpectraSAFE™</b>	–			–			–		
<b>SpectraSync™ Color Tuning Technology</b>	–			–			–		
<b>DLC® DesignLights Consortium</b>	Standard			Premium			Premium		
<b>Buy America(n) Solutions</b>	–			–			TAA FAR §52.225-11		
<b>Standalone Occupancy &amp; Daylighting</b>	–			–			–		
<b>NX Standalone Occupancy &amp; Daylighting</b>	–			–			–		
<b>NX Networked Occupancy &amp; Daylighting</b>	–			–			–		
<b>PowerHUBB™</b>	–			–			–		
<b>Applications</b>	Education, Healthcare, Office, Retail, Industrial			Education, Healthcare, Office, Retail, Industrial Yes			Education, Healthcare, Office, Retail, Industrial		

DLC® (DesignLights Consortium) Qualified. Please refer to the DLC website for specific product qualifications at [www.designlights.org](http://www.designlights.org)

BEST			
High-Spec Strip			
MPS			
2'	4'	8'	
Yes	Yes	Yes	
Yes			
17,490			
148			
None, Frosted Acrylic, Polycarbonate			
Yes			
80+/90			
Yes			
Yes			
Premium			
TAA FAR §52.225-11			
Yes			
Yes			
Yes			
Yes			
Education, Healthcare, Office, Retail, Industrial			



MPS

# CVT VAPORTITE

A narrow body linear vaportite that offers Switchable Lumen outputs and multiple mounting options for easy installation in both retrofits and new construction.

- IP65/66 rated
- Up to 161 lumens per watt
- -40°C to 40°C
- Switchable Lumen technology
- Universal voltage, 120-277V
- 0-10V Dimming to 10%



Cold Storage Layout

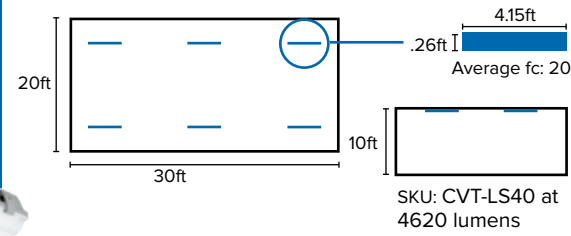

SKU: CVT-LS40 at 4620 lumens





Length	Width	Height	Weight
49.8in.	3.4in.	3.4in.	4.4lbs.

Part #	Catalog #	UPC	Lumens	CCT	LPW	Watts	Stock Locations				Pallet Qty	Equivalency	DLC Listing
							CA	GA	IL	NJ			
93123404	CVT4-LS40	840141400242	7000, 5800, 4500	4000K	155, 158, 160	48, 38, 29	•	•			24	3, 2, 2 T8 Lamp	PZF65FVJ
93123405	CVT4-LS50	840141400259	7000, 5800, 4500	5000K	152, 154, 158	48, 38, 29	•	•			24	3, 2, 2 T8 Lamp	POZKQ7HN





# VAPORTITE

## PRODUCT SELECTION GUIDE

		GOOD			BETTER					
		tradeSELECT <sup>®</sup>			Mid-Spec Vaportite			Mid-Spec Vaportite		
										
		CVT			LXEN			LXEM		
		2'	4'	8'	2'	4'	8'	2'	4'	8'
FEATURES	Length	-	Yes	-	-	Yes	Yes	Yes	Yes	Yes
	Certifications	IP65, IP66, Wet Location			IP65, IP66, IP67, Wet Location, UL Sanitation			IP65, IP66, IP67, Wet Location, UL Sanitation, IK10 with polycarbonate lens		
	Lumens Range (Switchable)	4620-7460			2000-4300			2145-22,473		
	Efficacy (maximum LPW)	29-48			111-116			96-143		
	Mounting Height	8'-12'			8'-10'			8'-20'		
	Lens	Ribbed Frosted Polycarbonate			Ribbed Frosted Acrylic			Ribbed Frosted Acrylic, Ribbed Clear Acrylic, Deep Frosted Acrylic, Deep Clear Acrylic, Ribbed Frosted Polycarbonate, Ribbed Clear Polycarbonate		
	Dimming	Yes			Yes			Yes		
	Emergency	-			-			Yes		
	CRI	80+			80+			80+		
	CCT	4000K, 5000K			3000K, 3500K, 4000K, 5000K			3000K, 3500K, 4000K, 5000K		
	Temperature Range	-40°C to 40°C			-20°C to 50°C			-20°C to 50°C		
	Switchable Technology	Switchable Lumen			-			-		
	Buy America(n) Solutions	-			TAA FAR §52.225-11			TAA FAR §52.225-11		
	DLC <sup>®</sup> DesignLights Consortium	Premium			Standard			Premium		
USES	Applications	Education, Healthcare, Industrial, Cold Storage, Food Processing, Parking Garage			Education, Healthcare, Industrial, Cold Storage, Food Processing, Parking Garage			Education, Healthcare, Industrial, Cold Storage, Food Processing, Parking Garage		

DLC<sup>®</sup> (DesignLights Consortium) Qualified. Please refer to the DLC website for specific product qualifications at [www.designlights.org](http://www.designlights.org)

		BETTER					
		Mid-Spec Vaportite			Mid-Spec Vaportite		
							
		LXEW			LXEP		
		2'	4'	8'	2'	4'	8'
	Length	-	Yes	-	Yes	Yes	Yes
	Certifications	IP65/67/66, Wet Location, UL Sanitation			IP65/67/66, Wet Location, UL Sanitation		
	Lumens Range	11,079-38,228			2960-19,700		
	Efficacy (maximum LPW)	105-137			88-116		
	Mounting Height	20'-40'			8'-10'		
	Lens	Frosted Impact Resistance Acrylic, Clear Impact Resistance Acrylic, Clear UV Stabilized Polycarbonate			Deep Frosted Acrylic, Deep Clear Acrylic		
	Dimming	Yes			Yes		
	Emergency	Yes			Yes		
	CRI	80+			80+		
	CCT	3000K, 3500K, 4000K, 5000K			3000K, 3500K, 4000K, 5000K		
	Temperature Range	-20°C to 50°C			-20°C to 50°C		
	Switchable Technology	-			-		
	Buy America(n) Solutions	TAA FAR §52.225-11			-		
	DLC <sup>®</sup> DesignLights Consortium	Premium			Standard		
	USES	Education, Healthcare, Industrial, Cold Storage, Food Processing, Parking Garage			Parking Garage		

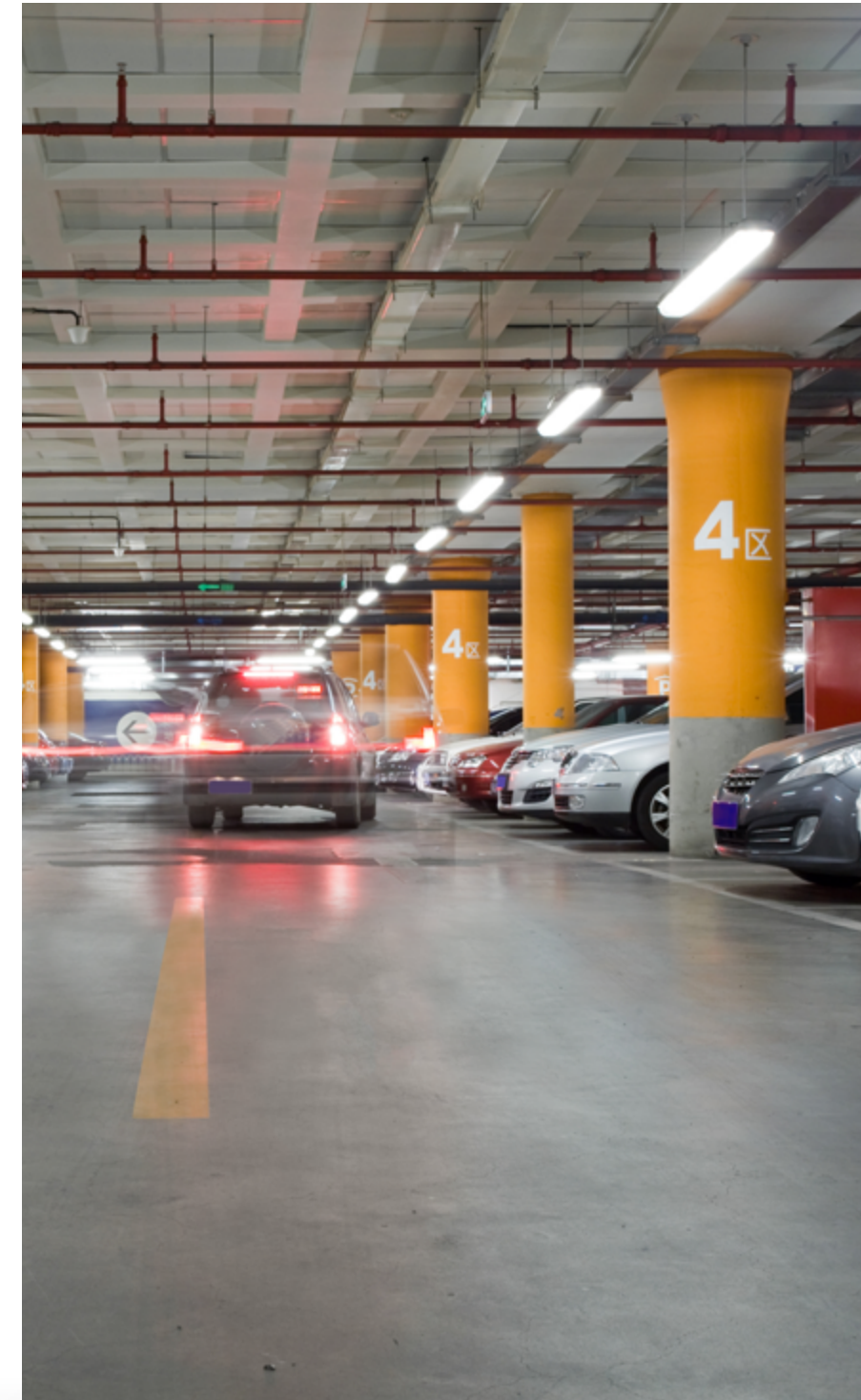



# CHB

## LINEAR HIGH BAY

The CHB is an efficient linear high bay suitable for a variety of areas including warehouses, gyms and mezzanines.

- V-hook and chain hanger provided standard
- Frosted acrylic lens
- 6kV surge protection
- Up to 131 lumens per watt
- -20°C to 50°C
- 0–10V Dimming to 10%
- Universal voltage, 120-277V

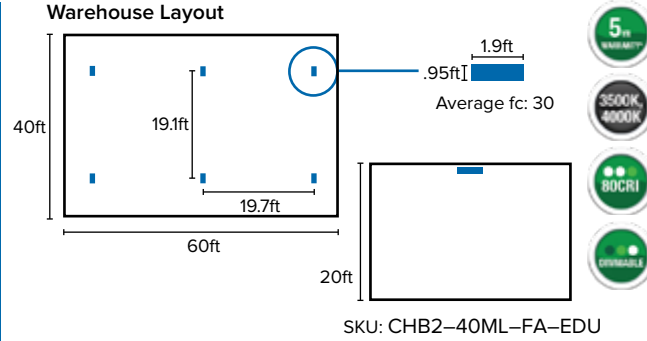

Fixture	Length	Width	Height	Weight
LX	23.81in.	12.57in.	3.75in.	10.6lbs.
ML, MH	23.81in.	12.57in.	3.75in.	10.6lbs.
MV	23.81in.	17.84in.	4.0in.	13.4lbs.

Part #	Catalog #	UPC	Lumens	CCT	LPW	Watts	Stock Locations				Pallet Qty	Equivalency	DLC Listing
							CA	GA	IL	NJ			
93095151	CHB2-40LX-FA-EDU	78531133351	11,380	4000K	131	88	•	•	•	•	44	4 Lamp T8	PLNG9QMYBWQW
93095153	CHB2-40ML-FA-EDU	78531133375	17,013	4000K	131	133	•	•	•	•	44	6 Lamp T8	PLJ55Y3IVWNK
93095155	CHB2-40MH-FA-EDU	78531133399	22,038	4000K	131	173	•	•	•	•	44	6 Lamp T8	PLXV35JDF4YZ
93095157	CHB2-40MV-FA-EDU	78531133412	27,343	4000K	131	213	•	•	•	•	22	6 Lamp T5HO	PLXFF0EZYEFH
93095152	CHB2-50LX-FA-EDU	78531133368	2199	5000K	133	88	•	•	•	•	44	2 Lamp T5HO	PLLWTK5AP8W9
93095154	CHB2-50ML-FA-EDU	78531133382	11,483	5000K	133	132	•	•	•	•	44	4 Lamp T5HO	PLNQ4RNMF3LM
93095156	CHB2-50MH-FA-EDU	78531133405	17,105	5000K	132	173	•	•	•	•	44	6 Lamp T8	PLMTJUNPCHQF
93095158	CHB2-50MV-FA-EDU	78531133429	27,522	5000K	133	213	•	•	•	•	22	6 Lamp T5HO	PL0LNBUV1QUL

# LINEAR HIGH BAY

## PRODUCT SELECTION GUIDE

		GOOD		BEST	
		tradeSELECT <sup>®</sup>		High-Spec Linear High Bay	
		CHB		PEL	
		2'	4'	2'	4'
FEATURES	Length	Yes	–	Yes	Yes
	Mounting Height	Up to 40'		Up to 60'	
	Lumens (maximum)	11,000–27,000		8000–60,000	
	Efficacy (maximum LPW)	120–131		146–177	
	CRI	80+		80+	
	CCT	4000K, 5000K		3000K, 3500K, 4000K, 5000K	
	Wattage	87–213W		50–410W	
	Voltage	120–277V, 347V, 480V		120–277V, 347V, 480V	
	Distribution	Lambertian		Narrow, Wide, Lambertian	
	Lens	Acrylic		No Lens, Acrylic, Polycarbonate	
	Uplight	–		Yes	
	Temperature Range	-20°C to 50°C		-40°C to 65°C	
	Dimming	0–10V Dimming to 10%		0–10V Dimming to 5%	
	Ratings	Damp Location		Damp Location	
	Emergency Battery Pack	10W		10W, 20W	
Equivalency	175W to 750W HID & 2-lamp, T5HO–6-lamp T5HO		100W to 1000W HID & 4-lamp T8, 8-lamp T5HO		
DLC <sup>®</sup> DesignLights Consortium	Premium		Yes		
Buy America(n) Solutions	–		TAA FAR §52.225-11		
INTEGRATED CONTROLS	Standalone Occupancy & Daylighting	Yes		Yes	
	NX Standalone Occupancy & Daylighting	–		Yes	
	NX Networked Occupancy & Daylighting	–		Yes	
USES	PowerHUBB <sup>™</sup>	–		–	
	Applications	Industrial, Gymnasium, Warehouse, Big Box Retail		Industrial, Gymnasium, Warehouse, Big Box Retail	

DLC<sup>®</sup> (DesignLights Consortium) Qualified. Please refer to the DLC website for specific product qualifications at [www.designlights.org](http://www.designlights.org)

# CRN

## WET LOCATION HIGH BAY

An efficient wet location high bay offers lumen packages from 14,000 to 34,000 for proper illumination on a variety of high bay applications.

- Available with standard clear glass lens or frosted polycarbonate lens
- Clear acrylic, spun aluminum and diffuse acrylic reflector options
- Up to 146 lumens per watt
- Wet location and IP66 rated
- Supplied with 6' power cord
- Universal voltage, 120-277V

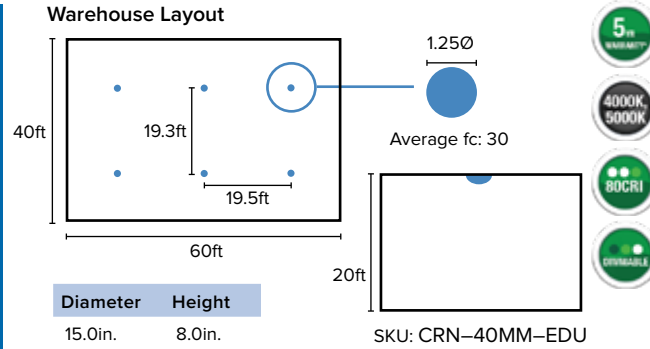

Part #	Catalog #	UPC	Lumens	CCT	LPW	Watts	Weight	Stock Locations				Pallet Qty	Equivalency	DLC Listing
								CA	GA	IL	NJ			
93097494	CRN-40LX-EDU	785988042913	14,426	4000K	144	100	38.7lbs.	•	•	•	•	20	250W	PLDAAFST4R4H
93097495	CRN-40MM-EDU	785988042920	21,678	4000K	144	150	39.4lbs.	•	•	•	•	20	400W	PLLS4RNOT6BK
93097496	CRN-40MV-EDU	785988042937	28,618	4000K	142	201	40.3lbs.	•	•	•	•	20	750W	PLL8W5VSIKWM
93097497	CRN-40MX-EDU	785988042944	33,520	4000K	140	239	41.3lbs.	•	•	•	•	20	750W	PLPMIWOLTFQJ
93097599	CRN-50MM-EDU	785988042968	21,981	5000K	146	150	22.8lbs.	•	•	•	•	20	400W	PLB48R2DB808
93097500	CRN-50MV-EDU	785988042975	29,018	5000K	144	201	37.5lbs.	•	•	•	•	20	750W	PLHVVUGEFX6L
93097501	CRN-50MX-EDU	785988042982	33,989	5000K	142	239	41.7lbs.	•	•	•	•	20	750W	PLU2OS2E0AHF
Accessories														
93097503	CRNAL18	785988043002	-	-	-	-	41.7lbs.	•	•	•	•	16	-	-
93097504	CRNWA18	785988043019	-	-	-	-	11.2lbs.	•	•	•	•	28	-	-
93097502	CRNWW18	785988042999	-	-	-	-	1.0lbs.	•	•	•	•	28	-	-

# ROUND HIGH BAY

## PRODUCT SELECTION GUIDE

		GOOD		BETTER	
		tradeSELECT <sup>®</sup>		Mid-Spec Round High Bay	
		CRN		UTB2	
FEATURES	<b>Diameter</b>	14.4"	15.6"	14.4"	15.6"
		Yes	-	-	Yes
	<b>Mounting Height</b>	Up to 40'		Up to 40'	
	<b>Lumens (maximum)</b>	14,000-34,000		12,000-24,000	
	<b>Efficacy (maximum LPW)</b>	126-144		106-162	
	<b>CRI</b>	80+		80+	
	<b>CCT</b>	4000K, 5000K		3000K, 3500K, 4000K, 5000K	
	<b>Wattage</b>	100-238W		84-160W	
	<b>Voltage</b>	120-277V, 347V, 480V		120-277V, 120V, 208V, 240V, 277V, 347V, 480V	
	<b>Distribution</b>	Reflector: Clear Diffuse, Aluminum		Reflector: Clear Acrylic, Translucent White, Suspended Bead, Anodized Aluminum, No Optic	
	<b>Lens</b>	Glass, Frosted Polycarbonate		Lens: Conical Drop Lens Dropped Lens Refractor, Frosted Acrylic Lens, None	
	<b>Uplight</b>	-		-	
	<b>Temperature Range</b>	-20°C to 55°C		-35°C to 65°C	
	<b>Dimming</b>	0-10V Dimming to 10%		0-10V Dimming to 10%	
	<b>Ratings</b>	IP66		Damp Location	
<b>Emergency Battery Pack</b>	-		10W		
<b>Equivalency</b>	250W to 750W HID		175W to 750W HID		
<b>DLC® DesignLights Consortium</b>	Premium		-		
INTEGRATED CONTROLS	<b>Standalone Occupancy &amp; Daylighting</b>	Yes		Yes	
	<b>NX Standalone Occupancy &amp; Daylighting</b>	-		Yes	
	<b>NX Networked Occupancy &amp; Daylighting</b>	-		Yes	
	<b>PowerHUBB™</b>	-		-	
USES	<b>Applications</b>	Industrial, Gymnasium, Warehouse, Big Box Retail, Garden Center		Industrial, Gymnasium, Warehouse, Big Box Retail	

DLC® (DesignLights Consortium) Qualified. Please refer to the DLC website for specific product qualifications at [www.designlights.org](http://www.designlights.org)

# HUBBELL OUTDOOR LIGHTING

combines innovative technology with practical lighting solutions and service oriented performance based on in-depth knowledge of the electrical distributor and contractor markets.

## OUTDOOR TABLE OF CONTENTS

FLOODLIGHT BEAM SPREAD GUIDE..... 37	WALLPACKS MOUNTING HEIGHT GUIDE..... 42	PATROLMAN ..... 48
ALF 6/12..... 38	SLING WALLPACKS..... 43	DUSK-TO-DAWN PRODUCT SELECTION GUIDE..... 49
COLT LBUL..... 38	WGH..... 44	SLING CANOPY..... 50
MINI COLT..... 39	PRS..... 45	CANOPY PRODUCT SELECTION GUIDE..... 51
MARSHAL..... 39	NRG® 300L..... 45	VAPORTITES ..... 52
FLOODLIGHT PRODUCT SELECTION GUIDE..... 40	WALLPACKS PRODUCT SELECTION GUIDE..... 46	VAPORTITES PRODUCT SELECTION GUIDE..... 53
	SLING SGD DUSK-TO-DAWN..... 48	



# FLOODLIGHT

## BEAM SPREAD GUIDE

### AVAILABLE BEAM SPREAD

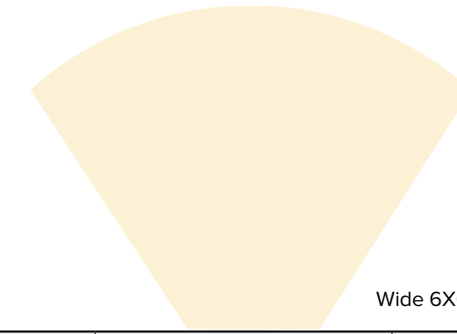

MODEL	Colt Mini MBUL	Marshal	Colt LBUL	ALF6 ALF12	SG1 SG2
EQUIVALENCY	70WHID	2-70W	100W	70W 100W	100W 250W
LUMENS	1100lm	2100lm	2339lm 2468lm	1100lm 2300lm	1500-8000lm
WATTS	13W	26.6W	20W	10W 21W	21-29W 51-80W

Not all configurations and outputs shown, please visit website for the most up-to-date information. Due to our continued efforts to improve our products, product specifications are subject to change without notice.

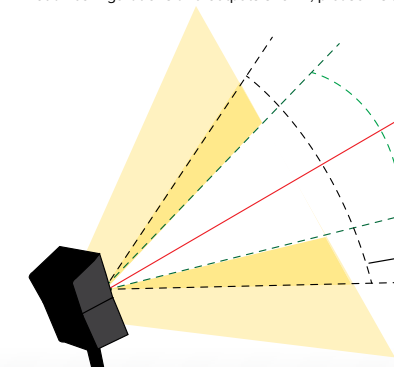

**Center Beam Axis @ 0°**  
(typically max beam intensity measured as Center Beam Candle Power / CBCP)

**Beam Angle**  
(angle within the beam of light equal to 50% of the max beam intensity)

**Field Angle**  
(angle within the beam of light equal to 10% of the max beam intensity)

### NEMA BEAM SPREAD CLASSIFICATION

Beam Spread Degrees (Field Angle)	NEMA Type	Beam Description
10° up to 18°	1	Very Narrow
18°-29°	2	Narrow
29°-46°	3	Medium Narrow
46°-70°	4	Medium
70°-100°	5	Medium Wide
100°-130°	6	Wide
130° and up	7	Very Wide

# ALF 6/12

## ARCHITECTURAL FLOODLIGHT

A versatile LED floodlight perfect for illuminating signs, trees and entrances or small area illumination. It features an adjustable knuckle pivot from 0–75°, wide 6X5 flood distribution and tempered glass lens.

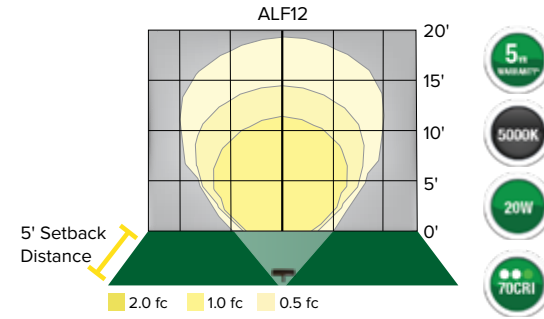

Fixture	Length	Width	Height	Weight
ALF6	12.0in.	1.5in.	7.0in.	4.0lbs.
ALF12	24.0in.	1.5in.	7.0in.	8.0lbs.

Part #	Catalog #	UPC	Lumens	Watts	CCT	Stock Locations				Ctn Qty	Equivalency
						CA	GA	IL	NJ		
ALF 6											
ALF6LU5KBZ	ALF-6LU-5K-BZ	785988019168	1122	20W	5000K	.	.	.	.	2	100W
ALF 12											
ALF12LU5KBZ	ALF-12LU-5K-BZ	785988020713	2303	20W	5000K	.	.	.	.	1	100W

# COLT LBUL

## MINI LED BULLET

Versatile compact LED floodlight perfect for a variety of applications including: landscape, accent, pole/column, facade and small area illumination. Stake or threaded mounting plus adjustable knuckle provides mounting flexibility. Durable die-cast design with corrosion resistant powder coat paint finish for years of maintenance free illumination.

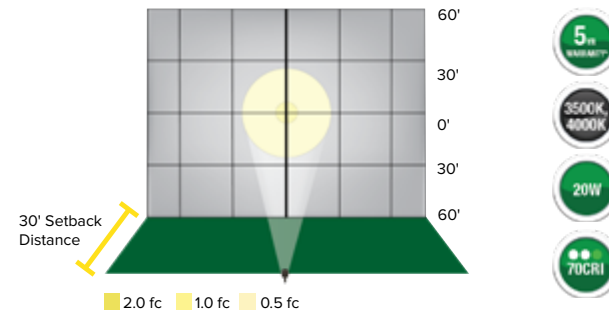

Length	Width	Height	Weight
7.6 in.	4.3 in.	7.3 in.	1.5 lbs.

Part #	Catalog #	UPC	Lumens	Watts	CCT	Stock Location				Pallet Qty	Equivalency	DLC Listing
						CA	GA	IL	NJ			
93116281	LBUL-20-120-3K	840141419886	2339	20W	3000K	.	.	.	.	576	100W	PENXQ5T4
93116282	LBUL-20-120-4K	840141419893	2468	20W	4000K	.	.	.	.	576	100W	PEQBBGRQ

# MINI COLT

## MINI LED BULLET

Versatile compact LED floodlight perfect for a variety of applications including: landscape, accent, pole/column, facade and small area illumination. Stake or threaded mounting and an adjustable knuckle provides mounting flexibility. Durable die-cast design with corrosion resistant powder coat paint finish for years of maintenance free illumination.

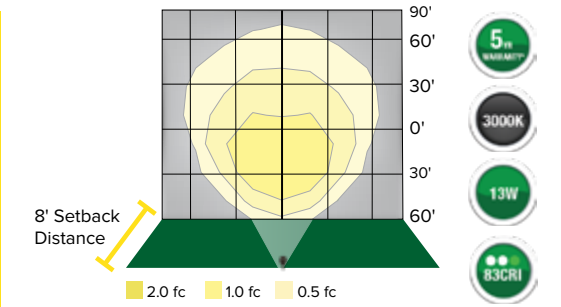

Length	Width	Height	Weight
3.9in.	3.2in.	6.2in.	2.0lbs.

Part #	Catalog #	UPC	Lumens	Watts	CCT	Stock Location				Pallet Qty	Equivalency
						CA	GA	IL	NJ		
MBUL1L3K1	MBUL-1L3K-1	785988031955	1115	13W	3000K	.	.	.	.	12	100W

# MARSHAL

## SECURITY FLOOD

Attractive security floodlight with 180° motion sensor with a coverage area of 72 feet. A powerful LED system saves energy and maintenance. The sensor includes time, sensitivity and distance adjustments.

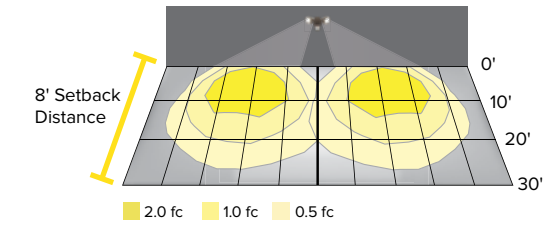





Fixture	Length	Width	Height	Weight
ML	12.75in.	-	5.0 in.	2.2lbs.
MS	6.0in.	0.25in.	0.2in.	0.5lbs.

Part #	Catalog #	UPC	Lumens	Watts	CCT	Stock Location				Pallet Qty	Equivalency
						CA	GA	IL	NJ		
ML2L3K1DB	ML-2L3K-1-DB	785988032723	2104	26W	3000K	.	.	.	.	144	100W
ML2L3K1WH	ML-2L3K-1-WH	785988032730	2104	26W	3000K	.	.	.	.	144	100W
Motion Sensor Only											
MSDB	MS-DB	785988032952	-	-	-	.	.	.	.	-	-
MSWH	MS-WH	785988032969	-	-	-	.	.	.	.	-	-

# FLOODLIGHTS

PRODUCT SELECTION GUIDE

		GOOD			BETTER					
		tradeSELECT®			tradeSELECT®					
										
		Colt Mini			Marshal			Colt LBUL		
FEATURES	Easy to Install	Yes			Yes			Yes		
	Mounting Options	½" 14 NPS			Junction box			½" 14 NPS		
	Features	+			+			++		
	Maintenance	Low, Aiming			Low, Aiming			Low, Aiming		
PERFORMANCE	Lumens	1115			2104			2339–2468		
	Watts	13W			20W			20W		
	Efficacy (maximum LPW)	85			100			115–122		
	Distribution	NEMA 6X6 Wide			NEMA 6X6 Wide			NEMA 6X7 Wide		
	CCT	3000K			3000K			3000K, 4000K		
	CRI	70			80			70		
	Certifications	Listed for Wet Locations	UL1598	IP65	Listed for Wet Locations	UL1598	IP65	Listed for Wet Locations	UL1598	IP65
			Yes	Yes	Yes	Yes	Yes	Yes	Yes	Yes
	Product Life	60,000hrs.			60,000hrs.			60,000 hrs.		
	HID Equivalence	70W			100W			100W		
Energy Savings (Based on HID Equivalence)	86%			85%			83%			
Voltage	120V			120V			120V			
CONTROLS	Basic occupancy	–			Yes			–		
	Occupancy and Daylight Harvesting	–			Yes			–		

BEST			
tradeSELECT®			
			
ALF 6/12			
Yes			
½" 14 NPS			
++			
Med, Aiming, Adjustment			
1122, 2303			
26W			
85			
NEMA 6X6 Wide			
5000K			
70			
Listed for Wet Locations	UL1598	IP65	
Yes	Yes	Yes	Yes
60,000hrs.			
120W			
86%			
120V			
Yes			
Yes			



# WALL PACK

## MOUNTING HEIGHT GUIDE

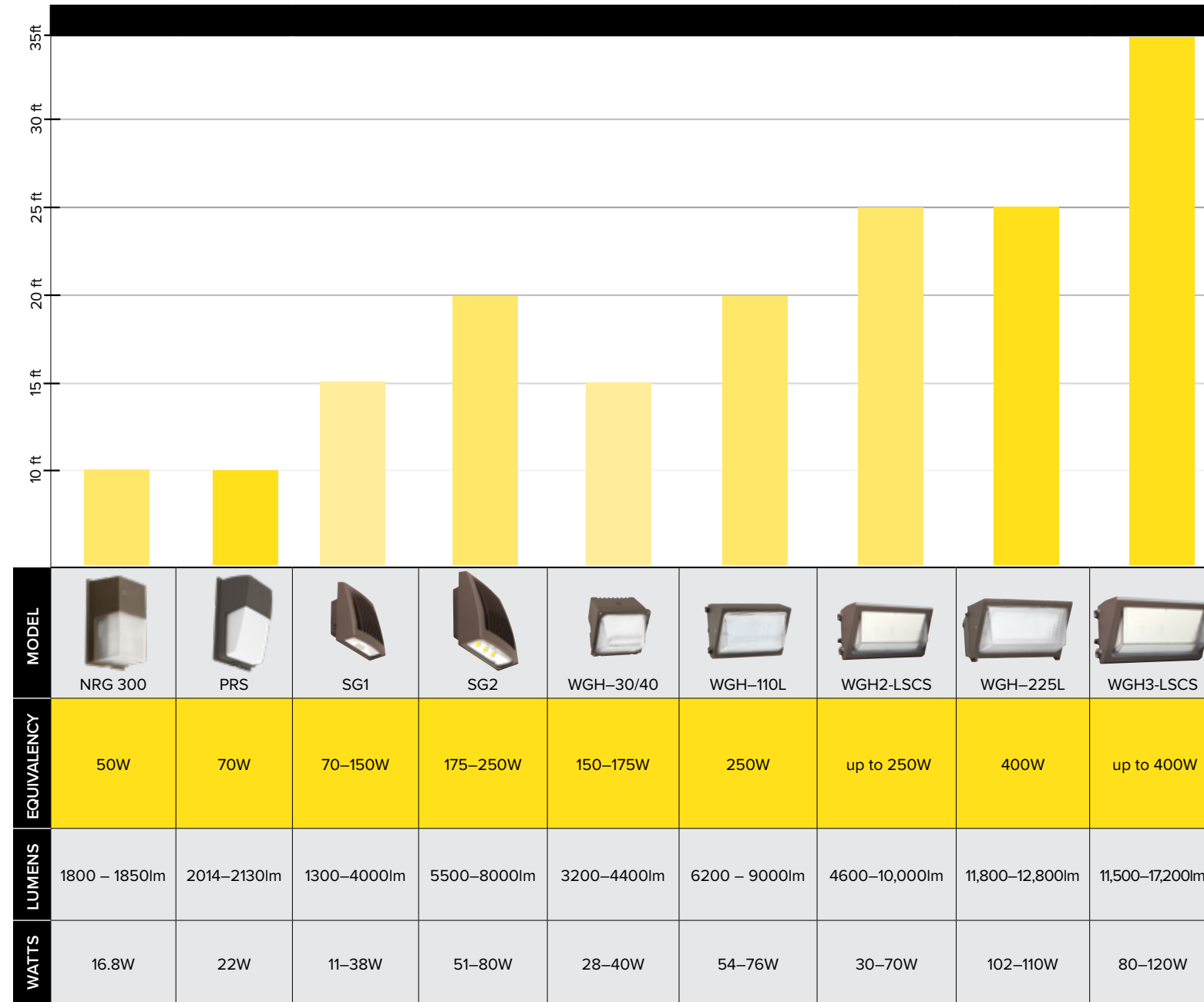

Not all configurations and outputs shown, please visit website for the most up-to-date information. Due to our continued efforts to improve our products, product specifications are subject to change without notice.

# SLING

## PERIMETER WALLPACK/ FLOODLIGHT

This slender wallpack is available in two sizes for a variety of applications. Its low profile form and wide range of outputs heights provide a scalable solution for mounting heights from eight to twenty feet. SLING luminaires feature a tempered glass lens, IP65 rating and floodlight mounting accessories.

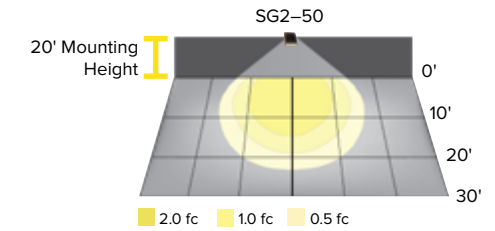

Fixture	Length	Width	Height	Weight
SG1	7.4in.	4.2in.	7.8in.	4.4lbs.
SG2	9.0in.	9.5in.	11.1in.	11.0lbs.



Part #	Catalog #	UPC	Lumens	Watts	CCT	Stock Location				Pallet Qty	Equivalency	DLC Listing
						CA	GA	IL	NJ			
SLING Small												
SG1104KPCU	SG1-10-4K-PCU	785988044726	1424	11W	4000K	.	.	.	.	192	70W	P56L9PT8
SG1204KPCU	SG1-20-4K-PCU	785988033201	2310	21W	4000K	.	.	.	.	192	100W	PJXKHKE3
SG1304KPCU	SG1-30-4K-PCU	785988033225	3060	29W	4000K	.	.	.	.	192	150W	PH9F4HZ2
SG1404KPCU	SG1-40-4K-PCU	785988044740	4070	38W	4000K	.	.	.	.	192	175W	P56L9PT8
SG110PCU	SG1-10-PCU	785988044719	1349	11W	5000K	.	.	.	.	192	70W	P1RK1H5S
SG120PCU	SG1-20-PCU	785988033195	2263	21W	5000K	.	.	.	.	192	100W	PTSF2YY
SG130PCU	SG1-30-PCU	785988033157	3270	29W	5000K	.	.	.	.	192	150W	PUCXBQEM
SG140PCU	SG1-40-PCU	785988044733	4008	38W	5000K	.	.	.	.	192	175W	P1RK1H5S
SLING Large												
SG2504KPCU	SG2-50-4K-PCU	785988033232	5526	51W	4000K	.	.	.	.	192	200W	PZTF3TT9
SG2804KPCU	SG2-80-4K-PCU	785988033232	8079	80W	4000K	.	.	.	.	192	250W	P25GRESH
SG250PCU	SG2-50-PCU	785988033171	5548	51W	5000K	.	.	.	.	192	200W	PK8TJMHT
SG280PCU	SG2-80-PCU	785988033188	8061	80W	5000K	.	.	.	.	192	250W	PXEQCQB8
Accessories												
SG1-KNUCKLE	SG1-KNUCKLE	785988033270	-	-	-	.	.	.	.	-	-	-
SG1-YOKE	SG1-YOKE	785988033249	-	-	-	.	.	.	.	-	-	-
SG2-KNUCKLE	SG2-KNUCKLE	785988038909	-	-	-	.	.	.	.	-	-	-
SG2-YOKE	SG2-YOKE	785988038893	-	-	-	.	.	.	.	-	-	-

# WGH2/3

## SWITCHABLE GLASS REFRACTOR WALLPACK

Featuring switchable lumen and wattage technology. Borosilicate glass refractor softens LED and provides uniform distribution. Field switchable lumens and LED color temperature (4000K, 4500K, & 5000K); wall mount at heights from 15-25ft.

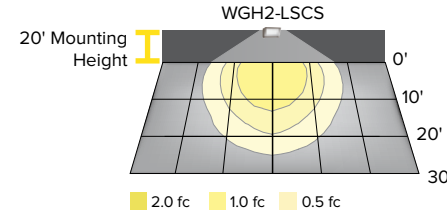

Fixture	Length	Width	Height	Weight
WGH2-LSCS	11.4in.	9.3in.	7.4in.	10.8lbs.
WGH3-LSCS	17.9in.	9in.	9.4in.	13.89lbs.

- 5yr WARRANTY
- 4000K, 5000K
- 29-100W
- 80CRI
- SWITCHABLE WATTAGE & CCT

Part #	Catalog #	UPC	Lumens	Watts	CCT	Stock Location				Pallet Qty	Equivalency	DLC Listing
						CA	GA	IL	NJ			
WGH Medium												
93131680	WGH2-LSCS	84014147950	4600-10,000	30-70W	4K, 4.5K, 5K	.	.	.	.	48	up to 250W	-
WGH Large												
93131681	WGH3-LSCS	84014147967	11,500-17,200	80-120W	4K, 4.5K, 5K	.	.	.	.	32	up to 400W	-

# WGH

## GLASS REFRACTOR WALLPACK

Provides energy-efficient, one-for-one replacement of existing legacy technology. Mid-power LEDs offer lower glare, better uniformity, higher efficacies (up to 119 LPW) and lower thermals for longer lasting electronic components. Borosilicate glass refractor softens LED and provides uniform distribution.

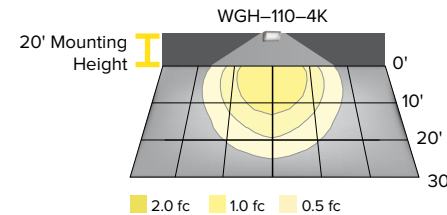

Fixture	Length	Width	Height	Weight
WGH-30/40	10.6in.	6.6in.	7.5in.	6.7lbs.
WGH-110L/133L	7.2in.	13in.	9.0in.	11.0lbs.
WGH-225L	13in.	17in.	9.0in.	19.0lbs.

- 5yr WARRANTY
- 4000K, 5000K
- 29-100W
- 80CRI

Part #	Catalog #	UPC	Lumens	Watts	CCT	Stock Location				Pallet Qty	Equivalency	DLC Listing
						CA	GA	IL	NJ			
WGH Small												
WGH304KUS	WGH-30-4K-U-S	785988044559	3259	28W	4000K	.	.	.	.	168	100W	PL0BH65AUE35
WGH305KUS	WGH-30-5K-U-S	785988044566	3326	28W	5000K	.	.	.	.	168	100W	PL46QSCHSPWE
WGH404KUS	WGH-40-4K-U-S	785988044573	4394	40W	4000K	.	.	.	.	168	150W	PLD29AELKVZ2
WGH405KUS	WGH-40-5K-U-S	785988044580	4484	40W	5000K	.	.	.	.	168	150W	PL947BAW5U9R
WGH Medium												
WGH110L4KUM	WGH-110L-4K-U-M	785988031139	6170	54W	4000K	.	.	.	.	48	175W	P2PWA7AJV
WGH110L5KUM	WGH-110L-5K-U-M	785988032990	6372	54W	5000K	.	.	.	.	48	175W	P43MX2XF
WGH133L4KUM	WGH-133L-4K-U-M	785988044597	8989	76W	4000K	.	.	.	.	108	250W	PLIZBWT2ITZR
WGH133L5KUM	WGH-133L-5K-U-M	785988044603	9173	76W	5000K	.	.	.	.	108	250W	PLFFO2EG8U2I
WGH Large												
WGH225L4KCL	WGH-225L-4K-C-L	78598831559	11,838	102W	4000K	.	.	.	.	32	400W	-
WGH225L4KUL	WGH-225L-4K-U-L	785988031146	11,838	102W	4000K	.	.	.	.	32	400W	PY86CS34D
WGH225L5KUL	WGH-225L-5K-U-L	785988033003	12,138	110W	5000K	.	.	.	.	32	400W	P6EP7CQZ

# PRS

## PERIMASHIELD WALLPACK

Compact stylish wallpack constructed of die-cast aluminum. Features impact resistant UV stabilized polycarbonate refractor. Mounts to standard 3-3/2" junction boxes with 1/2" conduit entry for surface mount applications. Optional photocontrol available for dusk to dawn operations.

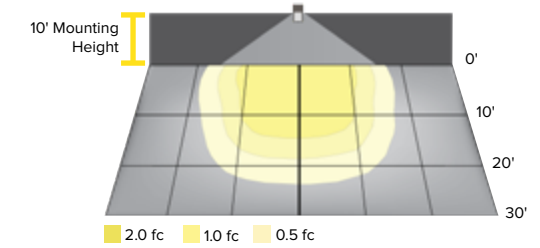

Length	Width	Height	Weight
10.9 in.	6.8 in.	4.8 in.	2.75 lbs.

- 5yr WARRANTY
- 4000K, 5000K
- 22W
- 80CRI

Part #	Catalog #	UPC	Lumens	Watts	CCT	Stock Location				Pallet Qty	Equivalency	DLC Listing
						CA	GA	IL	NJ			
93111053	PRS-20-4K-PC	840141419848	2130	22W	4000K	.	.	.	.	168	150W	P068RVSO
93111054	PRS-20-5K-PC	840141419855	2104	22W	5000K	.	.	.	.	168	150W	PWPEZ6XU
931115478	PRS-20-4K	840141419862	2130	22W	4000K	.	.	.	.	168	150W	P068RVSO
931115479	PRS-20-5K	840141419879	2104	22W	5000K	.	.	.	.	168	150W	PWPEZ6XU

# NRG® 300L

## POLYCARBONATE WALLPACK

Energy-efficient LED, features a one-piece polycarbonate front, vandal proof construction, dark bronze architectural finish. Photocontrol is available. Entry or single story perimeter lighting for safety, security and identity. Ideal for commercial buildings, shopping centers, schools, apartment complexes as well as non-supervised vandal prone applications.

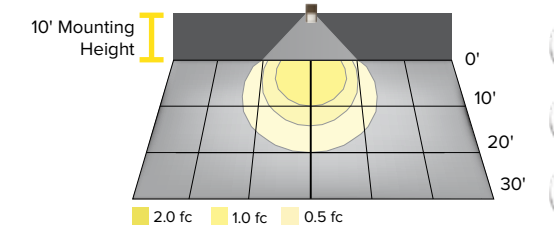



Length	Width	Height	Weight
5.4in.	6.9in.	11.2in.	6.0lbs.

- 5yr WARRANTY
- 4000K, 5000K
- 16W
- 80CRI

Part #	Catalog #	UPC	Lumens	Watts	CCT	Stock Location				Pallet Qty	Equivalency	DLC Listing
						CA	GA	IL	NJ			
93092004	NRG-356L-4K-U	785988031399	1858	16W	4000K	.	.	.	.	144	70W	PS9D61BU
93092005	NRG-356L-4K-U-PC	785988031405	1858	16W	4000K	.	.	.	.	144	70W	PS9D61BU
93092006	NRG-356L-5K-U	785988031412	1794	16W	5000K	.	.	.	.	144	70W	PXT41W62
93092007	NRG-356L-5K-U-PC	785988031429	1794	16W	5000K	.	.	.	.	144	70W	PXT41W62

# WALL PACKS

PRODUCT SELECTION GUIDE

		GOOD			BETTER		
		tradeSELECT®			tradeSELECT®		
							
		NRG® 300L			PRS PERIMASHIELD		
					WGH		
FEATURES	Easy to Install	Yes			Yes		
	Mounting Options	Junction box			Junction Box		
	Features	+			++		
	Maintenance	Low			Low		
PERFORMANCE	Lumens	1800			2104–2130		
	Watts	17W			22W		
	Efficacy (maximum LPW)	110			106		
	Distribution	Type IV			Type IV		
	CCT	4000K, 5000K			4000K, 5000K		
	CRI	70			70		
	Certifications	Listed for Wet Locations	UL1598	IP65	Listed for Wet Locations	UL1598	IP65
		Yes	Yes	–	Yes	Yes	–
	Product Life	60,000hrs.			60,000hrs.		
	HID Equivalence	70W			150W		
Energy Savings (Based on HID Equivalence)	75%			77%			
Voltage	120–277V			120–277V			
CONTROLS	Basic occupancy	Yes			Yes		
	Occupancy and Daylight Harvesting	–			–		
	Integrated Controls	–			–		

		BETTER						BEST		
		tradeSELECT®			tradeSELECT®			Additional Wallpaper		
										
		WGH2/WGH3			SLING WALL			LNC FAMILY		
PERFORMANCE	Easy to Install	Yes						Yes		
	Mounting Options	Junction box			Side door, Junction box			Mounting Plate, Junction box		
	Features	++++						+++		
	Maintenance	Low						Low		
	Lumens	4600–17,200			2200–8100			1000–14,800		
	Watts	30–120W			21–80W			35–170W		
	Efficacy (maximum LPW)	XXX-147			110–115			95–115		
	Distribution	Type IV			Type IV			Type II, Type III, Type IV		
	CCT	4000K, 4500, 5000K			3000K, 4000K, 5000K			3000K, 4000K, 5000K		
	CRI	70			70			70		
Certifications	Listed for Wet Locations	UL1598	IP65	UL1598	IP65	IP65	Listed for Wet Locations	UL1598	IP65	
	Yes	Yes	Yes	Yes	Yes	Yes	Yes	Yes	Yes	
Product Life	60,000hrs.			60,000hrs.			60,000hrs.			
HID Equivalence	150–400W			100–250W			70–400W			
Energy Savings (Based on HID Equivalence)	75–80%			70–80%			75–80%			
Voltage	120–277V			120–277V			120–277V			
CONTROLS	Basic occupancy	Yes						Yes		
	Occupancy and Daylight Harvesting	–						Yes		
	Integrated Controls	–						SiteSync™, NX		



# SLING SGD

## DUSK TO DAWN SECURITY LUMINAIRE

This stylish dusk-to-dawn area luminaire can be pole mounted or wall mounted and comes standard with a drop-down lens and integral twist-lock photocell.

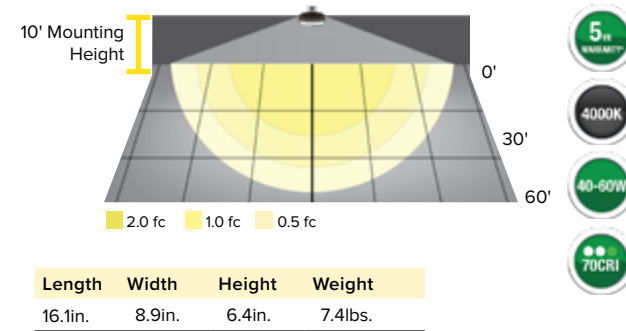

Part #	Catalog #	UPC	Lumens	Watts	CCT	Stock Location				Pallet Qty	Equivalency	DLC Listing
						CA	GA	IL	NJ			
93116179	SGD-40-4K-GR	840141419695	5000	40W	4000K	.	.	.	.	50	150W	PNWUPH67
93116182	SGD-40-4K	840141419718	5000	40W	4000K	.	.	.	.	50	150W	PNWUPH67
93116180	SGD-60-4K-GR	840141419701	8000	60W	4000K	.	.	.	.	50	250W	P72X46Z8
93116183	SGD-60-4K	840141419725	8000	60W	4000K	.	.	.	.	50	250W	P72X46Z8

# PATROLMAN

## MULTI-PURPOSE SECURITY LUMINAIRE

Rugged die-cast aluminum housing with both 2-3/8" & 1-5/8" OD mast arm mount capability as well as direct wall, surface mounting. Less refractor provides zero uplight design for environmentally friendly installations.

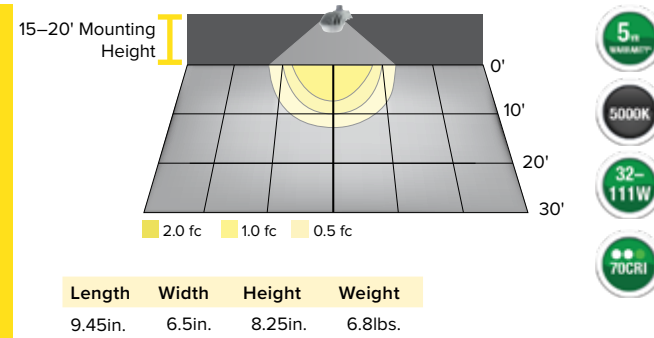

Part #	Catalog #	UPC	Lumens	Watts	CCT	Stock Location				Pallet Qty	Equivalency	DLC Listing
						CA	GA	IL	NJ			
DDL9L1	DDL-9L1	785988030699	4230	39W	5000K	.	.	.	.	40	175W	PC9A87FGV
DDL9LU	DDL-9LU	785988032945	4230	39W	5000K	.	.	.	.	40	175W	PC9A87FGV
DDL56L4K1NA	DDL-56L-4K-1-NA	785988041008	3748	43W	5000K	.	.	.	.	40	200W	PC9A87FGV
DDL140L1	DDL-140L1	785988031122	6097	30W	5000K	.	.	.	.	40	250W	PC9A87FGV
Accessories												
ARMDD24	ARM-DD24	785988033287	-	-	-	.	.	.	.	192	-	-
ARMDD30	ARM-DD30	785988033294	-	-	-	.	.	.	.	192	-	-

# DUSK TO DAWN

## PRODUCT SELECTION GUIDE

		BETTER			BEST		
		 PATROLMAN			 SLING SGD		
FEATURES	Easy to Install	Yes			Yes		
	Mounting Options	2 3/8"-1 5/8", Pipe & Wall Mount			2 3/8"-1 5/8", Pipe & Wall Mount		
	Features	++			++		
	Maintenance	Low, Aiming			Low, Aiming		
PERFORMANCE	Lumens	4320			5700-8000		
	Watts	39W			40, 60W		
	Efficacy (maximum LPW)	108			142-143		
	Distribution	Symmetric Type V			Type V		
	CCT	5000K			4000K		
	CRI	70			70		
	Certifications	Listed for Wet Locations	UL1598	IP65	Listed for Wet Locations	UL1598	IP65
		Yes	Yes	Yes	Yes	Yes	Yes
	Product Life	60,000hrs.			60,000hrs.		
	HID Equivalence	150W			100-250W		
Energy Savings (Based on HID Equivalence)	78%			78%			
Voltage	120-277V			120-277V			
CONTROLS	Basic occupancy	Yes			Yes		
	Occupancy and Daylight Harvesting	Yes			Yes		

# SLING CANOPY

## CANOPY

The low-profile SLING canopy luminaire provides a perfect retrofit solution for existing HID canopy luminaires up to 250W. The impact resistant polycarbonate lens increases durability while also reducing unwanted glare. Versatile surface or pendant mount.

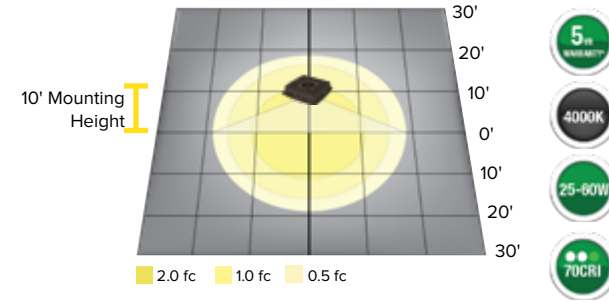



Length	Width	Height	Weight
10.2in.	3.6in.	6.4in.	4.9lbs.

- 5<sup>yr</sup> WARRANTY
- 4000K
- 25-60W
- 70CRI

Part #	Catalog #	UPC	Lumens	Watts	CCT	Stock Location				Pallet Qty	Equivalency	DLC Listing
						CA	GA	IL	NJ			
93116283	SGC-20-4K	840141419732	3000	25W	4000K	.	.	.	.	168	100W	PJFVWDXW
93116284	SGC-40-4K	840141419749	5000	40W	4000K	.	.	.	.	168	150W	P3Z8QRNP
93116286	SGC-40-4K-WH	840141419763	5500	40W	4000K	.	.	.	.	168	150W	P3Z8QRNP
93116285	SGC-60-4K	840141419756	8000	60W	4000K	.	.	.	.	168	250W	P72X46Z8

# CANOPY

## PRODUCT SELECTION GUIDE

		GOOD	BETTER	BEST	
		 SLING CANOPY	 LUMASQUARE	 BEACON DRIVE	
FEATURES	Easy to Install	Yes	Yes	Yes	
	Mounting Options	Standard J-Box-3/4" Pendant, 3 sided 1/2" 14 NPS threaded conduit entry	Standard J-Box or 3/4" Pendant	Standard J-Box or 3/4" Pendant	
	Features	++	++	+++	
	Maintenance	Low	Low	Low	
PERFORMANCE	Lumens	3000-8000	3000-9000	2,500-16,000	
	Watts	25-60W	25-75W	20-55W	
	Efficacy (maximum LPW)	120-133	120-127	109-125	
	Distribution	Type V	Type V	Type V, Type VC, Type VRW, Type IV	
	CCT	4000K	3000K, 4000K, 5000K	3000K, 4000K, 5000K	
	CRI	70	70	70	
	Certifications	Listed for Wet Locations	UL1598 IP65	Listed for Wet Locations UL1598 IP65	Listed for Wet Locations UL1598 IP65
		Yes	Yes Yes	Yes Yes Yes	Yes Yes Yes
	Product Life	60,000hrs.	60,000hrs.	60,000hrs.	
	HID Equivalence	100W	175-250W	175-250W	
Energy Savings	75%	75%	78%		
Voltage	120-277V	120-277V	120-277V		
CONTROLS	Basic occupancy	Yes, with optional PC	Yes	Yes	
	Occupancy and Daylight Harvesting	-	Yes	Yes	
	Integrated Controls	-	SiteSync™	NX	

# VAPORTITES

## CEILING/WALL VAPORTITES

Rugged die-cast aluminum construction, frosted globe with guard, wet location listed, energy-efficient LED vaportites for ceiling, pendant, wall mount. Use for entry, corridors, tunnels, service passages, stairwells. Gray powder paint finish.

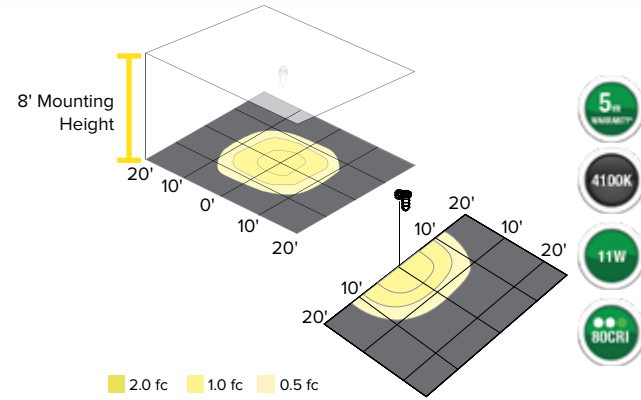

### Colored Globe Accessories



VGL-GN VGL-YW VGL-BU VGL-RD

Fixture	Length	Width	Height	Weight
VGBL-1	-	5.2in.	10.37in.	3.5lbs.
VWGL-1	7.34in.	5.2in.	11.0in.	3.6lbs.
Accessories				
VGL-FG	-	3.8in.	8.2in.	1.0lbs.
Colored Globes	-	3.8in.	8.2in.	1.0lbs.
VGL-GUARD	-	4.2in.	8.3in.	0.5lbs.

Part #	Catalog #	UPC	Lumens	Watts	CCT	Stock Location				Pallet Qty	Equivalency
						CA	GA	IL	NJ		
93092008	VGBL-1	785988030651	757	11W	4100K	•	•	•	-	-	70W
93092009	VWGL-1	785988030668	757	11W	4100K	•	•	•	-	-	70W
Accessories											
VGL-FG	VGL-FG	78598841282	-	-	-	•	•	-	-	-	-
VGL-GUARD	VGL-GUARD	-	-	-	-	•	-	-	-	-	-
Colored Globes											
VGL-GN	VGL-GN	78598841299	-	-	-	•	-	-	-	-	-
VGL-YW	VGL-YW	78598841312	-	-	-	•	-	-	-	-	-
VGL-BU	VGL-BU	78598841275	-	-	-	•	-	-	-	-	-
VGL-RD	VGL-RD	78598841305	-	-	-	•	-	-	-	-	-

# VAPORTITES

## PRODUCT SELECTION GUIDE

GOOD

		tradeSELECT®			tradeSELECT®		
		VGBL			VWGL		
FEATURES	Easy to Install	Yes			Yes		
	Mounting Options	Standard J-Box-Ceiling-4 sided ½" 14 NPS threaded conduit entry			Standard J-Box-4 sided ½" 14 NPS threaded conduit entry		
	Features	++			++		
	Maintenance	Low			Low		
PERFORMANCE	Lumens	757			757		
	Wattage	11W			11W		
	Efficacy (maximum LPW)	70			70		
	CCT	4100K			4100K		
	CRI	80			80		
	Certifications	Listed for Wet Locations	UL1598	IP65	Listed for Wet Locations	UL1598	IP65
		Yes	Yes	Yes	Yes	Yes	Yes
	Product Life	60,000hrs.			60,000hrs.		
	HID Equivalence	100w			100w		
	Energy Savings (Based on HID Equivalence)	82%			82%		
Voltage	120-277V			120-277V			

# COMPASS

Products feature economical energy-saving commercial and light industrial life safety products. Value engineered to reduce cost without sacrificing quality, the Compass Series provides a compact product offering that can be purchased and installed without compromise.

## LIFE SAFETY TABLE OF CONTENTS

EXIT AND EMERGENCY HEIGHT AND SPACING GUIDE.....	.55	CWC.....	.61	CU2SQ.....	.66
CC.....	.56	CEW.....	.61	CU2FO.....	.66
CE.....	.57	CC SQ.....	.62	CU2SO.....	.67
CU2HL.....	.58	CCE.....	.62	CUW.....	.67
CELEM.....	.58	CEL.....	.63	CSWEU2LED.....	.68
CPL25.....	.59	RME.....	.64	CUSO.....	.68
CELC.....	.59	CSR.....	.64	CIR.....	.69
CS.....	.60	CU2W.....	.65	COR.....	.69
		CU2.....	.65		

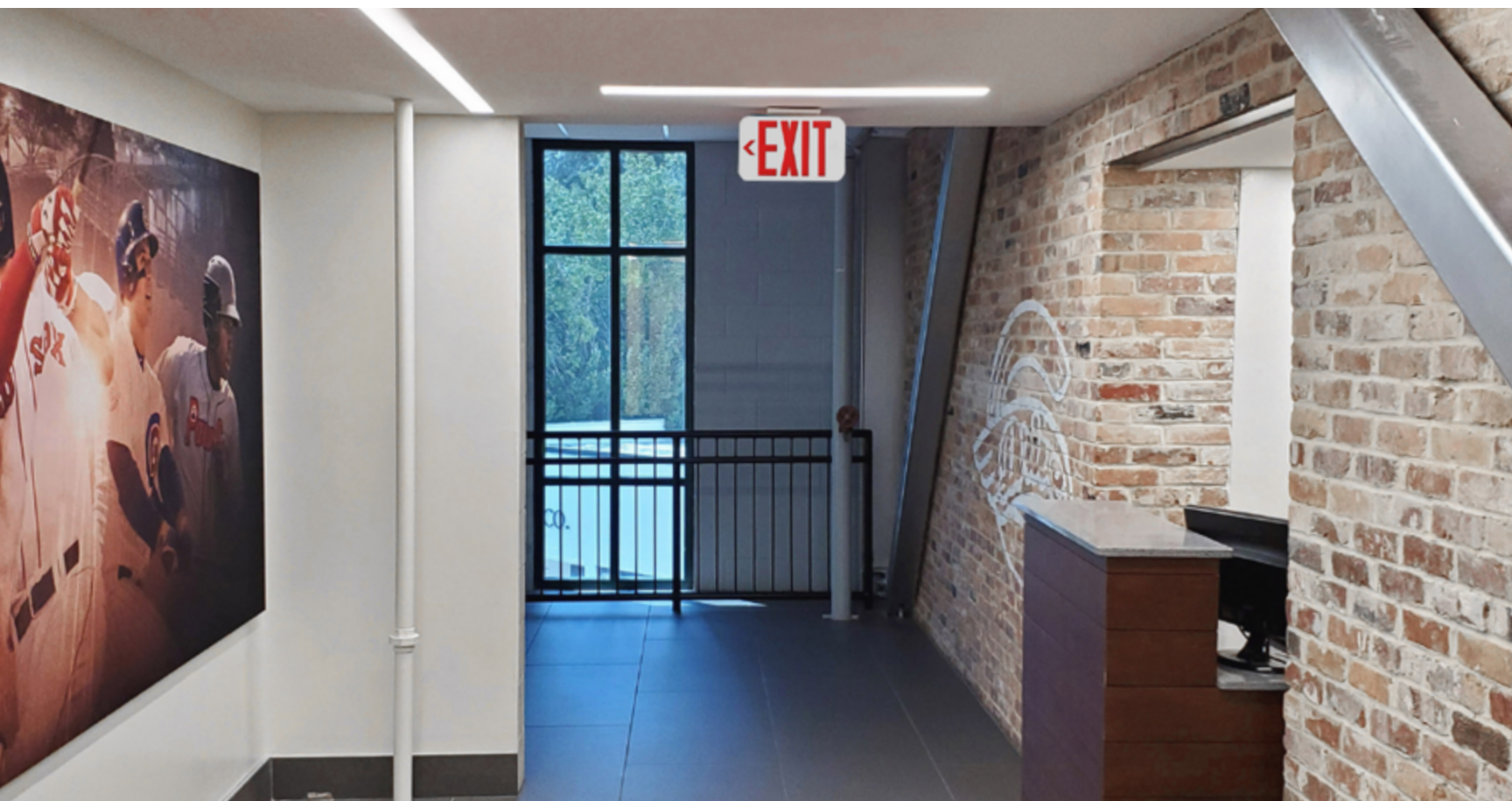

# EXIT AND EMERGENCY

## HEIGHT AND SPACING GUIDE

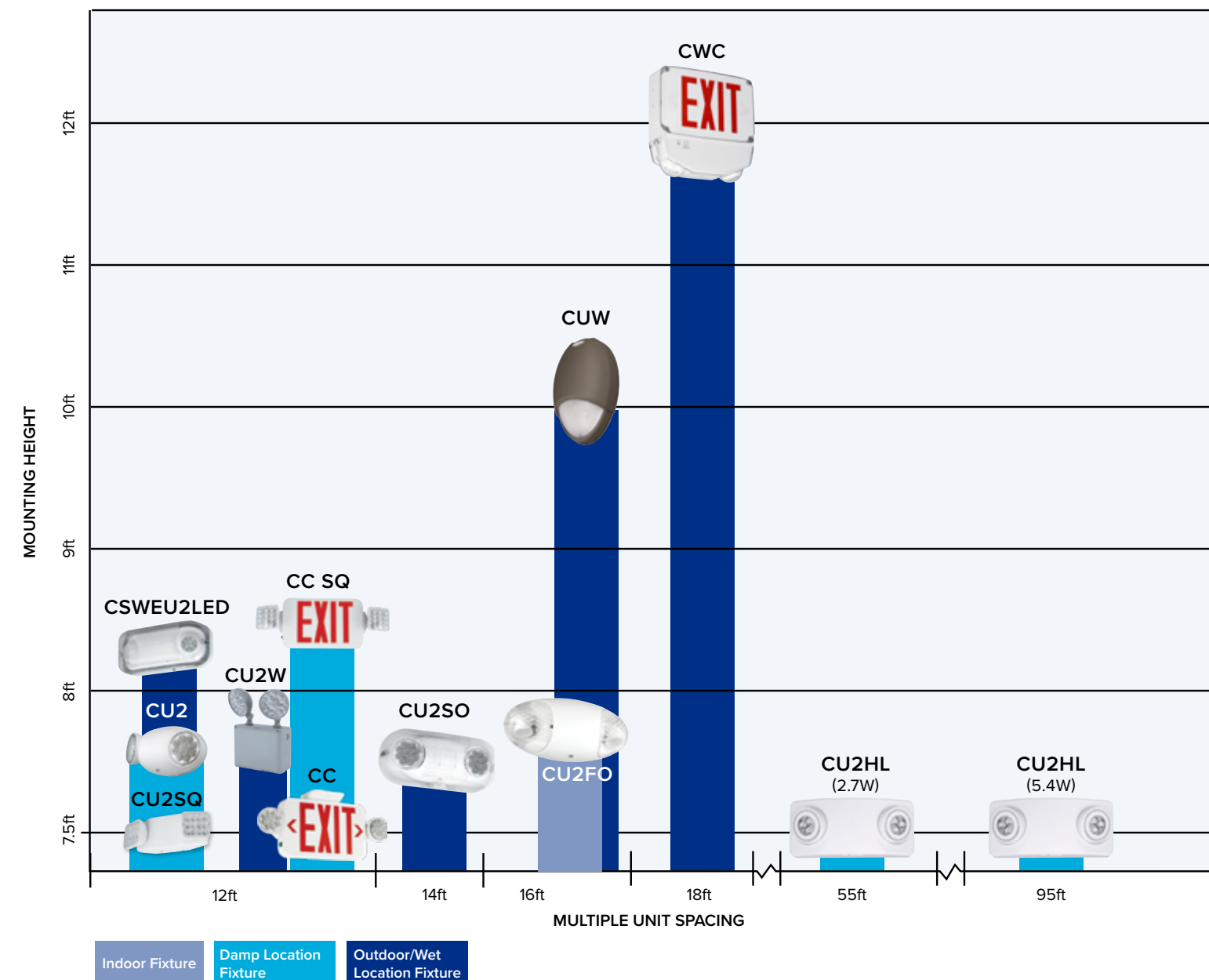

All multiple unit spacing and mounting height suggestions are based on a 6' path to obtain 1 footcandle average illumination. This information to be used as a product reference only. To obtain additional performance information, please refer to the specification sheet available at [www.dual-lite.com](http://www.dual-lite.com)

# CC

## COMBINATION EXIT/UNIT

- White or black housing made of high impact UL flame rated thermoplastic
- Molded-in template for quick installation
- Lamp-heads are fully adjustable
- Remote capacity or extended run-time option
- Matching indoor or outdoor remote heads CIRS, CIRD, CORD, CORS
- UL924 damp location listed



### OPTIONS



- Black or white finish
- Red or green Switchable LED
- Wall or canopy mount



Length	Width	Height	Weight
18.0in.	2.0in.	7.2in.	2.5lbs.

Part #	Catalog #	UPC	Remote Capacity	Self Diagnostics	Letter Color	Housing Color	Faces	Battery Type	Stock Location				CEC T20	Ctn Qty
									CA	GA	IL	NJ		
93104746	CCRG	782520871635			Both	White	Universal	NiCad	.	.	.	.	.	6
93104747	CCRGB	782520871642			Both	Black	Universal	NiCad	.	.	.	.	.	6
93104748	CCRGRC	782520871659	.		Both	White	Universal	NiMh	.	.	.	.	.	6
93104749	CCRGRCB	782520871666	.		Both	Black	Universal	NiMh	.	.	.	.	.	6
93043109	CCR	856143001400			Red	White	Universal	NiCad	.	.	.	.	.	6
93053078	CCRB	782520867096			Red	Black	Universal	NiCad	.	.	.	.	.	6
93043110	CCG	856143001417			Green	White	Universal	NiCad	.	.	.	.	.	6
93053079	CCGB	782520867102			Green	Black	Universal	NiCad	.	.	.	.	.	6
93043111	CCRRRC	856143001424	.		Red	White	Universal	NiMh	.	.	.	.	.	6
93053080	CCRRCB	782520867119	.		Red	Black	Universal	NiMh	.	.	.	.	.	6
93043112	CCGRC	856143001431			Green	White	Universal	NiMh	.	.	.	.	.	6
93091661	CCRS	856143002391		.	Red	White	Universal	NiCad	.	.	.	.	.	6
93091662	CCGS	856143002407		.	Green	White	Universal	NiCad	.	.	.	.	.	6
93091659	CCRRCS	856143002377	.	.	Red	White	Universal	NiMh	.	.	.	.	.	6
93091660	CCGRCS	856143002384	.	.	Green	White	Universal	NiMh	.	.	.	.	.	6

Note: Remote Capacity Unit will only power the Compass Indoor and Outdoor Remote (CIR and COR Series)  
See page 69 for Remote information

# CE

## EXIT SIGN

- Molded-in template for quick installation
- Universal single or double-face
- Remote capacity or extended run-time option
- Matching indoor or outdoor remote heads CIRS, CIRD, CORD, CORS
- UL924 damp location listed
- Universal face



### OPTIONS



- Black or white finish
- Red or green Switchable LED
- Wall or canopy mount



Length	Width	Height	Weight
12.6in.	2.0in.	8.2in.	2.0lbs.

Part #	Catalog #	UPC	Remote Capacity	Self Diagnostics	Letter Color	Housing Color	Battery Type	CEC T20	Damp Location 10° to 40°	Stock Location				Ctn Qty
										CA	GA	IL	NJ	
93104742	CARG	782520871598			Both	White	AC Only		.	.	.	.	6	
93104743	CARGB	782520871604			Both	Black	AC Only		.	.	.	.	6	
93104744	CERG	782520871611			Both	White	NiCad	.	.	.	.	.	6	
93104745	CERGB	782520871628			Both	Black	NiCad	.	.	.	.	.	6	
93081857	CAR	856143002209		.	Red	White	AC Only		.	.	.	.	6	
93081858	CAG	856143002216		.	Green	White	AC Only		.	.	.	.	6	
93081859	CARB	856143002223		.	Red	Black	AC Only		.	.	.	.	6	
93081860	CAGB	856143002230		.	Green	Black	AC Only		.	.	.	.	6	
93043113	CER	856143001448			Red	White	NiCad	.	.	.	.	.	6	
93053081	CERB	782520867126			Red	Black	NiCad	.	.	.	.	.	6	
93043114	CEG	856143001455			Green	White	NiCad	.	.	.	.	.	6	
93053082	CEGB	782520867133			Green	Black	NiCad	.	.	.	.	.	6	
93043116	CERRC	856143001462	.		Red	White	NiMh	.	.	.	.	.	6	
93053083	CERRCB	782520867140	.		Red	Black	NiMh	.	.	.	.	.	6	
93043117	CEGRC	856143001479	.		Green	White	NiMh	.	.	.	.	.	6	
93091663	CERS	856143002414		.	Red	White	NiCad	.	.	.	.	.	6	
93091664	CEGSD	856143002421		.	Green	White	NiCad	.	.	.	.	.	6	

Note: Remote Capacity Unit will only power the Compass Indoor and Outdoor Remote (CIR and COR Series)  
See page 69 for Remote information

# CU2HL

## HIGH LUMEN EMERGENCY LIGHT

- 2.7W units provide 55' spacing;
- 5.4W units have 95' spacing
- Battery recharge within 24 hours
- Damp Location Listed 10°C to 40°C (50°F to 104°F)
- Dual-voltage 120 through 277V AC, 50/60 Hz. input
- Includes long-life Lithium Iron Phosphate battery at 9.6Vdc for UL recognized 90 minute emergency lighting
- Provided with test switch and AC-On indicator
- Self-Test/Self-Diagnostic models available

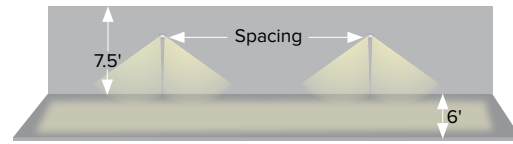

Multiple Unit Spacing (7.5' Mounting Height)

	Spacing	Path Width
CU2HL (2.7 Watt lamps)	55'	6'
CU2HL (5.4 Watt lamps)	95'	6'

Meets Life Safety Code minimum illuminance of 0.1 fc and average illumination of 1.0 fc. Photometry files available at [www.compasslightingproducts.com](http://www.compasslightingproducts.com)

Length	Width	Height	Weight
12.125in.	3.375in.	5.5in.	2.6lbs.



# CELEM

## RECESSED EMERGENCY LIGHT

- LED life-cycle exceeding 10 years
- Battery re-charge within 24 hours
- Damp location listed 10°C to 40°C (50°F to 104°F)
- Dual-voltage 120 or 277V AC, 60 Hz. input
- Includes long-life Nickel Metal Hydride battery for UL recognized 90 minute emergency lighting
- Provided with test switch and AC-On indicator

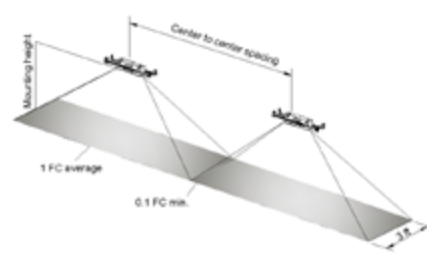

Length	Width	Height	Weight
10.0in.	2.0in.	3.0in.	3.0lbs.



Part #	Catalog #	UPC	Lumens	Battery Type	Mounting Height		Damp Location	Stock Location				Ctn Qty
					Spacing at 7.5ft.	Spacing at 10ft.		CA	GA	IL	NJ	
93116100	CELEM	782520871796	250	NiMh	24ft.	34ft.	.	.	.	.	6	
93116101	CELEMHO	782520871802	400	NiMh	30ft.	30ft.	.	.	.	.	6	

# CPL25

## LED EMERGENCY BATTERY PACK

- 90 Minutes of full lumen output
- 25 Watt output capacity
- Auto-Select 120/277V AC input/output
- Compatible with switched and unswitched loads
- Full battery recharge in 32 hours after complete discharge
- Remote test switch included standard
- Damp location listed for 20°C to 40°C operation

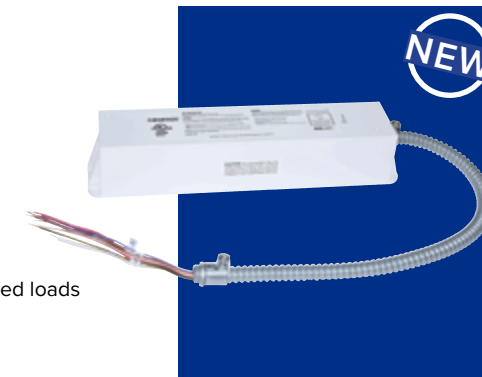

### Accessories



CRTS-Remote test switch

Length	Width	Height	Weight
15.8in.	3.3in.	3.0in.	7.7lbs.



Part #	Catalog #	UPC	Self Diagnostics	Load	Battery Type	Energy Consumption		Charge Current	Input/Output	Stock Location				Ctn Qty
						120/VAC	227/VAC			CA	GA	IL	NJ	
93104398	CPL25	782520871703	Yes	Up to 25 W	NiCad	9W	11W	450mA	120/277 VAC	.	.	.	.	2
Accessories														
93116849	CRTS	782520871703	-	-	-	-	-	-	-	.	.	.	.	10

# CELC

## EDGE-LIT COMBINATION EXIT AND EMERGENCY EXIT

- LED life cycle more than 10 years
- Quick installation
- Dual-voltage 120 or 277V AC input
- Includes long-life Nickel Metal Hydride battery for UL recognized 90 minute emergency lighting
- Damp location listed
- Fully adjustable lamp-heads
- Provided with test switch and AC-On indicator

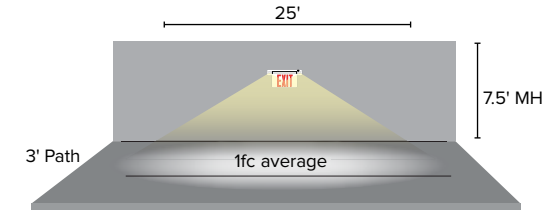

Length	Width	Height	Weight
17.2in.	0.2in.	9.9in.	7.0lbs.



Part #	Catalog #	UPC	Lumens	Test Switch	AC On Indicator	Mounting Type	Battery Type	# of Faces	Face Color	Stock Location				Ctn Qty
										CA	GA	IL	NJ	
93116092	CELCR1RN	782520871710	250	.	.	Recessed	NiMh	Single	Red	.	.	.	.	4
93116093	CELCR2RN	782520871727	250	.	.	Recessed	NiMh	Double	Red	.	.	.	.	4
93116094	CELCR1GN	782520871734	250	.	.	Recessed	NiMh	Single	Green	.	.	.	.	4
93116095	CELCR2GN	782520871741	250	.	.	Recessed	NiMh	Double	Green	.	.	.	.	4
93116096	CELCS1RN	782520871758	250	.	.	Surface	NiMh	Single	Red	.	.	.	.	4
93116097	CELCS2RN	782520871765	250	.	.	Surface	NiMh	Double	Red	.	.	.	.	4
93116098	CELCS1GN	782520871772	250	.	.	Surface	NiMh	Single	Green	.	.	.	.	4
93116099	CELCS2GN	782520871789	250	.	.	Surface	NiMh	Double	Green	.	.	.	.	4

# CS

## EMERGENCY LIGHT

- Exit face-plate and lamp-head shield made from high impact, UV stable polycarbonate
- LED based exit, emergency light for wall, ceiling or end mounting
- Includes Self-Test, Self-Diagnostics
- Fully adjustable LED lamp-heads at 3.6W each
- UL924 wet location listed

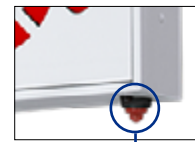

Durable aluminum housing



Push to test button

Fixture	Length	Width	Height	Weight
CS (with symbol)	18.6in.	2.0in.	7.7in.	6.1lbs.
CS (no symbol)	13.0in.	2.0in.	7.7in.	4.0lbs.

Part #	Catalog #	UPC	Dynamic Accessibility Symbol	Input Voltage		Power		Battery Type	Letter Color	Faces	Stock Location				Ctn Qty
				120V	277V	120V	277V				CA	GA	IL	NJ	
93099151	CSAUDR	856143002452	•	0.054W	0.024W	6.4W	6.7W	AC Only	Red	Universal					6
93099152	CSAUDG	856143002469	•	0.046W	0.021W	5.4W	5.7W	AC Only	Green	Universal					6
93099153	CSEUDR	856143002476	•	0.057W	0.027W	6.8W	7.5W	NiMH	Red	Universal					6
93099154	CSEUDG	856143002483	•	0.059W	0.028W	7.0W	7.0W	NiMH	Green	Universal					6
93099155	CSAUER	856143002490		0.027W	0.012W	3.1W	3.2W	AC Only	Red	Universal					8
93099156	CSAUEG	856143002506		0.044W	0.02W	5.1W	5.3W	AC Only	Green	Universal					8
93099157	CSEUER	856143002513		0.031W	0.013W	3.5W	3.6W	NiMH	Red	Universal					8
93099158	CSEUEG	856143002520		0.056W	0.026W	6.5W	7.1W	NiMH	Green	Universal					8

# CWC

## WET LOCATION EXIT, EMERGENCY LIGHT

- Exit face-plate and lamp-head shield made from high impact, UV stable polycarbonate
- Magnetic test switch and AC-On indicator
- Includes Self-Test, Self-Diagnostics
- Fully adjustable LED lamp-heads at 3.6W each
- UL924 wet location listed



Magnetic test switch and AC-On indicator



Wet location gasketed housing



Length	Width	Height	Weight
12.4in.	4.0in.	13.6in.	8.0lbs.

Part #	Catalog #	UPC	Faces	Letter Color	Input Watts		Input Amps		Cold Temp. Operation	Battery Type	Stock Location				Ctn Qty
					120V	277V	120V	277V			CA	GA	IL	NJ	
93063664	CWC1RW	856143001837	Single	Red	5.2W	5.2W	0.05A	0.022A		NiCad					4
93063665	CWC2RW	856143001844	Double	Red	5.2W	5.2W	0.05A	0.022A		NiCad					4
93063666	CWC1GW	856143001851	Single	Green	5.2W	5.1W	0.05A	0.021A		NiCad					4
93063667	CWC2GW	856143001868	Double	Green	5.2W	5.1W	0.05A	0.021A		NiCad					4
93063668	CWC1RW-CT	856143001875	Single	Red	33.6W	147.2W	0.288A	0.536A	•	NiCad					4
93063669	CWC2RW-CT	856143001882	Double	Red	33.6W	147.2W	0.288A	0.536A	•	NiCad					4
93063670	CWC1GW-CT	856143001899	Single	Green	33.6W	147.1W	0.288A	0.536A	•	NiCad					4
93063671	CWC2GW-CT	856143001905	Double	Green	33.6	147.1	0.288	0.536	•	NiCad					4

# CEW

## WET LOCATION EXIT

- LED life-cycle of more than 10 years
- Dual-voltage 120 or 277V AC input
- Housing is corrosion resistant and face-plate is fully gasketed
- Wet location listed (-20°C to 50°C)
- Provided with test switch and AC-On indicator
- Canopy included
- 24hr. re-charge



Wet Location gasketed Housing



Length	Width	Height	Weight
12.5in.	2.5in.	8.5in.	4.3lbs.

Part #	Catalog #	UPC	Letter Color	Faces	Battery Type	CEC T20	Stock Location				Ctn Qty
							CA	GA	IL	NJ	
93047782	CEWSRE	856143001646	Red	Single	NiCad	•	•	•			6
93047783	CEWDRE	856143001653	Red	Double	NiCad	•	•	•			6
93047784	CEWSGE	856143001660	Green	Single	NiCad	•	•				6
93047785	CEWDGE	856143001677	Green	Double	NiCad	•	•				6

# CC SQ

## COMBINATION EXIT, UNIT WITH SQUARE HEADS

- White or black housing made of high impact UL flame rated thermoplastic
- Molded-in template for quick installation
- Square heads are fully adjustable
- Remote capacity or extended run-time option
- Matching indoor or outdoor remote heads CIRS, CIRD, CORD, CORS
- UL924 damp location listed
- Test switch and AC-On indicator
- Wall or ceiling mount



Test Switch and AC-On indicator



Fully adjustable lamp heads



Length	Width	Height	Weight
18.0in.	2.0in.	7.2in.	2.5lbs.

Part #	Catalog #	UPC	Faces	Letter Color	Energy Consumption		Battery Type	Stock Location				Ctn Qty
					120VAC	277VAC		CA	GA	IL	NJ	
93081855	CCRHOSQ	856143002186	Universal	Red	3.9W	3.91W	NiCad	•	•	•	•	6
93081856	CCGHOSQ	856143002193	Universal	Green	5.0W	4.85W	NiCad	•	•	•	•	6

# CCE

## THIN DIE-CAST EXIT

- LED life-cycle of more than 10 years
- Molded-in template for quick installation
- Dual-voltage 120 or 277V AC input
- Emergency models include long-life 2.4VDC nickel cadmium battery for UL recognized 90 minute operation
- Damp location listed (0° to 50°C)
- Provided with test switch and AC-On indicator
- Canopy included
- 24hr. re-charge



Thin, brushed aluminum face



Length	Width	Height	Weight
11.6in.	0.8in.	7.7in.	2.8lbs.

Part #	Catalog #	UPC	Faces	Letter Color	Input Watts		Battery Type	Stock Location				Ctn Qty
					120VAC	277VAC		CA	GA	IL	NJ	
93047786	CCESRE	856143001684	Single	Red	1W	1W	NiCad	•	•	•	•	8
93047787	CCEDRE	856143001691	Double	Red	1W	1W	NiCad	•	•	•	•	8
93047788	CCESGE	856143001707	Single	Green	1W	1W	NiCad	•	•	•	•	8
93047789	CCEDGE	856143001714	Double	Green	1W	1W	NiCad	•	•	•	•	8
93047790	CCESR	856143001721	Single	Red	1W	1W	AC Only	•	•	•	•	8
93047791	CCEDR	856143001738	Double	Red	1W	1W	AC Only	•	•	•	•	8
93047792	CCESG	856143001745	Single	Green	1W	1W	AC Only	•	•	•	•	8
93047793	CCEDG	856143001752	Double	Green	1W	1W	AC Only	•	•	•	•	8

# CEL

## EDGE-LIT EXIT

- AC only or emergency models
- LED life-cycle of more than 10 years
- Damp location listed 20°C to 30°C (68°F to 86°F)
- Dual-voltage 120 or 277V AC input
- Low input power consumption at 3.72 Watts
- Field installed directional arrow indicators with template
- Mirror divider on single and double-face models
- Provided with test switch and AC-On indicator
- Canopy included for surface mount model



Test switch and AC-On indicator  
Edge-Lit exit sign with field installed directional arrows



Fixture	Length	Width	Height	Weight
CEL-wall mount	13.0in.	3.5in.	9.6in.	3.0-3.2lbs.
CEL-ceiling mount	15.0in.	4.0in.	10.3in.	5.9-6.1lbs

Part #	Catalog #	UPC	Letter Color	Mounting	Faces	Battery Type	Stock Location				Ctn Qty
							CA	GA	IL	NJ	
93070938	CELS1RN	856143002292	Red	Surface	Single	AC Only	•	•	•	•	6
93091653	CELS1GN	856143002315	Green	Surface	Single	AC Only	•	•	•	•	6
93070939	CELS2RN	856143002308	Red	Surface	Double	AC Only	•	•	•	•	6
93091654	CELS2GN	856143002322	Green	Surface	Double	AC Only	•	•	•	•	6
93070934	CELR1RN	856143002254	Red	Recessed	Single	AC Only	•	•	•	•	3
93070936	CELR1GN	856143002278	Green	Recessed	Single	AC Only	•	•	•	•	3
93070935	CELR2RN	856143002261	Red	Recessed	Double	AC Only	•	•	•	•	3
93070937	CELR2GN	856143002285	Green	Recessed	Double	AC Only	•	•	•	•	3
93043118	CELS1RNE	856143001547	Red	Surface	Single	NiCad	•	•	•	•	6
93043119	CELS1GNE	856143001554	Green	Surface	Single	NiCad	•	•	•	•	6
93043120	CELS2RNE	856143001561	Red	Surface	Double	NiCad	•	•	•	•	6
93043121	CELS2GNE	856143001578	Green	Surface	Double	NiCad	•	•	•	•	6
93043122	CELR1RNE	856143001585	Red	Recessed	Single	NiCad	•	•	•	•	3
93043123	CELR1GNE	856143001592	Green	Recessed	Single	NiCad	•	•	•	•	3
93043124	CELR2RNE	856143001608	Red	Recessed	Double	NiCad	•	•	•	•	3
93043125	CELR2GNE	856143001615	Green	Recessed	Double	NiCad	•	•	•	•	3



# RME

## RUNNING MAN EXIT SIGN

- Optional Self-Test, Self-Diagnostic feature to monitor proper operation
- Quick installation
- 120 through 347VAC, 50/60Hz.
- Includes long-life 4.8V DC nickel cadmium battery
- Full re-charge within 24 hours
- AC-On and test switch
- Fully automatic two-stage charger
- Wall, end or ceiling mount
- Canopy provided



Powder coated, 20 gauge steel construction

Test switch and AC-On indicator



Panel options

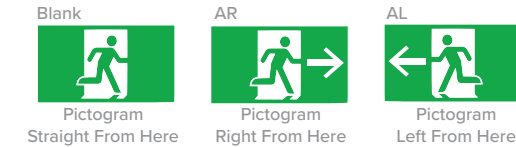

Length	Width	Height	Weight
14.1in.	5.6in.	5.5in.	6.0lbs.

# CSR

## INTERNATIONAL SALIDA EXIT

- Meets international input voltage installation
- Molded-in template for quick installation
- Universal single or double face SALIDA panel
- Optional long-life 4.8V nickel cadmium battery for 90 minute emergency lighting
- Provided with test switch and AC-On indicator



High impact thermoplastic housing

Test switch and AC-On indicator



Length	Width	Height	Weight
12.6in.	2.0in.	7.2in.	2.0lbs.

Part #	Catalog #	UPC	Faces	Input Watts		Input Amps		Battery Type	Stock Location				Ctn Qty
				120VAC	277VAC	120VAC	277VAC		CA	GA	IL	NJ	
93058261	CSREIV	856143001790	Universal	3.8W	3.8W	0.034A	0.02A	NiCad	•	•	•	•	6
93058260	CSRIV	856143001783	Universal	3.8W	3.8W	0.034A	0.02A	AC Only	•	•	•	•	6

# CU2W

## WET LOCATION EMERGENCY LIGHT

- LED life-cycle of more than 10 years
- Quick installation
- Dual-voltage 120 or 277V AC input
- Includes long-life 9.6VDC nickel cadmium battery for UL recognized 90 minute operation
- Remote capacity or extended runtime option
- Wet location listed (0°C to 50°C)
- Fully adjustable lamp-heads
- Provided with water-proof test switch and AC-On indicator



Gasketed lamp-heads for wet location listing



Water-proof test switch and AC-On indicator



Matching Wet Location Remote Heads

Length	Width	Height	Weight
8.0in.	3.6in.	12.2in.	7.5lbs.

Part #	Catalog #	UPC	Finish	Input Watts		Input Amps		Battery Type	Stock Location				Carton Qty
				120VAC	277VAC	120VAC	277VAC		CA	GA	IL	NJ	
93047780	CU2WG	856143001622	Grey	2.7W	2.7W	0.03A	0.013A	NiCad	•	•	•	•	4
93047781	CU2WB	856143001639	Black	2.7W	2.7W	0.03A	0.013A	NiCad	•	•	•	•	4

# CU2

## EMERGENCY LIGHT

- LED life-cycle of more than 10 years
- Quick installation
- Dual-voltage 120 or 277V AC input
- Remote capacity or extended runtime option
- Damp location listed 20°C to 30°C (68°F to 86°F)
- Fully adjustable, glare-free, lamp-heads
- Provided with test switch and AC-On indicator
- Wall or ceiling mount



Test switch and AC-On indicator



Length	Width	Height	Weight
9.0in.	2.7in.	4.0in.	1.0lbs.

Part #	Catalog #	UPC	Finish Color	Remote Capacity	Self-Test/ Self-Diagnostics	CEC T20 Compliant	Battery Type	Energy Consumption		Stock Location				Carton Qty
								120VAC	277VAC	CA	GA	IL	NJ	
93043107	CU2	856143001486	White	•	•	•	NiCad	.56W	.54W	•	•	•	•	12
93053076	CU2B	782520867072	Black	•	•	•	NiCad	.56W	.54W	•	•	•	•	12
93043108	CU2RC	856143001493	White	•	•	•	NiMh	.92W	1.62W	•	•	•	•	12
93053077	CU2RCB	782520867089	Black	•	•	•	NiMh	.92W	1.62W	•	•	•	•	12
93091657	CU2SD	856143002353	White	•	•	•	NiCad	.56W	.54W	•	•	•	•	12
93091658	CU2RCS	856143002360	White	•	•	•	NiMh	.92W	1.62W	•	•	•	•	12

Note: Remote Capacity Unit will only power the Compass Indoor and Outdoor Remote (CIR and COR Series)

# CU2SQ

## EMERGENCY LIGHT WITH SQUARE HEADS

- LED life-cycle of more than 10 years
- Quick installation
- Dual-voltage 120 or 277V AC input
- Damp location listed 20°C to 30°C (68°F to 86°F)
- Fully adjustable lamp-heads
- Provided with test switch and AC-On indicator
- Remote capacity (RC) models and AC-On indicator
- Wall or ceiling mount



Test switch and AC-On indicator



Length	Width	Height	Weight
12.3in.	3.6in.	4.3in.	1.0lbs.

Part #	Catalog #	UPC	Finish Color	Battery Type	Self-Test/ Self-Diagnostics	Remote Capacity	Energy Consumption		Stock Location				Ctn Qty
							120VAC	277VAC	CA	GA	IL	NJ	
93081852	CU2SQ	856143002155	White	NiCad			1.8W	1.8W	.	.	.	.	12
93081853	CU2SQB	856143002162	Black	NiCad			1.8W	1.8W	.	.			12
93081854	CU2RCSQ	856143002179	White	NiMH		.	2.5W	2.5W	.	.			12
93091665	CU2SQSD	856143002438	White	NiMH	.	.	1.8W	1.8W	.	.	.		12
93091666	CU2RCSQSD	856143002445	White	NiMH	.	.	2.5W	2.5W	.	.	.		12

# CU2FO

## FIXED OPTIC LED EMERGENCY LIGHT

- LED life-cycle of more than 10 years
- Quick installation
- Dual-voltage 120 or 277V AC input
- Includes long-life nickel cadmium battery for UL recognized 90 minute emergency lighting
- 12 LEDs per lamp-head for bright and even illumination
- Damp location listed 20°C to 30°C (68°F to 86°F)
- Provided with test switch and AC-On indicator
- Wall or ceiling mount



Fixed Optics



Test switch and AC-On indicator



Length	Width	Height	Weight
13.3in.	3.3in.	5.6in.	2.0lbs.

Part #	Catalog #	UPC	Finish Color	Battery Type	Energy Consumption		Stock Location				Ctn Qty
					120VAC	277VAC	CA	GA	IL	NJ	
93091656	CU2FO	856143002346	White	NiCad	2.4W	2.3W	.	.			12

# CU2SO

## SHIELDED OUTDOOR LED EMERGENCY LIGHT

- LED life-cycle of more than 10 years
- Quick installation
- Dual-voltage 102/277VAC input
- Includes long-life nickel cadmium battery for UL recognized 90 minute emergency lighting
- Wet location listed 0°C to 40°C (32°F to 104°F)
- Fully adjustable lamp-heads
- Includes test switch and AC-On indicator



Test switch and AC-On indicator

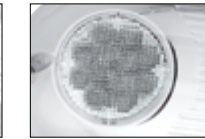

Fully adjustable optics and fully gasketed shield



Length	Width	Height	Weight
11.6in.	4.0in.	5.2in.	3.0lbs.

Part #	Catalog #	UPC	Finish Color	Battery Type	Energy Consumption		Stock Location				Ctn Qty
					120VAC	277VAC	CA	GA	IL	NJ	
93091655	CU2SO	856143002339	White	NiCad	3.59W	3.40W	.	.			12

# CUW

## OUTDOOR EMERGENCY LIGHT

- Includes self-diagnostic, self-test feature to monitor proper operation
- Quick installation
- NiCad battery type
- Universal 100-300VAC input
- Includes long-life 4.8VDC nickel cadmium battery for UL recognized 90 minute operation
- Full re-charge within 24 hours
- Provided with water-proof test switch & AC-On indicator
- UL924 wet location listed, 0°C to 50°C standard model, -20°C to 40°C with optional heater



Water-proof test switch & AC-On indicator



Length	Width	Height	Weight
6.5in.	3.7in.	10.4in.	4.0lbs.

Part #	Catalog #	UPC	Photo-Control	Self-Test/ Self-Diagnostics	Heater	Energy Consumption				Stock Location				Ctn Qty
						AC On		AC Off		CA	GA	IL	NJ	
						120VAC	277VAC	120VAC	277VAC					
93063364	CUWZ-PC	856143001806	.	.		9.0W	8.8W	2.0W	2.1W	.	.			6
93063366	CUWZ-HTR-PC	856143001820	.	.	.	18.4W	58.9W	11.5W	52.1W	.	.			6

# CSWEU2LED

## SHIELDED WET LOCATION EMERGENCY LIGHT

- Poly-carbonate shield
- LED life-cycle of more than 10 years
- Molded-in template for quick installation
- UL924 Wet location listed
- Full 2 year warranty
- Test switch and AC-On indicator
- Wall or ceiling mount



Test switch and AC-On indicator



Length	Width	Height	Weight
12.2in.	4.8in.	4.8in.	2.5lbs.

Part #	Catalog #	UPC	Finish Color	Battery Type	Energy Consumption (W)		RDC Location				Ctn Qty
					120V	277V	CA	GA	IL	NJ	
93081861	CSWEU2LED	856143002247	White	NiCad	1.90	1.90	.	.	.	.	6

# CUSO

## SLIM AC, EMERGENCY OUTDOOR LIGHT

- Durable die-cast aluminum housing
- Includes photo-sensor and PIR sensor
- Includes Self-Test, Self-Diagnostic
- UL924 wet location listed
- DLC listed
- 5 year warranty
- Optional heater
- 120-277VAC, 60Hz input

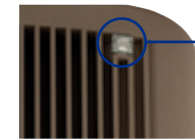

Photo-sensor



Length	Width	Height	Weight
9.1in.	2.5in.	6.3in.	4.5lbs.

Part #	Catalog #	UPC	Finish Color	Heater	PIR Sensor	Battery Type	Stock Location				Ctn Qty
							CA	GA	IL	NJ	
93073366	CUSO DB	856143002087	Dark Bronze			NiCad	.	.	.	.	6
93073367	CUSO DB-H	856143002094	Dark Bronze	.		NiCad	.	.	.	.	6
93073368	CUSO BK	856143002100	Black			NiCad	.	.	.	.	6
93073369	CUSO BK-H	856143002117	Black	.		NiCad	.	.	.	.	6
93073370	CUSO WH	856143002124	White			NiCad	.	.	.	.	6
93073371	CUSO WH-H	856143002131	White	.		NiCad	.	.	.	.	6
93080032	CUSO4DB-ND	782520869342	Dark Bronze		.	NiCad	.	.	.	.	6
93080033	CUSO4DB-H-ND	782520869359	Dark Bronze	.	.	NiCad	.	.	.	.	6
93080034	CUSO4BK-ND	782520869366	Black		.	NiCad	.	.	.	.	6
93080035	CUSO4BK-H-ND	782520869373	Black	.	.	NiCad	.	.	.	.	6
93080036	CUSO4WH-ND	782520869380	White		.	NiCad	.	.	.	.	6
93080037	CUSO4WH-H-ND	782520869397	White	.	.	NiCad	.	.	.	.	6

# CIR

## INDOOR REMOTE

- Fully adjustable lamp-heads
- Single or double lamp-head remote with base-plate
- UL924 damp location listed



Fully adjustable



Fixture	Length	Width	Height	Weight
CIRS	6.7in.	2.5in.	4.7in.	1.0lbs.
CIRD	4.6in.	2.6in.	4.7in.	1.2lbs.

Part #	Catalog #	UPC	Lamp Heads	Finish Color	Stock Location				Ctn Qty
					CA	GA	IL	NJ	
93043126	CIRS	856143001509	1	White	.	.	.	.	20
93103122	CIRSB	782520871253	1	Black	.	.	.	.	20
93043127	CIRD	856143001516	2	White	.	.	.	.	12
93103123	CIRDB	782520871260	2	Black	.	.	.	.	12

Powered by Compass Exit, Combo or Emergency Light with Remote Capacity

# COR

## OUTDOOR REMOTE

- Fully adjustable lamp-heads
- Single or double lamp-head remote with base
- Fully gasketed for application in wet environment
- UL924 damp location listed



Gasketed for outdoor applications

Fully adjustable lamp heads



Fixture	Length	Width	Height	Weight
CORS	4.5in.	4.5in.	6.7in.	1.0lbs.
CORD	7.4in.	7.4in.	5.6in.	1.2lbs.

Part #	Catalog #	UPC	Lamp Heads	Finish Color	Stock Location				Ctn Qty
					CA	GA	IL	NJ	
93043128	CORS	856143001523	1	White	.	.	.	.	20
93103124	CORSB	782520871277	1	Black	.	.	.	.	20
93043129	CORD	856143001530	2	White	.	.	.	.	12
93103125	CORDB	782520871284	2	Black	.	.	.	.	12

Powered by compass exit, combo or emergency light with remote capacity

# HUBBELL CONTROL SOLUTIONS

Lighting control technologies provide intuitive and flexible deployment options to meet code, enhance comfort, increase energy savings and improve operating efficiency for enterprises of any size.

## CONTROLS TABLE OF CONTENTS

CX LIGHTING CONTROL SYSTEMS . . . . .	71	OMNI® LOW VOLTAGE PIR. . . . .	76
LIGHTHAWK® . . . . .	72	POWER PACKS. . . . .	76
LIGHTHAWK®		UL924. . . . .	77
PRODUCT SELECTION GUIDE. . . . .	73	WALLBOX DIMMERS. . . . .	78
WASP. . . . .	74	LOW VOLTAGE SWITCHES. . . . .	78
OMNI® DUAL TECHNOLOGY . . . . .	75		



# CX LIGHTING CONTROL SYSTEMS

## COMMERCIAL LIGHTING CONTROL PANELS, RELAY AND SWITCHES

- LCD user interface with keypad
- Astronomical and real time clock
- Programmable dry contact inputs (dependent on panel size)
- Selectable pre-programmed scenarios
- Programmable switches for a variety of button functions



Model	Length	Width	Height	Weight
CX08 Panel	17.0in.	14.5in.	4.0in.	24.4lbs.
CX16 Panel	24.0in.	20.0in.	4.0in.	39.4lbs.
CX24 Panel	24.0in.	20.0in.	4.0in.	41.7lbs.
Emergency Relay	5.5in.	1.6in.	1.5in.	0.2lbs.
Dimming Card	3.5in.	3.5in.	1.75in.	0.5lbs.
Switches	4.3in.	1.1in.	1.1in.	0.2lbs.

Part #	Catalog #	UPC	Relay	# of Relays	Voltage	Stock Location			
						CA	GA	IL	NJ
Panels									
CX082S083LM	CX082S083LM	640181200631	8	1-Pole Latching	120/277VAC				
CX162S163LM	CX162S163LM	640181200938	16	1-Pole Latching	120/277VAC				
CX242S243LM	CX242S243LM	640181201058	24	1-Pole Latching	120/277VAC				

Part #	Catalog #	UPC	Relay	SCCR Rating	Voltage	Stock Location			
						CA	GA	IL	NJ
Emergency Relay									
CX3LEM	CX3LEM	640181729330	Latching	5K Amps	120/277/347VAC				

Part #	Catalog #	UPC	Panel Dimming Option Card Capacity			Stock Location			
			CA	GA	IL	NJ			
Dimming Card									
CXDIMCONTRBD	CXDIMCONTRBD	64018170163	CX08 – 1 CX Dimming Option Card	CX16 – Up to 2 CX Dimming Option Cards	CX24 – Up to 3 CX Dimming Option Cards				

Part #	Catalog #	UPC	Button Cap Legends Supplied					Stock Location			
			Raise	Lower	ON	OFF	ON/OFF	CA	GA	IL	NJ
Switches											
CXSW-1-WH	CXSW-1-WH	640181712080	-	-	-	-	1				
CXSW-2-WH	CXSW-2-WH	640181712097	1	1	1	1	-				
CXSW-3-WH	CXSW-3-WH	640181712103	1	1	-	-	3				
CXSW-4-WH	CXSW-4-WH	640181712110	1	1	2	2	-				
CXSW-6-WH	CXSW-6-WH	640181712127	-	-	-	-	-				

**IMPORTANT:** CXSW Switches connect to the Dimming Controller Option Board (CXDIMCONTRBD). These switch stations do not connect to the CX Panel without the dimming card.

# LIGHTHAWK®

## WALL SWITCH OCCUPANCY SENSOR

- Ultrasonic and Passive Infrared technologies for exceptional motion detection
- Manual-ON (Vacancy Sensor) or Automatic-ON (Occupancy Sensor) operation
- Patented IntelliDAPT® Technology
- 0-10V dimming versions available
- Built-in photo sensor for automatic daylight harvesting
- 400-1000 square-foot coverage area depending on model
- Fits standard decorator wall plate



Coverage Pattern

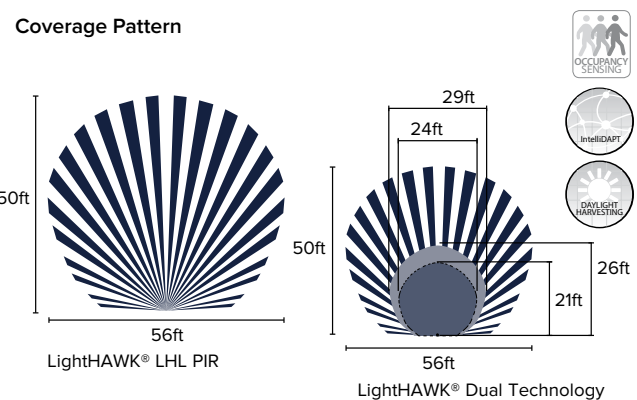



■ US Minor Motion □ US Major Motion ■ IR Major Motion

Model	Length	Width	Height	Weight
LightHAWK® Dimming PIR	1.7in.	1.7in.	3.3in.	0.5lbs.
LightHAWK® Dual Technology	1.7in.	1.7in.	3.3in.	0.5lbs.
LightHAWK® Dual Technology Dimming	1.7in.	1.7in.	3.3in.	0.5lbs.
LightHAWK® PIR	1.7in.	1.7in.	3.3in.	0.5lbs.
LightHAWK® LHL PIR	1.7in.	1.7in.	3.3in.	0.5lbs.

Part #	Catalog #	UPC	Dimming	Technology	Voltage	Stock Location				
						CA	GA	IL	NJ	
LightHAWK® Dimming PIR										
LHDMIRS3-N-WH	LHDMIRS3-N-WH	640181724496	0-10V	Passive Infrared	120/277V					.
LightHAWK® Dual Technology										
LHMTS1-N-WH	LHMTS1-N-WH	640181903938	No	Passive Infrared, Ultrasonic	120/277V			.	.	.
LHMTS1-G-WH	LHMTS1-G-WH	640181903839	No	Passive Infrared, Ultrasonic	120/277V			.	.	.
LHDCMTD2-G-WH	LHDCMTD2-G-WH	640181715739	No	Passive Infrared, Ultrasonic	120/277V			.	.	.
LHDCMTD2-N-WH	LHDCMTD2-N-WH	640181715739	No	Passive Infrared, Ultrasonic	120/277V			.	.	.
LightHAWK® Dual Technology Dimming										
LHDMMS2-N-WH	640181724687	640181715739	0-10V	Passive Infrared, Ultrasonic	120/277V			.	.	.
LightHAWK® PIR										
LHIRS1-G-WH	LHIRS1-G-WH	640181900739	No	Passive Infrared	120/277V			.	.	.
LHIRS1-N-WH	LHIRS1-N-WH	640181900913	No	Passive Infrared	120/277V			.	.	.
LHDCIRD2-G-WH	LHDCIRD2-G-WH	640181715432	No	Passive Infrared	120/277V			.	.	.
LHDCIRD2-N-WH	LHDCIRD2-N-WH	640181714534	No	Passive Infrared	120/277V			.	.	.
LightHAWK® LHL PIR										
LHL-IRS1-G-WH	LHL-IRS1-G-WH	640181708861	No	Passive Infrared	120/277V			.	.	.

# LIGHTHAWK®

## PRODUCT SELECTION GUIDE

	GOOD	BETTER	BEST
	<b>tradeSELECT®</b>  LightHAWK LHL PIR	<b>Mid-Spec Wall Switch</b>  LightHAWK PIR	<b>High-Spec Wall Switch</b>  LightHAWK Dual Tech
<b>Easy to Install</b>	Yes	Yes	Yes
<b>Features</b>	+	++	+++
<b>Sensing Technology</b>	PIR	PIR	PIR/US
<b>Self-adjusting Settings</b>	No	Yes – IntelliDAPT®	Yes – IntelliDAPT
<b>Mounting</b>	Standard Switch Box	Standard Switch Box	Standard Switch Box
<b>Coverage</b>	1,000 Sq. Ft., 180° coverage area	1,000 Sq. Ft., 180° coverage area	1,000 Sq. Ft., 180° coverage area
<b>Voltage</b>	120/277VAC;50/60Hz	120/277VAC;50/60Hz 347VAC; 50/60Hz 24VDC (requires UVPP)	120/277VAC;50/60Hz 347VAC; 50/60Hz 24VDC (requires UVPP)
<b>Electrical Ratings</b>	120VAC: 800W Incandescent/ Electronic Ballast/ LED Driver: 1,000W Magnetic Ballast; 1/6 HP Motor 277VAC: 1,800W Magnetic Ballast/ Electronic Ballast/ LED Driver: 1/6 HP Motor	120VAC: 800W Incandescent/Electronic Ballast/ LED Driver: 1,000W Magnetic Ballast; 1/6 HP Motor 277VAC: 1,800W Magnetic Ballast/ Electronic Ballast/ LED Driver: 1/6 HP Motor 347VAC: 1,500W Magnetic Ballast/ Electronic Ballast/ LED Driver: 1/6 HP Motor	120VAC: 800W Incandescent/Electronic Ballast/ LED Driver: 1,000W Magnetic Ballast; 1/6 HP Motor 277VAC: 1,800W Magnetic Ballast/ Electronic Ballast/ LED Driver: 1/6 HP Motor 347VAC: 1,500W Magnetic Ballast/ Electronic Ballast/ LED Driver: 1/6 HP Motor
<b>Minimum Load</b>	None	None	None
<b>Operating Modes</b>	Occupancy (Auto-ON) / Vacancy (Manual-ON)	Occupancy (Auto-ON) / Vacancy (Manual-ON)	Occupancy (Auto-ON) / Vacancy (Manual-ON)
<b>Time Delay</b>	4, 8, 16, 20 mins	4, 8, 15, 30 mins	4, 8, 15, 30 mins
<b>Photocell</b>	10-500 foot-candles	10-500 foot-candles	10-500 foot-candles
<b>Relay</b>	Single	Single and Dual versions	Single and Dual versions
<b>Operating Environment</b>	Indoor	Indoor	Indoor
<b>Occupancy and Daylight Harvesting</b>	Yes	Yes	Yes
<b>Construction</b>	RhinoTuff™ vandal resistant lens	RhinoTuff vandal resistant lens	RhinoTuff vandal resistant lens
<b>Color</b>	White; Ivory; Light Almond; Gray; Black	White; Ivory; Light Almond; Gray; Black	White; Ivory; Light Almond; Gray; Black
<b>Certifications</b>	Title 24, cULus	Title 24, cULus	Title 24, cULus
<b>USES</b>	Storerooms, Copier Rooms, Closets, Breakrooms, Small Single Person Bathrooms (No Stalls)	Storerooms, Copier Rooms, Closets, Breakrooms, Small Single Person Bathrooms (No Stalls)	Private Offices, Small Conference Rooms, Small Classrooms

# WASP

## FIXTURE MOUNT OCCUPANCY SENSORS

- Bluetooth® programming via controlHUBB App
- ON/OFF Control & 0–10V dimming models
- Tri-level set points
- Cloning of sensor settings
- Patented Intelliscope™ technology showing real-time occupancy data
- Multiple daylight harvesting modes

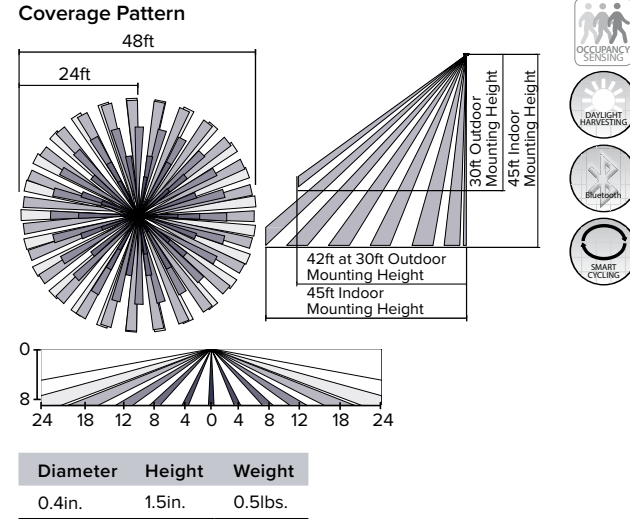

Part #	Catalog #	UPC	Coverage	Mounting	Voltage	Bluetooth®	Stock Location			
							CA	GA	IL	NJ
WSPMUNV	WSPMUNV	640181200839	See Lens Options*	End Mount	120/277/347V AC	–	•	•	•	
WSPSMUNV	WSPSMUNV	640181200419	See Lens Options*	Surface Mount	120/277/347V AC	–	•			
WSPSM24V	WSPSM24V	640181200457	See Lens Options*	Surface Mount	24VDC	–	•			
WSPLWOSM24V	WSPLWOSM24V	640181719621	See Lens Options*	Surface Mount	24VDC	–	•			
WSPDBEMUNV	WSPDBEMUNV	640181728579	See Lens Options*	End Mount	120–480V AC	Yes			•	
WSPDBSMUNV	WSPDBSMUNV	640181728630	See Lens Options*	Surface Mount	120–480V AC	Yes			•	
WSPDBSM24V	WSPDBSM24V	640181728609	See Lens Options*	Surface Mount	24V DC	Yes			•	
WSPDLWOBSM24V	WSPDLWOBSM24V	640181729477	See Lens Options*	Surface Mount	24V DC	Yes			•	
<b>Lens Options</b>										
WSP-L360-WH	WSP-L360-WH	640181708298	360° Area Lens	–	–	–			•	
WSP-L360-LM-WH	WSP-L360-LM-WH	640181708359	360° Area Lens	–	–	–			•	
WSPLWO-L360-WH	WSPLWO-L360-WH	640181718549	360° Area Lens	–	–	–			•	
WSPLWO-L360-LM-WH	WSPLWO-L360-LM-WH	640181718518	360° Area Lens	–	–	–			•	

\*Lenses sold separately.  
 Ordering Example: WSPDBEMUNV Sensor + WSP-L360-WH Lens  
 The Bluetooth® word mark and logos are registered trademarks owned by Bluetooth SIG, Inc. and any use of such marks by Hubbell Lighting Inc. is under license. Other trademarks and trade names are those of their respective owners.

# OMNI® DUAL TECHNOLOGY CEILING SENSOR

- Ultrasonic and Passive Infrared technologies for exceptional motion detection
- Smart IntelliDAPT® Technology eliminates false triggers
- 500–2000 Sq. Ft. coverage area per sensor (depending on model)
- Optional relay and photocell control



Diameter	Height	Weight
4.0in.	1.5in.	0.5lbs.

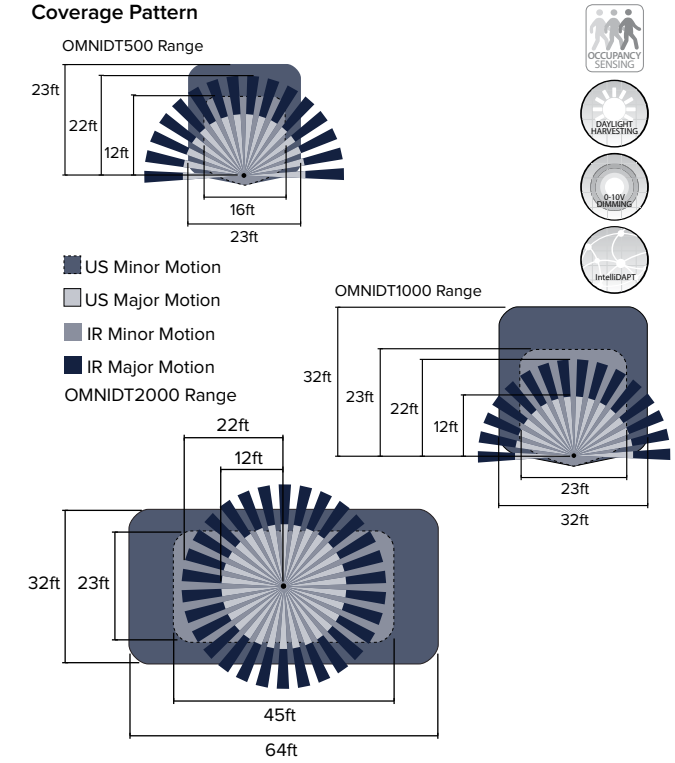

Part #	Catalog #	UPC	Technology	Coverage	Voltage	Stock Location			
						CA	GA	IL	NJ
OMNIDT500	OMNIDT500	640181402660	Passive Infrared & Ultrasonic	180°, 500 Sq. Ft.	24V DC	•	•		
OMNIDT500RP	OMNIDT500RP	640181402714	Passive Infrared & Ultrasonic	180°, 500 Sq. Ft.	24V DC	•	•		
OMNIDT1000	OMNIDT1000	640181402769	Passive Infrared & Ultrasonic	180°, 1000 Sq. Ft.	24V DC	•	•	•	
OMNIDT1000RP	OMNIDT1000RP	640181402813	Passive Infrared & Ultrasonic	180°, 1000 Sq. Ft.	24V DC	•	•	•	
OMNIDT1000BP1277	OMNIDT1000BP1277	640181411938	Passive Infrared & Ultrasonic	180°, 1000 Sq. Ft.	120/277V AC	•	•		
OMNIDT2000	OMNIDT2000	640181402868	Passive Infrared & Ultrasonic	360°, 2000 Sq. Ft.	24V DC	•	•	•	
OMNIDT2000RP	OMNIDT2000RP	640181402912	Passive Infrared & Ultrasonic	360°, 2000 Sq. Ft.	24V DC	•	•	•	
OMNIDT2000BP1277	OMNIDT2000BP1277	640181411945	Passive Infrared & Ultrasonic	360°, 2000 Sq. Ft.	120/277V AC	•	•		

## OMNI® PIR CEILING SENSOR

- Ultrasonic and Passive Infrared technologies for exceptional motion detection
- Smart IntelliDAPT® Technology eliminates false triggers
- 500–2000 Sq. Ft. coverage area per sensor (depending on model)
- Optional relay and photocell control



Coverage Pattern  
OMNI® IR Range

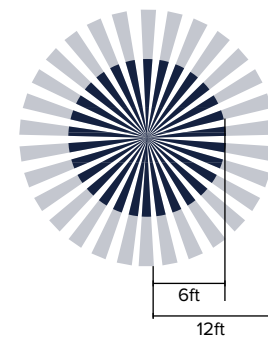

OMNI® IRL Range

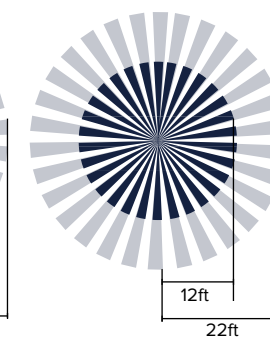

■ US Major Motion ■ US Minor Motion

Model	Diameter	Height	Weight
OMNI	4.5in.	1.5in.	0.5lbs.
OMNIDT	4.5in.	1.5in.	1.0lbs.

Part #	Catalog #	UPC	Technology	Coverage	Voltage	Stock Location			
						CA	GA	IL	NJ
OMNIIR	OMNIIR	640181403261	Passive Infrared	360°, 450 Sq. Ft.	24V DC	•	•		
OMNIIRL	OMNIIRL	640181403360	Passive Infrared	360°, 1500 Sq. Ft.	24V DC	•	•		
OMNIIRLRP	OMNIIRLRP	640181715432	Passive Infrared	360°, 1500 Sq. Ft.	24V DC	•	•		

## POWER PACKS UNIVERSAL VOLTAGE POWER PACKS

- Automatic voltage detection
- Electrical load switching capability; maximum of 20 Amps
- Regulated 24V DC current
- 150mA output short circuit protected
- Plenum rated
- Mounts inside or outside a junction box



Length	Width	Height	Weight
2.3in.	1.3in.	3.6in.	0.5lbs.

Part #	Catalog #	UPC	Low Voltage Switch Input	Voltage	Stock Location			
					CA	GA	IL	NJ
UVPP	UVPP	640181801685	No	120–277V AC	•	•	•	
UVPPM	UVPPM	640181720221	Yes	120–277V AC	•	•		

## UL924 AUTOMATIC LOAD RELAY

- Meets NEC Article 700 requirements for emergency lighting
- Dual voltage, 120 or 277V operation
- Normally closed contacts for emergency lighting
- Normally open contacts for 0–10V dimming override
- Provision for remote test button or fire alarm interface
- Multi-color function LED
- Suitable for use in return air plenums



Length	Width	Height	Weight
4.0in.	3.4in.	1.7in.	0.9lbs.

Part #	Catalog #	UPC	Low Voltage Switch Input	Voltage	Stock Location			
					CA	GA	IL	NJ
ALCR1277	ALCR1277	640181727237	Yes	120–277V AC				•

# WALLBOX DIMMERS

## PRESET & ROCKER SLIDE DIMMERS

- Separate ON/OFF switch that preserves the selected brightness level
- Provide single pole (one location) or 3-way (two location) lighting control
- Slim, compact housing fits easily into a standard wallbox
- Suitable for multi-gang installations
- Built-in radio, TV interference filter



Model	Length	Width	Height	Weight
Preset Slide Dimmer	1.7in.	0.4in.	4.1in.	0.1lbs
Rocker Slide Dimmer	1.7in.	0.4in.	4.1in.	0.1lbs

Part #	Catalog #	UPC	Dimming	Voltage	Stock Location			
					CA	GA	IL	NJ
<b>Rocker Slide Dimmer</b>								
RSD710-UNV-WVL	RSD710-UNV-WVL	640181726971	0-10V	1200VA @ 120V AC, 1500VA @ 277V AC				
RSDM10-120-WVL	RSDM10-120-WVL	640181726988	0-10V	1000VA @ 120 V AC MLV, 1000W @ 120V AC, 450W @ 120V AC Dimmable LED and CFL				
RSDE06-120-WVL	RSDE06-120-WVL	640181726995	0-10V	600VA @ 120V AC, Electronic Low Voltage, 300W @120V AC Dimmable LED and CFL				
RSDL06-120-WVL	RSDL06-120-WVL	640181727008	0-10V	600W @ 120V AC Incandescent, 300W @ 120V AC Dimmable LED and CFL				
<b>Preset Slide Dimmer</b>								
PSD710-UNV-WVL	PSD710-UNV-WVL	640181727152	0-10V	1200-1500VA @ 120/277V AC				

# LOW VOLTAGE SWITCHES

## MOMENTARY WALL SWITCH STATIONS

- Mounts to standard single-gang box
- Version with 0-10V dimming control
- Works with all HCS Control and Auxiliary packs



Length	Width	Height	Weight
4.1in.	1.5in.	4.1in.	0.2lbs.

Part #	Catalog #	UPC	Dimming	Switch Type	Button Qty	Stock Location			
						CA	GA	IL	NJ
LVSM1NPWH	LVSM1NPWH	640181100269	No	Momentary	1				
LVSD-M-3-WH	LVSD-M-3-WH	640181723055	0-10V	Momentary	3				







ARCHITECTURAL AREA LIGHTING

BEACON PRODUCTS

COLUMBIA LIGHTING

COMPASS

DUAL-LITE

HUBBELL CONTROL SOLUTIONS

HUBBELL OUTDOOR LIGHTING

KIM LIGHTING

KURT VERSEN

LITECONTROL

PRESCOLITE

WHITEWAY

trade**SELECT**<sup>®</sup>

701 Millennium Blvd. Greenville, SC 29607

Tel 864.678.1000

[www.hubbellighting.com](http://www.hubbellighting.com)

November 20, 2020 8:46 AM

Copyright © 2020 Hubbell Lighting, Inc. All rights reserved.

Please refer to online specifications for most up-to-date content as specifications are subject to change without notice.