

Wire Management Solutions



Connecting Power to Your World®



Providing a Bundle of Options

BURNDY® UNIRAP™ Cable Ties

From flame retardant nylon to tough stainless steel, BURNDY has just the right type of cable tie needed for any application. Choose from a wide array of colors, tensile strengths ranging from 18 to 900 pounds and latching mechanisms ready to be secured.

Stainless Steel Cable Ties (CTSS)

UNIRAP™ Stainless Steel Cable Ties are designed to secure hoses, cables, poles, pipes and more. Use our stainless steel cable ties when harsh environmental conditions may adversely affect the bundling application. UNIRAP™ Stainless Steel Cable Ties can be used in virtually any indoor, outdoor and underground application. They are especially useful where corrosion, vibration, weathering, radiation, and temperature extremes are a concern.



Stainless Steel Barb Ties (CT-SSB)

UNIRAP™ Stainless Steel Barb Ties are self-locking, nylon 6/6 and are cULus Listed for wiring positioning devices. The oval, low profile head design has no sharp edges, which helps to prevent damaged cables. Our barb ties have a curved tip for faster initial threading and installation, and a no-slip tail for easy grip during tensioning. CT-SSB ties are currently available in natural and UV black.



Stainless Steel Coated Ties (CTSS-PC and CTSS-FC)

UNIRAP™ Stainless Steel Coated Ties are designed with a steel ball-type locking mechanism. The smooth, rounded edges and polyester coating aid in safe installation and help to prevent damaged cables. High tensile strength, along with the shield of polyester coating, offers a reliable and lasting bundling solution that can be used in any indoor, outdoor or underground application. CTSS-FC ties are currently available in black.



Nylon 6/6

General purpose UNIRAP™ Nylon 6/6 Cable Ties are lightweight, high strength and offer wide temperature range options. Our nylon cable ties are halogen free so no dangerous gases, such as chlorine, bromine, fluorine and iodine are released when burned.

TABLE OF CONTENTS

Reference / Technical Information

Material Information	2
Available Materials	
Material Specifications	
Material Performance Guide	3
Catalog Numbering Schema	3
Military Specification Information	4
Precision Engineering, Enhanced Performance	5

Product Specific Information

Nylon 6/6

Standard Cable Ties	6-9
Identification Cable Ties	10
Push Mount Cable Ties	10
Releasable Cable Ties	11
Mounting Hole Cable Ties	12
Heat Stabilized Cable Ties	13
Cable Tie Mounting Bases	14
Cable Hangers	15
Stainless Steel Barb Cable Ties	16-17
Universal Grade Cable Ties	18-19
Universal Grade Mounting Hole Cable Ties	20
Universal Grade Mounting Bases	21
Cable Tie Variety Canisters	22

Velcro® Hook & Loop Straps

23

304 Stainless Steel Cable Ties

Uncoated	24
Partially Coated	25
Fully Coated	26

316 Stainless Steel Cable Ties

Uncoated	27
Partially Coated	28
Fully Coated	29

Wiley Bundle Straps & P-Clips

30-31

Wiley Cable Clips

32-33

Cable Tie Installation Tools

34

Alpha-Numeric Index

35-39

Material Information

Available Materials

Nylon 6/6 — General Purpose

General purpose nylon 6/6 features light weight, high strength and a wide temperature range. It is halogen free so it does not release dangerous gases, such as chlorine, bromine, fluorine and iodine when burned. Nylon 6/6 is hydroscopic, and therefore, absorbs or releases moisture depending on its environment. Thus, the moisture level of the material will affect tensile strength, stiffness and elongation of the product.

Nylon 6/6 — Heat Stabilized

With similar properties and benefits as nylon 6/6, products manufactured with heat stabilized nylon 6/6 material have a chemical stabilizer added for higher continuous temperature applications.

Nylon 6/6 — UV Stabilized

Chemical inhibitors are used to give nylon 6/6 material added properties to fight against premature aging of products due to the effects of ultraviolet rays.

Nylon 6/6 — UV Stabilized (2% Carbon for Military Specification)

The physical properties of this material include carbon, which acts as a UV stabilizer, prolonging the life of the product under ultraviolet conditions. It also allows cable ties to meet the particular military specification for cable ties.

Nylon 6/6 — V0 Flame Retardant

This material meets UL 94V-0 flammability requirements. Flame retardant additives generally reduce tensile strength when compared to general-purpose nylon 6/6, but this resin has been formulated to minimize such effects.

Nylon 6/6 — High Impact

Impact modifiers are added to increase flexibility. High impact nylon 6/6 has stable tensile strength due to its reduced influence from moisture. It is excellent for high vibration applications, as within the aircraft and automobile industries and performs better than nylon 6/6 against ultraviolet rays. Good for outdoor use.

Polypropylene

Polypropylene is used in environments where chemical effects on nylon are a concern. It is not affected by inorganic acids (hydrochloric), polyhydric alcohols (ethyleneglycol), neutral salts (sodium chloride) and basic salts (sodium bicarbonate). Polypropylene also resists a number of other chemicals with good results, although it has lower tensile strength than nylon 6/6 (about half). Polypropylene has good UV resistance.

Nylon 12 — UV Stabilized

Nylon 12 is resistant to chemicals and salts. Ideal for solar applications. Weather resistant grade, produced by the addition of stabilizers to the nylon resin.

Stainless Steel

Stainless Steel is used where corrosion, vibration, weathering, and temperature extremes are a concern. May be used for virtually any indoor, outdoor, or underground application. Available in both 304 and 316 Stainless Steel. Also available partially or fully coated with polyester.

Material Specifications

Material	Continuous* Operating Temperature Max. Min.	Tensile Strength at 73° F Dry as Molded ASTM D-638 (PSI)	UL Flame Rating	Oxygen Index %	Gamma Radiation Resistance	UV Resistance	Military, Federal, ASTM, and FDA Specifications
Nylon 6/6 — General Purpose (CT)	185° F —40° F 85° C —40° C	12,000	94V-2	28	1 x 10 ⁵ Rads	Poor	ASTM D-4066PA0111 FDA CFR177.1500
Nylon 6/6 — Heat Stabilized (CTHS)	220° F —40° F 105° C —40° C	12,000	94V-2	26	1 x 10 ⁵ Rads	Poor	ASTM D-4066PA0121
Nylon 6/6 — UV Stabilized (O)	185° F —40° F 85° C —40° C	12,000	94V-2	26	1 x 10 ⁵ Rads	Good	ASTM D4066PA0191
Nylon 6/6 — 2% Carbon UV Stabilized (OO)	220° F —40° F 105° C —40° C	12,000	94V-2	26	1 x 10 ⁵ Rads	Good	ASTM D-4066PA0181 MS3367/8
Nylon 6/6 — Flame Retardant (CTV)	185° F —40° F 85° C —40° C	10,800	94V-0	34	1 x 10 ⁵ Rads	Poor	ASTM D-4066PA0110
Nylon 6/6 — High Impact	185° F —40° F 85° C —40° C	8,800	94-HB	19	1 x 10 ⁵ Rads	Good	ASTM D-4066PA0150
Polypropylene — Chemical Resistant (CTPP)	185° F —40° F 85° C —40° C	3,400	94-HB	N/A	1 x 10 ⁵ Rads	Good	ASTM D-4101PP0320 FDA CFR177.1520
Nylon 12 — UV Stabilized	176° F —40° F 80° C —40° C	5,800	94-HB	N/A	9 x 10 ⁶ Rads	Good	ASTM D-4066PA411

* Elevated temperatures, over time, will affect materials' properties such as tensile strength, stiffness, elongation and appearance.

BURNDY® recommends the evaluation of cable ties in the actual application to determine the suitability of the tie for that application.

Material Performance Guide

Selection	Nylon 6/6 General Purpose	Nylon 6/6 Heat Stab.	Nylon 6/6 UV Stab.	Nylon 6/6 2% Carbon UV Stab.	Nylon 6/6 Flame Ret. V0	Nylon 6/6 High Impact	Poly- propylene	Nylon 12 UV Stab.
Tensile Strength	8	8	8	9	7	8	2	4
High Temp.	2	3	2	2	2	2	2	1
Flammability	5	5	5	5	10	2	2	2
UV Resistance	1	1	5	8	1	2	5	3
Radiation	3	3	3	3	3	3	6	3
Chemical	6	6	6	6	6	6	8	8
— Hydrocarbons	8	8	8	8	8	8	6	8
— Chlorinated	6	6	6	6	6	6	3	8
— Hydrocarbons	2	2	2	2	2	2	8	5
— Acids-Bases	6	6	6	6	6	6	8	6
— Salts	3	3	3	3	3	3	10	8
Relative Cost	Low	Low	Med.	Med.	Med.	Med.	Med.	Med.

1 = Least Recommended 10 = Most Recommended

The following chart is meant to help you understand BURNDY's cable tie catalog numbering system. Not every cable tie is available in every listed option. See below Catalog Numbering System Charts or contact BURNDY® Customer Service for more information.

Gray bars contain catalog number examples.

Type	Tensile	Bundle Dia.	Feature	Package	Color
CT	50	175		C	
CT = Nylon 6/6 Standard	18 = 18 lbs. 30 = 30 lbs. 40 = 40 lbs.	075 = 3/4" 087 = 7/8" 100 = 1"	CPM = Center Push Mount DL = Double Loop EPR = Extended Pawl Releasable	V = 5 X = 10 Q = 25	0 = UV Black ¹ 00 = UV Black ² 02 = Red
CTAS = Aerial Support	50 = 50 lbs. 100 = 100 lbs. 110 = 110 lbs. 120 = 120 lbs.	125 = 1-1/4" 137 = 1-3/8" 150 = 1-1/2" 175 = 1-3/4"	ID = Single Head ID ID2 = Double Head ID ID3 = Triple Head ID FL = ID Flag	L = 50 C = 100 B = 250 D = 500 M = 1000	1 = Brown 2 = Red 3 = Orange 4 = Yellow 5 = Green 6 = Blue 7 = Purple 8 = Gray 9 = Neon Green 10 = White 11 = Telco Gray 12 = Pink 20 = Black
CTHS = Nylon 6/6 Heat Stabilized	175 = 175 lbs. 225 = 225 lbs.	200 = 2" 225 = 2-1/4"	MH4 = Mounting Hole #4 MH6 = Mounting Hole #6 MH8 = Mounting Hole #8 MH10 = Mounting Hole #10 MH14 = Mounting Hole #14		
CTV = Nylon 6/6 Flame Retardant UL94V-0	250 = 250 lbs. 450 = 450 lbs. 500 = 500 lbs.	250 = 2-1/2" 300 = 3" 325 = 3-1/4"	PM = Push Mount Tie PML = Push Mount Tie w/Louvers PMW = Push Mount Tie w/Wing R = Releasable Tie LD = Ladder LP = Low Profile Tie PS = Positive Stop SSB = Stainless Steel Barb		
CTPP = Polypropylene	675 = 675 lbs. 700 = 700 lbs. 800 = 800 lbs. 900 = 900 lbs.	350 = 3-1/2" 400 = 4" 425 = 4-1/4"			
CTSS = Stainless Steel		500 = 5" 600 = 6" 700 = 7" 750 = 7-1/2" 800 = 8" 900 = 9" 1000 = 10" 1100 = 11" 1200 = 12" 1300 = 13" 1400 = 14"			Blank = Natural
CTNT = Nylon 12					
CT-UG = Nylon 6/6 Universal Grade					
CTWR = Weather Resistant			FC304 = Fully Coated 304 FC316 = Fully Coated 316 PC304 = Partially Coated 304 PC316 = Partially Coated 316 SSH = Stainless Steel Hook		

¹Material: Nylon 6/6 — UV Stabilized

²Material: Nylon 6/6 — 2% Carbon UV Stabilized (Mil. Spec.)

Type	Bundle Diameter	Adhesive/Mounting Type	Figure #	Package	Color
CTB	100	RA		C	0
CTB = Cable Tie Base	075 = 3/4"	RA = Rubber Adhesive	#1	L = 50	0 = UV Black
CTBR = Cable Tie Base Rectangular	125 = 1-1/4" 150 = 1-1/2"	AA = Acrylic Adhesive S = Screw Mounted	#2 #3	C = 100 D = 500 M = 1000	Blank = Natural
CTBRWR = Cable Tie Base Weather Resistant					

Military Specification UNIRAP™ Cable Ties

The BURNDY® cable ties shown below meet the requirements of SAE AS23190A (formerly MIL-S-23190) in accordance with specification MS3367, MS3368, and QPL-23190.

Mil Spec	Distributor Pack Catalog Number	Bulk Pack Catalog Number	Color
MS3367-1-0	CT50175C00	CT50175M00	UV Black ²
MS3367-1-0	CT50175C0	CT50175M0	UV Black ¹
MS3367-1-1	CT50175C1	—	Brown
MS3367-1-2	CT50175C2	CT50175M02	Red
MS3367-1-3	CT50175C3	—	Orange
MS3367-1-4	CT50175C4	—	Yellow
MS3367-1-5	CT50175C5	—	Green
MS3367-1-6	CT50175C6	—	Blue
MS3367-1-7	CT50175C7	—	Purple
MS3367-1-8	CT50175C8	—	Gray
MS3367-1-9	CT50175C	CT50175M	Natural
MS3367-2-0	CT50400C00	CT50400M00	UV Black ²
MS3367-2-0	CT50400C0	CT50400M0	UV Black ¹
MS3367-2-2	CT50400C2	CT50400M02	Red
MS3367-2-3	CT50400C3	—	Orange
MS3367-2-9	CT50400C	CT50400M	Natural
MS3367-3-0	CT120400L00	CT120400D00	UV Black ²
MS3367-3-0	CT120400L0	CT120400D0 CT120400M0	UV Black ¹
MS3367-3-9	CT120400L	CT120400D	Natural
MS3367-4-0	CT18075C00	CT18075M00	UV Black ²
MS3367-4-0	CT18075C0	CT18075M0	UV Black ¹
MS3367-4-9	CT18075C	CT18075M	Natural
MS3367-5-0	CT30125C00	CT30125M00	UV Black ²
MS3367-5-0	CT30125C0	CT30125M0	UV Black ¹
MS3367-5-9	CT30125C	CT30125M	Natural
MS3367-7-0	CT50300C00	CT50300M00	UV Black ²
MS3367-7-0	CT50300C0	CT50300M0	UV Black ¹
MS3367-7-2	CT50300C2	—	Red
MS3367-7-9	CT50300C	CT50300M	Natural
MS3367-10-0	CT175600Q0	—	UV Black ¹
MS3367-10-9	CT175600Q	—	Natural
MS3367-13-0	CT175900Q00	—	UV Black ²
MS3367-13-0	CT1751100Q0	—	UV Black ¹
MS3367-13-9	CT1751100Q	—	Natural

¹Material: Nylon 6/6 UV Stabilized

²Material: Nylon 6/6 2% UV Stabilized - Mil. Spec.

UNIRAP™

NYLON CABLE TIES

UNIRAP™ cable ties are fabricated of one piece Nylon with no metal parts. The straps are tough, resilient, lightweight and abrasion resistant. They offer high tensile strength and are chemically resistive to solvents, alkalies, oils, grease and diluted acids. Self-locking, they secure without twisting or leaving sharp projections.

Compact heads and pre-bent tips facilitate cable bundling in a minimum of time and space. UNIRAP™ cable ties are designed for both field and production line use and may be installed easily by hand.

BURNDY® cable ties consist of three components: strap, head, and tail. These components are specifically designed to function together to make BURNDY® UNIRAP™ cable ties superior in quality and performance. Shelf life of 5 years, when stored in original packaging.

Component

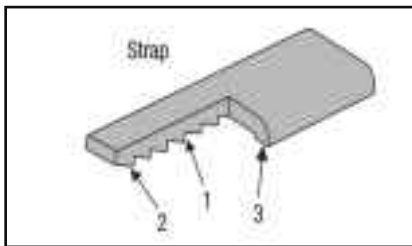

Precision Engineering

1. Includes load bearing **serrations**.
2. Features **flats** between the serrations.
3. Features the **double outer rail system**.

Enhanced Performance

1. Serrations provide complete adjustability within the fastening range.
2. Flats reduce stress concentrations and help make the tie stronger.
3. Smooth rails promote low drag, as well as minimize chafing.

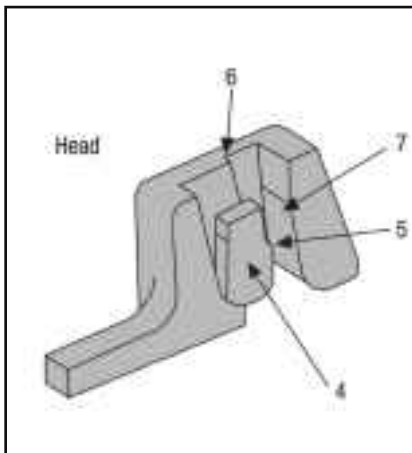

4. The **pawl** is integrally formed with the head.
5. The **pawl** is stepped in order to wedge against the serrations in the strap to form the lock.
6. The **shoulders**, or the sides of the head, guide the strap and prevent it from disengaging from the pawl during loaded conditions.
7. The **back** supports the strap during the wedging of the lock formation.

4. The locking unit will not disengage. It also promotes low insertion with high pull out force for very easy installation.
5. The tie's ultimate strength achieves optimum levels.
6. Promotes cable tie strength, endurance and longevity.
7. Ensure optimum locking capability.

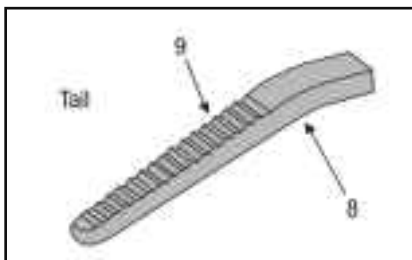

8. Features a **bent tip**.
9. Includes a **ribbed grip**.

8. Easy pick-up for installers, which leads to fast assembly.
9. Allows for easy, no-slip grip.

Wire Management Solutions



Nylon 6/6 Standard Cable Ties

UNIRAP™ Standard Cable Ties

Type CT

General purpose nylon 6/6 features light weight, high strength and a wide temperature range. It is halogen free so it does not release dangerous gases, such as chlorine, bromine, fluorine, or iodine when burned. Nylon 6/6 is hydroscopic, and therefore absorbs or releases moisture depending on its environment. Thus, the moisture level of the material will affect tensile strength, stiffness, and elongation of the product.



UV Black / UV Black (Mil. Spec.) are 2% Carbon UV Stabilized.



UL62275
Type 2 & 21

Std Pkg Catalog Number	Color	Max. Bundle Dia. In. [mm]	Min. Tensile Strength (lb)	Length	Width	Installation Tooling		Bulk Pkg Catalog Number	UL Type	Plenum Rated
				in [mm]	in [mm]	Tool	Tool Setting (if applicable)			
Nylon UNIRAP - 18 Lb. Tensile Strength										
CT18075C	Natural (Mil. Spec.)	0.75 [19.1]	18	4.10 [104]	0.10 [2.5]	CTT50 MK9	2 Std.	CT18075M	UL 62275, Type 2 & 21	Y
CT18075C0	UV Black (Mil. Spec.)							CT18075M0		
CT18075C00	UV Black (Mil. Spec.)							CT18075M00		
CT18125C	Natural	1.25 [31.8]	18	6.10 [155]	0.10 [2.5]	CTT50 MK9	2 Std.	CT18125M		
CT18125C0	UV Black							CT18125M0		
CT18125C3	Orange							-		
CT18125C4	Yellow							-		
CT18200C	Natural	2.00 [50.8]	18	8.10 [206]	0.10 [2.5]	CTT50 MK9	2 Std.	CT18200M		
CT18200C1	Brown							-		
CT18200C2	Red							-		
CT18200C5	Green							-		
CT18200C6	Blue							-		
CT18200C0	UV Black							CT18200M0		
Nylon UNIRAP - 30 Lb. Tensile Strength										
CT30125C	Natural (Mil. Spec.)	1.25 [31.8]	30	5.75 [146]	0.14 [3.6]	CTT50 MK9	2 Std.	CT30125M	UL 62275, Type 2 & 21	Y
CT18125C3	Orange							-		
CT18125C4	Yellow							-		
CT30125C0	UV Black (Mil. Spec.)							CT30125M0		
CT30125C00	UV Black (Mil. Spec.)							CT30125M00		

UNIRAP™

Standard Cable Ties (Continued)



Std Pkg Catalog Number	Color	Max. Bundle Dia. In. [mm]	Min. Tensile Strength (lb)	Length	Width	Installation Tooling		Bulk Pkg Catalog Number	UL Type	Plenum Rated
				in [mm]	in [mm]	Tool	Tool Setting (if applicable)			
Nylon UNIRAP - 40 Lb. Tensile Strength										
CT40200C	Natural	2.00 [50.8]	40	8.65 [220]	0.14 [3.6]	CTT50 MK9	2 Std.	CT40200M	UL 62275, Type 2 & 21	Y
CT40200C0	UV Black							CT40200M0		
CT40200C00	UV Black							CT40200M00		
CT40300C	Natural	3.00 [76.2]		11.10 [282]	0.18 [4.6]	CTT50 MK9	3 Std.	CT40300M		
CT40300C0	UV Black							CT40300M0		
CT40300C00	UV Black							CT40300M00		
CT40400C	Natural	4.00 [101.6]		14.60 [371]	0.18 [4.6]	CTT50 MK9	3 Std.	CT40400M		
CT40400C0	UV Black							CT40400M0		
CT40400C00	UV Black							CT40400M00		
Nylon UNIRAP - 50 Lb. Tensile Strength										
CT50175C	Natural (Mil. Spec.)	1.75 [44.5]	50	7.60 [193]	0.18 [4.6]	CTT50 MK9	3 Std.	CT50175M	UL 62275, Type 2 & 21	Y
CT50175C0	UV Black (Mil. Spec.)							CT50175M0		
CT50175C1	Brown (Mil. Spec.)							CT50175M02		
CT50175C2	Red (Mil. Spec.)							-		
CT50175C3	Orange (Mil. Spec.)							-		
CT50175C4	Yellow (Mil. Spec.)							-		
CT50175C5	Green (Mil. Spec.)							-		
CT50175C6	Blue (Mil. Spec.)							-		
CT50175C7	Purple (Mil. Spec.)							-		
CT50175C8	Gray (Mil. Spec.)							-		
CT50175C00	UV Black (Mil. Spec.)							CT50175M00		

Wire Management Solutions



Nylon 6/6 Standard Cable Ties

UNIRAP™

Standard Cable Ties (Continued)



Std Pkg Catalog Number	Color	Max. Bundle Dia. In. [mm]	Min. Tensile Strength (lb)	Length	Width	Installation Tooling		Bulk Pkg Catalog Number	UL Type	Plenum Rated
				in [mm]	in [mm]	Tool	Tool Setting (if applicable)			
CT50300C	Natural (Mil. Spec.)	3.00 [76.2]	50	11.10 [282]	0.18 [4.6]	CTT50 MK9	3 Std	CT50300M	UL 62275, Type 2 & 21	Y
CT50300C0	UV Black (Mil. Spec.)							CT50300M0		
CT50300C2	Red (Mil. Spec.)							-		
CT50300C00	UV Black (Mil. Spec.)	4.00 [101.6]	50	14.60 [371]	0.18 [4.6]	CTT50 MK9	3 Std	CT50300M00	UL 62275, Type 2 & 21	Y
CT50400C	Natural (Mil. Spec.)							CT50400M		
CT50400C0	UV Black (Mil. Spec.)							CT50400M0		
CT50400C2	Red (Mil. Spec.)							CT50400M02		
CT50400C3	Orange (Mil. Spec.)							-		
CT50400C00	UV Black (Mil. Spec.)							CT50400M00		

Nylon UNIRAP - 120 Lb. Tensile Strength

CT120200L	Natural	2.00 [50.8]	120	9.00 [229]	0.30 [7.6]	MK9	Heavy	CT120200D	UL 62275, Type 2 & 21	Y
CT120200L0	UV Black (Mil. Spec.)							CT120200D0		
CT120300L	Natural	3.00 [76.2]	120	12.00 [305]	0.30 [7.6]	MK9	Heavy	CT120300D	UL 62275, Type 2 & 21	Y
CT120300L0	UV Black							CT120300D0		
CT120400L	Natural (Mil. Spec.)	4.00 [101.6]	120	15.00 [381]	0.30 [7.6]	MK9	Heavy	CT120400D	UL 62275, Type 2 & 21	Y
CT120400L0	UV Black (Mil. Spec.)							CT120400D0 CT120400M0		
CT120400L00	UV Black (Mil. Spec.)							CT120400D00		
CT120800L	Natural	8.00 [203.2]	120	28.51 [724]	0.30 [7.6]	MK9	Heavy	-	UL 62275, Type 2 & 21	N
CT120800L00	UV Black							-		

US: 1-800-346-4175 / International: 1-603-647-5299 / Canada: 1-800-387-6487 / www.burndy.com

UNIRAP™

Standard Cable Ties (Continued)



Std Pkg Catalog Number	Color	Max. Bundle Dia. In. [mm]	Min. Tensile Strength (lb)	Length		Installation Tooling		Bulk Pkg Catalog Number	UL Type	Plenum Rated
				in [mm]	Width in [mm]	Tool	Tool Setting (if applicable)			
Nylon UNIRAP - 175 Lb. Tensile Strength										
CT175500Q	Natural	5.50 [139.7]	175	18.10 [460]	0.34 [8.6]	MK9	Heavy	—	UL 62275, Type 2 & 21	Y
CT175500Q0	UV Black									
CT175600Q	Natural (Mil. Spec.)	7.00 [177.8]		24.51 [622]	0.35 [8.9]					
CT175600Q0	UV Black (Mil. Spec.)									
CT175800Q0	UV Black	8.90 [222.1]		32.67 [830]	0.35 [8.9]					
CT175900Q	Natural	8.75 [222.0]		36.50 [927]	0.34 [8.6]					
CT175900Q00	UV Black (Mil. Spec.)									
CT1751100Q	Natural (Mil. Spec.)	11.00 [279.4]		48.00 [1219]	0.35 [8.9]					
CT1751100Q0	UV Black (Mil. Spec.)									
CT1751400Q0	UV Black	15.00 [381.0]		48.50 [1232]	0.34 [8.6]					
CT1751500Q	Natural									
Nylon UNIRAP - 250 Lb. Tensile Strength										
CT250600Q	Natural	6.00 [152.4]	250	23.00 [584]	0.35 [8.9]	MK9	Heavy	—	UR 1565	N
CT250600Q0	UV Black									
CT250800Q	Natural	8.00 [203.2]		28.74 [730]	0.35 [8.9]					
CT250800Q0	UV Black									
CT2501000Q	Natural	10.00 [254.0]		34.64 [880]	0.50 [12.7]					
CT2501200Q	Natural	12.00 [305.0]		40.00 [1016]	0.50 [12.7]					
CT2501200Q0	UV Black									

Wire Management Solutions



Nylon 6/6 Identification (CT-IDC) and Push Mount (CT-PM) Cable Ties

UNIRAP™ Identification Cable Ties

Type CT-ID

Identification cables ties are used in both bundling and identifying the wire groups at the same time. Same material, features and benefits as the Nylon 6/6 Standard Cable Ties.

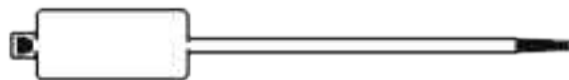

Fig. #1



Fig. #2

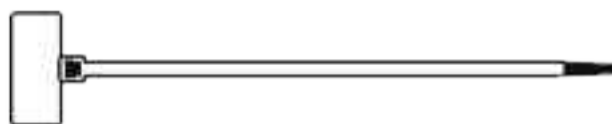

Fig. #3

Std Pkg Catalog Number	Material	Color	Figure	Marking Pad Size Inches	Max Bundle Diameter Inches [mm]	Min Tensile Strength (lbs)	Length Inches [mm]	Width Inches [mm]	Tool	Tool Setting (if applicable)
CT18075FLC	Nylon 6/6	Natural	3	.36 X .81	0.75 [19]	18	4.10 [104]	0.10 [2.5]	CTT50 MK9	2 Std.
CT18075IDC			2	.33 X 1.00	0.75 [19]	18	4.01 [102]	0.10 [2.5]		
CT18200IDC			2	.33 X 1.00	2.09 [53]	18	7.72 [196]	0.10 [2.5]		
CT50175IDC			1	.51 X 1.09	1.75 [44]	50	7.48 [190]	0.18 [4.6]	CTT50 MK9	3 Heavy
CT50250IDC			1	.51 X 1.09	2.95 [75]	50	10.60 [269]	0.19 [4.8]		

UNIRAP™ Push Mount Cable Ties

TYPE CT-PM

Push Mount Cable Ties attach cable bundle to other surface through a pre-drilled hole. One piece design provides extra stability, reliability and consistent performance. Same material and features as the Nylon 6/6 Standard Cable Ties.



Std Pkg Catalog Number	Material	Color	Max Bundle Diameter In. [mm]	Min Tensile Strength (lb)	Length Inches [mm]	Width Inches [mm]	Tool	Tool Setting (if applicable)
CT50175PMC	Nylon 6/6	Natural	1.75	50	8.50 [216]	0.18 [4.6]	CTT50 MK9	2 Heavy
CT50175PMC0		UV Black	[44.5]					

UNIRAP™ Releasable Cable Ties

Type CT-R

Perfect for prototype construction, releasable ties are ideal for temporary installations. Releasable ties are good for applications where service requires adding or subtracting wires from an existing bundle.



Std Pkg Catalog Number	Material	Color	Max Bundle Diameter In. [mm]	Min Tensile Strength (lbs)	Length Inches [mm]	Width Inches [mm]	Tool	Tool Setting (if applicable)
CT50175RC	Nylon 6/6	Natural	2.13	50	8.00	0.19	CTT50 MK9	2 Heavy
CT50175RC0		UV Black	[54.1]		[198]			
CT50137RC		Natural	1.40	6.00				
CT50400RC		UV Black	[35.6]	[151]				
CT50400RC0		Natural	4.00	50	15.20	0.49	MK9	Heavy
CT250200RQ		UV Black	[101.6]		[387]			
CT250200RQ0		Natural	2.52	9.50				
CT250500RQ		UV Black	[64.0]	[241]				
CT250500RQ0		Natural	5.00	250	20.00			
CT250600RQ		UV Black	[127.0]		[509]			
CT250600RQ0		Natural	6.00	24.30				
CT250800RQ		UV Black	[152.4]	[618]				
CT250800RQ0		Natural	8.00	250	28.50			
CT2501000RQ		UV Black	[203.2]		[724]			
CT2501000RQ0	Natural	9.76	32.60					
		[248.0]	[830]					

Wire Management Solutions



Nylon 6/6 Type CT-MH Mounting Hole Cable Ties

UNIRAP™ Mounting Hole Cable Ties

Type CT-MH

Bundling and mounting, one easy installation. Ideal for use where bundle needs to be secured, such as control panels and ceilings. Can be bundled before or after mounting.



Std Pkg Catalog Number	Color	Screw Size	Max Bundle Diameter In. [mm]	Min Tensile Strength (lbs)	Length Inches [mm]	Width Inches [mm]	Tool	Tool Setting (if applicable)	Bulk Catalog Number
CT18075MH4C	Natural	#4	0.75 [19.1]	18	3.93 [100]	0.10 [3.0]	CTT50 MK9	2 Std.	CT18075MH4M
CT30125MH8C	Natural	#8	1.25 [31.8]	30	6.80 [173]	0.14 [4.0]	CTT50 MK9	2 Std.	CT30125MH8M
CT30125MH8M0*	UV Black								—
CT50175MH10C	Natural	#10	1.75 [44.5]	50	8.10 [206]	0.18 [5.0]	CTT50 MK9	3 Heavy	CT50175MH10M
CT50175MH10C0	UV Black								CT50175MH10M0
CT50400MH10C	Natural	#10	4.00 [101.6]	50	15.10 [384]	0.18 [5.0]	CTT50 MK9	3 Heavy	—
CT50400MH10C0	UV Black								CT50400MH10M0
CT120400MH14L	Natural	1/4"	4.00 [101.6]	120	15.70 [399]	0.30 [8.0]	MK9	Heavy	CT120400MH14D
CT120400MH14L0	UV Black								CT120400MH14D0

*Only available in Bulk Package of 1000 pieces.

UNIRAP™ Heat Stabilized Cable Ties

Type CTHS

With similar properties and benefits as nylon 6/6, products manufactured with heat stabilized nylon 6/6 material have a chemical stabilizer added for higher continuous temperature applications. Range up to 225° F.

- Good fatigue resistance
- Resistant to chemicals
- Higher temperature range
- Meets the requirements of UL94V-2 flammability rating

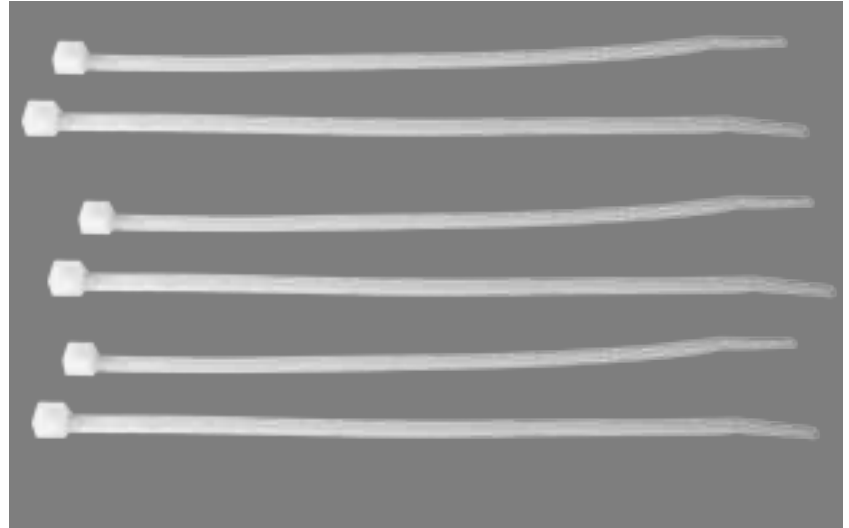

Catalog Number	Material	Color	Max Bundle Diameter In. [mm]	Min Tensile Strength (lbs)	Length Inches [mm]	Width Inches [mm]	Tool	Tool Setting (if applicable)
CTHS18075M	Nylon 6/6 Heat Stabilized	Natural	0.75 [19.1]	18	4.10 [104]	0.10 [2.5]	CTT50 MK9	2 Std.
CTHS40125M			1.25 [31.8]	40	5.75 [146]	0.14 [3.6]		2 Std.
CTHS50300M			3.00 [76.2]	50	11.10 [282]	0.18 [4.6]	CTT50 MK9	3 Heavy
CTHS50400M			4.00 [101.6]	50	14.60 [371]			
CTHS50700M			1.88 [47.8]	50	7.60 [193]			
CTHS120400M			4.00 [101.6]	120	15.00 [381]	0.30 [7.6]	MK9	Heavy

Wire Management Solutions

Nylon 6/6 Type CTB Cable Tie Mounting Bases



UNIRAP™

Type CTB STANDARD CABLE TIE MOUNTING BASES

BURNDY® offers a wide variety of mounting bases suited for many applications. Mounting bases are used in conjunction with cable ties to stabilize and secure wire bundles, both indoors and outdoors. Mounting bases can be secured to a surface using rubber based adhesive, acrylic adhesive, or also can be screw mounted.

The Rubber Adhesive has an operating temperature range from 14°F/-10°C to 140°F/60°C; Acrylic Adhesive has a temperature range of 14°F/-10°C to 176°F/80°C. When using the screw mounting option ONLY (not using any adhesive to secure the base) the product has a temperature range of -40°F/-40°C to 185°F/85°C.

These mounting bases are available to accommodate CT18 through CT50 series cable ties. Insertion of ties can be made from all sides. Each mount may be secured with screws, adhesive backing, or both, for ease of application and stability. For applications where higher temperatures, certain chemicals, or UV radiation are a concern and an adhesive is the preferred method for securing, the acrylic adhesive mounting bases are recommended.



Fig. #1



Fig. #2



Fig. #3

Std Pkg Catalog Number	Mounting Method	Figure #	Color	Min Tensile Strength (lbs)	Max Tie Slot Width [mm]	Width Inches [mm]	Length Inches [mm]	Bulk Catalog Number
CTB075AAF1C	Acrylic Adhesive or #6 or #8 Screw	1	Natural	11	.17 [4.2]	0.75 [19]	0.75 [19]	CTB075AAF1M
CTB075AAF1C0	Acrylic Adhesive or #6 or #8 Screw	1	UV Black	11	.17 [4.2]	0.75 [19]	0.75 [19]	—
CTB075RAF1C	Rubber Adhesive or #6 or #8 Screw	1	Natural	11	.17 [4.2]	0.75 [19]	0.75 [19]	CTB075RAF1M
CTB075RAF1C0	Rubber Adhesive or #6 or #8 Screw	1	UV Black	11	.17 [4.2]	0.75 [19]	0.75 [19]	—
CTB075SF1C	#6 or #8 Screw Only	1	Natural	11	.17 [4.2]	0.75 [19]	0.75 [19]	CTB075SF1M
CTB100AAF2C	Acrylic Adhesive or #10 Screw	2	Natural	36	0.22 [5.5]	1.12 [28.4]	1.12 [28.4]	CTB100AAF2D
CTB100AAF2C0	Acrylic Adhesive or #10 Screw	2	UV Black	36	0.22 [5.5]	1.12 [28.4]	1.12 [28.4]	—
CTB100RAF2L	Rubber Adhesive or #10 Screw	2	Natural	36	0.22 [5.5]	1.12 [28.4]	1.12 [28.4]	CTB100RAF2C CTB100RAF2D
CTB100RAF2C0	Rubber Adhesive or #10 Screw	2	UV Black	36	0.22 [5.5]	1.12 [28.4]	1.12 [28.4]	—
CTB100SF2C	#6 or #8 Screw Only	2	Natural	36	0.22 [5.5]	1.12 [28.4]	1.12 [28.4]	—
CTB150AAF3C	Acrylic Adhesive or #10 Screw	3	Natural	58	0.39 [10]	1.51 [38.4]	1.51 [38.4]	CTB150AAF3D
CTB150RAF3C0	Rubber Adhesive or #10 Screw	3	UV Black	58	0.39 [10]	1.51 [38.4]	1.51 [38.4]	—
CTB150RAF3D	Rubber Adhesive or #10 Screw	3	Natural	58	0.39 [10]	1.51 [38.4]	1.51 [38.4]	—
CTB150SF3C	#10 Screw Only	3	Natural	58	0.39 [10]	1.51 [38.4]	1.51 [38.4]	—
CTB150RA4C	Rubber Adhesive or #10 Screw	3	Natural	58	0.39 [10]	1.51 [38.4]	1.51 [38.4]	—

US: 1-800-346-4175 / International: 1-603-647-5299 / Canada: 1-800-387-6487 / www.burndy.com

UNIRAP™ Cable Hangers

Type CH

Cable hangers provide a contact area range of 1/2" to 3/8" in width. All contact edges have a full radius for product protection, and sizes are clearly marked on each clamp.

Cable hangers are injection molded. Available in white and black nylon 6/6.

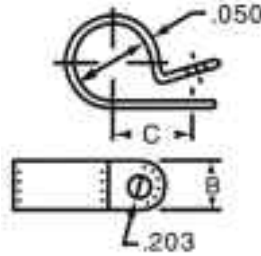

Catalog Number	Mounting Screw	Color	Maximum Bundle Inches [mm]	Dimension B Width Inches [mm]	Dimension C (Mount Hole to Center) Inches [mm]	Bulk Catalog Number
CH2C	#6 - #8 Screw	Natural	0.12 [3.1]	0.38 [9.7]	0.33	CH2M
CH2C0	#6 - #8 Screw	UV Black				—
CH3C	#10 Screw	Natural	0.19 [4.8]		0.43	CH3M
CH3C0	#10 Screw	UV Black				—
CH4C	#10 Screw	Natural	0.25 [6.4]		0.41	CH4M
CH4C0	#10 Screw	UV Black				CH4M0
CH5C	#10 Screw	Natural	0.31 [7.9]		0.50	CH5M
CH5C0	#10 Screw	UV Black				—
CH6C	#10 Screw	Natural	0.38 [9.7]		0.60	CH6M
CH6C0	#10 Screw	UV Black				CH6M0
CH7C	#10 Screw	Natural	0.44 [11.2]		0.57	CH7M
CH7C0	#10 Screw	UV Black				—
CH8C	#10 Screw	Natural	0.50 [12.7]		0.61	CH8M
CH8C0	#10 Screw	UV Black				—
CH9C	#10 Screw	Natural	0.56 [14.2]		0.61	CH9M
CH9C0	#10 Screw	UV Black				—
CH10C	#10 Screw	Natural	0.62 [15.8]	0.61	CH10M	
CH10C0	#10 Screw	UV Black			CH10M0	
CH11C	#10 Screw	Natural	0.62 [15.8]	0.50 [12.7]	0.66	CH11M
CH12C	#10 Screw	Natural	0.75 [19.1]		0.78	CH12M
CH12C0	#10 Screw	UV Black				CH12M0
CH14C	#10 Screw	Natural	0.88 [22.4]		0.85	CH14M
CH14C0	#10 Screw	UV Black				—
CH16C	#10 Screw	Natural	1.00 [25.4]		0.91	CH16M
CH18C	#10 Screw	Natural	1.12 [28.5]		0.97	CH18M
CH24L	#10 Screw	Natural	1.50 [38.1]		1.19	CH24C
CH24C0	#10 Screw	UV Black				—

Wire Management Solutions



Nylon 6/6 Type CT-SSB Stainless Steel Barb Cable Ties

UNIRAP™ Stainless Steel Barb Cable Ties

TYPE CT-SSB

The Stainless Steel Barb cable ties (Type CT-SSB) are nylon 6/6 with self-locking stainless steel barbs featuring an oval low-profile head. There are no sharp edges helping prevent damaged cables. CT-SSB ties have a curved tip for faster initial threading to help speed installation and a no slip tail for easy grip during tensioning. CT-SSB ties are currently available in Natural and UV Black. These cable ties are cULus Listed for Wiring Positioning devices.



Type 21

Features & Benefits

- Nylon 6/6 Standard
- Self-locking stainless steel barb
- Available in UV Black and Natural
- Maximum strength and adjustability for versatility
- Chemically resistant to solvents, oils, grease, and diluted acids
- Rounded edges and bent tail for easy installation
- Safe for air handling spaces
- Plenum rated

Standard Catalog Number	Color	Max Bundle Diameter In. [mm]	Tensile Strength (lbs)	Length Inches [mm]	Width Inches [mm]	Installation Tool	Tool Setting	Bulk Catalog Number
CT18087SSBC	Natural	0.87 [22.0]	18	3.94 [100]	0.12 [3.0]	CTT50	1	CT18087SSBM
CT18087SSBC0	UV Black							CT18087SSBM0
CT18100SSBC	Natural	0.91 [23.1]		4.02 [102]	0.09 [2.0]			CT18100SSBM
CT18100SSBC0	UV Black							CT18100SSBM0
CT18200SSBC	Natural	2.01 [51.1]		7.91 [201]				CT18200SSBM
CT18200SSBC0	UV Black							CT18200SSBM0
CT40137SSBC	Natural	1.38 [35.1]	40	5.91 [150]	0.14 [3.0]	CTT50 MK9	2 Heavy	CT40137SSBM
CT40137SSBC0	UV Black							CT40137SSBM0
CT40200SSBC	Natural	1.97 [50.0]		7.87 [200]	0.15 [4.0]			CT40200SSBD
CT40200SSBC0	UV Black							CT40200SSBD0
CT40300SSBC	Natural	3.15 [80.0]		11.18 [284]	0.14 [3.0]			CT40300SSBD
CT40300SSBC0	UV Black							CT40300SSBD0
CT40400SSBC	Natural	4.09 [103.9]	14.49 [368]		CT40400SSBD			
CT40400SSBC0	UV Black				CT40400SSBD0			
CT50175SSBC	Natural	1.77 [45.0]	50	7.32 [186]	0.19 [5.0]	CTT50 MK9	4 Heavy	CT50175SSBD
CT50175SSBC0	UV Black							CT50175SSBD0
CT50200SSBC	Natural	1.97 [50.0]		7.87 [200]	0.24 [6.0]			CT50200SSBB
CT50200SSBC0	UV Black							CT50200SSBB0
CT50250SSBC	Natural	2.56 [65.0]		9.84 [250]	0.19 [5.0]			CT50250SSBB
CT50250SSBC0	UV Black							CT50250SSBB0
CT50300SSBC	Natural	3.19 [81.0]	11.61 [295]		CT50300SSBB			
CT50300SSBC0	UV Black				CT50300SSBB0			

US: 1-800-346-4175 / International: 1-603-647-5299 / Canada: 1-800-387-6487 / www.burndy.com

UNIRAP™

TYPE CT-SSB Stainless Steel Barb
Cable Ties (Continued)

Standard Catalog Number	Color	Max Bundle Diameter In. [mm]	Tensile Strength (lbs)	Length Inches [mm]	Width Inches [mm]	Installation Tool	Tool Setting	Bulk Catalog Number
CT50400SSBC	Natural	3.94 [100.0]	50	14.33 [364]	0.19 [5.0]	CTT50 MK9	4 Heavy	CT50400SSBB
CT50400SSBC0	UV Black							
CT50425SSBC	Natural	4.21 [106.9]		14.96 [380]				CT50425SSBB
CT50425SSBC0	UV Black							CT50425SSBB0
CT110200SSBC	Natural	2.01 [51.1]	110	8.70 [221]	0.28 [7.0]	MK9	Heavy	CT110200SSBB
CT110200SSBC0	UV Black							CT110200SSBB0
CT110225SSBL	Natural	2.24 [57.0]		9.45 [240]	0.32 [8.0]			CT110225SSBC
CT110225SSBL0	UV Black							CT110225SSBC0
CT110300SSBL	Natural	2.99 [76.0]		11.81 [300]	0.32 [8.0]			CT110300SSBC
CT110300SSBL0	UV Black							
CT110325SSBC	Natural	3.15 [80.0]			0.28 [7.0]			CT110325SSBB
CT110325SSBC0	UV Black							
CT110350SSBL	Natural	3.62 [92.0]		13.78 [350]	0.32 [8.0]			CT110350SSBC
CT110350SSBL0	UV Black							
CT110400SSBL	Natural	4.02 [102.1]		14.88 [378]	0.28 [7.0]			CT110400SSBC
CT110400SSBL0	UV Black							
CT110500SSBL	Natural	5.00 [127.0]		18.11 [460]				CT110500SSBC
CT110500SSBL0	UV Black							
CT110600SSBL	Natural	5.98 [151.9]		21.18 [538]				CT110600SSBC
CT110600SSBL0	UV Black							
CT110800SSBL	Natural	7.99 [203.0]	27.52 [699]	CT110800SSBC				
CT110800SSBL0	UV Black					CT110800SSBC0		
CT120300SSBL	Natural	3.15 [80.0]	11.81 [300]	0.39 [10.0]	CT120300SSBC			
CT120300SSBL0	UV Black					CT120300SSBC0		
CT120350SSBL	Natural	3.82 [97.0]	13.78 [350]		CT120350SSBC			
CT120350SSBL0	UV Black					CT120350SSBC0		
CT120400SSBL	Natural	4.33 [110.0]	15.75 [400]		CT120400SSBC			
CT120400SSBL0	UV Black					CT120400SSBC0		
CT120500SSBL	Natural	4.92 [125.0]	17.72 [450]	CT120500SSBC				
CT120500SSBL0	UV Black				CT120500SSBC0			

Wire Management Solutions



Nylon 6/6 Type CT-UG Cable Ties

UNIRAP™ Cable Ties

TYPE CT-UG

General purpose nylon 6/6 features light weight, high strength and a wide temperature range. It is halogen free so it does not release dangerous gases, such as chlorine, bromine, fluorine or iodine when burned. Nylon 6/6 is hydroscopic, and therefore, absorbs or releases moisture depending on its environment. Thus, the moisture level of the material will affect tensile strength, stiffness and elongation of the product.



Features & Benefits



- Nylon 6/6 Standard
- Available in UV Black and Natural
- One piece injection molded
- Maximum strength and adjustability for versatility
- Chemically resistant to solvents, oils, grease, and diluted acids
- Rounded edges and bent tip for easy installation
- Self-Locking

Std Pkg Catalog Number	Color	Max. Bundle Dia. (in) [mm]	Min. Tensile Strength (lb)	Length inch [mm]	Width inch [mm]	Tool	Tool Setting (if applicable)	Bulk Pkg Catalog Number
Nylon UNIRAP - 18 Lb. Tensile Strength								
CT18075CUG	Natural	0.75 [19.1]	18	3.94 [101]	0.10 [2.5]	CTT50 MK9	2 Std.	CT18025MUG
CT18075C0UG	UV Black			7.95 [202]				CT18025M0UG
—	Natural	2.00 [50.8]		CT18200MUG				
CT18200C0UG	UV Black			CT18200M0UG				
Nylon UNIRAP - 30 Lb. Tensile Strength								
CT30125CUG	Natural	1.25 [31.8]	30	5.90 [150]	0.13 [3.3]	CTT50 MK9	2 Std.	CT30125MUG
CT30125C0UG	UV Black			—				
Nylon UNIRAP - 40 Lb. Tensile Strength								
CT40200CUG	Natural	2.00 [50.8]	40	7.90 [201]	0.15 [3.8]	CTT50 MK9	3 Heavy	CT40200MUG
CT40400C0UG	UV Black	4.00 [101.6]		14.50 [368]				—
Nylon UNIRAP - 50 Lb. Tensile Strength								
CT50175CUG	Natural	1.75 [44.5]	50	7.83 [199]	0.18 [4.6]	CTT50 MK9	3 Heavy	CT50175MUG
CT50175C0UG	UV Black			CT50175M0UG				
CT50300CUG	Natural	3.00 [76.2]		11.34 [288]				CT50300MUG
CT50300C0UG	UV Black			CT50300M0UG				
CT50400CUG	Natural	4.00 [101.6]		14.60 [371]				CT50400MUG
CT50400C0UG	UV Black			—				

UNIRAP™

TYPE CT-UG Cable Ties (Continued)

Std Pkg Catalog Number	Color	Max. Bundle Dia. (in) [mm]	Min. Tensile Strength (lb)	Length inch [mm]	Width inch [mm]	Tool	Tool Setting (if applicable)	Bulk Pkg Catalog Number
Nylon UNIRAP - 120 Lb. Tensile Strength								
CT120200L0UG	UV Black	2.00 [50.8]	120	8.87 [225]	0.28 [7.1]	CTT50 MK9	3 Heavy	—
CT120400LUG	Natural	4.00 [101.6]		14.57 [370]				—
CT120400L0UG	UV Black			17.70 [450]				CT120400C0UG
CT120500CUG	Natural	5.00 [127.0]		29.75 [756]				—
CT120900LUG	Natural	9.00 [228.6]		—				
Nylon UNIRAP - 175 Lb. Tensile Strength								
CT175400Q0UG	UV Black	4.00 [101.6]	175	15.00 [381]	0.35 [8.9]	MK9	Heavy	—
CT175600QUG	Natural	6.00 [152.4]		24.00 [610]				—
CT175600Q0UG	UV Black			32.00 [813]				—
CT175900Q0UG	UV Black	9.00 [228.6]		36.00 [914]				—
CT1751100QUG	Natural	11.00 [279.4]		52.00 [1321]				—
CT1751100Q0UG	UV Black			—				
CT1751400QUG	Natural	14.00 [355.6]		—				
Nylon UNIRAP - 250 Lb. Tensile Strength								
CT250800Q0UG	UV Black	8.00 [203.2]	250	29.00 [737]	0.50 [12.7]	MK9	Heavy	—

Wire Management Solutions



Nylon 6/6 Type CT-MH-UG Mounting Hole Cable Ties

UNIRAP™ Cable Ties

TYPE CT-MH-UG

The CT-MH-UG Cable Ties use the same material and have the same benefits of our CT-UG Cable Ties with the addition of a mounting hole. General purpose nylon 6/6 features light weight, high strength and a wide temperature range. It is halogen free so it does not release dangerous gases, such as chlorine, bromine, fluorine or iodine when burned. Nylon 6/6 is hydroscopic, and therefore, absorbs or releases moisture depending on its environment. Thus, the moisture level of the material will affect tensile strength, stiffness and elongation of the product.



Features & Benefits

- Nylon 6/6 Standard
- Available in UV Black and Natural
- One piece injection molded
- Maximum strength and adjustability for versatility
- Chemically resistant to solvents, oils, grease, and diluted acids
- Rounded edges and bent tip for easy installation
- Self-Locking

Std Pkg Catalog Number	Color	Screw Size	Max Bundle Diameter Inches [mm]	Min Tensile Strength (lbs)	Length Inches [mm]	Width Inches [mm]	Installation Tool	Tool Setting
CT50175MH10CUG	Natural	#10	1.75 [44.5]	50	7.79 [198]	0.18 [4.6]	CTT50 MK9	3 Std.
CT50175MH10C0UG	UV Black			50				
CT50300MH10CUG	Natural		3.00 [76.2]	50	11.73 [298]			
CT50300MH10C0UG	UV Black			50				

UNIRAP™ Mounting Bases

Type CTB-UG

These cable tie mounting bases may be secured with 2 screws and/or a rubber-based adhesive for ease of application and stability. These bases are suited for many applications to stabilize and secure wire buncles, both indoors and outdoors.

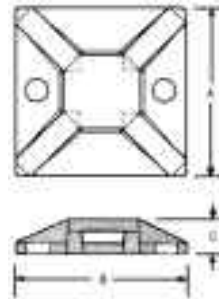

Features & Benefits

- Nylon 6/6 Standard
- Chemically resistant to solvents, oils, grease, and diluted acids

Std Pkg Catalog Number	Mounting Method	Max Tie Slot Width [mm]	Dimension A [mm]	Dimension B [mm]	Dimension C [mm]	Bulk Catalog Number
CTB075RA4CUG	Rubber Adhesive	0.14 [3.56]	0.75 [19.0]	0.75 [19.0]	0.15 [3.8]	—
CTB125RA4CUG	Rubber Adhesive	0.20 [5.08]	1.125 [28.6]	1.125 [28.6]	0.19 [4.8]	CTB125RA4DUG

Wire Management Solutions



Nylon 6/6 Type CTASST Cable Tie Variety Canisters

UNIRAP™ Cable Tie Variety Canisters

TYPE CTASST

There are times when a variety of lengths and color would be helpful. The Type CTASST Cable Tie Variety Canisters are perfect when your needs change.



Catalog Number	Contains						Installation Tool	Tool Setting
	Quantity	Color	Max Bundle Diameter	Tensile Strength (lbs)	Length Inches [mm]	Width Inches [mm]		
CTASST	100	Natural	0.75 [19.1]	18	3.94 [100]	0.10 [2.5]	CTT50 MK9	2 Std.
	100	UV Black						
	200	Natural	1.75 [44.5]	50	7.99 [203]	0.13 [3.2]	CTT50 MK9	3 Std.
	100	UV Black						
	50	Natural	3.00 [76.2]	50	11.02 [280]	0.19 [4.8]	CTT50 MK9	3 Std.
	50	UV Black						
CTASST500N	200	Natural	0.75 [19.1]	18	4.00 [102]	0.10 [2.6]	CTT50 MK9	2 Std.
	100		1.75 [44.5]	30	6.00 [152]	0.13 [3.3]		
	200		50	8.00 [203]	0.18 [4.5]	CTT50 MK9	3 Std.	
CTASST500B	200	UV Black	0.75 [19.1]	18	4.00 [102]	0.10 [2.6]	CTT50 MK9	2 Std.
	100		1.75 [44.5]	30	6.00 [152]	0.13 [3.3]		
	200		50	8.00 [203]	0.18 [4.5]	CTT50 MK9	3 Std.	
CTASST650N	300	Natural	0.75 [19.1]	18	4.00 [102]	0.10 [2.6]	CTT50 MK9	2 Std.
	300		1.75 [44.5]	50	8.00 [203]	0.18 [4.5]	CTT50 MK9	3 Std.
	50		3.00 [76.2]	50	11.00 [203]	0.18 [4.5]		
CTASST650B	300	UV Black	0.75 [44.5]	18	4.00 [102]	0.10 [2.6]	CTT50 MK9	2 Std.
	300		1.75 [44.5]	50	8.00 [203]	0.18 [4.5]	CTT50 MK9	3 Std.
	50		3.00 [76.2]	50	11.00 [203]	0.18 [4.5]		

US: 1-800-346-4175 / International: 1-603-647-5299 / Canada: 1-800-387-6487 / www.burndy.com

VELCRO® Hook and Loop Straps

TYPE TFV-B

Reusable and flexible, hook and loop straps are a unique self-gripping fastening system. These ties are specifically used on fiberoptic applications.

The TFV-V2 flame retardant straps are UL Listed Wire Positioning Devices (ZODZ), UL94-V2 rated for use in air handling spaces in accordance with the NEC Section 300-22(c) and (d). Perfect for plenum areas.

25 straps are conveniently packaged in each polybag.

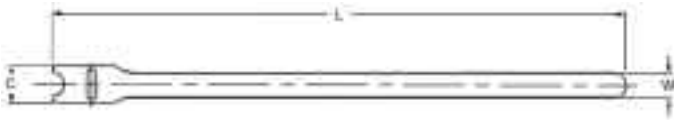

Catalog Number	Product Description	Max Bundle Diameter [mm]	C [mm]	L [mm]	W [mm]	T	Avg. Sheer (PSI)	Avg. Peel (PIW)	Pkg. Qty.
TFV3B12V2	VELCRO® hook and loop strap, 3/4" x 12", Black, 25pk	3.00 [76.2]	0.75 [19.1]	12.00 [305]	0.50 [.27]	0.09	29	0.60	1 package = 25 ties
TFV3B18V2	VELCRO® hook and loop strap, 3/4" x 18", Black, 25pk	5.00 [127.0]		18.00 [457]			29	0.60	
TFV3B6V2	VELCRO® hook and loop strap, 3/4" x 6", Black, 25pk	1.00 [25.4]		6.00 [152]			29	0.60	
TFV3BLU12	VELCRO® hook and loop strap, 3/4" x 12", Royal Blue, 25pk	3.00 [76.2]		12.00 [305]			23	0.50	
TFV3BLU18	VELCRO® hook and loop strap, 3/4" x 18", Royal Blue, 25pk	5.00 [127.0]		18.00 [457]			23	0.50	

Wire Management Solutions



Grade 304 Stainless Steel Uncoated Type CTSS Cable Ties

UNIRAP™ Grade 304 Stainless Steel Uncoated

Type CTSS

BURNDY® 304 Stainless Steel ties are designed to secure hoses, cables, poles, pipes, and more when harsh environmental conditions may adversely affect the bundling application.

Used where corrosion, vibration, weathering, radiation, and temperature extremes are a concern. BURNDY® Stainless Steel ties can be used in virtually any indoor, outdoor, and underground application.

These Stainless Steel ties are made from Grade 304 Stainless Steel. Designed with a low profile clamping bearing head with fully adjustable strap accommodating many bundle diameters.



Features & Benefits

- Meet the requirements of ABS
- 304 Grade Stainless Steel
- Suitable for general purpose applications
- Smooth, rounded edges help ensure safe, efficient handling
- Available in a variety of lengths and widths
- Self-locking steel ball design speeds installation and locks into place at any length
- Provides a strong durable method of cable bundling
- Flame retardant and non-toxic for applications where safety from fire is critical

Catalog Number	Material	Max Bundle Diameter In. [mm]	Min Tensile Strength Lbs.	Length Inches [mm]	Width Inches [mm]	Installation Tool
CTSS225100304C	304 SS	0.99 [25.2]	225	3.94 [100]	0.18 [4.6]	CTSS900
CTSS225200304C		1.97 [50.0]		7.87 [200]		
CTSS225300304C		3.00 [76.2]		11.81 [300]		
CTSS225400304C		4.02 [102.1]		15.75 [400]		
CTSS225500304C		5.04 [128.0]		19.68 [500]		
CTSS225600304C		6.07 [154.2]		23.62 [600]		
CTSS500200304L	304 SS	1.97 [50.0]	500	7.87 [200]	0.31 [7.9]	CTSS900
CTSS500300304L		3.00 [76.2]		11.81 [300]		
CTSS500400304L		4.02 [102.1]		15.75 [400]		
CTSS500500304L		5.04 [128.0]		19.68 [500]		
CTSS500600304L		6.07 [154.2]		23.62 [600]		
CTSS500700304L		7.09 [180.1]		27.56 [700]		
CTSS500750304L		7.60 [193.0]		31.50 [800]		
CTSS500800304L		8.12 [206.3]		39.37 [1000]		
CTSS700200304L	304 SS	1.97 [50.0]	700	7.87 [200]	0.50 [12.7]	CTSS900
CTSS700300304L		3.00 [76.2]		11.81 [300]		
CTSS700400304L		4.02 [102.1]		15.75 [400]		
CTSS700500304L		5.04 [128.0]		19.68 [500]		
CTSS700600304L		6.07 [154.2]		23.62 [600]		
CTSS700700304L		7.09 [180.1]		27.56 [700]		
CTSS700800304L		8.12 [206.3]		39.37 [1000]		
CTSS900200304L	304 SS	1.97 [50.0]	920	7.87 [200]	0.62 [15.9]	CTSS900
CTSS900300304L		3.00 [76.2]		11.81 [300]		
CTSS900400304L		4.02 [102.1]		15.75 [400]		
CTSS900500304L		5.04 [128.0]		19.68 [500]		
CTSS900600304L		6.07 [154.2]		23.62 [600]		
CTSS900700304L		7.09 [180.1]		27.56 [700]		
CTSS900800304L		8.12 [206.3]		39.37 [1000]		

US: 1-800-346-4175 / International: 1-603-647-5299 / Canada: 1-800-387-6487 / www.burndy.com

UNIRAP™ Grade 304 Stainless Steel Partially Coated

TYPE CTSS-PC

BURNDY® Stainless Steel Partially Coated cable ties (Type CTSS-PC) are designed with a steel ball self-locking mechanism. There are no sharp edges which prevents damaged cables. These ties have smooth, rounded edges and polyester coating which add to the safety of the installer. High tensile strength along with the shield of the polyester coating offer a reliable and lasting bundling solution. CTSS-PC ties are currently available in black. BURNDY® Stainless Steel Partially Coated Cable Ties can be used in any indoor, outdoor, or underground application.



Features & Benefits

- Meet the requirements of ABS
- 304 Grade Stainless Steel
- Available in Black only
- Suitable for general purpose applications
- Smooth, rounded edges along with the polyester coating add to the safety of the installer
- Self-locking steel ball design speeds installation and locks into place at any length
- Provides a strong, durable method of cable bundling
- Available in a wide range of lengths and widths
- Halogen free low smoke polyester coating

Catalog Number	Material	Max Bundle Diameter In. [mm]	Min Tensile Strength Lbs.	Length Inches [mm]	Width Inches [mm]	Installation Tool
CTSS250200PC304L	304 SS	1.97 [50.0]	270	7.87 [200]	0.31 [7.9]	CTTSS900
CTSS250300PC304L		3.00 [76.2]		11.81 [300]		
CTSS250400PC304L		4.02 [102.1]		15.75 [400]		
CTSS250500PC304L		5.04 [128.0]		19.68 [500]		
CTSS250600PC304L		6.06 [153.9]		23.62 [600]		
CTSS250700PC304L		7.09 [180.1]		27.56 [700]		
CTSS250800PC304L		8.11 [206.0]		39.37 [1000]		
CTSS450200PC304L	304 SS	1.97 [50.0]	450	7.87 [200]	0.50 [12.7]	CTTSS900
CTSS450300PC304L		3.00 [76.2]		11.81 [300]		
CTSS450400PC304L		4.02 [102.1]		15.75 [400]		
CTSS450500PC304L		5.04 [128.0]		19.68 [500]		
CTSS450600PC304L		6.06 [153.9]		23.62 [600]		
CTSS450700PC304L		7.09 [180.1]		27.56 [700]		
CTSS450800PC304L		8.11 [206.0]		39.37 [1000]		
CTSS675200PC304Q	304 SS	1.97 [50.0]	675	7.87 [200]	0.62 [15.9]	CTTSS900
CTSS675300PC304Q		3.00 [76.2]		11.81 [300]		
CTSS675400PC304Q		4.02 [102.1]		15.75 [400]		
CTSS675500PC304Q		5.04 [128.0]		19.68 [500]		
CTSS675600PC304Q		6.06 [153.9]		23.62 [600]		
CTSS675700PC304Q		7.09 [180.1]		27.56 [700]		
CTSS675800PC304Q		8.11 [206.0]		39.37 [1000]		

Wire Management Solutions



Grade 304 Stainless Steel Fully Coated Type CTSS-FC Cable Ties

UNIRAP™ Grade 304 Stainless Steel Fully Coated

Type CTSS-FC

The Stainless Steel Fully Coated cable ties (Type CTSS-FC) are designed with a steel ball type locking mechanism. There are no sharp edges which prevents damaged cables. These ties have smooth, rounded edges and polyester coating which add to the safety of the installer. High tensile strength along with the shield of the polyester coating offers a reliable and lasting bundling solution. Type CTSS-FC ties are currently available only in black. BURNDY® stainless steel fully coated cable ties can be used in any indoor, outdoor, or underground applicaiton.



Features & Benefits

- Meet the requirements of ABS
- 304 Grade Stainless Steel
- Available in Black only
- Suitable for general purpose applications
- Smooth, rounded edges along with the polyester coating add to the safety of the installer
- Self-locking steel ball design speeds installation and locks into place at any length
- Provides a strong, durable method of cable bundling
- Available in a wide range of lengths and widths
- Halogen free low smoke polyester coating

Catalog Number	Material	Max Bundle Diameter In. [mm]	Min Tensile Strength Lbs.	Length Inches [mm]	Width Inches [mm]	Installation Tool
CTSS100100FC304C	304 SS	0.98 [24.9]	160	3.94 [100]	0.18 [4.6]	CTSS900
CTSS100200FC304C		1.97 [50.0]		7.87 [200]		
CTSS100300FC304C		3.00 [76.2]		11.81 [300]		
CTSS100400FC304C		4.02 [102.1]		15.75 [400]		
CTSS100500FC304C		5.04 [128.0]		19.68 [500]		
CTSS100600FC304C		6.07 [154.2]		23.62 [600]		
CTSS100800FC304C		8.11 [206.0]		31.50 [800]		
CTSS250200FC304L	304 SS	1.97 [50.0]	250	7.87 [200]	0.31 [7.9]	CTSS900
CTSS250300FC304L		3.00 [76.2]		11.81 [300]		
CTSS250400FC304L		4.02 [102.1]		15.75 [400]		
CTSS250500FC304L		5.04 [128.0]		19.68 [500]		
CTSS250600FC304L		6.06 [153.9]		23.62 [600]		
CTSS250700FC304L		7.09 [180.1]		27.56 [700]		
CTSS250800FC304L		8.11 [206.0]		39.37 [1000]		
CTSS450200FC304L	304 SS	1.97 [50.0]	450	7.87 [200]	0.50 [12.7]	CTSS900
CTSS450300FC304L		3.00 [76.2]		11.81 [300]		
CTSS450400FC304L		4.02 [102.1]		15.75 [400]		
CTSS450500FC304L		5.04 [128.0]		19.68 [500]		
CTSS450600FC304L		6.06 [153.9]		23.62 [600]		
CTSS450700FC304L		7.09 [180.1]		27.56 [700]		
CTSS450800FC304L		8.11 [206.0]		39.37 [1000]		
CTSS675200FC304Q	304 SS	1.97 [50.0]	675	7.87 [200]	0.62 [15.9]	CTSS900
CTSS675300FC304Q		3.00 [76.2]		11.81 [300]		
CTSS675400FC304Q		4.02 [102.1]		15.75 [400]		
CTSS675500FC304Q		5.04 [128.0]		19.68 [500]		
CTSS675600FC304Q		6.06 [153.9]		23.62 [600]		
CTSS675700FC304Q		7.09 [180.1]		27.56 [700]		
CTSS675800FC304Q		8.11 [206.0]		39.37 [1000]		

US: 1-800-346-4175 / International: 1-603-647-5299 / Canada: 1-800-387-6487 / www.burndy.com

UNIRAP™ Grade 316 Stainless Steel Uncoated

TYPE CTSS

BURNDY® Stainless Steel ties (Type CTSS) are designed to secure hoses, cables, poles, pipes, and more when harsh environmental conditions may adversely affect the bundling application. Used where corrosion, vibration, weathering, radiation, and temperature extremes are a concern, BURNDY® Stainless Steel ties can be used in virtually any indoor, outdoor, and underground application.

BURNDY® Stainless Steel ties are made from Grade 316 Stainless Steel. This tie is designed with a low profile clamping bearing head with fully adjustable strap accommodating many bundle diameters.



Features & Benefits

- Meet the requirements of ABS
- 316 Grade Stainless Steel
- Suitable for rigorous corrosive conditions
- Smooth, rounded edges help ensure safe efficient handling
- Available in a wide range of lengths and widths
- Self-locking steel ball design speeds installation and locks into place at any length
- Provides a strong, durable method of cable bundling
- Flame retardant and non-toxic for applications where safety from fire is critical

Catalog Number	Material	Max Bundle Diameter In. [mm]	Min Tensile Strength Lbs.	Length Inches [mm]	Width Inches [mm]	Installation Tool
CTSS225100316C	316 SS	0.99 [24.9]	225	3.94 [100]	0.18 [4.6]	CTTSS900
CTSS225200316C		1.97 [50.0]		7.87 [200]		
CTSS225300316C		3.00 [76.2]		11.81 [300]		
CTSS225400316C		4.02 [102.1]		15.75 [400]		
CTSS225500316C		5.04 [128.0]		19.68 [500]		
CTSS225600316C		6.07 [154.2]		23.62 [600]		
CTSS500200316C	316 SS	1.97 [50.0]	500	7.87 [200]	0.31 [7.9]	CTTSS900
CTSS500300316C		3.00 [76.2]		11.81 [300]		
CTSS500400316L		4.02 [102.1]		15.75 [400]		
CTSS500500316L		5.04 [128.0]		19.68 [500]		
CTSS500600316L		6.07 [154.2]		23.62 [600]		
CTSS500700316L		7.09 [180.1]		27.56 [700]		
CTSS500750316L		7.60 [193.0]		31.50 [800]		
CTSS500800316L		8.12 [206.3]		39.37 [1000]		
CTSS700200316L	316 SS	1.97 [50.0]	700	7.87 [200]	0.50 [12.7]	CTTSS900
CTSS700300316L		3.00 [76.2]		11.81 [300]		
CTSS700400316L		4.02 [102.1]		15.75 [400]		
CTSS700500316L		5.04 [128.0]		19.68 [500]		
CTSS700600316L		6.07 [154.2]		23.62 [600]		
CTSS700700316L		7.09 [180.1]		27.56 [700]		
CTSS700800316L	8.12 [206.3]	39.37 [1000]				
CTSS900200316L	316 SS	1.97 [50.0]	920	7.87 [200]	0.62 [15.9]	CTTSS900
CTSS900300316L		3.00 [76.2]		11.81 [300]		
CTSS900400316L		4.02 [102.1]		15.75 [400]		
CTSS900500316L		5.04 [128.0]		19.68 [500]		
CTSS900600316L		6.07 [154.2]		23.62 [600]		
CTSS900700316L		7.09 [180.1]		27.56 [700]		
CTSS900800316L		8.12 [206.3]		39.37 [1000]		

Wire Management Solutions



Grade 316 Stainless Steel Partially Coated Type CTSS-PC Cable Ties

UNIRAP™ Grade 316 Stainless Steel Partially Coated

Type CTSS-PC

The Stainless Steel Partially Coated cable ties (Type CTSS-PC) are designed with a steel ball type locking mechanism. There are no sharp edges which prevents damaged cables. These ties have smooth, rounded edges and polyester coating which add to the safety of the installer. High tensile strength along with the shield of the polyester coating offers a reliable and lasting bundling solution. Type CTSS-PC ties are currently available only in black. BURNDY® stainless steel partially coated cable ties can be used in any indoor, outdoor, or underground applicaiton.



Features & Benefits

- Meet the requirements of ABS
- 316 Grade Stainless Steel
- Available in Black only
- Suitable for rigorous corrosive conditions
- Smooth, rounded edges along with the polyester coating add to the safety of the installer
- Self-locking steel ball design speeds installation and locks into place at any length
- Provides a strong, durable method of cable bundling
- Available in a wide range of lengths and widths
- Halogen free low smoke polyester coating

Catalog Number	Material	Max Bundle Diameter In. [mm]	Min Tensile Strength Lbs.	Length Inches [mm]	Width Inches [mm]	Installation Tool
CTSS250200PC316L	316 SS	1.97 [50.0]	270	7.87 [200]	0.31 [7.9]	CTTSS900
CTSS250300PC316L		3.00 [76.2]		11.81 [300]		
CTSS250400PC316L		4.02 [102.1]		15.75 [400]		
CTSS250500PC316L		5.04 [128.0]		19.68 [500]		
CTSS250600PC316L		6.06 [153.9]		23.62 [600]		
CTSS250700PC316L		7.09 [180.1]		27.56 [700]		
CTSS250800PC316L		8.11 [206.0]		39.37 [1000]		
CTSS450200PC316L	316 SS	1.97 [50.0]	450	7.87 [200]	0.50 [12.7]	CTTSS900
CTSS450300PC316L		3.00 [76.2]		11.81 [300]		
CTSS450400PC316L		4.02 [102.1]		15.75 [400]		
CTSS450500PC316L		5.04 [128.0]		19.68 [500]		
CTSS450600PC316L		6.06 [153.9]		23.62 [600]		
CTSS450700PC316L		7.09 [180.1]		27.56 [700]		
CTSS450800PC316L		8.11 [206.0]		39.37 [1000]		
CTSS675200PC316Q	316 SS	1.97 [50.0]	675	7.87 [200]	0.62 [15.9]	CTTSS900
CTSS675300PC316Q		3.00 [76.2]		11.81 [300]		
CTSS675400PC316Q		4.02 [102.1]		15.75 [400]		
CTSS675500PC316Q		5.04 [128.0]		19.68 [500]		
CTSS675600PC316Q		6.06 [153.9]		23.62 [600]		
CTSS675700PC316Q		7.09 [180.1]		27.56 [700]		
CTSS675800PC316Q		8.11 [206.0]		39.37 [1000]		

UNIRAP™ Grade 316 Stainless Steel Fully Coated

TYPE CTSS-FC

BURNDY® Stainless Steel Fully Coated cable ties (Type CTSS-FC) are designed with a steel ball self-locking mechanism. There are no sharp edges which prevents damaged cables. These ties have smooth, rounded edges and polyester coating which add to the safety of the installer. High tensile strength along with the shield of the polyester coating offer a reliable and lasting bundling solution. Type CTSS-FC ties are currently available in black only. BURNDY® Stainless Steel fully coated cable ties can be used in any indoor, outdoor, or underground application.



Features & Benefits

- Meet the requirements of ABS
- 316 Grade Stainless Steel
- Available in black only
- Suitable for rigorous corrosive conditions
- Smooth, rounded edges help ensure safe efficient handling
- Available in a wide range of lengths and widths
- Self-locking steel ball design speeds installation and locks into place at any length
- Provides a strong, durable method of cable bundling
- Flame retardant and non-toxic for applications where safety from fire is critical

Catalog Number	Material	Max Bundle Diameter In. [mm]	Min Tensile Strength Lbs.	Length Inches	Width Inches	Installation Tool
CTSS100100FC316C	316 SS	0.98 [24.9]	160	3.94 [100]	0.18 [4.6]	CTTSS900
CTSS100200FC316C		1.97 [50.0]		7.87 [200]		
CTSS100300FC316C		3.00 [76.2]		11.81 [300]		
CTSS100400FC316C		4.02 [102.1]		15.75 [400]		
CTSS100500FC316C		5.04 [128.0]		19.68 [500]		
CTSS100600FC316C		6.07 [154.2]		23.60 [600]		
CTSS100800FC316C		8.11 [206.0]		31.50 [800]		
CTSS250200FC316L	316 SS	1.97 [50.0]	250	7.87 [200]	0.31 [7.9]	CTTSS900
CTSS250300FC316L		3.00 [76.2]		11.81 [300]		
CTSS250400FC316L		4.02 [102.1]		15.75 [400]		
CTSS250500FC316L		5.04 [128.0]		19.68 [500]		
CTSS250600FC316L		6.06 [153.9]		23.62 [600]		
CTSS250700FC316L		7.09 [180.1]		27.56 [700]		
CTSS250800FC316L		8.11 [206.0]		39.37 [1000]		
CTSS450200FC316L	316 SS	1.97 [50.0]	450	7.87 [200]	0.50 [12.7]	CTTSS900
CTSS450300FC316L		3.00 [76.2]		11.81 [300]		
CTSS450400FC316L		4.02 [102.1]		15.75 [400]		
CTSS450500FC316L		5.04 [128.0]		19.68 [500]		
CTSS450600FC316L		6.06 [153.9]		23.62 [600]		
CTSS450700FC316L		7.09 [180.1]		27.56 [700]		
CTSS450800FC316L		8.11 [206.0]		39.37 [1000]		
CTSS675200FC316Q	316 SS	1.97 [50.0]	675	7.87 [200]	0.62 [15.9]	CTTSS900
CTSS675300FC316Q		3.00 [76.2]		11.81 [300]		
CTSS675400FC316Q		4.02 [102.1]		15.75 [400]		
CTSS675500FC316Q		5.04 [128.0]		19.68 [500]		
CTSS675600FC316Q		6.06 [153.9]		23.62 [600]		
CTSS675700FC316Q		7.09 [180.1]		27.56 [700]		
CTSS675800FC316Q		8.11 [206.0]		39.37 [1000]		

Wire Management Solutions



WILEY Bundle Strap - Wire Management Bundle Strap

WILEY Bundle Straps

The Wiley Bundle Strap is made of corrosion resistant 304 stainless steel, which makes them a durable, long lasting and reliable solution for all environments. The vinyl jacket covering the 304 stainless steel wire is designed to protect cable insulation from damage. The Wiley Bundle Strap is easy to install and can be crimped in the field with electrician linesman pliers or standard wire cutters. The crimp sleeve's retention feature allows for a quick, effortless, secure installation. Custom lengths available upon request.

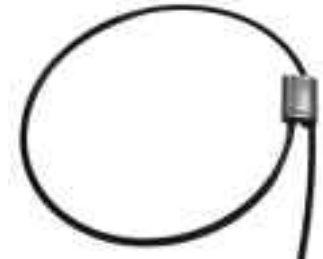

Features & Benefits

- UL 62275 Listed
- High quality, long-lasting, labor saving, wire management solution
- UV guarded vinyl jacketed 304 stainless steel wire with 304 stainless steel crimp
- Vinyl jacket designed to protect cable insulation from damage
- 304 stainless steel crimp sleeve allows for quick and easy installation
- Can be crimped in the field with electrician linesman pliers or standard wire cutters
- Retention feature allows for a quick, effortless, secure installation
- Lasts for the lifetime of the PV system
- RoHS compliant
- Custom lengths available upon request

Installing the ACC-FBC with WBS or UNIRAP™ cable tie

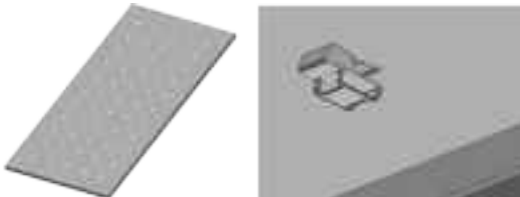

The ACC-FBC mounting base slides onto the module flange



Route a WBS or UNIRAP™ through the ACC-FBC mounting base



Secure desired cables by tightening the WBS or UNIRAP™

Wiley Bundle Straps

304 Stainless Steel wire covered with vinyl jacket helps protect cable insulation from damage

Catalog Number	Length inch [mm]	Diameter inch [mm]	Max. Tensile Strength	Max. Bundle Diameter inch [mm]	Material
WBS8V	8.00 [203.20]	0.06 [1.50]	100 lbs.	2.30 [58.40]	Vinyl Insulated 304 Stainless Steel Wire
WBS10V	10.00 [254.00]	0.06 [1.50]	100 lbs.	2.92 [74.00]	
WBS12V	12.00 [304.80]	0.06 [1.50]	100 lbs.	3.88 [98.50]	
WBS14V	14.00 [356.00]	0.06 [1.50]	100 lbs.	4.20 [106.70]	
WBS20V	20.00 [508.00]	0.06 [1.50]	100 lbs.	6.36 [161.50]	
WBS24V	24.00 [609.60]	0.06 [1.50]	100 lbs.	7.00 [178.00]	
WBS30V	30.00 [762.00]	0.06 [1.50]	100 lbs.	8.75 [222.00]	
WBS36V	36.00 [914.40]	0.06 [1.50]	100 lbs.	11.00 [279.40]	



ACC-FBC shown with WBS8V



Mounting Platform for WBS Bundle Straps or UNIRAP™ Cable Ties

304 Stainless Steel wire covered with vinyl jacket helps protect cable insulation from damage

Catalog Number	Length inch [mm]	Width inch [mm]	Height inch [mm]	Max. Cable Tie Width inch [mm]	Frame Thickness
ACC-FBC	0.55 [14.00]	0.48 [12.20]	0.27 [7.00]	0.31 [8.00]	1.3mm to 2.5mm

US: 1-800-346-4175 / International: 1-603-647-5299 / Canada: 1-800-387-6487 / www.burndy.com

WILEY Insulated Wire Management



WIS8-2 shown

Wiley Insulated Straps				
<i>Vinyl insulated steel straps protect cables from vibration and insulation damage</i>				
Catalog Number	Length inch [mm]	Diameter inch [mm]	Max. Bundle Diameter inch [mm]	Material
WIS8-2	7.87 [200.0]	0.24 [6.0]	2.00 [50.8]	Vinyl coated steel
WIS12-3	11.80 [300.0]	0.24 [6.0]	3.00 [76.2]	

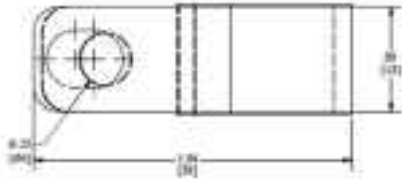

WIPC14-12 shown

Wiley Insulated P-Clips				
<i>Vinyl insulated steel p-clips protect cables from vibration and insulation damage</i>				
Catalog Number	Length inch [mm]	Width inch [mm]	Max. Bundle Diameter inch [mm]	Material
WIPC14-14	1.54 [39.0]	0.24 [6.0]	0.25 [6.4]	Vinyl coated steel
WIPC14-12	1.54 [39.0]	0.24 [6.0]	0.50 [13.0]	
WIPC14-34	1.54 [39.0]	0.24 [6.0]	0.75 [19.0]	
WIPC14-1	1.54 [39.0]	0.24 [6.0]	1.00 [25.4]	
WIPC14-112	1.54 [39.0]	0.24 [6.0]	1.25 [31.8]	

Wiley Cable Clips

Engineered for high-quality wire management solutions, Wiley Cable Clips simplify wire management and create a cleaner aesthetic to solar PV arrays. The clips are made of corrosion resistant stainless steel, which makes for a durable, long lasting and reliable solution in all environments and are designed with coined edges to prevent damage to cable insulation. The designs are to install and remove with a flat head screwdriver and can be reused. The clips can be used in a wide variety of mounting configurations (including 90 degree) for module and rail applications. Custom designs are available upon request.



Features & Benefits

- UL 1565 Listed
- Accommodates a broad range of cable combinations and sizes (e.g., USE-2, PV, AC module and micro inverter cables)
- Compatible on modules with a flange thickness range of 1.3 to 2.5mm
- No tools required for installation
- Multiuse capabilities
- Coined edges to prevent damage to cable insulation
- Reliability for use throughout the lifetime of the PV system



ACC-FLD shown

Module Clips						
<i>304 Stainless Steel cable clips that install on the module frame</i>						
Line Image	Catalog Number	Length inch [mm]	Width inch [mm]	Height inch [mm]	Qty of Wires Held	Wire Diameter inch [mm]
	ACC	0.66 [16.85]	0.39 [10.00]	0.39 [10.00]	1 to 2 USE-2 wires or 1 PV wire	Max. 0.29 [7.50]
	ACC-PV	0.72 [18.42]	0.39 [10.00]	0.47 [12.60]	1 to 2 PV wires	Max. 0.29 [7.50]
	ACC-FLD	0.75 [19.00]	0.39 [10.00]	0.50 [12.70]	1 to 2 PV wires	Max. 0.29 [7.50]
	ACC-FPV	0.92 [23.33]	0.49 [12.50]	0.56 [14.22]	1 to 2 PV wires	Max. 0.31 [8.00]

US: 1-800-346-4175 / International: 1-603-647-5299 / Canada: 1-800-387-6487 / www.burndy.com

Wiley Cable Clips (Continued)

90 Degree Module Clips						
<i>304 Stainless Steel cable clips that install parallel or perpendicular on the module frame</i>						
Line Image	Catalog Number	Length inch [mm]	Width inch [mm]	Height inch [mm]	Qty of Wires Held	Wire Diameter inch [mm]
	ACC-F90-1	0.81 [20.58]	0.51 [13.08]	0.56 [14.22]	1 to 2 USE-2 wires or 1 to 2 PV wire	Max. 0.29 [7.50]
	ACC-F2-90	1.16 [29.49]	0.41 [10.51]	0.59 [15.10]	1 to 2 Micro Inverter Trunk or AC cables	1 wire: Max. 0.55 [14.00] 2 wires Max. 0.43 [11.00]
	ACC-F4-90	1.37 [34.72]	0.41 [10.51]	0.56 [14.31]	1 to 4 PV wires	Max. 0.29 [7.50]
	ACC-F1-270	0.92 [23.50]	0.39 [10.00]	0.77 [19.55]	2 PV wire or 1 Micro Inverter Trunk	Max. 0.55 [14.00]
Rail Clips						
<i>304 Stainless Steel cable clips that install on the rail or in the channel</i>						
Line Image	Catalog Number	Length inch [mm]	Width inch [mm]	Height inch [mm]	Qty of Wires Held	Wire Diameter inch [mm]
	ACC-R2	1.47 [37.41]	0.39 [10.00]	0.81 [20.50]	1 to 2 Micro Inverter Trunk or AC cables	1 wire: Max. 0.55 [14.00] 2 wires Max. 0.43 [11.00]
	ACC-R2-E	1.18 [30.10]	0.49 [12.50]	0.66 [16.81]	1 to 2 Micro Inverter Trunk or AC cables	1 wire: Max. 0.55 [14.00] 2 wires Max. 0.43 [11.00]
	ACC-R4	1.55 [39.46]	0.39 [10.00]	0.63 [16.05]	1 to 4 PV wires	Max. 0.29 [7.50]
	ACC-RBC15	0.91 [23.00]	0.65 [16.50]	0.47 [12.00]	2 Micro Inverter Trunk or up to 4 PV wires	Max. 0.55 [14.00]



ACC-F90-1 shown in both orientations



ACC-F1-270



ACC-R2-E shown



ACC-RBC15 shown

Wire Management Solutions



Cable Tie Tools Types MK, TWT and CTT

Cable Tie Tools

Types MK, CTT, and CTTSS

Ergonomics and the prevention of repetitive motion injuries, coupled with the need to continually improve assembly efficiencies and procedures, are a major concern with most cable tie users. BURNDY® cable tie tools effectively address both issues. BURNDY® has world class cable tie tools to complement its line of quality cable ties. These tools are truly state-of-the-art both in design and performance.

BURNDY® tools make it easier for operators to install cable ties, while maintaining correct tension and flush cut-off. Worker safety is further enhanced as the tools can eliminate the sharp edges of a cut-off cable tie.



A



B



C

Catalog Number	Ref. Figure	Description	For Use On
MK9	A	Adjustable Tensioning Tool for Width 0.19" to 0.35"	Nylon 18-250 lbs
CTT50	B	Adjustable Tensioning Tool for Width 0.10" to 0.19"	Nylon up to 50 lbs
CTTSS900	C	Stainless Steel Tie Tool	SS Ties up to 900 lbs

ALPHA-NUMERIC INDEX BY CATALOG NUMBER

Catalog Number	Page Number
ACC	32
ACC-F1-270	33
ACC-F2-90	33
ACC-F4-90	33
ACC-F90-1	33
ACC-FBC	30
ACC-FLD	32
ACC-FPV	32
ACC-PV	32
ACC-R2	33
ACC-R2-E	33
ACC-R4	33
ACC-RBC15	33
CH10C	15
CH10C0	15
CH10M	15
CH10M0	15
CH11C	15
CH11M	15
CH12C	15
CH12C0	15
CH12M	15
CH12M0	15
CH14C	15
CH14C0	15
CH14M	15
CH16C	15
CH16M	15
CH18C	15
CH18M	15
CH24C	15
CH24C0	15
CH24L	15
CH2C	15
CH2C0	15
CH2M	15
CH3C	15
CH3C0	15
CH3M	15
CH4C	15
CH4C0	15

Catalog Number	Page Number
CH4M	15
CH4M0	15
CH5C	15
CH5C0	15
CH5M	15
CH6C	15
CH6C0	15
CH6M	15
CH6M0	15
CH7C	15
CH7C0	15
CH7M	15
CH8C	15
CH8C0	15
CH8M	15
CH9C	15
CH9C0	15
CH9M	15
CT110200SSBB	17
CT110200SSBB0	17
CT110200SSBC	17
CT110200SSBC0	17
CT110225SSBC	17
CT110225SSBC0	17
CT110225SSBL	17
CT110225SSBL0	17
CT110300SSBC	17
CT110300SSBC0	17
CT110300SSBL	17
CT110300SSBL0	17
CT110325SSBB	17
CT110325SSBB0	17
CT110325SSBC	17
CT110325SSBC0	17
CT110350SSBC	17
CT110350SSBC0	17
CT110350SSBL	17
CT110350SSBL0	17
CT110400SSBC	17
CT110400SSBC0	17
CT110400SSBL	17

Catalog Number	Page Number
CT110400SSBL0	17
CT110500SSBC	17
CT110500SSBC0	17
CT110500SSBL	17
CT110500SSBL0	17
CT110600SSBC	17
CT110600SSBC0	17
CT110600SSBL	17
CT110600SSBL0	17
CT110800SSBC	17
CT110800SSBC0	17
CT110800SSBL	17
CT110800SSBL0	17
CT120200D	8
CT120200D0	8
CT120200L	8
CT120200L0	8
CT120200LOUG	19
CT120300D	8
CT120300D0	8
CT120300L	8
CT120300L0	8
CT120300SSBC	17
CT120300SSBC0	17
CT120300SSBL	17
CT120300SSBL0	17
CT120350SSBC	17
CT120350SSBC0	17
CT120350SSBL	17
CT120350SSBL0	17
CT120400C0UG	19
CT120400D	8
CT120400D0	8
CT120400D00	8
CT120400L	8
CT120400L0	8
CT120400L00	8
CT120400LOUG	19
CT120400LUG	19
CT120400M0	8
CT120400MH14D	12

ALPHA-NUMERIC INDEX BY CATALOG NUMBER (continued)

Catalog Number	Page Number
CT120400MH14D0	12
CT120400MH14L	12
CT120400MH14L0	12
CT120400SSBC	17
CT120400SSBC0	17
CT120400SSBL	17
CT120400SSBL0	17
CT120500CUG	19
CT120500SSBC	17
CT120500SSBC0	17
CT120500SSBL	17
CT120500SSBL0	17
CT120800L	8
CT120800L00	8
CT120900LUG	19
CT1751100Q	9
CT1751100Q0	9
CT1751100Q0UG	19
CT1751100QUG	19
CT1751400Q0	9
CT1751400QUG	19
CT1751500Q	9
CT175400Q0UG	19
CT175500Q	9
CT175500Q0	9
CT175600Q	9
CT175600Q0	9
CT175600Q0UG	19
CT175600QUG	19
CT175800Q0	9
CT175900Q	9
CT175900Q00	9
CT175900Q0UG	19
CT18025M0UG	18
CT18025MUG	18
CT18075C	6
CT18075C0	6
CT18075C00	6
CT18075C0UG	18
CT18075CUG	18
CT18075FLC	10

Catalog Number	Page Number
CT18075IDC	10
CT18075M	6
CT18075M0	6
CT18075M00	6
CT18075MH4C	12
CT18075MH4M	12
CT18087SSBC	16
CT18087SSBC0	16
CT18087SSBM	16
CT18087SSBM0	16
CT18100SSBC	16
CT18100SSBC0	16
CT18100SSBM	16
CT18100SSBM0	16
CT18125C	6
CT18125C0	6
CT18125C3	6
CT18125C3	6
CT18125C4	6
CT18125C4	6
CT18125M	6
CT18125M0	6
CT18200C	6
CT18200C0	6
CT18200C0UG	18
CT18200C1	6
CT18200C2	6
CT18200C5	6
CT18200C6	6
CT18200IDC	10
CT18200M	6
CT18200M0	6
CT18200M0UG	18
CT18200MUG	18
CT18200SSBC	16
CT18200SSBC0	16
CT18200SSBM	16
CT18200SSBM0	16
CT2501000Q	9
CT2501000RQ	11
CT2501200Q	9

Catalog Number	Page Number
CT2501200Q0	9
CT250200RQ	11
CT250200RQ0	11
CT250500RQ	11
CT250500RQ0	11
CT250600Q	9
CT250600Q0	9
CT250600RQ	11
CT250600RQ0	11
CT250800Q	9
CT250800Q0	9
CT250800Q0UG	19
CT250800RQ	11
CT250800RQ0	11
CT30125C	6
CT30125C0	6
CT30125C00	6
CT30125C0UG	18
CT30125CUG	18
CT30125M	6
CT30125M0	6
CT30125M00	6
CT30125MH8C	12
CT30125MH8M	12
CT30125MH8M0	12
CT30125MUG	18
CT40137SSBC	16
CT40137SSBC0	16
CT40137SSBM	16
CT40137SSBM0	16
CT40200C	7
CT40200C0	7
CT40200C00	7
CT40200CUG	18
CT40200M	7
CT40200M0	7
CT40200M00	7
CT40200MUG	18
CT40200SSBC	16
CT40200SSBC0	16
CT40200SSBD	16

ALPHA-NUMERIC INDEX BY CATALOG NUMBER (continued)

Catalog Number	Page Number
CT40200SSBD0	16
CT40300C	7
CT40300C0	7
CT40300C00	7
CT40300M	7
CT40300M0	7
CT40300M00	7
CT40300SSBC	16
CT40300SSBC0	16
CT40300SSBD	16
CT40300SSBD0	16
CT40400C	7
CT40400C0	7
CT40400C00	7
CT40400C0UG	18
CT40400M	7
CT40400M0	7
CT40400M00	7
CT40400SSBC	16
CT40400SSBC0	16
CT40400SSBD	16
CT40400SSBD0	16
CT50137RC	11
CT50175C	7
CT50175C0	7
CT50175C00	7
CT50175C0UG	18
CT50175C1	7
CT50175C2	7
CT50175C3	7
CT50175C4	7
CT50175C5	7
CT50175C6	7
CT50175C7	7
CT50175C8	7
CT50175CUG	18
CT50175IDC	10
CT50175M	7
CT50175M0	7
CT50175M00	7
CT50175M02	7

Catalog Number	Page Number
CT50175M0UG	18
CT50175MH10C	12
CT50175MH10C0	12
CT50175MH10C0UG	20
CT50175MH10CUG	20
CT50175MH10M	12
CT50175MH10M0	12
CT50175MUG	18
CT50175PMC	10
CT50175PMC0	10
CT50175RC	11
CT50175RC0	11
CT50175SSBC	16
CT50175SSBC0	16
CT50175SSBD	16
CT50175SSBD0	16
CT50200SSBB	16
CT50200SSBB0	16
CT50200SSBC	16
CT50200SSBC0	16
CT50250IDC	10
CT50250SSBB	16
CT50250SSBB0	16
CT50250SSBC	16
CT50250SSBC0	16
CT50300C	8
CT50300C0	8
CT50300C00	8
CT50300C0UG	18
CT50300C2	8
CT50300CUG	18
CT50300M	8
CT50300M0	8
CT50300M00	8
CT50300M0UG	18
CT50300MH10C0UG	20
CT50300MH10CUG	20
CT50300MUG	18
CT50300SSBB	16
CT50300SSBB0	16
CT50300SSBC	16

Catalog Number	Page Number
CT50300SSBC0	16
CT50400C	8
CT50400C0	8
CT50400C00	8
CT50400C0UG	18
CT50400C2	8
CT50400C3	8
CT50400CUG	18
CT50400M	8
CT50400M0	8
CT50400M00	8
CT50400M02	8
CT50400MH10C	12
CT50400MH10C0	12
CT50400MH10M0	12
CT50400MUG	18
CT50400RC	11
CT50400RC0	11
CT50400SSBB	17
CT50400SSBB0	17
CT50400SSBC	17
CT50400SSBC0	17
CT50425SSBB	17
CT50425SSBB0	17
CT50425SSBC	17
CT50425SSBC0	17
CTASST	22
CTASST500B	22
CTASST500N	22
CTASST650B	22
CTASST650N	22
CTB075AAF1C	14
CTB075AAF1C0	14
CTB075AAF1M	14
CTB075RA4CUG	21
CTB075RAF1C	14
CTB075RAF1C0	14
CTB075RAF1M	14
CTB075SF1C	14
CTB075SF1M	14
CTB100AAF2C	14

ALPHA-NUMERIC INDEX BY CATALOG NUMBER (continued)

Catalog Number	Page Number
CTB100AAF2C0	14
CTB100AAF2D	14
CTB100RAF2C	14
CTB100RAF2C0	14
CTB100RAF2D	14
CTB100RAF2L	14
CTB100SF2C	14
CTB125RA4CUG	21
CTB125RA4DUG	21
CTB150AAF3C	14
CTB150AAF3D	14
CTB150RA4C	14
CTB150RAF3C0	14
CTB150RAF3D	14
CTB150SF3C	14
CTHS120400M	13
CTHS18075M	13
CTHS40125M	13
CTHS50300M	13
CTHS50400M	13
CTHS50700M	13
CTSS100100FC304C	26
CTSS100100FC316C	29
CTSS100200FC304C	26
CTSS100200FC316C	29
CTSS100300FC304C	26
CTSS100300FC316C	29
CTSS100400FC304C	26
CTSS100400FC316C	29
CTSS100500FC304C	26
CTSS100500FC316C	29
CTSS100600FC304C	26
CTSS100600FC316C	29
CTSS100800FC304C	26
CTSS100800FC316C	29
CTSS225100304C	24
CTSS225100316C	27
CTSS225200304C	24
CTSS225200316C	27
CTSS225300304C	24
CTSS225300316C	27

Catalog Number	Page Number
CTSS225400304C	24
CTSS225400316C	27
CTSS225500304C	24
CTSS225500316C	27
CTSS225600304C	24
CTSS225600316C	27
CTSS250200FC304L	26
CTSS250200FC316L	29
CTSS250200PC304L	25
CTSS250200PC316L	28
CTSS250300FC304L	26
CTSS250300FC316L	29
CTSS250300PC304L	25
CTSS250300PC316L	28
CTSS250400FC304L	26
CTSS250400FC316L	29
CTSS250400PC304L	25
CTSS250400PC316L	28
CTSS250500FC304L	26
CTSS250500FC316L	29
CTSS250500PC304L	25
CTSS250500PC316L	28
CTSS250600FC304L	26
CTSS250600FC316L	29
CTSS250600PC304L	25
CTSS250600PC316L	28
CTSS250700FC304L	26
CTSS250700FC316L	29
CTSS250700PC304L	25
CTSS250700PC316L	28
CTSS250800FC304L	26
CTSS250800FC316L	29
CTSS250800PC304L	25
CTSS250800PC316L	28
CTSS450200FC304L	26
CTSS450200FC316L	29
CTSS450200PC304L	25
CTSS450200PC316L	28
CTSS450300FC304L	26
CTSS450300FC316L	29
CTSS450300PC304L	25

Catalog Number	Page Number
CTSS450300PC316L	28
CTSS450400FC304L	26
CTSS450400FC316L	29
CTSS450400PC304L	25
CTSS450400PC316L	28
CTSS450500FC304L	26
CTSS450500FC316L	29
CTSS450500PC304L	25
CTSS450500PC316L	28
CTSS450600FC304L	26
CTSS450600FC316L	29
CTSS450600PC304L	25
CTSS450600PC316L	28
CTSS450700FC304L	26
CTSS450700FC316L	29
CTSS450700PC304L	25
CTSS450700PC316L	28
CTSS450800FC304L	26
CTSS450800FC316L	29
CTSS450800PC304L	25
CTSS450800PC316L	28
CTSS500200304L	24
CTSS500200316C	27
CTSS500300304L	24
CTSS500300316C	27
CTSS500400304L	24
CTSS500400316L	27
CTSS500500304L	24
CTSS500500316L	27
CTSS500600304L	24
CTSS500600316L	27
CTSS500700304L	24
CTSS500700316L	27
CTSS500750304L	24
CTSS500750316L	27
CTSS500800304L	24
CTSS500800316L	27
CTSS675200FC304Q	26
CTSS675200FC316Q	29
CTSS675200PC304Q	25
CTSS675200PC316Q	28

ALPHA-NUMERIC INDEX BY CATALOG NUMBER (continued)

Catalog Number	Page Number
CTSS675300FC304Q	26
CTSS675300FC316Q	29
CTSS675300PC304Q	25
CTSS675300PC316Q	28
CTSS675400FC304Q	26
CTSS675400FC316Q	29
CTSS675400PC304Q	25
CTSS675400PC316Q	28
CTSS675500FC304Q	26
CTSS675500FC316Q	29
CTSS675500PC304Q	25
CTSS675500PC316Q	28
CTSS675600FC304Q	26
CTSS675600FC316Q	29
CTSS675600PC304Q	25
CTSS675600PC316Q	28
CTSS675700FC304Q	26
CTSS675700FC316Q	29
CTSS675700PC304Q	25
CTSS675700PC316Q	28
CTSS675800FC304Q	26
CTSS675800FC316Q	29
CTSS675800PC304Q	25
CTSS675800PC316Q	28
CTSS700200304L	24
CTSS700200316L	27
CTSS700300304L	24
CTSS700300316L	27
CTSS700400304L	24
CTSS700400316L	27
CTSS700500304L	24
CTSS700500316L	27
CTSS700600304L	24
CTSS700600316L	27
CTSS700700304L	24
CTSS700700316L	27
CTSS700800304L	24
CTSS700800316L	27
CTSS900200304L	24
CTSS900200316L	27
CTSS900300304L	24

Catalog Number	Page Number
CTSS900300316L	27
CTSS900400304L	24
CTSS900400316L	27
CTSS900500304L	24
CTSS900500316L	27
CTSS900600304L	24
CTSS900600316L	27
CTSS900700304L	24
CTSS900700316L	27
CTSS900800304L	24
CTSS900800316L	27
CTT50	34
CTTSS900	34
MK9	34
TFV3B12V2	23
TFV3B18V2	23
TFV3B6V2	23
TFV3BLU12	23
TFV3BLU18	23
WBS10V	30
WBS12V	30
WBS14V	30
WBS20V	30
WBS24V	30
WBS30V	30
WBS36V	30
WBS8V	30
WIPC14-1	31
WIPC14-112	31
WIPC14-12	31
WIPC14-14	31
WIPC14-34	31
WIS12-3	31
WIS8-2	31

Straps and Clips

Wiley Bundle Straps and Clips

Easy to install and made of corrosion resistant 304 stainless steel, the WILEY Bundle Strap is a durable, long lasting, reliable solution for all environments and can be custom designed to meet your needs.

Bundle Straps

UV protected vinyl jacketed 304 stainless steel wire with a 304 stainless steel crimp. Unique retention feature allows for a quick, effortless, and secure installation of PV bundles. UL 62275 Listed



90-Degree Module Clips

304 stainless steel cable clips that install parallel or perpendicular on a module frame or purlin. Compatible with USE-2, PV cable, and Enphase/Micro Inverter Trunk Cables. UL 1565 Listed



Module Clips

304 stainless steel cable clips that install on a module frame or purlin. Compatible with USE-2 and PV cables. UL 1565 Listed



Rail Clips

304 stainless steel cable clips that install in the rail channel. Compatible with USE-2, PV cable, and Enphase/Micro Inverter Trunk Cables. UL 1565 Listed



Bundle Clips

304 stainless steel bundle clips that install on a module frame, purline, or in the rail channel. Utilizes the Wiley Bundle Strap and the UNIRAP™ cable ties. Compatible with USE-2, PV cable, and Enphase/Micro Inverter trunk cable bundles. UL 1565 & UL 62275 Listed





www.we-llc.com | 1-800-346-4175
www.burndy.com | 1-800-346-4175



Customer Service Department

7 Aviation Park Drive
Londonderry, NH 03053
1-800-346-4175
1-603-647-5299 (International)

Canada

1-800-361-6975 (Quebec)
1-800-387-6487 (All other provinces)

Mexico

011-52-722-265-4400

Brazil

011-55-11-5515-7225

Tool Service Center

Littleton Industrial Park
Littleton, NH 03561
1-800-426-8720



Connecting Power to Your World®

