

# HandyBug™

## The Survival Tool of Electrical Connections

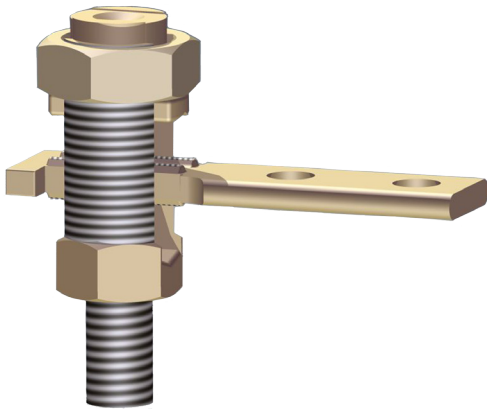

Look at just some of the many applications!

### Features & Benefits

- Power or Grounding
- Can be used to terminate wires to bus bars for power or grounding
- Can be used for splicing and tap connections
- Used to connect ground wires to pipe or fencing
- No special tooling required
- cULus Listed
- Rated for Direct Burial
- Tin Plated
- Industry standard mounting hole configurations

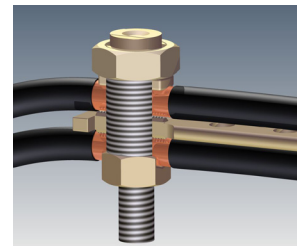
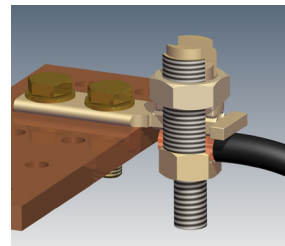
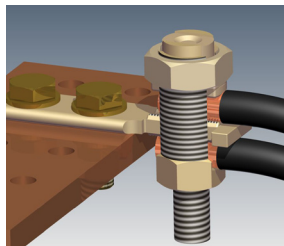
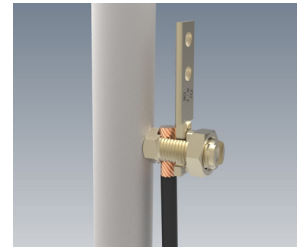
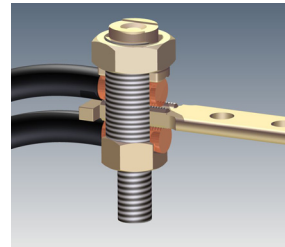
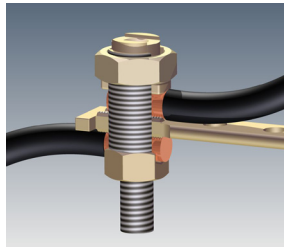
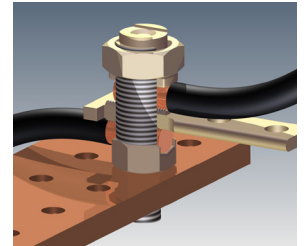
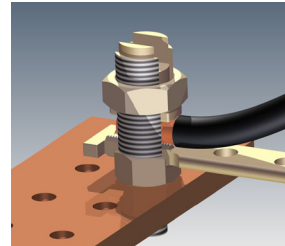
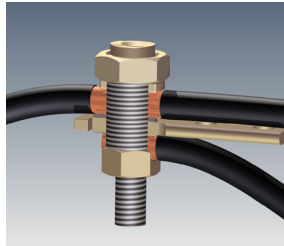

### Markets / Customer Base

- Commercial Contractors
- Emergency Service Technicians
- Maintenance Repair & Operations (MRO)
- Distribution Counters
- Military
- Utilities and Power Distribution
- Industrial Markets
- Retail

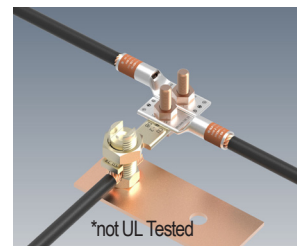
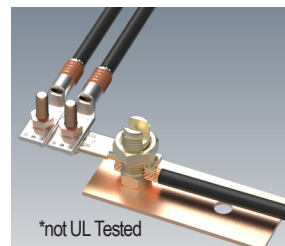
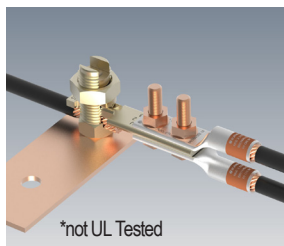

Customer Service 1-800-346-4175 | Tool Service Center 1-800-426-8720 | Technical Services 1-800-451-4956 | [www.burndy.com](http://www.burndy.com)