

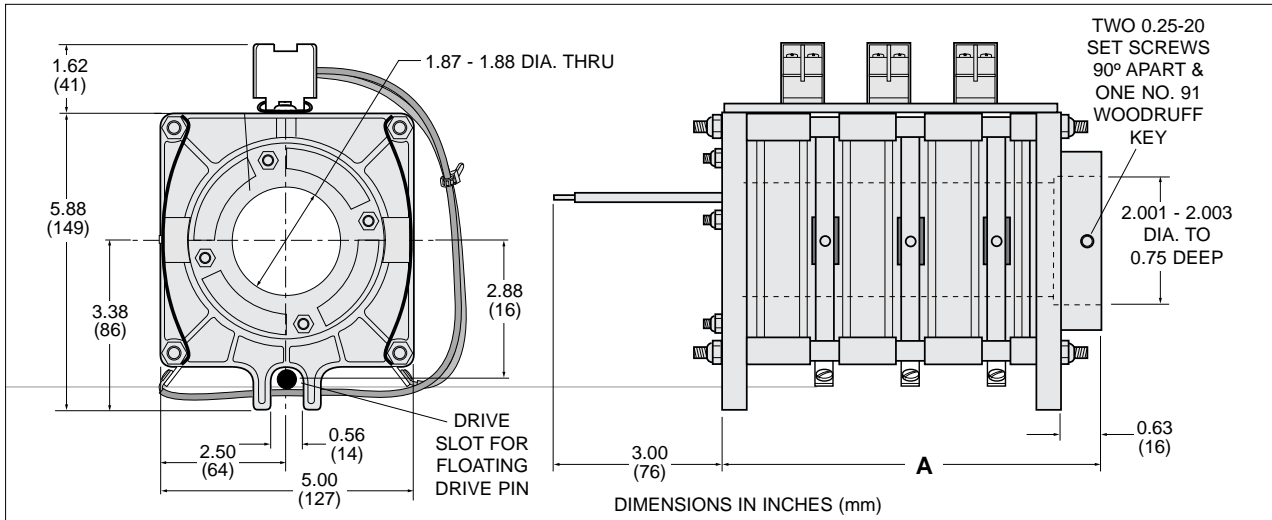

ROTA-POWER™ 35 SLIP RINGS

35 Ampere 600 Volt 2.0"(51mm) Bore

- **RINGS:** Copper alloy for best combination of conductivity and durability. Wide contact area for maximum reliability.
- **BRUSHES:** Copper graphite, precisely machined to match ring radius.
- **BRUSH SPRINGS:** Zinc plated steel with "quick change" design for easy field inspection.
- **SHUNT WIRES:** Braided copper.
- **INSULATORS:** Phenolic.
- **END PLATES:** Nylon with phenolic bearing surfaces are both durable and economical.
- **DRIVE COLLAR:** Cast aluminum with double set screws for secure mounting at any attitude.
- **SPEED:** Nominal 125 rpm; reversing.
- **ENCLOSURES:** Durable steel with polyester powder baked-on finish exceeds even zinc plating. Custom coatings available. See opposite side for details.



35 AMP ROTA-POWER SLIP-RINGS

Model Number	Number Poles	Assembled Length (A)	AWG Lead*
		in. (mm)	
RP035-02	2	4.88 (124)	#12
RP035-03	3	4.88 (124)	#12
RP035-04	4	4.88 (124)	#12
RP035-06	6	7.38 (188)	#12
RP035-08	8	7.38 (188)	#12
RP035-10	10	9.88 (251)	#12
RP035-12	12	9.88 (251)	#12
RP035-14	14	12.38 (314)	#12
RP035-16	16	12.38 (314)	#12
RP035-20	20	15.88 (403)	#12
RP035-24	24	18.38 (467)	#12
RP035-30	30	22.13 (562)	#12
RP035-36	36	25.82 (656)	#12

* Unless otherwise specified, standard assemblies are supplied with lead wires as indicated, derated per lead wire limits and per number of poles.

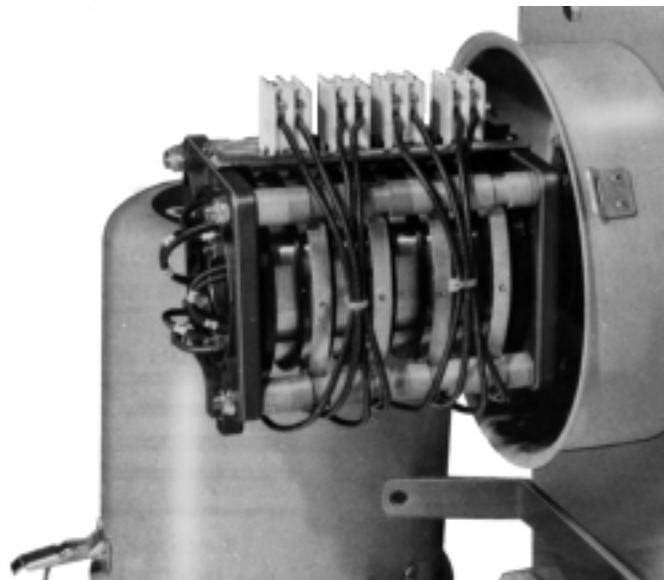

Slip Rings with ratings to 700 Amps and 15,000 volts also available. Contact Gleason.

SLIP-RINGS IN ENCLOSURES

ROTA-POWER™ 35 Slip-Ring plus Enclosure

- **WEATHERTIGHT HOUSING:** Easy to access Gleason Slip-Ring Enclosures are watertight and dust-tight. Sealed design keeps all but the most minute particles away from the working slip-ring.
- **RUGGED CONSTRUCTION:** All enclosures are manufactured from medium gauge steel and are custom fit to each slip-ring size. Main shafts are mounted to enclosure on double ball bearings (for support of slip-ring assembly and enclosure only).
- **WEATHERPROOF FINISH:** Gleason Slip-Ring Enclosures feature a baked-on polyester finish for maximum durability in harsh condition. Finish exceeds even zinc plating. Custom colors and finishes are available—contact Gleason Reel for details.
- **HEATERS:** For outdoor applications where machinery is not operating for extended periods of time or where low temperatures are common, we recommend the installation of a strip heater. Condensation can build up during shut-down periods causing the slip-ring assembly to require frequent service. The strip heater eliminates this condensation on a continuous basis increasing the service life of your Gleason Reel Slip-Ring assembly.

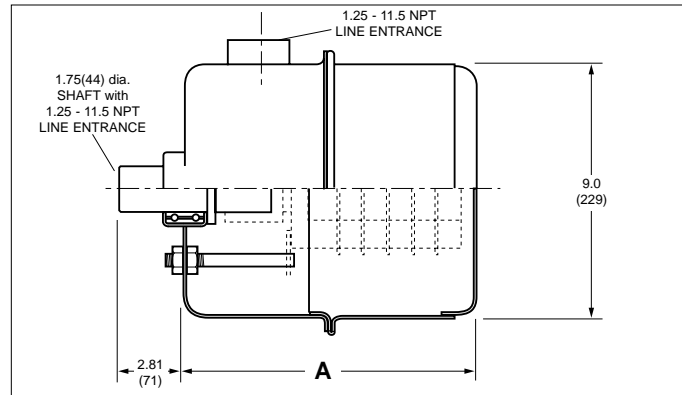

Model Number	Number Poles	Amps*	Assembled Length (A)	
			in.	(mm)
ERP035-02	2	35	12.00	(305)
ERP035-03	3	35	12.00	(305)
ERP035-04	4	35	12.00	(305)
ERP035-06	6	35	14.50	(369)
ERP035-08	8	35	14.50	(369)
ERP035-10	10	35	17.00	(432)
ERP035-12	12	35	17.00	(432)

Model Number	Number Poles	Amps*	Assembled Length (A)	
			in.	(mm)
ERP035-14	14	35	19.50	(496)
ERP035-16	16	35	19.50	(496)
ERP035-20	20	35	24.50	(623)
ERP035-24	24	35	24.50	(623)
ERP035-30	30	35	32.50	(826)
ERP035-36	36	35	32.50	(826)

* Unless otherwise specified, standard assemblies are supplied with lead wires as indicated, derated per lead wire limits and per number of poles (see below).

Ampacities are based on 3 pole 75°C rated wire at 30° ambient (per N.E.C.). **Ampacity must be derated when more than 3 poles are used**, as follows:

- 4 to 6 poles: 80% of rating shown.
- 7 to 24 poles: 70% of rating shown.
- 25 to 36 poles: 60% of rating shown.

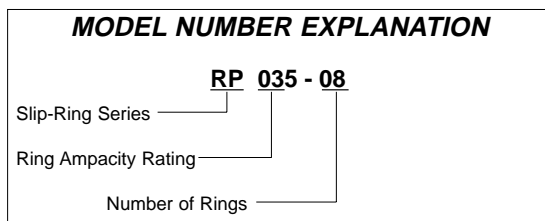

Gleason Slip-Rings may be mounted in virtually any position. Used in Gleason Reels, they are mounted horizontally. Vertical applications include rotating signs and amusement rides. Whichever configuration you choose, it is possible for either the main shaft or the mounting surface to be in rotation.

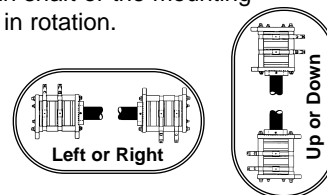

Please note: Bearing supports on all slip-rings intended for support of slip-ring **only**.



A Hubbell Company

GLEASON REEL CORP.

P.O. Box 26 • 600 South Clark Street
 Mayville, WI 53050
 Phone 920-387-4120 • FAX 920-387-4189