

DC Devices - Type 711 / 712 1600A Motor-Operated Switch System

Catalog • October 2010

42711 / 42712

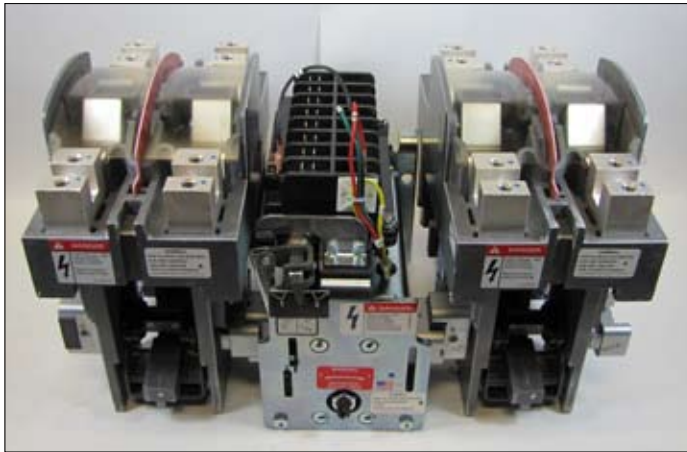

The 1600 Amp, 1500 Volt DC Motor Operated Switch is created by coupling up to six Type 712 Switch Modules to one Type 711 Motor Module. This combination is suitable for mounting on a common 3 inch channel. This Motor Operated Switch is designed for use in DC systems such as those found in oil well drilling, crane control, uninterruptable power supplies, transportation and mining equipment and adjustable speed DC drives.

TYPE 711 MOTOR MODULE



HIGHLIGHTS

- Controls up to six Switch Modules at once
- Two second travel time
- Three N.O. and three N.C. auxiliary contacts
- 24, 74 or 125 VDC control voltage

TYPE 712 SWITCH MODULE



HIGHLIGHTS

- Two-Pole Double-Throw Non-interrupting Switch
- 1600 Amp 1500 VDC rating
- Motor Cut-Out (MCO) option
- Trifurcated main contacts
- Silver alloy main contacts
- Silver-plated current-carrying connections
- High dielectric and mechanical strength

Amazingly Reliable – Hubbell Industrial Controls Devices

The Hubbell ICD family of rugged, high-performance DC devices are in great demand by industries needing reliable, solid state, adjustable controls. Products include contactors, limit switches, crane controls, fire pump controls, transfer switches, motor controllers and resistors. Hubbell ICD has a device ideal for a wide range of applications. And if it's from Hubbell, you know you're getting amazingly reliable technology.



hubbell industrial controls, inc.

TYPE 711 Motor Module

The Type 711 Motor Module can drive up to six Type 712 Switch Modules. Motor voltages of 24 volts DC, 74 volts DC and 125 volts DC are available. Travel time from one end position to the other is approximately 2 seconds.

The Switch Module will not try to interrupt or change state with the Motor Operated Switch design. Upon loss of power, the motor remains in its location. The switch modules coupled to the motor module also remain in their existing closed (non interrupting) position.

Three Normally Open and Three Normally Closed (3 N.O. and 3 N.C.) Auxiliary Contacts are available for customer use. Between end position all six auxiliary contacts are open.

TYPE 712 Switch Module

The Type 712 Switch Module is a two pole double throw non interrupting switch rated for 1600 amps in a convection cooled, 40° C ambient and insulated for 1500 volts DC.

The Switch Module Motor Cut-Out (MCO) option is available which positions the switch module main movable contacts to a "neutral" center (all contacts open) location. This operation removes that switch module load from its power source while

the loads on the remaining switch modules remain connected to the power source. MCO operation is achieved by energizing the Switch Module MCO coil. The main movable switch contacts will then be centered on the next motor module travel. De-energizing the MCO coil will allow the main movable switch contacts to be driven by the motor module on its next cycle connecting that switch module's load to its power source. One Normally Open and One Normally Closed (1 N.O. and 1 N.C.) auxiliary contacts are available to indicate MCO status for customer use.

Switch Module utilizes main contacts with wiping action to provide exceptionally high reliability contact continuity and low contact resistance. Main contacts are silver alloy with major current carrying parts silver plated for good electrical connections. Non-current carrying steel parts are zinc plated with a dichromate finish for maximum corrosion protection.

Non-tracking moldings of glass polyester offer high dielectric mechanical strength.

All operating coils are of molded construction for protection against dirt, moisture and physical abuse resulting in high reliability and long life.

PRODUCT LISTING

Ordering Information:

Type 711 Series

Catalog Number as follows:

14-192-625-50- *

* Last digit specifies DC motor control voltage.

Type 712 Series

Catalog Number as follows:

14-192-626-50- *

* Last digit specifies MCO configuration.

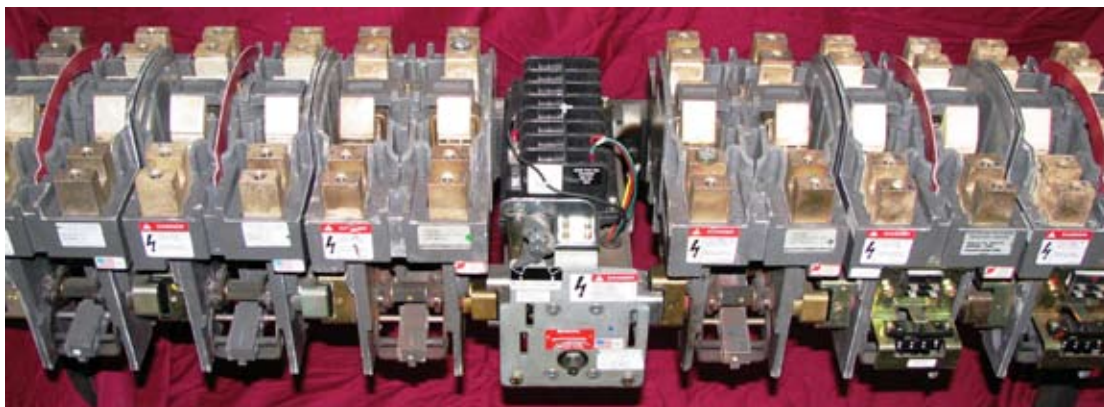

SPECIFICATIONS

TYPE 711 MOTOR MODULE

Motor Ratings

Rated Voltage	Minimum Operating Voltage	Maximum Current
24VDC	20VDC	15A
74VDC	60VDC	5A
125VDC	100VDC	3A

120 operations per hour maximum

5 operations per minute maximum

Auxiliary Interlock Ratings

3 N.O. and 3 N.C. at End Positions (All N.O. Between End Positions)

Resistive Load

125 VDC or less, 10 Amps

250 VDC, 2.5 Amps

Maximum interrupting capacity:

1.5A at 125VDC Inductive

5.0A at 125VDC Resistive

Mounting

Mounts on 3 in. (76.2 mm) wide channel with two 3/8 in. (M8) screws

Connections

Two 1/4 in. (6.35 mm) faston tabs per terminal (36 total)

Weight

26 lbs. (12 kg)

TYPE 712 SWITCH MODULE

Main Pole Configuration

Two pole Double Throw (DPDT)

Main Contact Rating

Continuous open air rating = 1600 Amps @ 40°C ambient

Maximum voltage = 1500 Volts DC

Maximum interrupting capacity = 100A

Thru-Current Capability = 30,000 Amps

Special ratings available - Consult factory

MCO Switch Rating

1 N.O. and 1 N.C.

15 Amps, 600 VAC, resistive

0.4 Amps, 115 VDC, inductive

0.2 Amps, 230 VDC, inductive

Same Polarity

MCO Operating Coil Ratings (Continuous Duty)

Rated Voltage	OHMS (@ 20° C)	Minimum Operating Voltage
24VDC	20	20VDC
74VDC	190	60VDC
125VDC	480	100VDC

Mounting

Mounts on 3 in. (76.2 mm) wide channel with two 3/8 in. (M8) screws

Power Connections

Top and bottom of Switch Module



Two 3/8 in.—16 tapped holes per terminal

MCO Switch Connections

Two 1/4 in. (6.35 mm) faston tabs per terminal (8 total)

Weight

28 lbs. (13 kg)

	Illustration	Catalog No.	Description
TYPE 711 MOTOR MODULE		14-192-625-501 14-192-625-502 14-192-625-503	125VDC Motor 74VDC Motor 24VDC Motor
TYPE 712 SWITCH MODULE		14-192-626-502 14-192-626-503 14-192-626-504 14-192-626-505	no MCO with 24VDC MCO with 74VDC MCO with 125VDC MCO

TYPE 711 MOTOR MODULE - Connection Diagrams

Auxiliary Contact Configuration

CIRCUIT	POSITION		
	1	MIDDLE	2
Y-V	OPEN	CLOSED	CLOSED
X-W	CLOSED	CLOSED	OPEN
A-B	OPEN	OPEN	CLOSED
C-D	OPEN	OPEN	CLOSED
E-F	CLOSED	OPEN	OPEN
G-H	CLOSED	OPEN	OPEN
N-P	OPEN	OPEN	CLOSED
Q-R	CLOSED	OPEN	OPEN

Gearmotor Wiring Diagram

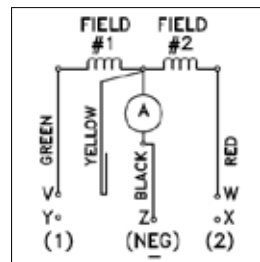

TYPE 712 SWITCH MODULE - Connection Diagrams

Typical Schematic - Main Contacts

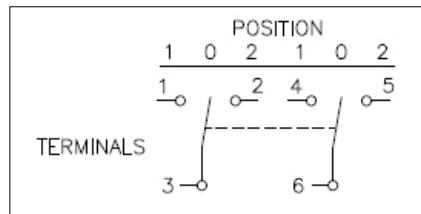

MCO Switch

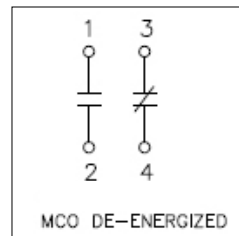

OUTLINE DRAWINGS

TYPE 711 MOTOR MODULE

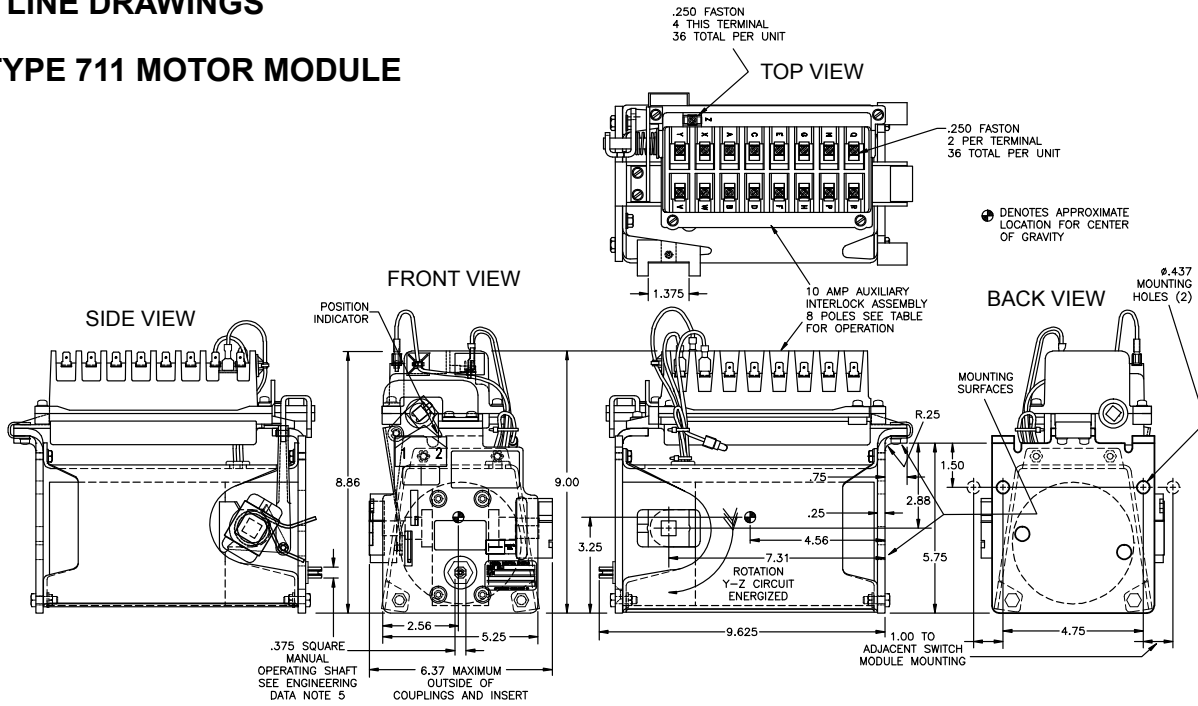

TYPE 712 SWITCH MODULE

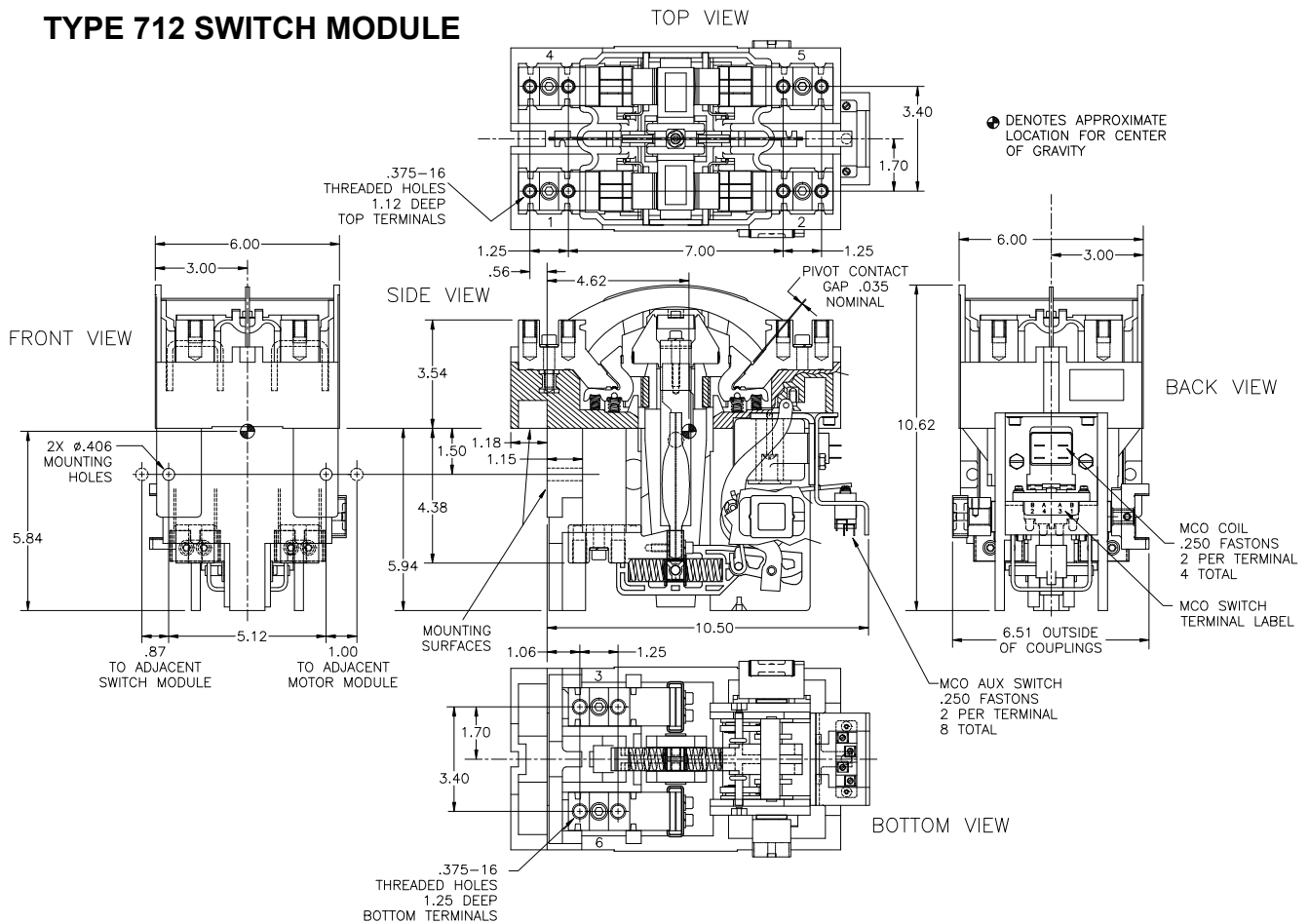

All dimensions are shown in inches. For reference purposes only; not to be used for design or construction purposes.
 All electrical specifications are based on mounting devices upright as shown.



Hubbell Industrial Controls, Inc.
 a subsidiary of Hubbell Incorporated
 4301 Cheyenne Drive, Archdale, NC 27263
 Phone (336) 434-2800 | Fax (336) 434-2801
 www.hubbell-icd.com
 sales@hubbell-icd.com