

MANUAL

WEATHERPROOF



TAYMAC BELL

TRAINING



RACO TAYMAC BELL

TABLE OF CONTENTS

History 3

NEC Definitions 4

Box Fill Calculations 5

Types of Wiring Systems 7

Rain-tight, concrete-tight, liquid-tight and water-tight 10

Weatherproof Boxes A1

Weatherproof Extensions and Adapters B1

Weatherproof Covers C1

Weatherproof Lighting & Accessories D1

Product/Packaging Reference i

Multiple Configurations i

Quick-Fit™ & Knock-Out™ ii

Glossary iii

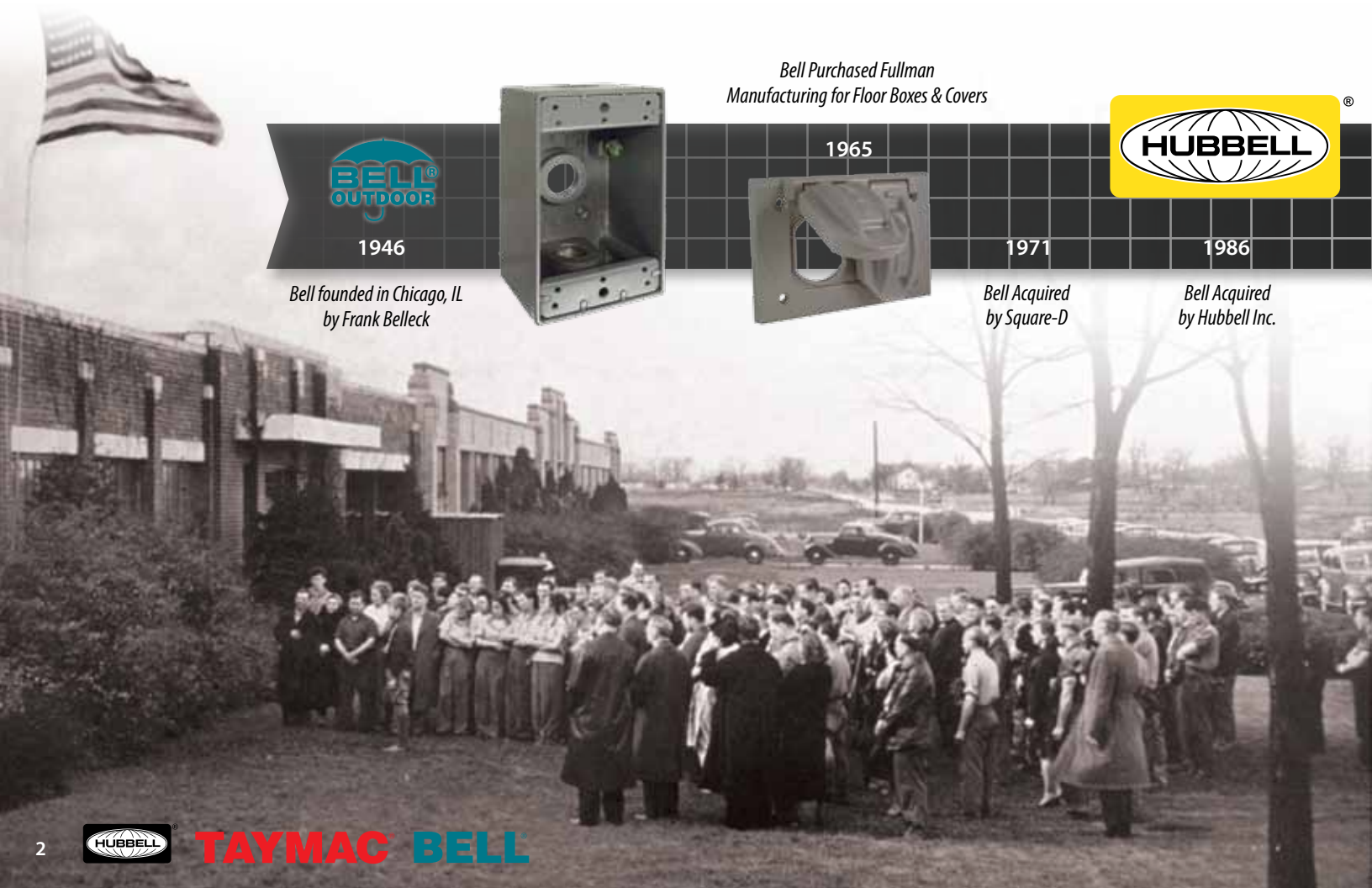

 1946 <i>Bell founded in Chicago, IL by Frank Belleck</i>		<p><i>Bell Purchased Fullman Manufacturing for Floor Boxes & Covers</i></p> 1965 	1971 <i>Bell Acquired by Square-D</i>	 1986 <i>Bell Acquired by Hubbell Inc.</i>
---	---	---	---	--

HISTORY

1946: Bell founded in Chicago, IL by Frank Belleck

- Inventor of weatherproof boxes and covers... 1st company to sell
- 1st product offered was a spring-loaded... "TR" wiring device
- The term "Bell Box" is a generic term for a weatherproof box
- Primarily sold through retail outlets such as Sears, Montgomery Wards, Woolsworths, and JC Penny's

1965: Bell Purchased Fullman Manufacturing for Floor Boxes & Covers

1971: Bell Acquired by Square-D

1986: Bell Acquired by Hubbell Inc.

1989: TayMac founded by Michael Shotey

- Inventor of while-in-use cover technology
- Was a pool builder by trade
- Shotey (ideas) + McLellan (Investor) = TayMac

1997: TayMac 1st WIU cover sold to The Home Depot

2008: TayMac launches line of metallic weatherproof

2011: TayMac Extra-Duty, Metallic WIU covers Launched

2012: TayMac acquired by Hubbell Inc.

2013: TayMac Extra-Duty, Non-Metallic WIU covers Launched

TayMac sells first While-In-Use cover to The Home Depot

TayMac Extra-Duty, Metallic WIU covers Launched

TayMac acquired by Hubbell Inc.

TayMac Extra-Duty, Non-Metallic WIU covers Launched

1989



1997



2008



2011

2012

2013

TAYMAC

2013



TayMac founded by Michael Shotey

TayMac launches line of metallic weatherproof

Opens a 100,000+ sq. ft. super efficient distribution facility in South Bend, IN



2014 NEC WET AND DAMP LOCATION DEFINITIONS

406.9

(A) Receptacles in Damp Locations. A receptacle installed outdoors in a location protected from the weather or in other damp locations shall have an enclosure for the receptacle that is weatherproof when the receptacle is covers (attachment plug cap not inserted and receptacle covers closed).

An installation suitable for a wet location shall also be considered suitable for damp locations.

A receptacle shall be considered to be in a location protected from the weather where located under roofed open porches, canopies, marquees, and the like, and will not be subject to a beating rain or water runoff. All 15- and 20- ampere, 125- and 250- volt non-locking receptacles shall be a listed weather-resistant type.

(B) Receptacles in Wet Locations

(1) Receptacles of 15 and 20 Amperes in a Wet Location. 15- and 20-ampere, 125- and 250-volt receptacles installed in a wet location shall have an enclosure that is weatherproof whether or not the attachment plug cap is inserted. An outlet box hood installed for this purpose shall be listed and shall be identified as "extra duty." All 15- and 20- ampere, 125- and 250- volt non-locking type receptacles shall be listed weather-resistant type.

(2) Other Receptacles. All other receptacles installed in a wet location shall comply with (B)(2)(a) or (B)(2)(b).

(a) A receptacle installed in a wet location, where the product intended to be plugged into it is not attended while in use, shall have an enclosure that is weatherproof with the attachment plug cap inserted or removed.

(b) A receptacle installed in a wet location where the product intended to be plugged into it will be attended while in use (e.g., portable tools) shall have and enclosure that is weatherproof when the attachment plug is removed.

(C) Bathtub and Shower Space. Receptacles shall not be installed within or directly over a bathtub or shower stall.

(D) Protection for Floor Receptacles. Standpipes of floor receptacles shall allow floor-cleaning equipment to be operated without damage to receptacles.

(E) Flush Mounting with Faceplate. The enclosure for a receptacle installed in an outlet box flush-mounted in a finished surface shall be made weatherproof by means of a weatherproof faceplate assembly that provides a watertight connection between the plate and the finished surface.

CALCULATE THE MINIMUM SIZE BOX

Wiring Capacity: BELL® Weatherproof Boxes and Extensions

Maximum Number of Conductors or Minimum Size Box (Article 314.16 (B))

The purpose of Section 314.16 (B) is to determine the maximum conductor count or the minimum box size required for the job. It also can be used to figure how many other conductors may be added without exceeding the Code-prescribed limit. Most applications have determined the number of conductors. The rules of Section 314.16 (B) are used to determine the Code recognized limit, or smallest box that may be installed.

Selection of any BELL Weatherproof box or extension for use in any electrical circuit work must take into consideration the maximum number of wires permitted in the box. Safe electrical practice demands that wires not be jammed into boxes because of the possibility of nicks, abrasions, or other damage to the insulating material, creating the potential for ground faults or short circuits.

314.16 Number of Conductors in Outlet, Device, and Junction Boxes, and Conduit Bodies. Boxes and conduit bodies shall be of an approved size to provide free space for all enclosed conductors. In no case shall the volume of the box, as calculated in 314.16(A), be less than the fill calculation as calculated in 314.16(B). The minimum volume for conduit bodies shall be as calculated in 314.16(C).

The provisions of this section shall not apply to terminal housings supplied with motors or generators.

Boxes and conduit bodies enclosing conductors 4 AWG or larger shall also comply with the provisions of 314.28.

(A) Box Volume Calculations. The volume of a wiring enclosure (box) shall be the total volume of the assembled sections and, where used, the space provided by plaster rings, domed covers, extension rings, and so forth, that are marked with their volume or are made from boxes the dimensions of which are listed in Table 314.16(A). (1) Standard Boxes. The volumes of standard boxes that are not marked with their volume shall be as given in Table 314.16(A).

(2) Other Boxes. Boxes 1650 cm³ (100 in.³) or less, other than those described in Table 314.16(A), and nonmetallic boxes shall be durably and legibly marked by the manufacturer with their volume. Boxes described in Table 314.16(A) that have a volume larger than is designated in the table shall be permitted to have their volume marked as required by this section.

(B) Box Fill Calculations. The volumes in paragraphs 314.16(B)(1) through (B)(5), as applicable, shall be

added together. No allowance shall be required for small fittings such as locknuts and bushings.

(1) Conductor Fill. Each conductor that originates outside the box and terminates or is spliced within the box shall be counted once, and each conductor that passes through the box without splice or termination shall be counted once. Each loop or coil of unbroken conductor not less than twice the minimum length required for free conductors in 300.14 shall be counted twice. The conductor fill shall be calculated using Table 314.16(B). A conductor, no part of which leaves the box, shall not be counted.

Exception: An equipment grounding conductor or conductors or not over four fixture wires smaller than 14 AWG, or both, shall be permitted to be omitted from the calculations where they enter a box from a domed luminaire or similar canopy and terminate within that box.

(2) Clamp Fill. Where one or more internal cable clamps, whether factory or field supplied, are present in the box, a single volume allowance in accordance with Table 314.16(B) shall be made based on the largest conductor present in the box. No allowance shall be required for a cable connector with its clamping mechanism outside the box.

(3) Support Fittings Fill. Where one or more luminaire studs or hickies are present in the box, a single volume allowance in accordance with Table 314.16(B) shall be made for each type of fitting based on the largest conductor present in the box.

(4) Device or Equipment Fill. For each yoke or strap containing one or more devices or equipment, a double volume allowance in accordance with Table 314.16(B) shall be made for each yoke or strap based on the largest conductor connected to a device(s) or equipment supported by that yoke or strap. A device or utilization equipment wider than a single 50 mm (2 in.) device box as described in Table 314.16(A) shall have double volume allowances provided for each gang required for mounting.

(5) Equipment Grounding Conductor Fill. Where one or more equipment grounding conductors or equipment bonding jumpers enter a box, a single volume allowance in accordance with Table 314.16(B) shall be made based on the largest equipment grounding conductor or equipment bonding jumper present in the box. Where an additional set of equipment grounding conductors, as permitted by 250.146(D), is present in the box, an additional volume allowance shall be made based on the largest equipment grounding conductor in the additional set.

CALCULATE THE MINIMUM SIZE BOX

Calculate The Minimum Size Box

Section 314-16(B) describes in detail the method of counting wires, as well as clamps, fittings, or devices (i.e., switches, receptacles, combination devices) — by establishing an equivalent conductor-value for each. These values are added together to get a total number of conductors. The minimum size box is the smallest one in cubic inch size that can accommodate that number of conductors.

Points to Remember:

1. No matter how many ground wires come into a box, they only count as one conductor within the box.
2. Any wire running unbroken through the box counts as one wire.
3. Each wire coming into a splice device (crimp or twist-on type) is counted as one wire.
4. Each wire coming into the box and connecting to a device counts as one wire of that size.
5. Where devices are mounted in the box, the total conductor count must be increased by two for each mounting strap.

Table 314.16(B)
Volume Allowance Required per Conductor

Size of Conductor	Free Space Within Box for Each Conductor	
(AWG)	cm ³	in. ³
18	24.6	1.50
16	28.7	1.75
14	32.8	2.00
12	36.9	2.25
10	41.0	2.50
8	49.2	3.00
6	81.9	5.00

Example – BELL® Weatherproof

Supply power to a single switch with #14 conductors. Metal conduit will be used as the wire way. You must provide space for four conductors and one switch, totally a conductor count of 6. Read across the line in Table 314.16(B) for a #14 conductor. Multiply 6 times the free space within a box. For each conductor for a #14 conductor 2.00. This example requires a minimum box of 12.0 cubic inches.

WIRING SYSTEMS: CABLE & FLEXIBLE CONDUIT

Types of Wiring Systems (see Figure A)

There are various types of cable wiring systems used in construction today. Most are unique to either commercial or residential construction or various geographical regions throughout the U.S. This module highlights the different types of cable and flexible conduit.



Cable

Cable is manufactured with current carrying, and frequently grounding, conductors factory installed. Cables are flexible and available with metal or non-metallic outer coverings. Cables are described by the number and size of current carrying conductors and "with ground" when a grounding conductor is included. Cables are often covered by finished walls and changes are difficult to accomplish. A single conductor is an individual wire, usually sheathed with an insulating material. Conductors are shielded from one another by material that does not carry current - color coded PVC material. A grounding wire is green or green with one or more yellow stripes. It may also be bare. White or gray insulation indicates neutral wire; all other colors are used to identify hot wires. Copper is the best and most commonly used metal for conductors, aluminum and copper-clad aluminum are also used. Aluminum or copper-clad aluminum wire must be larger than a copper wire to conduct the same amount of electricity because aluminum is not as efficient a conductor as copper. "Conductor fill" refers to the number of current carrying and grounding conductors permitted by the NEC to be allowed in conduit. It relates to the trade size of conduit and varies by gauge and insulation. Generally, the conductors may fill only 40% of the conduit. Conduit fill has no relationship to the number of conductors allowed in a box.

Flexible Metallic Conduit

Flexible metallic conduit is frequently called "Greenfield™" which is the trade name of one manufacturer of this flexible steel or aluminum raceway. It is used around machinery where vibration or movement exists or where complex routing of the raceway dictates a flexible conduit. It is also used for short connections from junction box to light fixtures in false ceilings or commercial buildings. It offers good mechanical protection, but is approved for only dry locations. Flex is available in steel or aluminum, in trade sizes of 3/8" to 4", and is supplied in coils. Flex must be supported every 4-1/2 feet and within 12" of a box. The only exceptions to the support requirements are light fixtures in old work applications. Usually the conduit serves as the ground path.



Flexible Armored Cable (BX®, AC)

Flexible armored cable is commonly called BX, a manufacturer's trade name. It may be described as pre-wired Greenfield™ since it includes two or more current carrying conductors and can be furnished with a grounding conductor. The conductors are individually insulated. BX/AC is permitted indoors in dry locations only. It must be supported every 4 feet and within 12" of a box, except in old work. AC cable has a bonding strip (16 AWG). This strip is in constant contact with the armor, and with the armor, forms an equipment ground.

Nonmetallic Sheathed Cable (ROMEX®)

Nonmetallic sheathed cable, often called by a manufacturer's trade name Romex®, is two or more insulated conductors, usually copper, protected by an outer covering of nonmetallic material. Type NM must be used in dry locations, but type NMC has an outer covering that resists dampness and fungus. Nonmetallic sheathed cable is used in one or two family dwellings, multi-family dwellings and other structures not exceeding three floors above ground. It is the accepted raceway for nonmetallic outlet and switch boxes. Nonmetallic sheathed cable is not permitted in industrial applications and prohibited by some local codes. Instead of "trade size", nonmetallic sheathed cable is described by conductor size, number of conductors, and with or without ground wire. Nonmetallic sheathed cable is sold in coils and is available in #14 through #12. Nonmetallic sheathed cable must be supported every 4.5' and within 12" of the box.



Metal Clad Cable (MC Cable)

MC Cable is a factory assembly of one or more insulated conductors wrapped in a polypropylene tape enclosed in a steel or aluminum armor. MC Cable is typically used indoors in exposed and concealed locations for power, lighting control and signal circuits. MC Cable, unlike Armored Cable, cannot be used as a grounding means.

MC Cable and Armored Cable are similar in look and feel. An easy way to differentiate between the two is to look for the type of material used to wrap the conductors inside the armor. Armored Cable typically uses moisture-resistant and fire retardant paper wraps around individual conductors, while Metal Clad Cable typically uses a clear plastic (polypropylene) tape as a wrap around the conductor bundle.

MC Cable must be supported and secured every 6 feet and within 12" of a box.

Service Entrance Cable (SE)

Service entrance cable can be compared to Romex in larger conductor sizes, #8-#4/0 with a weatherproof non-metallic outer covering. It may be used alone, without additional encasement, in locations where it will not be subjected to mechanical abuse. However, it is typically encased in rigid/IMC or EMT conduit for additional physical protection. The SE cable must be supported every 4 feet and within 12 inches of every box, panel, entrance cap, or enclosure. A separate grounding conductor is included in the SE cable. Type SEU cable is approved for underground use.

Underground Feeder Cable (UF)

Underground feeder cable (Type UF) is a group of conductors manufactured in the form of a cable assembly similar to type NM (Romex). The physical and electrical characteristics allow for direct burial in the ground. The individual conductors are covered with insulation and the entire cable has an outer sheath of plastic insulation that protects the cable from moisture, fungus, corrosion, and is flame retardant. In residential wiring the cable would be used to feed outside lighting and out-buildings.

Flexible Cords And Cables

Portable and flexible cords are a broad category of conductors from #27 to #2 encased in a wide variety of non-metallic coverings. This category includes lamp and portable appliance cords for which RACO does not offer connectors. RACO offers a line of liquid-tight strain relief connectors for the portable cords used in industrial applications. These cords are popular because of convenience and flexibility of operation. Like all non-metallic cables, they must be used where they are not subject to mechanical abuse. They can be used as pendants and fixture wiring in plants. Non-metallic cords and cables also prevent the transmission of noise or vibration. They may not substitute for the final wiring of a structure (rigid/IMC and EMT) by being attached to building surfaces, or be concealed in walls or ceilings.

Non-Metallic Liquid-Tight Type CN & LNM

A flexible wiring conduit designed primarily for use on machine tools and other heavy equipment for protection against abrasion and physical damage, connections on moving heads and other components, protection of critical wiring from destructive oils, and console and remote control wiring. Available in trade sizes 3/8" to 2". CN Sealtite® has a smooth inner core, nylon reinforcing with a rugged outer jacket. Type LNM Liquatite® is constructed of two layers of specially formulated material, permanently bonded together and reinforced with braided cords.

Liquid-Tight Flexible Non-Metallic Conduit (NMLT)

Liquid-tight flexible non-metallic conduit is a raceway of circular cross section having a smooth inner surface with integral reinforcement within the conduit wall. This conduit is flame resistant and is approved for the installation of electrical conductors when used with the proper electrical fittings. NMLT shall be permitted to be used in exposed locations, where flexibility is required for installation, operation, or maintenance, and where protection is required from vapors, liquids, or solids. NMLT is used extensively in the machine tool and related industries. NMLT should never be used where it may be subject to physical damage. Available trade sizes are 3/8" to 2" and its use is limited to 6 feet in length.

ENMT- Electrical Non-Metallic Tubing

Electrical non-metallic tubing is a rigid corrugated raceway of circular cross-section with integral or associated couplings, connectors and fittings approved for the installation of electrical conductors. It is composed of a material that is resistant to moisture, chemical atmospheres, and is flame retardant. Tubing smaller than 1/2" electrical trade size or larger than 1" shall not be used.

Liquid-Tight Flexible Metal Conduit

Liquid-tight flexible metal conduit is Flexible metal conduit with a plastic outer jacket that protects the electrical system against moisture, dust, cutting oils, and it offers good mechanical protection as well. It may also be used in selected hazardous locations. It is available in trade sizes of 3/8" to 6" and must be supported every 4-1/2 feet and within 12 inches of the box or enclosure. Support exceptions are old work applications and lengths not more than three feet where flexibility is required. The raceway may be used as the ground path in trade sizes up to 1-1/4". Trade sizes 1-1/2" and larger in lengths over 6 feet require a separate grounding conductor.



CONCRETE-TIGHT, RAIN-TIGHT, WATER-TIGHT and LIQUID-TIGHT

Many RACO connectors and couplings are approved for use outdoors, imbedded in concrete, and on industrial machinery where cutting oils could enter the electrical system. They are designed to prevent the entry of smoke, dust, dirt, or grime in other applications. These uses are quite separate and distinct from the hazardous location criteria.

- **Concrete-tight** couplings and connectors pass a UL test before receiving this approval. Generally compression type and set screw type fittings for Rigid/IMC and EMT fit this category. Machine steel, die cast zinc, or aluminum fittings may qualify for this listing, however, the test does not relate to the durability of the material. On most concrete deck jobs, the concrete can enter the conduit through the fittings and, once it sets, blocks the pulling of wires. To insure this costly problem does not occur, most electrical contractors tape the connectors and stuff the boxes with removable material. UL now requires that labels identify this as "concrete-tight when taped". An alternative would be to use more expensive boxes and fittings.
- **Rain-tight** couplings and connectors must pass a UL test that "keeps out beating rain." However, the test does not relate to durability of material. Malleable iron, steel, and die cast zinc fittings qualify for this approval. Rain-tight also has been referred to as "suitable for wet locations."
- **Water-tight** is a term applied to RACO service entrance connectors with a rubberized grommet that is intended to keep rain out of the electrical system. In this context, the term is synonymous with "rain-tight." The connectors are not intended for submersion. Again, durability of material is not a criteria.
- **Liquid-tight** is a term applied to conduit and fittings that keep cutting oils, moisture, and grime out of electrical connectors on industrial machinery. The plastic sealing rings and neoprene grommets of RACO connectors will not break down under corrosive elements.

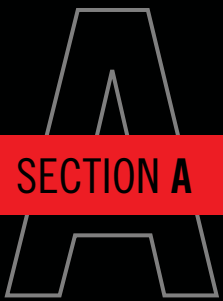

SECTION A

WEATHERPROOF BOXES

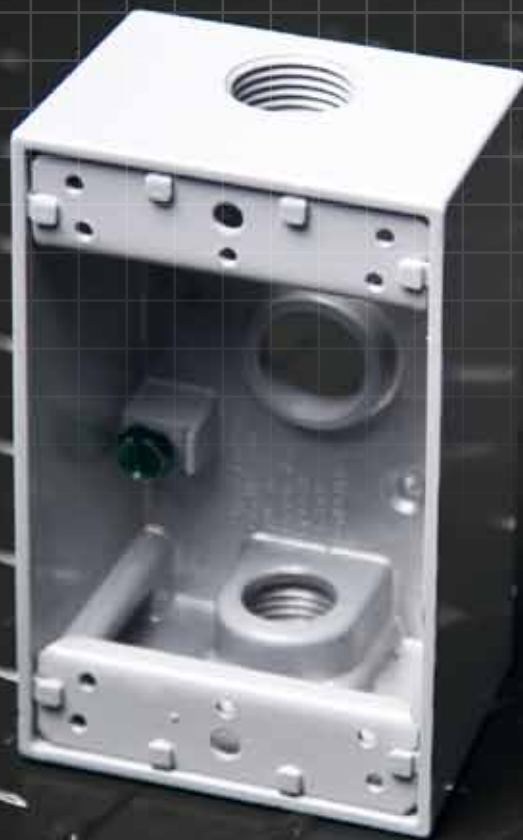

WEATHERPROOF BOXES

General Information

- Made of die cast aluminum in a one piece, seamless construction
- Electrostatic baked epoxy enamel paint provides corrosion protection
- Threaded conduit hubs for a weatherproof connection.
- Detachable mounting lugs provide the end user with 8 mounting options (except round box)
- Boxes are tapered to allow water run-off.
- Available in 1, 2, 3 gang and round with various hole configurations/sizes.
- Ground screw installed
- NEMA 3R Rated
- UL Listed File E195978
- CSA Approved C22.2 No. 18

Box Mount Holes

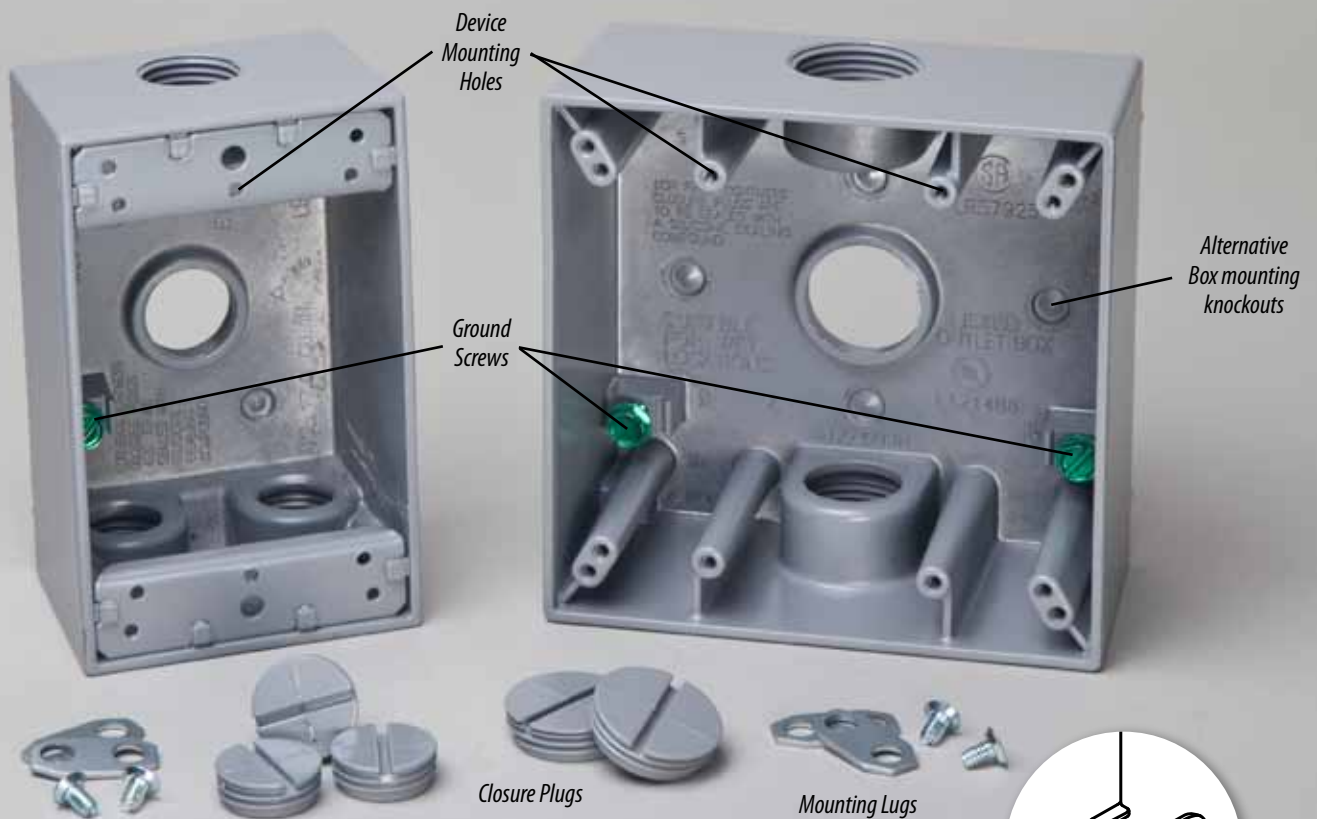

Mounting lugs install with self-tapping screws on back corner of box



Single Gang Boxes

1-gang boxes are used in branch circuit wiring as junction boxes or device boxes for housing receptacles, switches and GFCI's. Deeper boxes are more commonly used when additional box fill capacity is needed especially when using a GFCI. They can also be used with BELL® rectangular cluster covers and single gang lampholder combinations for weatherproof outdoor security and utility lighting.

2" Deep - Metallic

- 18.3 cu. in. capacity
- Three, four or five hubs - 1/2" or 3/4"
- Contains 2 closure plugs
- 2 "knock-out" mounting holes on the back of the box
- All available in gray, some configurations available in white and bronze



5320-0



5385-0

2 -5/8" Deep - Metallic

- 20.5 cu. in. capacity
- Three hubs - 1/2" or 3/4"
- Contains 2 closure plugs
- 2 "knock-out" mounting holes on the back of the box
- All available in gray

2" Deep - Non- Metallic

- 16.5 cu. in. capacity
- Three hubs - 1/2" or 3/4"
- Contains 2 closure plugs and 3 reducing bushings
- 4 molded mounting lugs
- All available in gray or white
- UL Marine Listed



PSB37550GY



Tip: Weatherproof boxes cannot be installed directly into wet cement. Recommend using either a steel masonry box or apply tar to the outside of the box to keep the cement from corroding the box.

Two Gang Boxes

2-gang boxes are used in branch circuit wiring as junction boxes or device boxes for housing 2 receptacles, switches or GFCI's, or larger single receptacles. Deeper boxes are more commonly used when additional box fill capacity is needed especially when using (2) GFCI's.

2" Deep - Metallic

- 31.0 cu. in. capacity (may vary depending on configuration 30.2 min)
- Three, four, five or seven hubs - 1/2" & 3/4"
- Contains 2 closure plugs
- 4 "knock-out" mounting holes on the back of the box
- All available in gray, some configurations available in white and bronze



5333-0



5337-0



5388-0

2-5/8" Deep - Metallic

- 36.0 cu. in. capacity
- Five hubs - 3/4" or 1"
- Contains 2 closure plugs
- 4 "knock-out" mounting holes on the back of the box
- All available in gray

2" Deep - Non-Metallic

- 26.5 cu. in. capacity
- Seven hubs - 1/2" & 3/4"
- Contains 6 closure plugs and 7 reducing bushings
- 4 molded mounting lugs
- All available in gray or white
- UL Marine Listed



PDB77550GY



Three Gang Boxes

3-gang boxes are commonly used in branch wiring as junction boxes or device boxes for housing 3 receptacles, switches or GFCI's.

2-5/8" Deep - Metallic

- 55.0 cu. in. capacity
- Seven hubs - 3/4"
- Contains 4 closure plugs
- 2 "knock-out" mounting holes on the back of the box
- All available in gray



5390-0





4" Round Splice Boxes

Round outlet boxes are typically used in branch circuit wiring as junction boxes or may be used with BELL® round cluster covers and round lamp holder combinations for weatherproof outdoor security and utility lighting

1-1/2" Deep - Metallic

- 16.0 cu. in. capacity
- Five hubs - 1/2" or 3/4"
- Contains 4 closure plugs
- All available in gray, some configurations available in white and bronze



5361-0

1-1/8" Deep - Non-Metallic

- 13.5 cu. in. capacity
- Five hubs - 1/2" and 3/4"
- Contains 4 closure plugs and 5 reducing bushings
- Attached mounting lugs
- All available in gray and white



PRB57550G



B

SECTION B

WEATHERPROOF BOX EXTENSIONS & ADAPTERS



WEATHERPROOF BOX EXTENSIONS & ADAPTERS

General Information

- Made of die cast aluminum in a one piece, seamless construction
- Electrostatic baked epoxy enamel paint provides corrosion protection
- Threaded conduit hubs for a weatherproof connection.
- Available in 1, 2 gang and round.
- NEMA 3R Rated
- UL Listed File E195978
- CSA Approved C22.2 No. 18

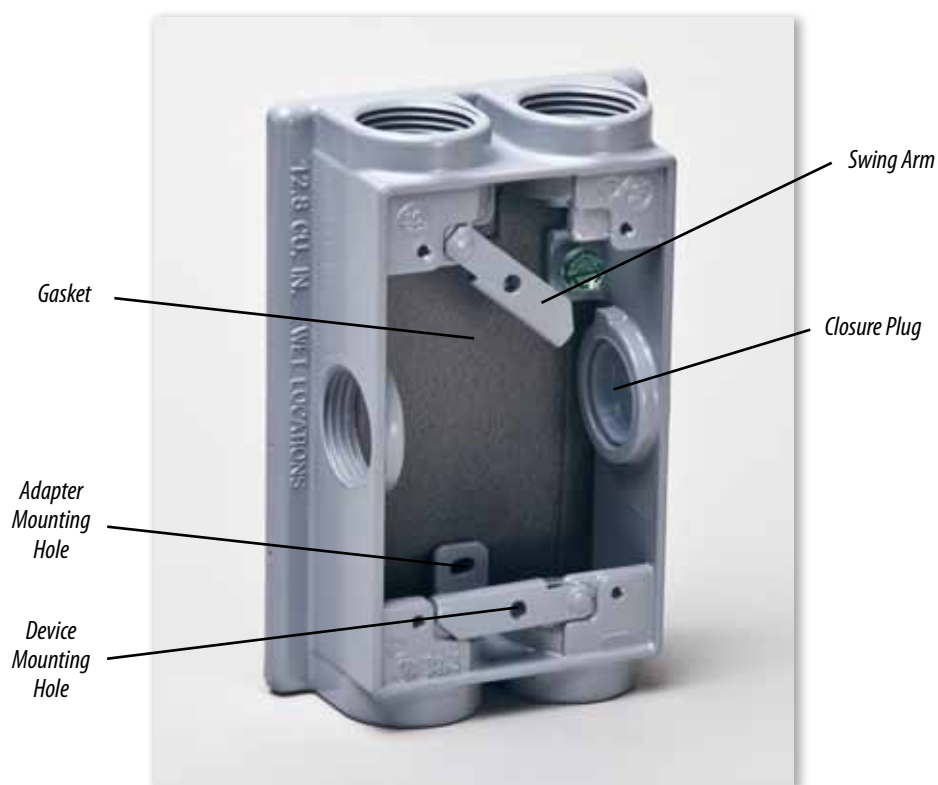

Tip: *Unique swing arm feature speeds up installation. Rotates to avoid obstruction when mounting the adapter to the box, then rotates back for device installation.*

Single Gang Extensions & Adapters

1-gang extensions and adapters are typically used when additional box fill capacity is needed, or when adding GFCI receptacles. Adapters are also used in branch wiring when "take-offs" are added for additional boxes/devices.

1" Deep Extension - Metallic

- 9.5 cu. in. capacity
- No Ground Screw
- No Threaded Hubs
- Available in Gray



5406-0

1-1/2" Deep Adapter - Metallic

- 11.0 cu. in. capacity (may vary depending on configuration 9.5 min)
- Available with either 2 or 6 threaded hubs 1/2" or 3/4"
- Contains Closure plugs (2 hole – 1 plug, 6 hole – 3 plugs)
- Available in Gray



5400-0

1-1/2" Deep Swing Arm Adapter - Metallic

- 13.8 cu. in. capacity (may vary depending on configuration 12.8 min)
- Swing arm speeds installation
- Available with either 2 or 6 threaded hubs 1/2" or 3/4"
- Contains Closure plugs (2 hole – 1 plug, 6 hole – 3 plugs)
- Available in Gray



5414-0



Two Gang Extensions

2-gang extension are typically used when additional box fill capacity is needed, or when adding GFCI receptacles.

1-1/32" Deep Extension - Metallic

- 16 cu. in. capacity
- No Ground Screw
- No Threaded Hubs
- Available in Gray



5406-0

4" Round Extension Adapter

Used in branch wiring when "take-offs" are added for additional boxes/devices or when additional box fill capacity is needed.

- 16.3 cu. in. capacity
- 1-1/2" Deep
- Four hubs – 1/2"
- Contains 4 closure plugs
- No Ground Screw



5363-0



SECTION C

WEATHERPROOF COVERS



Blank Covers

Provide a weatherproof barrier for junction boxes. These covers are available in one, two, three gang and round. All covers are made of high quality metal and coated with a state of the art powder coat. Each cover comes with a gasket and mounting hardware.

General Information

- Rugged metallic construction (Metallic)
- Powder coat finish (Metallic)
- High impact polycarbonate construction (Non-Metallic)
- Includes Installation hardware and gasket



Single Gang - Uses Device Mounting Holes – Metallic

- All available in gray, white and bronze

Single Gang - Box Mount – Metallic

- All available in gray

Two Gang - Box Mount – Metallic

- All available in gray, white and bronze

Three Gang –Box Mount – Metallic

- All available in gray

4" Round - Box Mount - Metallic

- All available in gray

One Gang –Box Mount – Non-Metallic

- All available in gray and white

Two Gang –Box Mount – Non-Metallic

- All available in gray and white

4" Round –Box Mount – Non-Metallic

- All available in gray and white



RAYNTITE® Flip Covers

Provide weatherproof protection for outdoor receptacles. These were specifically designed with a hooded cover to protect the device on 3 sides and constructed from die cast aluminum and coated with a state of the art powder coat. They are self closing covers using stainless steel springs.



General Information

- 4 knockouts for box mounting
- Vertical and 2 gang are pad-lockable with ¼" diameter hole
- Single Gang (vertical & horizontal) and Two Gang available
- Various configurations including GFCI, duplex, toggle and round

Single Gang – Vertical Mount – Metallic

- Available as Duplex, GFCI, 1.406", 1.593", 1.710" or 2.150" dia.
- All available in gray, some configurations available in white



5028-0

Single Gang – Horizontal Mount – Metallic

- Available as Duplex or GFCI
- All available in gray, some configurations available in white



5001-0

Two Gang – Vertical Mount – Metallic

- Various configurations available
- All available in gray, some configurations available in white



5001-0



Multi-Configuration Flip Covers

These covers provide weatherproof protection for outdoor receptacles. These were specifically designed with universal plates that fit nearly any receptacle. Patented Quick-Fit™ keyhole mounting system allows cover to be installed in under a minute. They are made of heavy duty die-cast metal with a premium powder coat finish. All covers have 4 drill holes for box mounting.

Single Gang – Vertical – Metallic

- Horizontal or vertical mount
- 12 in 1 configurations
- All available in gray, white and bronze



MX1250S

Single Gang – Horizontal – Metallic

- Horizontal or vertical mount
- 12 in 1 configurations
- All available in gray, white and bronze

Two Gang – Vertical – Metallic

- 25 in 1 configurations
- All available in gray, white and bronze



MX2050S

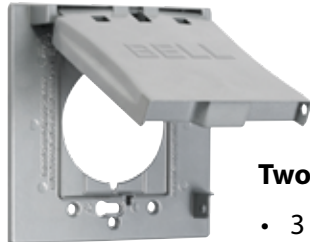

MX2150S

Two Gang – Single Device – Metallic

- 3 in 1 configurations (2-1/4 dia, Duplex or GFCI)
- All available in gray

Three Gang – Vertical – Metallic

- 12 in 1 configurations
- All available in gray



MX3050S



Tips: No need to have all the different configurations, stock 1 cover for all the applications.

Self closing spring allows for vertical or horizontal mount.

Lockable with a 3/16" diameter (shackle) padlock

Snap Lid Covers

Also called flip covers, these provide weatherproof protection for outdoor receptacles. The covers are rugged metallic construction and coated with a state of the art powder coat. All covers are self closing.

Single Gang – Vertical Mount – Metallic

- Device and box mount available
- Duplex, GFCI, and 1.406" dia. available
- All available in gray, some configurations available in white and bronze



5146-0



5180-0

Single Gang – Horizontal Mount – Metallic

- Device and box mount available
- Duplex, GFCI, 1.406" dia., and 1.6" motor plug available
- All available in gray, some configurations available in white and bronze



5148-0



5097-0

Two Gang – Vertical Mount – Metallic

- Device and box mount available
- Various combinations of Duplex, 1.406" dia. or GFCI
- All available in gray, some configurations available in white and bronze

Three Gang – Vertical Mount – Metallic

- Box mount
- (3) Duplex or (3) 1.406" Dia available
- All available in gray



Non-Metallic While-in-Use Bubble Covers

This type of cover is typically used whenever weatherproof protection is required while an outlet is in use. Patented Quick-Fit™ keyhole mounting system allows cover to be installed in under a minute. Pre-configured for GFCI with patented Knock-Out™ technology for alternate devices. They are constructed of high-impact polycarbonate.

Single Gang – Horizontal/Vertical Mount

- Depths 2.75" to 4.75"
- 16 in 1 configurations
- Available in Clear, White, & Gray

Single Gang – Extra Duty – Horizontal/Vertical Mount

- Depths 2.75" to 4.75"
- 16 in 1 configurations
- Available in Clear or Gray



MM410C



MM420C

Tips: Alternate hinge locations allows for horizontal or vertical mount.
All lockable with 1/8" diameter (shackle) padlock while the MM420 accepts up to a 1/4" diameter.

Two Gang – Vertical Mount

- Depths 2.75" to 4.75"
- 55 in 1 configurations
- Available in Clear or Gray



MM2410C

Two Gang – Extra Duty – Vertical Mount

- Depths 2.75"
- 55 in 1 configurations
- Available in Clear or Gray



MM2420C



Non-Metallic Low Profile While-in-Use Covers

Used whenever weatherproof protection is required while an outlet is in use with the ability to contract the cover when not in use. Patented Quick-Fit™ keyhole mounting system allows cover to be installed in under a minute. Pre-configured for GFCI with patented Knock-Out™ technology for alternate devices. They are constructed of high-impact polycarbonate construction. The patented low profile design expands from 1" to 3" when the cover is in use.

Single Gang – Horizontal/Vertical Mount

- 16 in 1 configurations
- Available in Gray, White & Bronze



Single Gang – Extra Duty – Horizontal/Vertical Mount

- 16 in 1 configurations
- Available in Gray, White & Bronze

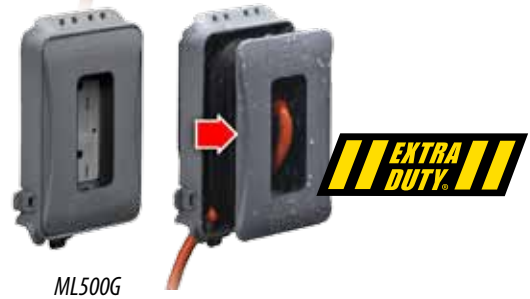

Two Gang – Vertical Mount

- 55 in 1 configurations
- Available in Gray



Two Gang – Extra Duty – Vertical Mount

- 55 in 1 configurations
- Available in Gray



Tips: Corner cord port location and self closing spring allow for horizontal or vertical mounting of single gang covers.



Non-Metallic Flat Covers

Typically used whenever weatherproof protection is required for outdoor receptacles or switches. Unlike while-is-use covers, flat covers are not weatherproof when leaving a cord plugged in. Patented Quick-Fit™ keyhole mounting system allows cover to be installed in under a minute. Base technology with patented Knock-Out™ technology for custom fit. Constructed of high-impact polycarbonate construction.

Single Gang – Horizontal/Vertical Mount

- 16 in 1 configurations
- Available in Clear, White, & Gray



MM110C

Two Gang – Vertical Mount

- 55 in 1 configurations
- Available in Clear, White, & Gray



MM1410G



Tips: Alternate hinge location on 1-gang cover allows for horizontal or vertical mount.

Lockable with 1/8" diameter (shackle) padlock.

Metallic While-in-Use Covers

Used where weatherproof protection is required while an outlet is in use. Patented Quick-Fit™ keyhole mounting system allows cover to be installed in under a minute. Pre-configured for GFCI with patented Knock-Out™ technology for alternate devices. They are constructed of heavy duty die-cast metal. All covers are Extra Duty rate and 3-1/2" deep.



Single Gang – Vertical Mount

- 8 in 1 configurations
- Available in Gray



MX3200



MX3300

Single Gang – Horizontal Mount

- 8 in 1 configurations
- Available in Gray

Two Gang – Vertical Mount

- 55 in 1 configurations
- Available in Gray



MX6200

Tips: Lockable with standard 3/8" diameter (shackle) padlock.





Metallic Low Profile While-in-Use Covers

Typically used whenever weatherproof protection is required while and outlet is in use. Patented Quick-Fit™ keyhole mounting system allows cover to be installed in under a minute. Pre-configured for GFCI with patented Knock-Out™ technology for alternate devices. They are constructed of high-impact polycarbonate construction. All covers are Extra Duty rated.



Single Gang – Vertical Mount

- 2" to 3-1/2" Deep
- 8 in 1 configurations
- Available in Gray, White and Bronze



MX4280S



MX4380S

Single Gang – Horizontal Mount

- 2" to 3-1/2" Deep
- 8 in 1 configurations
- Available in Gray

Single Gang – Vertical Mount - Deep

- 2-1/2" to 4-1/2" Deep
- 8 in 1 configurations
- Available in Gray



MX5280S



MX7280S

Two Gang – Vertical Mount

- 2" to 3-1/2" Deep
- 55 in 1 configurations
- Available in Gray



Tips: Lockable with standard 3/8" diameter (shackle) padlock.

Locking tab swivels out 180° so cover can also be locked in the expanded (while-in-use) position.

Toggle Switch Covers

Provide convenient weatherproof protection for “on-off” type switches. The covers are rugged metallic construction and coated with a state of the art powder coat.

Single Gang – Vertical Mount

- Single Pole 125V, 15A
- Device included
- Available in Gray, White and Bronze



5121-0



5124-0

Two Gang – Device Mount

- Single Pole 125V, 15A
- Devices included
- Cover only available (5125-0)
- Available in Gray



5166-0

Two Gang – Toggle and Outlet Combo

- Single Pole 125V, 15A & Duplex
- Toggle & GFCI Cover only available (5167-0)
- Cover only available (5125-0)
- Available in Gray

Three Gang – Device Mount

- Single Pole 125V, 15A
- Devices included
- Available in Gray



5126-0

Toggle Switch

- Single Pole 125V, 15A



5201-0



Tips: includes spacing ferrule to fit any standard toggle switch.
Remove strap ears on the switch prior to installation.

Non-Metallic Toggle Switch Covers

Used wherever weatherproof protection is required for an "on-off" type switch. The covers are made from high impact polycarbonate construction. All covers have the gasket attached.

Single Gang – Device Mount

- Available in Gray & White



PTC100GY



PTC200GY

Two Gang – Device Mount

- Available in Gray



PTC521GY

Two Gang – Toggle and GFCI Combo

- Available in Gray & White



Cluster Covers

Commonly used to mount BELL® lamp holders for outdoor security and utility lighting. The covers are rugged metallic construction and coated with a state of the art powder coat.

- Single Gang and 4" Round
- One hole or three holes
- 1/2" threaded outlets
- Closure plugs included with three hole covers



5186-0

Rectangular 1 Hole

- 1/2" threaded outlet
- Available in Gray, White and Bronze

Rectangular 3 Hole

- 1/2" threaded outlet
- Two closure plugs included
- Available in Gray, White and Bronze



5189-0



5193-0

4" Round 1 Hole

- 1/2" threaded outlet
- Available in Gray, White and Bronze

4" Round 3 Hole

- 1/2" threaded outlet
- Two closure plugs included
- Available in Gray, White and Bronze



5197-0

D

SECTION D

WEATHERPROOF LIGHTING AND ACCESSORIES



WEATHERPROOF LIGHTING

Lampholders

Typically mount to BELL cluster covers or boxes for outdoor security and utility lighting. The lampholders are rugged metallic construction and coated with a state of the art powder coat.

Standard 75-150W Par 38

- Locking swivel knuckle for positioning
- Extra long leads with porcelain socket
- Internal or external gasket options
- Available in Gray, White and Bronze



5606-0

Swivel 75-150W Par 38

- Swivel joint for easy positioning
- Extra long leads with porcelain socket
- External gasket options
- Available in Gray, White and Bronze



LTS100S

Swivel 75W Halogen

- Swivel joint for easy positioning
- Extra long leads with porcelain socket
- Last up to 3 time longer w/ 50% more light
- Available in Gray, White and Bronze



LHS100S

Swivel 1000 Lumens (13W) LED

- Swivel joint for easy positioning
- 80% Less Energy Consumption
- Long Life: 50,000 Hours
- Even Light Distribution
- Available in Gray, White and Bronze



LL1000S



Bullet Lampholder

Typically used to mount to BELL boxes for outdoor accent lighting. The lampholder is a rugged metallic construction and coated with a state of the art powder coat.

Standard 75-150W PAR 38 or R-40

- Locking swivel knuckle for positioning
- Extra long leads with porcelain socket
- Available in Green



Portable Lampholders

Primarily used for temporary outdoor accent lighting. The lampholders are a rugged metallic construction and coated with a state of the art powder coat.

Spike Light 75-150W PAR 38

- Locking swivel knuckle for positioning
- 9 inch or 6 feet cord options
- Available in Bronze (9") or Gray (6')



SL101B

LED Spike Light

- Locking swivel knuckle for positioning
- 6.5 watts / 350 lumens
- 9" cord
- Available in Bronze



SPLED2Z



Tier Garden Lights

Used outdoors for accent lighting along walkways, driveways, terraces, porches and garden areas. These lights are constructed from rugged die cast aluminum and coated with a state of the art powder coat.

3-Tier Garden Light

- 40W max lamp
- Screw in clear glass globe
- Available in Green



5884-8



5893-8

4-Tier Garden Light

- 60W max lamp
- Screw in clear glass globe
- Available in Green

Photocells

Used for darkness activated automatic control of night lighting from dusk to dawn. Switch may be used to control porch lights, garden lights, post lanterns, barn lights, loading dock lights, outdoor signs and the like. Built in delay prevents operation triggered by auto headlamps or other temporary light flashes.

Internal

- 1000 watt rated
- Fits 1/2" hole
- Available in black



PE100

External

- Swivel Knuckle, locknut
- 2000 watt rated
- Fits 1/2" hole
- 1800VA Ballast
- 120V 50-60HZ
- Available in Gray



5638-5



WEATHERPROOF ACCESSORIES

Weatherproof Accessories are used in conjunction with weatherproof boxes, extensions and lighting.

Closure Plugs

- Available in Gray, White or Bronze
- Sold in bags of 4, cards of 3 or bulk of 1000



5269-0



5302-0

Box Mounting Lugs

- Includes lugs and screws
- Sold in bags of 2

Replacement Gaskets

- Available 1 Gang, 2 Gang & 1 Gang w/ 4 lampholder gaskets
- Gasket has cutouts for toggle, duplex, GFCI, & 1.406" round



5611-0

Lampholder Gaskets

- Replacement gasket for 5612-0
- Outer Gasket

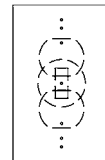

5019-0

Garden Lamp Globes

- 3-Tier and 4-Tier
- Screw in



5694-0



PRBA400G

Round Box Adapter

- Allows 1G device cover to fit round box
- Available in Gray

Metal Spike

- 9" die cast metal
- Fits 1/2" hole
- Available in silver



SG100S



PRODUCT/PACKAGING REFERENCE

Multiple Configurations

Device covers often include adapter plate(s) that allow the cover to be configured to fit various devices and orientations (horizontal/vertical). Below are some of the common multiple configurations

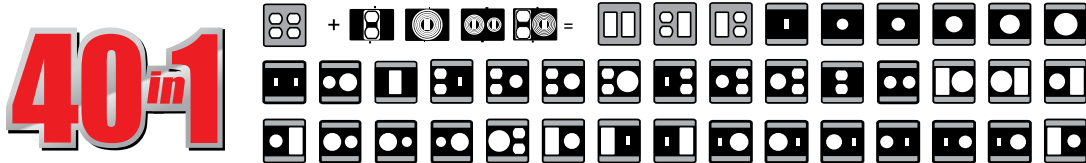
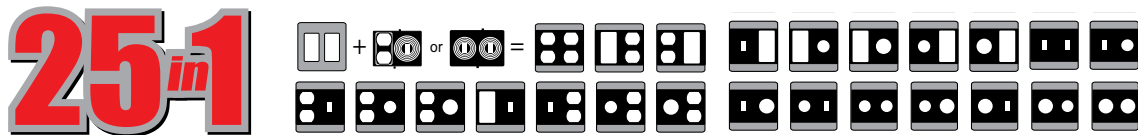
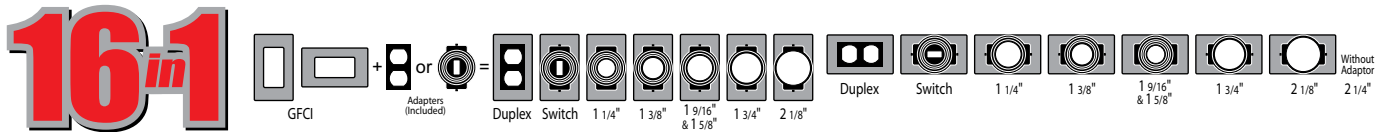
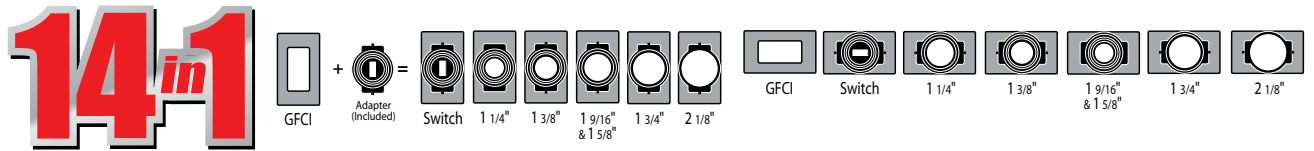
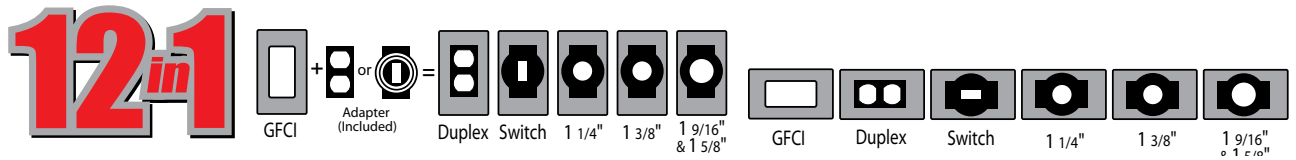

Multiple combinations of duplex, GFCI, switch and rounds: 1-3/8", 1-5/8", 1-3/4", 2-1/4", 2-5/8"

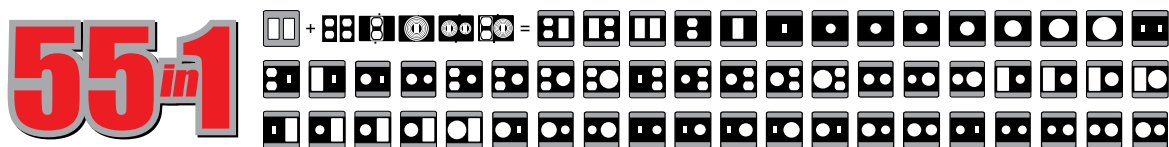

Multiple combinations of duplex, GFCI, switch, and rounds: 1-1/4", 1-3/8", 1-9/16", 1-5/8", 1-11/16", 1-3/4", 2-1/8", 2-1/4", 2-7/16"



Quick-Fit™ Keyhole Mounting System – Allows for easier and faster installation.



Knock-Out™ Technology – Plates allow for custom fitting.

BELL and TayMac Packaging / Color Nomenclature

SUFFIX	COLOR	PACKAGING
-0	Gray	Shrink
-1	White	Shrink
-2	Bronze	Shrink
-5	Gray	Carded
-6	White	Carded
-7	Bronze	Carded
-8	Green	Boxed
-9	Gray	Bulk
-10	Bronze	Bulk
C	Clear	Shrink
CW	White/Clear	Shrink
G	Gray	Shrink
W/WH	White	Shrink
S	Silver/Gray	Shrink
Z	Bronze	Varies
B	Bronze	Clamshell



Example of the gray callout on packaging for product with three color options

GLOSSARY

A

AMP (A) – a measurement of the amount of electrical current in a circuit at any moment.

ARMOR – a metallic covering around the cable for mechanical protection. Typically interlocked steel or aluminum.

B

BELL BOX – a Hubbell Inc. trade name for the BELL® brand of weatherproof boxes.

BOX EXTENSION – see extension ring.

BOX MOUNT – a term commonly used to denote where the screws of a cover attach.

C

CSA – see Canadian Standards Association.

CABLE – two or more insulated conductors wrapped in metal or plastic sheathing.

CANADIAN STANDARDS ASSOCIATION (CSA) – an independent testing agency that certifies products to its established standards of safety and performance.

CIRCUIT – the path of electrical flow from a power source through an outlet and back to ground.

CODE GUARD® – RACO trademark for weatherproof cover and Hubbell WRTR device.

CONDUCTOR FILL – refers to the number of current carrying and grounding conductors permitted by the National Electrical Code (NEC) to be used in conduit and tubing.

CONDUCTORS – electrical term describing wires capable of carrying an electrical current or wire being used as a ground, usually sheathed with an insulating material.

CONDUIT – (raceway) a pipe or tube designed to enclose and protect conductors or cables from moisture and physical damage.

CONDUIT BODY – a portion of a conduit or tubing system that provides access through a removable cover(s) to the interior of the system at a junction of two or more sections of the system or at a terminal point of the system.

CONDUIT CLAMP – a fastening clamp used to mount raceways.

CONDUIT HANGER – a fastening means used to support conduit.

CONDULET – a term used to refer to malleable or aluminum conduit bodies.

D

DAMP LOCATION – partially protected locations such as under canopies or roofed open porches, and interior locations subject to moderate degrees of moisture, such as basements, barns, and cold-storage warehouses.

DEVICE EARS – ears or tabs with holes spaced to accommodate wiring devices. Device ears are found on plaster rings, switch boxes and handy boxes.

DEVICE MOUNT – a term commonly used to denote where the screws of a device cover attach.

DUPLEX RECEPTACLE – Electrical outlet device having two plug receptacles.

E

ELECTRICAL METALLIC TUBING (EMT OR THINWALL) – conduit called thinwall as a contrast to the “heavywall” of rigid or IMC.

ELECTRICAL NONMETALLIC TUBING (ENT) – a plastic corrugated raceway of circular cross section that is resistant to moisture and chemical atmospheres, and that is flame retardant.

EMT – see electrical metallic tubing.

END RUN – that portion of the branch circuit that extends to the last fixture or device.

ETL – certification mark for Intertek Testing Services. ITS tests to the standards of UL, CSA and other international standards.

EXTENSION RING – used to extend the box when it is recessed back in a wall. Also provides more cubic inch capacity for the box if needed.

EXTRA DUTY – a name applied to weatherproof while-in-use covers that have passed UL testing and are listed as “Extra-Duty”.

F

FIXTURE – a lighting assembly that is permanently attached to a building’s wiring system, usually to a ceiling box.

FIXTURE EARS – ears or tabs with holes in them spaced 2- 3/4" or 3- 1/2" apart to accommodate lighting fixtures.

FLEX – see flexible metal conduit.

FLEXIBLE ARMORED CABLE (BX) – commonly called BX, a manufacturer’s trade name. It may be described as prewired flexible metallic conduit since it includes two or more current carrying conductors and can be supplied with a grounding conductor.

FLEXIBLE METAL CONDUIT (GREENFIELD OR FLEX) – frequently called “Greenfield,” which is the trade name of one manufacturer of this flexible steel or aluminum raceway. It is used around machinery where vibration or movement exists or where complex routing of the raceway dictates a flexible conduit.

FORM 7 – a style of conduit body that requires a clip cover.

FORM 8 – an “expanded volume” style of conduit body that requires a two screw cover.

FORM 35 – a style of conduit body that requires a two screw cover.

FURRING STRIPS – small wood strips attached to an existing wall to provide a means to attach paneling or drywall.

G

GFCI – see Ground Fault Circuit Interrupter. **GANGABLE** – box with a side that can be removed to allow the attachment of another box for installation of multiple devices.

GAUGE – a term used to describe the physical size of a wire.

GROUND – a conducting connection between an electrical circuit or equipment and the earth, or to some conducting body that serves in place of the earth. Neutral wires carry the current to ground in all circuits. An additional grounding wire, or the sheathing of metal clad cable or conduit, protects against shock from a malfunctioning tool or other device.

GROUND FAULT CIRCUIT INTERRUPTER (GFCI) – a safety device that senses shock hazard and automatically stops electrical flow in a circuit.

GROUND SCREW – a UL listed screw used to secure a grounding conductor to an enclosure.

H

HAZARDOUS LOCATIONS – are those locations where fire or explosion hazards may exist due to flammable gases or vapors, flammable liquids, combustible dust, or ignitable fibers or flyings.

HEAVYWALL – see rigid metal conduit.

I

I.D. – inside diameter.

IMC – see intermediate metal conduit.

INSULATION – sheathing or jacket of nonconducting material used to cover wires.

INTERMEDIATE METAL CONDUIT (IMC) – a lighter weight, more economical version of rigid metal conduit. It has the same outside diameter (O.D.) with a thinner wall.

J

JOIST – horizontal beams that extend from wall to wall and support the floor or ceiling – typically 2" x 10", 2" x 8" or 2" x 6".

JUNCTION BOX – an enclosure used for splitting circuits into different branches. In a junction box, wires connect only to each other, never to a switch, receptacle, or fixture.

K

KILOWATT (KW) – one thousand watts, kilowatt measures power.

KILOWATT-HOUR – the standard measure of electrical consumption or energy.

KO (KNOCKOUT) – a circular tab on the side or bottom of a box pushed back in place with a small piece of steel remaining uncut to hold the tab in place until it is removed for installation of conduit or a connector.

L

LAMPHOLDER – a current carrying device used to support, illuminate and protect lamps.

LIQUIDTIGHT FLEXIBLE METAL CONDUIT – flexible metal conduit with a plastic outer jacket that protects the electrical system against sunlight, liquids, vapors or solids.

LIQUIDTIGHT FLEXIBLE NONMETALLIC CONDUIT (NMLT) – liquidtight flexible nonmetal conduit is a raceway of circular cross section having a smooth inner surface with integral reinforcement within the conduit wall.

LOAD BEARING – walls that are an integral part of the structure that supports the joists.

LOCKNUT – an internally threaded barbed nut for use on conduit or fittings to prevent turning and to provide a secure joint.

LUG – see ground lug.

M

MC CABLE – metal clad cable. A UL classification indicating an assembly of insulated conductors with a metal cladding applied over the core and with grounding conductor(s) if the cladding is interlocked armor.

MOUNTING EARS – ears on a box which are used to mount a box cover, device or fixture.

N

NEC – see National Electrical Code.

NEMA – National Electrical Manufacturer's Association.

NM – see nonmetallic sheathed cable.

NATIONAL ELECTRICAL CODE (NEC) – a set of rules governing safe wiring methods drafted by the National Fire Protection Association. Local codes sometimes differ from and take precedence over NEC requirements.

NEUTRAL WIRE – a grounded conductor that completes a circuit by providing a return path to the source. Neutral wires are always identified by white or gray insulation.

NIPPLE – an externally threaded fitting intended primarily to serve as a short raceway between close-spaced enclosures.

NONMETALLIC SHEATHED CABLE (ROMEX®) – nonmetallic sheathed cable, popularly called by a manufacturer's trade name of Romex, is two or more insulated conductors, usually copper, protected by an outer jacket or sheath of nonmetallic material.

NMLT – see liquidtight flexible nonmetallic conduit.

O

O.D. – outside diameter (of conduit, etc.).

OUTLET – anything that allows access to the wiring system (eg., box, conduit body, etc).

P

PLUG – a threaded means used to close unused threaded openings.

Q

QUICK-FIT™ – Keyhole mounting system.

R

RACE WAY – enclosed channel designed expressly for holding wire or cables. Conduit is a raceway; so is a duct.

RAINTIGHT – constructed so as to pass the UL rain test.

RAYNGUARD™ – RACO® trademark for extra duty weatherproof proof metallic while in use cover.

RAYNTITE® – RACO® trademark for weatherproof device cover approved for use in wet locations.

RIGID – see rigid metal conduit.

RIGID METAL CONDUIT (RIGID OR HEAVYWALL) – rigid metal conduit is a raceway that provides a high degree of mechanical protection indoors or out, in dry or wet locations, exposed or concealed, in all kinds of atmospheric conditions, locations, and in hazardous locations such as explosion proof, vapor tight and dust tight.

RIGID NONMETALLIC CONDUIT – three types of rigid nonmetallic conduit are listed by UL: (1) rigid nonmetallic plastic Schedule 40 and 80 PVC; (2) rigid nonmetallic underground plastic; and (3) rigid nonmetallic underground other than plastic, fiber type.

S

SEALTITE® – A registered trademark used to refer to liquidtight metallic conduit and fittings.

SERVICE DROP – service entrance conductors from the utility pole to the service entrance conductors of a building that has overhead service. The utility company usually supplies and connects the service drop.

SERVICE ENTRANCE – the point at which electrical service enters a building

SERVICE ENTRANCE CABLE (SE) – service entrance cable can be compared to nonmetallic sheathed cable (Romex®) in large conductor sizes, with a weatherproof nonmetallic outer covering. It is often encased by rigid, IMC or EMT conduit for additional protection.

SERVICE-ENTRANCE HEAD – an enclosed fitting intended for use at service entrances where open wiring is connected to a service-entrance cable or raceway system.

SHEATH – material, usually an extruded plastic material applied outermost to a wire or cable. Often called a jacket.

SHIELDED CABLE – a cable in which the insulated conductor(s) are enclosed in a conductive mesh envelope. The mesh is intended to protect the enclosed conductor(s) from external electrical interference.

SPLICE – the joining of two or more conductors.

SPLICE BOX – see junction box.

SWIVEL LOK® – a registered HUBBELL INC trademark for multi-position liquidtight connectors for type B liquidtight flexible nonmetallic conduit and extra flexible liquidtight nonmetallic tubing.

T

TOGGLE SWITCH – a switch intended for use in general distribution and branch circuits.

TRADE SIZE – conduit is referred to by trade size according to its inside diameter.

TYPE UF – see underground feeder cable.

U

UL – see Underwriters Laboratories.

UNDERGROUND FEEDER CABLE – underground feeder cable (Type UF) is a group of conductors manufactured in the form of a cable assembly similar to Type NM (Romex®) but with the physical and electrical characteristics that allow for direct burial in the earth.

UNDERWRITERS LABORATORIES (UL) – An independent testing agency that tests and lists electrical equipment to its established standards of safety and performance.

V

VOLT (V) – a unit of electromotive force.

W

WATT (W) – a measure of the power an electrical device consumes; [volts x amps = watts].

WEATHERHEAD – a term used to refer to a service entrance head.

WEATHERPROOF – an enclosure constructed for outdoor use.

WEATHERPROOF-WHILE-IN-USE – term commonly used to describe covers that are designed to be rain tight with cords installed.

WET LOCATIONS – installations underground or in concrete slabs or masonry in direct contact with earth, and locations subject to saturation with water or other liquids, such as vehicle washing areas, and locations exposed to weather and unprotected.

WRTR – an electrical device that is weather resistant and tamper resistant.