

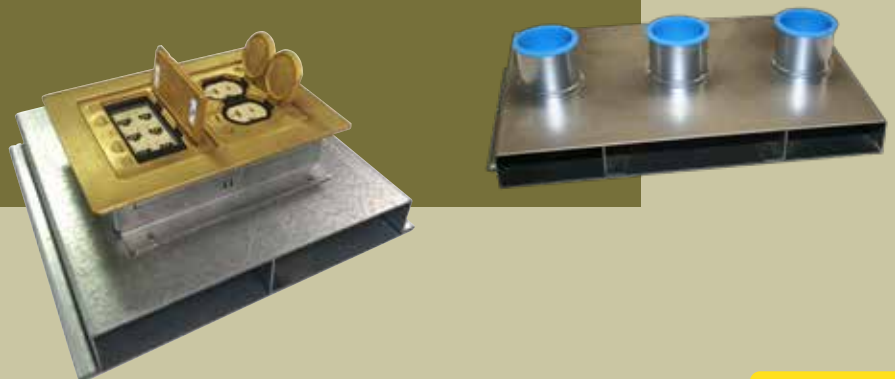

**Trench & Wall
Duct Products**



**Underfloor
Duct Products**



Hubbell Trench Duct Series

Features and Benefits

A high capacity trench system for in-floor wire management.

The Hubbell Trench System is a UL listed in-floor wire management system that meets today's high capacity wiring needs requiring multiple circuit separation. Trench duct is commonly used as a feeder system for medical wall duct when installing radiology equipment, such as X-Ray and MRI machines. Trench duct is also used as a stand alone system for commercial and retail applications where ease of access and high capacity are crucial.



Multiple compartments provide more capacity than conventional ducts.

The Hubbell Trench System provides more capacity than conventional conduits and ducts. It features a single, high-capacity duct with multi-compartments for easy placement of additional wiring.

Its open top design allows wiring to be laid in the duct instead of being pulled, eliminating the need for junction boxes.

Removable covers are 1/4" thick and lock into the track of the trench. Internal dividers and/or support strips increase load capacity of heavy-duty covers. These removable covers allow free access to wiring and can be placed anywhere along the duct for easy wire exit relocation.

- High capacity design supports large wiring for single and multiple service requirements
- Open top design allows wire to be easily laid in duct
- Cover plates are removable and adjust horizontally to any point along the duct. Custom lengths of trench and fittings are available. Provided in either galvanized G90 steel or nonferrous aluminum.
- Multiple compartment options allows for multiple circuit and low voltage separation
- Innovative duct support assembly allows for pre-pour leveling
- Packaging and labeling by project floor and room is available

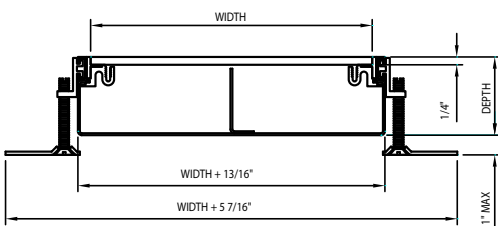
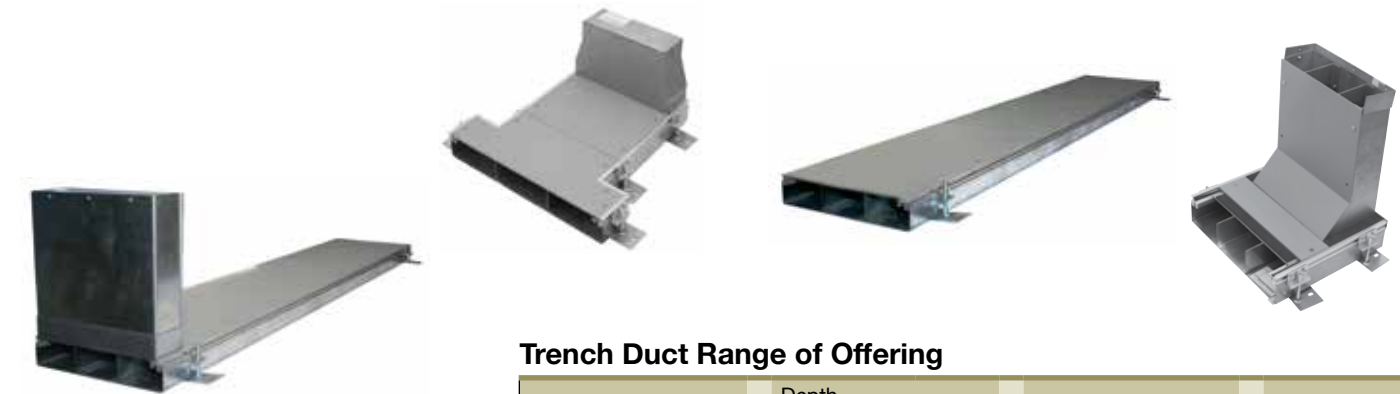

Trench Duct Range of Offering

Trench Product	Depth 1/2" Increments	Width	Compartments	Cover Plate
OKA = Trench	A = 2"	6	1C = 1 Compartment	1/4" = 1/4" thick
OKB = Pull Box	B = 2 1/2"	9	2C = 2 Compartment	
OKC = Exit Cover	C = 3"	12	3C = 3 Compartment	
OKE = End Cap	D = 3 1/2"	18	4C = 4 Compartment	
OKL = Horizontal L	E = 4"	24		
OKR = Vertical Riser	J = 6"	(Other Widths Avail.)		
OKT = T Junction Box	N = 8"	(Other Depths Available)		
OKX = X Junction Box				

Note: For Aluminum Trench Duct or Fittings, add "AL" suffix to catalog number.



Ordering Information Notes:

1. Common use sizes are listed below. Contact factory for other configurations or see page 2 for Range of Offering table.
2. Trench Duct part numbers are for reference only. All Trench Duct orders are lot billed with a generic TW prefix project specific part numbers. Please contact your local Hubbell Territory Manager for all Hubbell Duct quotations.

Trench Duct	Description	Trench Depth	Cover Width	No. of Compartments	Catalog Number
	Straight Section		2½"	9"	1
Manufactured in standard 6' lengths with factory installed dividers.		3"	9"	2	OKA/C9-2C-1/4
Provided with (3) leveling feet/couplers on each side, (3) 24" long cover plates and (3) cover plate joint protectors.		2½"	12"	2	OKA/B12-2C-1/4
		3"	12"	3	OKA/C12-3C-1/4
		2½"	18"	3	OKA/B18-3C-1/4
		3"	18"	4	OKA/C18-4C-1/4
		2½"	24"	3	OKA/B24-3C-1/4
		3"	24"	4	OKA/C24-4C-1/4

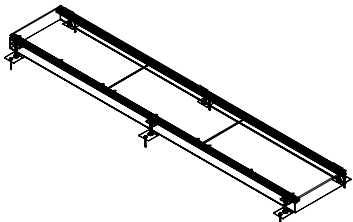

Note: For Aluminum Trench Duct or Fittings, add "AL" suffix to catalog number.

Fittings	Description	Outside Cover	No. of Compartments	Catalog Number
	Horizontal "L" Fitting		12" x 12"	1
Manufactured with a single cover and matching internal partitions to form a 90° horizontal "L". Includes cover plate joint protectors and leveling feet.		12" x 12"	2	OKL/C9-2C-1/4
		15" x 15"	2	OKL/B12-2C-1/4
		15" x 15"	3	OKL/C12-3C-1/4
		21" x 21"	3	OKL/B18-3C-1/4
		21" x 21"	4	OKL/C18-4C-1/4
		27" x 27"	3	OKL/B24-3C-1/4
		27" x 27"	4	OKL/C24-4C-1/4
Horizontal 45° Elbow Fitting		45°	1	OKL/B9-1Cx45-1/4
Manufactured with a split cover plate and matching internal partitions to form a 45° Mitered "L". Other angles available. Includes cover plate joint protectors and leveling feet.		45°	2	OKL/C9-2Cx45-1/4
		45°	2	OKL/B12-2Cx45-1/4
		45°	3	OKL/C12-3Cx45-1/4
		45°	3	OKL/B18-3Cx45-1/4
		45°	4	OKL/C18-4Cx45-1/4
		45°	3	OKL/B24-3Cx45-1/4
		45°	4	OKL/C24-4Cx45-1/4
Single Level "T" Junction Fitting		15" x 12"	1	OKT/B9-1C-1/4
Manufactured with matching internal partitions and crossovers to isolate power and communications. Includes cover plate joint protectors and leveling feet.		15" x 12"	2	OKT/C9-2C-1/4
		18" x 15"	2	OKT/B12-2C-1/4
		18" x 15"	3	OKT/C12-3C-1/4
		24" x 21"	3	OKT/B18-3C-1/4
		24" x 21"	4	OKT/C18-4C-1/4
		30" x 27"	3	OKT/B24-3C-1/4
		30" x 27"	4	OKT/C24-4C-1/4
Pull Box		9" x 12"	1	OKB/B9-1C-1/4
Manufactured to attach to trench section replacing end cap. Divided into compartments as required. Additional depth permits attachment of large conduits. Box is field punched for conduits. Standard depth is 6". Also available as a stand-alone SPOKB solid-sided floor box with trench rails on all 4 sides. Consult factory for details		9" x 12"	2	OKB/C9-2C-1/4
		12" x 12"	2	OKB/B12-2C-1/4
		12" x 12"	3	OKB/C12-3C-1/4
		18" x 12"	3	OKB/B18-3C-1/4
		18" x 12"	4	OKB/C18-4C-1/4
		24" x 12"	3	OKB/B24-3C-1/4
		24" x 12"	4	OKB/C24-4C-1/4

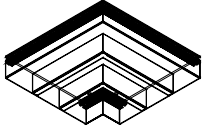
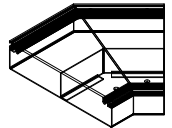
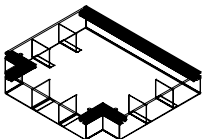
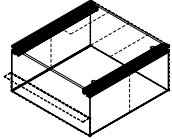
Exit Cover Fittings	Description	Trench Width	Catalog Number
	Exit Cover		
Designed to provide exit and feed for Trench Duct. Conduit openings are provided for power and communication exit or feed using conventional conduit fittings or service fittings. Exit Cover may be placed anywhere along the length of the trench. All Exit Covers are 6" long. Hole sizes and placement are specified at time of order.		9"	OKC/9-xx
		12"	OKC/12-xx
		18"	OKC/18-xx
		24"	OKC/24-xx
Access Hood			
Similar to Exit Cover except provided with a louvered opening for communication cables. Consult factory for custom Access Hoods.		9"	OKHOOD-9
		12"	OKHOOD-12
		18"	OKHOOD-18
		24"	OKHOOD-24

Ordering Information Notes:

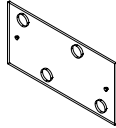
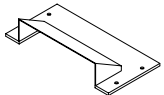
1. Common use sizes are listed below. Contact factory for other configurations or see page 2 for Range of Offering table.
2. Trench Duct part numbers are for reference only. All Trench Duct orders are lot billed with a generic TW prefix project specific part numbers. Please contact your local Hubbell Territory Manager for all Hubbell Duct quotations.

Hubbell Trench Duct Fittings

	Description	Outside Cover	No. of Compartments	Catalog Number	
	Single Level "X" Junction Fitting Manufactured with matching internal partitions and crossovers to isolate power and communications. Includes cover plate joint protectors and leveling feet.	15" x 15"	15" x 15"	1	
15" x 15"		15" x 15"	2	OKX/C9-2C-1/4	
18" x 18"		18" x 18"	2	OKX/B12-2C-1/4	
18" x 18"		18" x 18"	3	OKX/C12-3C-1/4	
24" x 24"		24" x 24"	3	OKX/B18-3C-1/4	
24" x 24"		24" x 24"	4	OKX/C18-4C-1/4	
30" x 30"		30" x 30"	3	OKX/B24-3C-1/4	
30" x 30"	30" x 30"	4	OKX/C24-4C-1/4		
End Cap Fits over end of trench run to close trench and prevent foreign material from entering. End cap may be drilled to accept conduit.	Description	Fits Trench Dim. (Width x Depth)	Max Trade Size Conduit	Catalog Number	
	9" x 2½"	9" x 2½"	¾"	OKE/B9	
	9" x 3"	9" x 3"	1"	OKE/C9	
	12" x 2½"	12" x 2½"	¾"	OKE/B12	
	12" x 3"	12" x 3"	1"	OKE/C12	
	18" x 2½"	18" x 2½"	¾"	OKE/B18	
	18" x 3"	18" x 3"	1"	OKE/C18	
24" x 2½"	24" x 2½"	¾"	OKE/B24		
24" x 3"	24" x 3"	1"	OKE/C24		
Vertical Riser Fitting (Straight) Manufactured to transition from trench duct to a panel, pull box or to conduit. Mounts on trench in place of cover. Partitioned to separate cells and flanged to attach to a pull box or panel. Removable front cover and top cover. Standard height above finish floor — 12". Standard depth — 3½". Available in a sweep version (replace OKR with OKSWR)	Description	Fits Trench Width	No. of Compartments	Catalog Number	
	9"	9"	1	OKR/D9-1C	
	9"	9"	2	OKR/D9-2C	
	12"	12"	2	OKR/D12-2C	
	12"	12"	3	OKR/D12-3C	
	18"	18"	3	OKR/D18-3C	
	18"	18"	4	OKR/D18-4C	
24"	24"	3	OKR/D24-3C		
24"	24"	4	OKR/D24-4C		

	Description	Trench Width #1	Trench Width #2	Catalog Number	
	Reducer Fitting Manufactured to transition from a wide trench duct width to a narrower trench duct width.	9"	9"	6"	
12"		12"	9"	OKARED/B12-9-3C-1/4	
18"		18"	12"	OKARED/B18-12-3C-1/4	
24"		24"	18"	OKARED/B24-18-4C-1/4	
Fastening Angles Accessories to join trench sections for field fabrication of horizontal and vertical assemblies.	Horizontal Angle	—	—	OK/VW1	
	Vertical Angle	—	—	OK/VWV	

	Description	Accessory Type	Catalog Number
	Permits 1" of pre-pour vertical adjustment and couples sections together. "x" represents screw height (max. 6") and height of trench. Additional vertical adjustment is available by increasing the length of screw "x".	Single Leveling Foot Assembly	OK/F-x
	Provides a 1½" wide surface (with gasket) for cover plate joints. "x" represents trench width.	Single Cover Plate Joint Protector	OK/DSD-x
	Separates trench duct compartments. "x" represents trench depth (see catalog number system).	Divider	OKP/x
Provided with 5/16" x 18 bolts on 6" or 12" centers for increased cover plate weight loading capability.	Support Stud Strip	Consult Factory	

	Description	Type	No. of Compartments	Catalog Number	
	Tunnel Fittings Factory installed inside of multi-compartment "T" and "X" units to maintain separation of services. May be ordered separately and field installed.	"T" Unit	"T" Unit	2, 3, or 4	
"X" Unit		"X" Unit	2, 3, or 4	Consult Factory	

Features and Benefits

The Hubbell Wall Duct Series is a UL Listed metal raceway system designed for the enclosure of wiring for MRI or X-Ray equipment in medical applications. The system provides complete lay-in wiring capability in order to accommodate the large cables and connectors used in today's installations.

Hubbell Wall Duct is available in either flush or surface mount and a combination will usually be required on any job. Vertical runs in the walls are usually flush mounted with horizontal runs on walls and all duct in ceiling plenum are typically surface type.

Wall Duct is available in ferrous steel and non-ferrous aluminum versions.

- Lay in wiring accommodates large cables and connectors to connect equipment
- Corrosion resistant galvanized A60 steel or non ferrous aluminum versions
- Steel Wall Duct is provided with unpainted bodies and gray primed cover plates. Custom painted wall duct is available
- Flush (primarily wall) and Surface (primarily ceiling) mount provides flexibility to address specific equipment placement and unique room design requirements
- Hubbell Wall Duct is utilized with Hubbell Trench Duct
- Packaging and labeling by project floor and room is available



Wall Duct Range of Offering

Wall Duct Product		Depth ½" Increments	Width	Cover Style
OWA = Wall Duct	OWI = Internal Elbow	A = 2"	6	S = Surface
OWB = Adapter	OWL = External Elbow	B = 2½"	10	F = Flush
OWC = Coupling	OWP = Partition	C = 3"	12	
OWD = Reducer Coupling	OWR = Vertical Riser	D = 3½"	18	
OWE = End Closure	OWT = T Unit	E = 4"	(Other Widths Available)	
OWF = Cabinet Connector	OWV = Trench to Wall Duct Adapter	J = 6"		
OWH = Horizontal Elbow	OWX = X Unit	N = 8"		
		(Other Depths Available)		

Note: For Aluminum Wall Duct or Fittings, add **"AL"** suffix to catalog number.

Ordering Information Notes:

1. Common use sizes are listed below. Contact factory for other configurations or see page 5 for Range of Offering table.
2. Wall Duct part numbers are for reference only. All Wall Duct orders are lot billed with a generic TW prefix project specific part numbers. Please contact your local Hubbell Territory Manager for all Hubbell Duct quotations.

Wall Duct	Description	Overall Depth	Body Width	Cover Width	Flush Catalog Number	Cover Width	Surface Catalog Number
	Wall and Ceiling Duct Manufactured in standard 60" lengths with two 30" long cover plates. Provided with one coupling and necessary screws.	3½"	9 ¹³ / ₁₆ "	12"	OWA/D10F	10"	OWA/D10S
3½"		11 ¹³ / ₁₆ "	14"	OWA/D12F	12"	OWA/D12S	
3½"		17 ¹³ / ₁₆ "	20"	OWA/D18F	18"	OWA/D18S	

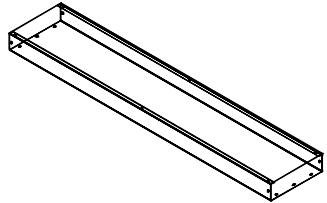

Note: For Aluminum Wall Duct or Fittings, add "AL" suffix to catalog number.

Elbow Fittings	Description	Overall Depth	Body Width	Cover Width	Flush Catalog Number	Cover Width	Surface Catalog Number
	Internal Elbow Forms a sharp 90° Internal "L". Provided with one cover plate, one coupling and necessary screws.	3½"	9 ¹³ / ₁₆ "	12"	OWI/D10F	10"	OWI/D10S
3½"		11 ¹³ / ₁₆ "	14"	OWI/D12F	12"	OWI/D12S	
3½"		17 ¹³ / ₁₆ "	20"	OWI/D18F	18"	OWI/D18S	
Internal Elbow, Sweep Forms a chamfered 90° Internal "L" for increased cable bend radius. Provided with one cover plate, one coupling and necessary screws.	3½"	9 ¹³ / ₁₆ "	12"	OWSWI/D10F	10"	OWSWI/D10S	
	3½"	11 ¹³ / ₁₆ "	14"	OWSWI/D12F	12"	OWSWI/D12S	
	3½"	17 ¹³ / ₁₆ "	20"	OWSWI/D18F	18"	OWSWI/D18S	
Internal 45° Elbow Forms a 45° Internal "L". Provided with one cover plate, one coupling and necessary screws. Also available as an External 45° elbow. Replace "OWI" with "OWL" in catalog number.	3½"	9 ¹³ / ₁₆ "	12"	OWI45/D10F	10"	OWI45/D10S	
	3½"	11 ¹³ / ₁₆ "	14"	OWI45/D12F	12"	OWI45/D12S	
	3½"	17 ¹³ / ₁₆ "	20"	OWI45/D18F	18"	OWI45/D18S	
Horizontal Elbow Forms a 90° Horizontal "L". Provided with one cover plate, one coupling and necessary screws. Corner divider "OWCP" ordered separately.	3½"	9 ¹³ / ₁₆ "	12"	OWH/D10F	10"	OWH/D10S	
	3½"	11 ¹³ / ₁₆ "	14"	OWH/D12F	12"	OWH/D12S	
	3½"	17 ¹³ / ₁₆ "	20"	OWH/D18F	18"	OWH/D18S	
Horizontal 45° Elbow Forms a 45° Horizontal "L". Provided with one cover plate, one coupling and necessary screws.	3½"	9 ¹³ / ₁₆ "	12"	OWH45/D10F	10"	OWH45/D10S	
	3½"	11 ¹³ / ₁₆ "	14"	OWH45/D12F	12"	OWH45/D12S	
	3½"	17 ¹³ / ₁₆ "	20"	OWH45/D18F	18"	OWH45/D18S	
External Elbow Forms a sharp 90° External "L". Provided with two cover plates, one coupling and necessary screws.	3½"	9 ¹³ / ₁₆ "	12"	OWL/D10F	10"	OWL/D10S	
	3½"	11 ¹³ / ₁₆ "	14"	OWL/D12F	12"	OWL/D12S	
	3½"	17 ¹³ / ₁₆ "	20"	OWL/D18F	18"	OWL/D18S	

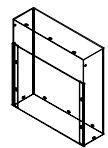
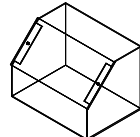
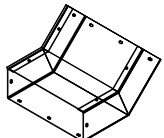
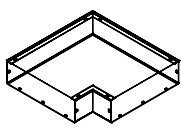
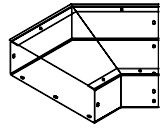
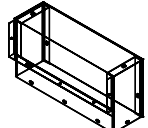
Note: Images shown are surface mount.

Ordering Information Notes:

1. Common use sizes are listed below. Contact factory for other configurations or see page 5 for Range of Offering table.
2. Wall Duct part numbers are for reference only. All Wall Duct orders are lot billed with a generic TW prefix project specific part numbers. Please contact your local Hubbell Territory Manager for all Hubbell Duct quotations.

Hubbell Wall Duct Fittings

	Description	Overall Depth	Body Width	Cover Width	Flush Catalog Number	Cover Width	Surface Catalog Number		
Internal / External Elbows	Internal / External Elbow	3½"	9¼"	—	—	10"	SPOWI/D10S		
	Transitions from surface wall duct to surface style ceiling duct.	3½"	11¼"	—	—	12"	SPOWI/D12S		
	Flush wall duct to surface style ceiling duct available upon request. Provided with two cover plates, one coupling and necessary screws.	3½"	17¼"	—	—	18"	SPOWI/D18S		
	Internal / External Elbow, Sweep	Internal / External Elbow, Sweep	3½"	9¼"	—	—	10"	SPOWSWI/D10S	
		Transitions from surface wall duct to surface style ceiling duct.	3½"	11¼"	—	—	12"	SPOWSWI/D12S	
		Flush wall duct to surface style ceiling duct available upon request. Provided with two cover plates, one coupling and necessary screws.	3½"	17¼"	—	—	18"	SPOWSWI/D18S	
"T" Units	Vertical "T" Unit	3½"	9¼"	12"	OWVT/D10F	10"	OWVT/D10S		
	Forms a 90° Vertical "T". Provided with three cover plates, two couplings and necessary screws.	3½"	11¼"	14"	OWVT/D12F	12"	OWVT/D12S		
		3½"	17¼"	20"	OWVT/D18F	18"	OWVT/D18S		
	Horizontal "T" Unit	Horizontal "T" Unit	3½"	9¼"	12"	OWT/D10F	10"	OWT/D10S	
		Forms a 90° Horizontal "T". Provided with one cover plate, one coupling and necessary screws. Tunnels are ordered separately.	3½"	11¼"	14"	OWT/D12F	12"	OWT/D12S	
			3½"	17¼"	20"	OWT/D18F	18"	OWT/D18S	
"X" Unit	"X" Unit	3½"	9¼"	12"	OWX/D10F	10"	OWX/D10S		
	Forms intersection of four perpendicular ducts. Provided with one cover plate, two coupling and necessary screws. Tunnels are ordered separately.	3½"	11¼"	14"	OWX/D12F	12"	OWX/D12S		
		3½"	17¼"	20"	OWX/D18F	18"	OWX/D18S		

	Description	For Trench Width	For Wall Duct (Width x Depth)	Flush Catalog Number	Surface Catalog Number		
Vertical Riser Fittings	Vertical Riser Fitting, Straight	10"	10" x 3½"	OWR/D10F	OWR/D10S		
	Transitions from trench duct to a vertical run of wall duct. Mounts on trench in place of cover. Removable front cover. Standard height above finish floor — 12" (7" for OWR/D12x10). Standard depth — 3½". Provided with one coupling and necessary screws.	12"	12" x 3½"	OWR/D12F	OWR/D12S		
		18"	18" x 3½"	OWR/D18F	OWR/D18S		
		12"	10" x 3½"	OWR/D12-10F	OWR/D12-10S		
	Vertical Riser Fitting, Sweep	Vertical Riser Fitting, Sweep	10"	10" x 3½"	OWSWR/D10F	OWSWR/D10S	
		Transitions from trench duct to a vertical run of wall duct. Mounts on trench in place of cover. Removable front cover. Standard height above finish floor — 12". Standard depth — 3½". Provided with one coupling and necessary screws.	12"	12" x 3½"	OWSWR/D12F	OWSWR/D12S	
		18"	18" x 3½"	OWSWR/D18F	OWSWR/D18S		
		12"	10" x 3½"	OWSWR/D12-10F	OWSWR/D12-10S		

	Description	Overall Depth	Flush Wall Duct Body Width	Surface Cover Width	Catalog Number	
Adapter Fitting	Flush to Surface Adapter	3½"	9¼"	10"	OWB/D10-10	
	Transitions from flush wall duct to perpendicular surface wall duct. Provided with one cover plate, two couplings and necessary screws.	3½"	11¼"	18"	OWB/D12-18	
		3½"	17¼"	12"	OWB/D18-12	
		3½"	17¼"	18"	OWB/D18-18	



Ordering Information Notes:

1. Common use sizes are listed below. Contact factory for other configurations or see page 5 for Range of Offering table.
2. Wall Duct part numbers are for reference only. All Wall Duct orders are lot billed with a generic TW prefix project specific part numbers. Please contact your local Hubbell Territory Manager for all Hubbell Duct quotations.

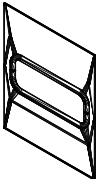
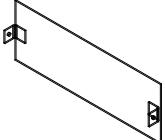
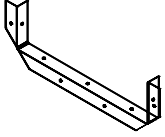
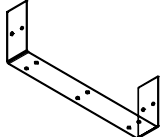
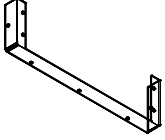
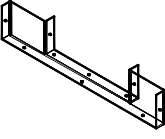
Hubbell Wall Duct Fittings

	Description	Overall Depth	Cover Width	Flush Catalog Number	Cover Width	Surface Catalog Number	
Additional Fittings	Split Cover Plate Provides wire egress from raceway. Provided with assembly screws and grommet material.	—	12" 14" 20"	OWSC/10F OWSC/12F OWSC/18F	10" 12" 18"	OWSC/10S OWSC/12S OWSC/18S	
	End Cap Closes off end of wall duct. Screws provided.	3½" 3½" 3½"	12" 14" 20"	OWE/D10F OWE/D12F OWE/D18F	10" 12" 18"	OWE/D10S OWE/D12S OWE/D18S	
	Cabinet Connector Connects wall duct to enclosures. Designed to be positioned around outside surface of duct and secured with screws from inside of duct. Screws provided.	3½" 3½" 3½"	12" 14" 20"	OWF/D10 OWF/D12 OWF/D18	10" 12" 18"	OWF/D10 OWF/D12 OWF/D18	
	Coupling Joins surface or flush wall duct sections together. Designed to be positioned around outside surface of duct and secured with screws from inside of duct. Screws provided.	3½" 3½" 3½"	12" 14" 20"	OWC/D10 OWC/D12 OWC/D18	10" 12" 18"	OWC/D10 OWC/D12 OWC/D18	
	Trench to Wall Duct Adapter Transitions from trench duct to a vertical run of wall duct when not using the OWR or OKR series Vertical Risers. Mounts on trench in place of cover. Provided with necessary screws.	3½" 3½" 3½"	12" 14" 20"	OWV/D10 OWV/D12 OWV/D18	10" 12" 18"	OWV/D10 OWV/D12 OWV/D18	
	Reducer Coupling Joins two sizes of surface or flush wall duct sections together. Designed to be positioned around outside surface of duct and secured with screws from inside of duct. Screws provided.	3½" 3½"	20" to 12" 20" to 14"	OWD/D (18-10) OWD/D (18-12)	18" to 10" 18" to 12"	OWD/D (18-10) OWD/D (18-12)	

Note: Grommet material is available to cover field cut openings in Wall Duct. Outside dimensions of grommet is ¼" x 5/16" and is made from SBR rubber. Catalog number GROM-xx ("xx" represents length in feet).

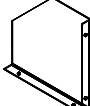
	Description	For Overall Raceway Depth	For Fitting Style		
			Straight (Length 60")	Horizontal "L"	Internal Sweep Elbow
Partitions Fittings	Internal Duct Partitions Divides raceway and fittings into compartments. Screws provided.	3½"	OWP/D	OWCP/D	OWSWP/D
					

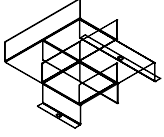
	Description	Type	No. of Compartments	Catalog Number	
Tunnel Fittings	Tunnels Field installed inside of multi-compartment "T" and "X" units to maintain separation of services. May be factory installed.	"T" Unit "X" Unit	2, 3, or 4 2, 3, or 4	Consult Factory Consult Factory	

Features and Benefits

Multi-Compartment Underfloor Duct Saves Time and Money for In-Slab Wire Management System

The Hubbell Underfloor Duct system is a UL listed in-slab wire management product for delivering power, voice and data services to applications that include retail facilities, open office workstations, fitness centers, casinos, medical facilities and libraries. This system is uniquely designed with multiple compartments, allowing unlimited design options and cost savings in labor and materials from other single-compartment systems. Matched with our strong national distribution and complete technical and application support, the Hubbell Underfloor Duct System is the perfect solution for your underfloor wire management needs.

- Eight duct profiles available to accommodate numerous in-slab wire management for power and communications.
- One-piece design multi-compartment duct, drastically reducing installation and material costs.
- Standard insert heights ranging from 1 to 3 inches (other heights available).
- Inclusive tile trim in square-top junction boxes, providing the installer the on-site option of using the trim or leaving it recessed.
- Combination duct coupler/support, reducing material and labor costs using the same part to join raceway sections together and to support/level the duct.
- Activation inserts are pre-assembled to the duct, or the inserts can be purchased separately for field installation only where you need them.
- Heavy duty junction boxes are available for areas requiring high-concentrated floor loads.
- Meets or exceeds UL 884 specifications, assuring a fully UL Listed system.



Flush Insert Duct Benefits

- Provides an aesthetic wire management solution for delivering power and communications services.
- Unique multi-gang flush inserts with removable voltage dividers provide the flexibility of installing multiple gangs of the same service at each insert location.
- Individual gangs can be activated as needed, to minimize costs.
- Activation trims accept standard Hubbell floor box covers for power and data, available in aluminum and brass.

Ordering Information Note:

Floor Duct part numbers are for reference only. All Floor Duct orders are lot billed with a generic FD prefix project specific part numbers. Please contact your local Hubbell Territory Manager for all Hubbell Duct quotations.

Conventional, Flush and Blank Underfloor Duct Profiles

- Provided in standard 10 ft. lengths
- 14 gauge, G90 galvanized steel
- 2 Inch IPS (Iron Pipe Size) round inserts are die-cast zinc
- Rectangular inserts are 14 gauge, G90 galvanized steel

Catalog Number System

	SP202F -	2	-	12	
	Profile	Insert Height		Insert Spacing	
Round Insert Duct and Blank Duct	201	B = Blank		12 = 12"	
	201W	1 = 1" (201 only)		24 = 24"	
	202	15 = 1 1/2"		(consult factory for special preset spacing)	
	SP202	2 = 2"			
	202W	25 = 2 1/2"			
	203	3 = 3"*		n/a for Blank Duct	
Flush Insert Duct	201F	1 = 1" (201F only)		12 = 12"	
	201WF	15 = 1 1/2"***		24 = 24"	
	202F	2 = 2"		(consult factory for special preset spacing)	
	SP202F	25 = 2 1/2"			
	202WF	3 = 3"*			

Note: *Consult factory for heights greater than 3". ** 1 1/2" min. required for duplex receptacles.

Dimensions

201 & 201F

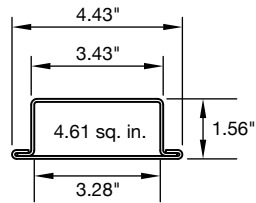

201W & 201WF

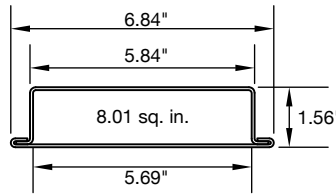

202 & 202F

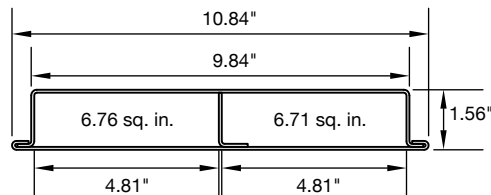

203

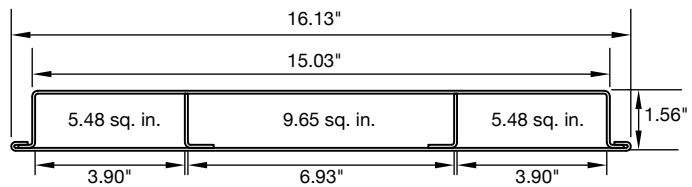

SP202 & SP202F

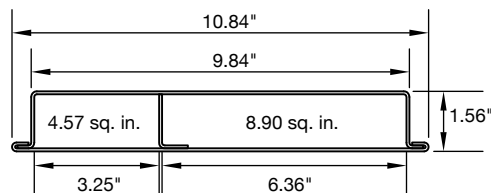

203F

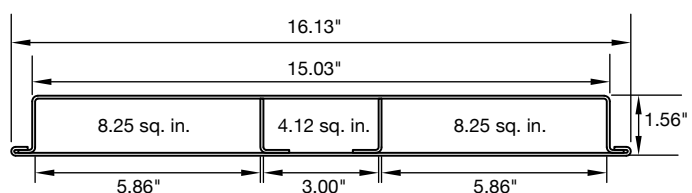

202W & 202WF

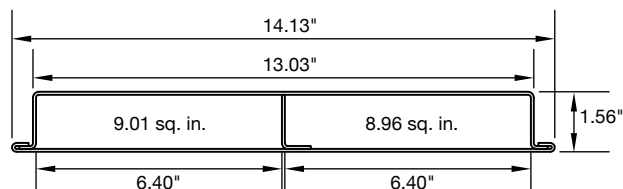

204

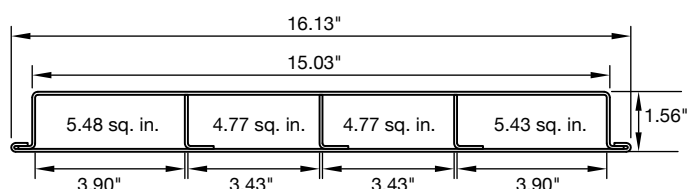

Ordering Information Note:

Floor Duct part numbers are for reference only. All Floor Duct orders are lot billed with a generic FD prefix project specific part numbers. Please contact your local Hubbell Territory Manager for all Hubbell Duct quotations.

Technical Information and Wire Fill Capacity Chart

Cable Type	Size	Approx. Dia. (in.)	Approx. Area (sq in.)	201		202		SP202		202W		203			203F			204			
				201F	201WF	202F	202F	SP202F	SP202F	202WF	202WF	A	B	C	A	B	C	A	B	C	D
				Channel Cross Sectional Area (sq. in.)				A	A	A	B	A	B	A	B	A	B	C	A	B	C
Power (THHN)	14 AWG	0.111	0.0097	190	331	279	277	188	367	372	370	226	398	226	341	170	341	226	197	197	224
	12 AWG	0.130	0.0133	138	241	203	202	137	268	271	270	165	290	165	248	124	248	165	143	143	163
	10 AWG	0.164	0.0211	87	151	128	127	86	168	170	169	103	182	103	156	78	156	103	90	90	102
	8 AWG	0.216	0.0366	50	87	73	73	49	97	98	97	59	105	59	90	44	90	59	52	52	59
Coax Cables	RG-6/U	0.270	0.0573	32	55	47	46	31	62	62	62	38	67	38	57	28	57	38	33	33	37
	RG-6/UQ	0.298	0.0697	26	45	38	38	26	51	51	51	31	55	31	47	23	47	31	27	27	31
LAN Cables	Cat 5e	0.210	0.0346	53	92	78	77	52	102	104	103	63	111	63	95	47	95	63	55	55	62
	Cat 6	0.250	0.0491	37	65	55	54	37	72	73	73	44	78	44	67	33	67	44	38	38	44
	Cat 6A	0.350	0.0962	19	33	28	27	18	37	37	37	22	40	22	34	17	34	22	19	19	22
Fiber Optic Distribution Cables	2-6 Strand	0.190	0.0284	65	113	95	94	64	125	127	126	77	136	77	116	58	116	77	67	67	76
	8-12 Strand	0.230	0.0415	44	77	65	64	43	85	86	86	52	92	52	79	39	79	52	45	45	52
	16-24 Strand	0.350	0.0962	19	33	28	27	18	37	37	37	22	40	22	34	17	34	22	19	19	22

Note: Cable quantities shown in this chart are based on a 40% wire fill capacity. Sizes of COAX, LAN and Fiber Optic cables are provided for example only. Consult cable manufacturer's specification for exact cable sizes.

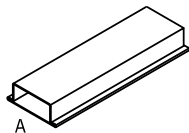

201 and 201F Series
Single Compartment

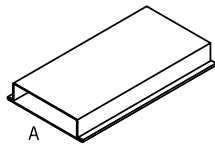

201W and 201WF Series
Single Wide Compartment

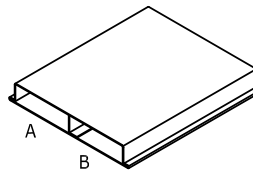

202 and 202F Series
Two Equal Compartments

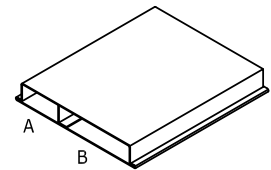

SP202 and SP202F Series
Modified Two Compartments

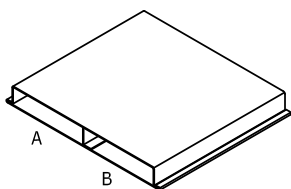

202W and 202WF Series
Two Equal Compartments

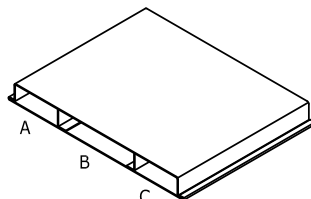

203 Series
Three Compartments

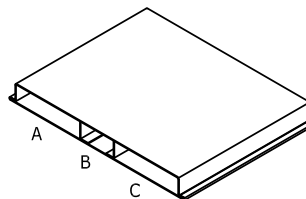

203F Series
Three Compartments

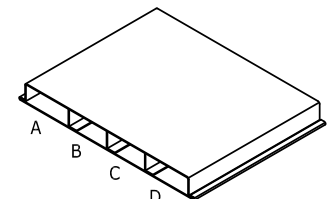

204 Series
Four Compartments

Applicable Codes & Standards

- TIA/EIA 569-C "Commercial Building Standard for Telecommunications Pathways and Spaces"
- NEC Article 390 "Underfloor Raceways"
- Ampacity derating rules of NEC Article 310.15 (B)(3) applies to conductors installed in Underfloor Raceways and Trench Duct
- UL Standard UL 884 "Underfloor Raceways and Fittings"
- UL Listed E75939 (Underfloor Raceway) & E304554 (Underfloor raceway Fittings)

Ordering Information Note:

Floor Duct part numbers are for reference only. All Floor Duct orders are lot billed with a generic FD prefix project specific part numbers. Please contact your local Hubbell Territory Manager for all Hubbell Duct quotations.

Underfloor Duct Raceway Fittings

			Flush Insert Duct						Conventional Duct										
			201F	201WF	202F	SP202F	202WF	203F	201	201W	202	SP202	202W	203	204				
Coupler Support		Couples duct sections together and supports the duct. To be used every 5 feet of duct run.	201-DCS	•															
			201W-DCS		•							•							
			202-DCS			•	•						•	•					
			202W-DCS							•					•				
			203-DCS													•	•		
End Cap Support		Supports and closes unused duct ends.	201-ECS	•															
			201W-ECS		•							•							
			202-ECS			•	•						•	•					
			202W-ECS							•					•				
			203-ECS													•	•		
Vertical Riser		Transitions from duct embedded in concrete floor to vertical duct or may be used for direct connection to a Universal Conduit Adapter (UCA). Coupler / Supports (DCS) are required to attach to duct and UCA.	201-VEL	•															
			201W-VEL		•							•							
			202-VEL			•							•						
			SP202-VEL				•							•					
			202W-VEL							•					•				
			203-VEL													•	•		
			203F-VEL															•	
204-VEL																•			
Universal Conduit Adapter		Transitions from duct to conduit. A blank 14 gauge steel plate is provided for field punched conduit openings. For use with up to 2 1/2" trade size conduits. Consult factory for larger conduit accommodations. (may also be inserted directly into Junction Boxes)	201-UCA	•															
			201W-UCA		•							•							
			202-UCA			•							•						
			SP202-UCA				•							•					
			202W-UCA							•					•				
			203-UCA													•	•		
			203F-UCA															•	
204-UCA																•			
Horizontal 90 Degree Elbow		Provides a horizontal 90 degree turn in floor duct. No hand access provided. Consult factory for other angles. SP202-HB90-NIR SP202-HB90-NOR SP202-HB90's must be specified either with the Narrow Compartment located at the inside radius (-NIR) or at the outside radius (-NOR) as shown in illustration.	201-HB90	•															
			201W-HB90		•							•							
			202-HB90			•							•						
			SP202-HB90-NIR				•							•					
			SP202-HB90-NOR					•							•				
			202W-HB90							•					•				
			203-HB90													•	•		
			203F-HB90															•	
204-HB90																•			
Cabinet Connector		Provides a means for connecting duct to an electrical cabinet	201-DCC	•															
			201W-DCC		•							•							
			202-DCC			•	•						•	•					
			202W-DCC							•					•				
			203-DCC													•	•		

Ordering Information Note:

Floor Duct part numbers are for reference only. All Floor Duct orders are lot billed with a generic FD prefix project specific part numbers. Please contact your local Hubbell Territory Manager for all Hubbell Duct quotations.

- x = Preset Insert Height
- 1 = 1" (201 & 201F only)
- 15 = 1 1/2" (min. required for duplex recept.)
- 2 = 2"
- 25 = 2 1/2"
- 3 = 3" (consult factory for heights greater than 3")

Underfloor Duct Raceway Junction Boxes and Accessories

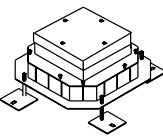
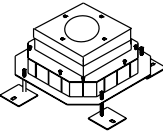
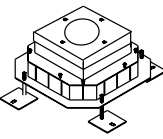
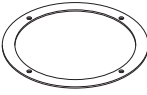
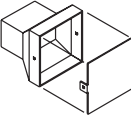
Junction Box Square Access 	For providing square opening access at intersections of Feeder Duct and Distribution Duct	201-JB-x
		201W-JB-x
		202-JB-x
		SP202-JB-x
		202W-JB-x
		203-JB-x
		203F-JB-x
		204-JB-x
Junction Box Round Access 	For providing round opening access at intersections of Feeder Duct and Distribution Duct. Provided with Brass or Stainless Steel Carpet Ring *Available in Stainless Steel. To order replace B with SS	201-JB-x-RCB*
		201W-JB-x-RCB*
		202-JB-x-RCB*
		SP202-JB-x-RCB*
		202W-JB-x-RCB*
		203-JB-x-RCB*
		203F-JB-x-RCB*
		204-JB-x-RCB*
Junction Box Heavy Duty Round Access 	Same as above except cover plates are 3/8" thick and after-pour height adjustable. Carpet Rings and Closure Caps must be ordered separately. Duct Entrance Cap - HDJBDC Corner Cap - HDJBCC	202-JB-x-HD-ADJ
		SP202-JB-x-HD-ADJ
		202W-JB-x-HD-ADJ
Carpet Ring for Heavy Duty Junction Boxes 	1/8" thick Carpet Trim for Heavy Duty Junction Boxes. *Available in Stainless Steel. To order replace BRASS with SS	RD-BRASS*-202-ADJ
		RD-BRASS*-SP202-ADJ
		RD-BRASS*-202W-ADJ
Junction Box Corner Conduit Adapter 	Provides attachment point for conduit to each corner of all junction boxes. JB-CCA is provided with 14 gauge steel plate for field punched conduit opening. All other adapters are factory punched.	JB-CCA
		JB-CCA-1/2
		JB-CCA-3/4
		JB-CCA-1
		JB-CCA-1-1/2
		JB-CCA-2

Flush Insert Duct						Conventional Duct						
201F	201WF	202F	SP202F	202WF	203F	201	201W	202	SP202	202W	203	204
●						●						
	●						●					
		●						●				
			●						●			
				●						●		
					●						●	
						●						●
												●

Hubbell Trench Duct is commonly used as a feeder system for Underfloor Duct Raceway systems.



Factory assembled Trench/Underfloor duct intersect units allow unrestricted capacity by the elimination of tunnels. Side mounted Underfloor duct is available for shallow concrete pours. Consult factory for details.

- High capacity design supports large cables for single and multiple service requirements.
- Open top design allows cables to be easily laid in duct.
- Cover plates are removable and adjust horizontally to any point along the duct.
- Custom lengths of trench and fittings are available.
- Multiple compartments allow complete separation of services.
- Innovative duct support assembly allows for pre-pour leveling and acts as a splice for duct sections.

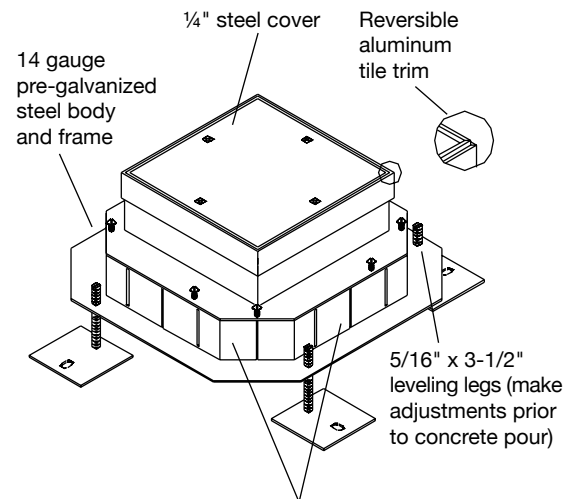

Removable pry-out sections for corner conduit adapters (JB-CCA series) and duct entrances. Additional blanking plates not required for unused junction box entrances. Blanking plates must be ordered separately for heavy duty junction boxes.

Ordering Information Note:

Floor Duct part numbers are for reference only. All Floor Duct orders are lot billed with a generic FD prefix project specific part numbers. Please contact your local Hubbell Territory Manager for all Hubbell Duct quotations.

Underfloor Duct Junction Box Dimensions

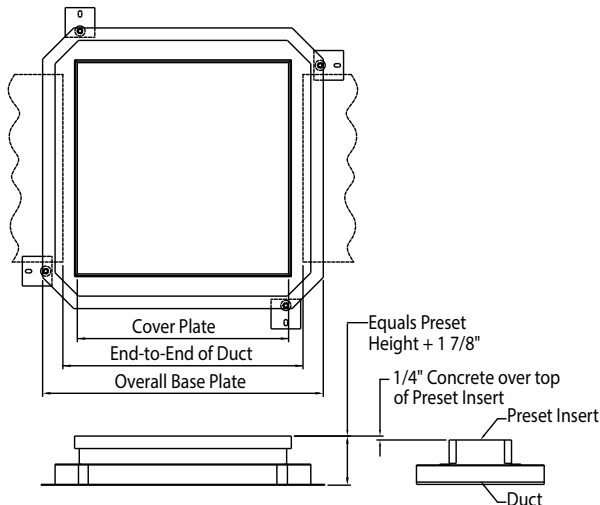

Junction Box Catalog Number	Cover Plate	End-To-End Of Duct	Overall Base Plate
201-JB-x 201-JB-x-RCx	6 5/16"	8"	10 1/2"
201W-JB-x 201W-JB-x-RCx	12 9/16"	14 1/2"	17 13/16"
202-JB-x 202-JB-x-RCx			
SP202-JB-x SP202-JB-x-RCx			
202W-JB-x 202W-JB-x-RCx	17"	19 5/8"	22 11/16"
203-JB-x 203-JB-x-RCx			
203F-JB-x 203F-JB-x-RCx			
204-JB-x 204-JB-x-RCx			
202-JB-x-HD-ADJ SP202-JB-x-HD-ADJ	14"	15 1/8"	18 1/2"
202W-JB-x-HD-ADJ	17"	18 1/8"	21 1/2"

Underfloor Duct Raceway Aftersets and Marker Caps

Flush Insert Duct		Description	Catalog Number		
Afterset Insert		Provides means to add activation inserts in the field where needed prior to concrete pour. 14 gauge steel.	1-Gang	1 1/2" Insert Height	DAIFA-1G-15
				2" Insert Height	DAIFA-1G-2
				3" Insert Height	DAIFA-1G-3
			2-Gang	1 1/2" Insert Height	DAIFA-2G-15
				2" Insert Height	DAIFA-2G-2
				3" Insert Height	DAIFA-2G-3
			3-Gang	1 1/2" Insert Height	DAIFA-3G-15
				2" Insert Height	DAIFA-3G-2
				3" Insert Height	DAIFA-3G-3
Marker Cap		Marker caps are used in place of standard insert caps in (a) each insert adjacent to junction box, (b) inserts on each side of a permanent wall, and (c) the last insert in each run of duct.	Insert Marker Cap:		
			Zinc Screw	FA-DMC-Z	
			Brass Screw	FA-DMC-B	
Compartment Cover		Used for abandoning preset opening (one per gang). 18 gauge steel. Customer is required to fill void over top of plate with concrete.	Blank Cover	FA-MC	

Round Insert Duct		Description	Catalog Number	
Afterset Insert		Provides means to add activation inserts in the field where needed prior to or after concrete pour. Zinc die cast.	1 " Insert Height	DAI-1
			2 " Insert Height	DAI-2
			3 " Insert Height	DAI-3
			4 " Insert Height	DAI-4
Marker Cap		Marker caps are used in place of standard insert caps in (a) each insert adjacent to junction box, (b) inserts on each side of a permanent wall, and (c) the last insert in each run of duct.	Insert Marker Cap:	
			Zinc Screw	DMC-Z
			Brass Screw	DMC-B
Reducing Bushing		Reduces threaded 2" IPS insert opening to either 3/4" NPT or 1" NPT threaded opening for attachment of conduit fitting or pedestal fitting chase nipple.	2" to 3/4"	RB-162
			2" to 1"	RB-163

Underfloor Duct Raceway Activation Kits

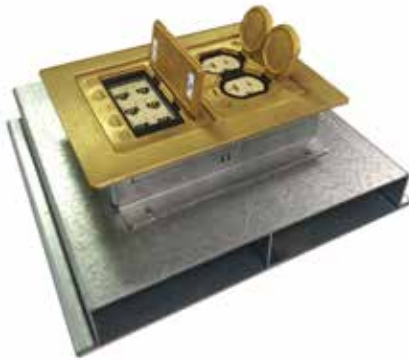

- Available in brass and brushed aluminum to meet aesthetic requirements
- Available in one, two and three-gang options
- ScrubShield® Complies with UL514A scrub water requirements
- Flanged design may be used in tile, wood, carpet, terrazzo and bare concrete applications
- Uniform look when used in same areas where Hubbell floor boxes are installed
- Blank Closure Plates are available to close off insert opening when abandoning Activation Kits. Plates are available in single, double and triple-gang configurations in brass, aluminum and stainless steel. Consult factory for additional information.

Flush Insert Underfloor Duct		Finish	1-Gang 6" x 4.85"	2-Gang 6" x 8.13"	3-Gang 6" x 11.34"	
Flanges	Flanges are provided with adapter plates and accessories required for installing to rectangular Underfloor Duct preset inserts and aftersets.	Brass	SB3083W-UFD	SB3084W-UFD	SB3085W-UFD	
		Aluminum	SA3083W-UFD	SA3084W-UFD	SA3085W-UFD	
Covers	All Covers 4.15" x 2.99"		Duplex Flap	Duplex Screw	Style Line Decorator Opening	Combination 2 1/8" x 3/4"
		Brass	S3825	S3625	S3826	S2425
		Aluminum	SA3825	SA3625	SA3826	SA2425
			Combination 2 1/8" x 1"	2 1/8" Single Receptacle	2 3/8" Single Receptacle	Blank
		Brass	S2625	S2825	S3425	S3813
		Aluminum	SA2625	—	—	SA3813

Round Insert Underfloor Duct								
Housing	Die-cast aluminum frame, brushed aluminum housing, chase nipple, without plates	1" Chase Nipple	SC3099A					
		3/4" Chase Nipple	SC3098A					
Plates	Duplex Receptacle	Single Receptacle 1.39" (35.3 mm) opening	Style Line Decorator	Blank	Telephone bushing 1 in. I.D. and (2) 3/8" KO for coax	Furniture Feed aluminum plate with 3/4" trade size KO	Furniture Feed aluminum plate, blank	
		SS309D	SS309S	SS309DS	SS309B	SS309T	SS309SF	SS309BF

Hubbell SystemOne—*One Look for Any Capacity*

SystemOne—part of Hubbell's Delivery Systems line—was born from a desire to create a common look for fire-rated poke-throughs and floor boxes. This innovative system allows you to create custom solutions for multi-service applications that require both flush in-floor boxes and fire-rated poke-throughs.



Hubbell SystemOne Literature



4 Inch
Solutions



Recessed
Floor Boxes



10 Inch
Fire-Rated
Poke-Throughs

Literature Support

Hubbell offers an extensive literature library for product support. Downloadable PDFs are available on our website, under the resources tab.