

Load:Logic[®] Control Panels

HUBBELL[®]
Wiring Device-Kellems



Space Control



Hubbell Control

Distributed Control



Centralized Control



Load:Logic® Panels



Save Time

- Compact single enclosure includes relays, control functions and input terminals for low voltage devices.
- All inputs are software assignable to any Hubbell low voltage input device including switches, occupancy sensors, and photocells.
- LCD user interface incorporates easy to follow, intuitively configured tools.

Meet Energy Efficiency Standards

- Load:Logic Panels meet ASHRAE 90.1, IECC, and California (CEC) Title 24 energy codes.
- Load:Logic Panels contribute to LEED certification requirements.
- Allows multiple low voltage inputs from Hubbell switches, occupancy sensors, and photocells.

Lower Cost

- Can save up to 50% in parts and labor cost over conventional time clock and contactor systems.
- Lowers energy consumption with expanded programming options.
- Pre-configured scenarios offer a wide variety of options to maximize energy savings for each possible control zone.

Increase Control

- Sunrise/sunset controls provided using an internal astronomical clock eliminate the need for roof mounted photocells.
- Scenarios offer many easy to use control combinations.
- Priorities and masking allow for personalized control solutions.



Product Installation Features

The Hubbell Load:Logic panels are self-contained load control systems. All inputs are low voltage and hard-wired to terminal blocks in the panel. Input power supply is multi-tapped for typical service voltages. Line voltage terminals are located with generous space for easy connection.

- 1 Load:Logic Panel User Interface**
The easy to use and understand LCD Display with keypad has been designed based on input styles of commonly used devices, such as cell phones.
- 2 Panel Door Lock**
The panel is designed to be locked once the qualified electrician has completed all connections. All programming, system status, and manual controls are available via the User Interface once the door is secured.
- 3 Low Voltage Input Device Wiring Diagrams**
Indicates point-to-point connection requirements for each type of device.
- 4 Line Voltage Input Leads**
These leads are marked for various input supply voltages.
- 5 Control Power Transformer**
This transformer has multi-tap leads to be connected to a common input line voltage supply.
- 6 Control Power Disconnect**
A disconnect plug is provided for low voltage input control power to allow for safe removal and replacement of relay cards.
- 7 Individual Relay Card**
Relays are individually mounted for easy replacement, improved reliability and to allow for panels to include any mix of relay types.
- 8 Relay Manual Override Button**
Allows for relays to be manually operated. Manual control of relays is also available through the User Interface.
- 9 Relay Status Light**
Indicates relay operation status.
- 10 Relay Board Input Terminal Block**
Most types of low voltage input including Switches, Occupancy Sensors or Photocells may be connected to any relay input terminal block. These inputs are software assignable as to type and control.
- 11 Line Voltage Control Circuit Terminals**
Circuits are connected to these heavy duty screw terminals. Each terminal will accommodate two #14-#10 stranded or solid copper wire of the same type and size.
- 12 Auxiliary Inputs**
The Load:Logic Panel is supplied with additional low voltage inputs to accommodate a wide variety of control scenarios that require more than one input for a relay or group. The panel accepts inputs such as low voltage switches, occupancy sensors, photocells and dry contact signals from a 3rd party energy management system to indicate an action in response to an event, such as a Demand Response.
- 13 Dry Contact Output Terminals**
Each Output Terminal allows for the Load:Logic Panel to signal other systems with N.O./N.C. momentary or maintained contacts.
- 14 Master/Secondary Panel Interface Card Connector**
Cards provided with the secondary panel provide easy RJ45 connection with UTP category based cable.
- 15 Wireway Divider**
Separates Line and Low Voltage wiring.

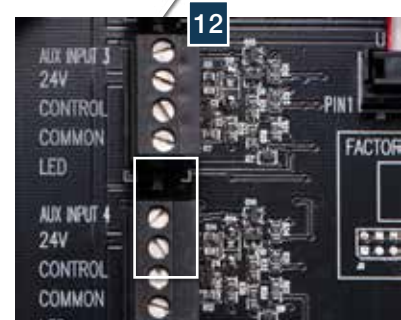
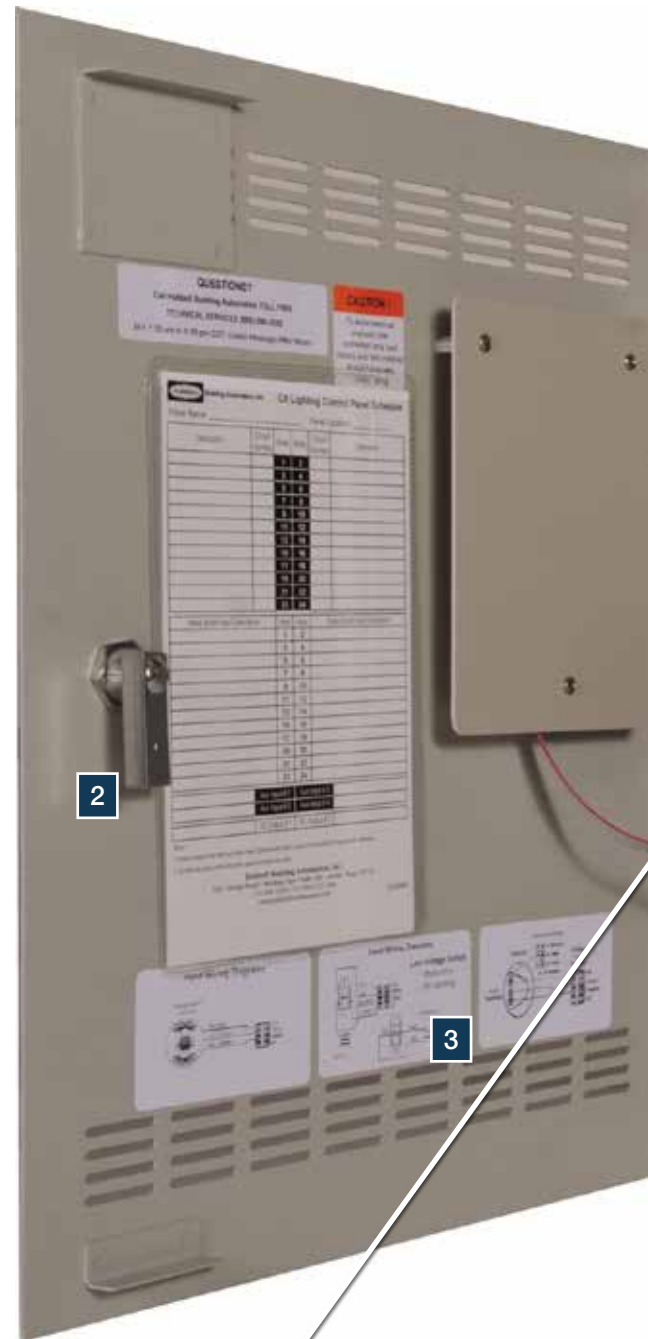

Auxiliary Inputs

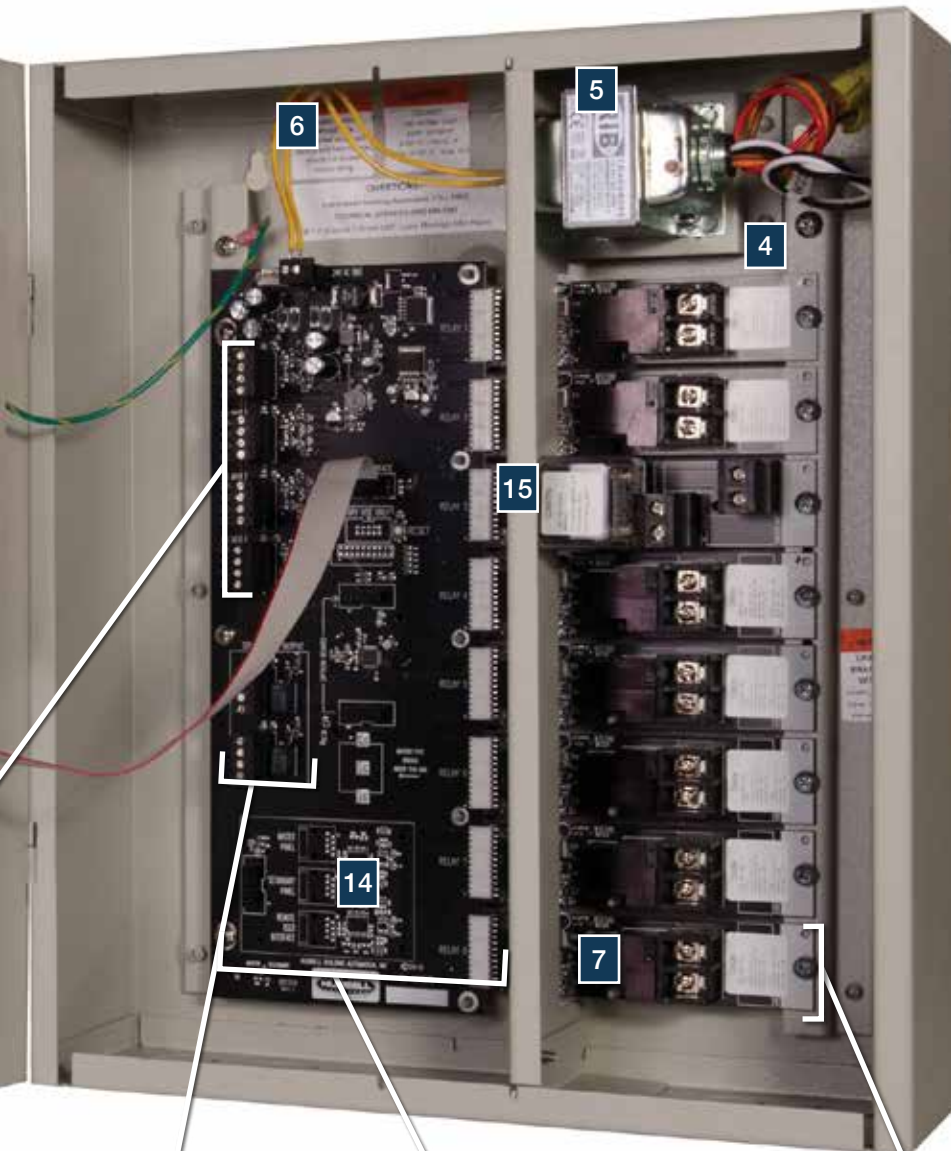

Load:Logic 8-Relay Panel Interior

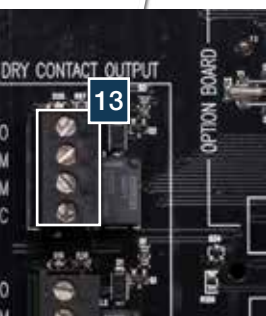

Dry Contact Outputs



Dimming Card



Individual Mounted Relay Card



Auxiliary Input Features

- Provisions for multiple device control of a single relay or group
- Scenarios program allows for easy mapping of auxiliary inputs

Dry Contact Output Features

- Normally open or normally closed output
- Momentary or maintained
- Allows for interconnection to other building functions such as security, fire alarm, or building management system

Relay Card Features

- 1-pole and 2-pole relays fit in the same sized space
- Relay self-identifies once installed
- Available 20A/1P N/O, 20A/2P N/O or N/C and 30A/1P latching

Dimming Card Features

- Full range dimming with preset dimming levels
- Ramp Up, Fade Down, Minimum Dim Level, Max Dim Level (Demand Response System Settings)
- Operates with 0-10V dimmable ballasts
- 8 Dimming channels per card
- Switches feature RJ45 connectivity

Load:Logic® Panel Configurations

The easy to use color LCD display has been designed based on inputs used in common mobile devices and digital equipment.

LCD Display

Allows for most programming to be completed in a single screen. Right side scroll bars appear when more choices are available than currently visible.

Alpha-Numeric Keypad

This keypad is used to populate names and numeric values while programming.

Keys

Function Keys – These keys provide programming choices in various screens. Key labels appear on-screen when keys are available.

Escape Key – This key takes the user to the previous screen. Warning prompts when changes have been made but not saved.

Help Key – This key will bring up help screens in specific locations driven by the field that is highlighted.

Navigation Keys – Allows user to navigate Up/Down/Right/Left/Toggle through editable fields to select program choices.

Enter Key – Use this key to make selections.

Load:Logic® Main Menu

The Load:Logic Panel Main Menu presents easy to understand programming and system status choices. Press ENTER to begin programming from system home screen. Simply scroll up/down and then press ENTER to navigate to menu choices.

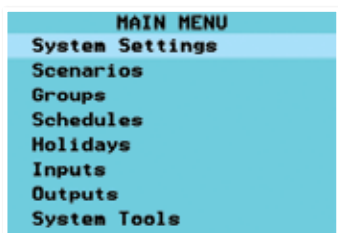

So SIMPLE and INTUITIVE Complete configuration in less than 30 minutes.

- Simple Arrow navigation and Enter buttons make selections easy.
- Color LCD screen allows for settings to be made in a single screen.
- All Low Voltage Inputs are assignable to any type of control device.
- Help screens are available throughout the program by touching the HELP key when the  symbol appears.
- Naming is made easy through selectable name input.
- Choose City and State from a large list of pre-configured longitude and latitude values.

The Scenarios programming feature allows the user to select from a group of pre-configured control schemes to easily assign relays and inputs for the desired actions. The use of Scenarios shortens configuration time by only requiring a unique input that assigns properties, masking and priorities to a predetermined operation mode.

Indoor Scenarios:

- Manual Switch ON/Auto Occupancy Sensor OFF
- Photocell ON/OFF/Override Switch
- Switch-Occupancy ON/OFF/Photocell OFF
- Manual Switch ON/Occupancy-Photocell OFF
- Schedule ON/Schedule OFF/Override Switch
- Schedule ON/Schedule OFF/Blink Override Switch
- Schedule ON/Schedule OFF/Blink Sweep Switch
- Schedule ON/Schedule OFF/Sensor ON-OFF After Hours
- Master Override All Programming Switch
- Many More Scenarios are Available

Outdoor Scenarios:

- Photocell ON/Photocell OFF
- Photocell ON/Schedule OFF/Override Switch
- Astro ON/Schedule OFF/Override Switch

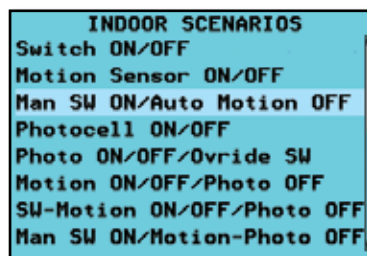

Load:Logic® Programming Specifications

The Load:Logic Panel has a diverse set of configuration capabilities designed to meet or exceed the current energy codes and standards to give maximum flexibility to building users. The User Interface Main Menu is the gateway to easy input and development of system programming for the project. The system provides the following capabilities:

- System Settings for **Time and Date**, **Astronomical Clock** and **System Global** Settings
 - Astronomical Clock Select from a list of major U.S. cities
 - Relay Function, Blink Alert, and After Hours Sweep
 - 4 Open/Close time schedules
 - Panel Names, Power ON settings, and Display settings
- Outputs are programmable to be activated by any schedule or input
 - Maintained or Momentary, Normally Open or Normally Closed contact form selection
- Holidays may be “Block Schedule” dates or may have Holiday Schedules applied
 - A master list of standard holidays may be chosen as recurring year-after-year dates
 - 99 custom Month-Day-Years dates may be programmed
 - 4 Holiday schedules can be created and applied to any of the 99 dates
- Inputs are program assignable to any type of device
 - Switches, Occupancy Sensors, or Photocells can be connected to any input
 - Inputs may be jumpered and mapped to additional relays or groups
 - 4 levels of Priority can be applied to ON and OFF events independently
 - Masking can be applied to ON and OFF events independently
 - Panel provides device power for 8 devices on 4/8 relay panels, 24 devices on 16 relay panels, and 30 devices on 24 relay panes.
- System Tools include Access Control, Manual Control, Diagnostics and System Information
 - Program Save/Back-up/Restore
 - Upload/Save Program

Load:Logic® Control Panels

Load:Logic® Stand Alone, Master and Secondary Panels

The Hubbell Load:Logic Control Panels provide feature-rich and cost effective control for maximum energy savings. The LCD user interface is located in the door and utilizes simple and intuitive scrolling menus to configure, check status or update the panel. The easy to use Pre-Configured Scenarios Menu makes project commissioning simple and fast.

04 Configurations

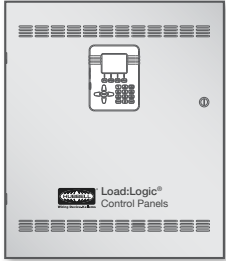

4-Relay Stand Alone*
*not available as a master or secondary panel

08 Configurations



8-Relay Master



8-Relay Secondary

16/24 Configurations

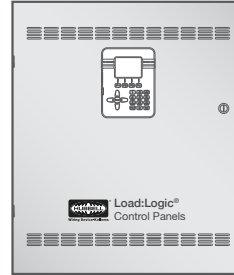

16/24-Relay Master

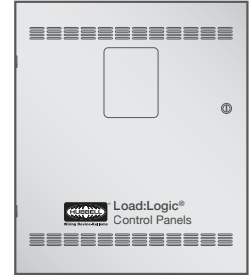

16/24-Relay Secondary

Flexible Design Applications

Load:Logic Master/Secondary Panels are easily applicable to a wide range of small to medium commercial projects.

Load:Logic® Master and Secondary Connections

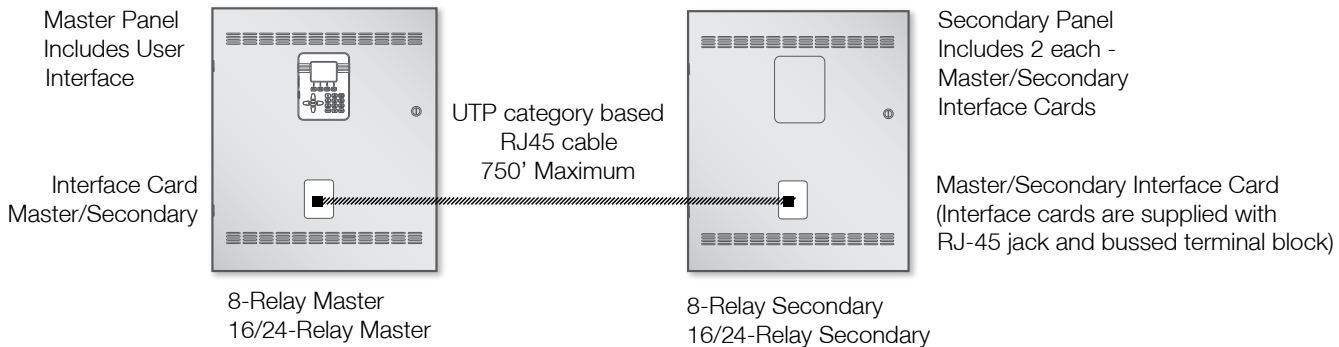

Load:Logic® Panel Typical Input Connections

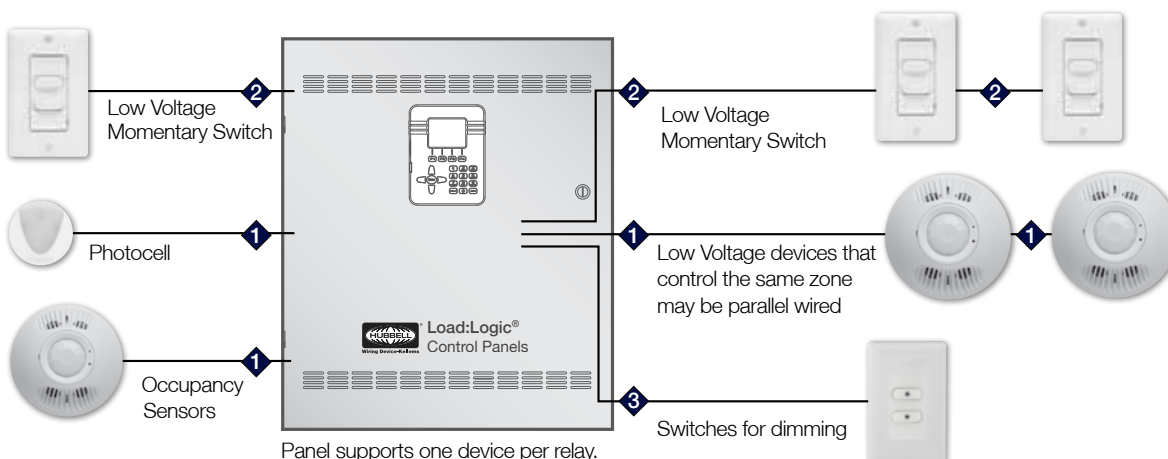

Cables

- ❖ 1 3 #18 insulated class 2 copper wire.
- ❖ 2 #18 insulated class 2 copper wire. Number of wires varies based on number of buttons and LED indication.
- ❖ 3 UTP category based RJ45 patch cord

Selecting Load:Logic - Easy as 1, 2, 3

- Step 1** Select the control panel
- Step 2** Select the appropriate relays
- Step 3** Select the appropriate switches
- Step 4** Select a dimming card, if required
- Step 5** Select appropriate sensors

Load:Logic® Control Panels

4 and 8-Relay Panels

| Description | 4-Relay | | 8-Relay | |
|--|------------------|------------------|------------------|------------------|
| | Stand Alone | Master | Master | Secondary |
| Relay panel with space for field installation, 120/208/240/277V AC | CP042RRR3 | CP082RRR1 | CP082RRR1 | CP082RRR2 |

16 and 24-Relay Panels

| Description | 16-Relay | | 24-Relay | |
|--|------------------|------------------|------------------|------------------|
| | Master | Secondary | Master | Secondary |
| Relay panel with space for field installation, 120/277V AC | CP162RRR1 | CP162RRR2 | CP242RRR1 | CP242RRR2 |
| Relay panel with space for field installation, 480V AC | CP163RRR1 | CP163RRR2 | CP243RRR1 | CP243RRR2 |



16-Relay Panel

4- and 8-Relay Panel

Relays - Field Installed

- Four types of available relays for Load:Logic Panels
- Relays are individually board mounted and can be installed in any combination in the panel
- Types include electrically held normally open (N/O), electrically held normally closed (N/C), and latching. Ratings are 20A/1P 20A/2P, and 30A/1P.
- Relays can be field installed

Field Installed Relays

| Description | Catalog Number |
|---|----------------|
| 20A 1-Pole Electrically Held N/O 120-277V 14KSCCR @ 277VAC | R21HN |
| 30A 1-Pole Latching 120-277-347V 18KSCCR @ 277VAC, 14KSCCR @ 347VAC | R31LX |
| 20A 2-Pole Electrically Held N/O 480V 14KSCCR @ 480VAC | R202HN |
| 20A 2-Pole Electrically Held N/C 480V 14KSCCR @ 480VAC | R202HC |



R21HN
20A/1P 14K SCCR



R31LX
30A/1P 18K SCCR



R202HN, R202HC
20A/2P 14K SCCR

Low Voltage Switches

- Attractive, architectural design
- Available latching or momentary contact configurations
- Mounts to standard single-gang box

Low Voltage Switches

| Description | Ivory | Gray | Light Almond | White |
|--|-----------------|------------------|------------------|-----------------|
| Low voltage switch, momentary, 1 button | DSM30I1 | DSM30GY1 | DSM30LA1 | DSM30W1 |
| Low voltage switch, momentary, 2 button | DSM30I2 | DSM30GY2 | DSM30LA2 | DSM30W2 |
| Low voltage switch, momentary, 1 button with LED pilot light | DSM30I1P | DSM30GY1P | DSM30LA1P | DSM30W1P |
| Low voltage switch, momentary, 2 button with LED pilot light | DSM30I2P | DSM30GY2P | DSM30LA2P | DSM30W2P |
| Low voltage switch, momentary, 4 button with LED pilot light | DSM30I4P | DSM30GY4P | DSM30LA4P | DSM30W4P |



DSM30W1

Ordering Information

Dimming Load: Logic Interface Card

- Full range dimming with preset dimming levels
- Ramp Up, Fade Down, Minimum Dim Level
- Max Dim Level (Demand Response System Settings)
- Operates with 0-10V dimmable ballasts
- Eight Dimming channels per card



Interface Cards

| Description | Catalog Number |
|---|------------------|
| 8-channel dimming controller option board with manual and automatic control of dimming levels | CPDM8CTRB |

Dimming Switches (Use only with dimming card option)

| Color | 1 button | 2 button | 3 button | 4 button | 6 button* |
|--------------|----------------|----------------|----------------|----------------|----------------|
| Ivory | CPSD1I | CPSD2I | CPSD3I | CPSD4I | CPSD6I |
| Gray | CPSD1GY | CPSD2GY | CPSD3GY | CPSD4GY | CPSD6GY |
| Light Almond | CPSD1LA | CPSD2LA | CPSD3LA | CPSD4LA | CPSD6LA |
| White | CPSD1W | CPSD2W | CPSD3W | CPSD4W | CPSD6W |



**CPSD Series
with RJ45
Connectivity**

Note: *6 button option only available by special order.

2, 3, and 4 button switches are supplied with "ON," "OFF," raise, lower button caps.



CPSD1W



CPSD2W



CPSD3W



CPSD4W



CPSD6W

Ceiling Sensors

- "Install and forget" operation
- Photocell and relay to interface with auxiliary systems such as HVAC (CRP models)
- ASHRAE 90.1 and CEC Title 24 Compliant

Dual (Ultrasonic and Passive Infrared)

Combines the excellent minor motion detection of ultrasonic with the outstanding passive infrared (PIR) long-range major motion detection.

| Description | Color | Coverage Area | |
|--|--------------|---------------------|---------------------|
| | | 2000 sq. ft. (360°) | 1000 sq. ft. (180°) |
| Low voltage sensor with photocell and isolated relay | Office White | ATD2000CRP | ATD1000CRP |
| Low voltage sensor | Office White | ATD2000C | |



ATD2000C



ATD1000CRP

Ultrasonic (Excellent minor motion detection)

| Description | Color | Coverage Area | |
|--|--------------|---------------------|---------------------|
| | | 2000 sq. ft. (360°) | 1000 sq. ft. (180°) |
| Low voltage sensor with photocell and isolated relay | Office White | ATU2000CRP | ATU1000CRP |
| Low voltage sensor | Office White | ATU2000C | |



ATP1500C

Passive Infrared (Outstanding long range major motion detection)

| Description | Color | Coverage Area 1500 sq. ft. (360°) |
|--|--------------|-----------------------------------|
| Low voltage sensor with photocell and isolated relay | Office White | ATP1500CRP |
| Low voltage sensor | Office White | ATP1500C |

Wall Mount Sensors

- “Install and forget” operation
- Swivel mounting bracket included for wall or ceiling mounting
- All digital sensing technology
- Photocell for daylight harvesting and relay interface with auxiliary systems such as HVAC (RP models)
- 24V DC, 33mA
- ASHRAE 90.1 and CEC Title 24 Compliant
- cULus



ATD1600WRP



**ATP1600WRP,
ATP120HBRP**

Dual (Ultrasonic and Passive Infrared)

| Description | Coverage | Color | Catalog Number |
|--|--------------|--------------|-------------------|
| Low voltage sensor 32kHz with photocell and isolated relay | 1600 sq. ft. | Office White | ATD1600WRP |

Passive Infrared

| Description | Coverage | Color | Catalog Number |
|---|-----------------|--------------|-------------------|
| Low voltage sensor with photocell and isolated relay | 1600 sq. ft. | Office White | ATP1600WRP |
| Low voltage sensor for aisle and high bay applications, with photocell and isolated relay | 120 linear feet | Office White | ATP120HBRP |

Note: All wall mount sensors must use a CU series control units.

Daylight Harvesting

- Multiple calibration options
- Low-profile design
- Light-sensitivity wide range of options



RCDP



**DHAP,
DHSP**



DHOP

| Description | Voltage | Catalog Number |
|--|---------|----------------|
| Single zone continuous automatic dimming control | 10V DC | DHADC |
| Indoor photocell | 24V DC | DHIP |
| Outdoor photocell | 24V DC | DHOP |
| Atrium photocell | 24V DC | DHAP |
| Skylight photocell | 24V DC | DHSP |
| Daylight tracker with ON/OFF control | 24V DC | DHT |
| Daylight tracker with dimming control | 24V DC | DHTD* |
| Indoor Daylight Sensor | 24V DC | RCDP |
| Outdoor Daylight Sensor | 24V DC | RCODP |

Note: *For use with 0-10V DC dimming ballasts.



DHT

Wireless Transmitter

- Low voltage powered unit transmits occupancy or timer status to associated load control receivers.
- Use to upgrade control systems to support automatic receptacle control.
- 24V DC

| Description | Catalog Number |
|---|----------------|
| Wireless transmitter with Clear Connect | WLCA |



WLCA

Replacement Parts

| Description | Catalog Number |
|---|------------------|
| Transformer, 120/208/240/277V AC to 24V AC, 4 and 8-relay panel | CPTFMR27 |
| Transformer, 120-277V AC to 24V AC, 16-24 relay panel | CPTFMR12 |
| Transformer, 347-480V AC to 24V AC, 16-24 relay panel | CPTFMR48 |
| Panel replacement motherboard for 4-relay panel | CPMBRD04 |
| Panel replacement motherboard for 8-relay panel | CPMBRD08 |
| Panel replacement motherboard for 16-24 relay panel (8-relays) | CPMBRD16 |
| Master controller, replacement kit | CPMCTRRKT |

Load:Logic® Control Panels



Resources | Online

Hubbell offers a landing page dedicated to energy savings. Be sure to visit the Hubbell Wiring-Device Kellems website for more information.

Also Online | Literature

Hubbell offers an extensive literature library for product support. Downloadable PDFs are available online.

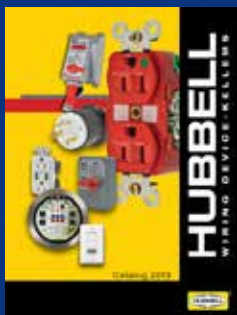

Hubbell
Wiring Device-Kellems
Catalog



Hubbell Load:Logic®
Room Controllers



Permanently Marked
Control Receptacles
for ARCS



Hubbell H-MOSS®
Occupancy Sensor
Application Guide

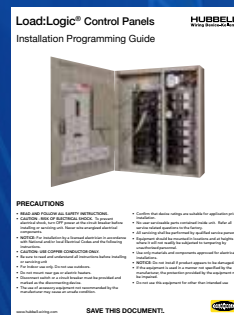

Load:Logic Instruction
and Programming Guide

HUBBELL®
Wiring Device-Kellems

www.hubbell-wiring.com

