

NOTE: FOR INSTRUCTION SHEETS SCROLL DOWN TO SHEET 2 & 3

LIST OF PARTS

DESCRIPTION	MATERIAL	FINISH
SPACER	STEEL	GALVANIZED
SIDES	STEEL	GALVANIZED
STUD BRACKET	STEEL	GALVANIZED
FARSIDE SUPPORT	STEEL	GALVANIZED
FASTENERS	STEEL	GALVANIZED
STAB-IT® CLAMP	STEEL	GALVANIZED
PIG TAIL	COPPER	
CABLE MANAGEMENT	STEEL	GALVANIZED

INSTALLED

- NOTES:**
- ALL DIMENSIONS ARE IN INCHES AND [MILLIMETERS]
 - BOX VOLUME: 30.3 IN³ [496.5 CM³]
 - 1 #12AWG SOLID COPPER WIRE 8" LONG PIG TAIL WITH GROUNDING SCREW INCLUDED
 - UL LISTED
 - FOR FARSIDE SUPPORT BEND INSTRUCTION SEE SHEET # 2

- ADJUSTABLE**
- 2-1/2" [63.5]
 - 3-1/2" [89]
 - 3-5/8" [92]
 - 4" [101.6]
 - 5.5" [140]
 - 6" [152.4]

U.L. LISTED 600 VOLT MAXIMUM. NO. 12 AWG GREEN TW INSULATED SOLID COPPER WIRE CUT 8-1/2" LONG IN FLAT, STRIPPED 1" IN FROM END.

KNOCKOUTS	
TRADE SIZE	LOCATION
1/2" KO	1- ON THE BOTTOM (ACCESSIBLE FOR 5.5" & 6" STUDS ONLY), 2-ON EACH SIDE, 2 -ON THE SIDE OF THE SPACER
1/2", 3/4" TKO®	1- ON THE BOTTOM (ACCESSIBLE FOR 5.5" & 6" STUDS ONLY), 1-ON EACH SIDE, 1 -ON THE SIDE OF THE SPACER
CABLE PRIOUTS	2- ON THE SIDE OF THE SPACER

CABLE TYPES AND RANGES FOR STAB-IT CLAMP	
CABLE TYPES	CABLE RANGES
AC STEEL & ALUMINUM	14-2,14-3,14-4,12-2,12-3,12-4,10-2,10-3
HCF AC STEEL	14-2,14-3,14-4,12-2,12-3,10-2,10-3
HCF AC ALMINUM	12-2,12-3,12-4,10-2,10-3
MC STEEL & ALUMINIUM	14-2,14-3,14-4,12-2,12-3,12-4,10-2,10-3
MCI-A STEEL & ALUMINIUM	14-2,14-3,14-4,12-2,12-3,12-4,10-2,10-3
HCF MCI-A STEEL	12-2,12-3,10-2
HCF MCI-A ALUMINIUM	14-2,14-3,14-4,12-2,12-3,12-4,10-2,10-3
3/8 TRADE SIZE FLEX,REFM C CONDUIT STEEL & ALUMINUM. ANTI SHORT BUSHING REQUIRED	
CABLE RANGE .400" DIA. MIN TO .605" DIA. MAX	

INITIAL RELEASE	K.K.	DATE
SYM.	REVISION DESCRIPTION	APP

THE DESIGN AND DIMENSIONS OF THE PRODUCT SHOWN ON THIS DRAWING ARE SUBJECT TO CHANGE WITHOUT NOTICE

TITLE: **4" SQ. 2-1/8" DEEP WELDED BOX WITH STAB-IT™ BX/MC CABLE CLAMP**

TOLERANCE UNLESS OTHERWISE SPECIFIED		<p>RACO South Bend, Indiana</p>	SCALE: 1:2
.XX DECIMAL ±.015	DRAWN BY: K.K.		
.XXX DECIMAL ±.005	APP. BY: N.S.		
ANGLE ±2°	DATE: 4/28/2015		

Instructions for using the RACO® Universal Box Stabilizer

1-1/2" Deep Boxes

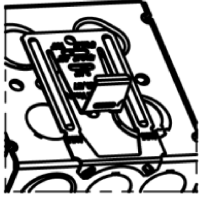

Bend center tab as shown

For 2-1/2" deep studs

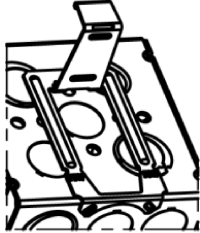

Bend center tab as shown - 2 places

For 3-1/2" deep studs

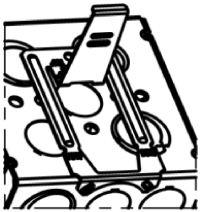

Bend center tab as shown

For 3-5/8" deep studs

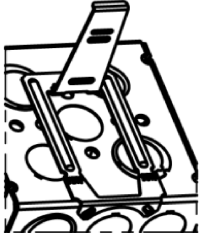

Bend center tab as shown

For 4" deep studs



Bend both tabs as shown

For 5-1/2" deep studs

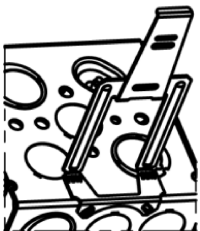

Bend both tabs as shown

For 6" deep studs

2-1/8" Deep Boxes

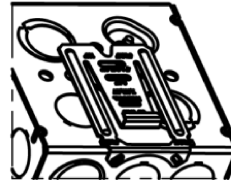

Comes preset

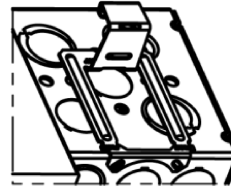

Bend center tab as shown - 2 places

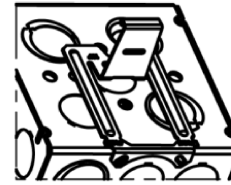

Bend center tab as shown



Bend center tab as shown

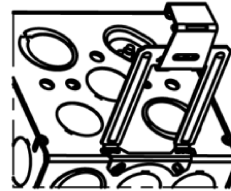

Bend both tabs as shown

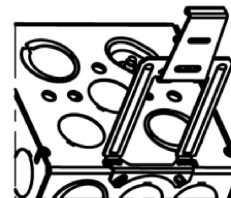

Bend both tabs as shown

NOTICE: Bottom knockouts are NOT usable with the FS support.

Instructions For Using the RACO® Cable Support Bracket with STAB-IT® Boxes

Step 1. Install box to stud.

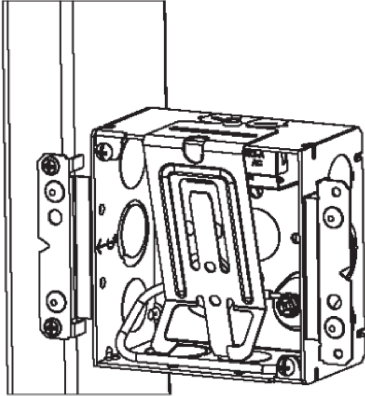

Step 2. Remove Pry-Out(s).

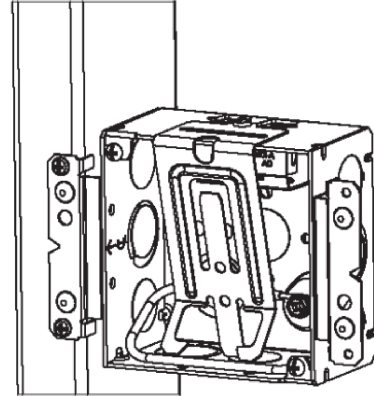

Step 3. Pre-bend Cable Support Bracket as shown and install cables.

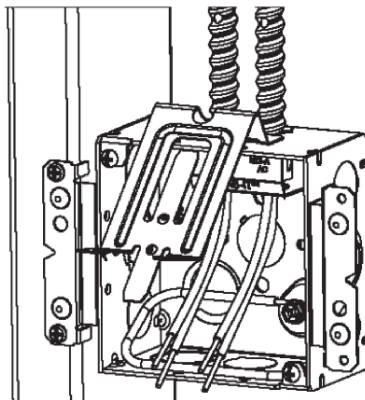

Step 4. Bend Cable Support Bracket as shown.

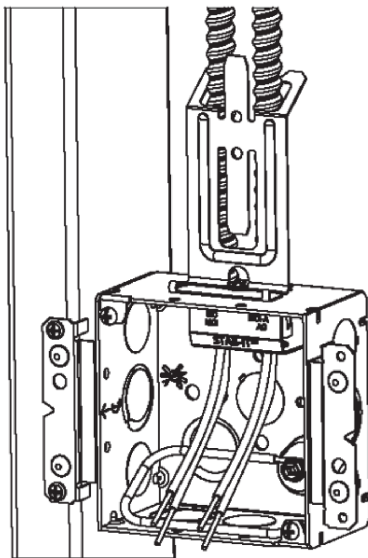

Step 5. Bend down two center tabs to lock cables as shown.

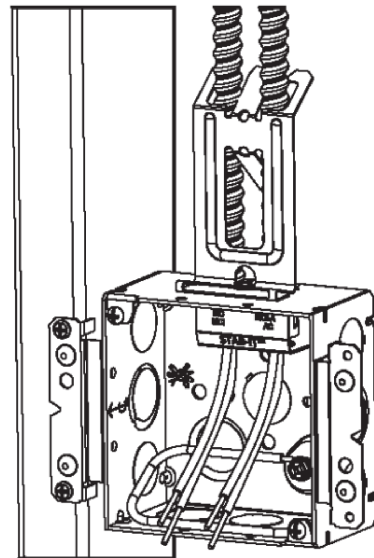

Hubbell Electrical Products
Hubbell Incorporated (Delaware)

RACO INC.
3902 W. Sample St. P.O. Box 4002 South Bend, IN 46634
Phone: (574) 234-7151 FAX (574) 283-4244

MADE IN CHINA

RA-Instr 345
119088