

REV.	DATE	DESCRIPTION	ECO	BY	C'H'K.
A	4/16/2010 11:00:00 AM	CREATE SALES DRAWING	20768	RM	JG

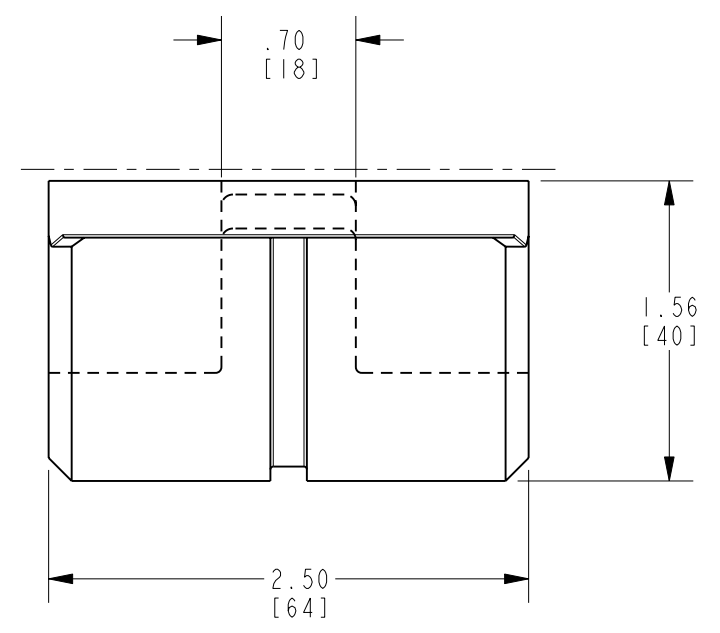
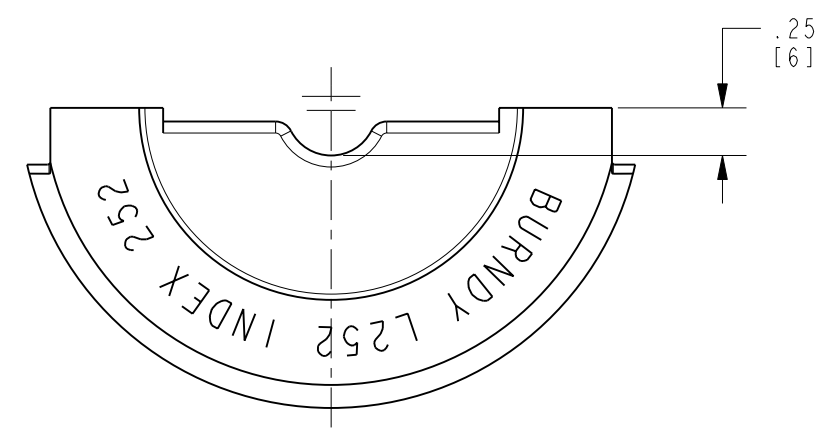
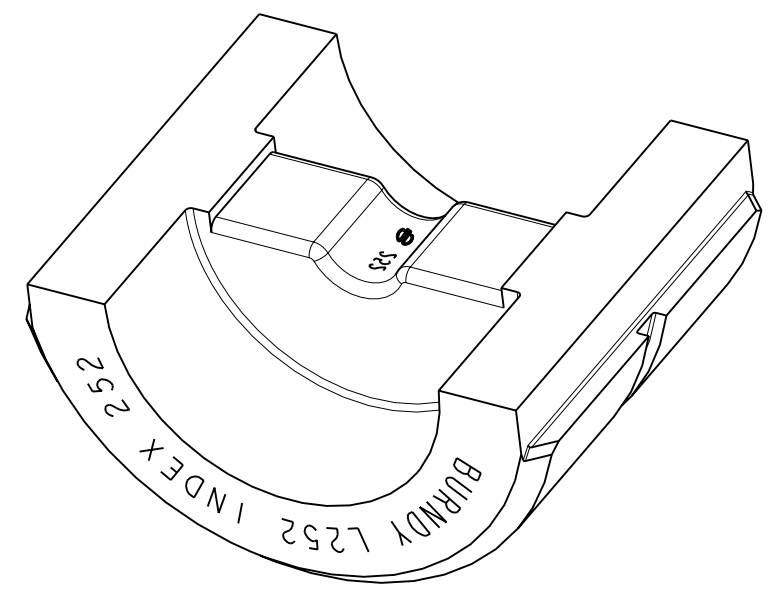
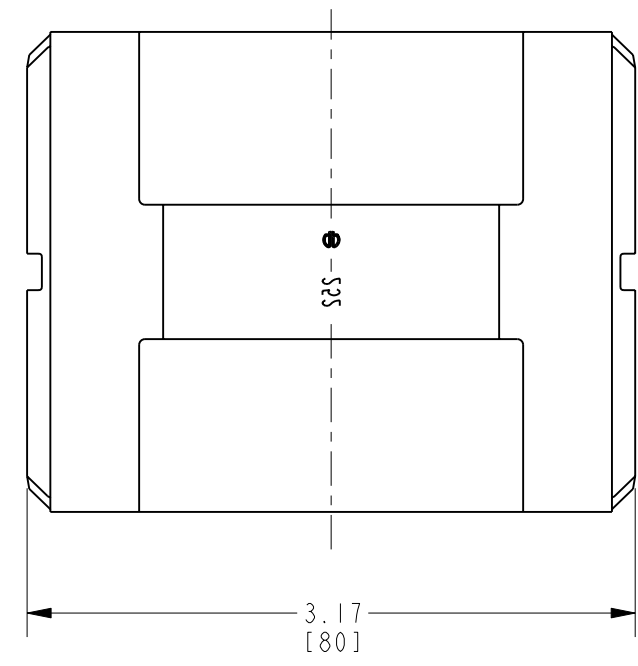

NOTES:

1. DIMENSIONS IN [] BRACKETS ARE IN MILLIMETERS, ROUNDED OFF TO THE NEAREST MILLIMETER, UNLESS OTHERWISE NOTED. METRIC DIMENSIONS ARE FOR REFERENCE ONLY.
2. MATERIAL : STAINLESS STEEL.
3. USED ON Y60 HYPRESS™.

TO ORDER BURNDY® PRODUCTS CALL
 UNITED STATES:
 1-800-346-4175 (LONDONDERRY, NH)
 CANADA:
 1-800-361-6975 (QUEBEC)
 1-800-387-6487 (ALL OTHER PROVINCES)
 FOR PRODUCT INFO: <http://www.burndy.com>

CIRCULAR TWIN DIE		SCALE: 1:1
ITEM NO:	N/A	DRAWING NO
CAT. NO:	L252	
DRAWN BY:	R. MURUGESAN 04/16/2010	SIZE
CHECKER:	--	
DSN APPVL:	--	SHEET 1 OF 1
MFG APPVL:	--	
QA APPVL:	--	
MKT APPVL:	--	
PROD FAM:	TOOLS_HYDRAULIC/L_DIES	
PROJECT #:	--	
DOCUMENT TYPE:	Sales	
REL LEVEL:	Released	

REV: PE0200