

REV.	DATE	DESCRIPTION	ECO	BY	C'H'K.
A	4/16/2010 11:00:00 AM	CREATE SALES DRAWING	20768	RM	JG

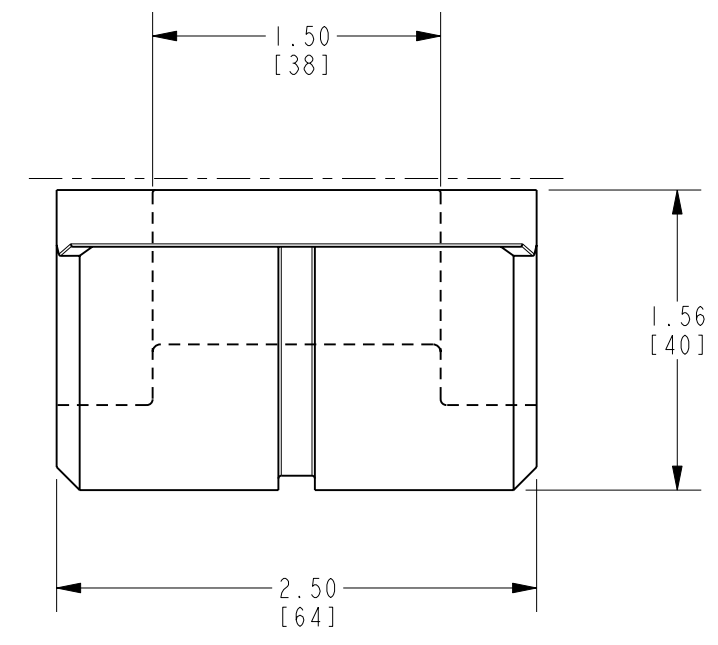
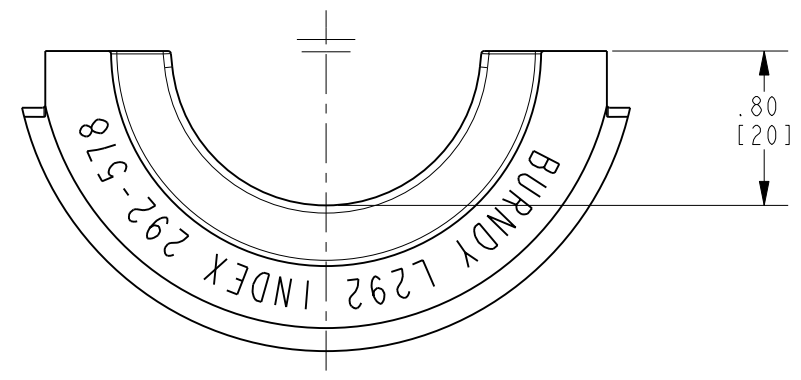
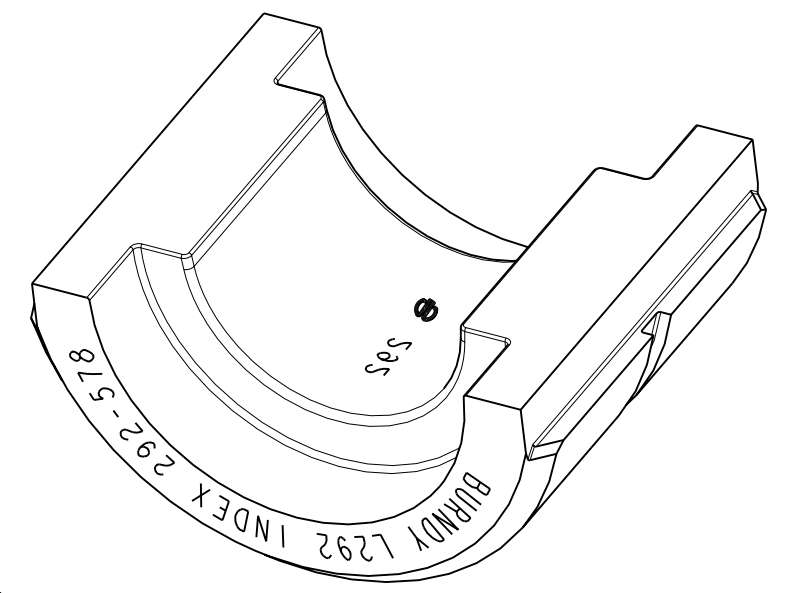
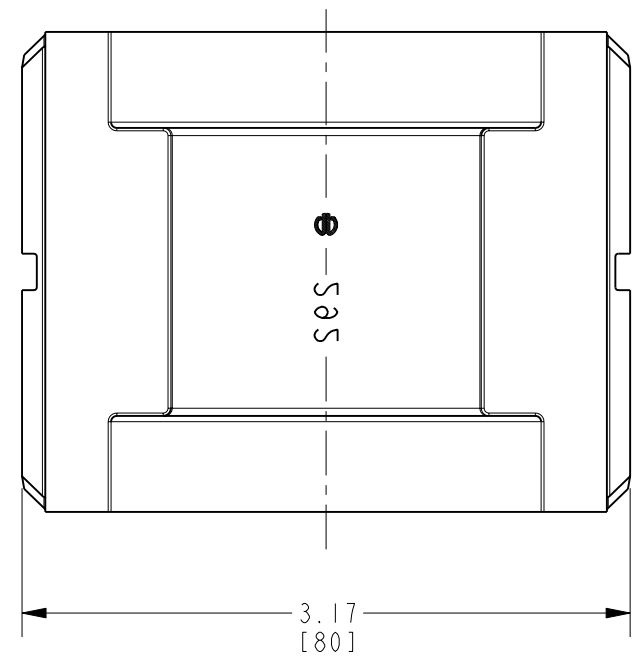

NOTES:

1. DIMENSIONS IN [] BRACKETS ARE IN MILLIMETERS, ROUNDED OFF TO THE NEAREST MILLIMETER, UNLESS OTHERWISE NOTED. METRIC DIMENSIONS ARE FOR REFERENCE ONLY.
2. MATERIAL : STAINLESS STEEL.
3. USED ON Y60 HYPRESS™.

TO ORDER BURNDY® PRODUCTS CALL		CIRCULAR TWIN DIE	
UNITED STATES: 1-800-346-4175 (LONDONDERRY, NH)		ITEM NO: N/A	CAT. NO: L292
CANADA: 1-800-361-6975 (QUEBEC) 1-800-387-6487 (ALL OTHER PROVINCES)		DRAWN BY: R. MURUGESAN 04/17/2010	CHECKER: --
FOR PRODUCT INFO: http://www.burndy.com		DSN APPVL: --	MFG APPVL: --
		QA APPVL: --	MKT APPVL: --
		PROD FAM: TOOLS-HYDRAULIC/L-DIES	SCALE: 1:1
		PROJECT #: --	DRAWING NO: 30000853
		DOCUMENT TYPE: Sales	REV: A
		REL LEVEL: Released	SHEET 1 OF 1

REV: PE0200