

REV	DATE	DESCRIPTION	ECO	BY	C'H.K.
A	08/11/2015	NEW DRAWING CREATED	41221	PB	DD

FEATURES:

ACCOMMODATES BOTH FLEX AND CODE CONDUCTORS

cULus LISTED TO UL1953 (FILE# E74460)

AL9CU RATED

OPTIONAL TOP COVER FOR OPEN STYLE (PART BDBMCSCOVER) FOR ADDED PROTECTION

100kA SCCR RATING WITH CORRECT FUSING

CONTACT CUSTOMER SERVICE FOR ALTERNATE CONFIGURATIONS AT TELEPHONE NUMBER 1 800 346-4175

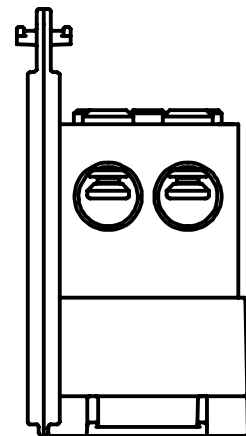
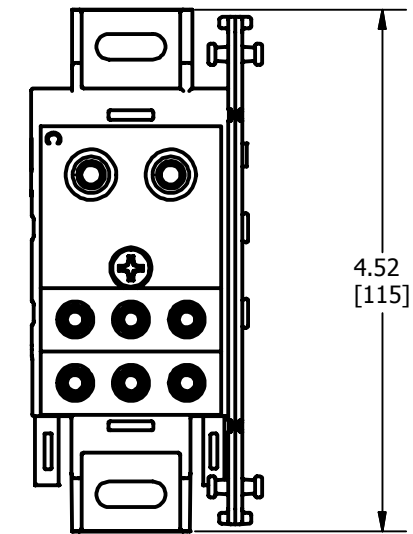
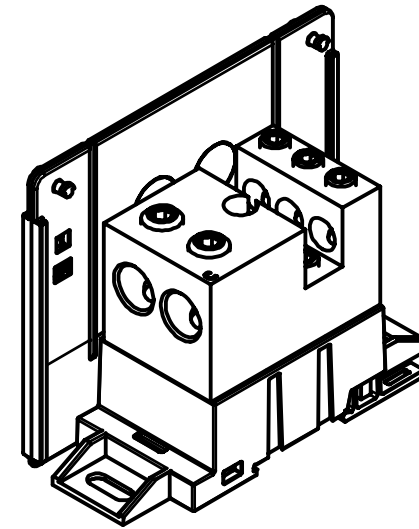

RUN SIDE

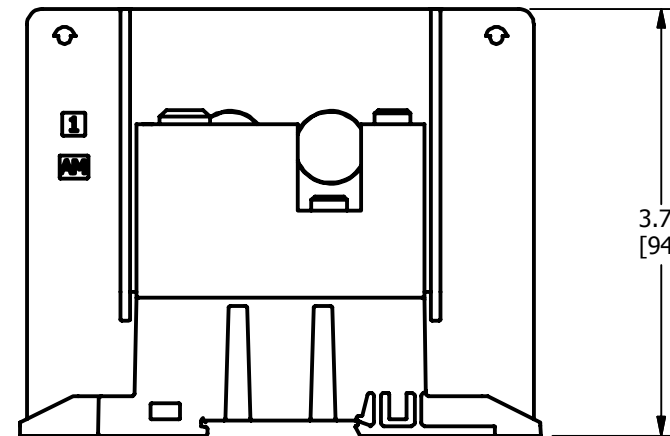

FINGER SAFE STYLE

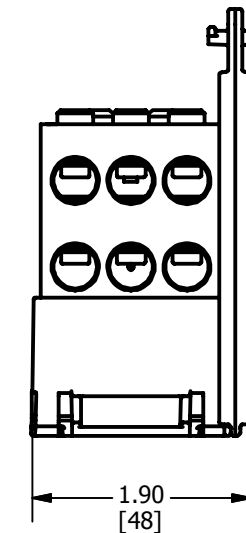

TAP SIDE

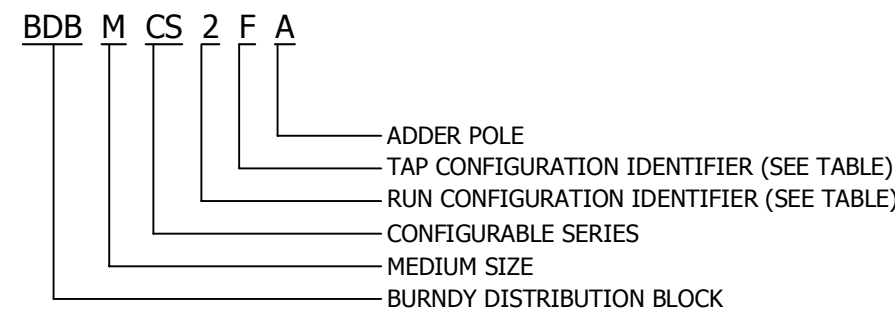

NOTES:

- DIMENSIONS IN BRACKETS [] ARE IN MILLIMETERS ROUNDED OFF TO THE NEAREST MILLIMETER, UNLESS OTHERWISE SPECIFIED AND ARE FOR REFERENCE ONLY.
- MATERIALS: BASE AND POLE SEPERATING SIDES - NYLON 6/6
BLOCK AND RETENTION SCREWS - TIN PLATED ALUMINUM
FINGER SAFE COVERS - POLYCARBONATE
BLOCK MOUNTING HARDWARE - STAINLESS STEEL

3 > 10kA SCCR RATING

TO ORDER BURNDY® PRODUCTS CALL		MEDIUM ADDER	
UNITED STATES 1-800-346-4175 (LONDONDERRY, NH)		ITEM NO: SEE TABLE	
CANADA: 1-800-361-6975 (QUEBEC) 1-800-387-6487 (ALL OTHER PROVINCES)		CAT. NO: SEE TABLE	
FOR PRODUCT INFO: http://www.burndy.com		DRAWN BY: PARTHIBAN B 8/11/2015	
		CHECKER: T REYNOLDS 9/11/2015	
		DSN APRVL: T REYNOLDS 9/11/2015	
		MFG APRVL: M STEVENS 9/15/2015	
		QA APRVL: C KOWALCZYK 9/17/2015	
		MKT APRVL: M BAILLY 9/15/2015	
PROJ #:	SIZE	DRAWING NO	REV
PROJECT #:	B	50063030	A
DOCUMENT TYPE: SALES			
REL LEVEL: Released		SHEET 1 OF 3	

BURNDY MEDIUM DISTRIBUTION BLOCKS

BLOCKS	BLOCK							AMPACITY
	RUN			TAP				
	HOLE LAYOUT	RANGE	TORQUE in-lbs	HOLE LAYOUT	RANGE	TORQUE in-lbs		
BDBMCS2FA	OO (2)	#14 awg - 2/0 B, C, H, I, K, DLO	#14-#6 80 #4-2/0 120	OOO (6)	#14 awg - #2 awg B, C, H, I, K, DLO	#14-#6 80 #4-#2 120	350	
BDBMCS2NA	OO (2)	#14 awg - 2/0 B, C, H, I, K, DLO	#14-#6 80 #4-2/0 120	OO (2)	#14 awg - 2/0 B, C, H, I, K, DLO	#14-#6 80 #4-2/0 120	350	
BDBMCS5FA	O (1)	#4 awg - 500 B, C, H, I, K, 535 DLO	#4-4/0 400 250-535 600	OOO (6)	#14 awg - #2 awg B, C, H, I, K, DLO	#14-#6 80 #4-#2 120	380	
BDBMCS1FA	O (1)	#14 awg - 2/0 B, C, H, I, K, DLO	#14-#6 80 #4-2/0 120	OOO (6)	#14 awg - #2 awg B, C, H, I, K, DLO	#14-#6 80 #4-#2 120	175	
BDBMCS5MA	O (1)	#4 awg - 500 B, C, H, I, K, 535 DLO	#4-4/0 400 250-535 600	OO (4)	#14 awg - 2/0 B, C, H, I, K, DLO	#14-#6 80 #4-2/0 120	380	
BDBMCS3UA	O (1)	#6 awg - 350 B, C, H, I, K, 373 DLO	#6-373 450	O (1)	#6 awg - 350 B, C, H, I, K, 373 DLO	#6-1/0 300 2/0-373 450	310	

3

RUN HOLES		
DIGIT	HOLE LAYOUT	RANGE
1	O	#14 awg - 2/0
2	OO	#14 awg - 2/0
3	O	#6 awg - 350 kcmil
4	OO	#6 awg - 350 kcmil
5	O	#4 awg - 500 kcmil
6	OO	#4 awg - 500 kcmil

RUN HOLES		
LETTER	HOLE LAYOUT	RANGE
A	OOOOO O	#14 awg - #4 awg
B	OOO OOO	
C	OO OO	
D	OO	#14 awg - #2 awg
E	O	
F	OOO OOO	
G	OO OO	#14 awg - 2/0
H	OO	
J	O	
K	OOO OOO	#14 awg - 2/0
M	OO OO	
N	OO	
P	O	#6 awg - 4/0
R	OO OO	
T	OO	
U	O	#6 awg - 350 kcmil
V	OO	
W	O	
X	O	750 kcmil

REV	DATE	DESCRIPTION	ECO	BY	C'H'K.
A	08/11/2015	NEW DRAWING CREATED	41221	PB	DD

TO ORDER BURNDY® PRODUCTS CALL UNITED STATES 1-800-346-4175 (LONDONDERRY, NH) CANADA: 1-800-361-6975 (QUEBEC) 1-800-387-6487 (ALL OTHER PROVINCES) FOR PRODUCT INFO: http://www.burndy.com	MEDIUM ADDER ITEM NO: SEE TABLE CAT. NO: SEE TABLE DRAWN BY: PARTHIBAN B 8/11/2015 CHECKER: T REYNOLDS 9/11/2015 DSN APRVL: T REYNOLDS 9/11/2015 MFG APRVL: M STEVENS 9/15/2015 QA APRVL: C KOWALCZYK 9/17/2015 MKT APRVL: M BAILLY 9/15/2015 PROD FAM: -- PROJECT #: -- DOCUMENT TYPE: SALES REL LEVEL: Released
DRAWING NO 50063030	REV A
SHEET 2 OF 3	

SCCR FUSE VALUES							
OPEN STYLE	J	T	RK1	RK5	G	CC	L
BDBMCS3UA	200	200	100	30	60	30	200
BDBMCS5MA	200	200	100	30	60	30	200
BDBMCS1FA	200	200	100	30	60	30	200
BDBMCS2FA	200	200	100	30	60	30	200
BDBMCS5FA	200	200	100	30	60	30	200

REV	DATE	DESCRIPTION	ECO	BY	C'H'K.
A	08/11/2015	NEW DRAWING CREATED	41221	PB	DD

<p>TO ORDER BURNDY® PRODUCTS CALL</p> <p>UNITED STATES 1-800-346-4175 (LONDONDERRY, NH)</p> <p>CANADA: 1-800-361-6975 (QUEBEC) 1-800-387-6487 (ALL OTHER PROVINCES)</p> <p>FOR PRODUCT INFO: http://www.burndy.com</p>	MEDIUM ADDER		
	ITEM NO: SEE TABLE		
	CAT. NO: SEE TABLE		
	DRAWN BY: PARTHIBAN B	8/11/2015	
	CHECKER: T REYNOLDS	9/11/2015	
	DSN APRVL: T REYNOLDS	9/11/2015	
	MFG APRVL: M STEVENS	9/15/2015	
	QA APRVL: C KOWALCZYK	9/17/2015	
	MKT APRVL: M BAILLY	9/15/2015	
	PROD FAM: --	DRAWING NO	REV
PROJECT #: --	SIZE	50063030	
DOCUMENT TYPE: SALES	B	A	
REL LEVEL: Released	SHEET 3 OF 3		