



PCORE
ELECTRIC

TITLE
SEISMICALLY ENHANCED TEST (SET) TERMINAL

DWG. CATALOG NUMBER

SD B-64008-41-CF

TOP TERMINAL
4 HOLE NEMA PAD @ 1.75 [44.4] SPACING

CURRENT RATING

4000 A

DATE 3-18-15

REV. DATE

WEIGHT 110 lbs [50 kg]

REF.

BOTTOM TERMINAL
4-12 THREAD FEMALE

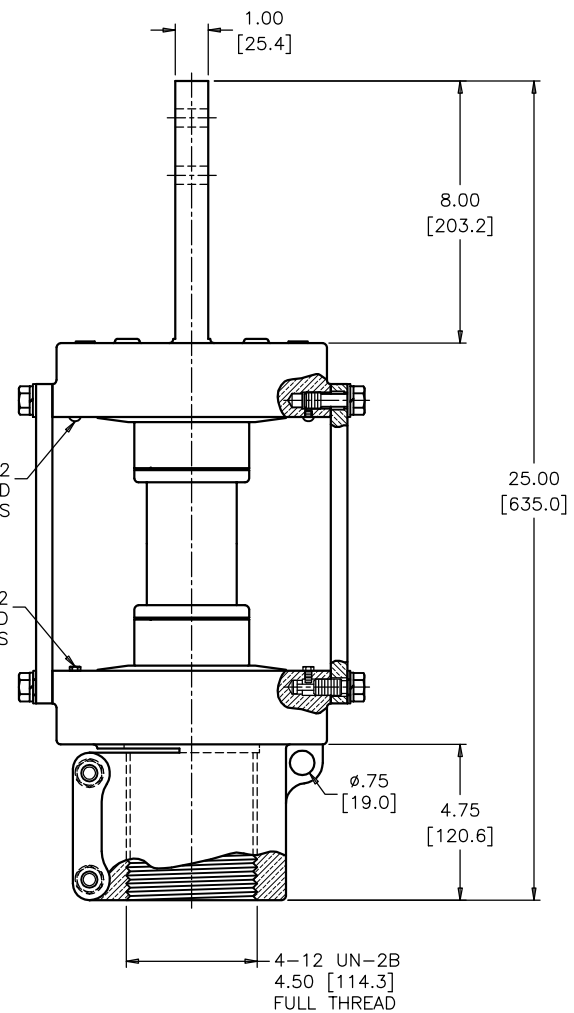
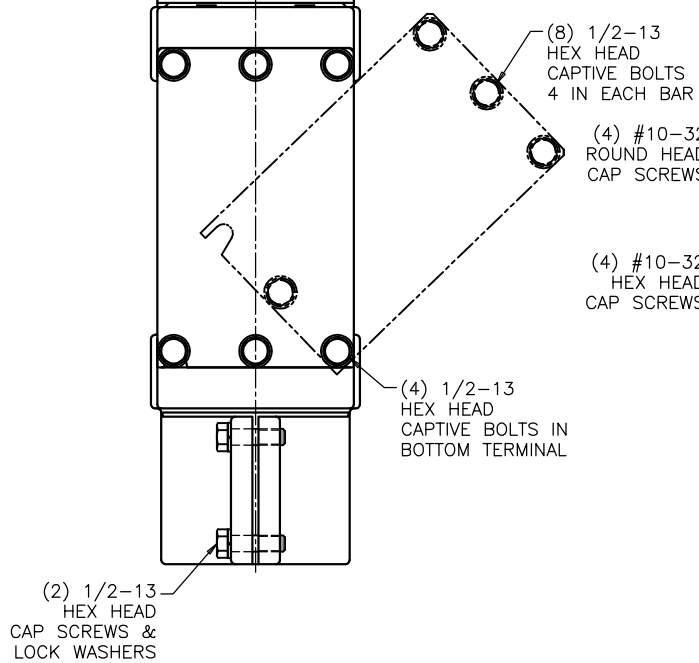
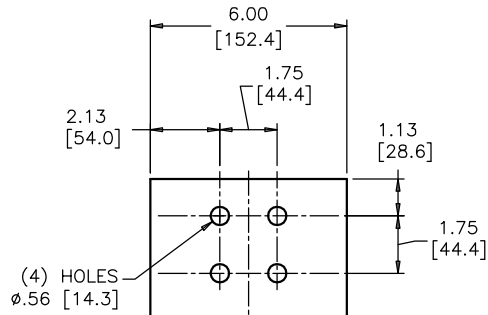
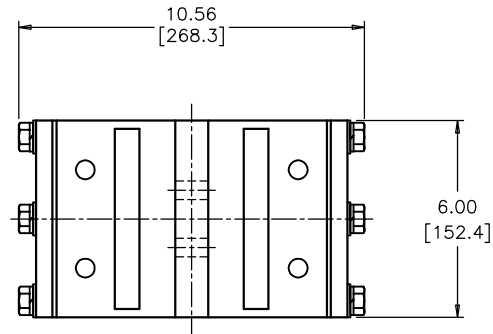

BOLTS ARE EVERDUR AND STAINLESS STEEL
HARDWARE IS HIGH CONDUCTIVITY COPPER - SILVER PLATED

DIMENSIONS IN INCHES [MILLIMETERS]

REVISION

SCALE 1/4

NOTE TO PURCHASER:
ALL SALES OF PCORE PRODUCTS ARE SUBJECT
TO OUR STANDARD TERMS AND CONDITIONS
AND THE LIMITED WARRANTIES THEREUNDER