

**TOP VIEW**

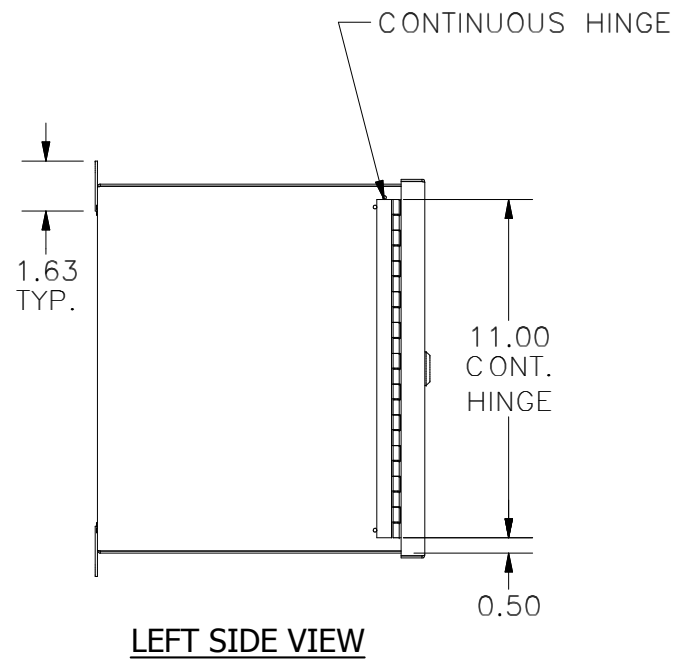

**LEFT SIDE VIEW**

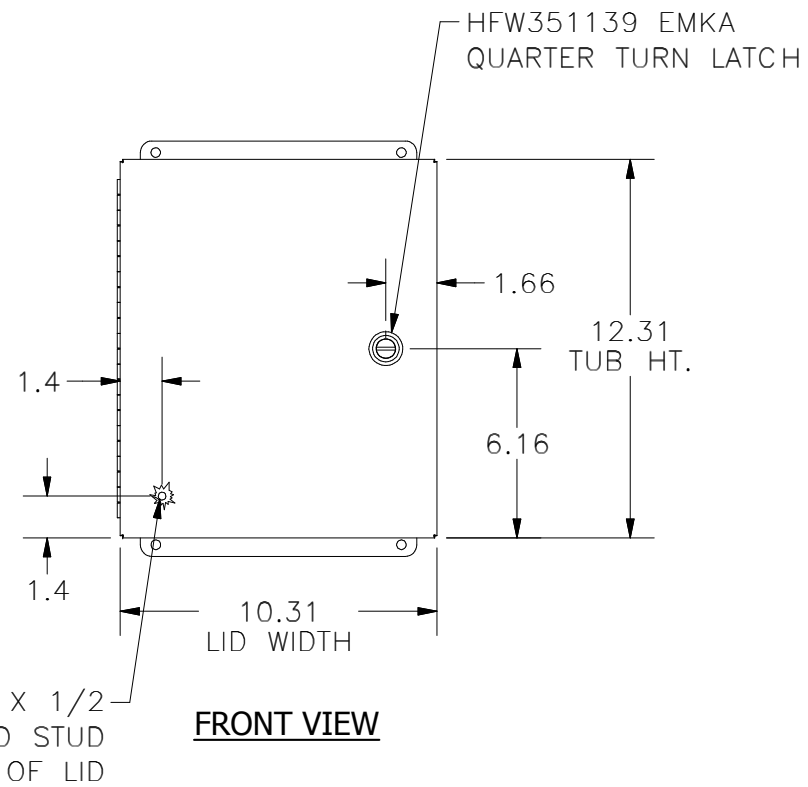

**FRONT VIEW**

10-32 X 1/2  
GROUND STUD  
ON INSIDE OF LID

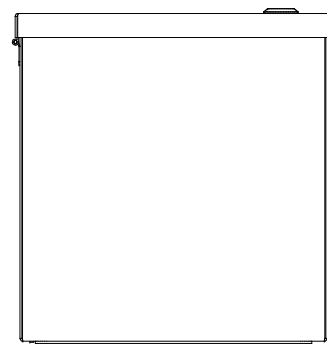

**BOTTOM VIEW**

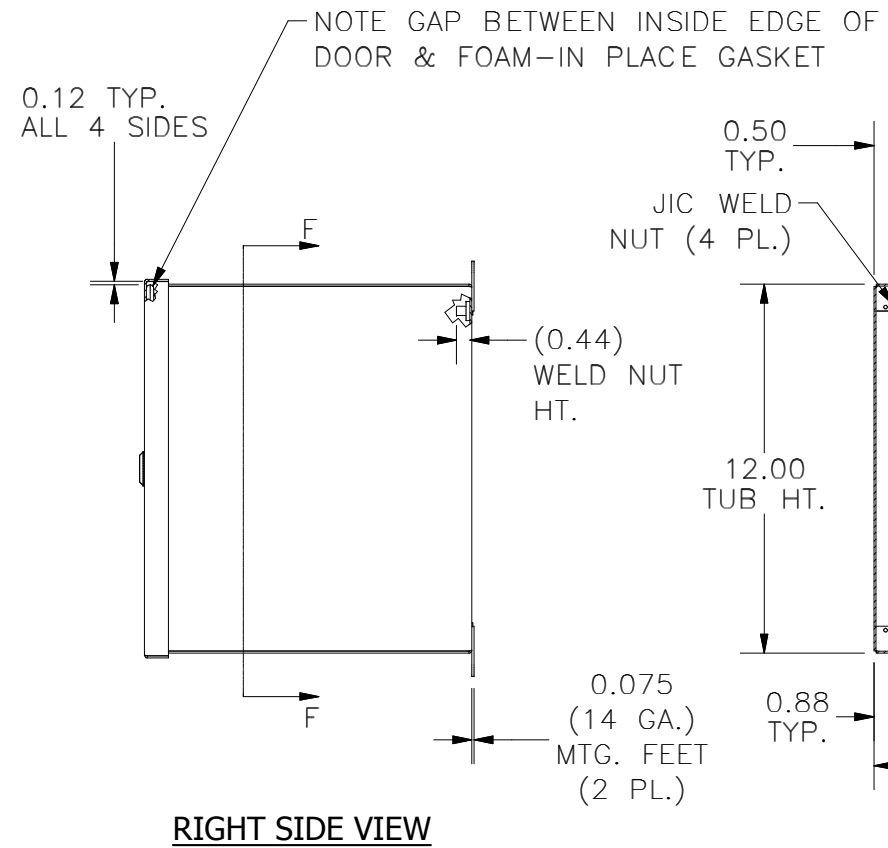

**RIGHT SIDE VIEW**

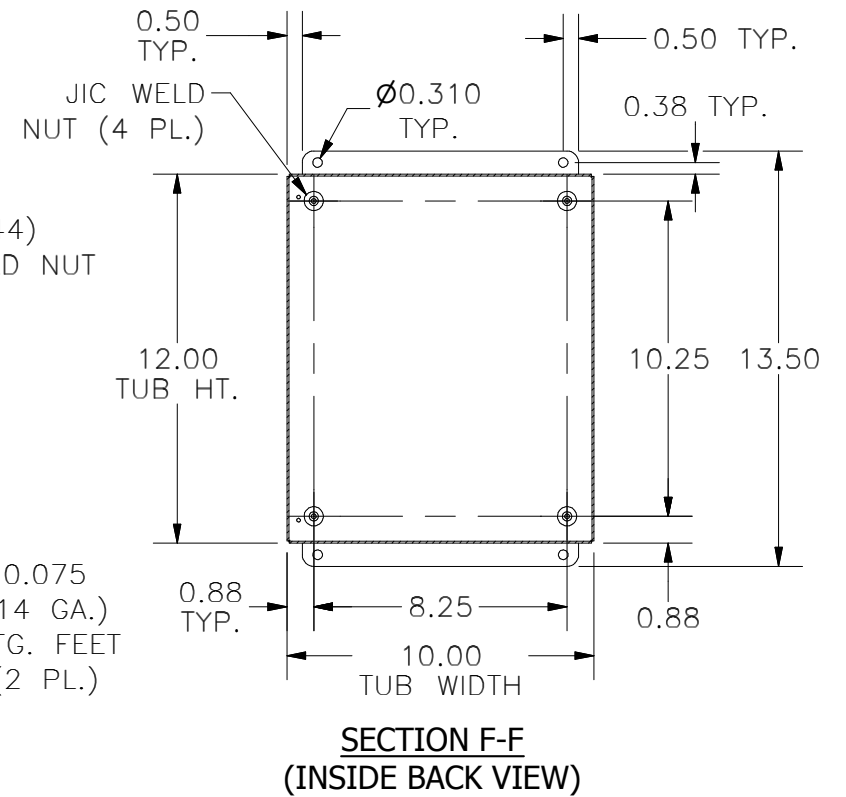

**SECTION F-F  
(INSIDE BACK VIEW)**

PART#: BN4121010CHQT  
(DATA SUBJECT TO CHANGE WITHOUT NOTICE)

THIS DRAWING IS PROPERTY OF HUBBELL INC. WIEGMANN  
ALL INFORMATION IS PROPRIETARY AND NOT TO BE DUPLICATED