

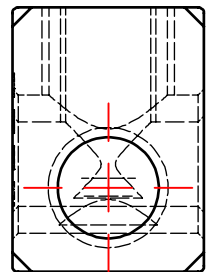

S.NO	CATALOG NUMBER	L	B
1	NSC350-4SL	6.47 [164]	4
2	NSC350-4SLI	6.47 [164]	4
3	NSC350-5SL	7.38 [187]	5
4	NSC350-6SL	8.29 [211]	6
5	NSC350-6SLI	8.29 [211]	6
6	NSC350-8SLI	10.11 [257]	8
7	NSC350-8SL	10.11 [257]	8

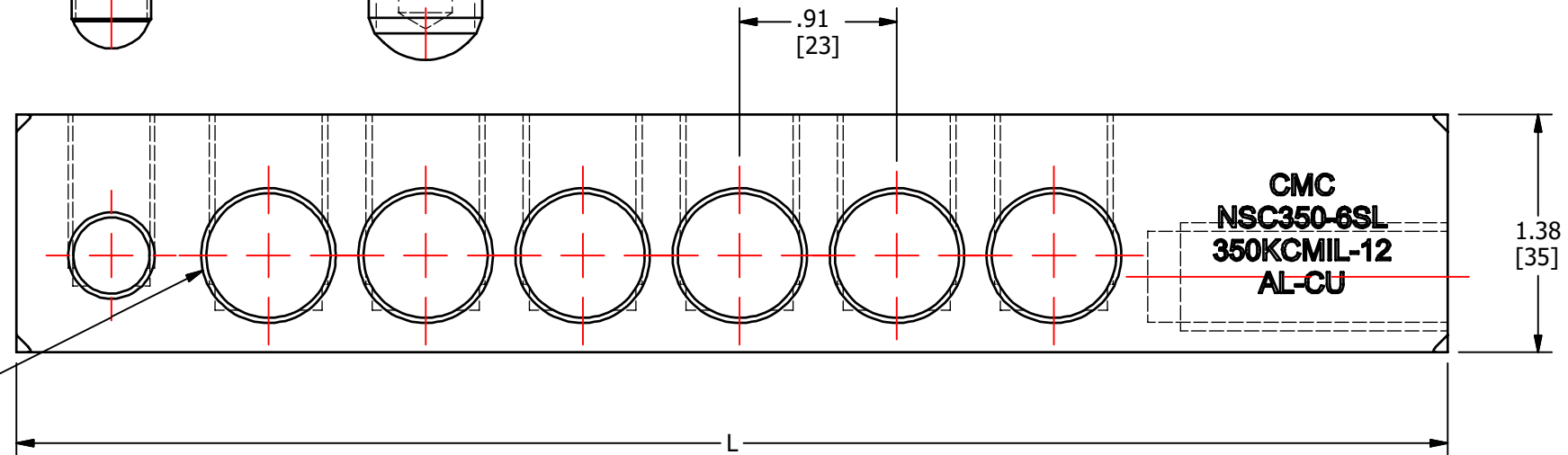
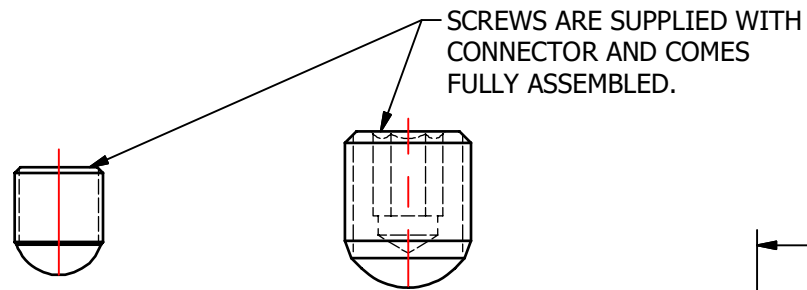
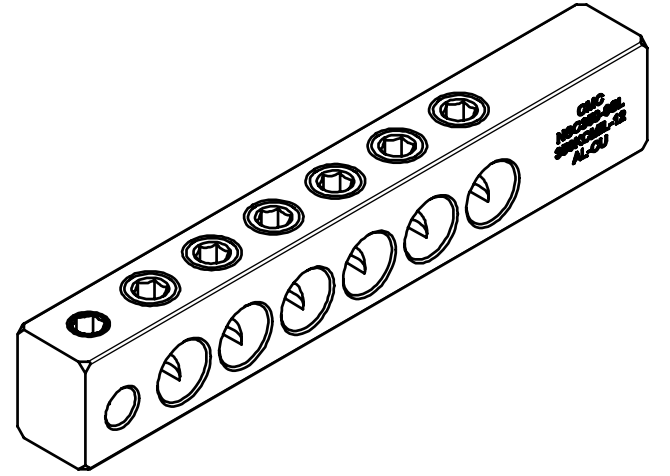
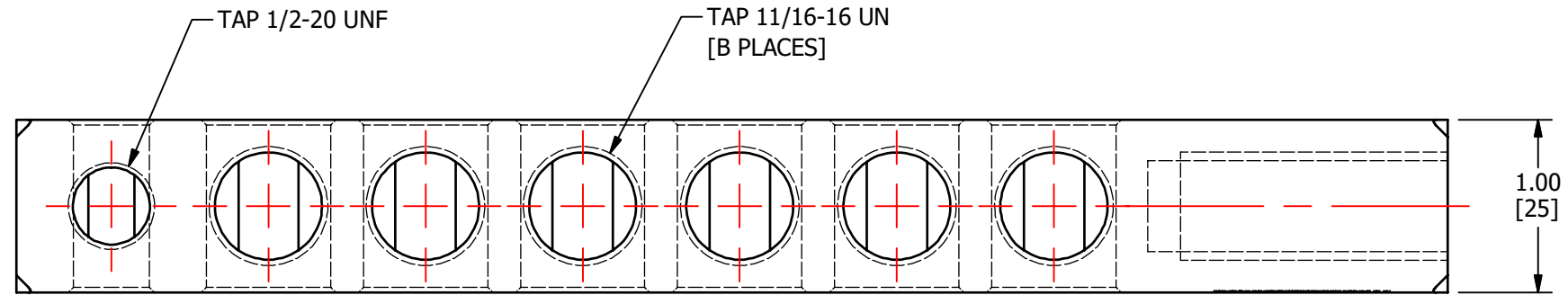

				DRAWN BY: TS 12/11/18		NAME OF PART: STUD MOUNT CONNECTOR		CAT. NO.: SEE TABLE	
				CHECKED BY:		DWG NO: C58700913C-S (CHARTED)		B	
A NEW DRAWING CREATED				12/11/18		TS		DRAWING NOT TO SCALE	
REV.	DESCRIPTION	ECN	DATE	INIT.	FOR PRODUCT INFO: http://www.cmclugs.com		SHEET NO: 1 OF 1		 

THIS INFORMATION IS PROPRIETARY TO CONNECTOR MFG. CO. AND IS NOT TO BE DISCLOSED OUTSIDE OF CONNECTOR MFG. CO. WITHOUT A CONFIDENTIALITY AGREEMENT

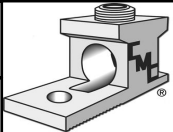

CONNECTOR MANUFACTURING CO.

HAMILTON, OHIO